

TLV6256x 采用 5 引脚 SOT-23 封装的 1.5A 高效降压转换器

1 特性

- 输入电压范围：2.7V 至 5.5V
- 1.5MHz 典型开关频率
- 输出电流高达 1.5A（最大值）
- 自适应接通时间电流控制
- 针对轻载效率的省电模式
- 50 μ A 运行静态电流
- 效率高达 95%
- 过流保护
- 95% 最大占空比
- 出色的交流和瞬态负载响应
- 电源正常输出，TLV62566
- 250 μ s 的内部软启动（典型值）
- 可调节输出电压
- 热关断保护
- 采用 5 引脚小外形尺寸晶体管 (SOT)-23 封装

2 应用

- 便携式设备
- DSL 调制解调器
- 硬盘驱动器
- 机顶盒
- 平板电脑

3 说明

TLV62565/6 器件是针对小型解决方案尺寸和高效率进行优化的同步降压转换器。此器件集成了能够传送高达 1.5A 输出电流的开关。

此器件借助谷值电流模式控制系统配置，根据自适应接通时间进行工作。中等或重负载时的典型工作频率为 1.5MHz。此器件被优化以便即使在使用小型外部组件时也能实现极低的输出电压纹波，并且特有一个出色的负载瞬态响应。

轻负载期间，TLV62565/6 在最低静态电流（典型值 50 μ A）时自动进入省电模式以在整个负载电流范围内保持高效率。关断时，流耗减少至小于 1 μ A。

TLV62565/6 通过一个外部电阻分压器来提供一个可调输出电压。输出电压启动斜坡由一个内部软启动控制，通常为 250 μ s。通过配置使能 (TLV62565) 和电源正常 (TLV62566) 引脚也有可能实现电源排序。其它诸如过流保护和过热保护的特性是内置的。

TLV62565/6 器件采用 5 引脚 SOT-23 封装。

器件信息(1)

器件型号	封装	封装尺寸（标称值）
TLV62565 和 TLV62566	SOT-23 (5)	2.90mm x 1.60mm

(1) 如需了解所有可用封装，请见数据表末尾的可订购产品附录。

4 简化电路原理图

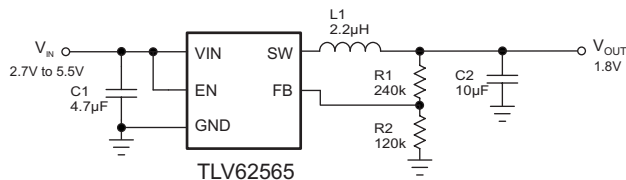

效率与负载电流间的关系

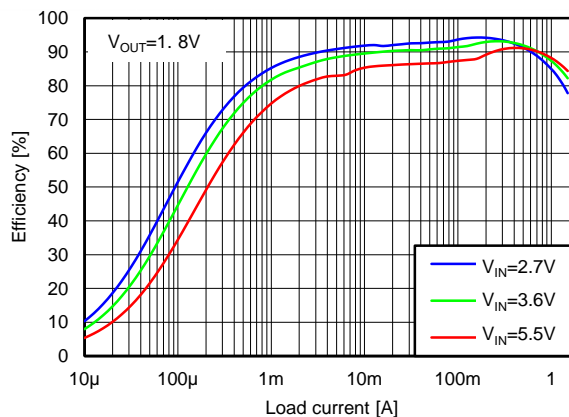

目录

1	特性	1	10.3	Feature Description.....	11
2	应用	1	10.4	Device Functional Modes.....	12
3	说明	1	11	Application and Implementation.....	13
4	简化电路原理图	1	11.1	Application Information.....	13
5	修订历史记录	2	11.2	Typical Application	13
6	Device Comparison Table	3	12	Power Supply Recommendations	17
7	Pin Configuration and Functions	3	13	Layout.....	18
8	Specifications.....	4	13.1	Layout Guidelines	18
8.1	Absolute Maximum Ratings	4	13.2	Layout Example	18
8.2	ESD Ratings.....	4	13.3	Thermal Considerations	18
8.3	Recommended Operating Conditions	4	14	器件和文档支持	19
8.4	Thermal Information	4	14.1	器件支持	19
8.5	Electrical Characteristics.....	5	14.2	文档支持	19
8.6	Typical Characteristics.....	6	14.3	相关链接	19
9	Parameter Measurement Information	8	14.4	商标	19
10	Detailed Description	9	14.5	静电放电警告	19
10.1	Overview	9	14.6	术语表	19
10.2	Functional Block Diagrams	10	15	机械、封装和可订购信息	19

5 修订历史记录

NOTE: Page numbers for previous revisions may differ from page numbers in the current version.

Changes from Revision A (November 2014) to Revision B	Page
• Added Storage temperature to Absolute Maximum Ratings	4
• Changed Handling Ratings to ESD Ratings.....	4
• Deleted Storage temperature from ESD Ratings	4
• 已更改 Thermal Information to Thermal Considerations and moved to Layout section	18

Changes from Original (October 2013) to Revision A	Page
• 已更改 添加了处理额定值表，特性描述部分，器件功能模式，应用和实施部分，电源相关建议部分，布局部分，器件和文档支持部分以及机械、封装和可订购信息部分。	1
• Added "T _A = -40°C to 85°C" to the V _{FB} , Feedback regulation voltage Test Conditions	5
• Added V _{FB} , Feedback regulation voltage Test Conditions and values for "PWM operation, T _A = 85°C"	5

6 Device Comparison Table

PART NUMBER	FUNCTION
TLV62566	EN
TLV62566	PG

7 Pin Configuration and Functions

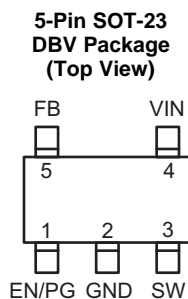

Pin Functions

NAME	PIN		I/O/PWR	DESCRIPTION
	NUMBER			
	TLV62565	TLV62566		
EN	1	—	I	Device enable logic input. Logic HIGH enables the device, logic low disables the device and turns it into shutdown.
FB	5	5	I	Feedback pin for the internal control loop. Connect this pin to the external feedback divider.
GND	2	2	PWR	Ground pin.
PG	—	1	O	Power Good open drain output. This pin is high impedance if the output voltage is within regulation. It is pulled low if the output is below its nominal value. It is also in logic low when V_{IN} below UVLO or thermal shutdown triggers.
SW	3	3	PWR	Switch pin connected to the internal MOSFET switches and inductor terminal. Connect the inductor of the output filter to this pin.
VIN	4	4	PWR	Power supply voltage input.

8 Specifications

8.1 Absolute Maximum Ratings

Over operating free-air temperature range (unless otherwise noted)⁽¹⁾

		MIN	MAX	UNIT
Voltage ⁽²⁾	V _{IN} , EN,PG	-0.3	7	V
	SW	-0.3	V _{IN} +0.3	V
	FB	-0.3	3.6	V
Sink current, I _{PG}	PG		660	μA
Continuous total power dissipation		See Thermal Information		
Operating junction temperature, T _J		-40	150	°C
Storage temperature, T _{stg}		-65	150	°C

- (1) Stresses beyond those listed under *absolute maximum ratings* may cause permanent damage to the device. These are stress ratings only and functional operation of the device at these or any other conditions beyond those indicated under *recommended operating conditions* is not implied. Exposure to absolute–maximum–rated conditions for extended periods may affect device reliability.
- (2) All voltage values are with respect to network ground terminal.

8.2 ESD Ratings

			VALUE	UNIT
V _(ESD)	Electrostatic discharge	Human-body model (HBM), per ANSI/ESDA/JEDEC JS-001 ⁽¹⁾	±2000	V
		Charged-device model (CDM), per JEDEC specification JESD22-C101 ⁽²⁾	±500	V

- (1) JEDEC document JEP155 states that 500-V HBM allows safe manufacturing with a standard ESD control process.
- (2) JEDEC document JEP157 states that 250-V CDM allows safe manufacturing with a standard ESD control process.

8.3 Recommended Operating Conditions⁽¹⁾

		MIN	TYP	MAX	UNIT
V _{IN}	Input voltage, V _{IN}	2.7		5.5	V
T _A	Operating ambient temperature	-40		85	°C

- (1) Refer to the [Application and Implementation](#) section for further information.

8.4 Thermal Information

THERMAL METRIC ⁽¹⁾		TLV62565, TLV62566	UNIT
		DBV (5 Pins)	
R _{θJA}	Junction-to-ambient thermal resistance	208.3	°C/W
R _{θJC(top)}	Junction-to-case (top) thermal resistance	73.7	
R _{θJB}	Junction-to-board thermal resistance	36.1	
ψ _{JT}	Junction-to-top characterization parameter	2.3	
ψ _{JB}	Junction-to-board characterization parameter	35.3	
R _{θJC(bot)}	Junction-to-case (bottom) thermal resistance	N/A	

- (1) For more information about traditional and new thermal metrics, see the *IC Package Thermal Metrics* application report, [SPRA953](#).

8.5 Electrical Characteristics

Over recommended free-air temperature range, $V_{IN} = 3.6\text{ V}$, $T_A = -40^\circ\text{C}$ to 85°C , typical values are at $T_A = 25^\circ\text{C}$ (unless otherwise noted)

PARAMETER		TEST CONDITIONS	MIN	TYP	MAX	UNIT
SUPPLY						
V_{IN}	Input voltage		2.7		5.5	V
I_Q	Quiescent current into VIN pin	$I_{OUT} = 0\text{ mA}$, Not switching		50		μA
V_{UVLO}	Under voltage lock out	V_{IN} falling		2.2	2.3	V
	Under voltage lock out hysteresis			200		mV
T_{JSD}	Thermal shutdown	Junction temperature rising		150		$^\circ\text{C}$
	Thermal shutdown hysteresis	Junction temperature falling below T_{JSD}		20		
LOGIC INTERFACE, TLV62565						
V_{IH}	High-level input voltage	$2.7\text{ V} \leq V_{IN} \leq 5.5\text{ V}$	1.2			V
V_{IL}	Low-level input voltage	$2.7\text{ V} \leq V_{IN} \leq 5.5\text{ V}$			0.4	V
I_{SD}	Shutdown current into VIN pin	EN = LOW		0.1	1	μA
$I_{EN,LKG}$	EN leakage current			0.01	0.16	μA
POWER GOOD, TLV62566						
V_{PG}	Power Good low threshold	V_{FB} falling referenced to V_{FB} nominal		90%		
	Power Good high threshold	V_{FB} rising referenced to V_{FB} nominal		95%		
V_L	Low level voltage	$I_{sink} = 500\text{ }\mu\text{A}$			0.4	V
$I_{PG,LKG}$	PG Leakage current	$V_{PG} = 5.0\text{ V}$		0.01	0.17	μA
OUTPUT						
V_{OUT}	Output voltage		0.6		$D_{MAX} \cdot V_{IN}$	V
V_{FB}	Feedback regulation voltage	PWM operation, $T_A = -40^\circ\text{C}$ to 85°C	0.588	0.6	0.612	V
		PWM operation, $T_A = 85^\circ\text{C}$	0.594	0.6	0.606	V
		PFM comparator threshold		0.9%		
I_{FB}	Feedback input bias current	$V_{FB} = 0.6\text{ V}$		10	100	nA
$R_{DS(on)}$	High-side FET on resistance	$I_{SW} = 500\text{ mA}$, $V_{IN} = 3.6\text{ V}$		173		m Ω
	Low-side FET on resistance	$I_{SW} = 500\text{ mA}$, $V_{IN} = 3.6\text{ V}$		105		
$I_{LIM,LS}$	Low-side FET valley current limit		1.5			A
$I_{LIM,HS}$	High-side FET peak current limit		1.8			A
f_{SW}	Switching frequency			1.5		MHz
D_{MAX}	Maximum duty cycle			95%		
$t_{OFF,MIN}$	Minimum off time			40		ns

8.6 Typical Characteristics

表 1. Table of Graphs

		FIGURE
Efficiency	vs Load current ($V_{OUT} = 1.8\text{ V}$, $V_{IN} = 2.7\text{ V}, 3.6\text{ V}, 5.5\text{ V}$)	图 1
	vs Load current ($V_{OUT} = 1.2\text{ V}$, $V_{IN} = 2.7\text{ V}, 3.6\text{ V}, 5.5\text{ V}$)	图 2
	vs Load current ($V_{OUT} = 3.3\text{ V}$, $V_{IN} = 4.2\text{ V}, 5.5\text{ V}$)	图 3
Output voltage	vs Input voltage (Line regulation, $V_{OUT} = 1.8\text{ V}$, Load = 0.5 A, 1 A, 1.5 A)	图 4
	vs Load current (Load regulation, $V_{OUT} = 1.8\text{ V}$, $V_{IN} = 2.7\text{ V}, 3.6\text{ V}, 5.5\text{ V}$)	图 5
Quiescent current	vs Input voltage	图 6
$R_{DS(on)}$	vs Input voltage, High-Side FET	图 7
	vs Input voltage, Low-Side FET	图 8
Switching frequency	vs Load current, $V_{OUT} = 1.8\text{ V}$	图 9



图 1. Efficiency vs Load Current



图 2. Efficiency vs Load Current

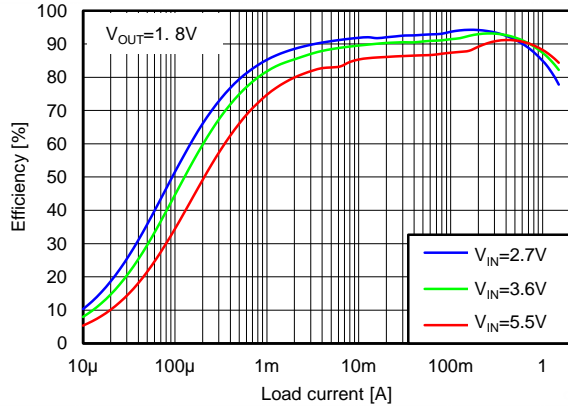

图 3. Efficiency vs Load Current

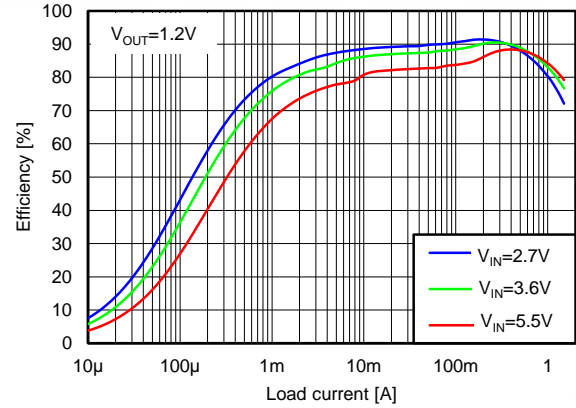

图 4. Output Voltage vs Input Voltage

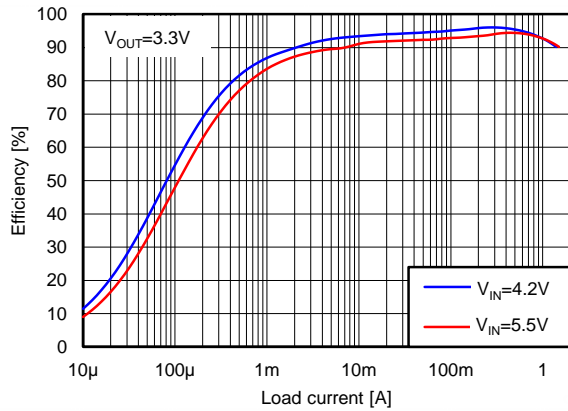

图 5. Output Voltage vs Load Current

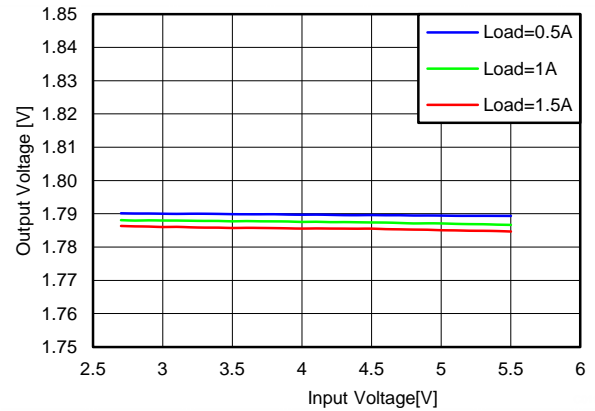

图 6. Quiescent Current vs Input Voltage

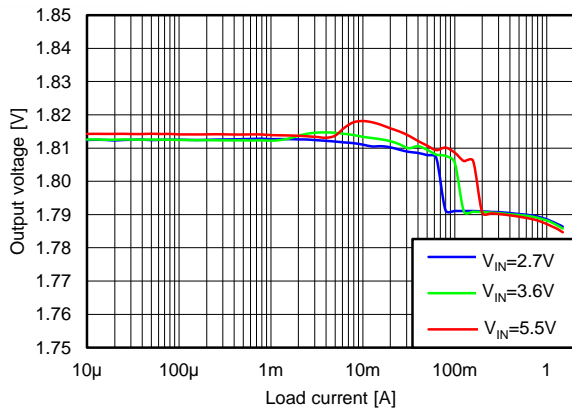

图 7. High-Side FET $R_{DS(on)}$ vs Input Voltage

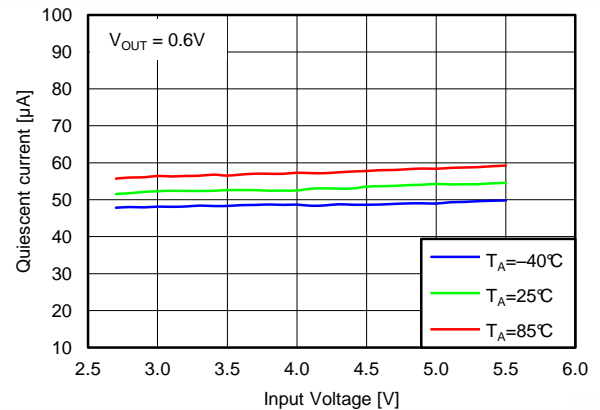

图 8. Low-Side FET $R_{DS(on)}$ vs Input Voltage

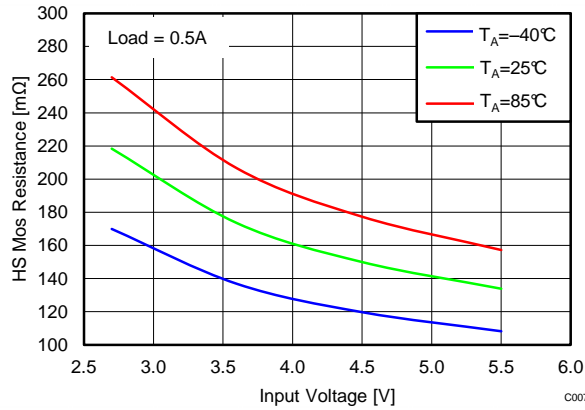

图 9. Switching Frequency vs Load Current

9 Parameter Measurement Information

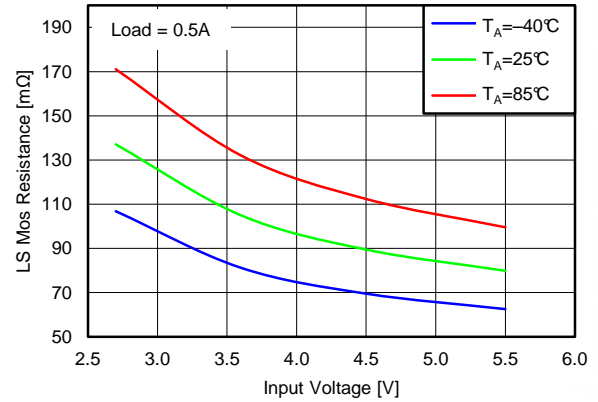

表 2. List of Components

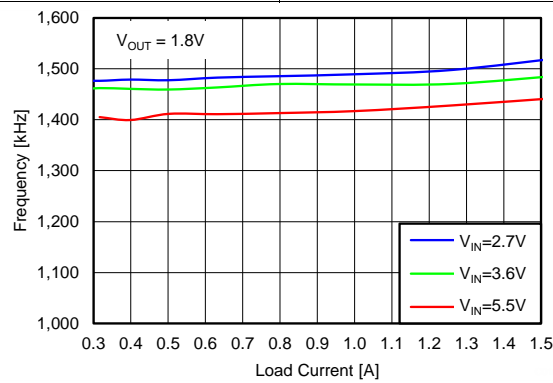
REFERENCE	DESCRIPTION	MANUFACTURER
C1	4.7 μ F, Ceramic Capacitor, 6.3 V, X5R, size 0603, GRM188R60J475ME84	Murata
C2	10 μ F, Ceramic Capacitor, 6.3 V, X5R, size 0603, GRM188R60J106ME84	Murata
L1	2.2 μ H, Power Inductor, 2.5 A, size 4mmx4mm, LQH44PN2R2MP0	Murata
R1,R2	Chip resistor,1%,size 0603	Std.

10 Detailed Description

10.1 Overview

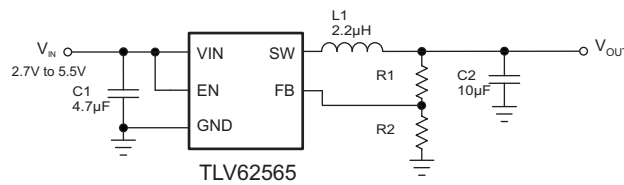
The TLV62565/6 device family includes two high-efficiency synchronous step-down converters. Each device operates with an adaptive on-time control scheme, which is able to dynamically adjust the on-time duration based on the input voltage and output voltage so that it can achieve relative constant frequency operation. The device operates at typically 1.5-MHz frequency pulse width modulation (PWM) at moderate to heavy load currents. Based on the V_{IN}/V_{OUT} ratio, a simple circuit sets the required on time for the high-side MOSFET. It makes the switching frequency relatively constant regardless of the variation of input voltage, output voltage, and load current. At the beginning of each switching cycle, the high-side switch is turned on and the inductor current ramps up to a peak current that is defined by on time and inductance. In the second phase, once the on time expires, the high-side switch is turned off while the low-side switch is being turned on. The current through the inductor then decays until triggering the valley current limit determined by the output of the error amplifier. Once this occurs, the on timer is set to turn the high-side switch back on again and the cycle is repeated.

The TLV62565/6 device family offers excellent load transient response with a unique fast response constant on-time valley current mode. The switching frequency changes during load transition so that the output voltage comes back in regulation faster than a traditional fixed PWM control scheme. 图 10 shows the operation principles of the load transient response of the TLV62565/6. Internal loop compensation is integrated which simplifies the design process while minimizing the number of external components. At light load currents the device automatically operates in Power Save Mode with pulse frequency modulation (PFM).



图 10. Operation in Load Transient

10.2 Functional Block Diagrams



图 11. TLV62565 Functional Block Diagram

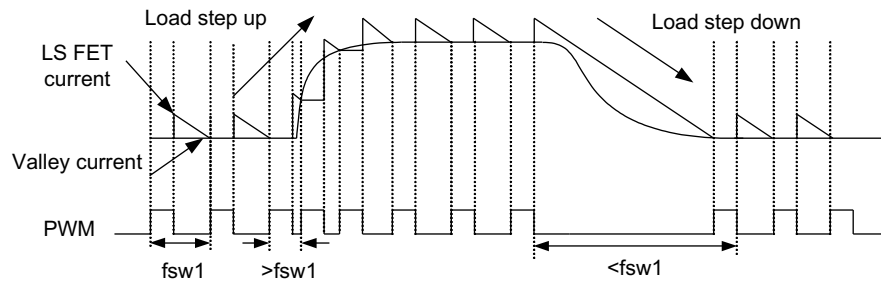

图 12. TLV62566 Functional Block Diagram

10.3 Feature Description

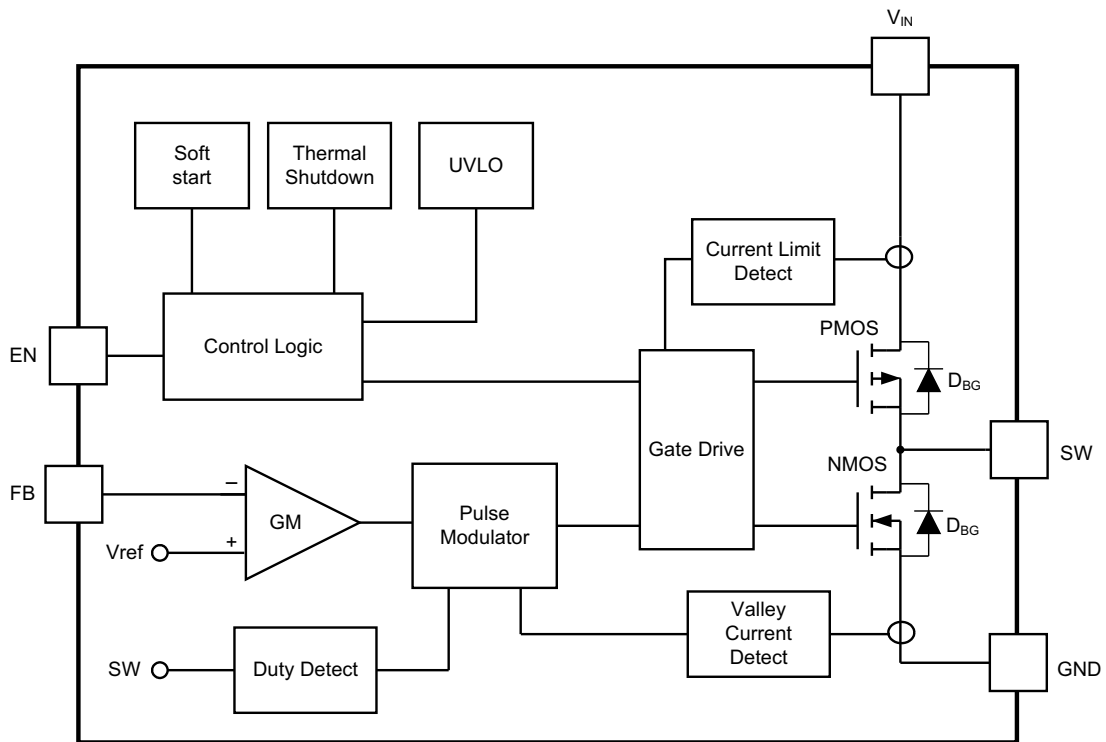
10.3.1 Power Save Mode

The device integrates a Power Save Mode with PFM to improve efficiency at light load. In Power Save Mode, the device only switches when the output voltage trips below a set threshold voltage. It ramps up the output voltage with several pulses and stops switching when the output voltage is higher than the set threshold voltage. PFM is exited and PWM mode entered in case the output current can no longer be supported in Power Save Mode. The threshold of the PFM comparator is typically 0.9% higher than the normal reference voltage. 图 13 shows the details of PFM/PWM mode transition.

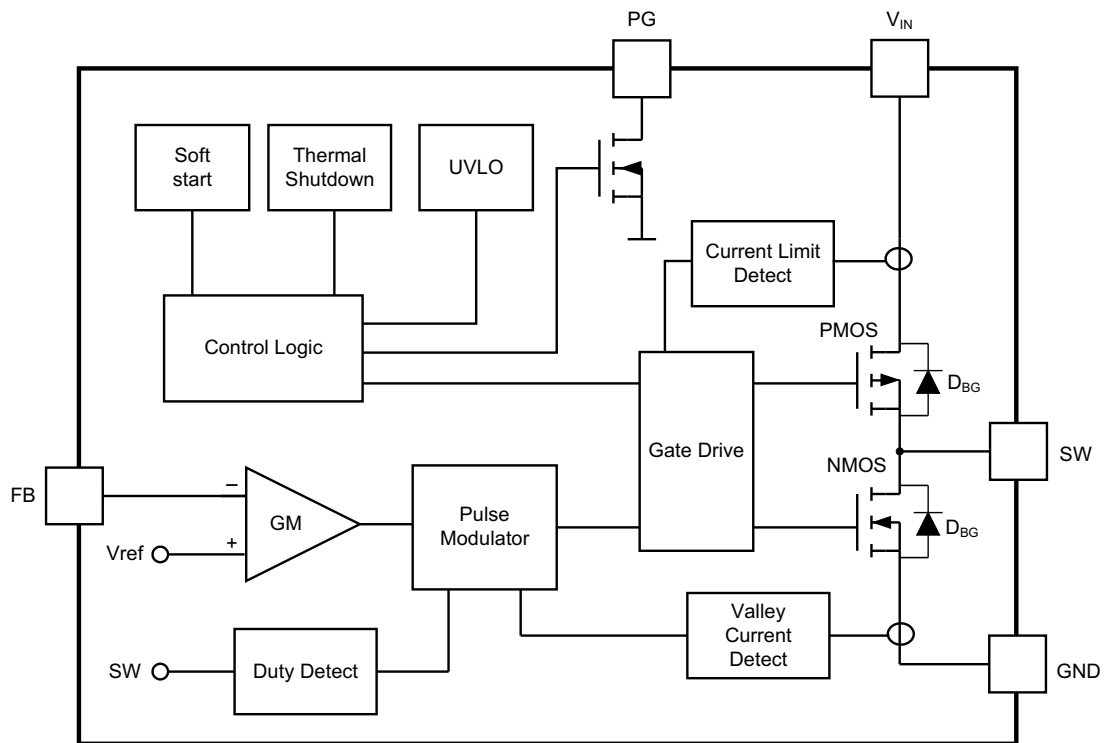

图 13. Output Voltage in PFM/PWM Mode

10.3.2 Enabling/Disabling the Device

The device is enabled by setting the EN input to a logic HIGH. Accordingly, a logic LOW disables the device. If the device is enabled, the internal power stage starts switching and regulates the output voltage to the set point voltage. The EN input must be terminated and should not be left floating.

10.3.3 Soft Start

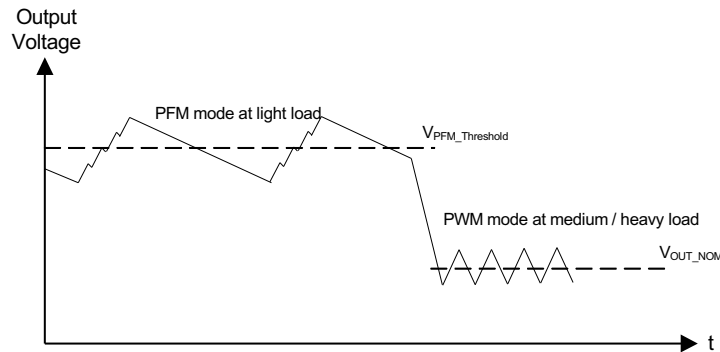
After enabling the device, internal soft-start circuitry monotonically ramps up the output voltage which reaches nominal output voltage during a soft-start time of 250 μ s (typical). This avoids excessive inrush current and creates a smooth output voltage rise slope. It also prevents excessive voltage drops of primary cells and rechargeable batteries with high internal impedance.

If the output voltage is not reached within the soft-start time, such as in the case of a heavy load, the converter enters regular operation. The TLV62565/6 are able to start into a pre-biased output capacitor. The converter starts with the applied bias voltage and ramps the output voltage to its nominal value.

10.3.4 Switch Current Limit

The switch current limit prevents the device from high inductor current and drawing excessive current from a battery or input voltage rail. Excessive current might occur with a heavy load or shorted output circuit condition.

The TLV62565/6 adopt valley current control by sensing the current of the low-side MOSFET. Once the low-side valley switch current limit is tripped, the low-side MOSFET is turned off and limits the inductor's valley current. The high-side current is also limited which is determined by the on time of the high-side MOSFET and inductor value calculated by 公式 1. For example, with 3.6 V_{IN} to 1.8 V_{OUT} and 2.2- μ H specification, the peak current limit is approximately 1.97 A with a typical valley current limit of 1.7 A.

Additionally, there is a secondary high-side current limit (typical 2 A) to prevent the current from going too high, which is shown in 图 14. Due to the internal propagation delay, the real current limit value might be higher than the static current limit in the electrical characteristics table.

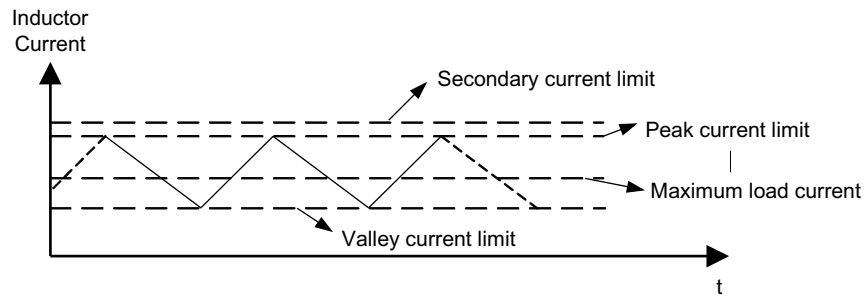
Feature Description (接下页)

图 14. Switch Current Limit

$$I_{PEAK,LIMIT} = I_{VALLEY,LIMIT} + \Delta I_L$$

$$\Delta I_L = \frac{V_{OUT}}{L} \times \frac{(1-D)}{f_{SW}}$$

where:

- $I_{PEAK,LIMIT}$ is the high-side peak current limit
- $I_{VALLEY,LIMIT}$ is the low-side valley current limit

(1)

10.3.5 Power Good

The TLV62566 integrates a Power Good output going low when the output voltage is below its nominal value. The Power Good output stays high impedance once the output is above 95% of the regulated voltage and is low once the output voltage falls below typically 90% of the regulated voltage. The PG pin is an open drain output and is specified to sink typically up to 0.5 mA. The Power Good output requires a pull-up resistor connected to any voltage lower than 5.5 V. When the device is off due to UVLO or thermal shutdown, the PG pin is pulled to logic low.

10.4 Device Functional Modes
10.4.1 Under Voltage Lockout

To avoid mis-operation of the device at low input voltages, under voltage lockout is implemented that shuts down the device at voltages lower than V_{UVLO} with V_{HYS_UVLO} hysteresis.

10.4.2 Thermal Shutdown

The device enters thermal shutdown once the junction temperature exceeds typically T_{JSD} . Once the device temperature falls below the threshold with hysteresis, the device returns to normal operation automatically. Power Good is pulled low when thermal protection is triggered.

11 Application and Implementation

注

Information in the following applications sections is not part of the TI component specification, and TI does not warrant its accuracy or completeness. TI's customers are responsible for determining suitability of components for their purposes. Customers should validate and test their design implementation to confirm system functionality.

11.1 Application Information

The TLV6256x devices are synchronous step-down converters optimized for small solution size and high efficiency. The devices integrate switches capable of delivering an output current up to 1.5 A.

11.2 Typical Application

TLV62565 2.7-V to 5.5-V input, 1.2-V output converter.



图 15. TLV62565 1.2-V Output Application

11.2.1 Design Requirements

11.2.1.1 Output Filter Design

The inductor and output capacitor together provide a low-pass frequency filter. To simplify this process, 表 3 outlines possible inductor and capacitor value combinations.

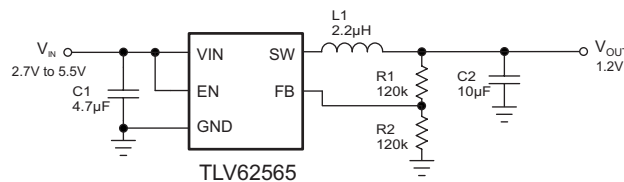
表 3. Matrix of Output Capacitor and Inductor Combinations

L [μ H] ⁽¹⁾	C _{OUT} [μ F] ^{(2) (3)}				
	4.7	10	22	47	100
1					
2.2		+ ⁽⁴⁾	+ ⁽⁴⁾	+ ⁽⁴⁾	
4.7					

- (1) Inductor tolerance and current de-rating is anticipated. The effective inductance can vary by +20% and -30%.
- (2) Capacitance tolerance and bias voltage de-rating is anticipated. The effective capacitance can vary by +20% and -50%.
- (3) For low output voltage applications (≤ 1.2 V), more output capacitance is recommended (usually ≥ 22 μ F) for smaller ripple.
- (4) Typical application configuration. '+' indicates recommended filter combinations.

11.2.1.2 Inductor Selection

The main parameters for inductor selection is inductor value and then saturation current of the inductor. To calculate the maximum inductor current under static load conditions, 公式 2 is given:

$$I_{L,MAX} = I_{OUT,MAX} + \frac{\Delta I_L}{2}$$

$$\Delta I_L = V_{OUT} \times \frac{1 - \frac{V_{OUT}}{V_{IN}}}{L \times f_{SW}}$$

where:

- $I_{OUT,MAX}$ is the maximum output current
- ΔI_L is the inductor current ripple
- f_{SW} is the switching frequency
- L is the inductor value

(2)

It is recommended to choose a saturation current for the inductor that is approximately 20% to 30% higher than $I_{L,MAX}$. In addition, DC resistance and size should also be taken into account when selecting an appropriate inductor. The recommended inductors are listed in 表 4.

表 4. List of Recommended Inductors

INDUCTANCE [μH]	CURRENT RATING [mA]	DIMENSIONS L x W x H [mm ³]	DC RESISTANCE [mΩ typ]	TYPE	MANUFACTURER
2.2	2500	4 x 3.7 x 1.65	49	LQH44PN2R2MP0	Murata
2.2	3000	4 x 4 x 1.8	50	NRS4018T2R2MDGJ	Taiyo Yuden

11.2.1.3 Input and Output Capacitor Selection

The input capacitor is the low impedance energy source for the converter that helps provide stable operation. The closer the input capacitor is placed to the V_{IN} and GND pins, the lower the switch ring. A low ESR multilayer ceramic capacitor is recommended for best filtering. For most applications, 4.7-μF input capacitance is sufficient; a larger value reduces input voltage ripple.

The architecture of the TLV62565/6 allow use of tiny ceramic-type output capacitors with low equivalent series resistance (ESR). These capacitors provide low output voltage ripple and are thus recommended. To keep its resistance up to high frequencies and to achieve narrow capacitance variation with temperature, it is recommended to use X7R or X5R dielectric. The TLV62565/6 are designed to operate with an output capacitance of 10 μF to 47 μF, as outlined in 表 3.

11.2.2 Detailed Design Procedure

11.2.2.1 Setting the Output Voltage

An external resistor divider is used to set output voltage. By selecting R1 and R2, the output voltage is programmed to the desired value. When the output voltage is regulated, the typical voltage at the FB pin is V_{FB} . [公式 3](#), [公式 4](#), and [公式 5](#) can be used to calculate R1 and R2.

When sizing R2, in order to achieve low quiescent current and acceptable noise sensitivity, use a minimum of 5 μ A for the feedback current I_{FB} . Larger currents through R2 improve noise sensitivity and output voltage accuracy but increase current consumption.

$$V_{OUT} = V_{FB} \times \left(1 + \frac{R1}{R2}\right) = 0.6V \times \left(1 + \frac{R1}{R2}\right) \quad (3)$$

$$R2 = \frac{V_{FB}}{I_{FB}} = \frac{0.6V}{5\mu A} = 120k\Omega \quad (4)$$

$$R1 = R2 \times \left(\frac{V_{OUT}}{V_{FB}} - 1\right) = R2 \times \left(\frac{V_{OUT}}{0.6V} - 1\right) \quad (5)$$

11.2.2.2 Loop Stability

The first step of circuit and stability evaluation is to look from a steady-state perspective at the following signals:

- Switching node, SW
- Inductor current, I_L
- Output ripple voltage, $V_{OUT(AC)}$

These are the basic signals that need to be measured when evaluating a switching converter. When the switching waveform shows large duty cycle jitter or the output voltage or inductor current shows oscillations, the regulation loop may be unstable. This is often a result of board layout and/or L-C combination. Applications with the recommended L-C combinations in [表 3](#) are designed for good loop stability as well as fast load transient response.

As a next step in the evaluation of the regulation loop, the load transient response is illustrated. The TLV62565/6 use a constant on time with valley current mode control, so the on time of the high-side MOSFET is relatively consistent from cycle to cycle when a load transient occurs. Whereas the off time adjusts dynamically in accordance with the instantaneous load change and brings V_{OUT} back to the regulated value.

During recovery time, V_{OUT} can be monitored for settling time, overshoot, or ringing which helps judge the stability of the converter. Without any ringing, the loop usually has more than 45° of phase margin.

11.2.3 Application Performance Curves



图 16. Typical Application (PWM Mode)

图 17. Typical Application (PFM Mode)

图 18. Typical Application (PFM Mode)

图 19. Load Transient

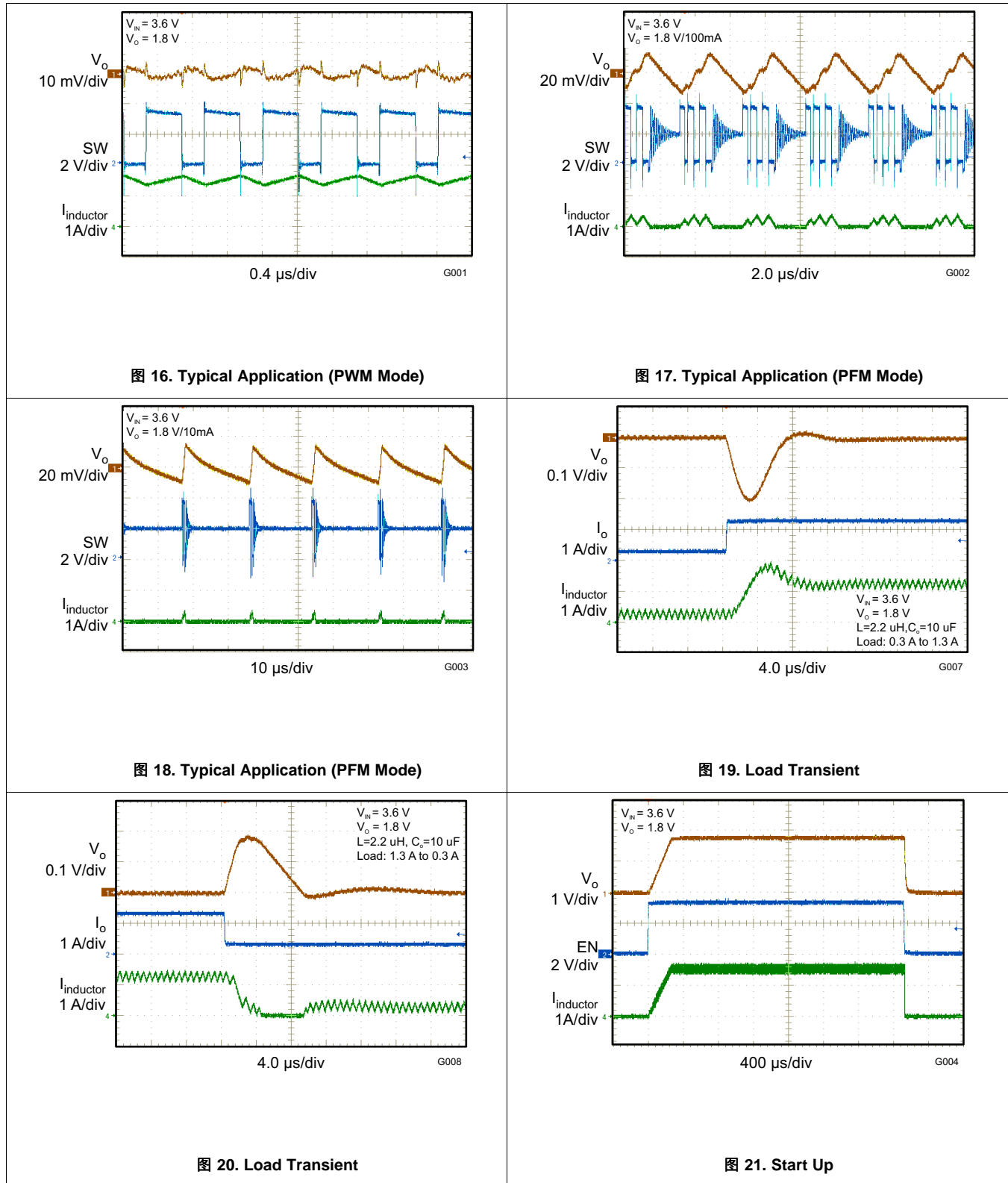
图 20. Load Transient

图 21. Start Up

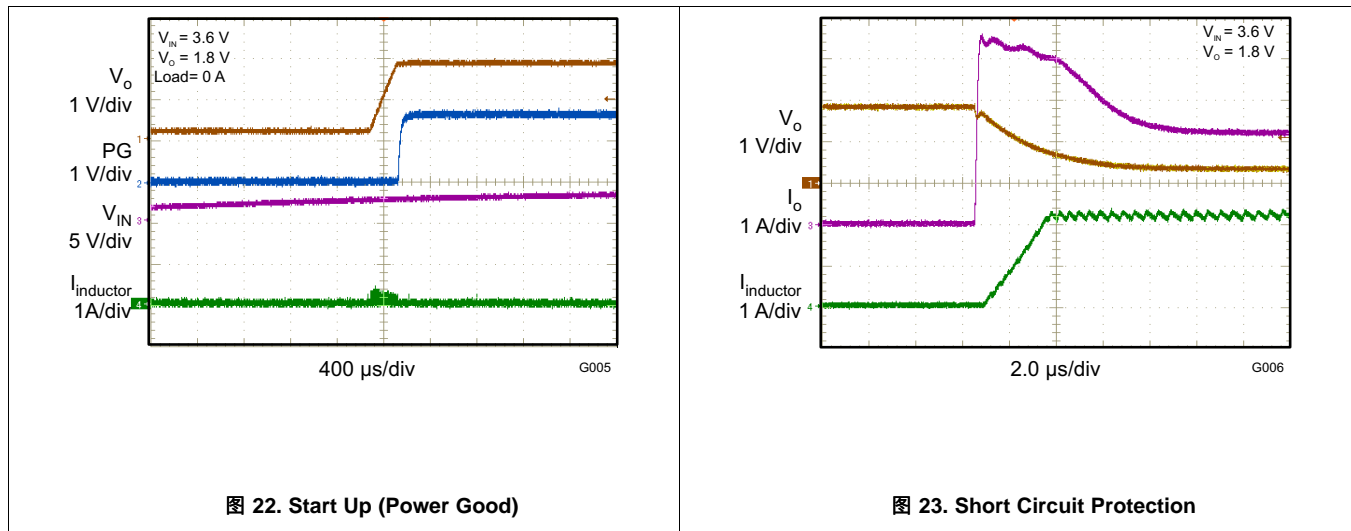

12 Power Supply Recommendations

The power supply to the TLV62565 and TLV62566 needs to have a current rating according to the supply voltage, output voltage and output current of the TLV62565 and TLV62566.

13 Layout

13.1 Layout Guidelines

The PCB layout is an important step to maintain the high performance of the TLV62565 devices.

- The input/output capacitors and the inductor should be placed as close as possible to the IC.
- This keeps the traces short. Routing these traces direct and wide results in low trace resistance and low parasitic inductance.
- A common power GND should be used.
- The low side of the input and output capacitors must be connected properly to the power GND to avoid a GND potential shift.
- The sense traces connected to FB is a signal trace .
- Special care should be taken to avoid noise being induced. By a direct routing, parasitic inductance can be kept small.
- GND layers might be used for shielding.
- Keep these traces away from SW nodes .

13.2 Layout Example

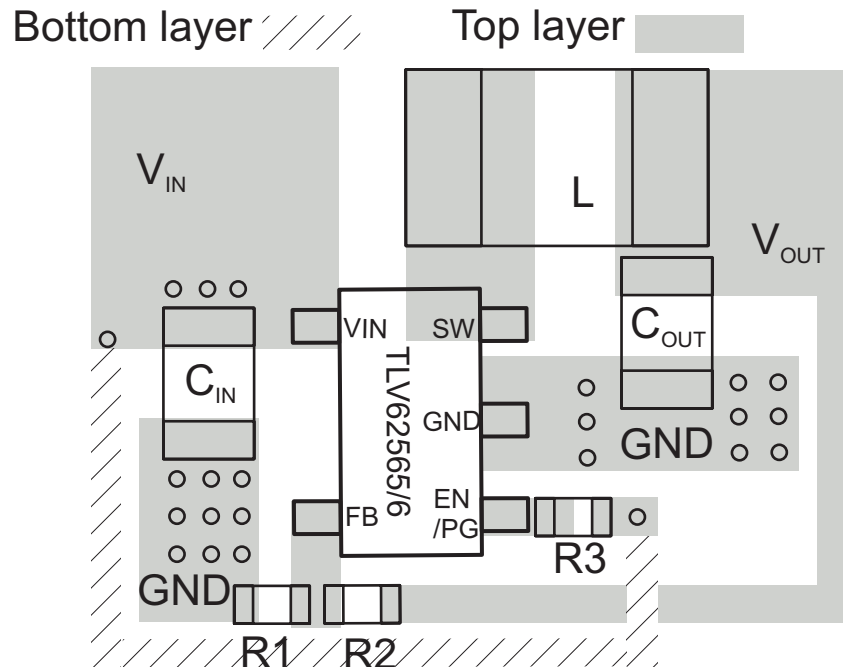

Note: PG connected to VIN via R3, EN direct connect to VIN

图 24. TLV62565 Layout

13.3 Thermal Considerations

Implementation of integrated circuits in low-profile and fine-pitch surface-mount packages typically requires special attention to power dissipation. Many system-dependent issues such as thermal coupling, airflow, convection surfaces, and the presence of other heat-generating components affect the power dissipation limits of a given component.

Two basic approaches for enhancing thermal performance are listed below:

- Improving the power dissipation capability of the PCB design
- Introducing airflow in the system

For more details on how to use the thermal parameters, see the application notes: Thermal Characteristics Application Notes [SZZA017](#) and [SPRA953](#).

14 器件和文档支持

14.1 器件支持

14.1.1 第三方产品免责声明

TI 发布的与第三方产品或服务有关的信息，不能构成与此类产品或服务或保修的适用性有关的认可，不能构成此类产品或服务单独或与任何 TI 产品或服务一起的表示或认可。

14.2 文档支持

14.2.1 相关文档

应用报告《半导体和 IC 封装热指标》（文件编号：[SPRA953](#)）

应用报告《采用 JEDEC PCB 设计的线性 and 逻辑封装散热特性》（文件编号：[SZZA017](#)）

14.3 相关链接

以下表格列出了快速访问链接。范围包括技术文档、支持与社区资源、工具和软件，并且可以快速访问样片或购买链接。

表 5. 相关链接

器件	产品文件夹	样片与购买	技术文档	工具与软件	支持与社区
TLV62565	请单击此处	请单击此处	请单击此处	请单击此处	请单击此处
TLV62566	请单击此处	请单击此处	请单击此处	请单击此处	请单击此处

14.4 商标

All trademarks are the property of their respective owners.

14.5 静电放电警告



这些装置包含有限的内置 ESD 保护。存储或装卸时，应将导线一起截短或将装置放置于导电泡棉中，以防止 MOS 门极遭受静电损伤。

14.6 术语表

[SLYZ022](#) — TI 术语表。

这份术语表列出并解释术语、首字母缩略词和定义。

15 机械、封装和可订购信息

以下页中包括机械、封装和可订购信息。这些信息是针对指定器件可提供的最新数据。这些数据会在无通知且不对本文档进行修订的情况下发生改变。欲获得该数据表的浏览器版本，请查阅左侧的导航栏。

PACKAGING INFORMATION

Orderable part number	Status (1)	Material type (2)	Package Pins	Package qty Carrier	RoHS (3)	Lead finish/ Ball material (4)	MSL rating/ Peak reflow (5)	Op temp (°C)	Part marking (6)
TLV62565DBVR	Active	Production	SOT-23 (DBV) 5	3000 LARGE T&R	Yes	NIPDAU SN	Level-1-260C-UNLIM	-40 to 85	SIK
TLV62565DBVR.A	Active	Production	SOT-23 (DBV) 5	3000 LARGE T&R	Yes	SN	Level-1-260C-UNLIM	-40 to 85	SIK
TLV62565DBVT	Active	Production	SOT-23 (DBV) 5	250 SMALL T&R	Yes	NIPDAU SN	Level-1-260C-UNLIM	-40 to 85	SIK
TLV62565DBVT.A	Active	Production	SOT-23 (DBV) 5	250 SMALL T&R	Yes	NIPDAU	Level-1-260C-UNLIM	-40 to 85	SIK
TLV62566DBVR	Active	Production	SOT-23 (DBV) 5	3000 LARGE T&R	Yes	NIPDAU SN	Level-1-260C-UNLIM	-40 to 85	SIL
TLV62566DBVR.A	Active	Production	SOT-23 (DBV) 5	3000 LARGE T&R	Yes	NIPDAU	Level-1-260C-UNLIM	-40 to 85	SIL
TLV62566DBVT	Active	Production	SOT-23 (DBV) 5	250 SMALL T&R	Yes	NIPDAU SN	Level-1-260C-UNLIM	-40 to 85	SIL
TLV62566DBVT.A	Active	Production	SOT-23 (DBV) 5	250 SMALL T&R	Yes	NIPDAU	Level-1-260C-UNLIM	-40 to 85	SIL
TLV62566DBVTG4	Active	Production	SOT-23 (DBV) 5	250 SMALL T&R	Yes	NIPDAU	Level-1-260C-UNLIM	-40 to 85	SIL
TLV62566DBVTG4.A	Active	Production	SOT-23 (DBV) 5	250 SMALL T&R	Yes	NIPDAU	Level-1-260C-UNLIM	-40 to 85	SIL

(1) **Status:** For more details on status, see our [product life cycle](#).

(2) **Material type:** When designated, preproduction parts are prototypes/experimental devices, and are not yet approved or released for full production. Testing and final process, including without limitation quality assurance, reliability performance testing, and/or process qualification, may not yet be complete, and this item is subject to further changes or possible discontinuation. If available for ordering, purchases will be subject to an additional waiver at checkout, and are intended for early internal evaluation purposes only. These items are sold without warranties of any kind.

(3) **RoHS values:** Yes, No, RoHS Exempt. See the [TI RoHS Statement](#) for additional information and value definition.

(4) **Lead finish/Ball material:** Parts may have multiple material finish options. Finish options are separated by a vertical ruled line. Lead finish/Ball material values may wrap to two lines if the finish value exceeds the maximum column width.

(5) **MSL rating/Peak reflow:** The moisture sensitivity level ratings and peak solder (reflow) temperatures. In the event that a part has multiple moisture sensitivity ratings, only the lowest level per JEDEC standards is shown. Refer to the shipping label for the actual reflow temperature that will be used to mount the part to the printed circuit board.

(6) **Part marking:** There may be an additional marking, which relates to the logo, the lot trace code information, or the environmental category of the part.

Multiple part markings will be inside parentheses. Only one part marking contained in parentheses and separated by a "~" will appear on a part. If a line is indented then it is a continuation of the previous line and the two combined represent the entire part marking for that device.

Important Information and Disclaimer:The information provided on this page represents TI's knowledge and belief as of the date that it is provided. TI bases its knowledge and belief on information provided by third parties, and makes no representation or warranty as to the accuracy of such information. Efforts are underway to better integrate information from third parties. TI has taken and continues to take reasonable steps to provide representative

and accurate information but may not have conducted destructive testing or chemical analysis on incoming materials and chemicals. TI and TI suppliers consider certain information to be proprietary, and thus CAS numbers and other limited information may not be available for release.

In no event shall TI's liability arising out of such information exceed the total purchase price of the TI part(s) at issue in this document sold by TI to Customer on an annual basis.

TAPE AND REEL INFORMATION

QUADRANT ASSIGNMENTS FOR PIN 1 ORIENTATION IN TAPE

*All dimensions are nominal

Device	Package Type	Package Drawing	Pins	SPQ	Reel Diameter (mm)	Reel Width W1 (mm)	A0 (mm)	B0 (mm)	K0 (mm)	P1 (mm)	W (mm)	Pin1 Quadrant
TLV62565DBVR	SOT-23	DBV	5	3000	180.0	8.4	3.2	3.2	1.4	4.0	8.0	Q3
TLV62565DBVT	SOT-23	DBV	5	250	180.0	8.4	3.2	3.2	1.4	4.0	8.0	Q3
TLV62565DBVT	SOT-23	DBV	5	250	180.0	8.4	3.2	3.2	1.4	4.0	8.0	Q3
TLV62566DBVR	SOT-23	DBV	5	3000	180.0	8.4	3.2	3.2	1.4	4.0	8.0	Q3
TLV62566DBVR	SOT-23	DBV	5	3000	180.0	8.4	3.2	3.2	1.4	4.0	8.0	Q3
TLV62566DBVT	SOT-23	DBV	5	250	180.0	8.4	3.2	3.2	1.4	4.0	8.0	Q3
TLV62566DBVTG4	SOT-23	DBV	5	250	180.0	8.4	3.2	3.2	1.4	4.0	8.0	Q3

TAPE AND REEL BOX DIMENSIONS

*All dimensions are nominal

Device	Package Type	Package Drawing	Pins	SPQ	Length (mm)	Width (mm)	Height (mm)
TLV62565DBVR	SOT-23	DBV	5	3000	210.0	185.0	35.0
TLV62565DBVT	SOT-23	DBV	5	250	210.0	185.0	35.0
TLV62565DBVT	SOT-23	DBV	5	250	210.0	185.0	35.0
TLV62566DBVR	SOT-23	DBV	5	3000	210.0	185.0	35.0
TLV62566DBVR	SOT-23	DBV	5	3000	210.0	185.0	35.0
TLV62566DBVT	SOT-23	DBV	5	250	210.0	185.0	35.0
TLV62566DBVTG4	SOT-23	DBV	5	250	210.0	185.0	35.0

EXAMPLE BOARD LAYOUT

DBV0005A

SOT-23 - 1.45 mm max height

SMALL OUTLINE TRANSISTOR



LAND PATTERN EXAMPLE
EXPOSED METAL SHOWN
SCALE:15X



SOLDER MASK DETAILS

4214839/K 08/2024

NOTES: (continued)

- 6. Publication IPC-7351 may have alternate designs.
- 7. Solder mask tolerances between and around signal pads can vary based on board fabrication site.

EXAMPLE STENCIL DESIGN

DBV0005A

SOT-23 - 1.45 mm max height

SMALL OUTLINE TRANSISTOR



SOLDER PASTE EXAMPLE
BASED ON 0.125 mm THICK STENCIL
SCALE:15X

4214839/K 08/2024

NOTES: (continued)

8. Laser cutting apertures with trapezoidal walls and rounded corners may offer better paste release. IPC-7525 may have alternate design recommendations.
9. Board assembly site may have different recommendations for stencil design.

重要通知和免责声明

TI“按原样”提供技术和可靠性数据（包括数据表）、设计资源（包括参考设计）、应用或其他设计建议、网络工具、安全信息和其他资源，不保证没有瑕疵且不做任何明示或暗示的担保，包括但不限于对适销性、与某特定用途的适用性或不侵犯任何第三方知识产权的暗示担保。

这些资源可供使用 TI 产品进行设计的熟练开发人员使用。您将自行承担以下全部责任：(1) 针对您的应用选择合适的 TI 产品，(2) 设计、验证并测试您的应用，(3) 确保您的应用满足相应标准以及任何其他安全、安保法规或其他要求。

这些资源如有变更，恕不另行通知。TI 授权您仅可将这些资源用于研发本资源所述的 TI 产品的相关应用。严禁以其他方式对这些资源进行复制或展示。您无权使用任何其他 TI 知识产权或任何第三方知识产权。对于因您对这些资源的使用而对 TI 及其代表造成的任何索赔、损害、成本、损失和债务，您将全额赔偿，TI 对此概不负责。

TI 提供的产品受 [TI 销售条款](#)、[TI 通用质量指南](#) 或 [ti.com](#) 上其他适用条款或 TI 产品随附的其他适用条款的约束。TI 提供这些资源并不会扩展或以其他方式更改 TI 针对 TI 产品发布的适用的担保或担保免责声明。除非德州仪器 (TI) 明确将某产品指定为定制产品或客户特定产品，否则其产品均为按确定价格收入目录的标准通用器件。

TI 反对并拒绝您可能提出的任何其他或不同的条款。

版权所有 © 2026，德州仪器 (TI) 公司

最后更新日期：2025 年 10 月