

TLC227x-Q1 高级轨到轨 LinCMOS™ 运算放大器

1 特性

- 符合面向汽车应用的 AEC-Q100 标准
 - 温度等级 1：- 40 °C 至 125 °C、 T_A
- 提供功能安全
 - 可提供用于功能安全系统设计的文档 (TLC2272-Q1)
 - 可提供用于功能安全系统设计的文档 (TLC2272A-Q1)
- 输出摆幅包括两个电源轨
- 低噪声：在 $f = 1\text{kHz}$ 时为 $9\text{nV}/\sqrt{\text{Hz}}$ (典型值)
- 低输入偏置电流：1pA (典型值)
- 完全符合单电源及双电源供电的要求
- 共模输入电压范围包括负轨
- 高增益带宽：2.2MHz (典型值)
- 高压摆率：3.6V/ μs (典型值)
- 低输入失调电压： $T_A = 25^\circ\text{C}$ 时最大值为 $950\ \mu\text{V}$
- 包括宏模型

2 应用

- 车身控制模块
- 电池管理系统
- 车载音频
- 直流/直流转换器
- 电动动力转向
- 引擎控制单元
- 汽油引擎
- 仪表组
- 逆变器和电机控制
- 车载充电器
- 远程信息处理控制单元
- 变速器控制
- 白色家电 (冰箱、洗衣机)

3 说明

TLC227x-Q1 为双通道和四通道 LinCMOS™ 运算放大器。两款器件均在单电源或双电源应用中表现出优异的轨到轨输出性能，能够进一步扩大动态范围。TLC227x-Q1 系列器件可为更高速率的应用提供 2MHz 的带宽和 3V/ μs 的压摆率。这些器件能够提供出色的交流性能，其噪声、输入失调电压和功耗均低于现有 CMOS 运算放大器。TLC227x-Q1 的噪声电压为 $9\text{nV}/\sqrt{\text{Hz}}$ ，是同类解决方案的二分之一。

TLC227x-Q1 具有高输入阻抗和低噪声特性，是用于高阻抗源 (如压电式传感器) 小信号调节的理想选择。此外，该系列器件的单电源或双电源具有轨到轨输出特性，是与模数转换器 (ADC) 连接的理想选择。

对于精密应用，TLC227xA-Q1 系列器件的最大输入失调电压为 $950\ \mu\text{V}$ 。该器件系列的额定工作电压为 5V 或 $\pm 5\text{V}$ 。

这些器件可提供更大的输出动态范围，更低的噪声电压和输入失调电压。凭借这一系列增强特性，TLC227x-Q1 能够用于更广泛的应用。对于需要更高输出驱动和更宽输入电压范围的应用，请参阅 [TLV2432-Q1](#) 和 [TLV2442-Q1](#)。TLC227x-Q1 系列器件的所有参数使这些器件能够适用于大多数汽车应用。

封装信息

器件型号	封装 ⁽¹⁾	封装尺寸 (标称值)
TLC2272-Q1、 TLC2272A-Q1	SOIC (8)	4.90mm x 3.91mm
	TSSOP (8)	3.00mm x 4.40mm
TLC2274-Q1、 TLC2274A-Q1	SOIC (14)	8.65mm x 3.91mm
	TSSOP (14)	5.00mm x 4.40mm

(1) 如需了解所有可用封装，请参阅数据表末尾的可订购产品附录。

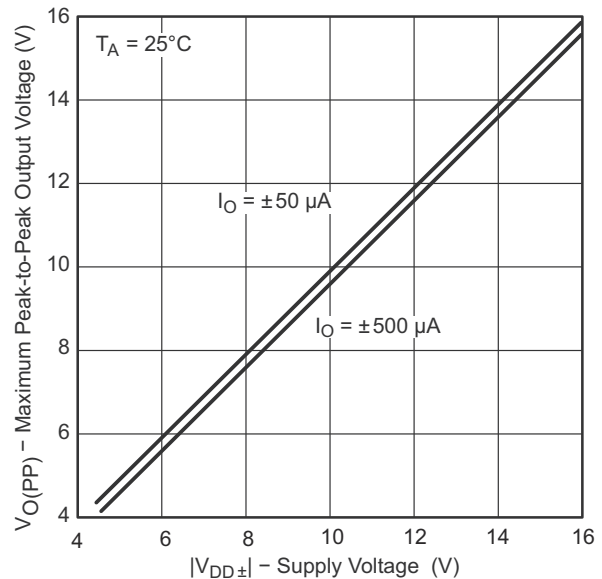

最大峰-峰值输出电压与电源电压



Table of Contents

1 特性	1	7.1 Overview.....	22
2 应用	1	7.2 Functional Block Diagram.....	22
3 说明	1	7.3 Feature Description.....	22
4 Revision History	2	7.4 Device Functional Modes.....	22
5 Pin Configuration and Functions	3	8 Application and Implementation	23
6 Specifications	4	8.1 Application Information.....	23
6.1 Absolute Maximum Ratings.....	4	8.2 Typical Application.....	24
6.2 ESD Ratings.....	4	8.3 Power Supply Recommendations.....	26
6.3 Recommended Operating Conditions.....	4	8.4 Layout.....	26
6.4 Thermal Information.....	5	9 Device and Documentation Support	28
6.5 Electrical Characteristics: $V_{DD} = 5\text{ V}$ (TLC2272-Q1 and TLC2272A-Q1).....	5	9.1 Device Support.....	28
6.6 Electrical Characteristics: $V_{DD\pm} = \pm 5\text{ V}$ (TLC2272-Q1 and TLC2272A-Q1).....	6	9.2 Documentation Support.....	28
6.7 Electrical Characteristics: $V_{DD} = 5\text{ V}$ (TLC2274-Q1 and TLC2274A-Q1).....	8	9.3 接收文档更新通知.....	28
6.8 Electrical Characteristics: $V_{DD\pm} = \pm 5\text{ V}$ (TLC2274-Q1 and TLC2274A-Q1).....	9	9.4 支持资源.....	28
6.9 Typical Characteristics.....	11	9.5 Trademarks.....	28
7 Detailed Description	22	9.6 Electrostatic Discharge Caution.....	29
		9.7 术语表.....	29
		10 Mechanical, Packaging, and Orderable Information	29

4 Revision History

注：以前版本的页码可能与当前版本的页码不同

Changes from Revision F (March 2016) to Revision G (August 2022)	Page
• 更新了整个文档中的表格、图和交叉参考的编号格式.....	1
• 向特性要点添加了功能安全信息.....	1
Changes from Revision E (January 2012) to Revision F (March 2016)	Page
• 添加了引脚配置和功能部分、特性说明部分、器件功能模式、应用和实施部分、电源相关建议部分、布局部分、器件和文档支持部分以及机械、封装和可订购信息部分.....	1
• Added ESD ratings table.....	4
Changes from Revision D (March 2009) to Revision E (January 2012)	Page
• Deleted ESD ratings table.....	4

5 Pin Configuration and Functions

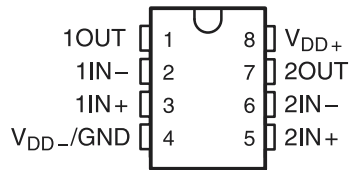

**图 5-1. TLC2272-Q1 and TLC2272A-Q1:
 D (8-Pin SOIC) or PW (8-Pin TSSOP)
 Packages, Top View**

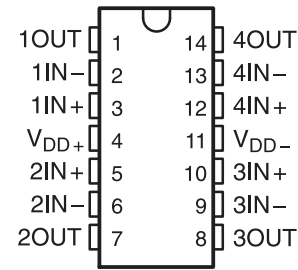

**图 5-2. TLC2274-Q1 and TLC2274A-Q1:
 D (14-Pin SOIC) or PW (14-Pin TSSOP)
 Packages, Top View**

表 5-1. Pin Functions

NAME	PIN NO.		TYPE	DESCRIPTION
	TLC2272-Q1, TLC2272A-Q1	TLC2274-Q1, TLC2274A-Q1		
1IN+	3	3	Input	Noninverting input, channel 1
1IN -	2	2	Input	Inverting input, channel 1
1OUT	1	1	Output	Output, channel 1
2IN+	5	5	Input	Noninverting input, channel 2
2IN -	6	6	Input	Inverting input, channel 2
2OUT	7	7	Ouput	Output, channel 2
3IN+	—	10	Input	Noninverting input, channel 3
3IN -	—	9	Input	Inverting input, channel 3
3OUT	—	8	Output	Output, channel 3
4IN+	—	12	Input	Noninverting input, channel 4
4IN -	—	13	Input	Inverting input, channel 4
4OUT	—	14	Output	Output, channel 4
V _{DD+}	8	4	Input	Positive (highest) supply
V _{DD-}	4	11	Input	Negative (lowest) supply

6 Specifications

6.1 Absolute Maximum Ratings

over operating free-air temperature range (unless otherwise noted)⁽¹⁾

	MIN	MAX	UNIT
Supply voltage, V_{DD+} ⁽²⁾		8	V
V_{DD-} ⁽²⁾	- 8		V
Differential input voltage, V_{ID} ⁽³⁾		±16	V
Input voltage, V_I (any input) ⁽²⁾	$V_{DD-} - 0.3$	V_{DD+}	V
Input current, I_I (any input)		±5	mA
Output current, I_O		±50	mA
Total current into V_{DD+}		±50	mA
Total current out of V_{DD-}		±50	mA
Duration of short-circuit current at (or below) 25°C ⁽⁴⁾		Unlimited	
Operating free-air temperature range, T_A	- 40	125	°C
Lead temperature 1,6 mm (1/16 inch) from case for 10 seconds		260	°C
	D or PW package		
Storage temperature, T_{stg}	- 65	150	°C

- (1) Stresses beyond those listed under *Absolute Maximum Ratings* may cause permanent damage to the device. These are stress ratings only, which do not imply functional operation of the device at these or any other conditions beyond those indicated under [# 6.3](#). Exposure to absolute-maximum-rated conditions for extended periods may affect device reliability.
- (2) All voltage values, except differential voltages, are with respect to the midpoint between V_{DD+} and V_{DD-} .
- (3) Differential voltages are at IN+ with respect to IN-. Excessive current will flow if input is brought below $V_{DD-} - 0.3$ V.
- (4) The output can be shorted to either supply. Temperature or supply voltages must be limited so that the maximum dissipation rating is not exceeded.

6.2 ESD Ratings

		VALUE	UNIT
$V_{(ESD)}$	Electrostatic discharge	Human-body model (HBM), per AEC Q100-002 ⁽¹⁾ HBM ESD classification level 2	±2000
		Charged-device model (CDM), per AEC Q100-011 CDM ESD classification level C6	±1000

- (1) AEC Q100-002 indicates that HBM stressing shall be in accordance with the ANSI/ESDA/JEDEC JS-001 specification.

6.3 Recommended Operating Conditions

over operating free-air temperature range (unless otherwise noted)

		MIN	MAX	UNIT
$V_{DD±}$	Supply voltage	±2.2	±8	V
V_I	Input voltage	V_{DD-}	$V_{DD+} - 1.5$	V
V_{IC}	Common-mode input voltage	V_{DD-}	$V_{DD+} - 1.5$	V
T_A	Operating free-air temperature	-40	125	°C

6.4 Thermal Information

THERMAL METRIC ⁽¹⁾		TLC2272-Q1, TLC2272A-Q1		TLC2274-Q1, TLC2274A-Q1		UNIT
		D (SOIC)	PW (TSSOP)	D (SOIC)	PW (TSSOP)	
		8 PINS	8 PINS	14 PINS	14 PINS	
$R_{\theta JA}$	Junction-to-ambient thermal resistance	115.6	175.8	83.8	111.6	°C/W
$R_{\theta JC(top)}$	Junction-to-case (top) thermal resistance	61.8	58.8	43.2	41.2	°C/W
$R_{\theta JB}$	Junction-to-board thermal resistance	55.9	104.3	38.4	54.7	°C/W
ψ_{JT}	Junction-to-top characterization parameter	14.3	5.9	9.4	3.9	°C/W
ψ_{JB}	Junction-to-board characterization parameter	55.4	102.3	38.1	53.9	°C/W
$R_{\theta JC(bot)}$	Junction-to-case (bottom) thermal resistance	—	—	—	—	°C/W

(1) For more information about traditional and new thermal metrics, see the [Semiconductor and IC Package Thermal Metrics application report](#).

6.5 Electrical Characteristics: $V_{DD} = 5\text{ V}$ (TLC2272-Q1 and TLC2272A-Q1)

at specified free-air temperature, $V_{DD} = 5\text{ V}$; $T_A = 25^\circ\text{C}$, unless otherwise noted.

PARAMETER		TEST CONDITIONS		MIN	TYP	MAX	UNIT
V_{IO}	Input offset voltage	$V_{IC} = 0\text{ V}$, $V_{DD\pm} = \pm 2.5\text{ V}$, $V_O = 0\text{ V}$, $R_S = 50\ \Omega$	TLC2272-Q1	$T_A = 25^\circ\text{C}$	300	2500	μV
			TLC2272A-Q1		300	950	
			TLC2272-Q1	Full Range ⁽¹⁾		3000	
			TLC2272A-Q1		1500		
α_{VIO}	Temperature coefficient of input offset voltage	$V_{IC} = 0\text{ V}$, $V_{DD\pm} = \pm 2.5\text{ V}$, $V_O = 0\text{ V}$, $R_S = 50\ \Omega$			2		$\mu\text{V}/^\circ\text{C}$
	Input offset voltage long-term drift ⁽²⁾	$V_{IC} = 0\text{ V}$, $V_{DD\pm} = \pm 2.5\text{ V}$, $V_O = 0\text{ V}$, $R_S = 50\ \Omega$			0.002		$\mu\text{V}/\text{mo}$
I_{IO}	Input offset current	$V_{IC} = 0\text{ V}$, $V_{DD\pm} = \pm 2.5\text{ V}$, $V_O = 0\text{ V}$, $R_S = 50\ \Omega$	$T_A = 25^\circ\text{C}$	0.5	60	pA	
			Full Range ⁽¹⁾		800		
I_{IB}	Input bias current	$V_{IC} = 0\text{ V}$, $V_{DD\pm} = \pm 2.5\text{ V}$, $V_O = 0\text{ V}$, $R_S = 50\ \Omega$	$T_A = 25^\circ\text{C}$	1	60	pA	
			Full Range ⁽¹⁾		800		
V_{ICR}	Common-mode input voltage	$R_S = 50\ \Omega$; $ V_{IO} \leq 5\text{ mV}$	$T_A = 25^\circ\text{C}$	-0.3	2.5	4	V
			Full Range ⁽¹⁾	0	2.5	3.5	
V_{OH}	High-level output voltage	$I_{OH} = -20\ \mu\text{A}$ $I_{OH} = -200\ \mu\text{A}$ $I_{OH} = -1\text{ mA}$	$T_A = 25^\circ\text{C}$	4.85	4.93	V	
			Full Range ⁽¹⁾	4.85			
			$T_A = 25^\circ\text{C}$	4.25	4.65		
			Full Range ⁽¹⁾	4.25			
V_{OL}	Low-level output voltage	$V_{IC} = 2.5\text{ V}$	$I_{OL} = 50\ \mu\text{A}$		0.01	V	
			$I_{OL} = 500\ \mu\text{A}$	$T_A = 25^\circ\text{C}$	0.09		0.15
				Full Range ⁽¹⁾			0.15
			$I_{OL} = 5\text{ mA}$	$T_A = 25^\circ\text{C}$	0.9		1.5
				Full Range ⁽¹⁾			1.5
			A_{VD}	Large-signal differential voltage amplification	$V_{IC} = 2.5\text{ V}$, $V_O = 1\text{ V to }4\text{ V}$		$R_L = 10\text{ k}\Omega$ ⁽³⁾
$R_L = 1\text{ M}\Omega$ ⁽³⁾	Full Range ⁽¹⁾	10					
						175	
r_{id}	Differential input resistance				10^{12}	Ω	
r_i	Common-mode input resistance				10^{12}	Ω	
C_i	Common-mode input capacitance	f = 10 kHz, P package			8	pF	
Z_o	Closed-loop output impedance	f = 1 MHz, $A_V = 10$			140	Ω	
CMRR	Common-mode rejection ratio	$V_{IC} = 0\text{ V to }2.7\text{ V}$, $V_O = 2.5\text{ V}$, $R_S = 50\ \Omega$	$T_A = 25^\circ\text{C}$	70	75	dB	
			Full Range ⁽¹⁾	70			
k_{SVR}	Supply-voltage rejection ratio ($\Delta V_{DD} / \Delta V_{IO}$)	$V_{DD} = 4.4\text{ V to }16\text{ V}$, $V_{IC} = V_{DD} / 2$, no load	$T_A = 25^\circ\text{C}$	80	95	dB	
			Full Range ⁽¹⁾	80			

6.5 Electrical Characteristics: $V_{DD} = 5\text{ V}$ (TLC2272-Q1 and TLC2272A-Q1) (continued)

at specified free-air temperature, $V_{DD} = 5\text{ V}$; $T_A = 25^\circ\text{C}$, unless otherwise noted.

PARAMETER		TEST CONDITIONS		MIN	TYP	MAX	UNIT
I_{DD}	Supply current	$V_O = 2.5\text{ V}$, no load	$T_A = 25^\circ\text{C}$		2.2	3	mA
			Full Range ⁽¹⁾			3	
SR	Slew rate at unity gain	$V_O = 0.5\text{ V}$ to 2.5 V , $R_L = 10\text{ k}\Omega$ ⁽³⁾ , $C_L = 100\text{ pF}$ ⁽³⁾	$T_A = 25^\circ\text{C}$		2.3	3.6	V/ μs
			Full Range ⁽¹⁾		1.7		
V_n	Equivalent input noise voltage	f = 10 Hz f = 1 kHz			50		nV/ $\sqrt{\text{Hz}}$
					9		
V_{NPP}	Peak-to-peak equivalent input noise voltage	f = 0.1 Hz to 1 Hz f = 0.1 Hz to 10 Hz			1		μV
					1.4		
I_n	Equivalent input noise current				0.6		fA/ $\sqrt{\text{Hz}}$
THD+N	Total harmonic distortion + noise	$V_O = 0.5\text{ V}$ to 2.5 V , f = 20 kHz, $R_L = 10\text{ k}\Omega$ ⁽³⁾	$A_V = 1$		0.0013%		
			$A_V = 10$		0.004%		
			$A_V = 100$		0.03%		
	Gain-bandwidth product	f = 10 kHz, $R_L = 10\text{ k}\Omega$ ⁽³⁾ , $C_L = 100\text{ pF}$ ⁽³⁾			2.18		MHz
B_{OM}	Maximum output-swing bandwidth	$V_{O(PP)} = 2\text{ V}$, $A_V = 1$, $R_L = 10\text{ k}\Omega$ ⁽³⁾ , $C_L = 100\text{ pF}$ ⁽³⁾			1		MHz
t_s	Settling time	$A_V = -1$, $R_L = 10\text{ k}\Omega$ ⁽³⁾ , Step = 0.5 V to 2.5 V , $C_L = 100\text{ pF}$ ⁽³⁾	To 0.1%		1.5		μs
			To 0.01%		2.6		
ϕ_m	Phase margin at unity gain	$R_L = 10\text{ k}\Omega$ ⁽³⁾ , $C_L = 100\text{ pF}$ ⁽³⁾			50°		
	Gain margin	$R_L = 10\text{ k}\Omega$ ⁽³⁾ , $C_L = 100\text{ pF}$ ⁽³⁾			10		dB

(1) $T_A = -40^\circ\text{C}$ to 125°C .

(2) Typical values are based on the input offset voltage shift observed through 168 hours of operating life test at $T_A = 150^\circ\text{C}$ extrapolated to $T_A = 25^\circ\text{C}$ using the Arrhenius equation and assuming an activation energy of 0.96 eV.

(3) Referenced to 0 V.

6.6 Electrical Characteristics: $V_{DD\pm} = \pm 5\text{ V}$ (TLC2272-Q1 and TLC2272A-Q1)

at specified free-air temperature, $V_{DD\pm} = \pm 5\text{ V}$; $T_A = 25^\circ\text{C}$, unless otherwise noted.

PARAMETER		TEST CONDITIONS		MIN	TYP	MAX	UNIT	
V_{IO}	Input offset voltage	$V_{IC} = 0\text{ V}$, $V_O = 0\text{ V}$, $R_S = 50\ \Omega$	TLC2272-Q1	$T_A = 25^\circ\text{C}$	300	2500	μV	
			TLC2272A-Q1		300	950		
			TLC2272-Q1	Full Range ⁽¹⁾		3000		
			TLC2272A-Q1			1500		
α_{VIO}	Temperature coefficient of input offset voltage	$V_{IC} = 0\text{ V}$, $V_O = 0\text{ V}$, $R_S = 50\ \Omega$			2		$\mu\text{V}/^\circ\text{C}$	
	Input offset voltage long-term drift ⁽²⁾	$V_{IC} = 0\text{ V}$, $V_O = 0\text{ V}$, $R_S = 50\ \Omega$			0.002		$\mu\text{V}/\text{mo}$	
I_{IO}	Input offset current	$V_{IC} = 0\text{ V}$, $V_O = 0\text{ V}$, $R_S = 50\ \Omega$	$T_A = 25^\circ\text{C}$		0.5	60	pA	
			Full Range ⁽¹⁾			800		
I_{IB}	Input bias current	$V_{IC} = 0\text{ V}$, $V_O = 0\text{ V}$, $R_S = 50\ \Omega$	$T_A = 25^\circ\text{C}$		1	60	pA	
			Full Range ⁽¹⁾			800		
V_{ICR}	Common-mode input voltage	$R_S = 50\ \Omega$; $ V_{IO} \leq 5\text{ mV}$	$T_A = 25^\circ\text{C}$		-5.3	0	4	V
			Full Range ⁽¹⁾		-5	0	3.5	
V_{OM+}	Maximum positive peak output voltage	$I_O = -20\ \mu\text{A}$ $I_O = -200\ \mu\text{A}$ $I_O = -1\text{ mA}$			4.99		V	
			$T_A = 25^\circ\text{C}$		4.85	4.93		
			Full Range ⁽¹⁾		4.85			
			$T_A = 25^\circ\text{C}$		4.25	4.65		
			Full Range ⁽¹⁾		4.25			

6.6 Electrical Characteristics: $V_{DD\pm} = \pm 5\text{ V}$ (TLC2272-Q1 and TLC2272A-Q1) (continued)

at specified free-air temperature, $V_{DD\pm} = \pm 5\text{ V}$; $T_A = 25^\circ\text{C}$, unless otherwise noted.

PARAMETER		TEST CONDITIONS		MIN	TYP	MAX	UNIT
V_{OM-}	Maximum negative peak output voltage	$V_{IC} = 0\text{ V}$	$I_O = 50\ \mu\text{A}$			-4.99	V
			$I_O = 500\ \mu\text{A}$	$T_A = 25^\circ\text{C}$	-4.85	-4.91	
				Full Range ⁽¹⁾	-4.85		
			$I_O = 5\text{ mA}$	$T_A = 25^\circ\text{C}$	-3.5	-4.1	
Full Range ⁽¹⁾	-3.5						
A_{VD}	Large-signal differential voltage amplification	$V_O = \pm 4\text{ V}$	$R_L = 10\text{ k}\Omega$	$T_A = 25^\circ\text{C}$	20	50	V/mV
				Full Range ⁽¹⁾	20		
			$R_L = 1\text{ M}\Omega$			300	
r_{id}	Differential input resistance				10^{12}		Ω
r_i	Common-mode input resistance				10^{12}		Ω
c_i	Common-mode input capacitance	$f = 10\text{ kHz}$, P package			8		pF
z_o	Closed-loop output impedance	$f = 1\text{ MHz}$, $A_V = 10$			130		Ω
CMRR	Common-mode rejection ratio	$V_{IC} = -5\text{ V to } 2.7\text{ V}$, $V_O = 0\text{ V}$, $R_S = 50\ \Omega$	$T_A = 25^\circ\text{C}$	75	80	dB	
			Full Range ⁽¹⁾	75			
k_{SVR}	Supply-voltage rejection ratio ($\Delta V_{DD} / \Delta V_{IO}$)	$V_{DD+} = 2.2\text{ V to } \pm 8\text{ V}$, $V_{IC} = 0\text{ V}$, no load	$T_A = 25^\circ\text{C}$	80	95	dB	
			Full Range ⁽¹⁾	80			
I_{DD}	Supply current	$V_O = 0\text{ V}$, no load	$T_A = 25^\circ\text{C}$		2.4	3	mA
			Full Range ⁽¹⁾			3	
SR	Slew rate at unity gain	$V_O = \pm 2.3\text{ V}$, $R_L = 10\text{ k}\Omega$, $C_L = 100\text{ pF}$	$T_A = 25^\circ\text{C}$	2.3	3.6	V/ μs	
			Full Range ⁽¹⁾	1.7			
V_n	Equivalent input noise voltage	$f = 10\text{ Hz}$			50	nV/ $\sqrt{\text{Hz}}$	
		$f = 1\text{ kHz}$			9		
V_{NPP}	Peak-to-peak equivalent input noise voltage	$f = 0.1\text{ Hz to } 1\text{ Hz}$			1	μV	
		$f = 0.1\text{ Hz to } 10\text{ Hz}$			1.4		
I_n	Equivalent input noise current				0.6	fA/ $\sqrt{\text{Hz}}$	
THD+N	Total harmonic distortion + noise	$V_O = \pm 2.3$, $f = 20\text{ kHz}$, $R_L = 10\text{ k}\Omega$	$A_V = 1$		0.0011%		
			$A_V = 10$		0.004%		
			$A_V = 100$		0.03%		
	Gain-bandwidth product	$f = 10\text{ kHz}$, $R_L = 10\text{ k}\Omega$, $C_L = 100\text{ pF}$			2.25	MHz	
B_{OM}	Maximum output-swing bandwidth	$V_{O(PP)} = 4.6\text{ V}$, $A_V = 1$, $R_L = 10\text{ k}\Omega$, $C_L = 100\text{ pF}$			0.54	MHz	
t_s	Settling time	$A_V = -1$, $R_L = 10\text{ k}\Omega$, Step = $-2.3\text{ V to } 2.3\text{ V}$, $C_L = 100\text{ pF}$	To 0.1%		1.5	μs	
			To 0.01%		3.2		
ϕ_m	Phase margin at unity gain	$R_L = 10\text{ k}\Omega$, $C_L = 100\text{ pF}$			52°		
	Gain margin	$R_L = 10\text{ k}\Omega$, $C_L = 100\text{ pF}$			10	dB	

(1) $T_A = -40^\circ\text{C to } 125^\circ\text{C}$.

(2) Typical values are based on the input offset voltage shift observed through 168 hours of operating life test at $T_A = 150^\circ\text{C}$ extrapolated to $T_A = 25^\circ\text{C}$ using the Arrhenius equation and assuming an activation energy of 0.96 eV.

6.7 Electrical Characteristics: $V_{DD} = 5\text{ V}$ (TLC2274-Q1 and TLC2274A-Q1)

at specified free-air temperature, $V_{DD} = 5\text{ V}$; $T_A = 25^\circ\text{C}$, unless otherwise noted.

PARAMETER		TEST CONDITIONS		MIN	TYP	MAX	UNIT
V_{IO}	Input offset voltage	$V_{IC} = 0\text{ V}$, $V_{DD\pm} = \pm 2.5\text{ V}$, $V_O = 0\text{ V}$, $R_S = 50\ \Omega$	TLC2274-Q1	$T_A = 25^\circ\text{C}$	300	2500	μV
			TLC2274A-Q1		300	950	
			TLC2274-Q1	Full Range ⁽¹⁾		3000	
			TLC2274A-Q1		1500		
$^a V_{IO}$	Temperature coefficient of input offset voltage	$V_{IC} = 0\text{ V}$, $V_{DD\pm} = \pm 2.5\text{ V}$, $V_O = 0\text{ V}$, $R_S = 50\ \Omega$			2	$\mu\text{V}/^\circ\text{C}$	
	Input offset voltage long-term drift ⁽²⁾	$V_{IC} = 0\text{ V}$, $V_{DD\pm} = \pm 2.5\text{ V}$, $V_O = 0\text{ V}$, $R_S = 50\ \Omega$			0.002	$\mu\text{V}/\text{mo}$	
I_{IO}	Input offset current	$V_{IC} = 0\text{ V}$, $V_{DD\pm} = \pm 2.5\text{ V}$, $V_O = 0\text{ V}$, $R_S = 50\ \Omega$	$T_A = 25^\circ\text{C}$	0.5	60	pA	
			Full Range ⁽¹⁾		800		
I_{IB}	Input bias current	$V_{IC} = 0\text{ V}$, $V_{DD\pm} = \pm 2.5\text{ V}$, $V_O = 0\text{ V}$, $R_S = 50\ \Omega$	$T_A = 25^\circ\text{C}$	1	60	pA	
			Full Range ⁽¹⁾		800		
V_{ICR}	Common-mode input voltage	$R_S = 50\ \Omega$; $ V_{IO} \leq 5\text{ mV}$	$T_A = 25^\circ\text{C}$	-0.3	2.5	4	V
			Full Range ⁽¹⁾	0	2.5	3.5	
V_{OH}	High-level output voltage	$I_{OH} = -20\ \mu\text{A}$ $I_{OH} = -200\ \mu\text{A}$ $I_{OH} = -1\text{ mA}$			4.99	V	
			$T_A = 25^\circ\text{C}$	4.85	4.93		
			Full Range ⁽¹⁾	4.85			
			$T_A = 25^\circ\text{C}$	4.25	4.65		
V_{OL}	Low-level output voltage	$V_{IC} = 2.5\text{ V}$	$I_{OL} = 50\ \mu\text{A}$		0.01	V	
			$I_{OL} = 500\ \mu\text{A}$	$T_A = 25^\circ\text{C}$	0.09		0.15
				Full Range ⁽¹⁾			0.15
			$I_{OL} = 5\text{ mA}$	$T_A = 25^\circ\text{C}$	0.9		1.5
Full Range ⁽¹⁾		1.5					
A_{VD}	Large-signal differential voltage amplification	$V_{IC} = 2.5\text{ V}$, $V_O = 1\text{ V to }4\text{ V}$	$R_L = 10\text{ k}\Omega$ ⁽³⁾	$T_A = 25^\circ\text{C}$	10	35	V/mV
			$R_L = 1\text{ M}\Omega$ ⁽³⁾	Full Range ⁽¹⁾	10		
						175	
r_{id}	Differential input resistance				10^{12}	Ω	
r_i	Common-mode input resistance				10^{12}	Ω	
c_i	Common-mode input capacitance	$f = 10\text{ kHz}$, P package			8	pF	
z_o	Closed-loop output impedance	$f = 1\text{ MHz}$, $A_V = 10$			140	Ω	
CMRR	Common-mode rejection ratio	$V_{IC} = 0\text{ V to }2.7\text{ V}$, $V_O = 2.5\text{ V}$, $R_S = 50\ \Omega$	$T_A = 25^\circ\text{C}$	70	75	dB	
			Full Range ⁽¹⁾	70			
k_{SVR}	Supply-voltage rejection ratio ($\Delta V_{DD} / \Delta V_{IO}$)	$V_{DD} = 4.4\text{ V to }16\text{ V}$, $V_{IC} = V_{DD} / 2$, no load	$T_A = 25^\circ\text{C}$	80	95	dB	
			Full Range ⁽¹⁾	80			
I_{DD}	Supply current	$V_O = 2.5\text{ V}$, no load	$T_A = 25^\circ\text{C}$	4.4	6	mA	
			Full Range ⁽¹⁾		6		
SR	Slew rate at unity gain	$V_O = 0.5\text{ V to }2.5\text{ V}$, $R_L = 10\text{ k}\Omega$ ⁽³⁾ , $C_L = 100\text{ pF}$ ⁽³⁾	$T_A = 25^\circ\text{C}$	2.3	3.6	$\text{V}/\mu\text{s}$	
			Full Range ⁽¹⁾	1.7			
V_n	Equivalent input noise voltage	$f = 10\text{ Hz}$ $f = 1\text{ kHz}$		50	$\text{nV}/\sqrt{\text{Hz}}$		
				9			
V_{NPP}	Peak-to-peak equivalent input noise voltage	$f = 0.1\text{ Hz to }1\text{ Hz}$		1	μV		
		$f = 0.1\text{ Hz to }10\text{ Hz}$		1.4			
I_n	Equivalent input noise current			0.6	$\text{fA}/\sqrt{\text{Hz}}$		
THD+N	Total harmonic distortion + noise	$V_O = 0.5\text{ V to }2.5\text{ V}$, $f = 20\text{ kHz}$, $R_L = 10\text{ k}\Omega$ ⁽³⁾	$A_V = 1$	0.0013%			
			$A_V = 10$	0.004%			
			$A_V = 100$	0.03%			
	Gain-bandwidth product	$f = 10\text{ kHz}$, $R_L = 10\text{ k}\Omega$ ⁽³⁾ , $C_L = 100\text{ pF}$ ⁽³⁾		2.18	MHz		
B_{OM}	Maximum output-swing bandwidth	$V_{O(PP)} = 2\text{ V}$, $A_V = 1$, $R_L = 10\text{ k}\Omega$ ⁽³⁾ , $C_L = 100\text{ pF}$ ⁽³⁾		1	MHz		

6.7 Electrical Characteristics: $V_{DD} = 5\text{ V}$ (TLC2274-Q1 and TLC2274A-Q1) (continued)

at specified free-air temperature, $V_{DD} = 5\text{ V}$; $T_A = 25^\circ\text{C}$, unless otherwise noted.

PARAMETER		TEST CONDITIONS		MIN	TYP	MAX	UNIT
t_s	Settling time	$A_V = -1$, $R_L = 10\text{ k}\Omega$ ⁽³⁾ , Step = 0.5 V to 2.5 V, $C_L = 100\text{ pF}$ ⁽³⁾	To 0.1%		1.5		μs
			To 0.01%		2.6		
ϕ_m	Phase margin at unity gain	$R_L = 10\text{ k}\Omega$ ⁽³⁾ , $C_L = 100\text{ pF}$ ⁽³⁾			50°		
	Gain margin	$R_L = 10\text{ k}\Omega$ ⁽³⁾ , $C_L = 100\text{ pF}$ ⁽³⁾			10		dB

- $T_A = -40^\circ\text{C}$ to 125°C .
- Typical values are based on the input offset voltage shift observed through 168 hours of operating life test at $T_A = 150^\circ\text{C}$ extrapolated to $T_A = 25^\circ\text{C}$ using the Arrhenius equation and assuming an activation energy of 0.96 eV.
- Referenced to 0 V.

6.8 Electrical Characteristics: $V_{DD\pm} = \pm 5\text{ V}$ (TLC2274-Q1 and TLC2274A-Q1)

at specified free-air temperature, $V_{DD\pm} = \pm 5\text{ V}$; $T_A = 25^\circ\text{C}$, unless otherwise noted.

PARAMETER		TEST CONDITIONS		MIN	TYP	MAX	UNIT	
V_{IO}	Input offset voltage	$V_{IC} = 0\text{ V}$, $V_O = 0\text{ V}$, $R_S = 50\ \Omega$	TLC2274-Q1 $T_A = 25^\circ\text{C}$		300	2500	μV	
			TLC2274A-Q1		300	950		
			TLC2274-Q1 Full Range ⁽¹⁾			3000		
			TLC2274A-Q1			1500		
α_{VIO}	Temperature coefficient of input offset voltage	$V_{IC} = 0\text{ V}$, $V_O = 0\text{ V}$, $R_S = 50\ \Omega$			2		$\mu\text{V}/^\circ\text{C}$	
	Input offset voltage long-term drift ⁽²⁾	$V_{IC} = 0\text{ V}$, $V_O = 0\text{ V}$, $R_S = 50\ \Omega$			0.002		$\mu\text{V}/\text{mo}$	
I_{IO}	Input offset current	$V_{IC} = 0\text{ V}$, $V_O = 0\text{ V}$, $R_S = 50\ \Omega$	$T_A = 25^\circ\text{C}$		0.5	60	pA	
			Full Range ⁽¹⁾			800		
I_{IB}	Input bias current	$V_{IC} = 0\text{ V}$, $V_O = 0\text{ V}$, $R_S = 50\ \Omega$	$T_A = 25^\circ\text{C}$		1	60	pA	
			Full Range ⁽¹⁾			800		
V_{ICR}	Common-mode input voltage	$R_S = 50\ \Omega$; $ V_{IO} \leq 5\text{ mV}$	$T_A = 25^\circ\text{C}$		-5.3	0	4	V
			Full Range ⁽¹⁾		-5	0	3.5	
V_{OM+}	Maximum positive peak output voltage	$I_O = -20\ \mu\text{A}$	$T_A = 25^\circ\text{C}$		4.85	4.93	V	
			Full Range ⁽¹⁾		4.85			
			$T_A = 25^\circ\text{C}$		4.25	4.65		
			Full Range ⁽¹⁾		4.25			
V_{OM-}	Maximum negative peak output voltage	$V_{IC} = 0\text{ V}$	$I_O = 50\ \mu\text{A}$		-4.99		V	
			$I_O = 500\ \mu\text{A}$	$T_A = 25^\circ\text{C}$		-4.85		-4.91
				Full Range ⁽¹⁾		-4.85		
			$I_O = 5\text{ mA}$	$T_A = 25^\circ\text{C}$		-3.5		-4.1
Full Range ⁽¹⁾		-3.5						
A_{VD}	Large-signal differential voltage amplification	$V_O = \pm 4\text{ V}$	$R_L = 10\text{ k}\Omega$	$T_A = 25^\circ\text{C}$		20	50	V/mV
				Full Range ⁽¹⁾		20		
			$R_L = 1\text{ M}\Omega$			300		
r_{id}	Differential input resistance				10^{12}		Ω	
r_i	Common-mode input resistance				10^{12}		Ω	
c_i	Common-mode input capacitance	$f = 10\text{ kHz}$, P package			8		pF	
Z_o	Closed-loop output impedance	$f = 1\text{ MHz}$, $A_V = 10$			130		Ω	
CMRR	Common-mode rejection ratio	$V_{IC} = -5\text{ V}$ to 2.7 V , $V_O = 0\text{ V}$, $R_S = 50\ \Omega$	$T_A = 25^\circ\text{C}$		75	80	dB	
			Full Range ⁽¹⁾		75			
k_{SVR}	Supply-voltage rejection ratio ($\Delta V_{DD} / \Delta V_{IO}$)	$V_{DD+} = 2.2\text{ V}$ to $\pm 8\text{ V}$, $V_{IC} = 0\text{ V}$, no load	$T_A = 25^\circ\text{C}$		80	95	dB	
			Full Range ⁽¹⁾		80			
I_{DD}	Supply current	$V_O = 0\text{ V}$, no load	$T_A = 25^\circ\text{C}$		4.8	6	mA	
			Full Range ⁽¹⁾			6		

6.8 Electrical Characteristics: $V_{DD\pm} = \pm 5\text{ V}$ (TLC2274-Q1 and TLC2274A-Q1) (continued)

at specified free-air temperature, $V_{DD\pm} = \pm 5\text{ V}$; $T_A = 25^\circ\text{C}$, unless otherwise noted.

PARAMETER		TEST CONDITIONS		MIN	TYP	MAX	UNIT
SR	Slew rate at unity gain	$V_O = \pm 2.3\text{ V}$, $R_L = 10\text{ k}\Omega$, $C_L = 100\text{ pF}$	$T_A = 25^\circ\text{C}$	2.3	3.6		V/ μs
			Full Range ⁽¹⁾	1.7			
V_n	Equivalent input noise voltage		$f = 10\text{ Hz}$		50		nV/ $\sqrt{\text{Hz}}$
			$f = 1\text{ kHz}$		9		
V_{NPP}	Peak-to-peak equivalent input noise voltage		$f = 0.1\text{ Hz to }1\text{ Hz}$		1		μV
			$f = 0.1\text{ Hz to }10\text{ Hz}$		1.4		
I_n	Equivalent input noise current				0.6		fA/ $\sqrt{\text{Hz}}$
THD+N	Total harmonic distortion + noise	$V_O = \pm 2.3$, $f = 20\text{ kHz}$, $R_L = 10\text{ k}\Omega$	$A_V = 1$		0.0011%		
			$A_V = 10$		0.004%		
			$A_V = 100$		0.03%		
	Gain-bandwidth product	$f = 10\text{ kHz}$, $R_L = 10\text{ k}\Omega$, $C_L = 100\text{ pF}$			2.25		MHz
B_{OM}	Maximum output-swing bandwidth	$V_{O(PP)} = 4.6\text{ V}$, $A_V = 1$, $R_L = 10\text{ k}\Omega$, $C_L = 100\text{ pF}$			0.54		MHz
t_s	Settling time	$A_V = -1$, $R_L = 10\text{ k}\Omega$, Step = $-2.3\text{ V to }2.3\text{ V}$, $C_L = 100\text{ pF}$	To 0.1%		1.5		μs
			To 0.01%		3.2		
ϕ_m	Phase margin at unity gain	$R_L = 10\text{ k}\Omega$, $C_L = 100\text{ pF}$			52°		
	Gain margin	$R_L = 10\text{ k}\Omega$, $C_L = 100\text{ pF}$			10		dB

(1) $T_A = -40^\circ\text{C to }125^\circ\text{C}$.

(2) Typical values are based on the input offset voltage shift observed through 168 hours of operating life test at $T_A = 150^\circ\text{C}$ extrapolated to $T_A = 25^\circ\text{C}$ using the Arrhenius equation and assuming an activation energy of 0.96 eV.

6.9 Typical Characteristics

表 6-1. Table of Graphs

			FIGURE ⁽¹⁾
V_{IO}	Input offset voltage	Distribution	1, 2, 3, 4
		vs Common-mode voltage	5, 6
α_{VIO}	Input offset voltage temperature coefficient	Distribution	7, 8, 9, 10 ⁽²⁾
I_{IB} / I_{IO}	Input bias and input offset current	vs Free-air temperature	11 ⁽²⁾
V_I	Input voltage	vs Supply voltage	12
		vs Free-air temperature	13 ⁽²⁾
V_{OH}	High-level output voltage	vs High-level output current	14 ⁽²⁾
V_{OL}	Low-level output voltage	vs Low-level output current	15, 16 ⁽²⁾
V_{OM+}	Maximum positive peak output voltage	vs Output current	17 ⁽²⁾
V_{OM-}	Maximum negative peak output voltage	vs Output current	18 ⁽²⁾
$V_{O(PP)}$	Maximum peak-to-peak output voltage	vs Frequency	19
I_{OS}	Short-circuit output current	vs Supply voltage	20
		vs Free-air temperature	21 ⁽²⁾
V_O	Output voltage	vs Differential input voltage	22, 23
A_{VD}	Large-signal differential voltage amplification	vs Load resistance	24
	Large-signal differential voltage amplification and phase margin	vs Frequency	25, 26
	Large-signal differential voltage amplification	vs Free-air temperature	27 ⁽²⁾ , 28 ⁽²⁾
Z_0	Output impedance	vs Frequency	29, 30
CMRR	Common-mode rejection ratio	vs Frequency	31
		vs Free-air temperature	32
k_{SVR}	Supply-voltage rejection ratio	vs Frequency	33, 34
		vs Free-air temperature	35 ⁽²⁾
I_{DD}	Supply current	vs Supply voltage	36 ⁽²⁾ , 37 ⁽²⁾
		vs Free-air temperature	38 ⁽²⁾ , 39 ⁽²⁾
SR	Slew rate	vs Load Capacitance	40
		vs Free-air temperature	41 ⁽²⁾
V_O	Inverting large-signal pulse response		42, 43
	Voltage-follower large-signal pulse response		44, 45
	Inverting small-signal pulse response		46, 47
	Voltage-follower small-signal pulse response		48, 49
V_n	Equivalent input noise voltage	vs Frequency	50, 51
	Noise voltage over a 10-second period		52
	Integrated noise voltage	vs Frequency	53
THD+N	Total harmonic distortion + noise	vs Frequency	54
		vs Supply voltage	55
		vs Free-air temperature	56 ⁽²⁾
ϕ_m	Phase margin	vs Load capacitance	57
	Gain margin	vs Load capacitance	58

(1) For all graphs where $V_{DD} = 5\text{ V}$, all loads are referenced to 2.5 V.

(2) Data at high and low temperatures are applicable only within the rated operating free-air temperature ranges of the various devices.

6.9 Typical Characteristics (continued)



图 6-1. Distribution of TLC2272-Q1 Input Offset Voltage



图 6-2. Distribution of TLC2272-Q1 Input Offset Voltage

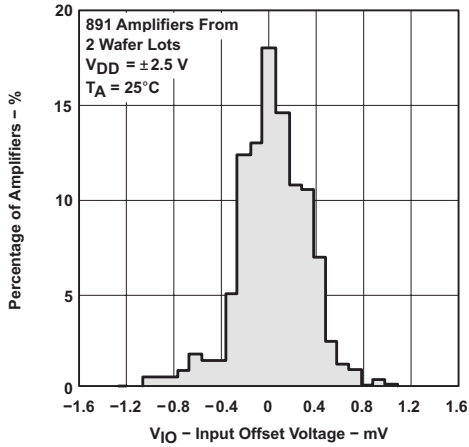

图 6-3. Distribution of TLC2274-Q1 Input Offset Voltage

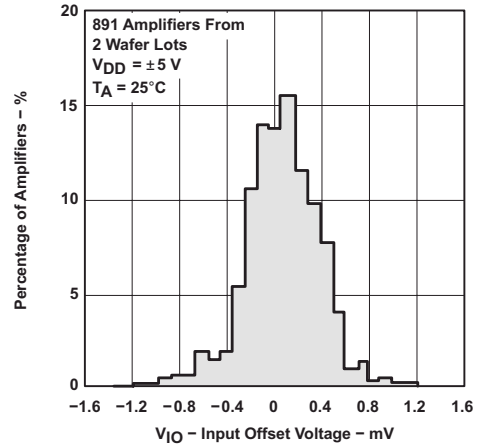

图 6-4. Distribution of TLC2274-Q1 Input Offset Voltage

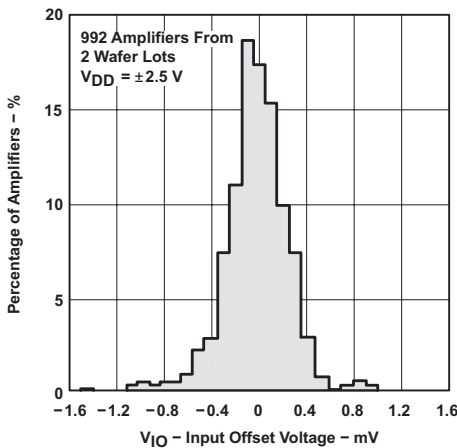

图 6-5. Input Offset Voltage vs Common-Mode Voltage

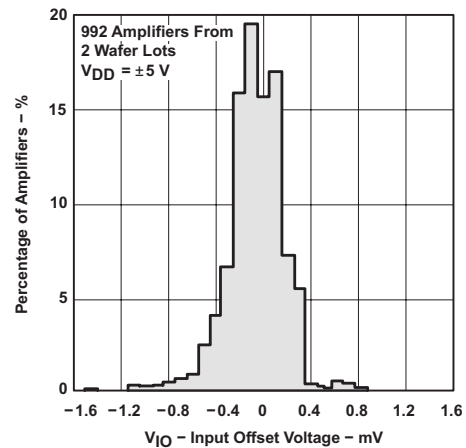

图 6-6. Input Offset Voltage vs Common-Mode Voltage

6.9 Typical Characteristics (continued)

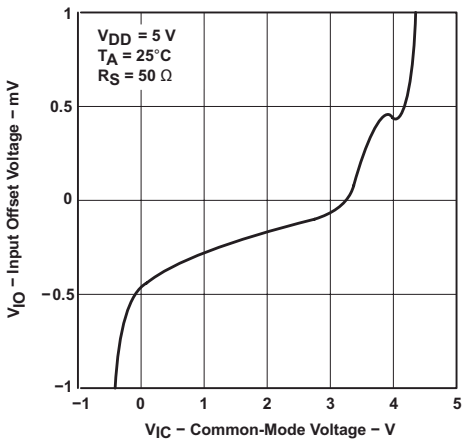

图 6-7. Distribution of TLC2272-Q1 vs Input Offset Voltage Temperature Coefficient

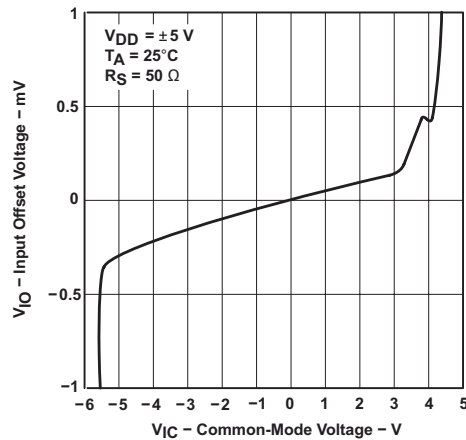

图 6-8. Distribution of TLC2272-Q1 vs Input Offset Voltage Temperature Coefficient

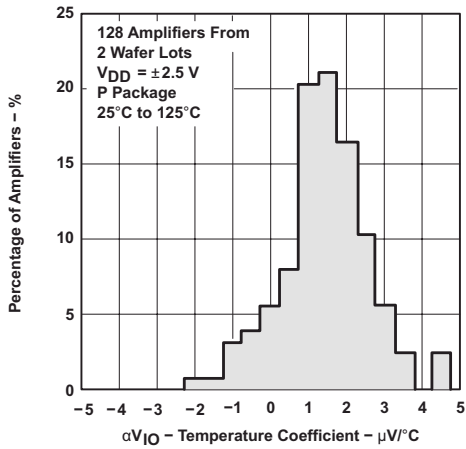

图 6-9. Distribution of TLC2274-Q1 vs Input Offset Voltage Temperature Coefficient

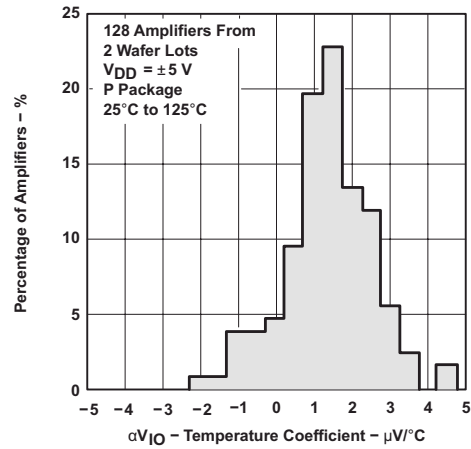

图 6-10. Distribution of TLC2274-Q1 vs Input Offset Voltage Temperature Coefficient

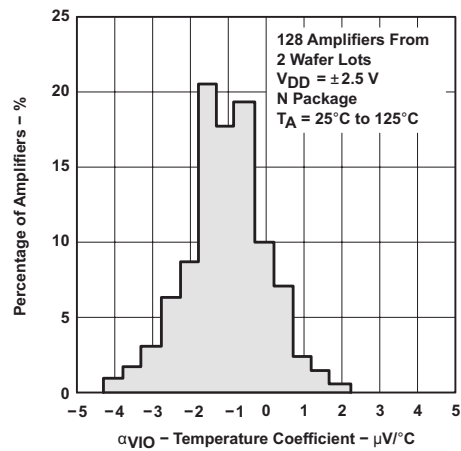

图 6-11. Input Bias and Input Offset Current vs Free-Air Temperature

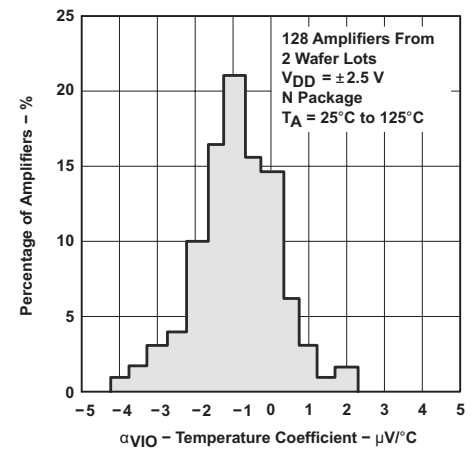

图 6-12. Input Voltage vs Supply Voltage

6.9 Typical Characteristics (continued)

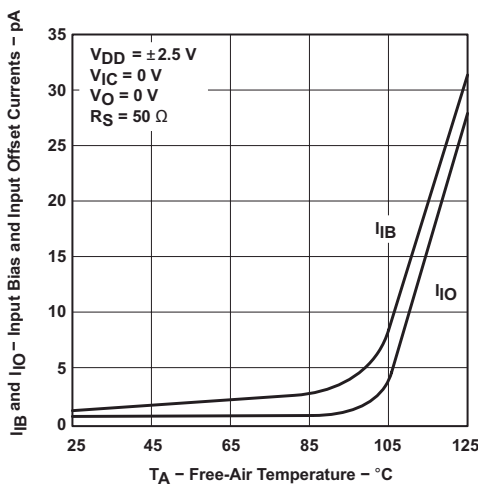

图 6-13. Input Voltage vs Free-Air Temperature

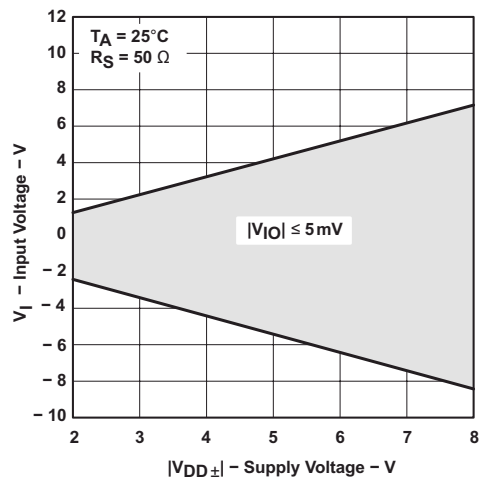

图 6-14. High-Level Output Voltage vs High-Level Output Current

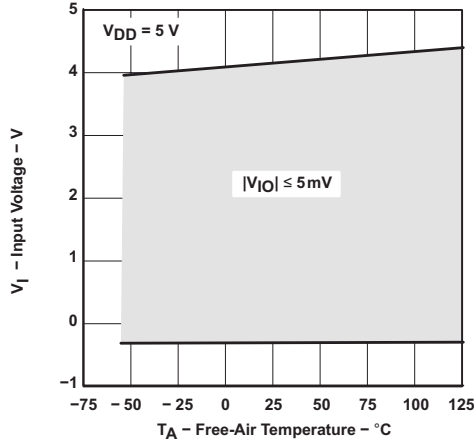

图 6-15. Low-Level Output Voltage vs Low-Level Output Current

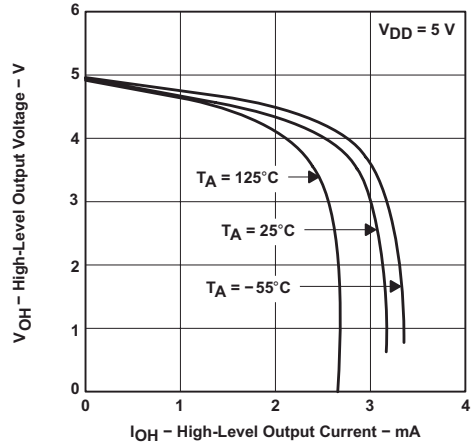

图 6-16. Low-Level Output Voltage vs Low-Level Output Current

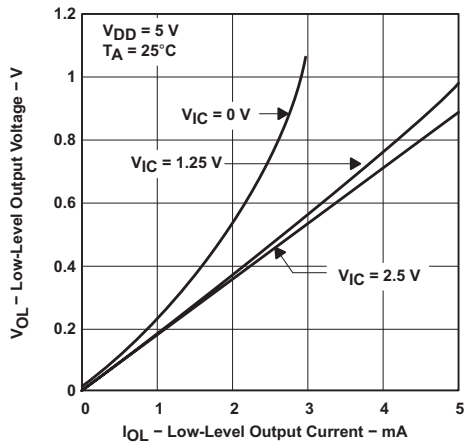

图 6-17. Maximum Positive Peak Output Voltage vs Output Current

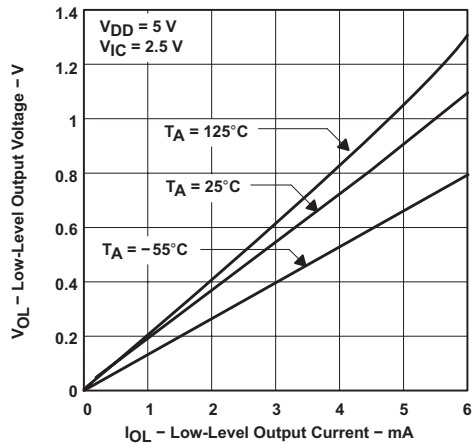

图 6-18. Maximum Positive Peak Output Voltage vs Output Current

6.9 Typical Characteristics (continued)

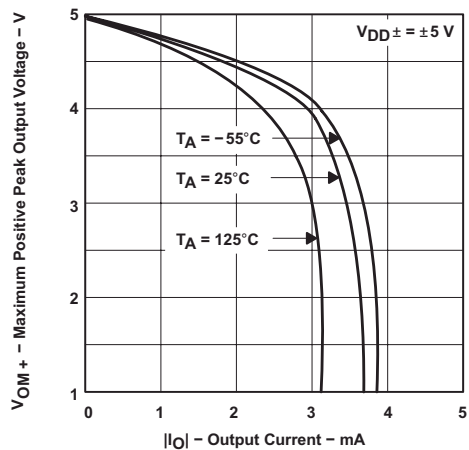

图 6-19. Maximum Peak-to-Peak Output Voltage vs Frequency

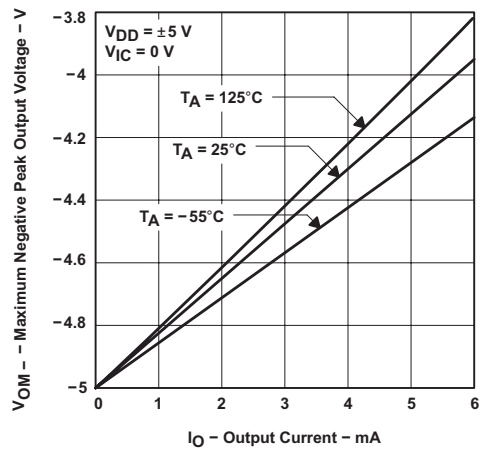

图 6-20. Short-Circuit Output Current vs Supply Voltage

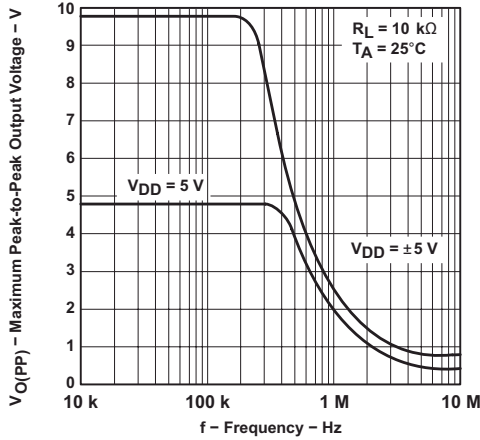

图 6-21. Short-Circuit Output Current vs Free-Air Temperature

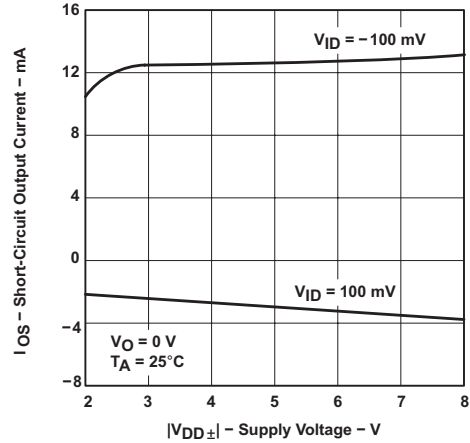

图 6-22. Output Voltage vs Differential Input Voltage

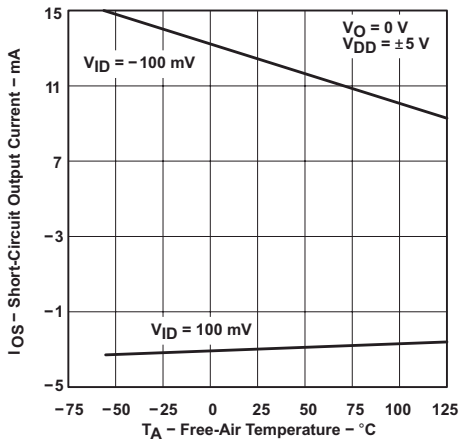

图 6-23. Output Voltage vs Differential Input Voltage

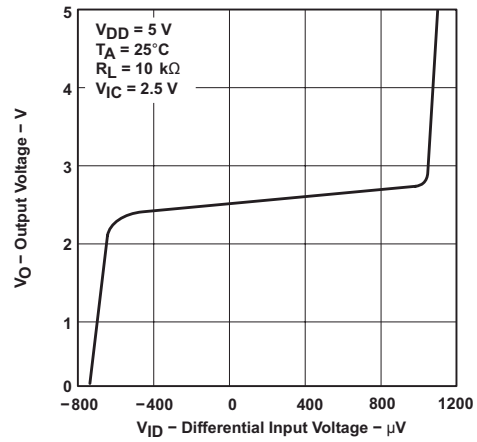

图 6-24. Large-Signal Differential Voltage Amplification vs Load Resistance

6.9 Typical Characteristics (continued)

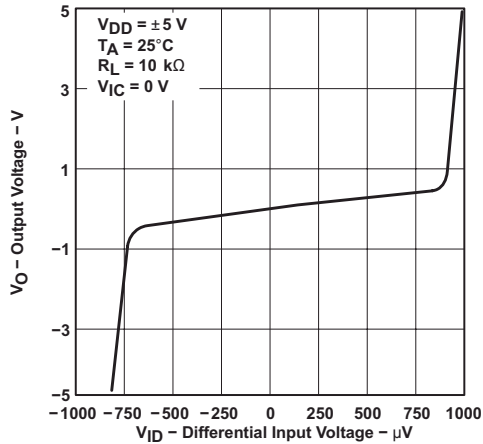

图 6-25. Large-Signal Differential Voltage Amplification and Phase Margin vs Frequency

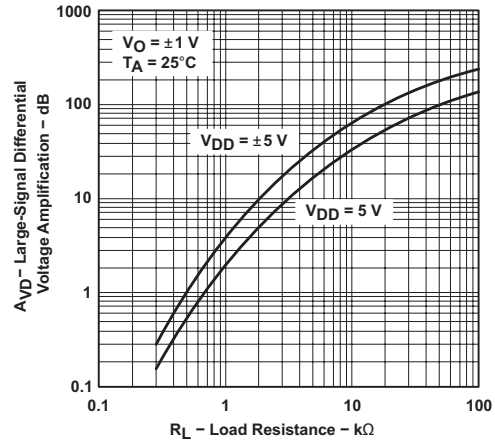

图 6-26. Large-Signal Differential Voltage Amplification and Phase Margin vs Frequency

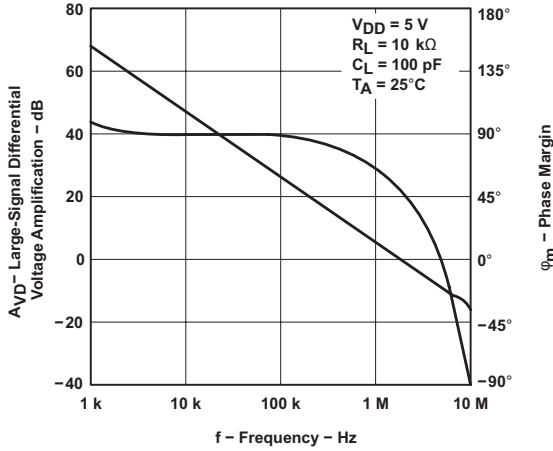

图 6-27. Large-Signal Differential Voltage Amplification vs Free-Air Temperature

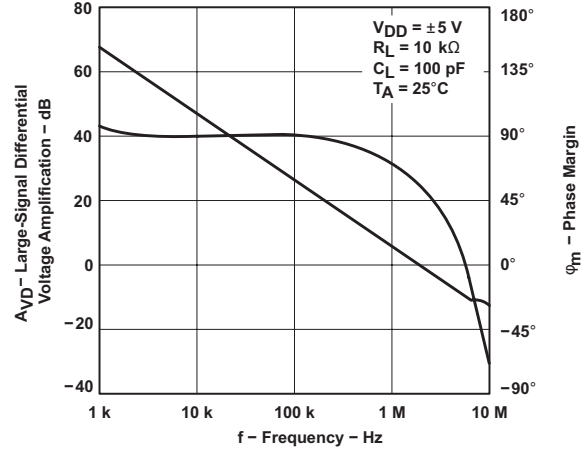

图 6-28. Large-Signal Differential Voltage Amplification vs Free-Air Temperature

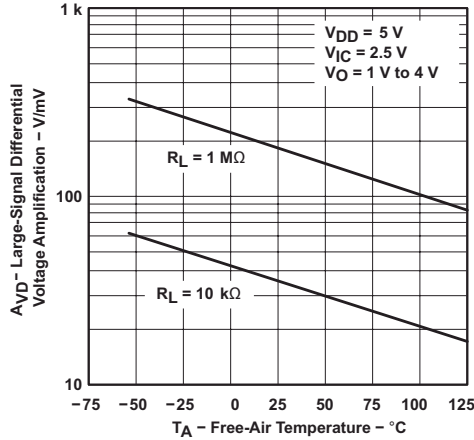

图 6-29. Output Impedance vs Frequency

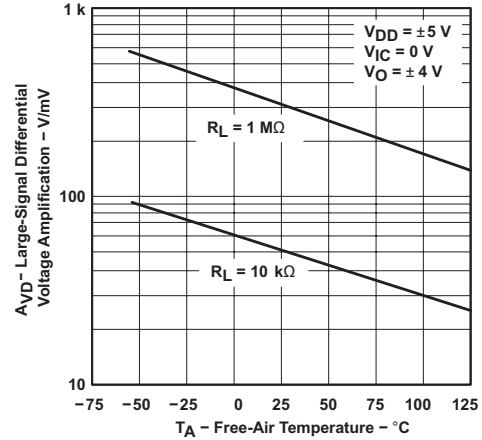

图 6-30. Output Impedance vs Frequency

6.9 Typical Characteristics (continued)

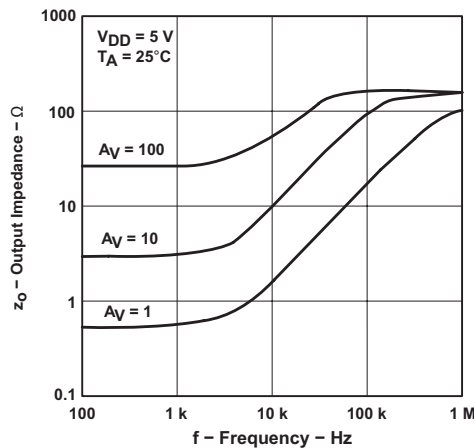

图 6-31. Common-Mode Rejection Ratio vs Frequency

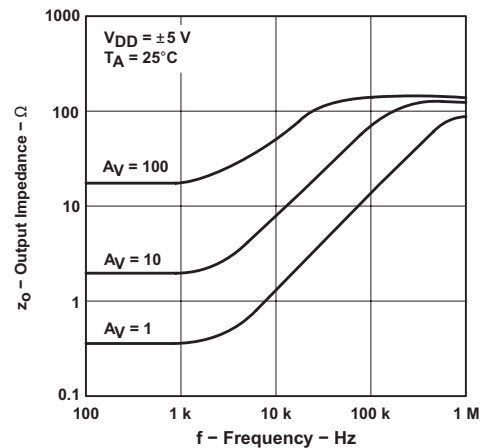

图 6-32. Common-Mode Rejection Ratio vs Free-Air Temperature

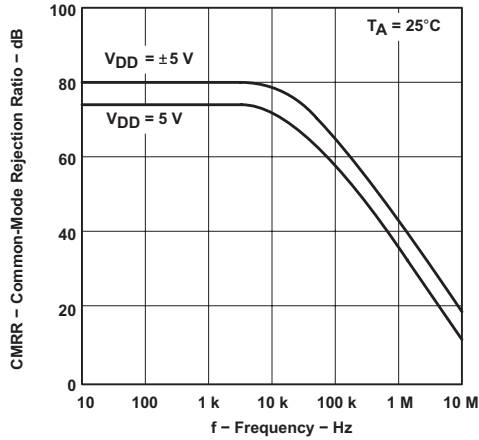

图 6-33. Supply-Voltage Rejection Ratio vs Frequency

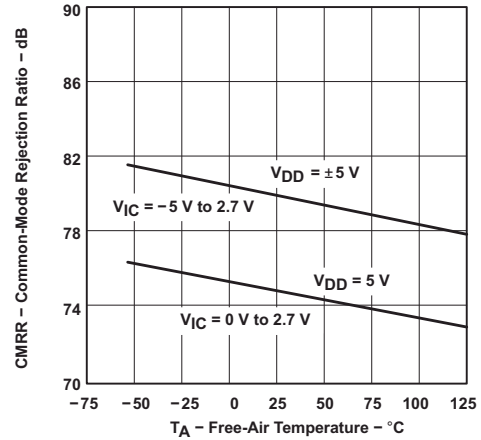

图 6-34. Supply-Voltage Rejection Ratio vs Frequency

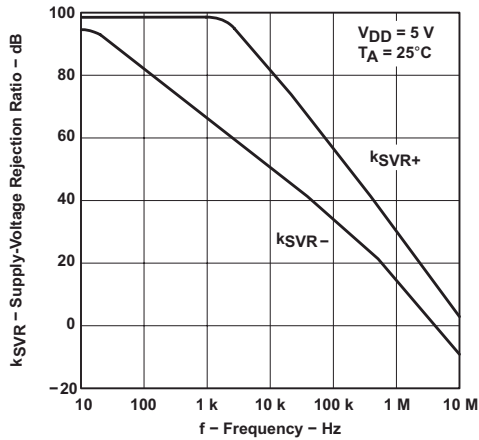

图 6-35. Supply-Voltage Rejection Ratio vs Free-Air Temperature

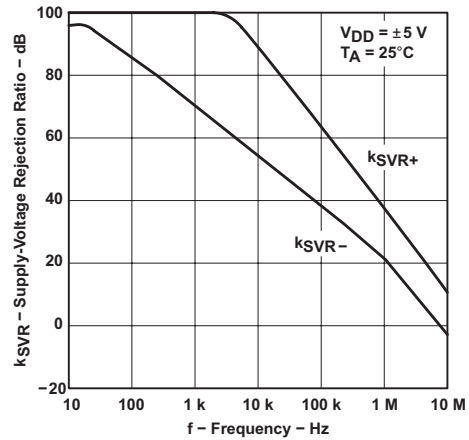

图 6-36. TLC2272-Q1 Supply Current vs Supply Voltage

6.9 Typical Characteristics (continued)

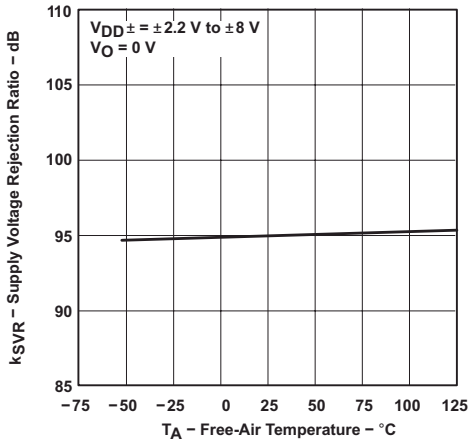

图 6-37. TLC2274-Q1 Supply Current vs Supply Voltage

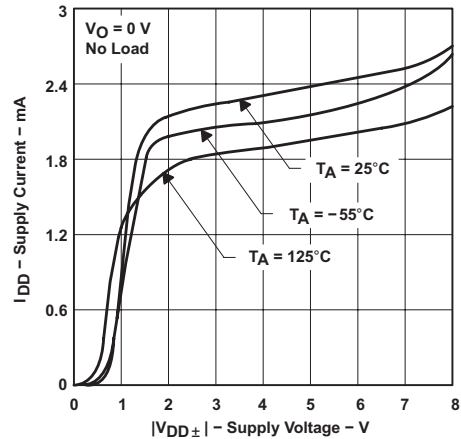

图 6-38. TLC2272-Q1 Supply Current vs Free-Air Temperature

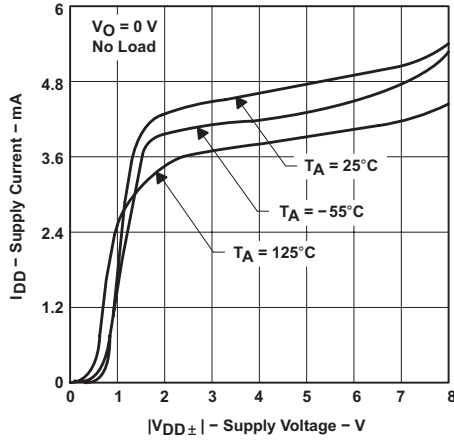

图 6-39. TLC2274-Q1 Supply Current vs Free-Air Temperature

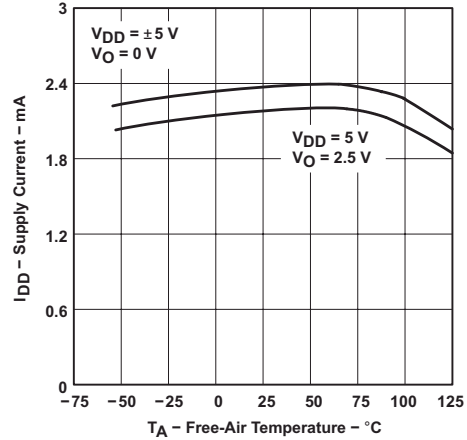

图 6-40. Slew Rate vs Load Capacitance

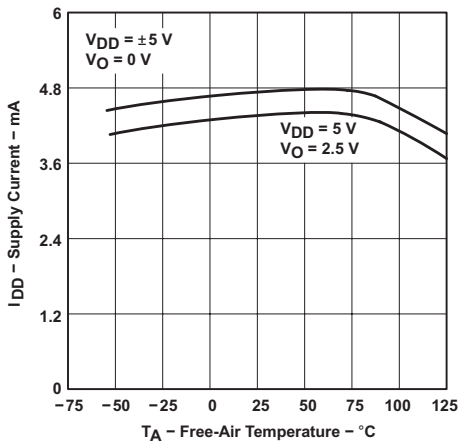

图 6-41. Slew Rate vs Free-Air Temperature

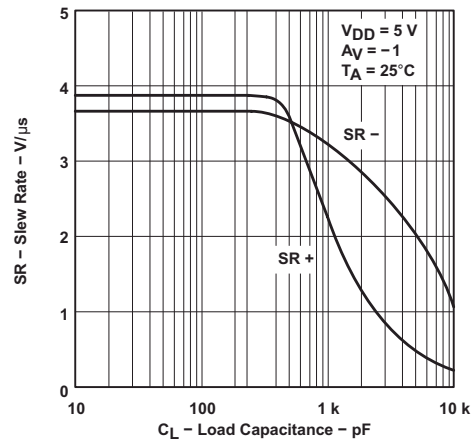

图 6-42. Inverting Large-Signal Pulse Response

6.9 Typical Characteristics (continued)

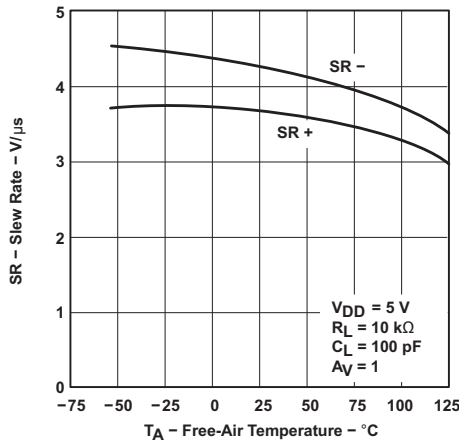

图 6-43. Inverting Large-Signal Pulse Response

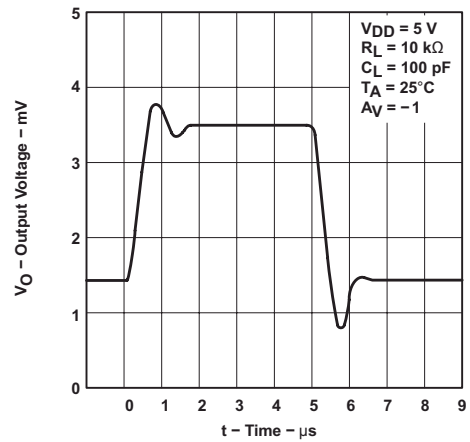

图 6-44. Voltage-Follower Large-Signal Pulse Response

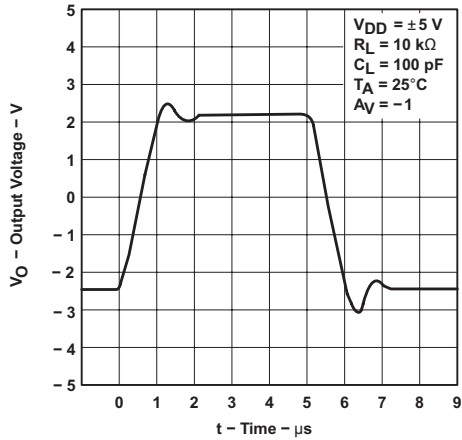

图 6-45. Voltage-Follower Large-Signal Pulse Response

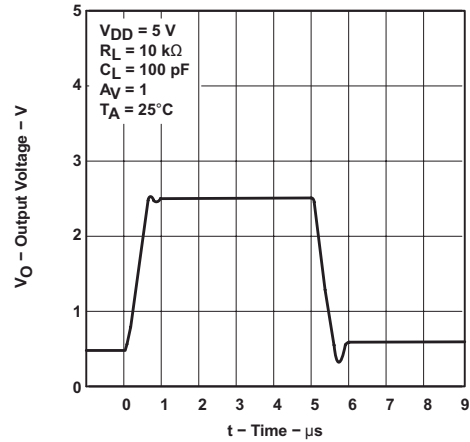

图 6-46. Inverting Small-Signal Pulse Response

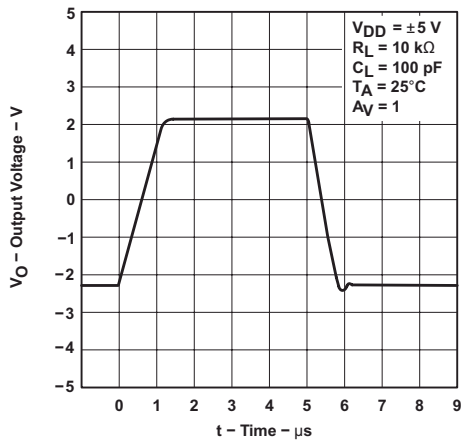

图 6-47. Inverting Small-Signal Pulse Response

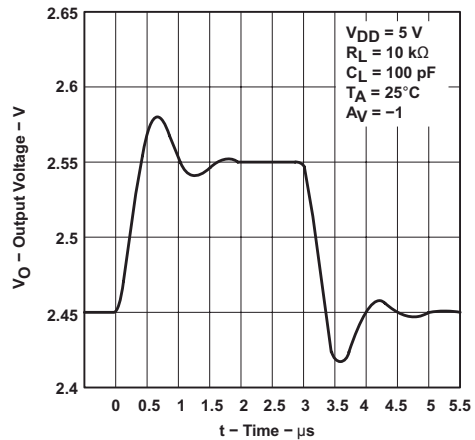

图 6-48. Voltage-Follower Small-Signal Pulse Response

6.9 Typical Characteristics (continued)

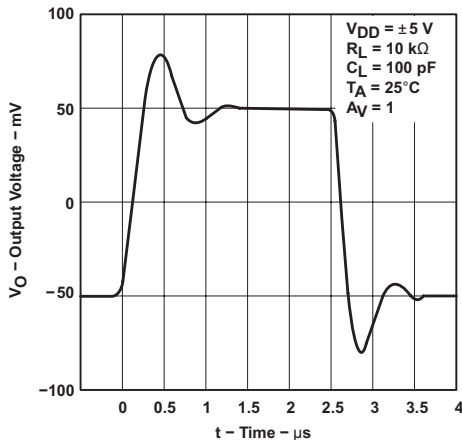

图 6-49. Voltage-Follower Small-Signal Pulse Response

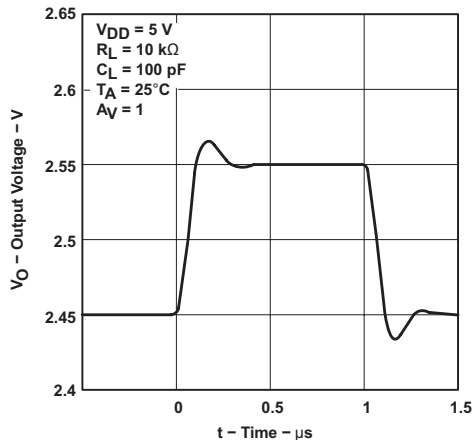

图 6-50. Equivalent Input Noise Voltage vs Frequency

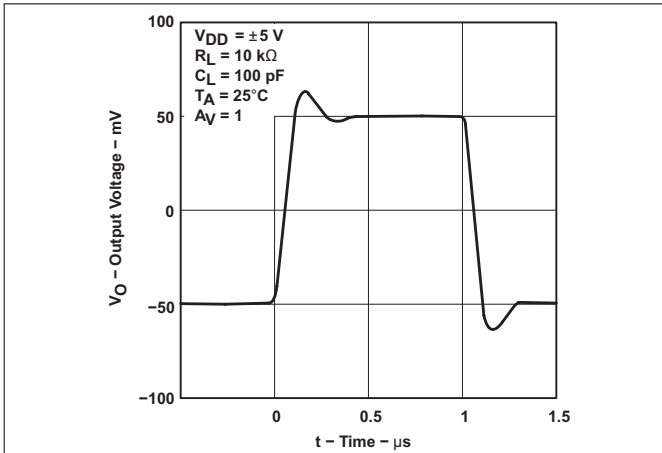

图 6-51. Equivalent Input Noise Voltage vs Frequency

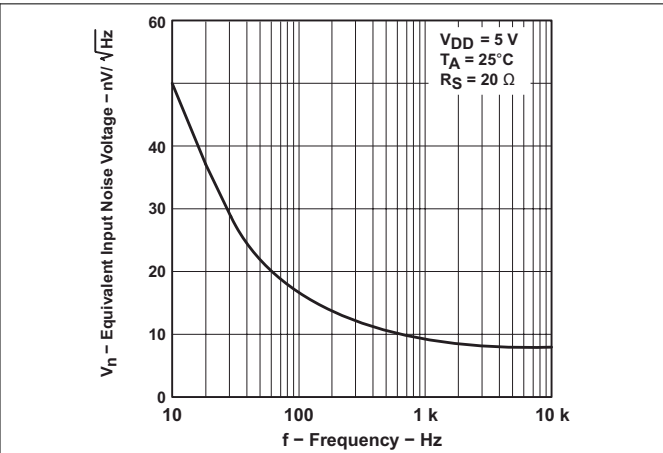

图 6-52. Noise Voltage Over a 10 Second Period

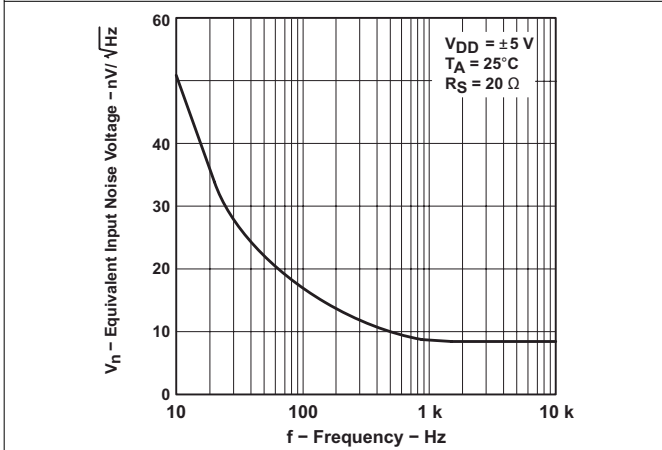

图 6-53. Integrated Noise Voltage vs Frequency

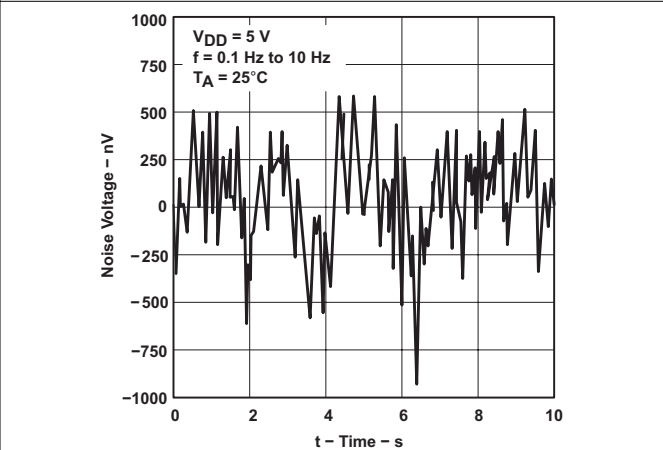

图 6-54. Total Harmonic Distortion + Noise vs Frequency

6.9 Typical Characteristics (continued)

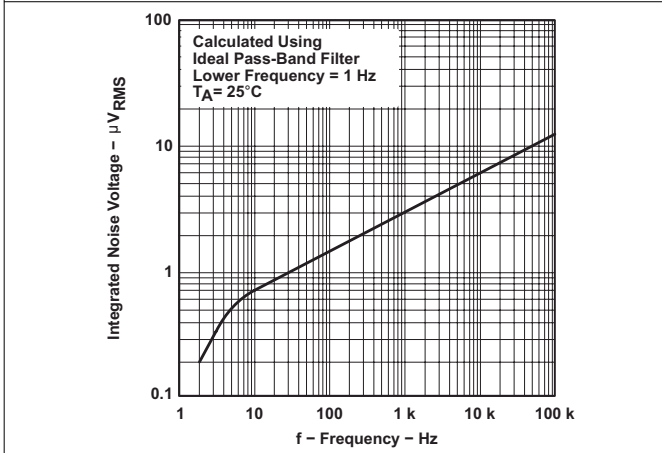

图 6-55. Gain-Bandwidth Product vs Supply Voltage

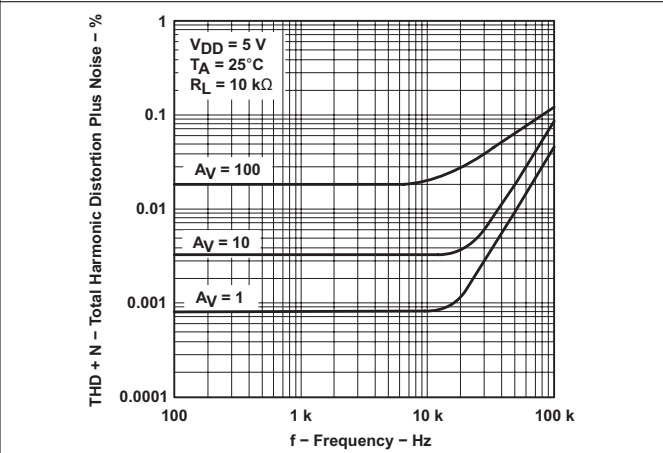

图 6-56. Gain-Bandwidth Product vs Free-Air Temperature

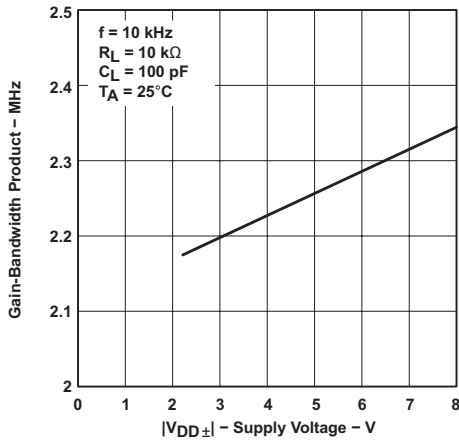

图 6-57. Phase Margin vs Load Capacitance

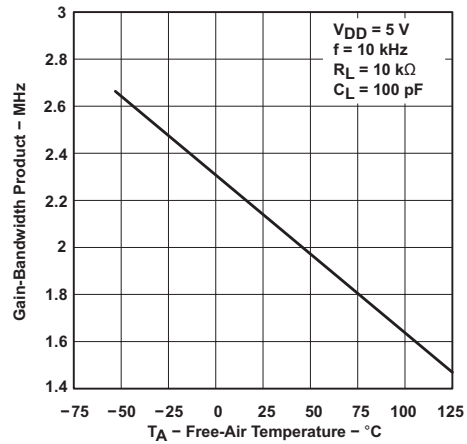

图 6-58. Gain Margin vs Load Capacitance

7 Detailed Description

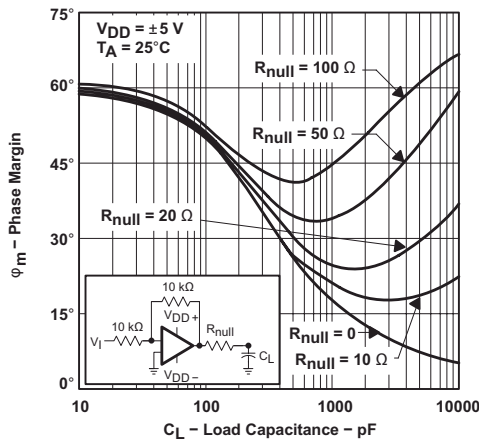
7.1 Overview

The TLC227x-Q1 devices are a rail-to-rail output operational amplifiers. These devices operate from a 4.4-V to 16-V single supply and a ± 2.2 -V ± 8 -V dual supply, are unity-gain stable, and are an excellent choice for a wide range of general-purpose applications.

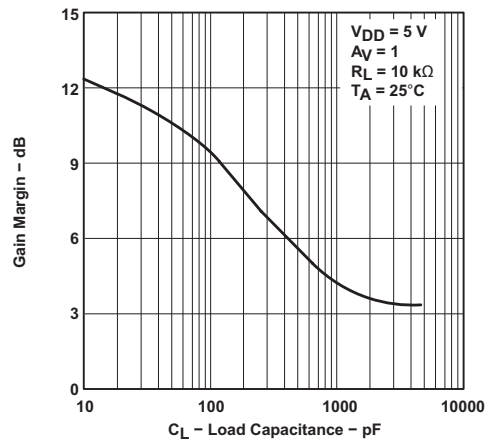
7.2 Functional Block Diagram



表 7-1. Actual Device Component Count⁽¹⁾

COMPONENT	TLC2272-Q1	TLC2274-Q1
Transistors	38	76
Resistors	26	52
Diodes	9	18
Capacitors	3	6

(1) Includes both amplifiers and all ESD, bias, and trim circuitry.

7.3 Feature Description

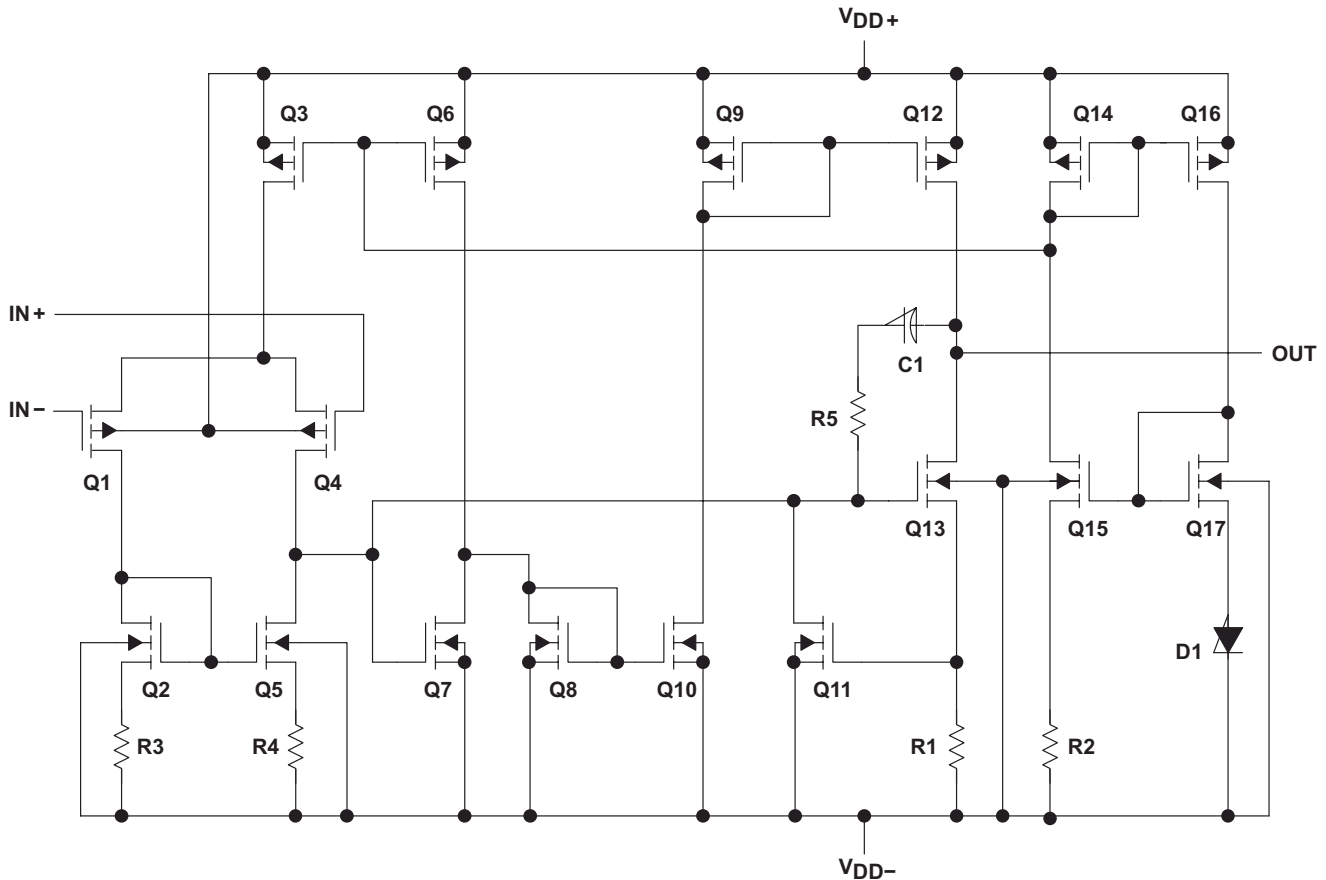
The TLC227x-Q1 family features 2-MHz bandwidth and voltage noise of $9 \text{ nV} / \sqrt{\text{Hz}}$ with performance rated from 4.4 V to 16 V across an automotive temperature range (-40°C to $+125^{\circ}\text{C}$). LinMOS is a great choice for a wide range of audio, automotive, industrial, and instrumentation applications.

7.4 Device Functional Modes

The TLC227x-Q1 family of devices is powered on when the supply is connected. The device can operate with single or dual supply, depending on the application. The device is in full performance after the supply is greater than the recommended value.

8 Application and Implementation

备注

以下应用部分中的信息不属于 TI 器件规格的范围，TI 不担保其准确性和完整性。TI 的客户应负责确定器件是否适用于其应用。客户应验证并测试其设计，以确保系统功能。

8.1 Application Information

8.1.1 Macromodel Information

Macromodel information provided was derived using MicroSim Parts, the model generation software used with PSpice®. The Boyle macromodel (see also [# 9.2.1](#)) and subcircuit in [图 8-1](#) were generated using the TLC227x typical electrical and operating characteristics at $T_A = 25^\circ\text{C}$. Using this information, output simulations of the following key parameters can be generated to a tolerance of 20% (in most cases):

- Maximum positive output voltage swing
- Maximum negative output voltage swing
- Slew rate
- Quiescent power dissipation
- Input bias current
- Open-loop voltage amplification
- Unity gain frequency
- Common-mode rejection ratio
- Phase margin
- DC output resistance
- AC output resistance
- Short-circuit output current limit



图 8-1. Boyle Macromodels and Subcircuit

8.2 Typical Application

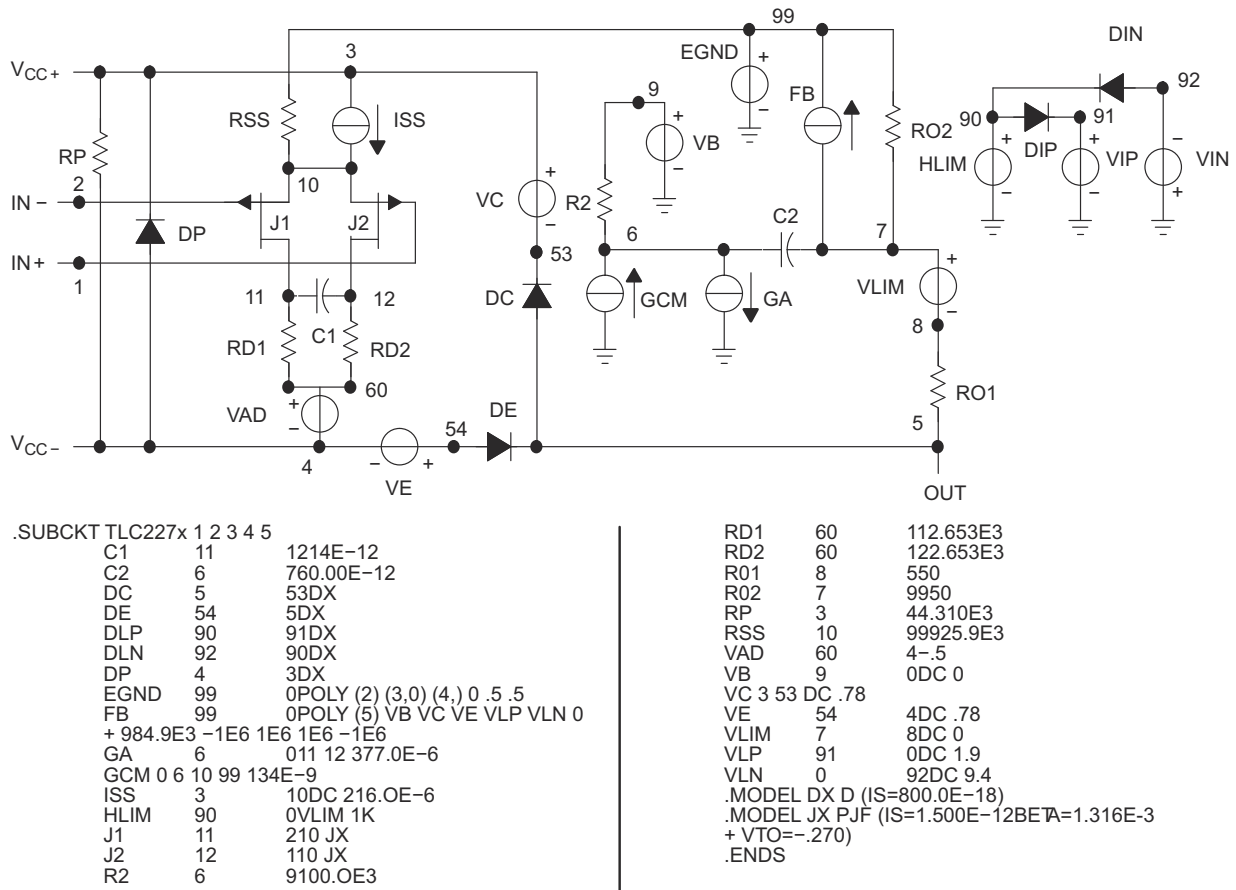

图 8-2. High-Side Current Monitor Equivalent Schematic (Each Amplifier)

8.2.1 Design Requirements

For this design example, use these parameters listed in 表 8-1 as the input parameters.

表 8-1. Design Parameters

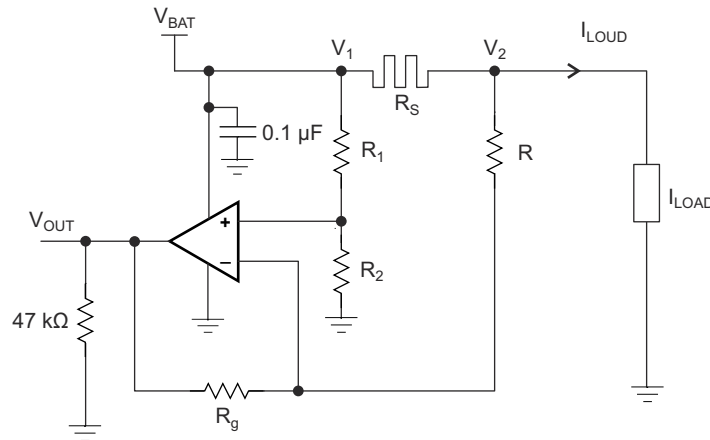
PARAMETER		VALUE
V _{BAT}	Battery voltage	12 V
R _{SENSE}	Sense resistor	0.1 Ω
I _{LOAD}	Load current	0 A to 10 A
	Operational amplifier	Set in differential configuration with gain = 10

8.2.2 Detailed Design Procedure

This circuit is designed for measuring the high-side current in automotive body control modules with a 12-V battery or similar applications. The operational amplifier is set as differential with an external resistor network.

8.2.2.1 Differential Amplifier Equations

方程式 1 和 方程式 2 are used to calculate V_{OUT}.

$$V_{OUT} = \frac{R_g}{R} \left(\frac{\frac{R}{R_g} - \frac{R_1}{R_2}}{1 + \frac{R_1}{R_2}} \times \frac{V_1 + V_2}{2} + \frac{1 + \frac{1}{2} \left(\frac{R_1 + R}{R_2 + R_g} \right)}{1 + \frac{R_1}{R_2}} (V_1 - V_2) \right) \quad (1)$$

$$V_{OUT} = \frac{R_g}{R} \left(\frac{\frac{R}{R_g} - \frac{R_1}{R_2}}{1 + \frac{R_1}{R_2}} \times V_{BAT} + \frac{1 + \frac{1}{2} \left(\frac{R_1 + R}{R_2 + R_g} \right)}{1 + \frac{R_1}{R_2}} \times R_S \times I_{LOAD} \right) \quad (2)$$

In an ideal case, 方程式 3 then calculates R₁ = R and R₂ = R_g, and V_{OUT}:

$$V_{OUT} = \frac{R_g}{R} \times R_S \times I_{LOAD} \quad (3)$$

However, the resistors have tolerances; therefore, the resistors cannot be perfectly matched.

$$R_1 = R \pm \Delta R_1$$

$$R_2 = R_2 \pm \Delta R_2$$

$$R = R \pm \Delta R$$

$$R_g = R_g \pm \Delta R_g$$

$$\text{Tol} = \frac{\Delta R}{R} \tag{4}$$

方程式 5 shows that by developing the equations and neglecting the second order, the worst case is when the tolerances add up:

$$V_{\text{OUT}} = \pm (4 \text{ Tol}) \frac{R_g}{R + R_g} \times V_{\text{BAT}} + \left(1 \pm 2 \text{ Tol} \left(1 + \frac{2R}{R + R_g} \right) \right) \frac{R_g}{R} \times R_S \times I_{\text{LOAD}} \tag{5}$$

where

- Tol = 0.01 for 1%
- Tol = 0.001 for 0.1%

If the resistors are perfectly matched, then Tol = 0 and 方程式 6 calculates V_{OUT} :

$$V_{\text{OUT}} = \frac{R_g}{R} \times R_S \times I_{\text{LOAD}} \tag{6}$$

The highest error is from the common mode:

$$4 (\text{Tol}) \frac{R_g}{R + R_g} \times V_{\text{BAT}} \tag{7}$$

Gain of 10, $R_g / R = 10$, and Tol = 1%:

$$\text{Common mode error} = ((4 \times 0.01) / 1.1) \times 12 \text{ V} = 0.436 \text{ V}$$

Gain of 10 and Tol = 0.1%:

$$\text{Common mode error} = 43.6 \text{ mV}$$

The resistors were chosen from 2% batches.

R_1 and R 12 k Ω

R_2 and R_g 120 k Ω

$$\text{Ideal Gain} = 120 / 12 = 10$$

The measured value of the resistors:

$$R_1 = 11.835 \text{ k}\Omega$$

$$R = 11.85 \text{ k}\Omega$$

$$R_2 = 117.92 \text{ k}\Omega$$

$$R_g = 118.07 \text{ k}\Omega$$

8.2.3 Application Curves



图 8-3. Output Voltage Measured vs Ideal (0 A to 1 A)



图 8-4. Output Voltage Measured vs Ideal (0 A to 10 A)

8.3 Power Supply Recommendations

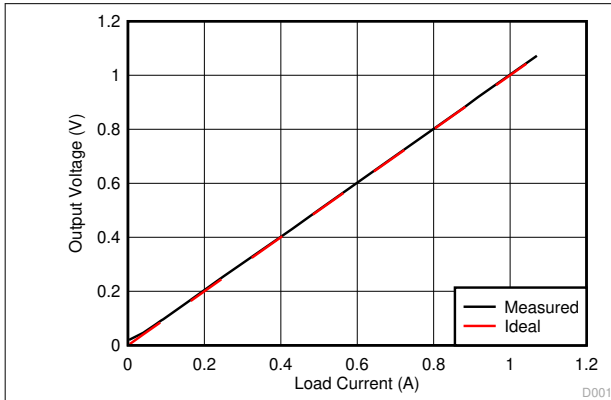
Supply voltage is 4.4 V to 16 V for single supply and ± 2.2 V to ± 8 V for dual. In the high-side sensing application, the supply is connected to a 12-V battery.

8.4 Layout

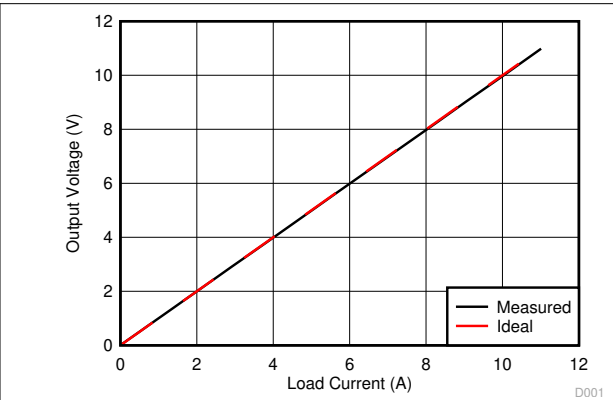
8.4.1 Layout Guidelines

The TLC227x-Q1 is a wideband amplifier. To realize the full operational performance of the device, good high frequency printed-circuit-board (PCB) layout practices are required. Low-loss 0.1- μ F bypass capacitors must be connected between each supply pin and ground as close to the device as possible. The bypass capacitor traces must be designed for minimum inductance.

8.4.2 Layout Example



图 8-5. Schematic Representation



图 8-6. Operational Amplifier Board Layout for Noninverting Configuration

9 Device and Documentation Support

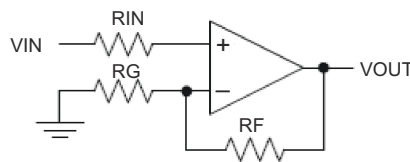
9.1 Device Support

9.1.1 Development Support

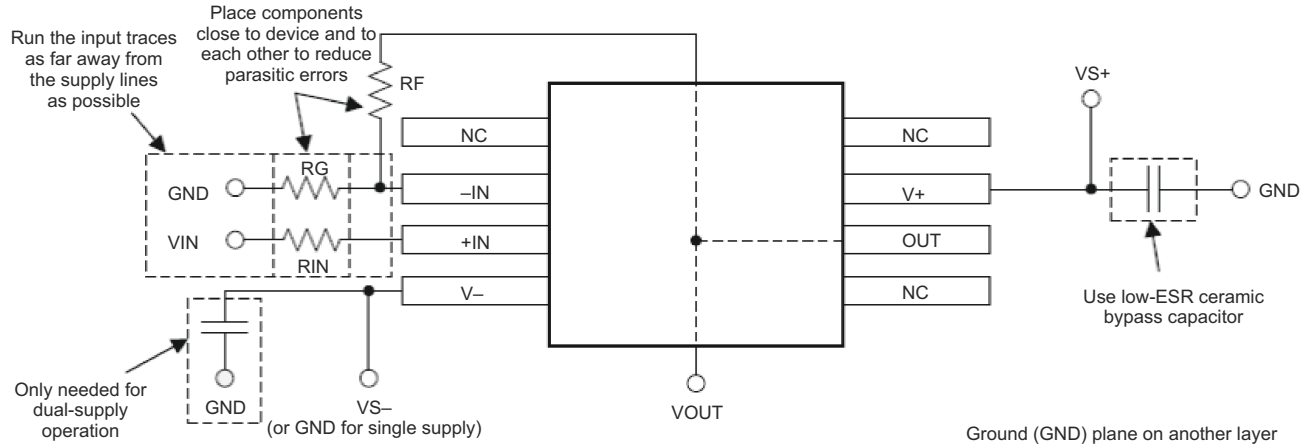
9.1.1.1 PSpice® for TI

PSpice® for TI 是可帮助评估模拟电路性能的设计和仿真环境。在进行布局和制造之前创建子系统设计和原型解决方案，可降低开发成本并缩短上市时间。

9.1.1.2 TINA-TI™ Simulation Software (Free Download)

TINA-TI™ simulation software is a simple, powerful, and easy-to-use circuit simulation program based on a SPICE engine. TINA-TI simulation software is a free, fully-functional version of the TINA™ software, preloaded with a library of macromodels, in addition to a range of both passive and active models. TINA-TI simulation software provides all the conventional dc, transient, and frequency domain analysis of SPICE, as well as additional design capabilities.

Available as a [free download](#) from the [Design tools and simulation](#) web page, TINA-TI simulation software offers extensive post-processing capability that allows users to format results in a variety of ways. Virtual instruments offer the ability to select input waveforms and probe circuit nodes, voltages, and waveforms, creating a dynamic quick-start tool.

备注

These files require that either the TINA software or TINA-TI software be installed. Download the free TINA-TI simulation software from the [TINA-TI™ software folder](#).

9.2 Documentation Support

9.2.1 Related Documentation

For related documentation see the following:

- G.R. Boyle, D.O. Pederson, B.M. Cohn, J.E. Solomon (Dec. 1974). *Macromodeling of Integrated Circuit Operational Amplifiers*. IEEE Journal of Solid-State Circuits, Volume 9, Issue 6, pages 353 – 364. Retrieved from <https://ieeexplore.ieee.org/document/1050528>

9.3 接收文档更新通知

要接收文档更新通知，请导航至 [ti.com](https://www.ti.com) 上的器件产品文件夹。点击 [订阅更新](#) 进行注册，即可每周接收产品信息更改摘要。有关更改的详细信息，请查看任何已修订文档中包含的修订历史记录。

9.4 支持资源

[TI E2E™ 支持论坛](#) 是工程师的重要参考资料，可直接从专家获得快速、经过验证的解答和设计帮助。搜索现有解答或提出自己的问题可获得所需的快速设计帮助。

链接的内容由各个贡献者“按原样”提供。这些内容并不构成 TI 技术规范，并且不一定反映 TI 的观点；请参阅 TI 的 [《使用条款》](#)。

9.5 Trademarks

LinCMOS™, TINA-TI™, and TI E2E™ are trademarks of Texas Instruments.

TINA™ is a trademark of DesignSoft, Inc.

PSpice® is a registered trademark of Cadence Design Systems, Inc.

所有商标均为其各自所有者的财产。

9.6 Electrostatic Discharge Caution



This integrated circuit can be damaged by ESD. Texas Instruments recommends that all integrated circuits be handled with appropriate precautions. Failure to observe proper handling and installation procedures can cause damage.

ESD damage can range from subtle performance degradation to complete device failure. Precision integrated circuits may be more susceptible to damage because very small parametric changes could cause the device not to meet its published specifications.

9.7 术语表

[TI 术语表](#) 本术语表列出并解释了术语、首字母缩略词和定义。

10 Mechanical, Packaging, and Orderable Information

The following pages include mechanical, packaging, and orderable information. This information is the most current data available for the designated devices. This data is subject to change without notice and revision of this document. For browser-based versions of this data sheet, refer to the left-hand navigation.

PACKAGING INFORMATION

Orderable Device	Status (1)	Package Type	Package Drawing	Pins	Package Qty	Eco Plan (2)	Lead finish/ Ball material (6)	MSL Peak Temp (3)	Op Temp (°C)	Device Marking (4/5)	Samples
TLC2272AQDRG4Q1	ACTIVE	SOIC	D	8	2500	RoHS & Green	NIPDAU	Level-1-260C-UNLIM	-40 to 125	2272AQ	Samples
TLC2272AQDRQ1	ACTIVE	SOIC	D	8	2500	RoHS & Green	NIPDAU	Level-1-260C-UNLIM	-40 to 125	2272AQ	Samples
TLC2272AQPWRG4Q1	ACTIVE	TSSOP	PW	8	2000	RoHS & Green	NIPDAU	Level-1-260C-UNLIM	-40 to 125	2272AQ	Samples
TLC2272AQPWRQ1	ACTIVE	TSSOP	PW	8	2000	RoHS & Green	NIPDAU	Level-1-260C-UNLIM	-40 to 125	2272AQ	Samples
TLC2272QDRG4Q1	ACTIVE	SOIC	D	8	2500	RoHS & Green	NIPDAU	Level-1-260C-UNLIM	-40 to 125	2272Q1	Samples
TLC2272QDRQ1	ACTIVE	SOIC	D	8	2500	RoHS & Green	NIPDAU	Level-1-260C-UNLIM	-40 to 125	2272Q1	Samples
TLC2272QPWRG4Q1	ACTIVE	TSSOP	PW	8	2000	RoHS & Green	NIPDAU	Level-1-260C-UNLIM	-40 to 125	2272Q1	Samples
TLC2272QPWRQ1	ACTIVE	TSSOP	PW	8	2000	RoHS & Green	NIPDAU	Level-1-260C-UNLIM	-40 to 125	2272Q1	Samples
TLC2274AQDRG4Q1	ACTIVE	SOIC	D	14	2500	RoHS & Green	NIPDAU	Level-1-260C-UNLIM	-40 to 125	2274AQ1	Samples
TLC2274AQDRQ1	ACTIVE	SOIC	D	14	2500	RoHS & Green	NIPDAU	Level-1-260C-UNLIM	-40 to 125	2274AQ1	Samples
TLC2274AQPWRG4Q1	ACTIVE	TSSOP	PW	14	2000	RoHS & Green	NIPDAU	Level-1-260C-UNLIM	-40 to 125	2274AQ1	Samples
TLC2274AQPWRQ1	ACTIVE	TSSOP	PW	14	2000	RoHS & Green	NIPDAU	Level-1-260C-UNLIM	-40 to 125	2274AQ1	Samples
TLC2274QDRG4Q1	OBSOLETE	SOIC	D	14		TBD	Call TI	Call TI	-40 to 125	2274Q1	
TLC2274QDRQ1	OBSOLETE	SOIC	D	14		TBD	Call TI	Call TI	-40 to 125	2274Q1	
TLC2274QPWRG4Q1	OBSOLETE	TSSOP	PW	14		TBD	Call TI	Call TI	-40 to 125	2274Q1	
TLC2274QPWRQ1	ACTIVE	TSSOP	PW	14	2000	RoHS & Green	NIPDAU	Level-1-260C-UNLIM	-40 to 125	2274Q1	Samples

(1) The marketing status values are defined as follows:

ACTIVE: Product device recommended for new designs.

LIFEBUY: TI has announced that the device will be discontinued, and a lifetime-buy period is in effect.

NRND: Not recommended for new designs. Device is in production to support existing customers, but TI does not recommend using this part in a new design.

PREVIEW: Device has been announced but is not in production. Samples may or may not be available.

OBSOLETE: TI has discontinued the production of the device.

(2) **RoHS:** TI defines "RoHS" to mean semiconductor products that are compliant with the current EU RoHS requirements for all 10 RoHS substances, including the requirement that RoHS substance do not exceed 0.1% by weight in homogeneous materials. Where designed to be soldered at high temperatures, "RoHS" products are suitable for use in specified lead-free processes. TI may reference these types of products as "Pb-Free".

RoHS Exempt: TI defines "RoHS Exempt" to mean products that contain lead but are compliant with EU RoHS pursuant to a specific EU RoHS exemption.

Green: TI defines "Green" to mean the content of Chlorine (Cl) and Bromine (Br) based flame retardants meet JS709B low halogen requirements of ≤ 1000 ppm threshold. Antimony trioxide based flame retardants must also meet the ≤ 1000 ppm threshold requirement.

(3) MSL, Peak Temp. - The Moisture Sensitivity Level rating according to the JEDEC industry standard classifications, and peak solder temperature.

(4) There may be additional marking, which relates to the logo, the lot trace code information, or the environmental category on the device.

(5) Multiple Device Markings will be inside parentheses. Only one Device Marking contained in parentheses and separated by a "~" will appear on a device. If a line is indented then it is a continuation of the previous line and the two combined represent the entire Device Marking for that device.

(6) Lead finish/Ball material - Orderable Devices may have multiple material finish options. Finish options are separated by a vertical ruled line. Lead finish/Ball material values may wrap to two lines if the finish value exceeds the maximum column width.

Important Information and Disclaimer:The information provided on this page represents TI's knowledge and belief as of the date that it is provided. TI bases its knowledge and belief on information provided by third parties, and makes no representation or warranty as to the accuracy of such information. Efforts are underway to better integrate information from third parties. TI has taken and continues to take reasonable steps to provide representative and accurate information but may not have conducted destructive testing or chemical analysis on incoming materials and chemicals. TI and TI suppliers consider certain information to be proprietary, and thus CAS numbers and other limited information may not be available for release.

In no event shall TI's liability arising out of such information exceed the total purchase price of the TI part(s) at issue in this document sold by TI to Customer on an annual basis.

OTHER QUALIFIED VERSIONS OF TLC2272-Q1, TLC2272A-Q1, TLC2274-Q1, TLC2274A-Q1 :

- Catalog : [TLC2272](#), [TLC2272A](#), [TLC2274](#), [TLC2274A](#)
- Enhanced Product : [TLC2272A-EP](#), [TLC2274-EP](#), [TLC2274A-EP](#)
- Military : [TLC2272M](#), [TLC2272AM](#), [TLC2274M](#), [TLC2274AM](#)

NOTE: Qualified Version Definitions:

- Catalog - TI's standard catalog product
- Enhanced Product - Supports Defense, Aerospace and Medical Applications

- Military - QML certified for Military and Defense Applications

TAPE AND REEL INFORMATION

QUADRANT ASSIGNMENTS FOR PIN 1 ORIENTATION IN TAPE

*All dimensions are nominal

Device	Package Type	Package Drawing	Pins	SPQ	Reel Diameter (mm)	Reel Width W1 (mm)	A0 (mm)	B0 (mm)	K0 (mm)	P1 (mm)	W (mm)	Pin1 Quadrant
TLC2272AQPWRG4Q1	TSSOP	PW	8	2000	330.0	12.4	7.0	3.6	1.6	8.0	12.0	Q1
TLC2272AQPWRQ1	TSSOP	PW	8	2000	330.0	12.4	7.0	3.6	1.6	8.0	12.0	Q1
TLC2272QPWRG4Q1	TSSOP	PW	8	2000	330.0	12.4	7.0	3.6	1.6	8.0	12.0	Q1
TLC2272QPWRQ1	TSSOP	PW	8	2000	330.0	12.4	7.0	3.6	1.6	8.0	12.0	Q1
TLC2274AQPWRG4Q1	TSSOP	PW	14	2000	330.0	12.4	6.9	5.6	1.6	8.0	12.0	Q1
TLC2274AQPWRQ1	TSSOP	PW	14	2000	330.0	12.4	6.9	5.6	1.6	8.0	12.0	Q1
TLC2274QPWRQ1	TSSOP	PW	14	2000	330.0	12.4	6.9	5.6	1.6	8.0	12.0	Q1

TAPE AND REEL BOX DIMENSIONS

*All dimensions are nominal

Device	Package Type	Package Drawing	Pins	SPQ	Length (mm)	Width (mm)	Height (mm)
TLC2272AQPWRG4Q1	TSSOP	PW	8	2000	356.0	356.0	35.0
TLC2272AQPWRQ1	TSSOP	PW	8	2000	356.0	356.0	35.0
TLC2272QPWRG4Q1	TSSOP	PW	8	2000	356.0	356.0	35.0
TLC2272QPWRQ1	TSSOP	PW	8	2000	356.0	356.0	35.0
TLC2274AQPWRG4Q1	TSSOP	PW	14	2000	356.0	356.0	35.0
TLC2274AQPWRQ1	TSSOP	PW	14	2000	356.0	356.0	35.0
TLC2274QPWRQ1	TSSOP	PW	14	2000	356.0	356.0	35.0

D (R-PDSO-G14)

PLASTIC SMALL OUTLINE



- NOTES:
- A. All linear dimensions are in inches (millimeters).
 - B. This drawing is subject to change without notice.
 -  Body length does not include mold flash, protrusions, or gate burrs. Mold flash, protrusions, or gate burrs shall not exceed 0.006 (0,15) each side.
 -  Body width does not include interlead flash. Interlead flash shall not exceed 0.017 (0,43) each side.
 - E. Reference JEDEC MS-012 variation AB.

D (R-PDSO-G14)

PLASTIC SMALL OUTLINE



4211283-3/E 08/12

- NOTES:
- All linear dimensions are in millimeters.
 - This drawing is subject to change without notice.
 - Publication IPC-7351 is recommended for alternate designs.
 - Laser cutting apertures with trapezoidal walls and also rounding corners will offer better paste release. Customers should contact their board assembly site for stencil design recommendations. Refer to IPC-7525 for other stencil recommendations.
 - Customers should contact their board fabrication site for solder mask tolerances between and around signal pads.



D0008A

PACKAGE OUTLINE

SOIC - 1.75 mm max height

SMALL OUTLINE INTEGRATED CIRCUIT



4214825/C 02/2019

NOTES:

1. Linear dimensions are in inches [millimeters]. Dimensions in parenthesis are for reference only. Controlling dimensions are in inches. Dimensioning and tolerancing per ASME Y14.5M.
2. This drawing is subject to change without notice.
3. This dimension does not include mold flash, protrusions, or gate burrs. Mold flash, protrusions, or gate burrs shall not exceed .006 [0.15] per side.
4. This dimension does not include interlead flash.
5. Reference JEDEC registration MS-012, variation AA.

EXAMPLE BOARD LAYOUT

D0008A

SOIC - 1.75 mm max height

SMALL OUTLINE INTEGRATED CIRCUIT



LAND PATTERN EXAMPLE
EXPOSED METAL SHOWN
SCALE:8X



SOLDER MASK DETAILS

4214825/C 02/2019

NOTES: (continued)

- 6. Publication IPC-7351 may have alternate designs.
- 7. Solder mask tolerances between and around signal pads can vary based on board fabrication site.

EXAMPLE STENCIL DESIGN

D0008A

SOIC - 1.75 mm max height

SMALL OUTLINE INTEGRATED CIRCUIT



SOLDER PASTE EXAMPLE
BASED ON .005 INCH [0.125 MM] THICK STENCIL
SCALE:8X

4214825/C 02/2019

NOTES: (continued)

8. Laser cutting apertures with trapezoidal walls and rounded corners may offer better paste release. IPC-7525 may have alternate design recommendations.
9. Board assembly site may have different recommendations for stencil design.

PW0008A



PACKAGE OUTLINE

TSSOP - 1.2 mm max height

SMALL OUTLINE PACKAGE



NOTES:

1. All linear dimensions are in millimeters. Any dimensions in parenthesis are for reference only. Dimensioning and tolerancing per ASME Y14.5M.
2. This drawing is subject to change without notice.
3. This dimension does not include mold flash, protrusions, or gate burrs. Mold flash, protrusions, or gate burrs shall not exceed 0.15 mm per side.
4. This dimension does not include interlead flash. Interlead flash shall not exceed 0.25 mm per side.
5. Reference JEDEC registration MO-153, variation AA.

EXAMPLE BOARD LAYOUT

PW0008A

TSSOP - 1.2 mm max height

SMALL OUTLINE PACKAGE



LAND PATTERN EXAMPLE
SCALE:10X



SOLDER MASK DETAILS
NOT TO SCALE

4221848/A 02/2015

NOTES: (continued)

- 6. Publication IPC-7351 may have alternate designs.
- 7. Solder mask tolerances between and around signal pads can vary based on board fabrication site.

EXAMPLE STENCIL DESIGN

PW0008A

TSSOP - 1.2 mm max height

SMALL OUTLINE PACKAGE



SOLDER PASTE EXAMPLE
BASED ON 0.125 mm THICK STENCIL
SCALE:10X

4221848/A 02/2015

NOTES: (continued)

8. Laser cutting apertures with trapezoidal walls and rounded corners may offer better paste release. IPC-7525 may have alternate design recommendations.
9. Board assembly site may have different recommendations for stencil design.

重要声明和免责声明

TI“按原样”提供技术和可靠性数据（包括数据表）、设计资源（包括参考设计）、应用或其他设计建议、网络工具、安全信息和其他资源，不保证没有瑕疵且不做任何明示或暗示的担保，包括但不限于对适销性、某特定用途方面的适用性或不侵犯任何第三方知识产权的暗示担保。

这些资源可供使用 TI 产品进行设计的熟练开发人员使用。您将自行承担以下全部责任：(1) 针对您的应用选择合适的 TI 产品，(2) 设计、验证并测试您的应用，(3) 确保您的应用满足相应标准以及任何其他功能安全、信息安全、监管或其他要求。

这些资源如有变更，恕不另行通知。TI 授权您仅可将这些资源用于研发本资源所述的 TI 产品的应用。严禁对这些资源进行其他复制或展示。您无权使用任何其他 TI 知识产权或任何第三方知识产权。您应全额赔偿因在这些资源的使用中对 TI 及其代表造成的任何索赔、损害、成本、损失和债务，TI 对此概不负责。

TI 提供的产品受 [TI 的销售条款](#) 或 [ti.com](#) 上其他适用条款/TI 产品随附的其他适用条款的约束。TI 提供这些资源并不会扩展或以其他方式更改 TI 针对 TI 产品发布的适用的担保或担保免责声明。

TI 反对并拒绝您可能提出的任何其他或不同的条款。

邮寄地址：Texas Instruments, Post Office Box 655303, Dallas, Texas 75265
Copyright © 2024，德州仪器 (TI) 公司