

Dual Channel USB3.0 Redriver/Equalizer

Check for Samples: [SN65LVPE502](#)

FEATURES

- Single Lane USB 3.0 Equalizer/Redriver
- Selectable Equalization, De-emphasis and Output Swing Control
- Integrated Termination
- Hot-Plug Capable
- Receiver Detect
- Low Power:
 - 315mW(TYP), $V_{CC} = 3.3V$
- Auto Low Power Modes:
 - 5mW (TYP) When no Connection Detected
 - 70mW (TYP) When in U2/U3 Mode
- Excellent Jitter and Loss Compensation Capability: to 24"
 - 24" of 6 mil Stripline on FR4
 - 12" on Input and 4m, 26AWG USB 3.0 Cable on Output
- Small foot print – 24 Pin (4mm × 4mm) QFN Package
- High Protection Against ESD Transient
 - HBM: 5,000 V
 - CDM: 1,500 V
 - MM: 200 V

APPLICATIONS

- Notebooks, Desktops, Docking Stations, Backplane and Cabled Application

DESCRIPTION

The SN65LVPE502 is a dual channel, single lane USB 3.0 redriver and signal conditioner supporting data rates of 5.0Gbps. The device complies with USB 3.0 spec revision 1.0, supporting electrical idle condition and low frequency periodic signals (LFPS) for USB 3.0 power management modes.

Programmable EQ, De-Emphasis and Amplitude Swing

The SN65LVPE502 is designed to minimize signal degradation effects such as crosstalk and inter-symbol interference (ISI) that limits the interconnect distance between two devices. The input stage of each channel offers selectable equalization settings that can be programmed to match loss in the channel. The differential outputs provide selectable de-emphasis to compensate for the anticipated distortion USB 3.0 signal will experience. Level of de-emphasis will depend on the length of interconnect and its characteristics. The SN65LVPE502 provides a unique way to tailor output de-emphasis on a per channel basis with use of DE and OS pins. All Rx and Tx equalization settings supported by the device are programmed by six 3-state pins as shown in [Table 2](#).

Low Power Modes

The device supports three low power modes as described below.

1. Sleep Mode

Initiated anytime EN_RXD undergoes a high to low transition or when device powers up with EN_RXD set low. In sleep mode both input and output terminations are held at HiZ and device ceases operation to conserve power. Sleep mode max power consumption is 1mW, entry time is 2 μ s, device exits sleep mode to Rx.Detect mode after EN_RXD is driven to V_{CC} , exit time is 100 μ s max.

2. RX Detect Mode – When no remote device is connected

Anytime SN65LVPE502 detects a break in link (i.e., when upstream device is disconnected) or after powerup fails to find a remote device, SN65LVPE502 goes to Rx Detect mode and conserves power by shutting down majority of the internal circuitry. In this mode, input termination for both channels are driven to Hi-Z. In Rx Detect mode device power is <10mW(TYP) or less than 5% of its normal operating power This feature is useful in saving system power in mobile applications like notebook PC where battery life is critical.

Anytime an upstream device gets reconnected the redriver automatically senses the connection and goes to normal operating mode. This operation requires no setting to the device.



Please be aware that an important notice concerning availability, standard warranty, and use in critical applications of Texas Instruments semiconductor products and disclaimers thereto appears at the end of this data sheet.

3. U2/U3 Mode

With the help of internal timers the device tracks when link enters USB 3.0 low power modes U2 and U3, in these modes link is in electrical idle state. SN65LVPE502 will selectively turn-off internal circuitry to save on power. Typical power saving is about 75% lower than normal operating mode. The device will automatically revert to active mode when signaling activity (LFPS) is detected.



These devices have limited built-in ESD protection. The leads should be shorted together or the device placed in conductive foam during storage or handling to prevent electrostatic damage to the MOS gates.

DESCRIPTION CONTINUED

Receiver Detection

RX.Detect cycle is performed by first setting Rx termination for each channel to Hi-Z, device then starts sensing for receiver termination that may be attached at the other end of each TX.

If receiver is detected on both channel:

- The TX and RX terminations are switched to $Z_{DIFF-TX}$, $Z_{DIFF-RX}$, respectively

If no receiver is detected on one or both channels:

- The transmitter is pulled to Hi-Z
- The channel is put in low power mode
- Device attempts to detect Rx termination in 12 ms (TYP) interval until termination is found or the device is put in sleep mode.

USB Compliance Mode

The device enters USB compliance mode when both EN_RXD and CM pins are set H. This mode is used to test the transmitter for compliance to voltage and timing specifications per USB 3.0 compliance specs. In this mode each channel will maintain its low-impedance termination R_{DC-RX} , while auto Rx detect operation in the device is disabled.

Electrical Idle Support

The electrical idle support is needed for low frequency periodic signaling (LFPS) used in USB 3.0 side band communication. A link is in an electrical idle state when the TX± voltage is held at a steady constant value like the common mode voltage. SN65LVPE502 detects an electrical idle state when RX± voltage at the device pin falls below $V_{RX_IDLE_DIFFpp}$ min. After detection of an idle state in a given channel the device asserts electrical idle state in its corresponding TX. When RX± voltage exceeds $V_{RX_IDLE_DIFFpp}$ max normal operation is restored and output start passing input signal. The electrical idle exit and entry time is specified at ≤ 6 ns.

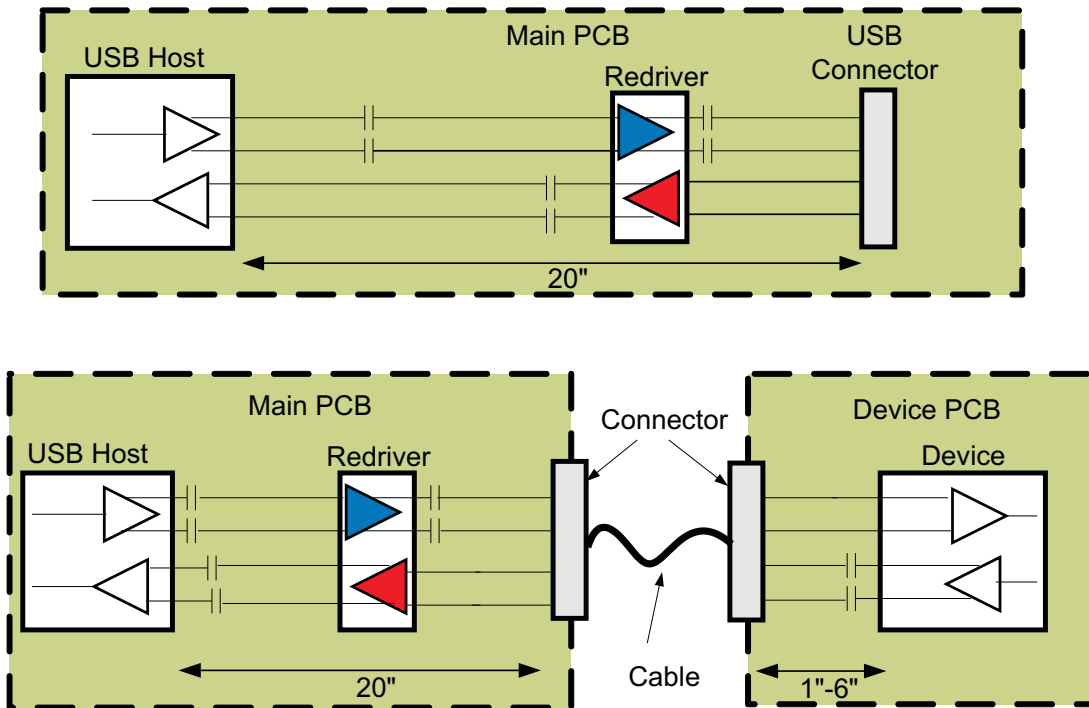

Figure 1. Typical Application

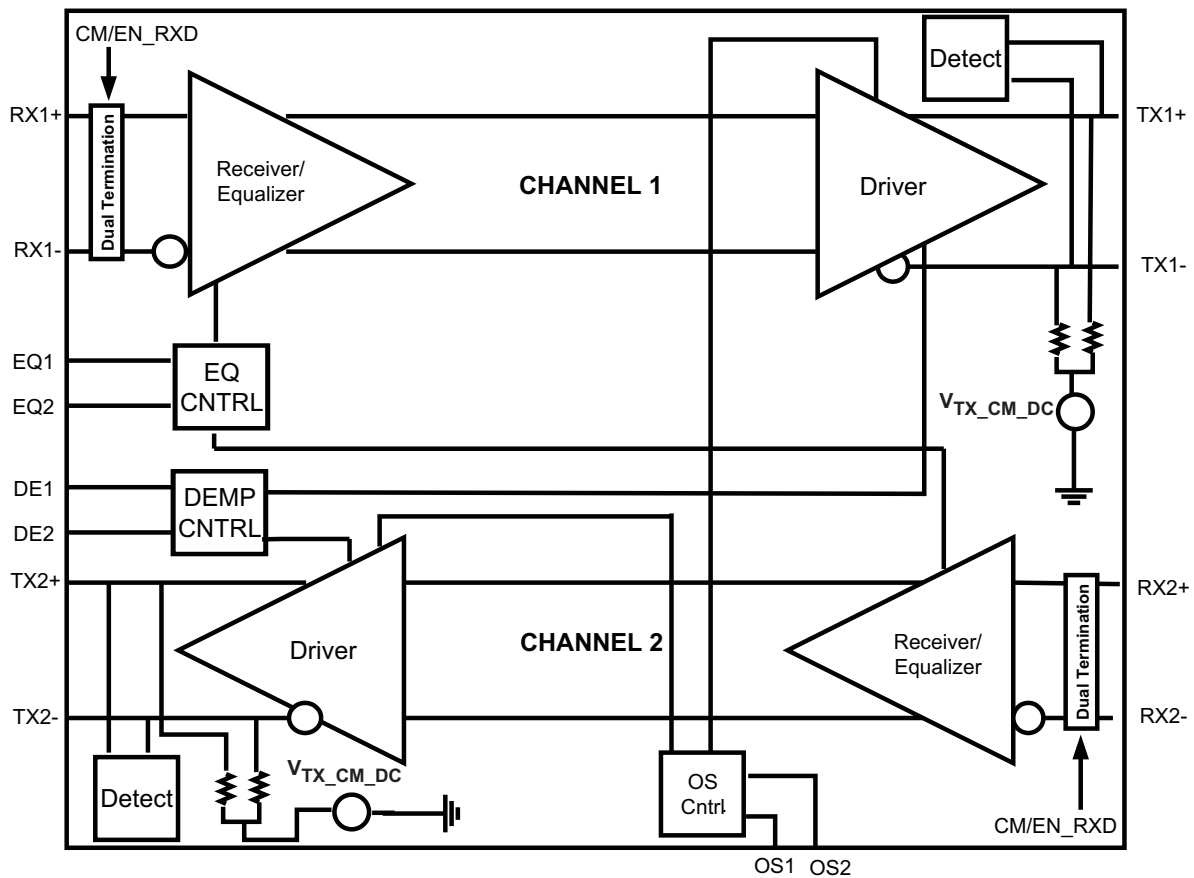

Figure 2. Data Flow Block Diagram

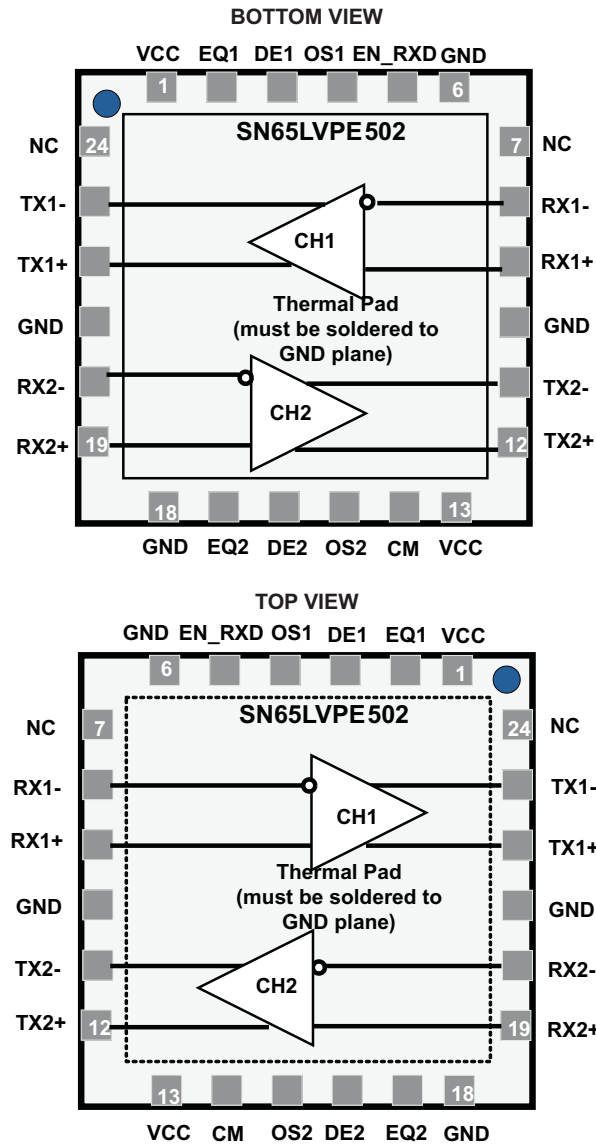

Figure 3. Flow-Through Pin-Out

Table 1. Pin Description

PIN			DESCRIPTION
NUMBER	NAME	I/O TYPE	
HIGH SPEED DIFFERENTIAL I/O PINS			
8	RX1-	I, CML	Non-inverting and inverting CML differential input for CH 1 and CH 2. These pins are tied to an internal voltage bias by dual termination resistor circuit
9	RX1+	I, CML	
20	RX2-	I, CML	
19	RX2+	I, CML	
23	TX1-	O, VML	Non-inverting and inverting VML differential output for CH 1 and CH 2. These pins are internally tied to voltage bias by termination resistors
22	TX1+	O, VML	
11	TX2-	O, VML	
12	TX2+	O, VML	

Table 1. Pin Description (continued)

PIN			
DEVICE CONTROL PIN			
5	EN_RXD	I, LVCMOS	Sets device operation modes per Table 2. Internally pulled to VCC
14	CM	I, LVCMOS	Sets device in compliance mode when pulled to VCC, internally pulled to GND
7,24	NC		Pads not internally connected
EQ CONTROL PINS⁽¹⁾			
3,16	DE1, DE2	I, LVCMOS	Selects de-emphasis settings for CH 1 and CH 2 per Table 2. Internally tied to V _{CC} /2
2,17	EQ1, EQ2	I, LVCMOS	Selects equalization settings for CH 1 and CH 2 per Table 2. Internally tied to V _{CC} /2
4, 15	OS1, OS2	I, LVCMOS	Selects output amplitude for CH 1 and CH 2 per Table 2. Internally tied to V _{CC} /2
POWER PINS			
1,13	VCC	Power	Positive supply should be 3.3V ± 10%
6,10,18,21	GND	Power	Supply ground

(1) Internally biased to V_{CC}/2 with >200kΩ pull-up/pull-down. When pins are left as NC board leakage at this pin pad must be < 1 μA otherwise drive to V_{CC}/2 to assert mid-level state.

Table 2. Signal Control Pin Setting

OS _x ⁽¹⁾		TRANSITION BIT AMPLITUDE (TYP mVpp)	
NC (default)		1000	
0		870	
1		1085	
EQ _x ⁽¹⁾		EQUALIZATION dB	
NC (default)		0	
0		7	
1		15	
DE _x ⁽¹⁾	OS _x ⁽¹⁾ = NC	OS _x ⁽¹⁾ = 0	OS _x ⁽¹⁾ = 1
NC	-3.5 dB	-2.2 dB	-4.4 dB
0	-6.0 dB	-5.2 dB	-6.0 dB
1	-8.5 dB	-8.9 dB	-7.6 dB
EN_RXD		DEVICE FUNCTION	
1 (default)		Normal operating mode	
0		Sleep mode	
CM		DEVICE FUNCTION	
0 (default)		Normal Mode	
1		Compliance mode	

(1) Applies to Channel 1 and Channel 2 at 2.5 GHz.

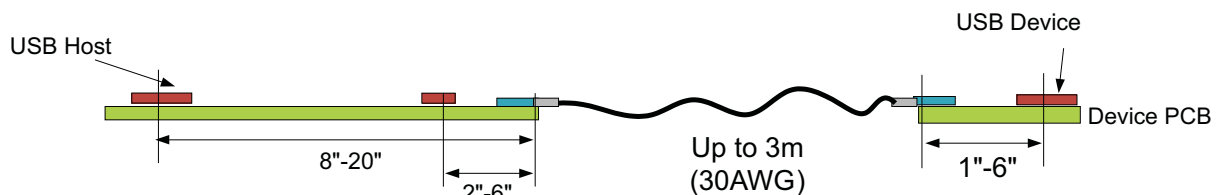

Figure 4. Redriver Placement Example

ORDERING INFORMATION⁽¹⁾

PART NUMBER	PART MARKING	PCAKAGE
SN65LVPE502RGER	LVPE502	24-pin RGE Reel (large)
SN65LVPE502RGET	LVPE502	24-pin RGE Reel (small)

(1) For the most current package and ordering information, see the Package Option Addendum at the end of this document, or see the TI web site at www.ti.com.

ABSOLUTE MAXIMUM RATINGS

over operating free-air temperature range (unless otherwise noted)⁽¹⁾

		UNITS / VALUES
Supply Voltage Range ⁽²⁾	V _{CC}	–0.5 V to 4 V
Voltage Range	Differential I/O	–0.5 V to 4 V
	Control I/O	–0.5 V to V _{CC} + 0.5V
Electrostatic discharge	Human Body Model ⁽³⁾	±5000V
	Charged Device Model ⁽⁴⁾	±1500V
	Machine Model ⁽⁵⁾	±200V
Continuous power dissipation		See Dissipation Rating Table

(1) Stresses beyond those listed under absolute maximum ratings may cause permanent damage to the device. These are stress ratings only and functional operation of the device at these or any conditions beyond those indicated under recommended operating conditions is not implied. Exposure to absolute-maximum-rated conditions for extended periods may affect device reliability.

(2) All voltage values, except differential voltages, are with respect to network ground terminal.

(3) Tested in accordance with JEDEC Standard 22, Test Method A114-B.

(4) Tested in accordance with JEDEC Standard 22, Test Method C101-A.

(5) Tested in accordance with JEDEC Standard 22, Test Method A115-A.

PACKAGE CHARACTERIZATION

over operating free-air temperature range (unless otherwise noted)

PARAMETER		TEST CONDITIONS	MIN	TYP	MAX	UNIT
P _D	Device power dissipation	CM, EN_RXD, EQ cntrl pins = NC, K28.5 pattern at 5 Gbps, V _{ID} = 1000 mVpp		330	450	mW
P _{SD}	Device power dissipation under low power mode	EN_RXD= GND		0.3	1	mW

THERMAL INFORMATION

THERMAL METRIC ⁽¹⁾		SN65LVPE502	UNITS
		RGE	
		24 PINS	
θ _{JA}	Junction-to-ambient thermal resistance	46	°C/W
θ _{JC(TOP)}	Junction-to-case(top) thermal resistance	42	
θ _{JB}	Junction-to-board thermal resistance	13	
ψ _{JT}	Junction-to-top characterization parameter	0.5	
ψ _{JB}	Junction-to-board characterization parameter	9	
θ _{JC(BOTTOM)}	Junction-to-case(bottom) thermal resistance	4	

(1) For more information about traditional and new thermal metrics, see the *IC Package Thermal Metrics* application report, SPRA953.

RECOMMENDED OPERATING CONDITIONS

over operating free-air temperature range (unless otherwise noted)

		MIN	TYP	MAX	UNIT
V _{CC}	Supply Voltage	3	3.3	3.6	V
C _{COUPLING}	AC Coupling Capacitor	75		200	nF
	Operating free-air temperature	0		85	°C

DEVICE POWER

The SN65LVPE502 is designed to operate from a single 3.3 V supply.

ELECTRICAL CHARACTERISTICS

over operating free-air temperature range (unless otherwise noted)

PARAMETER		TEST CONDITIONS	MIN	TYP	MAX	UNIT
DEVICE PARAMETERS						
I _{CC}	Supply Current	EN_RXD, CM, EQ cntrl = NC, K28.5 pattern at 5 Gbps, V _{ID} = 1000 mV _{pp}		100	120	mA
I _{CC} _{Rx.Detect}		In Rx.Detect mode		2	5	
I _{CC} _{sleep}		EN_RXD = GND			0.1	
I _{CC} _{U2-U3}		Link in USB low power state		21		
	Maximum Data Rate				5	Gbps
t _{ENB}	Device Enable Time	Sleep mode exit time EN_RXD L→H With Rx termination present			100	μs
t _{DIS}	Device Disable Time	Sleep mode entry time EN_RXD H→L			2	μs
T _{RX.DETECT}	Rx.Detect Start Event	Power-up time			100	μs
CONTROL LOGIC (under recommended operating conditions)						
V _{IH}	High level Input Voltage		1.4		V _{CC}	V
V _{IL}	Low Level Input Voltage		-0.3		0.5	V
V _{HYS}	Input Hysteresis			150		mV
I _{IH}	High Level Input Current	OSx, EQx, DEx = V _{CC}			30	μA
		EN_RXD = V _{CC}			1	
		CM = V _{CC}			30	
I _{IL}	Low Level Input Current	OSx, EQx, DEx = GND	-30			μA
		EN_RXD = GND	-30			
		CM = GND	-1			
RECEIVER AC/DC						
V _{in} _{diff_pp}	RX1, RX2 Input Voltage Swing	AC coupled differential RX peak to peak signal	100		1200	mVpp
V _{CM_RX}	RX1, RX2 Common Mode Voltage			3.3		V
V _{in} _{COM_P}	RX1, RX2 AC Peak common mode voltage	Measured at Rx pins with termination enabled			150	mVP
Z _{DC_RX}	DC common mode impedance		18	26	30	Ω
Z _{diff_RX}	DC differential input impedance		72	80	120	Ω
Z _{RX_High_IMP+}	DC Input High Impedance	Device in sleep mode Rx termination not powered. Measured with respect to GND over 500mV max	50	85		kΩ
V _{RX-LFPS-DETpp}	Low Voltage Periodic Signaling (LFPS) Detect Threshold	Measured at receiver pin, below minimum output is squelched, above max input signal is passed to output	100		300	mVpp
RL _{RX-DIFF}	Differential Return Loss	50 MHz – 1.25 GHz	10	11		dB
		1.25 GHz – 2.5 GHz	6	7		
RL _{RX-CM}	Common Mode Return Loss	50 MHz – 2.5 GHz	11	13		dB

ELECTRICAL CHARACTERISTICS (continued)

over operating free-air temperature range (unless otherwise noted)

PARAMETER		TEST CONDITIONS	MIN	TYP	MAX	UNIT
TRANSMITTER AC/DC						
V _{TXDIFF_TB_PP}	Differential peak-to-peak Output Voltage (VID = 800, 1200 mVpp, 5Gbps)	R _L = 100Ω +1%, DEX, OS _x = NC, Transition Bit	800	1000	1200	mV
		R _L = 100Ω +1%, DEX, OS _x = GND Transition Bit	870			
		R _L = 100Ω +1%, DEX, OS _x = VCC Transition Bit	1085			
V _{TXDIFF_NTBP_PP}		R _L = 100Ω +1%, DEX=NC, OS _x = 0,1,NC Non-Transition Bit	665			
		R _L = 100Ω +1%, DEX=0, OS _x = 0,1,NC Non-Transition Bit	510			
		R _L = 100Ω +1%, DEX=1 OS _x = 0,1,NC Non-Transition Bit	375			
De-Emphasis Level		OS _{1,2} = NC (for OS _{1,2} = 1 and 0 see Table 2)	-3.0	-3.5	-4.0	dB
			-6.0			
			-8.5			
T _{DE}	De-Emphasis Width		0.85			UI
Z _{diff_TX}	DC Differential Impedance		72	90	120	Ω
Z _{CM_TX}	DC Common Mode Impedance	Measured w.r.t to AC ground over 0-500mV	18	23	30	Ω
R _{Ldiff_TX}	Differential Return Loss	f = 50 MHz – 1.25 GHz	9	10		dB
		f = 1.25 GHz – 2.5 GHz	6	7		
R _{Lcm_TX}	Common Mode Return Loss	f = 50 MHz – 2.5 GHz	11	12		dB
I _{TX_SC}	TX short circuit current	TX± shorted to GND			60	mA
V _{TX_CM_DC}	Transmitter DC common-mode voltage		2.0	2.6	3.0	V
V _{TX_CM_AC_Active}	TX AC common mode voltage active			30	100	mVpp
V _{TX_idle_diff-AC-pp}	Electrical idle differential peak to peak output voltage	HPF to remove DC	0		10	mV
V _{TX_CM_DeltaU1-U0}	Absolute delta of DC CM voltage during active and idle states			35	200	mV
V _{TX_idle_diff-DC}	DC Electrical idle differential output voltage	Voltage must be low pass filtered to remove any AC component	0		10	mV
V _{detect}	Voltage change to allow receiver detect	Positive voltage to sense receiver termination			600	mV
t _R , t _F	Output Rise/Fall time	20%-80% of differential voltage measure 1" from the output pin	30	50		ps
t _{RF_MM}	Output Rise/Fall time mismatch				20	ps
T _{diff_LH} , T _{diff_HL}	Differential Propagation Delay	De-Emphasis = -3.5dB (CH 0 and CH 1). Propagation delay between 50% level at input and output See Figure 5		290	350	ps
t _{idleEntry} t _{idleExit}	Idle entry and exit times	See Figure 6		4	6	ns
C _{TX}	Tx input capacitance to GND	At 2.5 GHz		1.25		pF
EQUALIZATION						
T _{TX-EYE} ⁽¹⁾⁽²⁾	Total Jitter (Tj) at point A	Device setting: OS1 = L, DE1 = H, EQ1 = L		0.14	0.5	Ulpp ⁽³⁾
DJ _{TX} ⁽²⁾	Deterministic Jitter (Dj)			0.06	0.3	
RJ _{TX} ⁽²⁾⁽⁴⁾	Random Jitter (Rj)			0.08	0.2	
T _{TX-EYE} ⁽¹⁾⁽²⁾	Total Jitter (Tj) at point B	Device setting: OS2 = H, DE2 = H, EQ2 = L		0.14	0.5	Ulpp ⁽³⁾
DJ _{TX} ⁽²⁾	Deterministic Jitter (Dj)			0.06	0.3	
RJ _{TX} ⁽²⁾⁽⁴⁾	Random Jitter (Rj)			0.08	0.2	

(1) Includes Rj at 10⁻¹²

(2) Measured at the end of reference channel in Figure 8 with K28.5 pattern, V_{ID}=1000mVpp, 5Gbps, -3.5dB DE from source.

(3) UI = 200ps

(4) Rj calculated as 14.069 times the RMS random jitter for 10⁻¹² BER

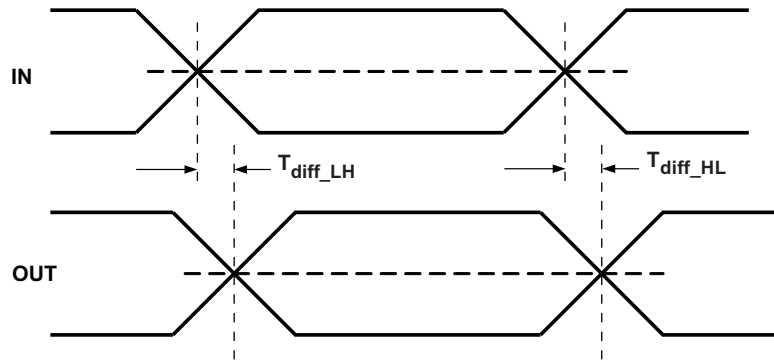

Figure 5. Propagation Delay

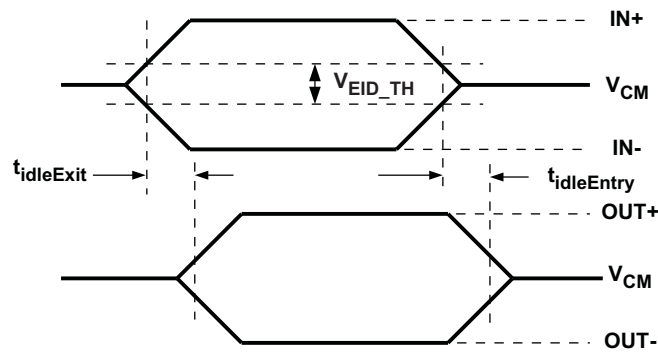

Figure 6. Electrical Idle Mode Exit and Entry Delay

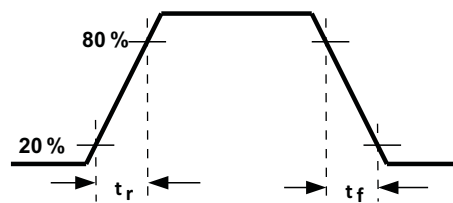

Figure 7. Output Rise and Fall Times

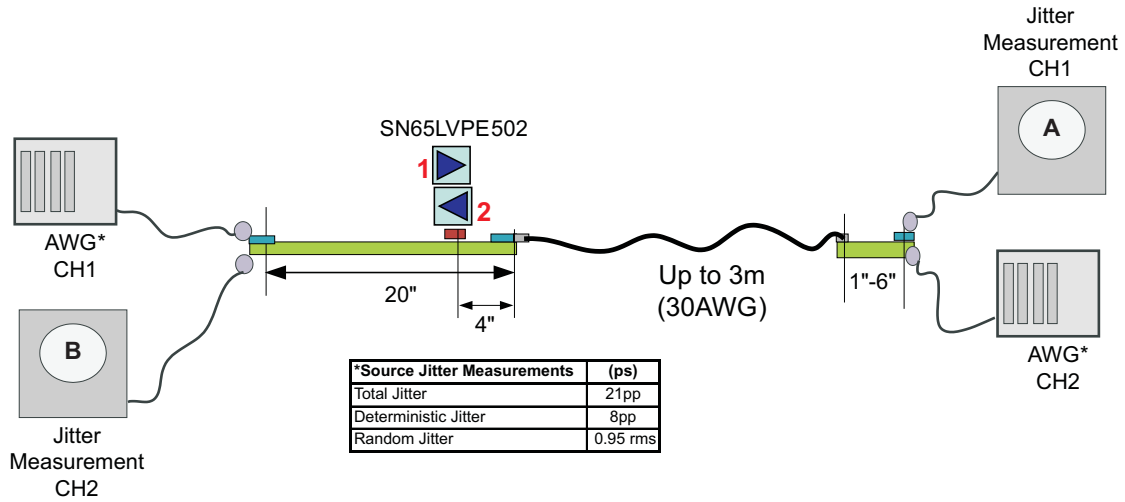

Figure 8. Jitter Measurement Setup

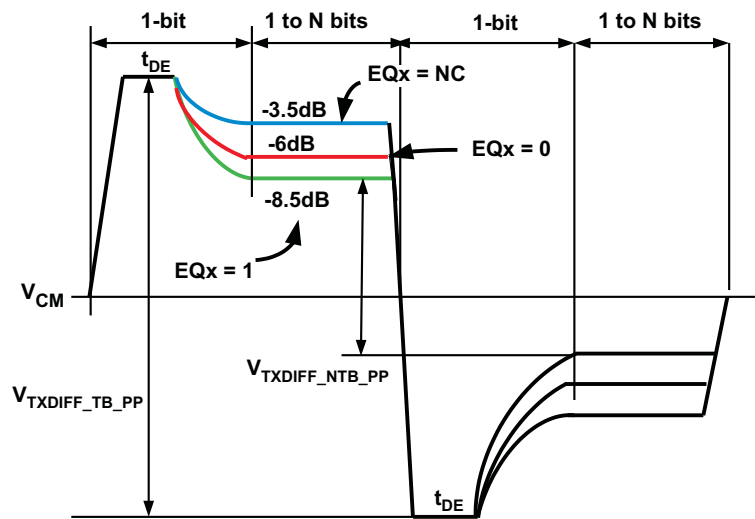

Figure 9. Output De-Emphasis Levels OSx = NC

Typical Eye Diagram and Performance Curves

Input Signal Characteristics: Data Rate = 5 Gbps, $V_{ID} = 1000$ mVpp, DE = -3.5 dB, Pattern = K28.5 Device
 Operating Conditions: VCC = 3.3 V, Temp = 25°C

Input Trace Length Held Constant and Output Cable Length Varied

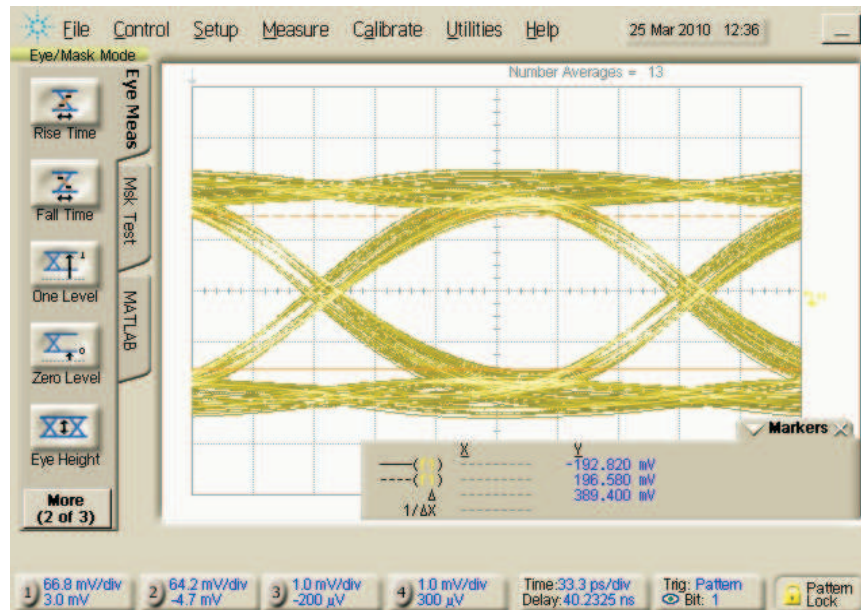

Figure 10. Input Trace = 12 Inches, 6 mil and Output USB 3 Cable Length = 1 M

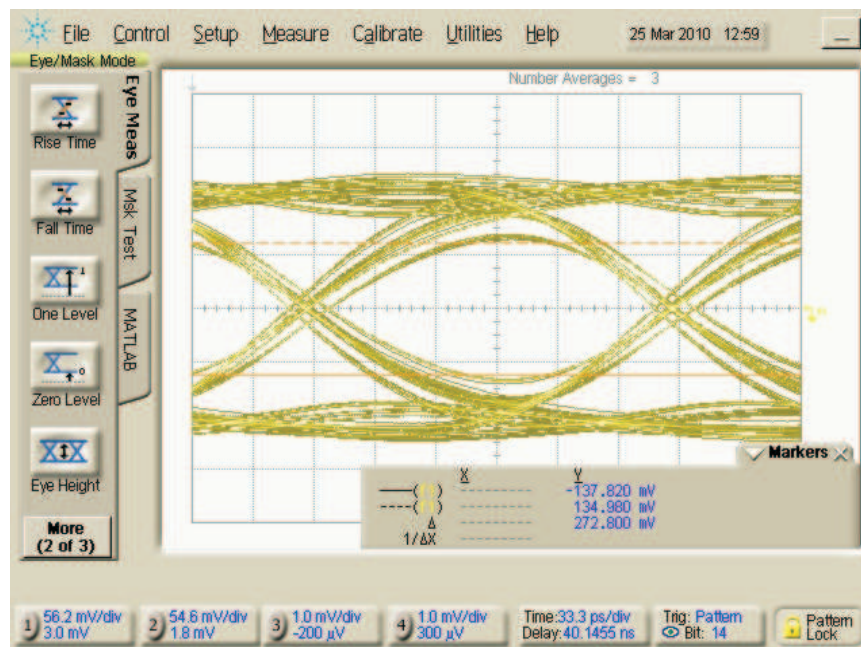

Figure 11. Input Trace = 12 Inches, 6 mil and Output USB 3 Cable Length = 2 M

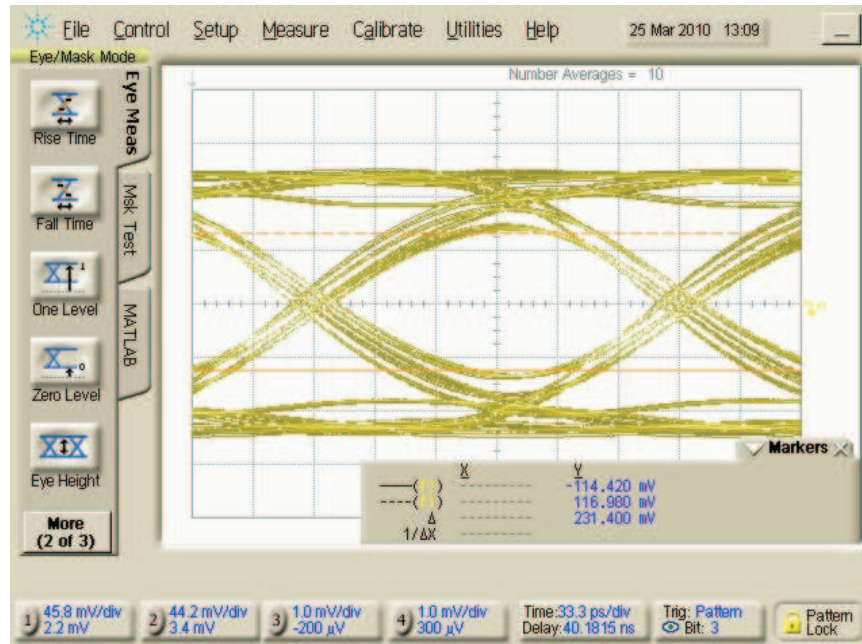

Figure 12. Input Trace = 12 Inches, 6 mil and Output USB 3 Cable Length = 3 M

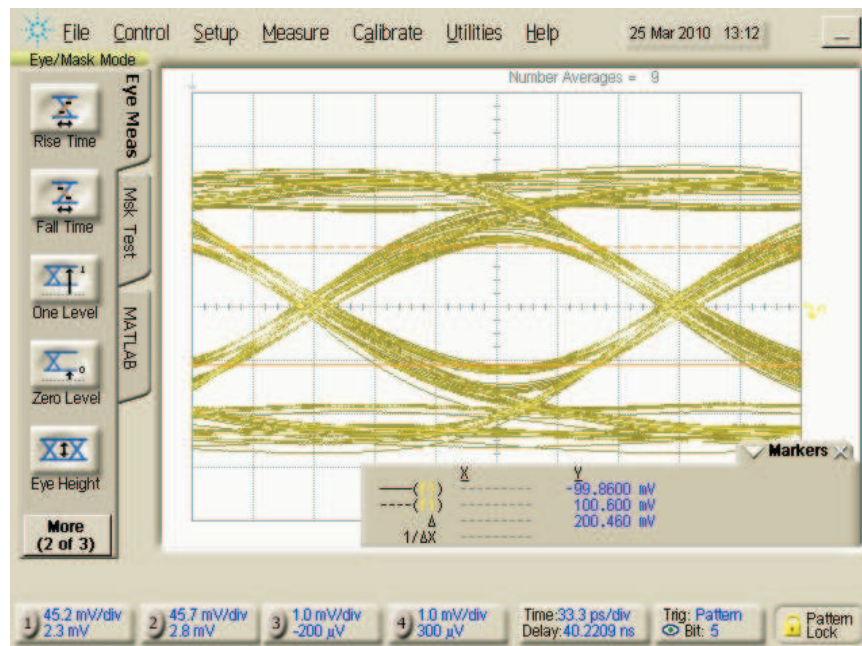

Figure 13. Input Trace = 12 Inches, 6 mil and Output USB 3 Cable Length = 4 M

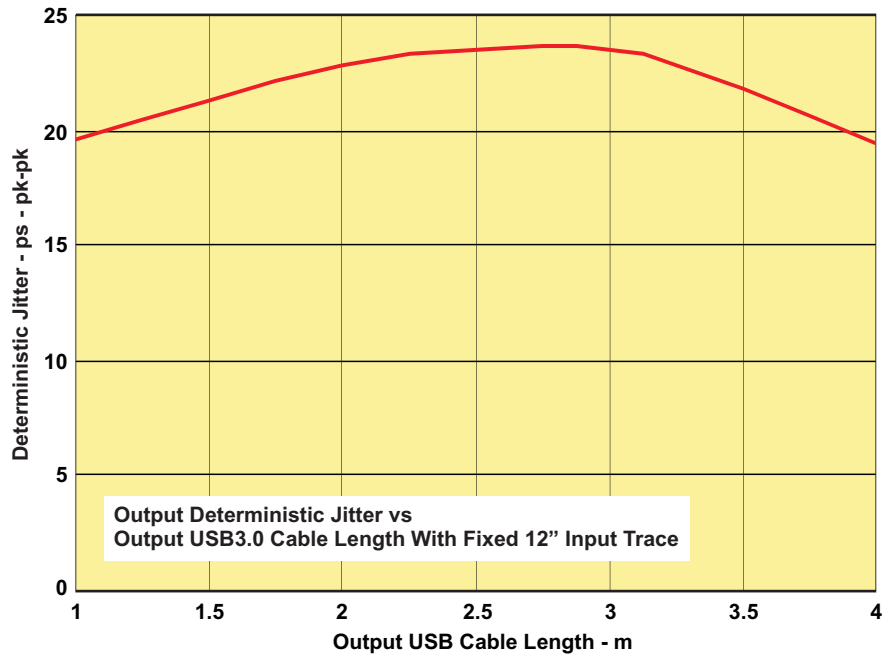

Figure 14. Jitter Performance Over Different Cable Lengths

Input Trace Length Held Constant and Output Trace Varied

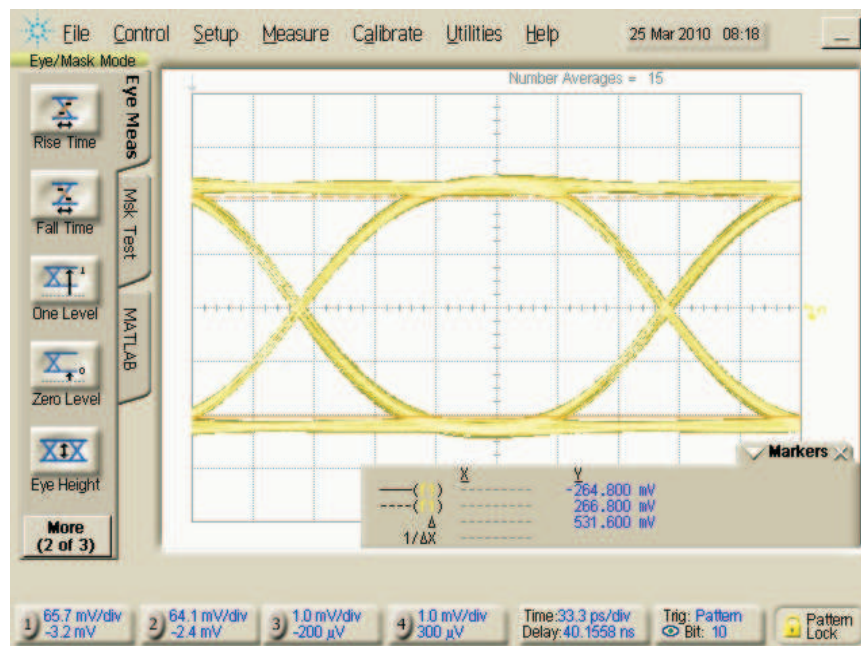

Figure 15. Input Trace = 4 Inches, 6 mil and Output Trace = 4 Inches, 6 mil

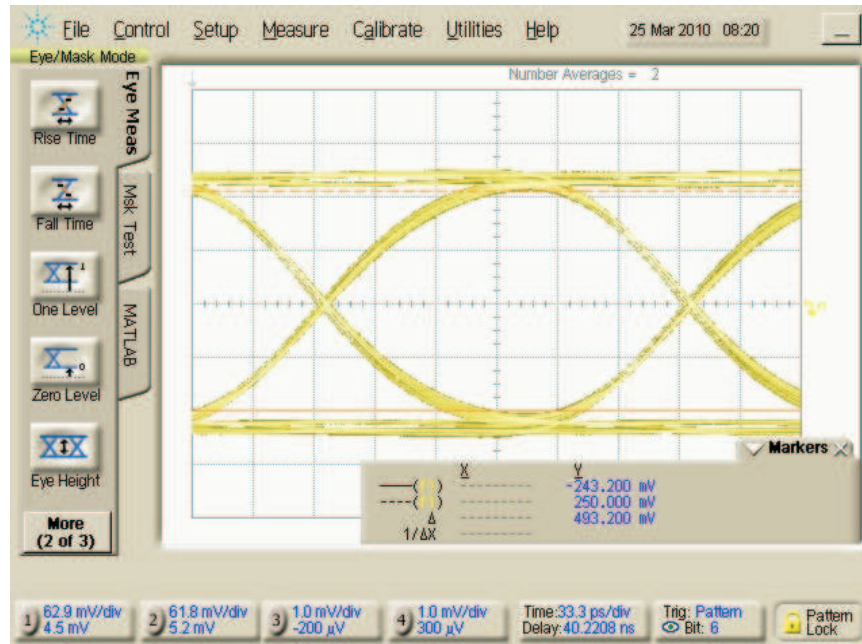

Figure 16. Input Trace = 4 Inches, 6 mil and Output Trace = 8 Inches, 6 mil

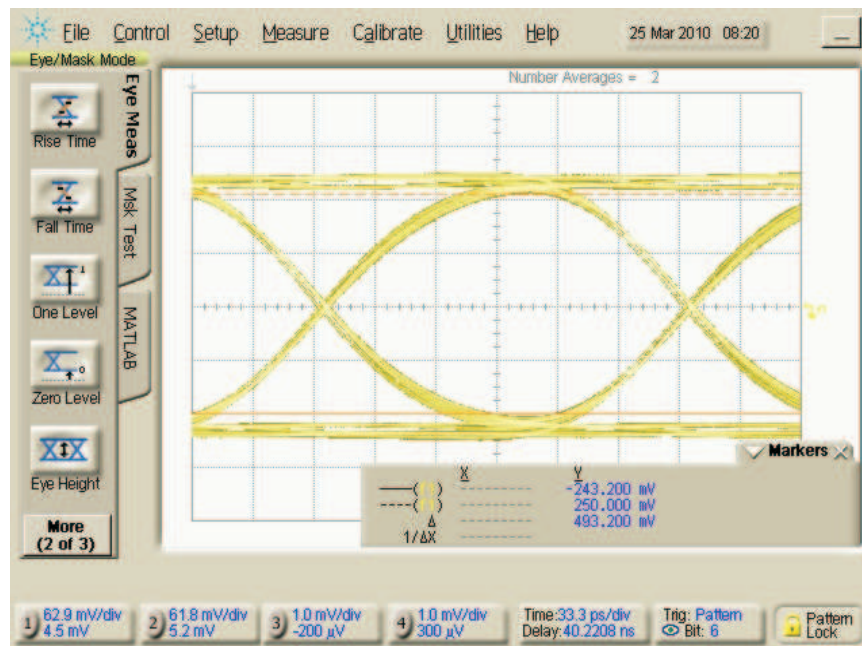

Figure 17. Input Trace = 4 Inches, 6 mil and Output Trace = 12 Inches, 6 mil

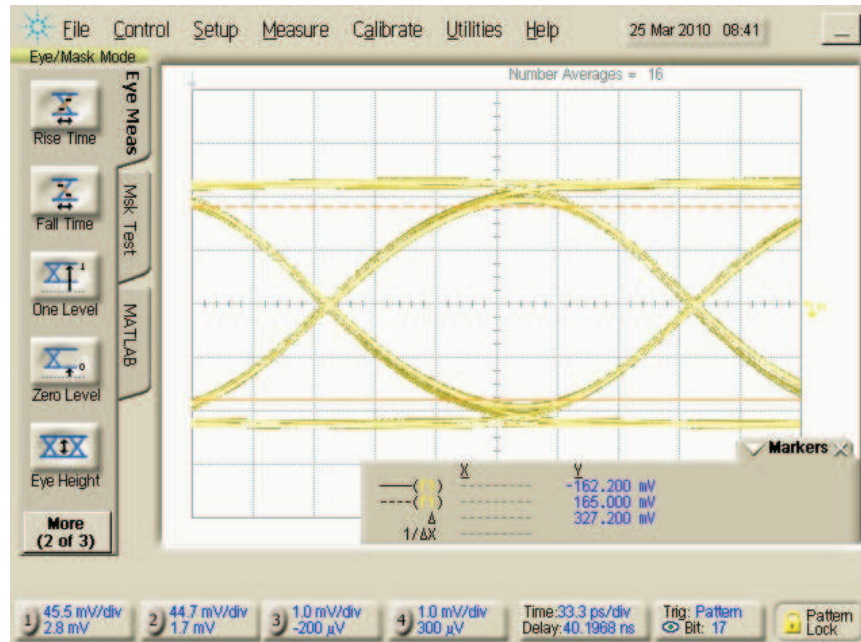

Figure 18. Input Trace = 4 Inches, 6 mil and Output Trace = 16 Inches, 6 mil

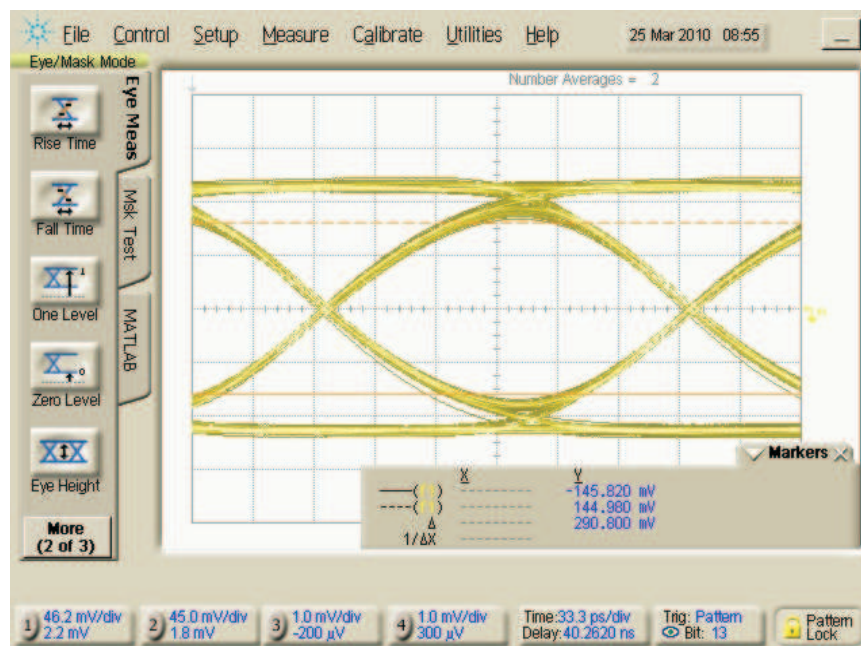

Figure 19. Input Trace = 4 Inches, 6 mil and Output Trace = 20 Inches, 6 mil

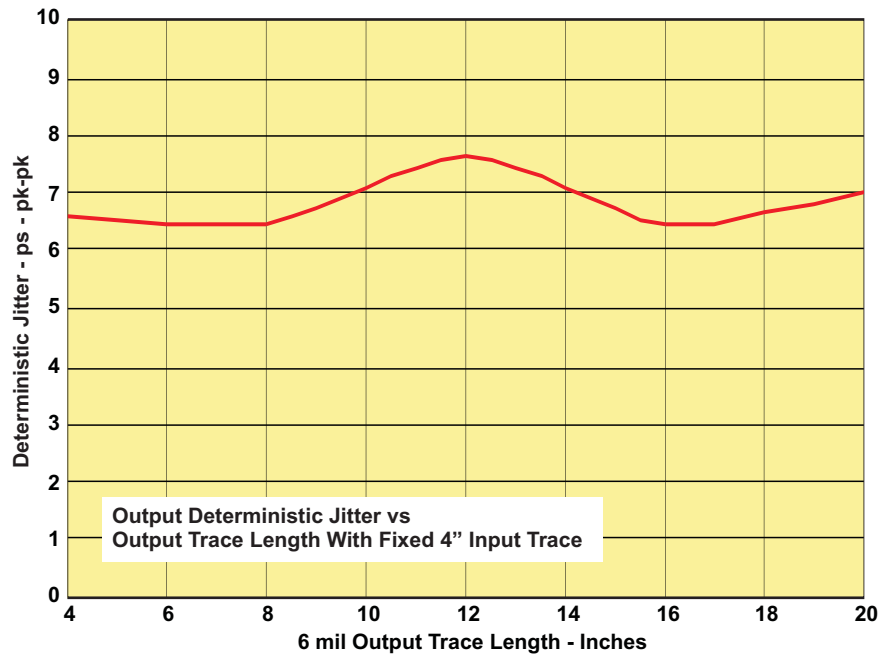

Figure 20. Jitter Performance Over Different Output Trace Lengths

Output Trace Length Held Constant and Input Trace Length Varied

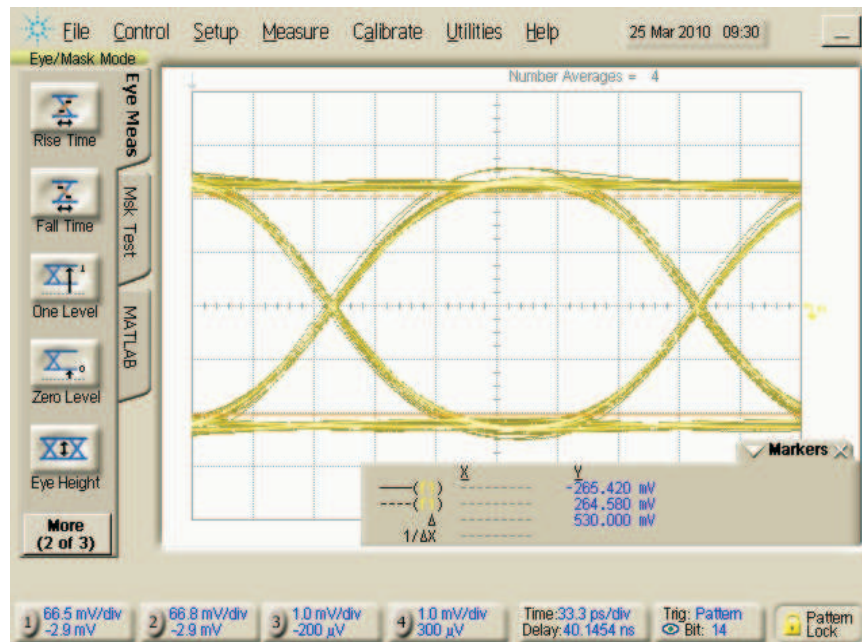

Figure 21. Input Trace = 4 Inches, 6 mil and Output Trace = 4 Inches, 6 mil

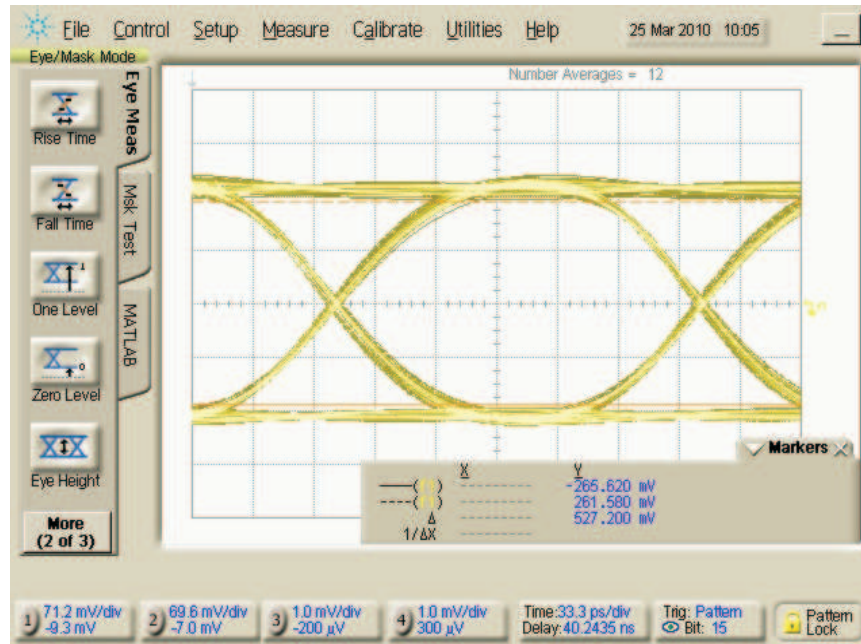

Figure 22. Input Trace = 8 Inches, 6 mil and Output Trace = 4 Inches, 6 mil

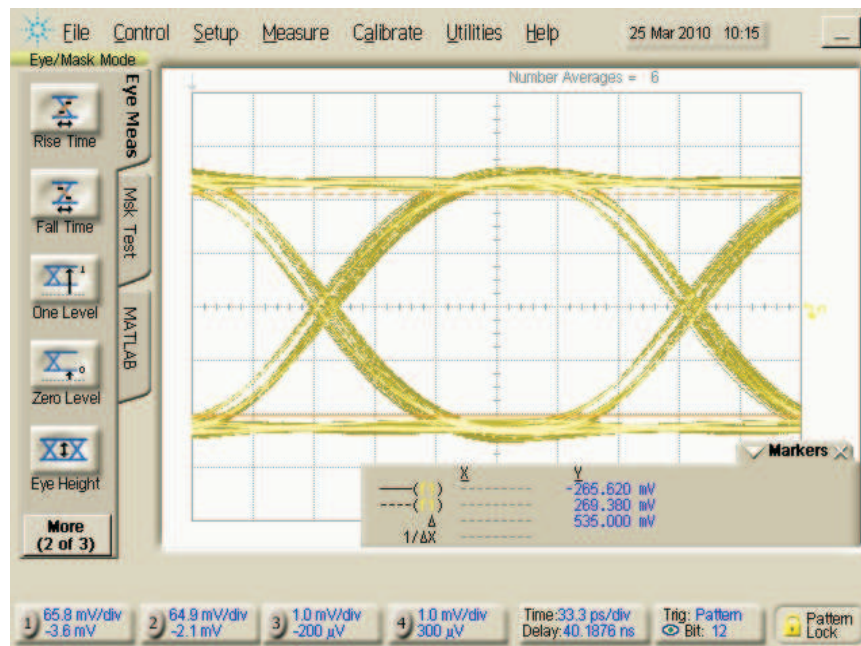

Figure 23. Input Trace = 12 Inches, 6 mil and Output Trace = 4 Inches, 6 mil

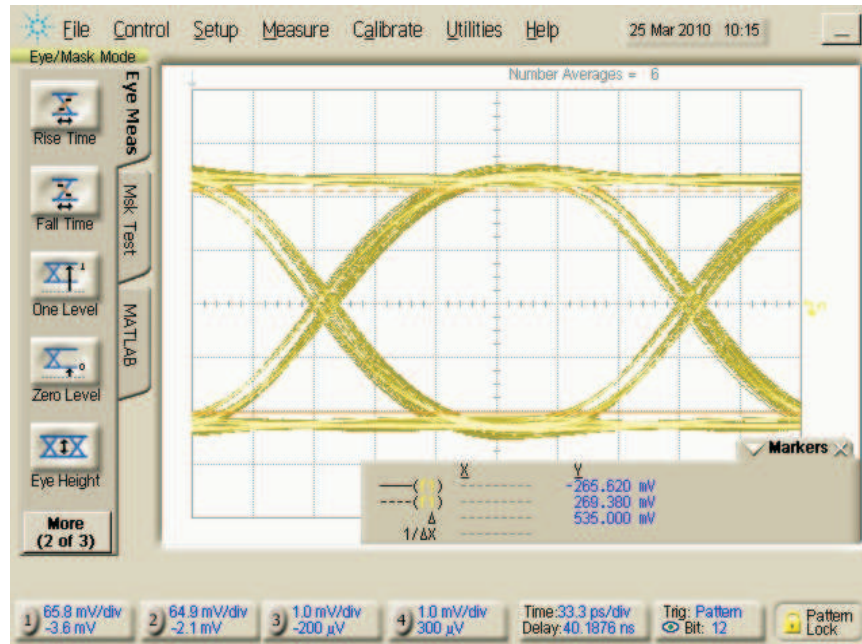

Figure 24. Input Trace = 16 Inches, 6 mil and Output Trace = 4 Inches, 6 mil

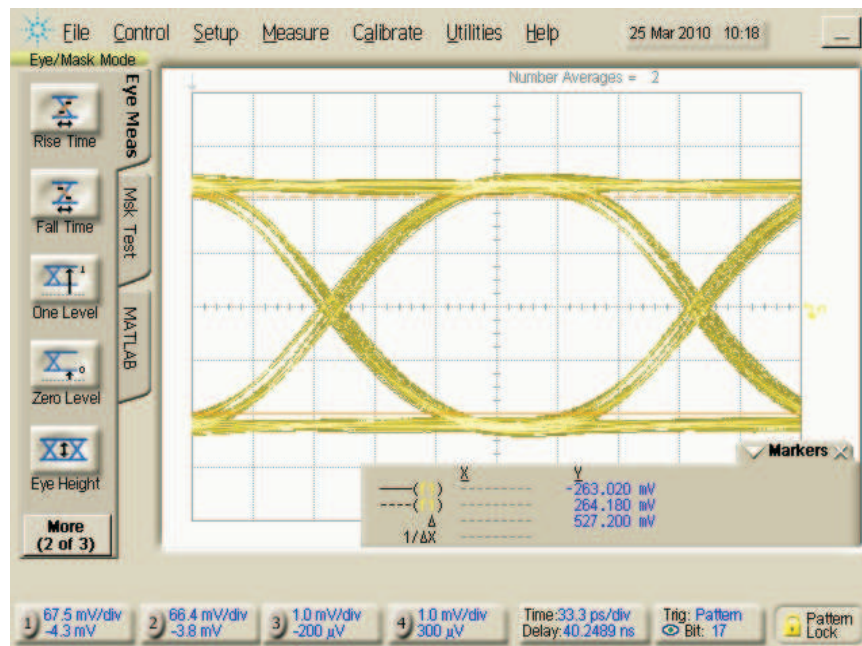

Figure 25. Input Trace = 20 Inches, 6 mil and Output Trace = 4 Inches, 6 mil

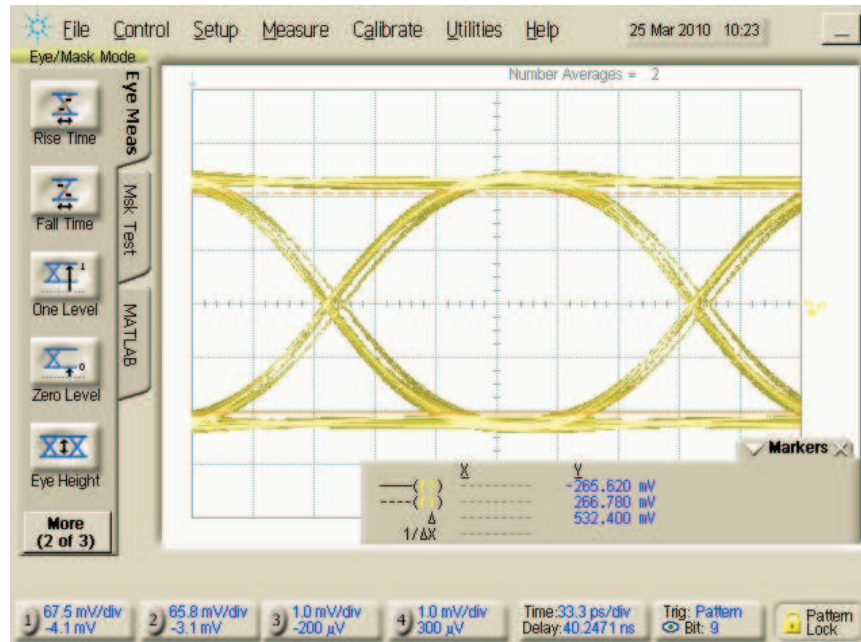

Figure 26. Input Trace = 28 Inches, 6 mil and Output Trace = 4 Inches, 6 mil

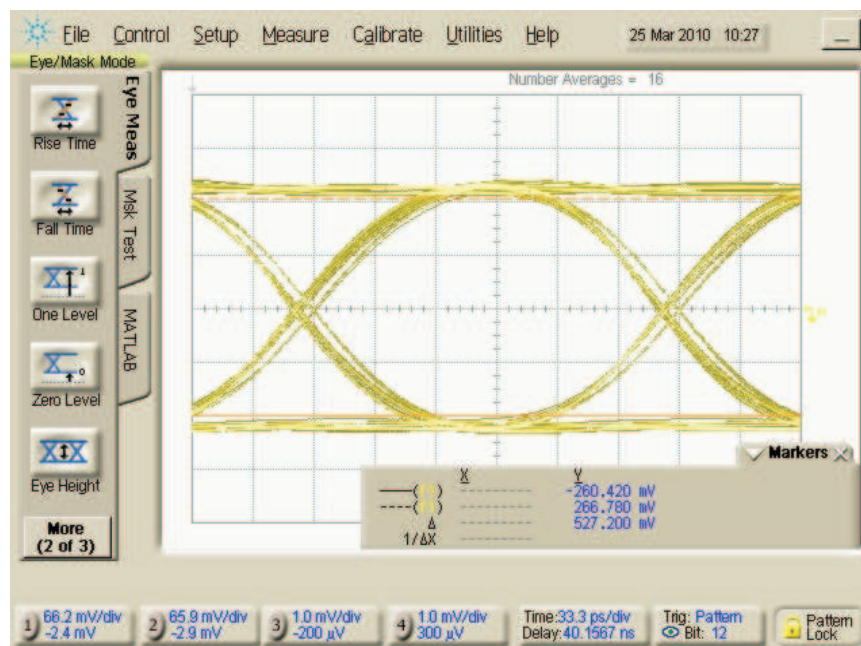

Figure 27. Input Trace = 32 Inches, 6 mil and Output Trace = 4 Inches, 6 mil

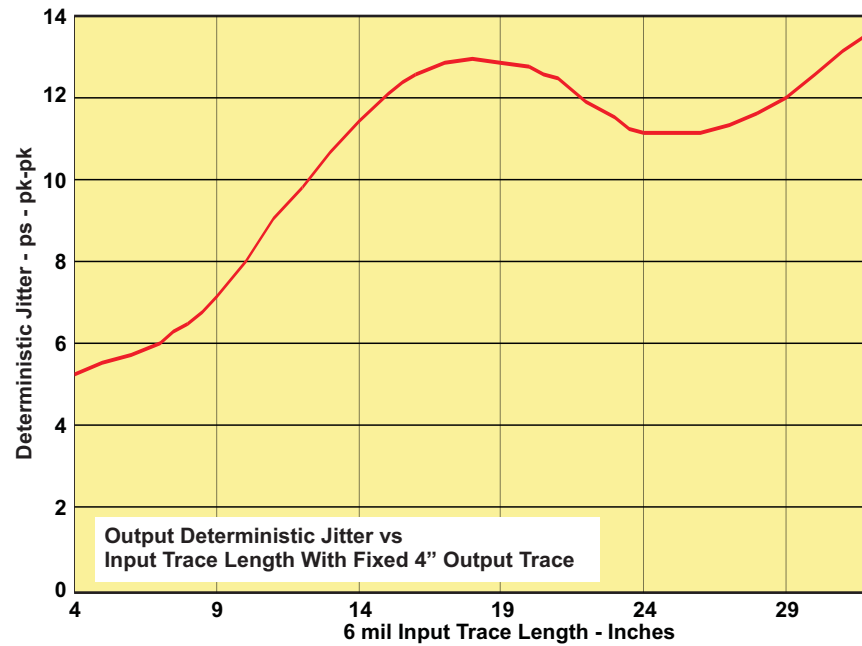

Figure 28. Jitter Performance Over Different Input Trace Lengths

REVISION HISTORY

Changes from Original (April 2010) to Revision A	Page
<hr/> <ul style="list-style-type: none">• Changed in Table 1. Pin Description, signals: TX1+, TX1-, TX2+ and TX2- , I/O types changed from O, CML to O, VML also in Descripton, 'CML' to 'VML' <hr/>	4

PACKAGING INFORMATION

Orderable part number	Status (1)	Material type (2)	Package Pins	Package qty Carrier	RoHS (3)	Lead finish/ Ball material (4)	MSL rating/ Peak reflow (5)	Op temp (°C)	Part marking (6)
SN65LVPE502RGER	NRND	Production	VQFN (RGE) 24	3000 LARGE T&R	Yes	NIPDAU	Level-2-260C-1 YEAR	0 to 85	LVPE502
SN65LVPE502RGER.B	NRND	Production	VQFN (RGE) 24	3000 LARGE T&R	Yes	NIPDAU	Level-2-260C-1 YEAR	0 to 85	LVPE502
SN65LVPE502RGET	NRND	Production	VQFN (RGE) 24	250 SMALL T&R	Yes	NIPDAU	Level-2-260C-1 YEAR	0 to 85	LVPE502
SN65LVPE502RGET.B	NRND	Production	VQFN (RGE) 24	250 SMALL T&R	Yes	NIPDAU	Level-2-260C-1 YEAR	0 to 85	LVPE502

(1) **Status:** For more details on status, see our [product life cycle](#).

(2) **Material type:** When designated, preproduction parts are prototypes/experimental devices, and are not yet approved or released for full production. Testing and final process, including without limitation quality assurance, reliability performance testing, and/or process qualification, may not yet be complete, and this item is subject to further changes or possible discontinuation. If available for ordering, purchases will be subject to an additional waiver at checkout, and are intended for early internal evaluation purposes only. These items are sold without warranties of any kind.

(3) **RoHS values:** Yes, No, RoHS Exempt. See the [TI RoHS Statement](#) for additional information and value definition.

(4) **Lead finish/Ball material:** Parts may have multiple material finish options. Finish options are separated by a vertical ruled line. Lead finish/Ball material values may wrap to two lines if the finish value exceeds the maximum column width.

(5) **MSL rating/Peak reflow:** The moisture sensitivity level ratings and peak solder (reflow) temperatures. In the event that a part has multiple moisture sensitivity ratings, only the lowest level per JEDEC standards is shown. Refer to the shipping label for the actual reflow temperature that will be used to mount the part to the printed circuit board.

(6) **Part marking:** There may be an additional marking, which relates to the logo, the lot trace code information, or the environmental category of the part.

Multiple part markings will be inside parentheses. Only one part marking contained in parentheses and separated by a "-" will appear on a part. If a line is indented then it is a continuation of the previous line and the two combined represent the entire part marking for that device.

Important Information and Disclaimer: The information provided on this page represents TI's knowledge and belief as of the date that it is provided. TI bases its knowledge and belief on information provided by third parties, and makes no representation or warranty as to the accuracy of such information. Efforts are underway to better integrate information from third parties. TI has taken and continues to take reasonable steps to provide representative and accurate information but may not have conducted destructive testing or chemical analysis on incoming materials and chemicals. TI and TI suppliers consider certain information to be proprietary, and thus CAS numbers and other limited information may not be available for release.

In no event shall TI's liability arising out of such information exceed the total purchase price of the TI part(s) at issue in this document sold by TI to Customer on an annual basis.

TAPE AND REEL INFORMATION

QUADRANT ASSIGNMENTS FOR PIN 1 ORIENTATION IN TAPE

*All dimensions are nominal

Device	Package Type	Package Drawing	Pins	SPQ	Reel Diameter (mm)	Reel Width W1 (mm)	A0 (mm)	B0 (mm)	K0 (mm)	P1 (mm)	W (mm)	Pin1 Quadrant
SN65LVPE502RGER	VQFN	RGE	24	3000	330.0	12.4	4.25	4.25	1.15	8.0	12.0	Q2
SN65LVPE502RGET	VQFN	RGE	24	250	180.0	12.4	4.25	4.25	1.15	8.0	12.0	Q2

TAPE AND REEL BOX DIMENSIONS

*All dimensions are nominal

Device	Package Type	Package Drawing	Pins	SPQ	Length (mm)	Width (mm)	Height (mm)
SN65LVPE502RGER	VQFN	RGE	24	3000	353.0	353.0	32.0
SN65LVPE502RGET	VQFN	RGE	24	250	213.0	191.0	35.0

GENERIC PACKAGE VIEW

RGE 24

VQFN - 1 mm max height

PLASTIC QUAD FLATPACK - NO LEAD



Images above are just a representation of the package family, actual package may vary.
Refer to the product data sheet for package details.

4204104/H

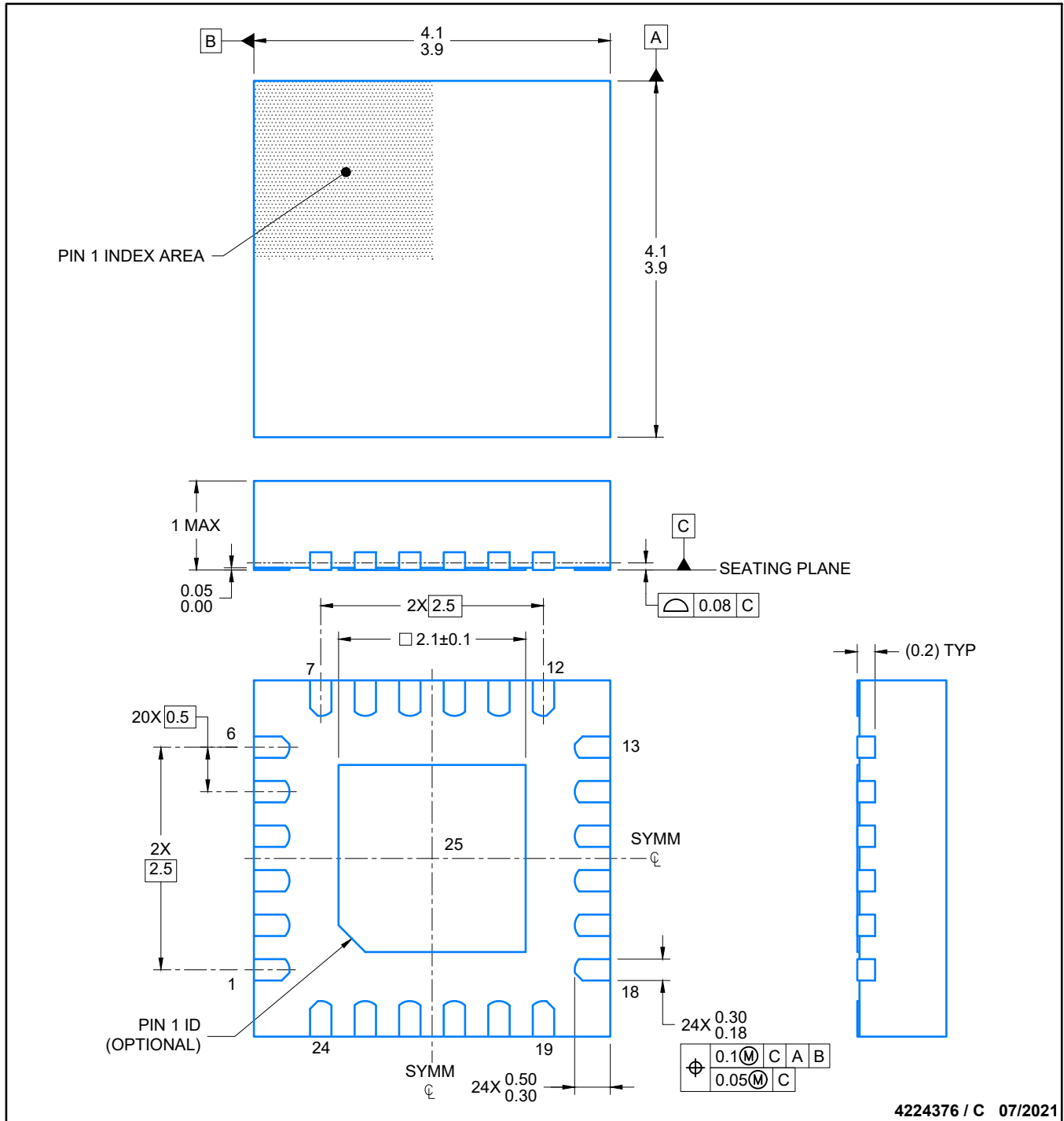

4224376 / C 07/2021

NOTES:

1. All linear dimensions are in millimeters. Any dimensions in parenthesis are for reference only. Dimensioning and tolerancing per ASME Y14.5M.
2. This drawing is subject to change without notice.
3. The package thermal pad must be soldered to the printed circuit board for thermal and mechanical performance.

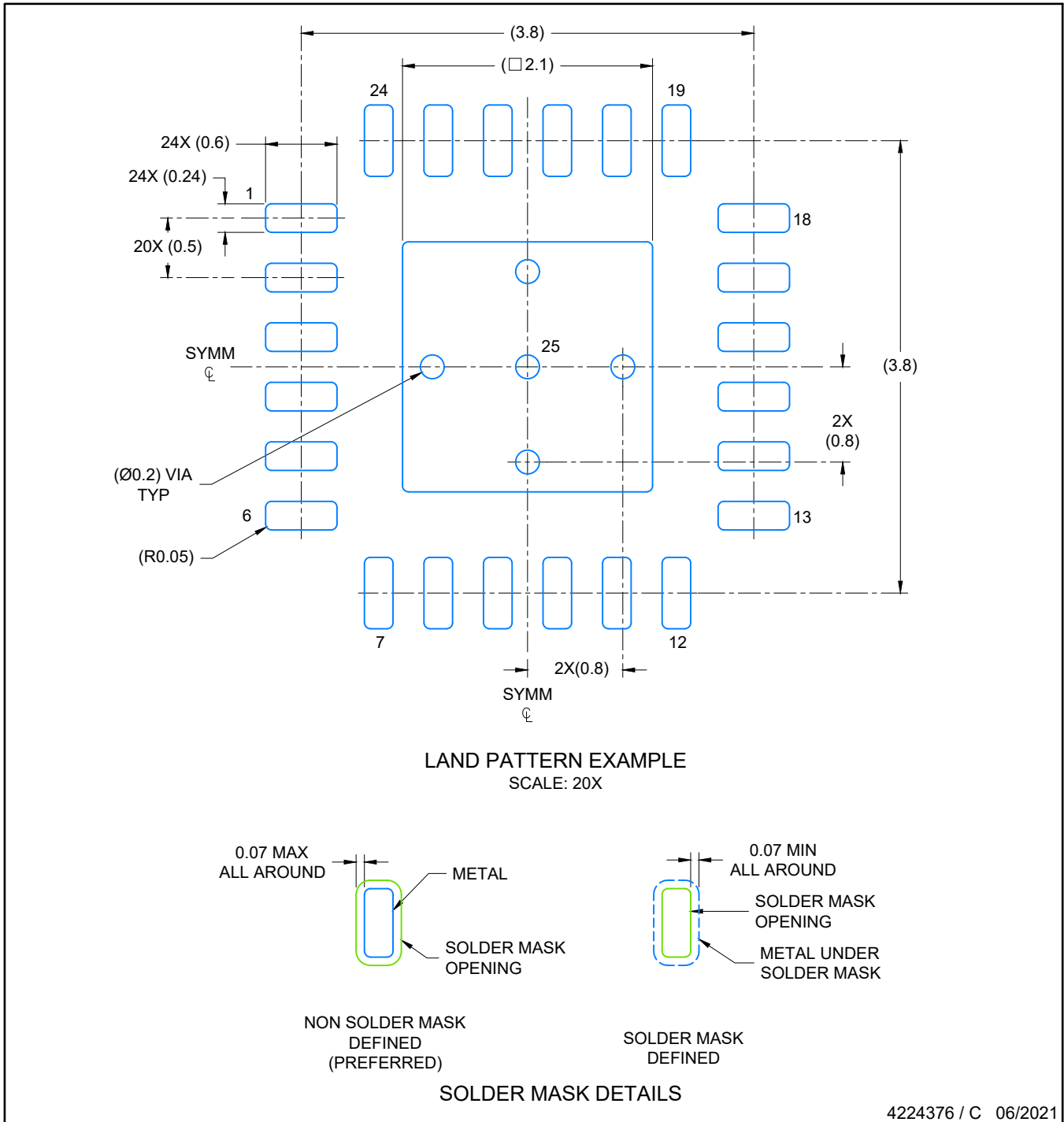

NOTES: (continued)

4. This package is designed to be soldered to a thermal pad on the board. For more information, see Texas Instruments literature number SLUA271 (www.ti.com/lit/slua271).
5. Solder mask tolerances between and around signal pads can vary based on board fabrication site.

EXAMPLE STENCIL DESIGN

RGE0024C

VQFN - 1 mm max height

PLASTIC QUAD FLATPACK- NO LEAD

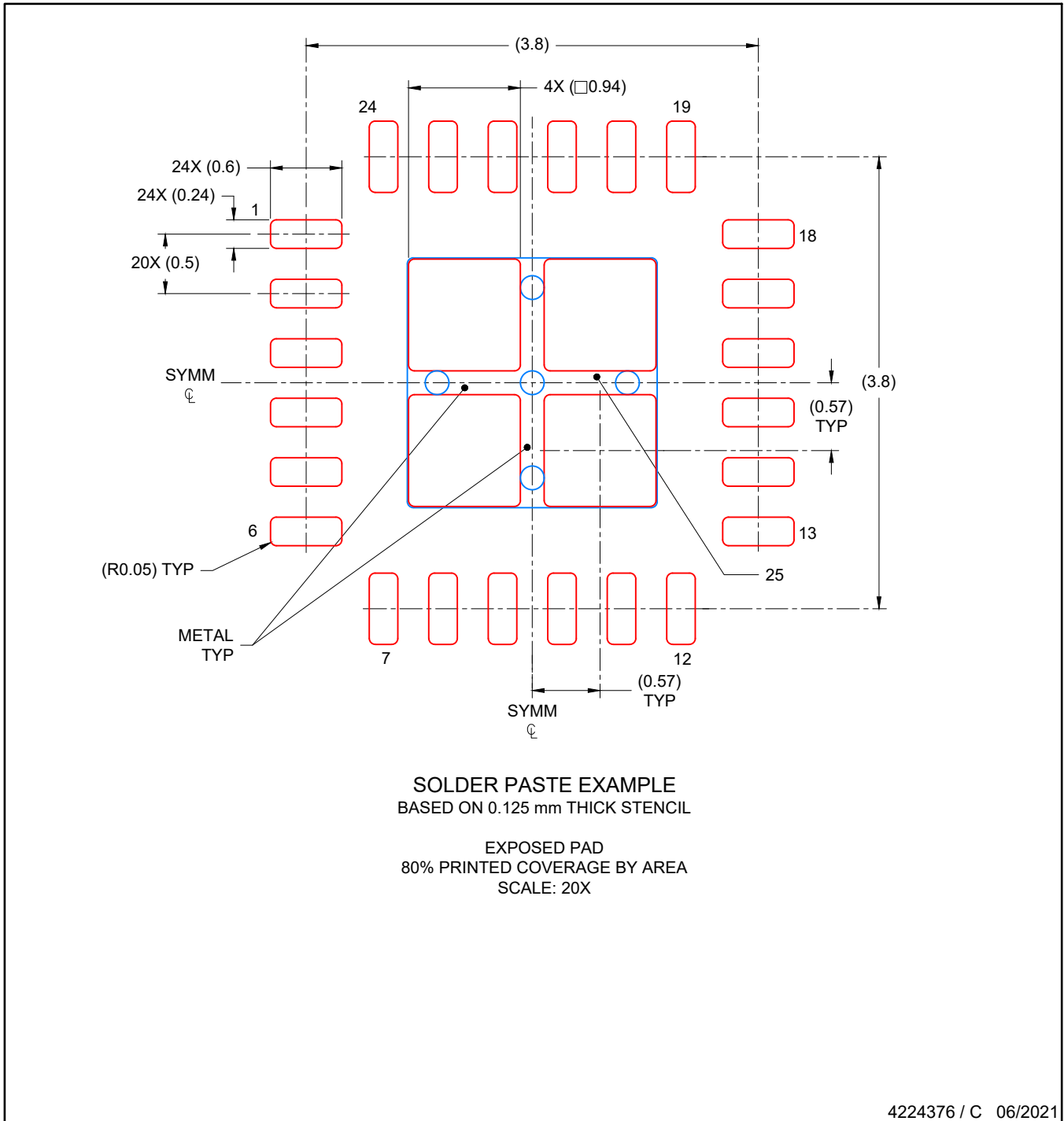

NOTES: (continued)

6. Laser cutting apertures with trapezoidal walls and rounded corners may offer better paste release. IPC-7525 may have alternate design recommendations..

IMPORTANT NOTICE AND DISCLAIMER

TI PROVIDES TECHNICAL AND RELIABILITY DATA (INCLUDING DATASHEETS), DESIGN RESOURCES (INCLUDING REFERENCE DESIGNS), APPLICATION OR OTHER DESIGN ADVICE, WEB TOOLS, SAFETY INFORMATION, AND OTHER RESOURCES "AS IS" AND WITH ALL FAULTS, AND DISCLAIMS ALL WARRANTIES, EXPRESS AND IMPLIED, INCLUDING WITHOUT LIMITATION ANY IMPLIED WARRANTIES OF MERCHANTABILITY, FITNESS FOR A PARTICULAR PURPOSE OR NON-INFRINGEMENT OF THIRD PARTY INTELLECTUAL PROPERTY RIGHTS.

These resources are intended for skilled developers designing with TI products. You are solely responsible for (1) selecting the appropriate TI products for your application, (2) designing, validating and testing your application, and (3) ensuring your application meets applicable standards, and any other safety, security, regulatory or other requirements.

These resources are subject to change without notice. TI grants you permission to use these resources only for development of an application that uses the TI products described in the resource. Other reproduction and display of these resources is prohibited. No license is granted to any other TI intellectual property right or to any third party intellectual property right. TI disclaims responsibility for, and you fully indemnify TI and its representatives against any claims, damages, costs, losses, and liabilities arising out of your use of these resources.

TI's products are provided subject to [TI's Terms of Sale](#), [TI's General Quality Guidelines](#), or other applicable terms available either on [ti.com](#) or provided in conjunction with such TI products. TI's provision of these resources does not expand or otherwise alter TI's applicable warranties or warranty disclaimers for TI products. Unless TI explicitly designates a product as custom or customer-specified, TI products are standard, catalog, general purpose devices.

TI objects to and rejects any additional or different terms you may propose.

Copyright © 2025, Texas Instruments Incorporated

Last updated 10/2025