

## SN65LVDS93A FlatLink™ 发送器

### 1 特性

- -40°C 至 85°C 的工业温度范围
- LVDS 显示 Serdes 接口，可直接连接至具有集成 LVDS 的 LCD 显示面板
- 封装选项：4.5mm × 7mm BGA 和 8.1mm × 14mm TSSOP
- 1.8V 至 3.3V 耐压数据输入，可直接连接至低功耗、低压应用和图形处理器
- 传输速率高达 135Mpps（百万像素/秒）；像素时钟频率范围为 10MHz 至 135MHz
- 适合 HVGA 到高清 (HD) 范围内的显示分辨率，并且电磁干扰 (EMI) 较低
- 通过 3.3V 单电源供电运行，75MHz 频率下的功耗为 170mW（典型值）
- 28 个数据通道和时钟输入低压 TTL 至 4 个数据通道和时钟输出低压差分
- 禁用时的功耗不到 1mW
- 可选择上升或下降时钟沿触发输入
- ESD: 5kV HBM
- 支持扩频时钟 (SSC)
- 兼容所有 OMAP™2x、OMAP3x 和 DaVinci™ 应用处理器

### 2 应用

- LCD 显示面板驱动器
- UMPC 和上网本
- 数码相框

### 3 说明

SN65LVDS93A LVDS SerDes（串行器/解串器）发送器在单个集成电路中包含 4 个 7 位并行负载串行输出移位寄存器、1 个 7 时钟合成器以及 5 个低电压差分信号 (LVDS) 驱动器。借助这些功能，可以通过 5 个平衡对导体同步传输 28 位单端 LVTTTL 数据并由兼容的接收器（如 SN65LVDS94）进行接收。

发送数据时，数据位 D0 至 D27 会在输入时钟信号 (CLKIN) 边沿全部加载到寄存器中。可通过时钟选择 (CLKSEL) 引脚来选择时钟的上升沿或下降沿。CLKIN 的频率会实现比率为 7 的倍增，然后用于以串行方式以 7 位时间片解除数据寄存器的负载。接着会将 4 个串行数据流和锁相时钟 (CLKOUT) 输出至 LVDS 输出驱动器。CLKOUT 的频率与输入时钟 (CLKIN) 相同。

#### 器件信息<sup>(1)</sup>

器件型号	封装	封装尺寸 (标称值)
SN65LVDS93A	TSSOP (56)	14.00mm × 6.10mm
	BGA MICROSTAR JUNIOR (56)	7.00mm × 4.50mm

(1) 要了解所有可用封装，请见数据表末尾的可订购产品附录。

### 使用分立式 LVDS TX 的 RGB 视频系统

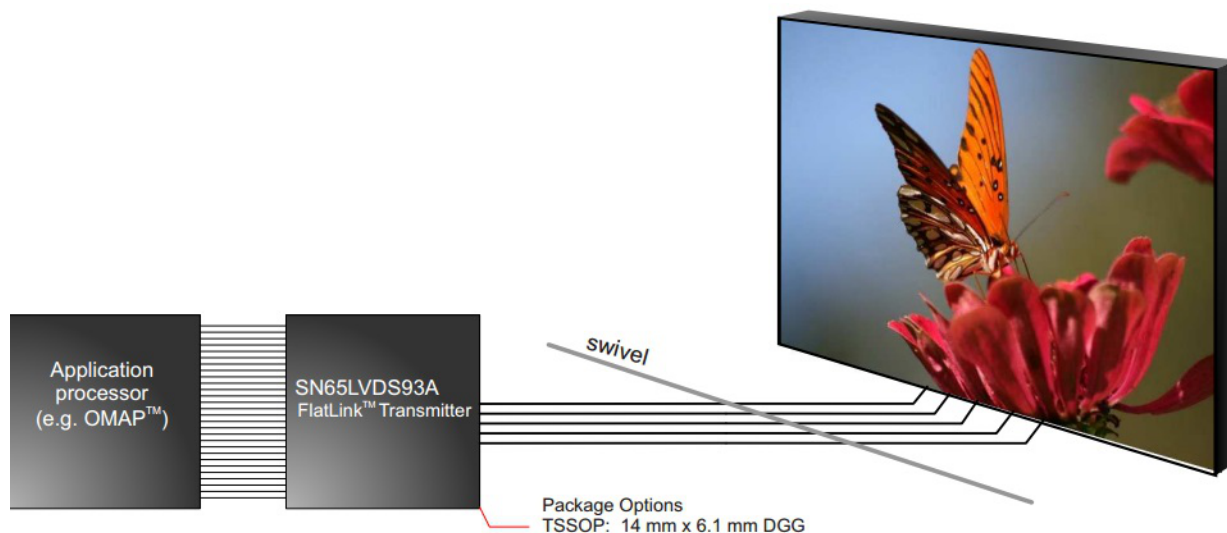

## 目录

<p><b>1</b> 特性 ..... 1</p> <p><b>2</b> 应用 ..... 1</p> <p><b>3</b> 说明 ..... 1</p> <p><b>4</b> 修订历史记录 ..... 2</p> <p><b>5</b> 说明 (续) ..... 3</p> <p><b>6 Pin Configuration and Functions</b> ..... 3</p> <p><b>7 Specifications</b> ..... 7</p> <p style="padding-left: 20px;">7.1 Absolute Maximum Ratings ..... 7</p> <p style="padding-left: 20px;">7.2 ESD Ratings ..... 7</p> <p style="padding-left: 20px;">7.3 Recommended Operating Conditions ..... 7</p> <p style="padding-left: 20px;">7.4 Thermal Information ..... 7</p> <p style="padding-left: 20px;">7.5 Electrical Characteristics ..... 8</p> <p style="padding-left: 20px;">7.6 Timing Requirements ..... 8</p> <p style="padding-left: 20px;">7.7 Switching Characteristics ..... 9</p> <p style="padding-left: 20px;">7.8 Typical Characteristics ..... 11</p> <p><b>8 Parameter Measurement Information</b> ..... 12</p> <p><b>9 Detailed Description</b> ..... 16</p> <p style="padding-left: 20px;">9.1 Overview ..... 16</p>	<p style="padding-left: 20px;">9.2 Functional Block Diagram ..... 16</p> <p style="padding-left: 20px;">9.3 Feature Description ..... 17</p> <p style="padding-left: 20px;">9.4 Device Functional Modes ..... 18</p> <p><b>10 Application and Implementation</b> ..... 19</p> <p style="padding-left: 20px;">10.1 Application Information ..... 19</p> <p style="padding-left: 20px;">10.2 Typical Application ..... 19</p> <p><b>11 Power Supply Recommendations</b> ..... 26</p> <p><b>12 Layout</b> ..... 26</p> <p style="padding-left: 20px;">12.1 Layout Guidelines ..... 26</p> <p style="padding-left: 20px;">12.2 Layout Example ..... 28</p> <p><b>13 器件和文档支持</b> ..... 30</p> <p style="padding-left: 20px;">13.1 文档支持 ..... 30</p> <p style="padding-left: 20px;">13.2 接收文档更新通知 ..... 30</p> <p style="padding-left: 20px;">13.3 社区资源 ..... 30</p> <p style="padding-left: 20px;">13.4 商标 ..... 30</p> <p style="padding-left: 20px;">13.5 静电放电警告 ..... 30</p> <p style="padding-left: 20px;">13.6 Glossary ..... 30</p> <p><b>14 机械、封装和可订购信息</b> ..... 30</p>
---	--

## 4 修订历史记录

注：之前版本的页码可能与当前版本有所不同。

### Changes from Revision A (August 2011) to Revision B

Page

<ul style="list-style-type: none"> <li>• 已添加 添加了引脚配置和功能 部分、ESD 额定值表、特性 说明 部分、器件功能模式、应用和实施 部分、电源建议 部分、布局 部分、器件和文档支持 部分以及机械、封装和可订购信息 部分 ..... 1</li> </ul>	1
--	---

## 5 说明 (续)

SN65LVDS93A 器件无需外部组件，只需很少控制，甚至无需控制。发送器输入端的数据总线与接收器输出端的数据总线相同，数据传输对于用户而言是透明的。用户唯一能够干预的是选择时钟上升沿（向 CLKSEL 输入高电平）或下降沿（向 CLKSEL 输入低电平），以及能够使用关断/清零 (SHTDN) 信号。SHTDN 是一个低电平有效输入，可禁用时钟并关断 LVDS 输出驱动器，从而降低功耗。如果该信号为低电平，则可以清除所有内部寄存器（处于低电平）。

SN65LVDS93A 在环境空气中的工作温度范围为 -40°C 至 85°C。

## 6 Pin Configuration and Functions

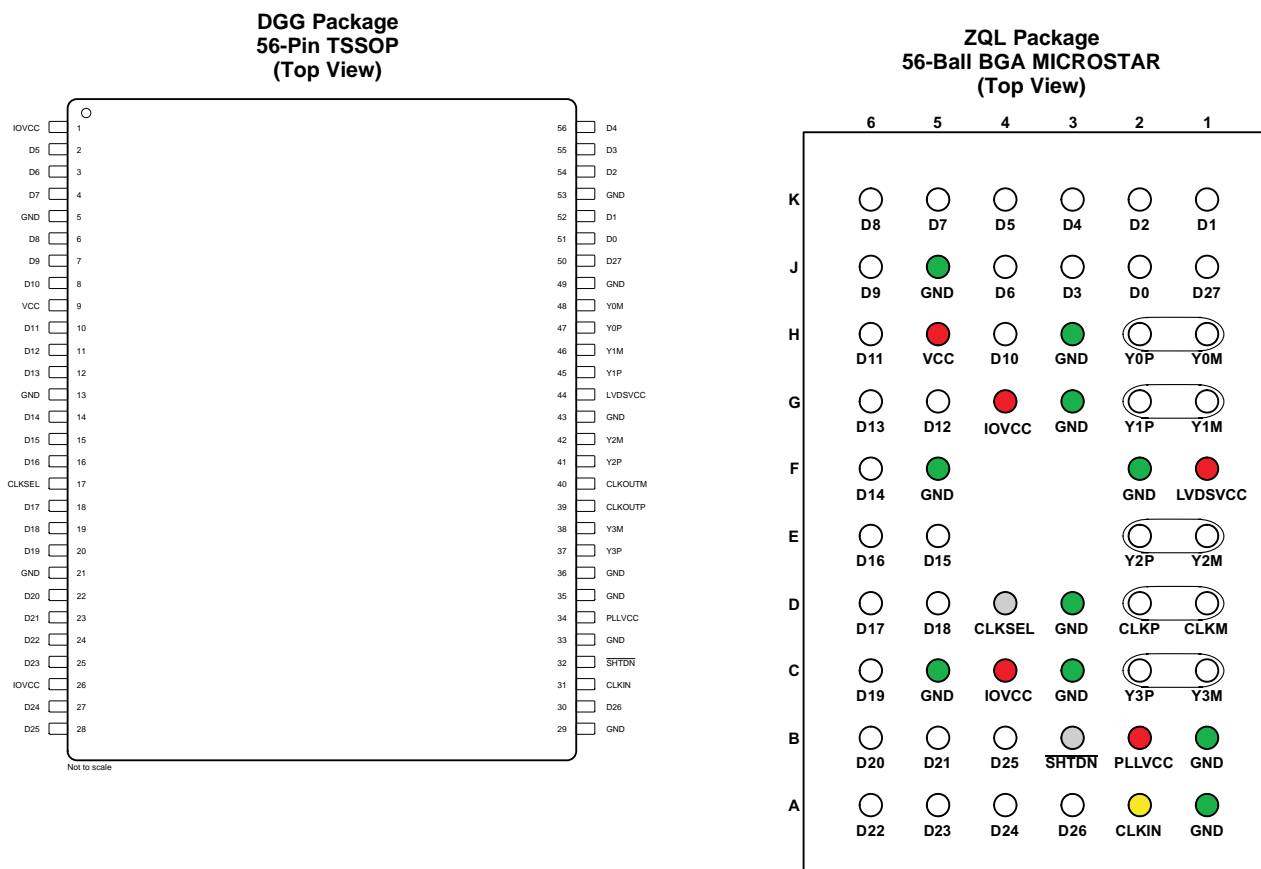

**Pin Functions - TSSOP**

PIN		I/O	DESCRIPTION
NAME	NO.		
CLKSEL	17	I	Selects between rising edge input clock trigger (CLKSEL = V <sub>IH</sub> ) and falling edge input clock trigger (CLKSEL = V <sub>IL</sub> ).
CLKIN	31	I	Input pixel clock; rising or falling clock polarity is selectable by Control input CLKSEL.
CLKOUTM	40	O	Differential LVDS pixel clock output. Output is high-impedance when $\overline{\text{SHTDN}}$ is pulled low (de-asserted).
CLKOUTP	39	O	
D0	51	I	Data inputs; supports 1.8-V to 3.3-V input voltage selectable by VDD supply. To connect a graphic source successfully to a display, the bit assignment of D[27:0] is critical (and not necessarily intuitive). Note: if application only requires 18-bit color, connect unused inputs D5, D10, D11, D16, D17, D23, and D27 to GND
D1	52		
D2	54		
D3	55		
D4	56		
D5	2		
D6	3		
D7	4		
D8	6		
D9	7		
D10	8		
D11	10		
D12	11		
D13	12		
D14	14		
D15	15		
D16	16		
D17	18		
D18	19		
D19	20		
D20	22		
D21	23		
D22	24		
D23	25		
D24	27		
D25	28		
D26	30		
D27	50		
GND	5, 13, 21, 29, 33, 35, 36, 43, 49, 53	Power Supply <sup>(1)</sup>	Supply Ground for VCC, IOVCC, LVDSVCC, and PLLVCC.
IOVCC	1, 26		I/O supply reference voltage (1.8 V up to 3.3 V matching the GPU data output signal swing)
LVDSVCC	44		3.3-V LVDS output analog supply
PLLVCC	34		3.3-V PLL analog supply
$\overline{\text{SHTDN}}$	32	I	Device shut down; pull low (de-assert) to shut down the device (low power, resets all registers) and high (assert) for normal operation.
VCC	9	Power Supply <sup>(1)</sup>	3.3-V digital supply voltage
Y0M	48	O	Differential LVDS data outputs. Outputs are high-impedance when $\overline{\text{SHTDN}}$ is pulled low (de-asserted)
Y1M	46		
Y2M	42		
Y0P	47		
Y1P	45		
Y2P	41		
Y3M	38	O	Differential LVDS Data outputs. Output is high-impedance when $\overline{\text{SHTDN}}$ is pulled low (de-asserted). Note: if the application only requires 18-bit color, this output can be left open.
Y3P	37		

(1) For a multilayer pcb, TI recommends keeping one common GND layer underneath the device and connecting all ground terminals directly to this plane.

**Pin Functions - BGA MICROSTAR**

BALL		I/O	DESCRIPTION
NAME	NO.		
CLKIN	A2	CMOS IN with pulldn	Input pixel clock; rising or falling clock polarity is selectable by Control input CLKSEL.
CLKM	D1	LVDS Out	Differential LVDS pixel clock output. Output is high-impedance when $\overline{\text{SHTDN}}$ is pulled low (de-asserted).
CLKP	D2		
CLKSEL	D4	CMOS IN with pulldn	Selects between rising edge input clock trigger (CLKSEL = $V_{IH}$ ) and falling edge input clock trigger (CLKSEL = $V_{IL}$ ).
D0	J2	CMOS IN with pulldn	Data inputs; supports 1.8-V to 3.3-V input voltage selectable by VDD supply. To connect a graphic source successfully to a display, the bit assignment of D[27:0] is critical (and not necessarily intuitive). Note: if application only requires 18-bit color, connect unused inputs D5, D10, D11, D16, D17, D23, and D27 to GND.
D1	K1		
D2	K2		
D3	J3		
D4	K3		
D5	K4		
D6	J4		
D7	K5		
D8	K6		
D9	J6		
D10	H4		
D11	H6		
D12	G5		
D13	G6		
D14	F6		
D15	E5		
D16	E6		
D17	D6		
D18	D5		
D19	C6		
D20	B6		
D21	B5		
D22	A6		
D23	A5		
D24	A4		
D25	B4		
D26	A3		
D27	J1		
GND	A1, B1, C3, C5, F2, F5, J5, D3, G3, H3	Power Supply <sup>(1)</sup>	Supply Ground for VCC, IOVCC, LVDSVCC, and PLLVCC.
IOVCC	C4, G4		I/O supply reference voltage (1.8 V up to 3.3 V matching the GPU data output signal swing)
LVDSVCC	F1		3.3-V LVDS output analog supply
PLLVCC	B2		3.3-V PLL analog supply
$\overline{\text{SHTDN}}$	B3	CMOS IN with pulldn	Device shut down; pull low (de-assert) to shut down the device (low power, resets all registers) and high (assert) for normal operation.
VCC	H5	Power Supply <sup>(1)</sup>	3.3-V digital supply voltage

(1) For a multilayer pcb, it is recommended to keep one common GND layer underneath the device and connect all ground terminals directly to this plane.

**Pin Functions - BGA MICROSTAR (continued)**

BALL		I/O	DESCRIPTION
NAME	NO.		
Y0M	H1	LVDS Out	Differential LVDS data outputs. Outputs are high-impedance when $\overline{\text{SHTDN}}$ is pulled low (de-asserted)
Y1M	G1		
Y2M	E1		
Y0P	H2		
Y1P	G2		
Y2P	E2		
Y3M	C1	LVDS Out	Differential LVDS Data outputs. Output is high-impedance when $\overline{\text{SHTDN}}$ is pulled low (de-asserted). Note: if the application only requires 18-bit color, this output can be left open.
Y3P	C2		
--	E3, E4, F3, F4	–	Not connected

## 7 Specifications

### 7.1 Absolute Maximum Ratings<sup>(1)</sup>

	MIN	MAX	UNIT
Supply voltage, VCC, IOVCC, LVDSVCC, PLLVCC <sup>(2)</sup>	–0.5	4	V
Voltage at any output terminal	–0.5	VCC + 0.5	V
Voltage at any input terminal	–0.5	IOVCC + 0.5	V
Continuous power dissipation	See <a href="#">Thermal Information</a>		
Storage temperature, T <sub>stg</sub>	–65	150	°C

- (1) Stresses beyond those listed under *Absolute Maximum Ratings* may cause permanent damage to the device. These are stress ratings only, which do not imply functional operation of the device at these or any other conditions beyond those indicated under *Recommended Operating Conditions*. Exposure to absolute-maximum-rated conditions for extended periods may affect device reliability.
- (2) All voltages are with respect to the GND terminals.

### 7.2 ESD Ratings

		VALUE	UNIT
V <sub>(ESD)</sub> Electrostatic discharge	Human body model (HBM), per ANSI/ESDA/JEDEC JS-001 <sup>(1)</sup>	±4000	V
	Charged-device model (CDM), per JEDEC specification JESD22-C101 <sup>(2)</sup>	±500	

- (1) JEDEC document JEP155 states that 500-V HBM allows safe manufacturing with a standard ESD control process.
- (2) JEDEC document JEP157 states that 250-V CDM allows safe manufacturing with a standard ESD control process.

### 7.3 Recommended Operating Conditions

over operating free-air temperature range (unless otherwise noted)

PARAMETER		MIN	NOM	MAX	UNIT
Supply voltage, VCC		3	3.3	3.6	V
LVDS output supply voltage, LVDSVCC		3	3.3	3.6	
PLL analog supply voltage, PLLVCC		3	3.3	3.6	
IO input reference supply voltage, IOVCC		1.62	1.8 / 2.5 / 3.3	3.6	
Power supply noise on any VCC terminal					
High-level input voltage, V <sub>IH</sub>	IOVCC = 1.8 V	IOVCC/2 + 0.3 V		V	
	IOVCC = 2.5 V	IOVCC/2 + 0.4 V			
	IOVCC = 3.3 V	IOVCC/2 + 0.5 V			
Low-level input voltage, V <sub>IL</sub>	IOVCC = 1.8 V	IOVCC/2 – 0.3 V		V	
	IOVCC = 2.5 V	IOVCC/2 – 0.4 V			
	IOVCC = 3.3 V	IOVCC/2 – 0.5 V			
Differential load impedance, Z <sub>L</sub>		90			Ω
Operating free-air temperature, T <sub>A</sub>		–45			°C

### 7.4 Thermal Information

THERMAL METRIC <sup>(1)</sup>		SN65LVDS93B	UNIT
		DGG (TSSOP)	
		56 PINS	
R <sub>θJA</sub>	Junction-to-ambient thermal resistance	62.1	°C/W
R <sub>θJC(top)</sub>	Junction-to-case (top) thermal resistance	18.4	°C/W
R <sub>θJB</sub>	Junction-to-board thermal resistance	31.1	°C/W
Ψ <sub>JT</sub>	Junction-to-top characterization parameter	0.8	°C/W
Ψ <sub>JB</sub>	Junction-to-board characterization parameter	30.8	°C/W

- (1) For more information about traditional and new thermal metrics, see the [Semiconductor and IC Package Thermal Metrics](#) application report.

## 7.5 Electrical Characteristics

over operating free-air temperature range (unless otherwise noted)

PARAMETER		TEST CONDITIONS	MIN	TYP	MAX	UNIT	
$V_T$	Input voltage threshold			IOVCC/2		V	
$ V_{OD} $	Differential steady-state output voltage magnitude	$R_L = 100 \Omega$ , See <a href="#">图 7</a>	250		450	mV	
$\Delta V_{OD} $	Change in the steady-state differential output voltage magnitude between opposite binary states			1	35	mV	
$V_{OC(SS)}$	Steady-state common-mode output voltage	See <a href="#">图 7</a>	1.125		1.375	V	
$V_{OC(PP)}$	Peak-to-peak common-mode output voltage	$t_{R/F} (Dx, CLKIN) = 1 \text{ ns}$			35	mV	
$I_{IH}$	High-level input current	$V_{IH} = IOVCC$			25	$\mu\text{A}$	
$I_{IL}$	Low-level input current	$V_{IL} = 0 \text{ V}$			$\pm 10$	$\mu\text{A}$	
$I_{OS}$	Short-circuit output current	$V_{OY} = 0 \text{ V}$			$\pm 24$	mA	
		$V_{OD} = 0 \text{ V}$			$\pm 12$	mA	
$I_{OZ}$	High-impedance state output current	$V_O = 0 \text{ V to VCC}$			$\pm 20$	$\mu\text{A}$	
$R_{pdn}$	Input pulldown integrated resistor on all inputs (Dx, CLKSEL, SHTDN, CLKIN)	IOVCC = 1.8 V		200		k $\Omega$	
		IOVCC = 3.3 V		100			
$I_Q$	Quiescent current	Disabled, all inputs at GND; SHTDN = $V_{IL}$		10	100	$\mu\text{A}$	
$I_{CC}$	Supply current (average)	SHTDN = $V_{IH}$ , $R_L = 100 \Omega$ (5 places), grayscale pattern ( <a href="#">图 8</a> ) VCC = 3.3 V, $f_{CLK} = 75 \text{ MHz}$		51.9		mA	
		$I_{(VCC)} + I_{(PLL VCC)} + I_{(LVDS VCC)}$					
		$I_{(IOVCC)}$ with IOVCC = 3.3 V		0.4			
		$I_{(IOVCC)}$ with IOVCC = 1.8 V		0.1			
		SHTDN = $V_{IH}$ , $R_L = 100 \Omega$ (5 places), worst-case pattern ( <a href="#">图 9</a> ), VCC = 3.6 V, $f_{CLK} = 75 \text{ MHz}$					mA
		$I_{(VCC)} + I_{(PLL VCC)} + I_{(LVDS VCC)}$		63.7			
		$I_{(IOVCC)}$ with IOVCC = 3.3 V		1.3			
		$I_{(IOVCC)}$ with IOVCC = 1.8 V		0.5			
		SHTDN = $V_{IH}$ , $R_L = 100 \Omega$ (5 places), worst-case pattern ( <a href="#">图 9</a> ), $f_{CLK} = 85 \text{ MHz}$					mA
		$I_{(VCC)} + I_{(PLL VCC)} + I_{(LVDS VCC)}$		75.1			
$I_{(IOVCC)}$ with IOVCC = 3.6 V		1.5					
$I_{(IOVCC)}$ with IOVCC = 1.8 V		0.6					
$C_1$	Input capacitance			2		pF	

## 7.6 Timing Requirements

		MIN	MAX	UNIT
Input clock period, $t_c$		7.4	100	ns
Input clock modulation	w/ modulation frequency 30 kHz		8%	
	w/ modulation frequency 50 kHz		6%	
High-level input clock pulse width duration, $t_w$		$0.4 t_c$	$0.6 t_c$	ns
Input signal transition time, $t_t$			3	ns
Data set up time, D0 through D27 before CLKIN (See <a href="#">图 6</a> )		2		ns
Data hold time, D0 through D27 after CLKIN		0.8		ns



## 7.7 Switching Characteristics

over operating free-air temperature range (unless otherwise noted)

		TEST CONDITIONS	MIN	TYP <sup>(1)</sup>	MAX	UNIT
$t_0$	Delay time, CLKOUT $\uparrow$ after Yn valid (serial bit position 0, equal D1, D9, D20, D5)	See <a href="#">图 10</a> , $t_C = 10$ ns,  Input clock jitter  < 25 ps <sup>(2)</sup>	-0.1	0	0.1	ns
$t_1$	Delay time, CLKOUT $\uparrow$ after Yn valid (serial bit position 1, equal D0, D8, D19, D27)		$1/7 t_C - 0.1$		$1/7 t_C + 0.1$	ns
$t_2$	Delay time, CLKOUT $\uparrow$ after Yn valid (serial bit position 2, equal D7, D18, D26, D23)		$2/7 t_C - 0.1$		$2/7 t_C + 0.1$	ns
$t_3$	Delay time, CLKOUT $\uparrow$ after Yn valid (serial bit position 3, equal D6, D15, D25, D17)		$3/7 t_C - 0.1$		$3/7 t_C + 0.1$	ns
$t_4$	Delay time, CLKOUT $\uparrow$ after Yn valid (serial bit position 4, equal D4, D14, D24, D16)		$4/7 t_C - 0.1$		$4/7 t_C + 0.1$	ns
$t_5$	Delay time, CLKOUT $\uparrow$ after Yn valid (serial bit position 5, equal D3, D13, D22, D11)		$5/7 t_C - 0.1$		$5/7 t_C + 0.1$	ns
$t_6$	Delay time, CLKOUT $\uparrow$ after Yn valid (serial bit position 6, equal D2, D12, D21, D10)		$6/7 t_C - 0.1$		$6/7 t_C + 0.1$	ns
$t_{c(o)}$	Output clock period			$t_C$		ns
$\Delta t_{c(o)}$	Output clock cycle-to-cycle jitter <sup>(3)</sup>	$t_C = 10$ ns; clean reference clock, see <a href="#">图 11</a>		$\pm 26$		ps
		$t_C = 10$ ns with 0.05UI added noise modulated at 3 MHz, see <a href="#">图 11</a>		$\pm 44$		
		$t_C = 7.4$ ns; clean reference clock, see <a href="#">图 11</a>		$\pm 35$		
		$t_C = 7.4$ ns with 0.05UI added noise modulated at 3 MHz, see <a href="#">图 11</a>		$\pm 42$		
$t_w$	High-level output clock pulse duration			$4/7 t_C$		ns
$t_{r/f}$	Differential output voltage transition time ( $t_r$ or $t_f$ )	See <a href="#">图 7</a>		225	500	ps
$t_{en}$	Enable time, $\overline{\text{SHTDN}}\uparrow$ to phase lock (Yn valid)	$f_{(clk)} = 135$ MHz, See <a href="#">图 12</a>		6		$\mu\text{s}$
$t_{dis}$	Disable time, $\overline{\text{SHTDN}}\downarrow$ to off-state (CLKOUT high-impedance)	$f_{(clk)} = 135$ MHz, See <a href="#">图 13</a>		7		ns

(1) All typical values are at  $V_{CC} = 3.3\text{V}$ ,  $T_A = 25^\circ\text{C}$ .

(2) |Input clock jitter| is the magnitude of the change in the input clock period.

(3) The output clock cycle-to-cycle jitter is the largest recorded change in the output clock period from one cycle to the next cycle observed over 15,000 cycles. Tektronix TDSJIT3 Jitter Analysis software was used to derive the maximum and minimum jitter value.

SN65LVDS93A

ZHCSHV8B – AUGUST 2009 – REVISED MARCH 2015

www.ti.com.cn



图 1. Typical SN65LVDS93A Load and Shift Sequences

### 7.8 Typical Characteristics



## 8 Parameter Measurement Information

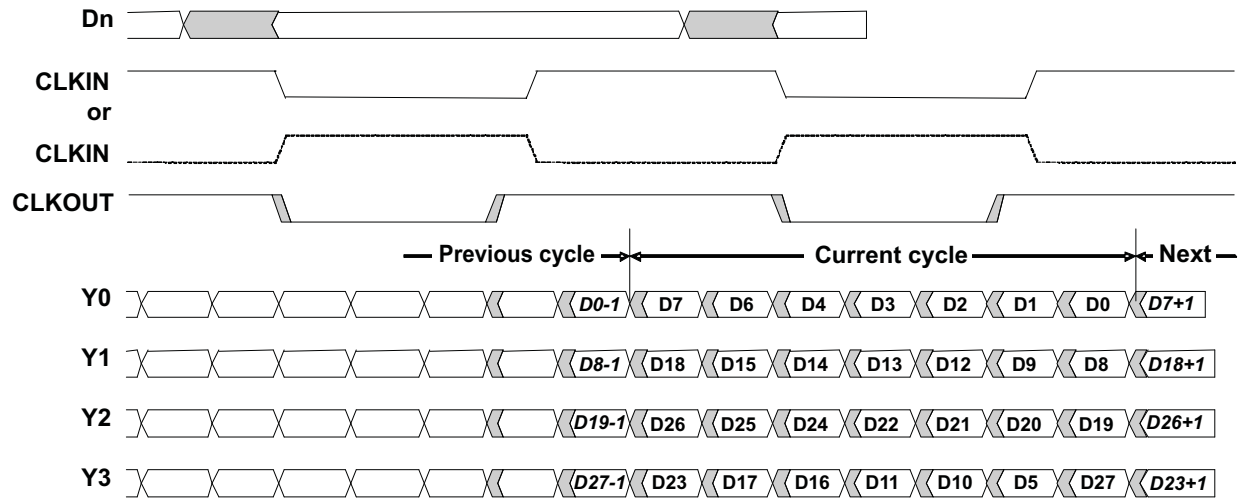
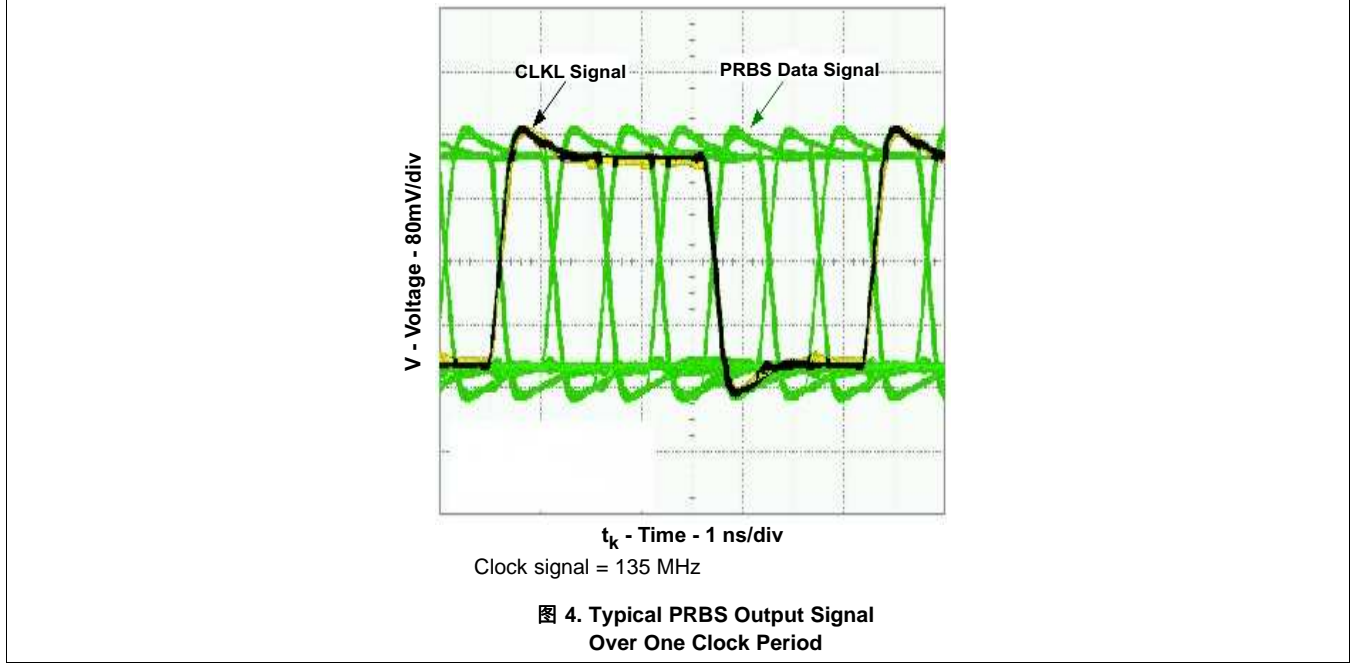
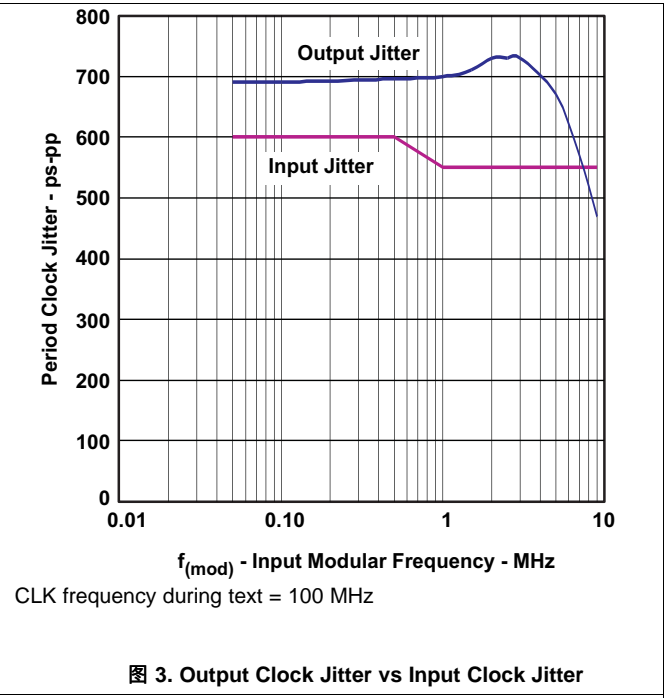
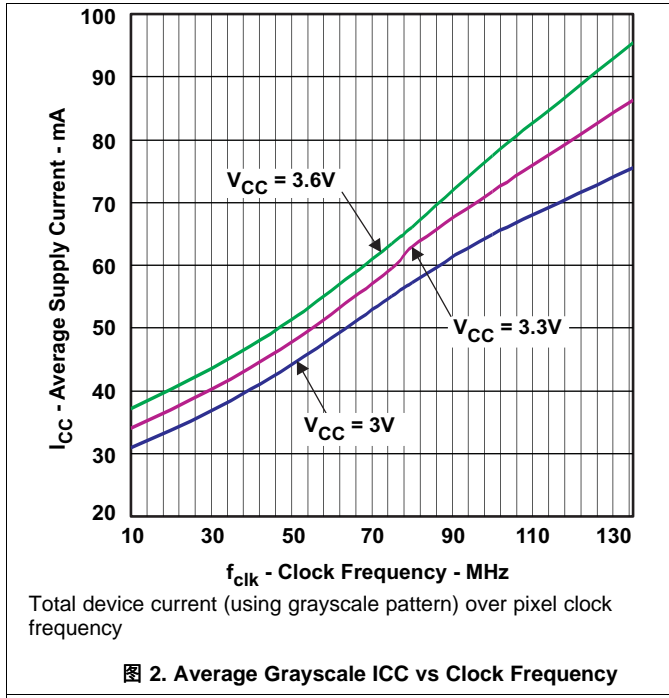

图 5. Equivalent Input and Output Schematic Diagrams



All input timing is defined at  $IOVDD / 2$  on an input signal with a 10% to 90% rise or fall time of less than 3 ns. CLKSEL = 0V.

图 6. Setup and Hold Time Definition

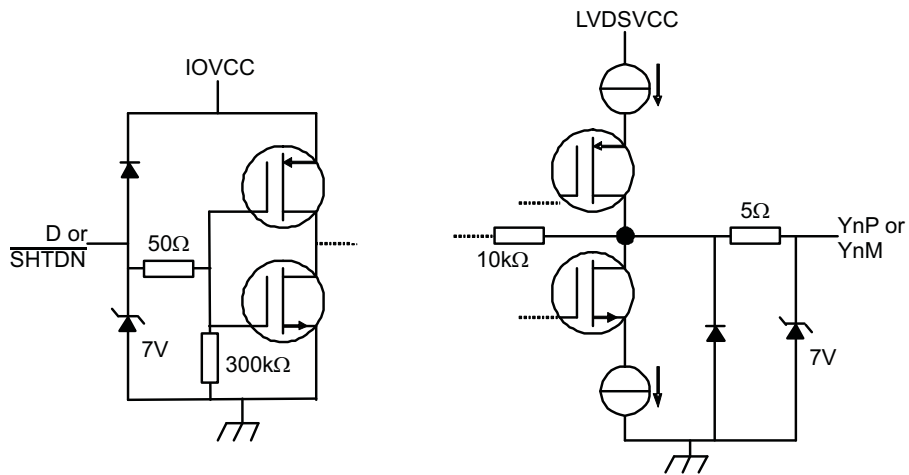
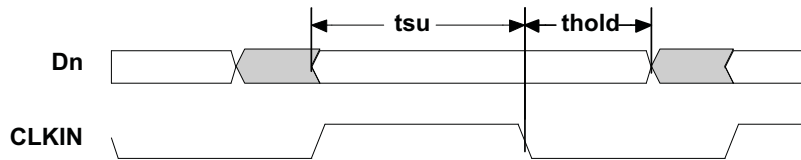
Parameter Measurement Information (接下页)



图 7. Test Load and Voltage Definitions for LVDS Outputs



The 16 grayscale test pattern test device power consumption for a typical display pattern.

图 8. 16 Grayscale Test Pattern

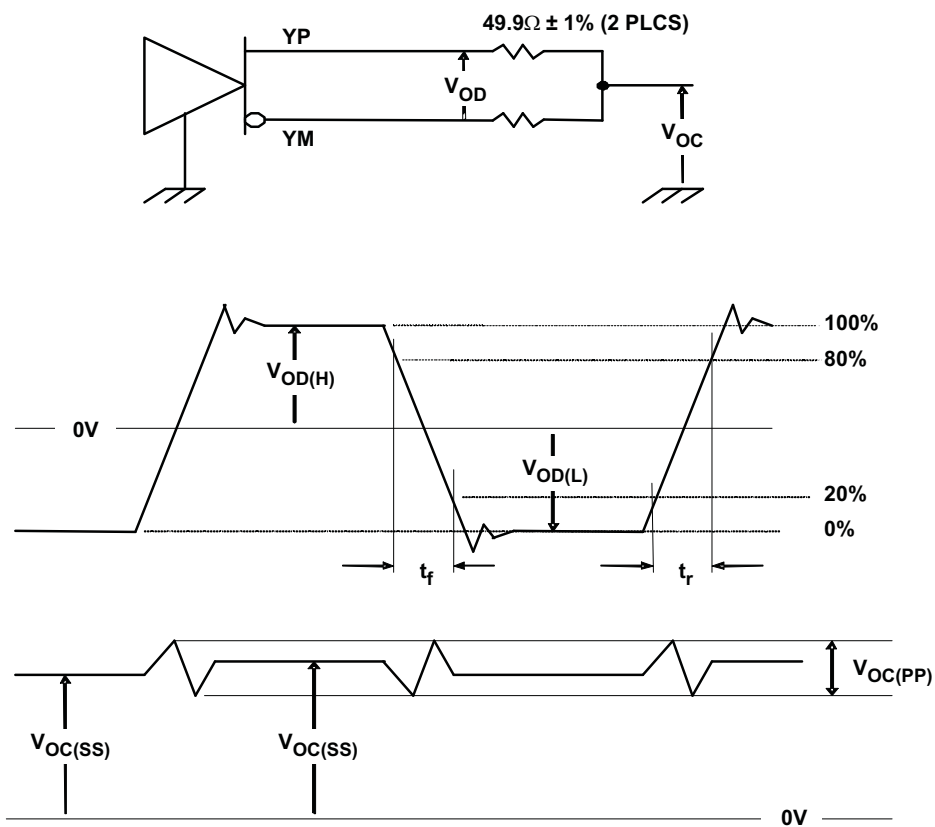
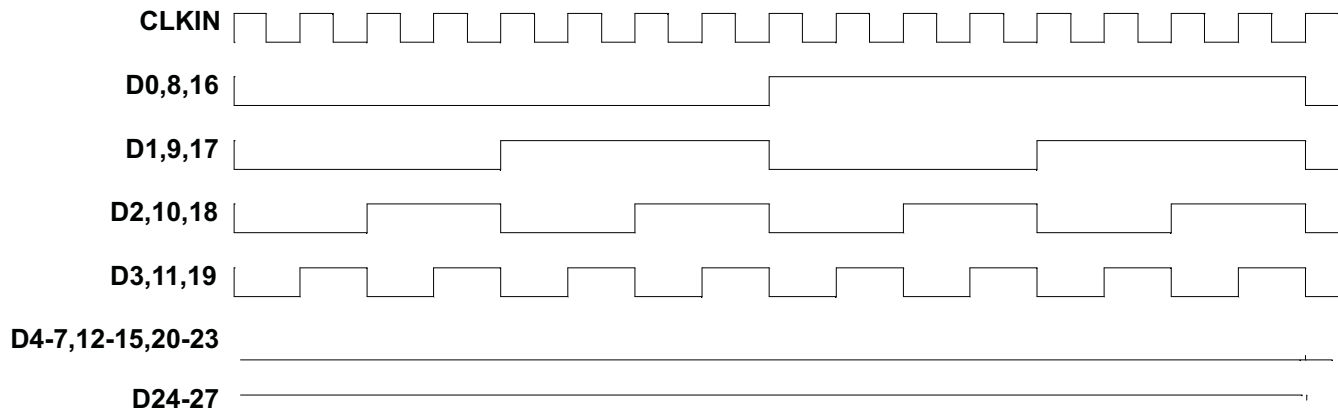
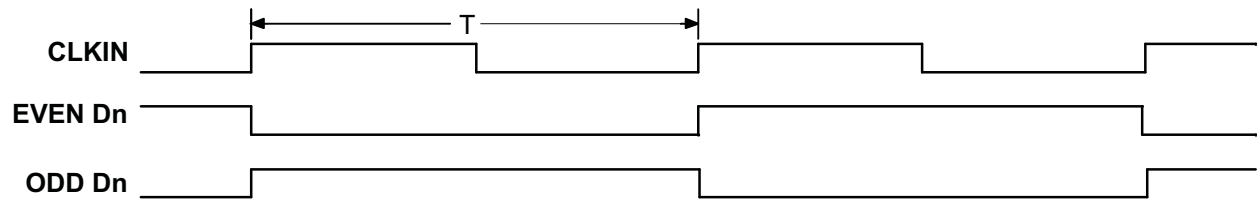
**Parameter Measurement Information (接下页)**

The worst-case test pattern produces nearly the maximum switching frequency for all of the LVDS outputs.

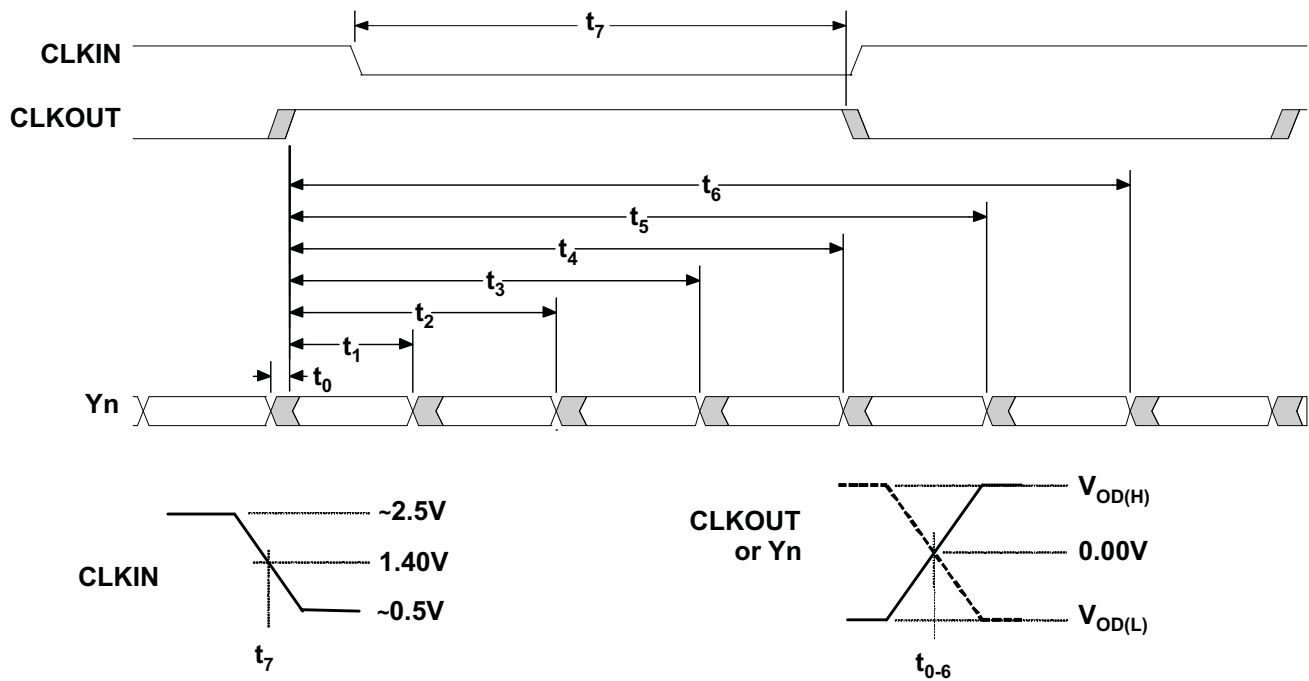
**图 9. Worst-Case Power Test Pattern**

CLKOUT is shown with CLKSEL at high-level.  
CLKIN polarity depends on CLKSEL input level.

**图 10. SN65LVDS93A Timing Definitions**

Parameter Measurement Information (接下页)



图 11. Output Clock Jitter Test Set Up



图 12. Enable Time Waveforms

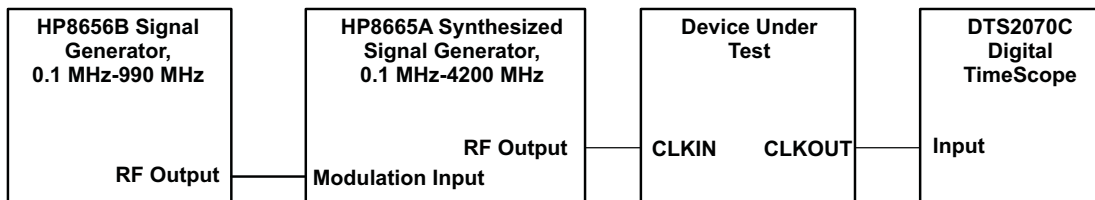
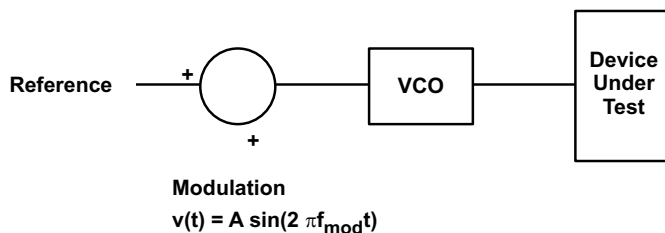

图 13. Disable Time Waveforms

## 9 Detailed Description

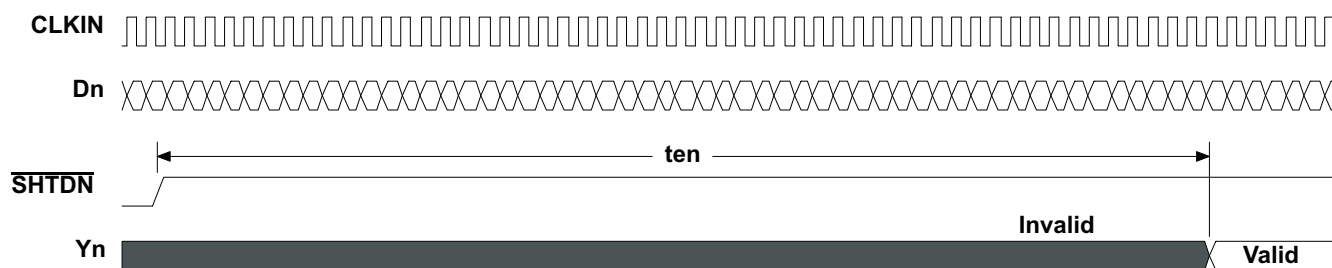
### 9.1 Overview

FlatLink™ is an LVDS SerDes data transmission system. The SN65LVDS93A takes in three (or four) data words each containing seven single-ended data bits, and converts this to an LVDS serial output. Each serial output runs at seven times that of the parallel data rate. The deserializer (receiver) device operates in the reverse manner. The three (or four) LVDS serial inputs are transformed back to the original 7-bit parallel single-ended data. FlatLink devices are available in 21:3 or 28:4 SerDes ratios.

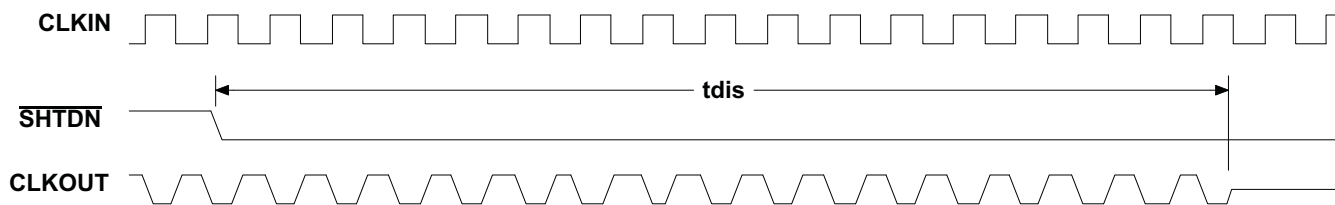
- The 21-bit devices are designed for 6-bit RGB video for a total of 18 bits in addition to 3 extra bits for horizontal synchronization, vertical synchronization, and data enable.
- The 28-bit devices are intended for 8-bit RGB video applications. Again, the extra 4 bits are for horizontal synchronization, vertical synchronization, data enable, and the remaining is the reserved bit. These 28-bit devices can also be used in 6-bit and 4-bit RGB applications as shown in the subsequent system diagrams.

### 9.2 Functional Block Diagram

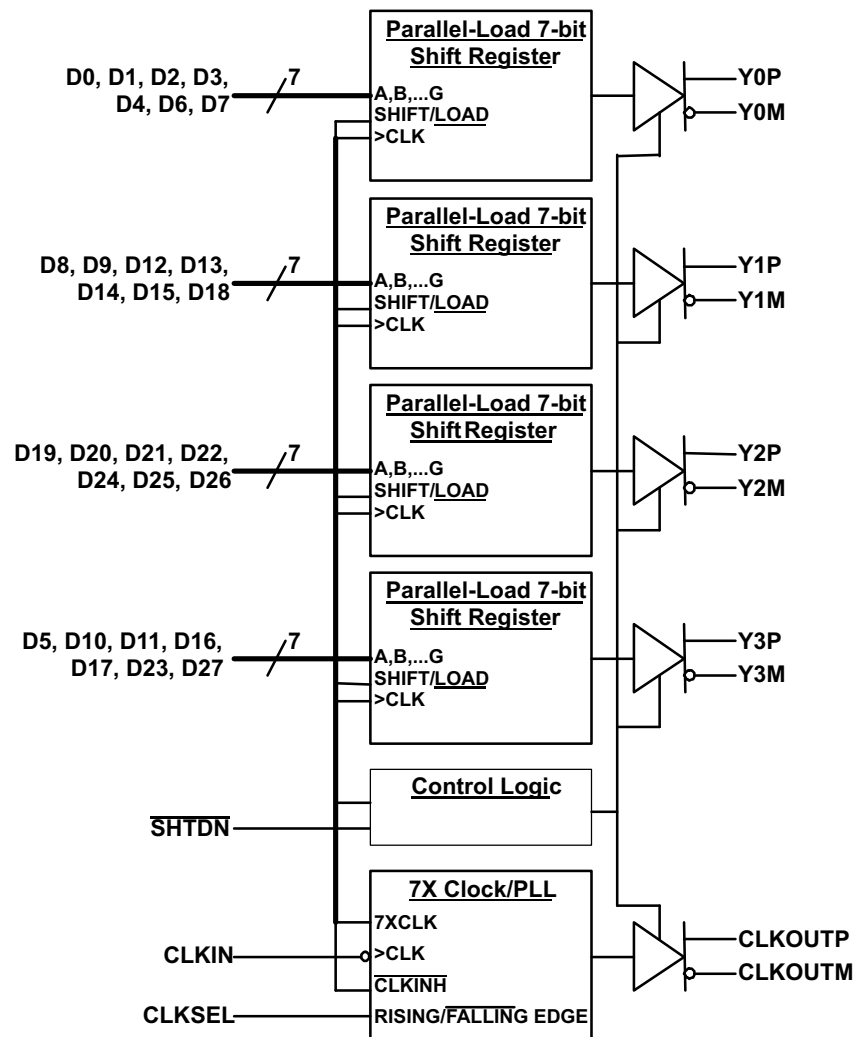



## 9.3 Feature Description

### 9.3.1 TTL Input Data

The data inputs to the transmitter come from the graphics processor and consist of up to 24 bits of video information, a horizontal synchronization bit, a vertical synchronization bit, an enable bit, and a spare bit. The data can be loaded into the registers upon either the rising or falling edge of the input clock selectable by the CLKSEL pin. Data inputs are 1.8 V to 3.3 V tolerant for the SN65LVDS93A and can connect directly to low-power, low-voltage application and graphic processors. The bit mapping is listed in [表 1](#).

**表 1. Pixel Bit Ordering**

	RED	GREEN	BLUE
LSB	R0	G0	B0
	R1	G1	B1
	R2	G2	B2
4-bit MSB	R3	G3	B3
	R4	G4	B4
6-bit MSB	R5	G5	B5
	R6	G6	B6
8-bit MSB	R7	G7	B7

### 9.3.2 LVDS Output Data

The pixel data assignment is listed in [表 2](#) for 24-bit, 18-bit, and 12-bit color hosts.

**表 2. Pixel Data Assignment**

SERIAL CHANNEL	DATA BITS	8-BIT			6-BIT	4-BIT	
		FORMAT-1	FORMAT-2	FORMAT-3		NON-LINEAR STEP SIZE	LINEAR STEP SIZE
Y0	D0	R0	R2	R2	R0	R2	VCC
	D1	R1	R3	R3	R1	R3	GND
	D2	R2	R4	R4	R2	R0	R0
	D3	R3	R5	R5	R3	R1	R1
	D4	R4	R6	R6	R4	R2	R2
	D6	R5	R7	R7	R5	R3	R3
	D7	G0	G2	G2	G0	G2	VCC
Y1	D8	G1	G3	G3	G1	G3	GND
	D9	G2	G4	G4	G2	G0	G0
	D12	G3	G5	G5	G3	G1	G1
	D13	G4	G6	G6	G4	G2	G2
	D14	G5	G7	G7	G5	G3	G3
	D15	B0	B2	B2	B0	B2	VCC
	D18	B1	B3	B3	B1	B3	GND
Y2	D19	B2	B4	B4	B2	B0	B0
	D20	B3	B5	B5	B3	B1	B1
	D21	B4	B6	B6	B4	B2	B2
	D22	B5	B7	B7	B5	B3	B3
	D24	HSYNC	HSYNC	HSYNC	HSYNC	HSYNC	HSYNC
	D25	VSYNC	VSYNC	VSYNC	VSYNC	VSYNC	VSYNC
	D26	ENABLE	ENABLE	ENABLE	ENABLE	ENABLE	ENABLE

**表 2. Pixel Data Assignment (接下页)**

SERIAL CHANNEL	DATA BITS	8-BIT			6-BIT	4-BIT	
		FORMAT-1	FORMAT-2	FORMAT-3		NON-LINEAR STEP SIZE	LINEAR STEP SIZE
Y3	D27	R6	R0	GND	GND	GND	GND
	D5	R7	R1	GND	GND	GND	GND
	D10	G6	G0	GND	GND	GND	GND
	D11	G7	G1	GND	GND	GND	GND
	D16	B6	B0	GND	GND	GND	GND
	D17	B7	B1	GND	GND	GND	GND
	D23	RSVD	RSVD	GND	GND	GND	GND
CLKOUT	CLKIN	CLK	CLK	CLK	CLK	CLK	CLK

## 9.4 Device Functional Modes

### 9.4.1 Input Clock Edge

The transmission of data bits D0 through D27 occurs as each are loaded into registers upon the edge of the CLKIN signal, where the rising or falling edge of the clock may be selected through CLKSEL. The selection of a clock rising edge occurs by inputting a high level to CLKSEL, which is achieved by populating pullup resistor to pull CLKSEL=high. Inputting a low level to select a clock falling edge is achieved by directly connecting CLKSEL to GND.

### 9.4.2 Low Power Mode

The SN65LVDS93A can be put in low-power consumption mode by active-low input SHTDN#. Connecting pin SHTDN# to GND will inhibit the clock and shut off the LVDS output drivers for lower power consumption. A low-level on this signal clears all internal registers to a low-level. Populate a pullup to VCC on SHTDN# to enable the device for normal operation.

## 10 Application and Implementation

### 注

Information in the following applications sections is not part of the TI component specification, and TI does not warrant its accuracy or completeness. TI's customers are responsible for determining suitability of components for their purposes. Customers should validate and test their design implementation to confirm system functionality.

### 10.1 Application Information

This section describes the power up sequence, provides information on device connectivity to various GPU and LCD display panels, and offers a PCB routing example.

### 10.2 Typical Application



图 14. Schematic Example (SN65LVDS93A Evaluation Board)

## Typical Application (接下页)

### 10.2.1 Design Requirements

For this design example, use the parameters listed in 表 3 as the input parameters.

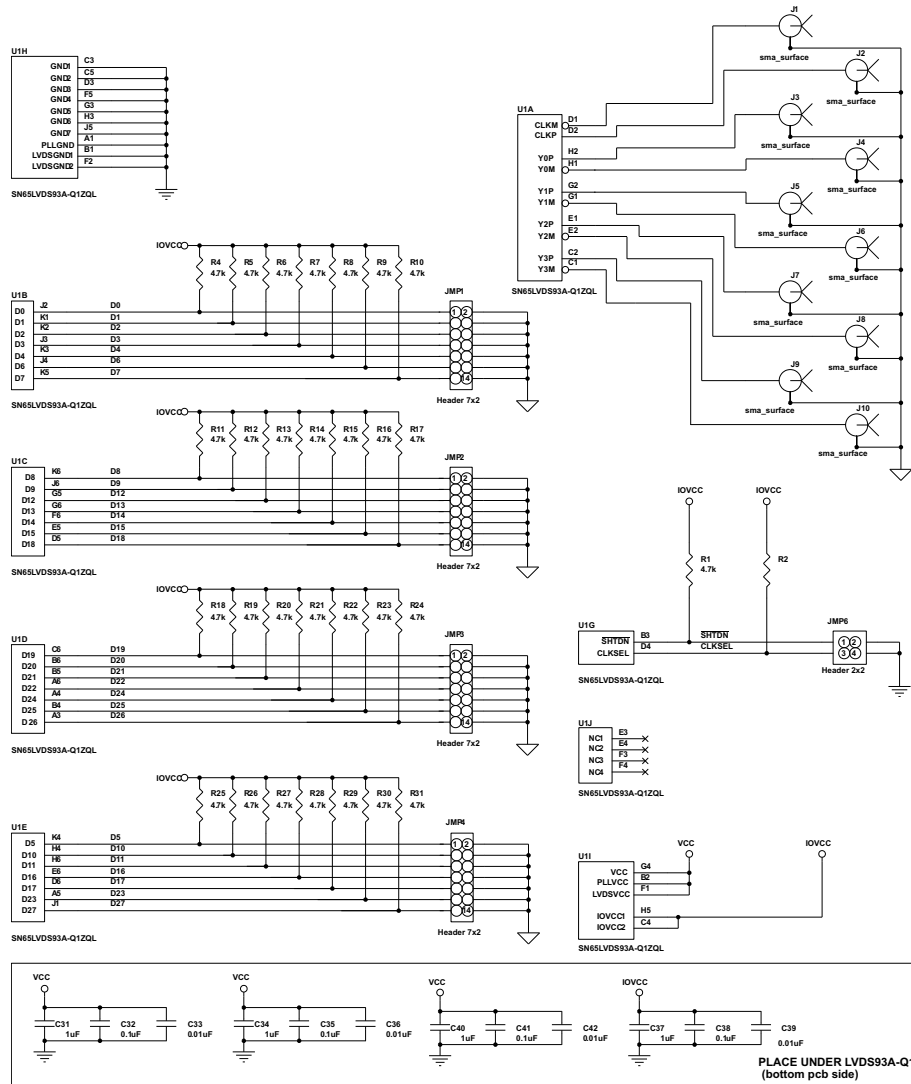
**表 3. Design Parameters**

DESIGN PARAMETER	EXAMPLE VALUE
VCC	3.3 V
VCCIO	1.8 V
CLKIN	Falling edge
SHTDN#	High
Format	18-bit GPU to 24-bit LCD

### 10.2.2 Detailed Design Procedure

#### 10.2.2.1 Power

The SN65LVDS93A does not require a specific power-up sequence.

The device is permitted to power up IOVCC while VCC, VCCPLL, and VCCLVDS remain powered down and connected to GND. The input level of the SHTDN during this time does not matter as only the input stage is powered up while all other device blocks are still powered down.

The device is also permitted to power up all 3.3-V power domains while IOVCC is still powered down to GND. The device will not suffer damage. However, in this case, all the I/Os are detected as logic HIGH, regardless of their true input voltage level. Hence, connecting SHTDN to GND will still be interpreted as a logic HIGH; the LVDS output stage turns on. The power consumption in this condition is significantly higher than standby mode, but still lower than normal mode.

The user experience can be impacted by the way a system powers up and powers down an LCD screen. The following sequence is recommended:

Power-up sequence (SN65LVDS93A SHTDN input initially low):

- A. Ramp up LCD power (maybe 0.5 ms to 10 ms) but keep backlight turned off.
- B. Wait for additional 0-200 ms to ensure display noise won't occur.
- C. Enable video source output; start sending black video data.
- D. Toggle SN65LVDS93A shutdown to SHTDN = V<sub>IH</sub>.
- E. Send >1 ms of black video data; this allows the SN65LVDS93A to be phase locked, and the display to show black data first.
- F. Start sending true image data.
- G. Enable backlight.

Power-down sequence (SN65LVDS93A SHTDN input initially high):

- A. Disable LCD backlight; wait for the minimum time specified in the LCD data sheet for the backlight to go low.
- B. Video source output data switch from active video data to black image data (all visible pixel turn black); drive this for >2 frame times.
- C. Set SN65LVDS93A input SHTDN = GND; wait for 250 ns.
- D. Disable the video output of the video source.
- E. Remove power from the LCD panel for lowest system power.

#### 10.2.2.2 Signal Connectivity

While there is no formal industry standardized specification for the input interface of LVDS LCD panels, the industry has aligned over the years on a certain data format (bit order). 图 15 through 图 18 show how each signal should be connected from the graphic source through the SN65LVDS93A input, output and LVDS LCD panel input. Detailed notes are provided with each figure.

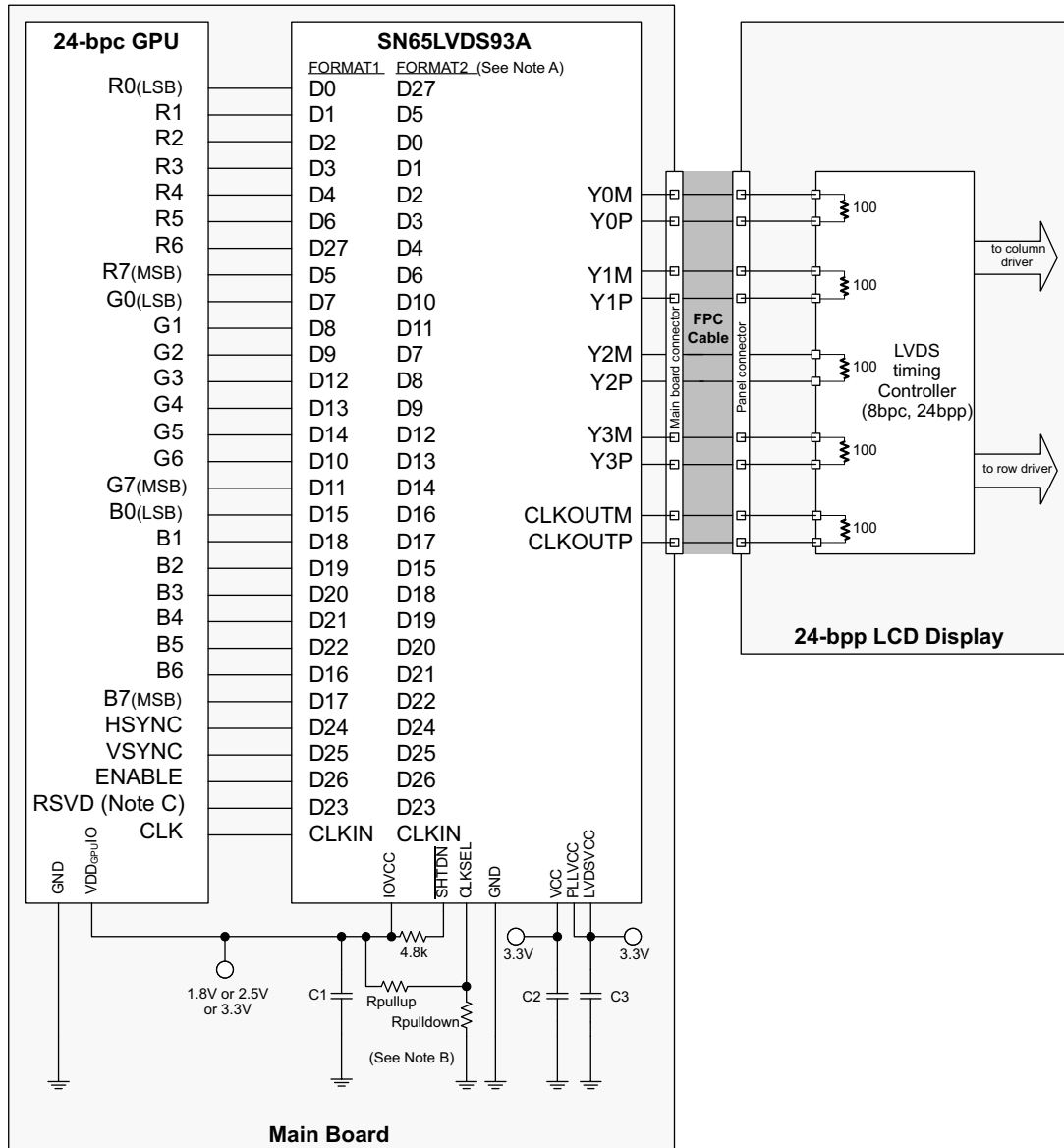

Note A. **FORMAT**: The majority of 24-bit LCD display panels require the two most significant bits (2 MSB ) of each color to be transferred over the 4th serial data output Y3. A few 24-bit LCD display panels require the two LSBs of each color to be transmitted over the Y3 output. The system designer needs to verify which format is expected by checking the LCD display data sheet.

- Format 1: use with displays expecting the 2 MSB to be transmitted over the 4th data channel Y3. This is the dominate data format for LCD panels.
- Format 2: use with displays expecting the 2 LSB to be transmitted over the 4th data channel.

Note B. **Rpullup**: install only to use rising edge triggered clocking.

**Rpulldown**: install only to use falling edge triggered clocking.

- C1: decoupling capacitor for the VDDIO supply; install at least 1x0.01μF.
- C2: decoupling capacitor for the VDD supply; install at least 1x0.1μF and 1x0.01μF.
- C3: decoupling capacitor for the VDDPLL and VDDLVDSS supply; install at least 1x0.1μF and 1x0.01μF.

Note C. If RSVD is not driven to a valid logic level, then an external connection to GND is recommended.

Note D. RSVD must be driven to a valid logic level. All unused SN65LVDS93A inputs must be tied to a valid logic level.

图 15. 24-Bit Color Host to 24-Bit LCD Panel Application

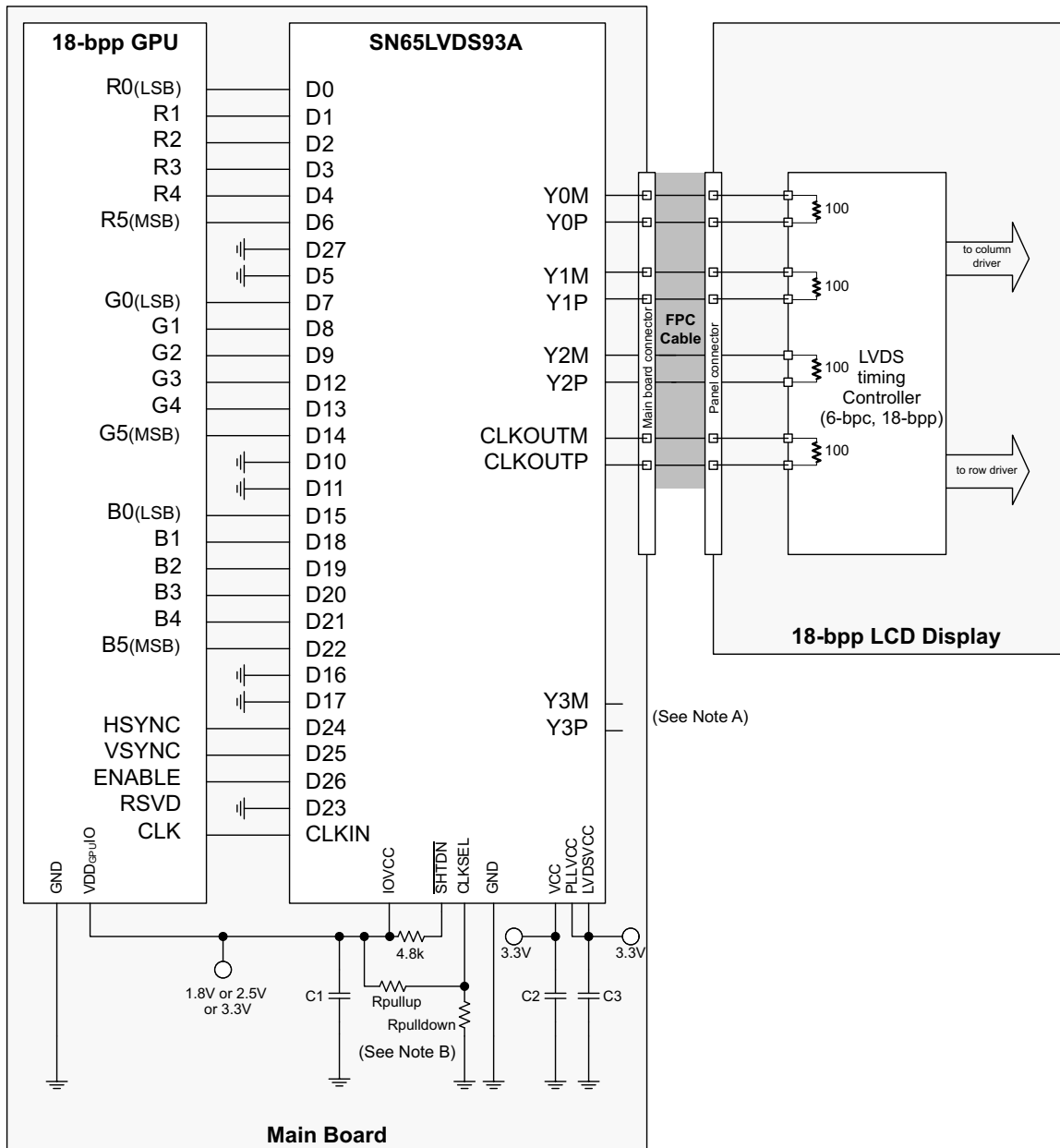

Note A. Leave output Y3 NC.

Note B. **Rpullup**: install only to use rising edge triggered clocking.

**Rpulldown**: install only to use falling edge triggered clocking.

- C1: decoupling capacitor for the VDDIO supply; install at least  $1 \times 0.01 \mu\text{F}$ .
- C2: decoupling capacitor for the VDD supply; install at least  $1 \times 0.1 \mu\text{F}$  and  $1 \times 0.01 \mu\text{F}$ .
- C3: decoupling capacitor for the VDDPLL and VDDLVD supply; install at least  $1 \times 0.1 \mu\text{F}$  and  $1 \times 0.01 \mu\text{F}$ .

**图 16. 18-Bit Color Host to 18-Bit Color LCD Panel Display Application**

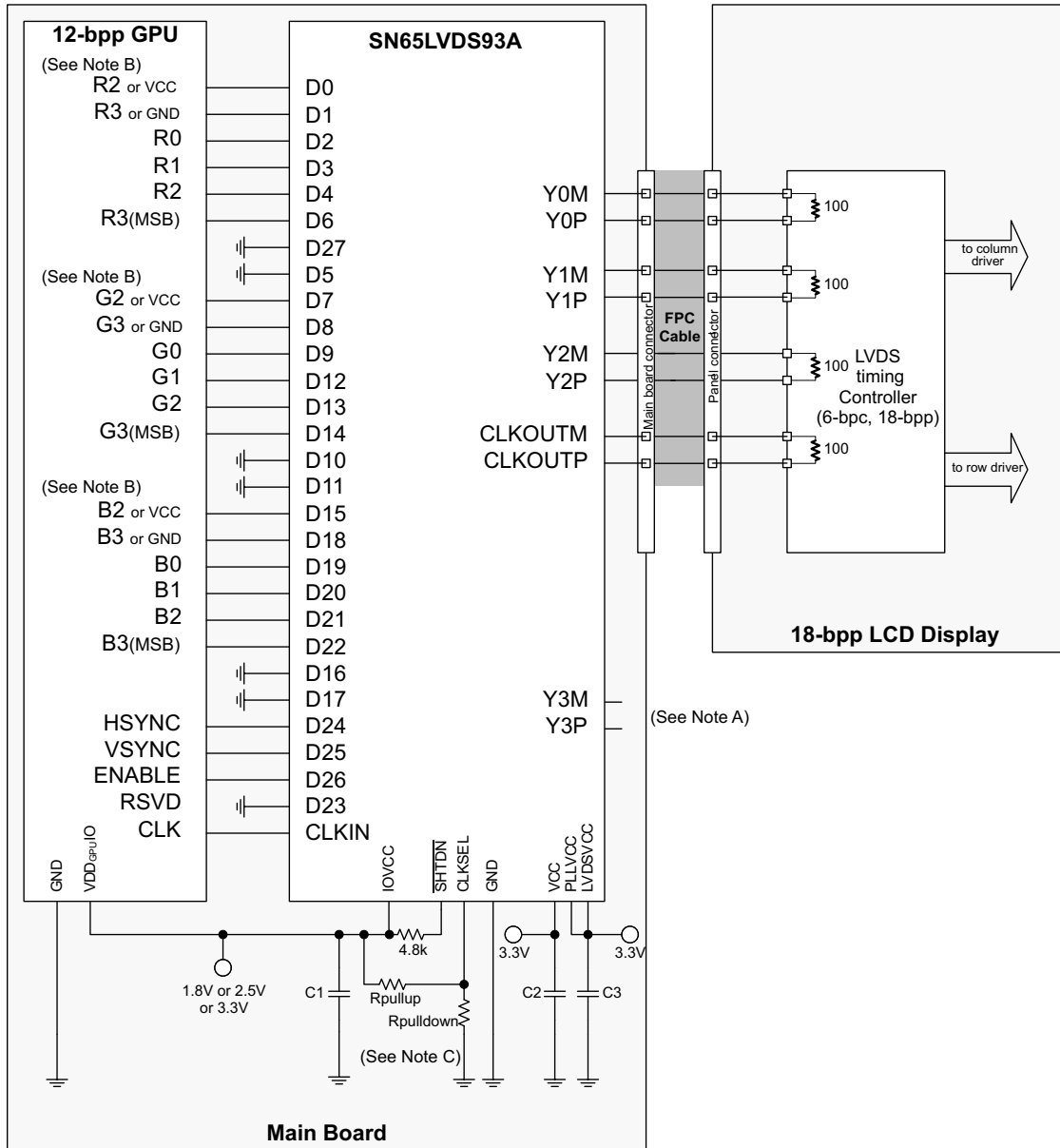

Note A. Leave output Y3 N.C.

Note B. **R3, G3, B3**: this MSB of each color also connects to the 5th bit of each color for increased dynamic range of the entire color space at the expense of nonlinear step sizes between each step. For linear steps with less dynamic range, connect D1, D8, and D18 to GND.

**R2, G2, B2**: these outputs also connects to the LSB of each color for increased, dynamic range of the entire color space at the expense of nonlinear step sizes between each step. For linear steps with less dynamic range, connect D0, D7, and D15 to VCC.

Note C. **Rpullup**: install only to use rising edge triggered clocking.

**Rpulldown**: install only to use falling edge triggered clocking.

- C1: decoupling capacitor for the VDDIO supply; install at least 1x0.01µF.
- C2: decoupling capacitor for the VDD supply; install at least 1x0.1µF and 1x0.01µF.
- C3: decoupling capacitor for the VDDPLL and VDDLVD supply; install at least 1x0.1µF and 1x0.01µF.

图 17. 12-Bit Color Host to 18-Bit Color LCD Panel Display Application

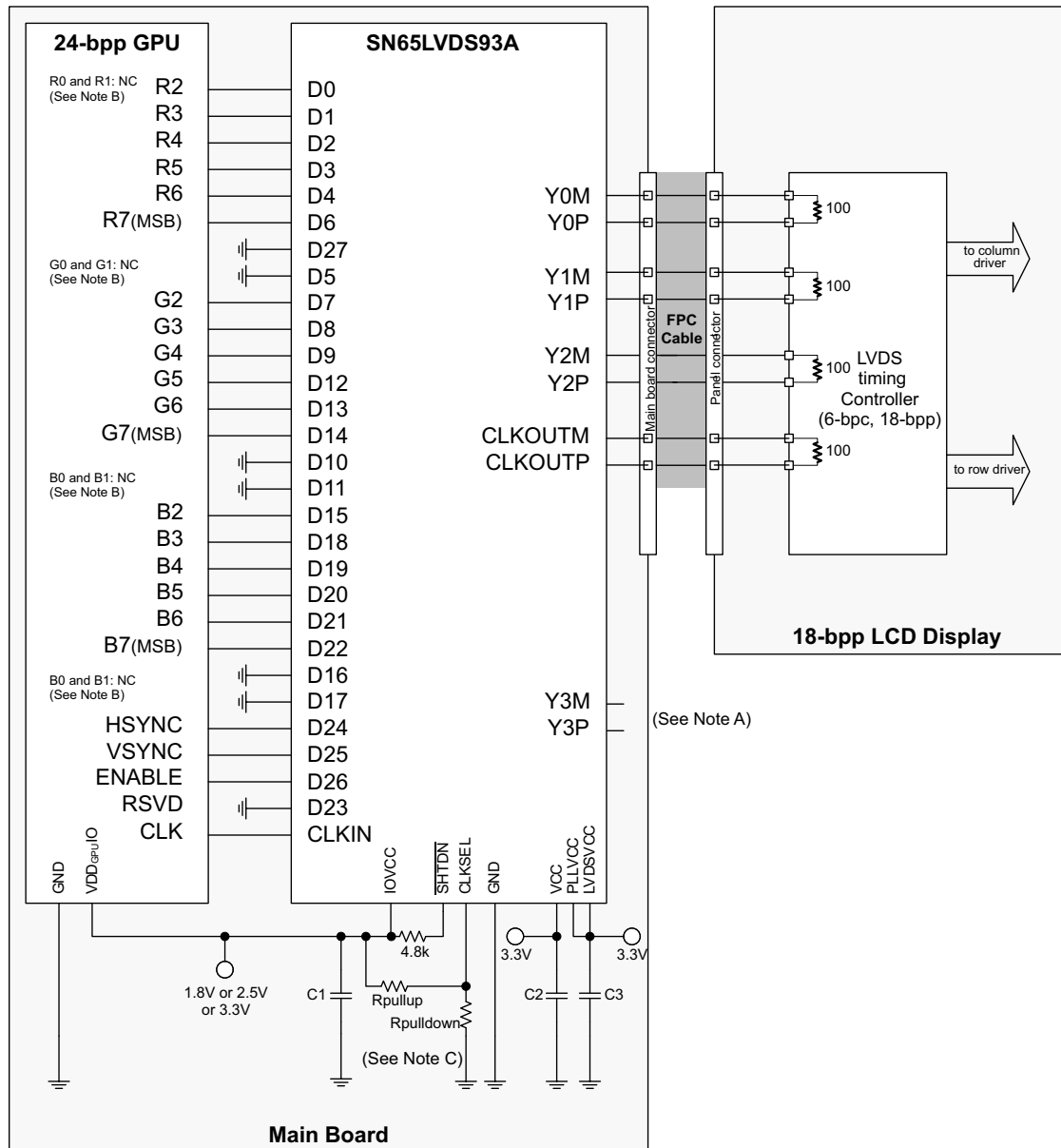

Note A. Leave output Y3 NC.

Note B. **R0, R1, G0, G1, B0, B1**: For improved image quality, the GPU should dither the 24-bit output pixel down to 18-bit per pixel.

Note C. **Rpullup**: install only to use rising edge triggered clocking.

**Rpulldown**: install only to use falling edge triggered clocking.

- C1: decoupling capacitor for the VDDIO supply; install at least 1x0.01 $\mu$ F.
- C2: decoupling capacitor for the VDD supply; install at least 1x0.1 $\mu$ F and 1x0.01 $\mu$ F.
- C3: decoupling capacitor for the VDDPLL and VDDLVD supply; install at least 1x0.1 $\mu$ F and 1x0.01 $\mu$ F.

**图 18. 24-Bit Color Host to 18-Bit Color LCD Panel Display Application**



10.2.2.3 PCB Routing

图 19 shows a possible breakout of the data input and output signals on two layers of a printed-circuit-board.



图 19. Printed-Circuit-Board Routing Example (See 图 14 for the Schematic)

10.2.3 Application Curve

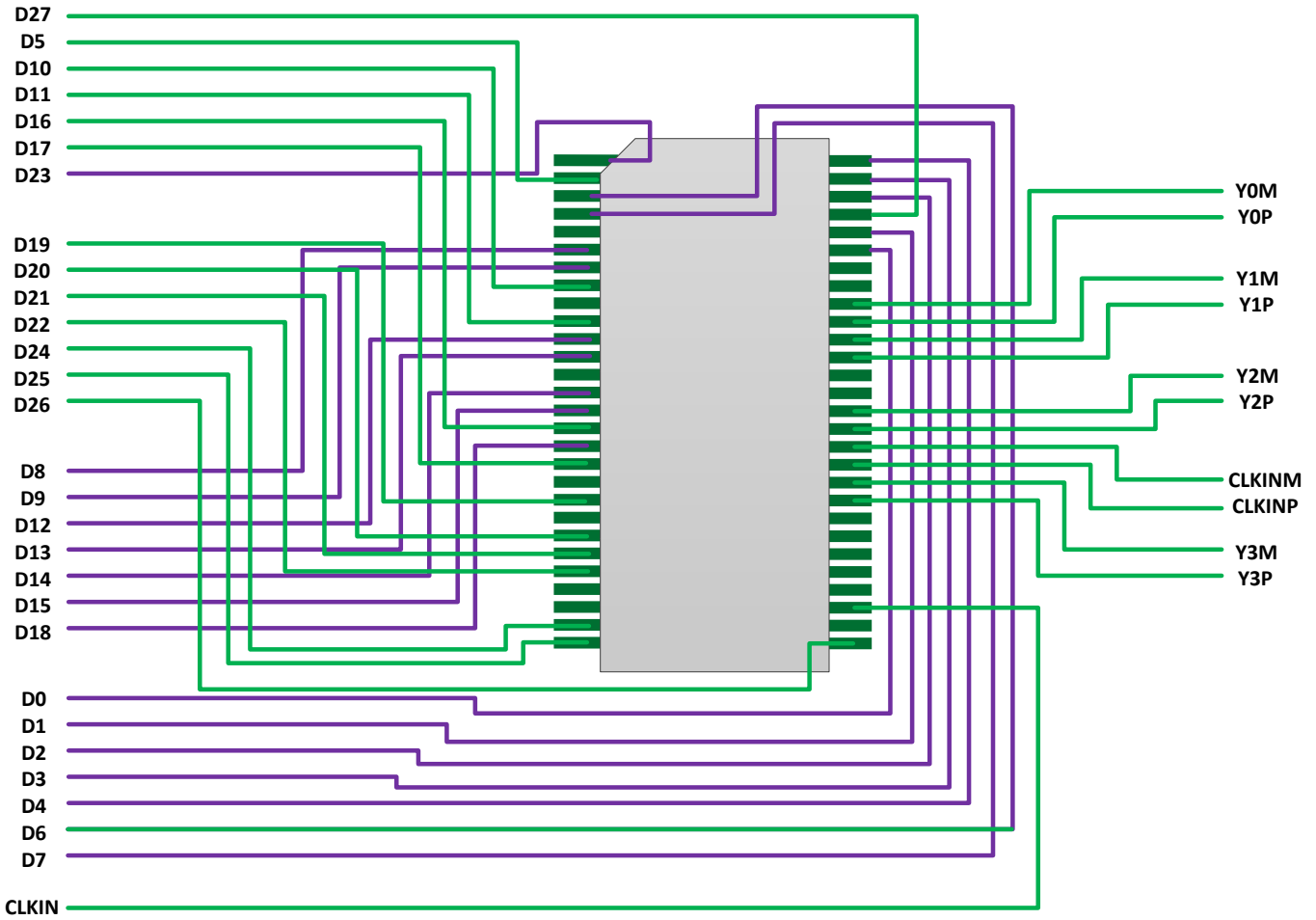

图 20. 18b GPU to 24b LCD

## 11 Power Supply Recommendations

Power supply PLL, IO, and LVDS pins must be uncoupled from each.

## 12 Layout

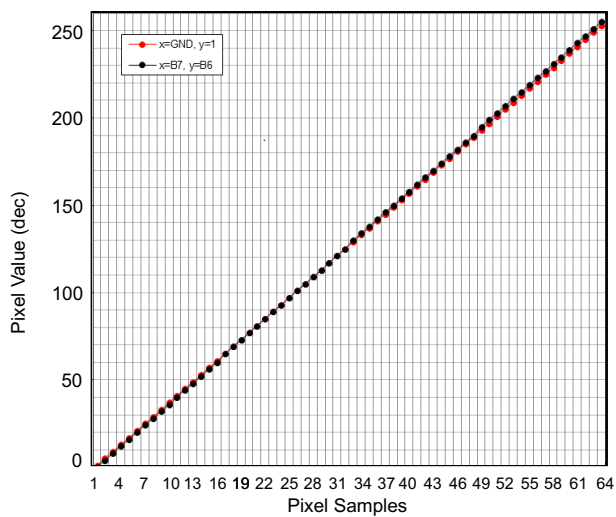
### 12.1 Layout Guidelines

#### 12.1.1 Board Stackup

There is no fundamental information about how many layers should be used and how the board stackup should look. Again, the easiest way to get good results is to use the design from the EVMs of TI. The magazine *Elektronik Praxis* has published an article with an analysis of different board stackups. These are listed in [表 4](#). Generally, the use of microstrip traces needs at least two layers, whereas one of them must be a GND plane. Better is the use of a 4-layer PCB, with a GND and a VCC plane and two signal layers. If the circuit is complex and signals must be routed as stripline, because of propagation delay and/or characteristic impedance, a 6-layer stackup should be used.

**表 4. Possible Board Stackup on a Four-Layer PCB**

	MODEL 1	MODEL 2	MODEL 3	MODEL 4
Layer 1	SIG	SIG	SIG	GND
Layer 2	SIG	GND	GND	SIG
Layer 3	VCC	VCC	SIG	VCC
Layer 4	GND	SIG	VCC	SIG
Decoupling	Good	Good	Bad	Bad
EMC	Bad	Bad	Bad	Bad
Signal Integrity	Bad	Bad	Good	Bad
Self Disturbance	Satisfaction	Satisfaction	Satisfaction	High

#### 12.1.2 Power and Ground Planes

A complete ground plane in high-speed design is essential. Additionally, a complete power plane is recommended as well. In a complex system, several regulated voltages can be present. The best solution is for every voltage to have its own layer and its own ground plane. But this would result in a huge number of layers just for ground and supply voltages. What are the alternatives? Split the ground planes and the power planes? In a mixed-signal design, for example, using data converters, the manufacturer often recommends splitting the analog ground and the digital ground to avoid noise coupling between the digital part and the sensitive analog part. Take care when using split ground planes because:

- Split ground planes act as slot antennas and radiate.
- A routed trace over a gap creates large loop areas, because the return current cannot flow beside the signal, and the signal can induce noise into the nonrelated reference plane ([图 21](#)).
- With a proper signal routing, crosstalk also can arise in the return current path due to discontinuities in the ground plane. Always take care of the return current ([图 22](#)).

For [图 22](#), do not route a signal referenced to digital ground over analog ground and vice versa. The return current cannot take the direct way along the signal trace and so a loop area occurs. Furthermore, the signal induces noise, due to crosstalk (dotted red line) into the analog ground plane.



图 21. Loop Area and Crosstalk Due to Poor Signal Routing and Ground Splitting



图 22. Crosstalk Induced by the Return Current Path

### 12.1.3 Traces, Vias, and Other PCB Components

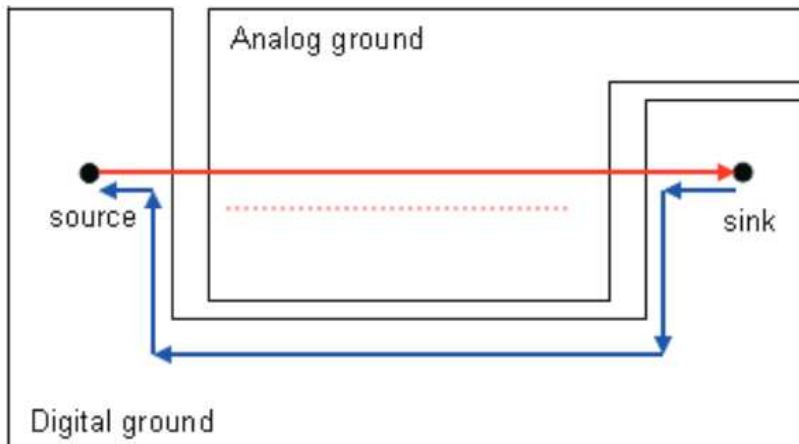
A right angle in a trace can cause more radiation. The capacitance increases in the region of the corner, and the characteristic impedance changes. This impedance change causes reflections.

- Avoid right-angle bends in a trace and try to route them at least with two 45° corners. To minimize any impedance change, the best routing would be a round bend (see 图 23).
- Separate high-speed signals (for example, clock signals) from low-speed signals and digital from analog signals; again, placement is important.
- To minimize crosstalk not only between two signals on one layer but also between adjacent layers, route them with 90° to each other.

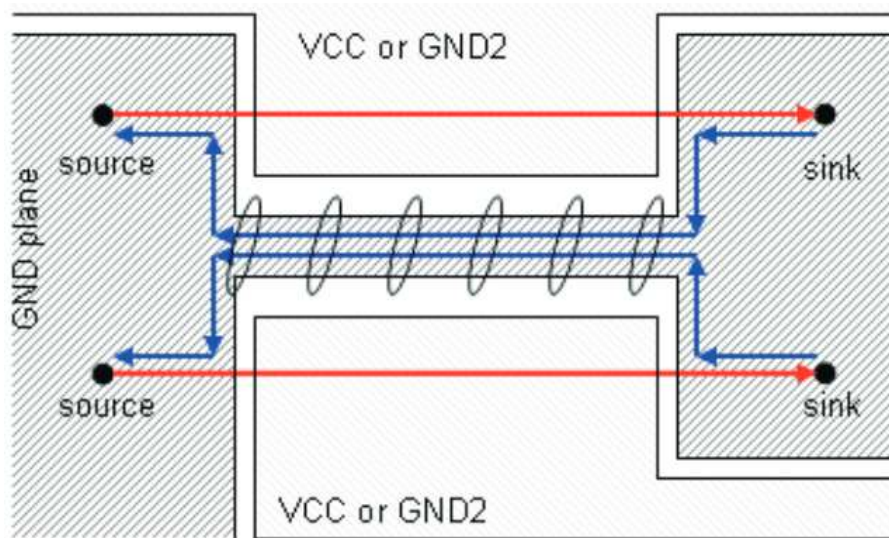

图 23. Poor and Good Right-Angle Bends

## 12.2 Layout Example

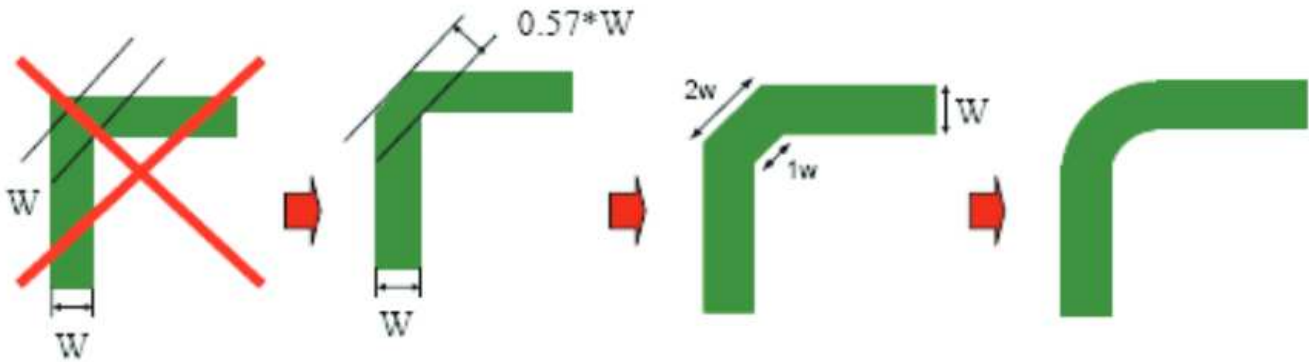

图 24. SN65LVDS93A EVM Top Layer – TSSOP Package

Layout Example (接下页)

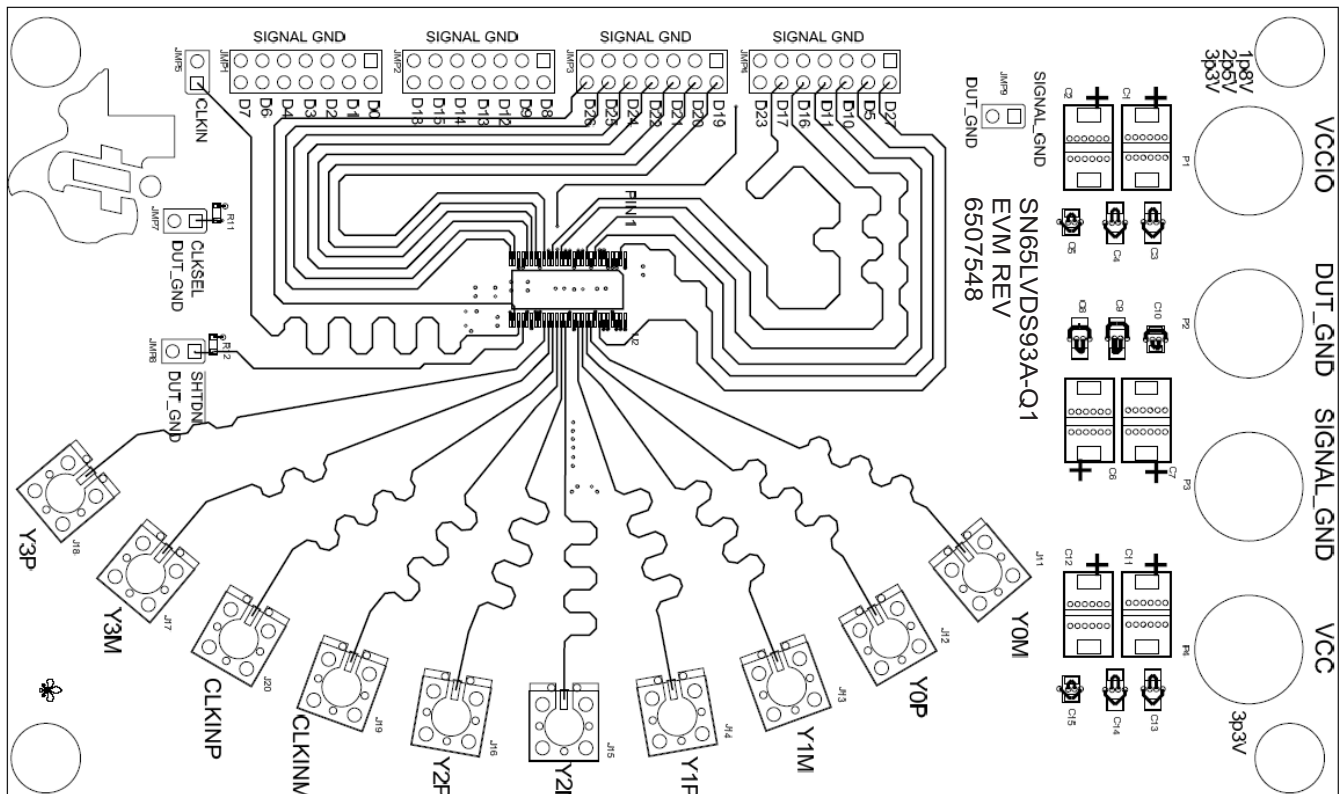

图 25. SN65LVDS93AEVM VCC Layer – TSSOP Package

## 13 器件和文档支持

### 13.1 文档支持

#### 13.1.1 相关文档

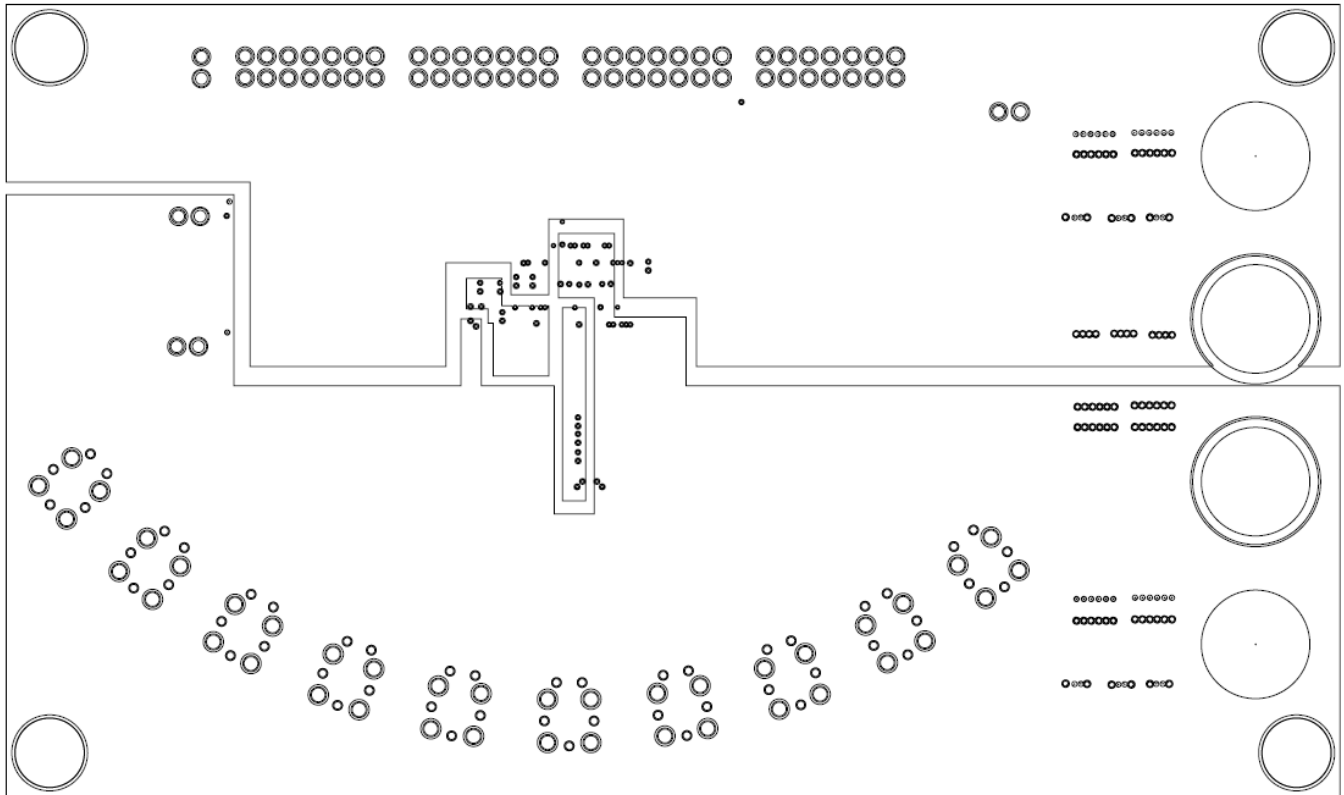
如需相关文档，请参阅：

《LVDS SerDes 接收器》(SNLS043H)

### 13.2 接收文档更新通知

要接收文档更新通知，请导航至 [TI.com.cn](http://TI.com.cn) 上的器件产品文件夹。请单击右上角的提醒我进行注册，即可每周接收产品信息更改摘要。有关更改的详细信息，请查看任何已修订文档中包含的修订历史记录。

### 13.3 社区资源

下列链接提供到 TI 社区资源的连接。链接的内容由各个分销商“按照原样”提供。这些内容并不构成 TI 技术规范，并且不一定反映 TI 的观点；请参阅 TI 的《使用条款》。

**TI E2E™ 在线社区** *TI 的工程师对工程师 (E2E) 社区*。此社区的创建目的在于促进工程师之间的协作。在 [e2e.ti.com](http://e2e.ti.com) 中，您可以咨询问题、分享知识、拓展思路并与同行工程师一道帮助解决问题。

**设计支持** *TI 参考设计支持* 可帮助您快速查找有帮助的 E2E 论坛、设计支持工具以及技术支持的联系信息。

### 13.4 商标

OMAP, DaVinci, FlatLink, E2E are trademarks of Texas Instruments.  
All other trademarks are the property of their respective owners.

### 13.5 静电放电警告



这些装置包含有限的内置 ESD 保护。存储或装卸时，应将导线一起截短或将装置放置于导电泡棉中，以防止 MOS 门极遭受静电损伤。

## 13.6 Glossary

**SLYZ022** — *TI Glossary*.

This glossary lists and explains terms, acronyms, and definitions.

## 14 机械、封装和可订购信息

以下页面包含机械、封装和可订购信息。这些信息是指定器件的最新可用数据。数据如有变更，恕不另行通知，也不会对此文档进行修订。如欲获取此数据表的浏览器版本，请参阅左侧的导航。

**PACKAGING INFORMATION**

Orderable part number	Status (1)	Material type (2)	Package   Pins	Package qty   Carrier	RoHS (3)	Lead finish/ Ball material (4)	MSL rating/ Peak reflow (5)	Op temp (°C)	Part marking (6)
<a href="#">SN65LVDS93ADGG</a>	Active	Production	TSSOP (DGG)   56	35   TUBE	Yes	NIPDAU	Level-2-260C-1 YEAR	-40 to 85	LVDS93A
SN65LVDS93ADGG.A	Active	Production	TSSOP (DGG)   56	35   TUBE	Yes	NIPDAU	Level-2-260C-1 YEAR	-40 to 85	LVDS93A
<a href="#">SN65LVDS93ADGGR</a>	Active	Production	TSSOP (DGG)   56	2000   LARGE T&R	Yes	NIPDAU	Level-2-260C-1 YEAR	-40 to 85	LVDS93A
SN65LVDS93ADGGR.A	Active	Production	TSSOP (DGG)   56	2000   LARGE T&R	Yes	NIPDAU	Level-2-260C-1 YEAR	-40 to 85	LVDS93A
SN65LVDS93ADGGRG4	Active	Production	TSSOP (DGG)   56	2000   LARGE T&R	Yes	NIPDAU	Level-2-260C-1 YEAR	-40 to 85	LVDS93A
SN65LVDS93ADGGRG4.A	Active	Production	TSSOP (DGG)   56	2000   LARGE T&R	Yes	NIPDAU	Level-2-260C-1 YEAR	-40 to 85	LVDS93A

(1) **Status:** For more details on status, see our [product life cycle](#).

(2) **Material type:** When designated, preproduction parts are prototypes/experimental devices, and are not yet approved or released for full production. Testing and final process, including without limitation quality assurance, reliability performance testing, and/or process qualification, may not yet be complete, and this item is subject to further changes or possible discontinuation. If available for ordering, purchases will be subject to an additional waiver at checkout, and are intended for early internal evaluation purposes only. These items are sold without warranties of any kind.

(3) **RoHS values:** Yes, No, RoHS Exempt. See the [TI RoHS Statement](#) for additional information and value definition.

(4) **Lead finish/Ball material:** Parts may have multiple material finish options. Finish options are separated by a vertical ruled line. Lead finish/Ball material values may wrap to two lines if the finish value exceeds the maximum column width.

(5) **MSL rating/Peak reflow:** The moisture sensitivity level ratings and peak solder (reflow) temperatures. In the event that a part has multiple moisture sensitivity ratings, only the lowest level per JEDEC standards is shown. Refer to the shipping label for the actual reflow temperature that will be used to mount the part to the printed circuit board.

(6) **Part marking:** There may be an additional marking, which relates to the logo, the lot trace code information, or the environmental category of the part.

Multiple part markings will be inside parentheses. Only one part marking contained in parentheses and separated by a "~" will appear on a part. If a line is indented then it is a continuation of the previous line and the two combined represent the entire part marking for that device.

**Important Information and Disclaimer:**The information provided on this page represents TI's knowledge and belief as of the date that it is provided. TI bases its knowledge and belief on information provided by third parties, and makes no representation or warranty as to the accuracy of such information. Efforts are underway to better integrate information from third parties. TI has taken and continues to take reasonable steps to provide representative and accurate information but may not have conducted destructive testing or chemical analysis on incoming materials and chemicals. TI and TI suppliers consider certain information to be proprietary, and thus CAS numbers and other limited information may not be available for release.

In no event shall TI's liability arising out of such information exceed the total purchase price of the TI part(s) at issue in this document sold by TI to Customer on an annual basis.

**OTHER QUALIFIED VERSIONS OF SN65LVDS93A :**

- Automotive : [SN65LVDS93A-Q1](#)

## NOTE: Qualified Version Definitions:

- Automotive - Q100 devices qualified for high-reliability automotive applications targeting zero defects



**TAPE AND REEL INFORMATION**

**QUADRANT ASSIGNMENTS FOR PIN 1 ORIENTATION IN TAPE**

\*All dimensions are nominal

Device	Package Type	Package Drawing	Pins	SPQ	Reel Diameter (mm)	Reel Width W1 (mm)	A0 (mm)	B0 (mm)	K0 (mm)	P1 (mm)	W (mm)	Pin1 Quadrant
SN65LVDS93ADGGR	TSSOP	DGG	56	2000	330.0	24.4	8.9	14.7	1.4	12.0	24.0	Q1
SN65LVDS93ADGGRG4	TSSOP	DGG	56	2000	330.0	24.4	8.9	14.7	1.4	12.0	24.0	Q1

**TAPE AND REEL BOX DIMENSIONS**

\*All dimensions are nominal

Device	Package Type	Package Drawing	Pins	SPQ	Length (mm)	Width (mm)	Height (mm)
SN65LVDS93ADGGR	TSSOP	DGG	56	2000	356.0	356.0	45.0
SN65LVDS93ADGGRG4	TSSOP	DGG	56	2000	356.0	356.0	45.0

**TUBE**

\*All dimensions are nominal

Device	Package Name	Package Type	Pins	SPQ	L (mm)	W (mm)	T (μm)	B (mm)
SN65LVDS93ADGG	DGG	TSSOP	56	35	530	11.89	3600	4.9
SN65LVDS93ADGG.A	DGG	TSSOP	56	35	530	11.89	3600	4.9



NOTES:

1. All linear dimensions are in millimeters. Any dimensions in parenthesis are for reference only. Dimensioning and tolerancing per ASME Y14.5M.
2. This drawing is subject to change without notice.
3. This dimension does not include mold flash, protrusions, or gate burrs. Mold flash, protrusions, or gate burrs shall not exceed 0.15 mm per side.
4. Reference JEDEC registration MO-153.

# EXAMPLE BOARD LAYOUT

DGG0056A

TSSOP - 1.2 mm max height

SMALL OUTLINE PACKAGE



LAND PATTERN EXAMPLE  
SCALE:6X

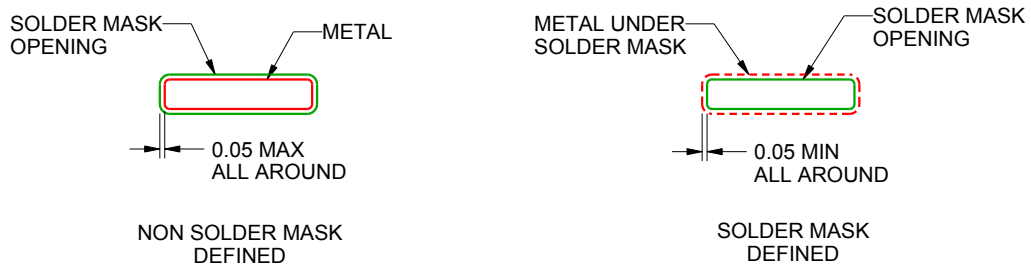

SOLDER MASK DETAILS

4222167/A 07/2015

NOTES: (continued)

- 5. Publication IPC-7351 may have alternate designs.
- 6. Solder mask tolerances between and around signal pads can vary based on board fabrication site.

# EXAMPLE STENCIL DESIGN

DGG0056A

TSSOP - 1.2 mm max height

SMALL OUTLINE PACKAGE



SOLDER PASTE EXAMPLE  
BASED ON 0.125 mm THICK STENCIL  
SCALE:6X

4222167/A 07/2015

NOTES: (continued)

7. Laser cutting apertures with trapezoidal walls and rounded corners may offer better paste release. IPC-7525 may have alternate design recommendations.
8. Board assembly site may have different recommendations for stencil design.

## 重要通知和免责声明

TI“按原样”提供技术和可靠性数据（包括数据表）、设计资源（包括参考设计）、应用或其他设计建议、网络工具、安全信息和其他资源，不保证没有瑕疵且不做任何明示或暗示的担保，包括但不限于对适销性、与某特定用途的适用性或不侵犯任何第三方知识产权的暗示担保。

这些资源可供使用 TI 产品进行设计的熟练开发人员使用。您将自行承担以下全部责任：(1) 针对您的应用选择合适的 TI 产品，(2) 设计、验证并测试您的应用，(3) 确保您的应用满足相应标准以及任何其他安全、安保法规或其他要求。

这些资源如有变更，恕不另行通知。TI 授权您仅可将这些资源用于研发本资源所述的 TI 产品的相关应用。严禁以其他方式对这些资源进行复制或展示。您无权使用任何其他 TI 知识产权或任何第三方知识产权。对于因您对这些资源的使用而对 TI 及其代表造成的任何索赔、损害、成本、损失和债务，您将全额赔偿，TI 对此概不负责。

TI 提供的产品受 [TI 销售条款](#)、[TI 通用质量指南](#) 或 [ti.com](#) 上其他适用条款或 TI 产品随附的其他适用条款的约束。TI 提供这些资源并不会扩展或以其他方式更改 TI 针对 TI 产品发布的适用的担保或担保免责声明。除非德州仪器 (TI) 明确将某产品指定为定制产品或客户特定产品，否则其产品均为按确定价格收入目录的标准通用器件。

TI 反对并拒绝您可能提出的任何其他或不同的条款。

版权所有 © 2025，德州仪器 (TI) 公司

最后更新日期：2025 年 10 月