

# OPA375、OPA2375、OPA4375 500 $\mu$ V (最大值)、10MHz、低宽带噪声、RRO 运算放大器

## 1 特性

- 低宽带噪声：3.5nV/ $\sqrt{\text{Hz}}$
- 低失调电压：500 $\mu$ V (最大值)
- 低 THD+N：0.00015%
- 增益带宽：10MHz
- 轨到轨输出
- 单位增益稳定
- 低  $I_Q$ ：
  - OPA375：890 $\mu$ A/通道
  - OPA2375/OPA4375：990 $\mu$ A/通道
- 宽电源电压范围：
  - OPA375：2.25V 至 5.5V
  - OPA2375/OPA4375：1.7V 至 5.5V
- 低失调电压漂移： $\pm 0.16\mu\text{V}/^\circ\text{C}$

## 2 应用

- 光电二极管放大器
- 精密传感器前端
- ADC 输入驱动器放大器
- 测试和测量设备
- 传感器现场变送器
- 可穿戴消费类应用
- 音频设备
- 医疗仪器
- 有源滤波器

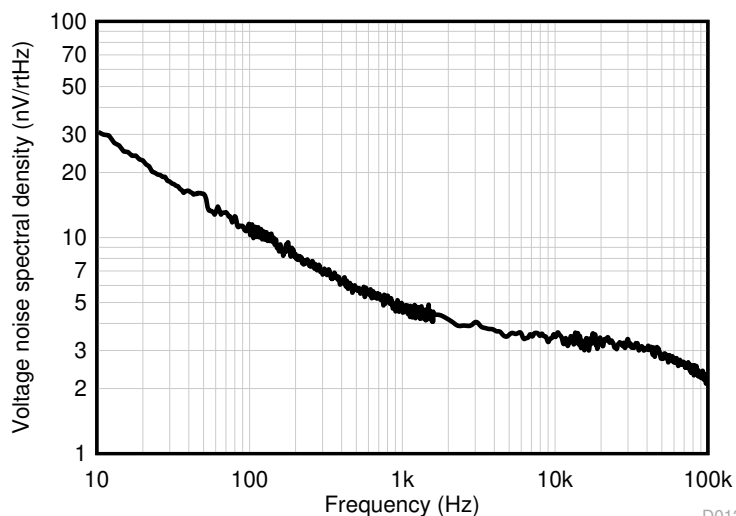

噪声频谱密度与频率间的关系

## 3 说明

OPAx375 系列包括单通道 (OPA375)、双通道 (OPA2375) 和四通道 (OPA4375) 通用 CMOS 运算放大器，这些运算放大器提供 3.5nV/ $\sqrt{\text{Hz}}$  的超低噪声系数、500 $\mu$ V (最大值) 的低失调电压和 10MHz 的高带宽。OPAx375 系列器件凭借低噪声和高带宽特性，适用于要求在成本和性能之间达到良好平衡的各种高精度应用。此外，OPAx375 的输入偏置电流支持具有高源阻抗的应用。

OPAx375 系列器件采用稳健耐用的设计，方便电路设计人员使用；这得益于该器件具有单位增益稳定性、集成的 RFI/EMI 抑制滤波器、在过驱条件下不会出现反相并且具有高静电放电 (ESD) 保护功能 (2kV HBM)。另外，电阻式开环输出阻抗使其易于在较高的容性负载下保持稳定。

该运算放大器经优化可在低电压下工作，OPA375 的工作电压低至 2.25V ( $\pm 1.125\text{V}$ )，OPA2375 和 OPA4375 的工作电压可低至 1.7V ( $\pm 0.85\text{V}$ )。所有器件的最高工作电压均为 5.5V ( $\pm 2.75\text{V}$ )，额定温度范围为  $-40^\circ\text{C}$  至  $125^\circ\text{C}$ 。

单通道 OPA375 采用小尺寸的 SC70-5 封装。双通道 OPA2375 可采用多种封装选项，其中包括 1.5mm  $\times$  2.0mm X2QFN 微型封装。

### 器件信息

器件型号 <sup>(1)</sup>	封装	封装尺寸 (标称值)
OPA375	SC70 (5)	1.25mm $\times$ 2.00mm
OPA2375	SOIC (8)	3.91mm $\times$ 4.90mm
	TSSOP (8)	3.00mm $\times$ 4.40mm
	VSSOP (8)	3.00mm $\times$ 3.00mm
	SOT-23 (8)	1.60mm $\times$ 2.90mm
	WSON (8)	2.00mm $\times$ 2.00mm
	X2QFN (10)	1.50mm $\times$ 2.00mm

(1) 如需了解所有可用封装，请参阅数据表末尾的可订购产品附录。



## Table of Contents

1 特性.....	1	8.4 Device Functional Modes.....	31
2 应用.....	1	<b>9 Application and Implementation.....</b>	<b>32</b>
3 说明.....	1	9.1 Application Information.....	32
4 Revision History.....	2	9.2 Single-Supply Electret Microphone Preamplifier With Speech Filter.....	32
5 Device Comparison Table.....	4	<b>10 Power Supply Recommendations.....</b>	<b>35</b>
6 Pin Configuration and Functions.....	5	<b>11 Layout.....</b>	<b>36</b>
7 Specifications.....	7	11.1 Layout Guidelines.....	36
7.1 Absolute Maximum Ratings.....	7	11.2 Layout Example.....	37
7.2 ESD Ratings.....	7	<b>12 Device and Documentation Support.....</b>	<b>39</b>
7.3 Recommended Operating Conditions.....	7	12.1 Documentation Support.....	39
7.4 Thermal Information for Single Channel.....	7	12.2 接收文档更新通知.....	39
7.5 Thermal Information for Dual Channel.....	8	12.3 支持资源.....	39
7.6 Electrical Characteristics.....	9	12.4 Trademarks.....	39
7.7 Typical Characteristics: OPA375.....	12	12.5 Electrostatic Discharge Caution.....	39
7.8 Typical Characteristics: OPA2375.....	19	12.6 术语表.....	39
<b>8 Detailed Description.....</b>	<b>26</b>	<b>13 Mechanical, Packaging, and Orderable Information.....</b>	<b>40</b>
8.1 Overview.....	26		
8.2 Functional Block Diagram.....	26		
8.3 Feature Description.....	26		

## 4 Revision History

注：以前版本的页码可能与当前版本的页码不同

Changes from Revision D (February 2021) to Revision E (August 2021)	Page
• 将 OPA2375 VSSOP (DGK) 封装从 预发布 更改为 正在供货.....	1
• Removed preview tag for the VSSOP (DGK) package in the <i>Device Comparison Table</i> section.....	4
• Added VSSOP Package thermal data for OPA2375 in the <i>Thermal Information for Dual Channel</i> section.....	7
Changes from Revision C (June 2020) to Revision D (February 2021)	Page
• 更新了整个文档中的表格、图和交叉参考的编号格式.....	1
• Changed Operating temperature from 125 to 150 in <i>Absolute Maximum Ratings</i> .....	7
• Added Junction temperature spec to <i>Absolute Maximum Ratings</i> .....	7
• Removed OPA375 Table of Graphs and OPA2375 Table of Graphs tables from the <i>Specifications</i> section....	12
• Removed <i>Related Links</i> section from the <i>Device and Documentation Support</i> section.....	39
Changes from Revision B (January 2020) to Revision C (June 2020)	Page
• 将 OPA2375S X2QFN (RUG) 封装从 预发布 更改为 正在供货.....	1
• Added X2QFN Package Drawing and Pin Functions for OPA2375S in <i>Pin Configuration and Functions</i> section.....	5
• Changed typical input current noise density value from 2 fA $\sqrt{\text{Hz}}$ to 23 fA $\sqrt{\text{Hz}}$ .....	9
• Changed total supply voltage total from 5V to 5.5V in <i>Electrical Characteristics</i> condition statement.....	9
• Deleted "Vs = 2.25 V to 5.5 V" test conditions for common-mode rejection ratio parameter in <i>Electrical Characteristics</i> .....	9
Changes from Revision A (January 2019) to Revision B (January 2020)	Page
• 更改了 特性 部分的“低宽带噪声”规格以便与 OPA2375 规格匹配.....	1
• 向 特性 部分添加了 THD+N 规格.....	1
• 在 特性 部分中添加了 OPA2375 和 OPA4375 的 I <sub>Q</sub> 定义.....	1
• 在 特性 部分中添加了 OPA2375 和 OPA4375 的电源电压范围定义.....	1

• 将首页上的噪声频谱密度与频率间的关系图更改为 OPA2375 噪声图.....	1
• 更改了 <i>说明</i> 部分的措辞以反映整个 OPAx375 系列.....	1
• 向 <i>器件信息</i> 表中添加了 OPA2375 器件.....	1
• Added <i>Device Comparison Table</i> section.....	4
• Added pin out drawings for OPA2375 packages in <i>Pin Configuration and Functions</i> section.....	5
• Added pin functions for OPA2375 packages.....	5
• Changed Human-body model (HBM) value from: $\pm 1000$ to $\pm 3000$ and Charged-device mode (CDM) value from $\pm 250$ to $\pm 1000$ .....	7
• Added OPA2375 typical characteristic graphs in the <i>Specifications</i> section.....	12
• Added <i>EMI Rejection</i> section with description information to <i>Detailed Description</i> section.....	27
• Added <i>Electrical Overstress</i> section and diagram to <i>Detailed Description</i> section.....	28
• Added <i>Typical Specification and Distributions</i> section to <i>Detailed Description</i> section.....	29
• Added <i>Shutdown Function</i> section with description for OPAx375S to <i>Detailed Description</i> section.....	30
• Added <i>Packages With an Exposed Thermal Pad</i> section to <i>Detailed Description</i> section.....	30
• Added dual channel layout example in the <i>Layout</i> section.....	37

---

<b>Changes from Revision * (November 2017) to Revision A (January 2019)</b>	<b>Page</b>
---	-------------

---

• Added maximum input offset voltage drift specification in <i>Electrical Characteristics</i> .....	9
---	---

---

## 5 Device Comparison Table

DEVICE	NO. OF CHANNELS	PACKAGE LEADS						
		SOIC D	SC-70 DCK	VSSOP DGK	WSON DSG	TSSOP PW	SOT-23 DDF	X2QFN RUG
OPA375	1	—	5	—	—	—	—	—
OPA2375	2	8	—	8	8	8	8	—
		—	—	—	—	—	—	10

## 6 Pin Configuration and Functions



图 6-1. OPA375 DCK Package  
5-Pin SC70  
Top View

表 6-1. Pin Functions: OPA375

PIN		I/O	DESCRIPTION
NAME	NO.		
+IN	1	I	Noninverting input
- IN	3	I	Inverting input
OUT	4	O	Output
V+	5	—	Positive (highest) supply
V -	2	—	Negative (lowest) supply or ground (for single-supply operation)

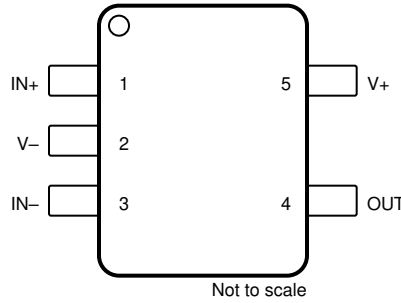

图 6-2. OPA2375 D, DGK, PW, and DDF Package  
8-Pin SOIC, VSSOP, TSSOP, and SOT-23  
Top View



Connect thermal pad to V -. See 节 8.3.8 for more information.

图 6-3. OPA2375 DSG Package  
8-Pin WSON With Exposed Thermal Pad  
Top View

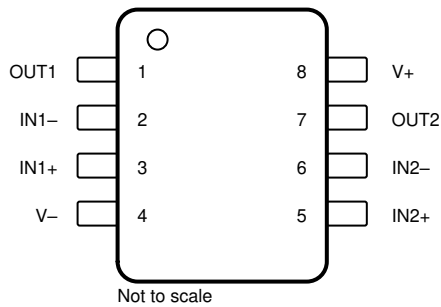
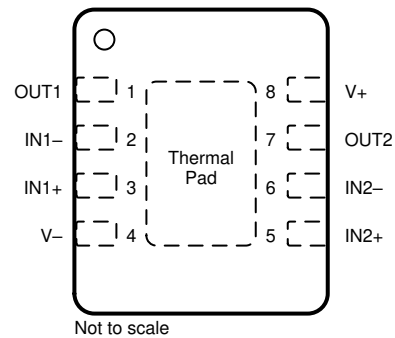
表 6-2. Pin Functions: OPA2375

PIN		I/O	DESCRIPTION
NAME	NO.		
IN1 -	2	I	Inverting input, channel 1
IN1+	3	I	Noninverting input, channel 1
IN2 -	6	I	Inverting input, channel 2
IN2+	5	I	Noninverting input, channel 2
OUT1	1	O	Output, channel 1
OUT2	7	O	Output, channel 2
V -	4	—	Negative (lowest) supply or ground (for single-supply operation)

表 6-2. Pin Functions: OPA2375 (continued)

PIN		I/O	DESCRIPTION
NAME	NO.		
V+	8	—	Positive (highest) supply



图 6-4. OPA2375S RUG Package  
10-Pin X2QFN  
Top View

表 6-3. Pin Functions: OPA2375S

PIN		I/O	DESCRIPTION
NAME	NO.		
IN1 -	9	I	Inverting input, channel 1
IN1+	10	I	Noninverting input, channel 1
IN2 -	5	I	Inverting input, channel 2
IN2+	4	I	Noninverting input, channel 2
OUT1	8	O	Output, channel 1
OUT2	6	O	Output, channel 2
SHDN1	2	I	Shutdown: low = amp disabled, high = amp enabled. Channel 1. See 节 8.3.7 for more information.
SHDN2	3	I	Shutdown: low = amp disabled, high = amp enabled. Channel 2. See 节 8.3.7 for more information.
V -	1	I or —	Negative (lowest) supply or ground (for single-supply operation)
V+	7	I	Positive (highest) supply

## 7 Specifications

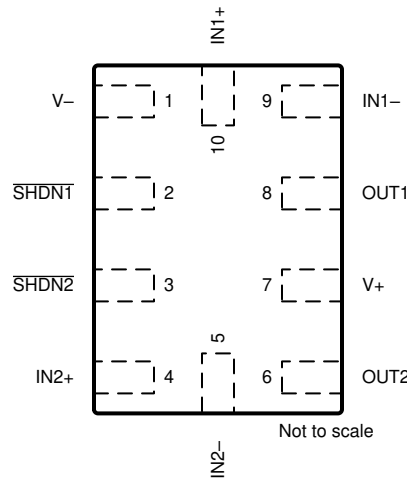
### 7.1 Absolute Maximum Ratings

over operating ambient temperature range (unless otherwise noted) <sup>(1)</sup>

		MIN	MAX	UNIT
Supply voltage, $V_S = (V+) - (V-)$		0	6	V
Signal input pins	Common-mode voltage <sup>(3) (4)</sup>	$(V-) - 0.5$	$(V+) + 0.5$	V
	Differential voltage <sup>(3)</sup>		$V_S + 0.2$	V
	Current <sup>(3)</sup>	- 10	10	mA
Output short-circuit <sup>(2)</sup>		Continuous		
Operating ambient temperature, $T_A$		- 55	150	°C
Junction temperature, $T_J$			150	°C
Storage temperature, $T_{stg}$		- 65	150	°C

- Operating the device beyond the ratings listed under *Absolute Maximum Ratings* will cause permanent damage to the device. These are stress ratings only, based on process and design limitations, and this device has not been designed to function outside the conditions indicated under *Recommended Operating Conditions*. Exposure to any condition outside *Recommended Operating Conditions* for extended periods, including absolute-maximum-rated conditions, may affect device reliability and performance.
- Short-circuit to ground, one amplifier per package.
- Input pins are diode-clamped to the power-supply rails. Input signals that may swing more than 0.5 V beyond the supply rails must be current limited to 10 mA or less.
- Differential input voltages greater than 0.25 V applied continuously can result in a shift to the input offset voltage above the maximum specification of this parameter. The magnitude of this effect increases as the ambient operating temperature rises.

### 7.2 ESD Ratings

			VALUE	UNIT
$V_{(ESD)}$	Electrostatic discharge	<b>OPA375:</b> Human-body model (HBM), per ANSI/ESDA/JEDEC JS-001 <sup>(1)</sup>	±3000	V
		<b>OPA2375:</b> Human-body model (HBM), per ANSI/ESDA/JEDEC JS-001 <sup>(1)</sup>	±2000	
		<b>All Devices:</b> Charged-device model (CDM), per JEDEC specification JESD22-C101 <sup>(2)</sup>	±1500	

- JEDEC document JEP155 states that 500-V HBM allows safe manufacturing with a standard ESD control process.
- JEDEC document JEP157 states that 250-V CDM allows safe manufacturing with a standard ESD control process.

### 7.3 Recommended Operating Conditions

over operating ambient temperature range (unless otherwise noted)

		MIN	MAX	UNIT
$V_S$	Supply voltage, $(V+) - (V-)$ , for OPA2375 and OPA4375	1.7 <sup>(1)</sup>	5.5	V
$V_S$	Supply voltage, $(V+) - (V-)$ , for OPA375 only	2.25	5.5	V
$V_I$	Input voltage range	$(V-)$	$(V+) - 1.2$	V
$T_A$	Specified temperature	- 40	125	°C

- Operation between 1.7 V and 1.8 V is only recommended for  $T_A = 0 - 85^\circ\text{C}$

### 7.4 Thermal Information for Single Channel

THERMAL METRIC <sup>(1)</sup>		OPA375	UNIT
		DCK (SC70)	
		5 PINS	
$R_{\theta JA}$	Junction-to-ambient thermal resistance	240.9	°C/W
$R_{\theta JC(top)}$	Junction-to-case (top) thermal resistance	151.7	°C/W
$R_{\theta JB}$	Junction-to-board thermal resistance	64	°C/W
$\psi_{JT}$	Junction-to-top characterization parameter	34.8	°C/W
$\psi_{JB}$	Junction-to-board characterization parameter	63.3	°C/W

### 7.4 Thermal Information for Single Channel (continued)

THERMAL METRIC <sup>(1)</sup>		OPA375	
		DCK (SC70)	
		5 PINS	
		UNIT	
$R_{\theta JC(bot)}$	Junction-to-case (bottom) thermal resistance	n/a	
		°C/W	

(1) For more information about traditional and new thermal metrics, see the *Semiconductor and IC Package Thermal Metrics* application report [SPRA953C](#).

### 7.5 Thermal Information for Dual Channel

THERMAL METRIC <sup>(1)</sup>		OPA2375, OPA2375S						UNIT
		D (SOIC)	DDF (SOT-23-8)	DSG (WSON)	PW (TSSOP)	DGK (VSSOP)	RUG (X2QFN)	
		8 PINS	8 PINS	8 PINS	8 PINS	8 PINS	10 PINS	
$R_{\theta JA}$	Junction-to-ambient thermal resistance	131.1	153.8	78.2	185.6	177.0	140.3	°C/W
$R_{\theta JC(top)}$	Junction-to-case (top) thermal resistance	73.2	80.2	97.5	74.5	68.6	52.6	°C/W
$R_{\theta JB}$	Junction-to-board thermal resistance	74.5	73.1	44.6	116.3	98.7	69.7	°C/W
$\psi_{JT}$	Junction-to-top characterization parameter	24.4	6.6	4.7	12.6	12.4	1.0	°C/W
$\psi_{JB}$	Junction-to-board characterization parameter	73.3	72.7	44.6	114.6	97.1	67.5	°C/W
$R_{\theta JC(bot)}$	Junction-to-case (bottom) thermal resistance	n/a	n/a	19.8	n/a	n/a	n/a	°C/W

(1) For more information about traditional and new thermal metrics, see the *Semiconductor and IC Package Thermal Metrics* application report, [SPRA953C](#).

## 7.6 Electrical Characteristics

**OPA2375/4375 Specifications:**  $V_S = (V+) - (V-) = 1.8\text{ V to }5.5\text{ V}$  ( $\pm 0.9\text{ V to } \pm 2.75\text{ V}$ ) at  $T_A = 25^\circ\text{C}$ ,  $R_L = 10\text{ k}\Omega$  connected to  $V_S / 2$ ,  $V_{CM} = V_S / 2$ , and  $V_{OUT} = V_S / 2$ , unless otherwise noted.

**OPA375 Specifications:**  $V_S = (V+) - (V-) = 5.5\text{ V}$  at  $T_A = 25^\circ\text{C}$ ,  $R_L = 10\text{ k}\Omega$  connected to  $V_S / 2$ ,  $V_{CM} = V_S / 2$ , and  $V_{OUT} = V_S / 2$ , unless otherwise noted.

PARAMETER		TEST CONDITIONS		MIN	TYP	MAX	UNIT
<b>OFFSET VOLTAGE</b>							
$V_{OS}$	Input offset voltage	$V_S = 5.0\text{ V}$			$\pm 0.15$	$\pm 0.5$	mV
			$T_A = -40^\circ\text{C to }125^\circ\text{C}$	OPA2/4375 <sup>(3)</sup>		$\pm 0.7$	
$dV_{OS}/dT$	Input offset voltage drift		$T_A = -40^\circ\text{C to }125^\circ\text{C}$	OPA375 <sup>(2)</sup>	$\pm 0.35$	$\pm 2$ <sup>(4)</sup>	$\mu\text{V}/^\circ\text{C}$
				OPA2/4375 <sup>(3)</sup>	$\pm 0.16$		
PSRR	Input offset voltage versus power supply	$V_S = 2.25\text{ V to }5.5\text{ V}, V_{CM} = V-$		OPA375 <sup>(2)</sup>	$\pm 0.32$	$\pm 6.3$	$\mu\text{ V/V}$
		$V_{VCM} = V-$		OPA2/4375 <sup>(3)</sup>	$\pm 0.7$	$\pm 5.8$	
	Channel separation	$f = 20\text{ kHz}$			130		dB
<b>INPUT BIAS CURRENT</b>							
$I_B$	Input bias current			OPA375 <sup>(2)</sup>	$\pm 10$		pA
				OPA2/4375 <sup>(3)</sup>	$\pm 3$		
$I_{OS}$	Input offset current			OPA375 <sup>(2)</sup>	$\pm 10$		
				OPA2/4375 <sup>(3)</sup>	$\pm 0.5$		
<b>NOISE</b>							
$E_N$	Input voltage noise	$f = 0.1\text{ to }10\text{ Hz}$			1.2		$\mu\text{ V}_{PP}$
					0.227		$\mu\text{V}_{RMS}$
$e_N$	Input voltage noise density	$f = 10\text{ Hz}$		OPA2/4375 <sup>(3)</sup>	30		$\text{nV}/\sqrt{\text{Hz}}$
		$f = 1\text{ kHz}$		OPA375 <sup>(2)</sup>	5.0		
		$f = 1\text{ kHz}$		OPA2/4375 <sup>(3)</sup>	4.6		
		$f = 10\text{ kHz}$		OPA375 <sup>(2)</sup>	3.7		
		$f = 10\text{ kHz}$		OPA2/4375 <sup>(3)</sup>	3.5		
$i_N$	Input current noise	$f = 1\text{ kHz}$			23		$\text{fA}/\sqrt{\text{Hz}}$
<b>INPUT VOLTAGE RANGE</b>							
$V_{CM}$	Common-mode voltage range			(V-)		(V+) - 1.2	V
CMRR	Common-mode rejection ratio	$(V-) < V_{CM} < (V+) - 1.2\text{ V}$		OPA375 <sup>(2)</sup>	95	120	dB
		$V_S = 1.8\text{ V}, (V-) < V_{CM} < (V+) - 1.2\text{ V}$		OPA2/4375 <sup>(3)</sup>	87	100	
		$V_S = 5.5\text{ V}, (V-) < V_{CM} < (V+) - 1.2\text{ V}$			94	110	
<b>INPUT CAPACITANCE</b>							
$Z_{ID}$	Differential				10    6		M $\Omega$    pF
$Z_{ICM}$	Common-mode				10    6		G $\Omega$    pF
<b>OPEN-LOOP GAIN</b>							
$A_{OL}$	Open-loop voltage gain	$(V-) + 40\text{ mV} < V_O < (V+) - 40\text{ mV}, R_L = 10\text{ k}\Omega$ to $V_S/2$		OPA375 <sup>(2)</sup>	125		dB
		$(V-) + 150\text{ mV} < V_O < (V+) - 150\text{ mV}, R_L = 2\text{ k}\Omega$ to $V_S/2$			110	130	
		$V_S = 1.8\text{ V}, (V-) + 150\text{ mV} < V_O < (V+) - 150\text{ mV}, R_L = 2\text{ k}\Omega$ to $V_S/2$		107	130		
		$V_S = 5.5\text{ V}, (V-) + 150\text{ mV} < V_O < (V+) - 150\text{ mV}, R_L = 2\text{ k}\Omega$ to $V_S/2$			140		
		$V_S = 1.8\text{ V}, (V-) + 40\text{ mV} < V_O < (V+) - 40\text{ mV}, R_L = 10\text{ k}\Omega$ to $V_S/2$		110	132		
		$V_S = 5.5\text{ V}, (V-) + 40\text{ mV} < V_O < (V+) - 40\text{ mV}, R_L = 10\text{ k}\Omega$ to $V_S/2$			142		

**OPA375, OPA2375**

ZHCSH34E – NOVEMBER 2017 – REVISED AUGUST 2021

**OPA2375/4375 Specifications:**  $V_S = (V+) - (V-) = 1.8\text{ V to }5.5\text{ V} (\pm 0.9\text{ V to } \pm 2.75\text{ V})$  at  $T_A = 25^\circ\text{C}$ ,  $R_L = 10\text{ k}\Omega$  connected to  $V_S / 2$ ,  $V_{CM} = V_S / 2$ , and  $V_{O\ UT} = V_S / 2$ , unless otherwise noted.

**OPA375 Specifications:**  $V_S = (V+) - (V-) = 5.5\text{ V}$  at  $T_A = 25^\circ\text{C}$ ,  $R_L = 10\text{ k}\Omega$  connected to  $V_S / 2$ ,  $V_{CM} = V_S / 2$ , and  $V_{O\ UT} = V_S / 2$ , unless otherwise noted.

PARAMETER		TEST CONDITIONS		MIN	TYP	MAX	UNIT
<b>FREQUENCY RESPONSE</b>							
GBW	Gain-bandwidth product				10		MHz
SR	Slew rate	$V_S = 5.5\text{ V}, G = +1, C_L = 20\text{ pF}$			4.6		V/ $\mu\text{s}$
$t_S$	Settling time	To 0.1%, $V_S = 5.5\text{ V}, V_{STEP} = 2\text{ V}, G = +1, C_L = 20\text{ pF}$			0.65		$\mu\text{s}$
		To 0.01%, $V_S = 5.5\text{ V}, V_{STEP} = 2\text{ V}, G = +1, C_L = 20\text{ pF}$			1.2		
	Phase margin	$G = +1, R_L = 10\text{ k}\Omega, C_L = 20\text{ pF}$			55		°
	Overload recovery time	$V_{IN} \times \text{gain} > V_S$			0.2		$\mu\text{s}$
THD+N	Total harmonic distortion + noise	$V_S = 5.5\text{ V}, V_{CM} = 2.5\text{ V}, V_O = 1\text{ V}_{RMS}, G = +1, f = 1\text{ kHz}, R_L = 10\text{ k}\Omega$		OPA375 <sup>(2)</sup>	0.00035		%
				OPA2/4375 <sup>(3)</sup>	0.00015		
EMIRR	Electro-magnetic interference rejection ratio	$f = 1\text{ GHz}$		OPA2/4375 <sup>(3)</sup>	51		dB
<b>OUTPUT</b>							
	Voltage output swing from rail	Positive/Negative rail headroom	$V_S = 5.5\text{ V}, R_L = 10\text{ k}$	OPA375 <sup>(2)</sup>	8	10	mV
			$V_S = 5.5\text{ V}, R_L = \text{no load}$		7		
		Positive rail headroom	$V_S = 5.5\text{ V}, R_L = 2\text{ k}\Omega$		35		
			$V_S = 5.5\text{ V}, R_L = 10\text{ k}\Omega$	OPA2/4375 <sup>(3)</sup>	5	14	
		Negative rail headroom	$V_S = 5.5\text{ V}, R_L = \text{no load}$		7		
			$V_S = 5.5\text{ V}, R_L = 2\text{ k}\Omega$		35		
		$V_S = 5.5\text{ V}, R_L = 10\text{ k}\Omega$		5	14		
$I_{SC}$	Short-circuit current			OPA2/4375 <sup>(3)</sup>	$\pm 68$		mA
$C_{LOAD}$	Capacitive load drive				See <a href="#">7-58</a>		
$Z_O$	Open-loop output impedance	$f = 10\text{ MHz}, I_O = 0\text{ A}$		OPA375 <sup>(2)</sup>	160		$\Omega$
		$f = 2\text{ MHz}, I_O = 0\text{ A}$		OPA2/4375 <sup>(3)</sup>	165		$\Omega$
<b>POWER SUPPLY</b>							
$I_Q$	Quiescent current per amplifier	$V_S = 5.5\text{ V}, I_O = 0\text{ A}$		OPA375 <sup>(2)</sup>	890		$\mu\text{A}$
			$T_A = -40^\circ\text{C to }125^\circ\text{C}$		1100		
				OPA2/4375 <sup>(3)</sup>	990	1200	
			$T_A = -40^\circ\text{C to }125^\circ\text{C}$		1250		
	Turn-On Time	At $T_A = 25^\circ\text{C}, V_S = 5.5\text{ V}, V_S$ ramp rate $> 0.3\text{ V}/\mu\text{s}$		OPA2/4375 <sup>(3)</sup>	10		$\mu\text{s}$

**OPA2375/4375 Specifications:**  $V_S = (V+) - (V-) = 1.8\text{ V to }5.5\text{ V}$  ( $\pm 0.9\text{ V to } \pm 2.75\text{ V}$ ) at  $T_A = 25^\circ\text{C}$ ,  $R_L = 10\text{ k}\Omega$  connected to  $V_S / 2$ ,  $V_{CM} = V_S / 2$ , and  $V_{O_{UT}} = V_S / 2$ , unless otherwise noted.

**OPA375 Specifications:**  $V_S = (V+) - (V-) = 5.5\text{ V}$  at  $T_A = 25^\circ\text{C}$ ,  $R_L = 10\text{ k}\Omega$  connected to  $V_S / 2$ ,  $V_{CM} = V_S / 2$ , and  $V_{O_{UT}} = V_S / 2$ , unless otherwise noted.

PARAMETER		TEST CONDITIONS	MIN	TYP	MAX	UNIT
<b>SHUTDOWN</b>						
$I_{QSD}$	Quiescent current per amplifier	All amplifiers disabled, $\overline{\text{SHDN}} = V-$		1	3.5	$\mu\text{A}$
$Z_{\text{SHDN}}$	Output impedance during shutdown	Amplifier disabled		10    6		$\text{G}\Omega \parallel \text{pF}$
$V_{IH}$	Logic high threshold voltage (amplifier enabled)		$(V-) + 1.1\text{ V}$			V
$V_{IL}$	Logic low threshold voltage (amplifier disabled)			$(V-) + 0.2\text{ V}$		
$t_{ON}$	Amplifier enable time (full shutdown) <sup>(1)</sup>	$G = +1, V_{CM} = V-, V_O = 0.1 \times V_S / 2$		15		$\mu\text{s}$
	Amplifier enable time (partial shutdown) <sup>(1)</sup>	$G = +1, V_{CM} = V-, V_O = 0.1 \times V_S / 2$		8		
$t_{OFF}$	Amplifier disable time <sup>(1)</sup>	$V_{CM} = V-, V_O = V_S / 2$		3		
	SHDN pin input bias current (per pin)	$(V+) \geq \overline{\text{SHDN}} \geq (V-) + 0.9\text{ V}$		0.4		$\mu\text{A}$
		$(V-) \leq \overline{\text{SHDN}} \leq (V-) + 0.7\text{ V}$		0.25		

- (1) Disable time ( $t_{OFF}$ ) and enable time ( $t_{ON}$ ) are defined as the time interval between the 50% point of the signal applied to the  $\overline{\text{SHDN}}$  pin and the point at which the output voltage reaches the 10% (disable) or 90% (enable) level.
- (2) This electrical characteristic only applies to the single-channel, OPA375
- (3) This electrical characteristic only applies to the dual-channel OPA2375 and quad-channel OPA4375
- (4) Specified by design and characterization; not production tested

## 7.7 Typical Characteristics: OPA375

at  $T_A = 25^\circ\text{C}$ ,  $V_S = 5.5\text{ V}$ ,  $R_L = 10\text{ k}\Omega$  connected to  $V_S / 2$ ,  $V_{CM} = V_S / 2$ , and  $V_{OUT} = V_S / 2$  (unless otherwise noted)



图 7-1. Offset Voltage Production Distribution



图 7-2. Offset Voltage Drift Distribution

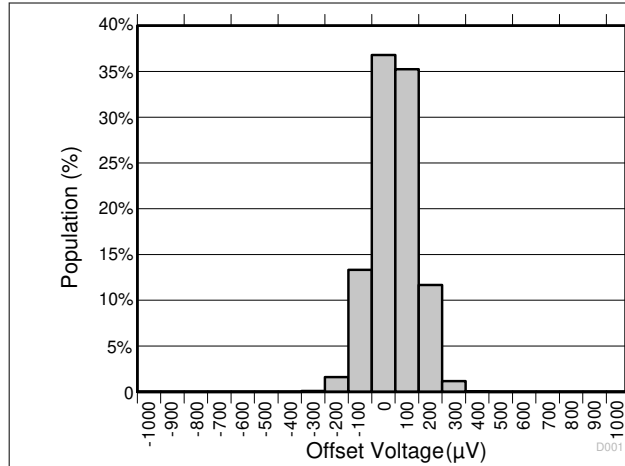

图 7-3. Offset Voltage vs Temperature

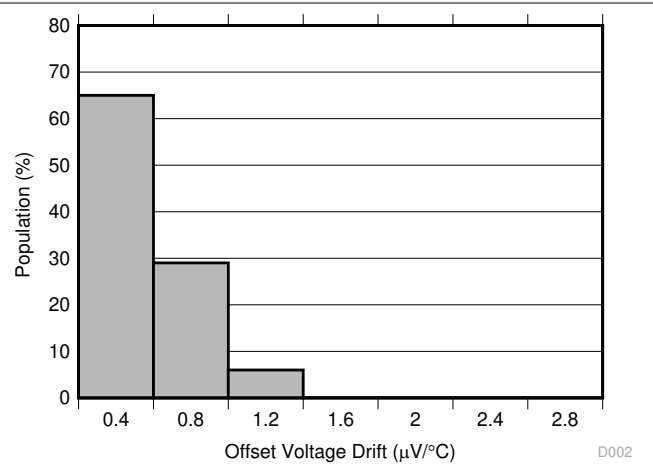

图 7-4. Offset Voltage vs Common-Mode Voltage

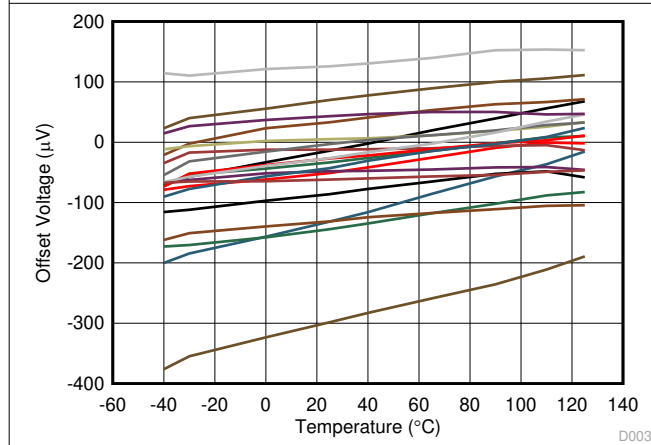

图 7-5. Offset Voltage vs Common-Mode Voltage

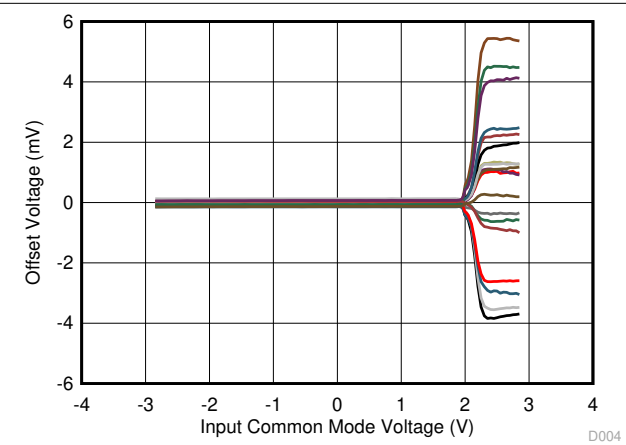

图 7-6. Offset Voltage vs Power Supply

### 7.7 Typical Characteristics: OPA375 (continued)

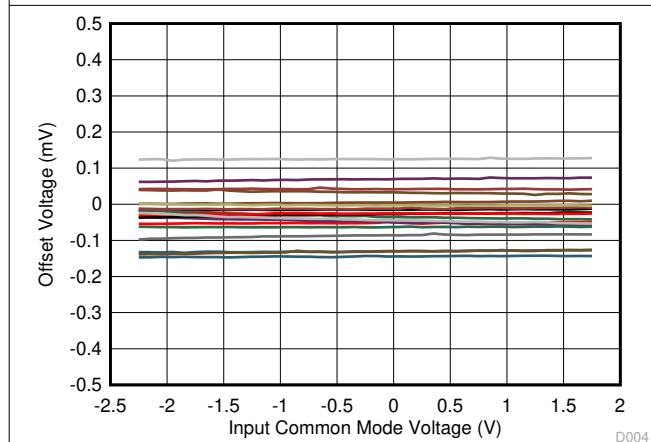
at  $T_A = 25^\circ\text{C}$ ,  $V_S = 5.5\text{ V}$ ,  $R_L = 10\text{ k}\Omega$  connected to  $V_S / 2$ ,  $V_{CM} = V_S / 2$ , and  $V_{OUT} = V_S / 2$  (unless otherwise noted)

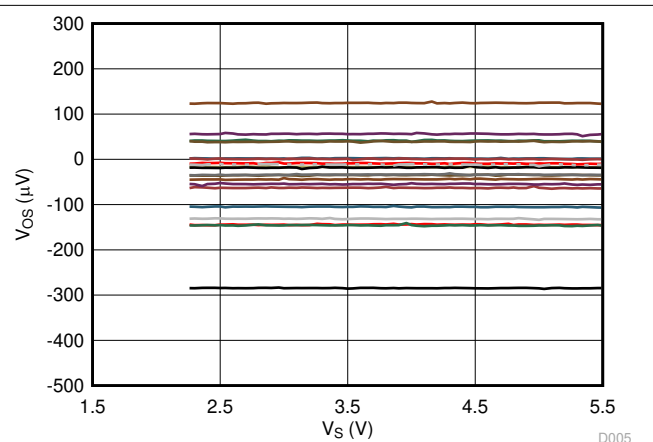

图 7-7.  $I_B$  and  $I_{OS}$  vs Common-Mode Voltage

D043

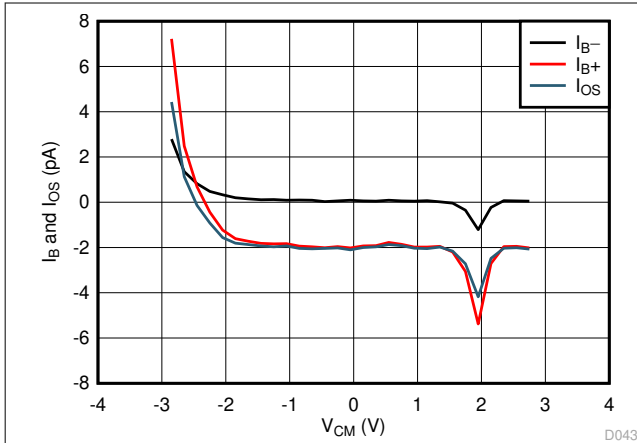

图 7-8.  $I_B$  and  $I_{OS}$  vs Temperature

D044

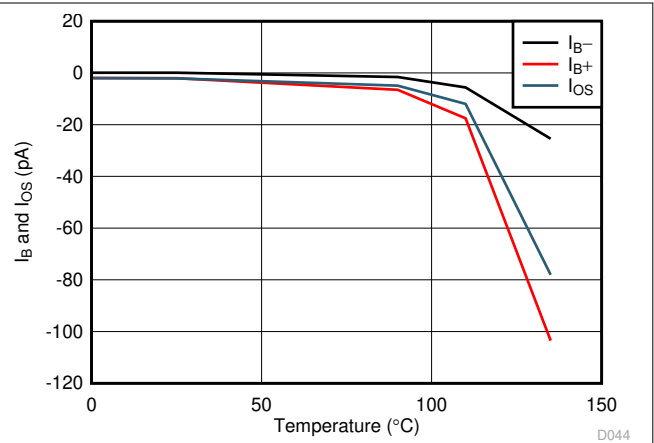

图 7-9. Open-Loop Gain and Phase vs Frequency

D006

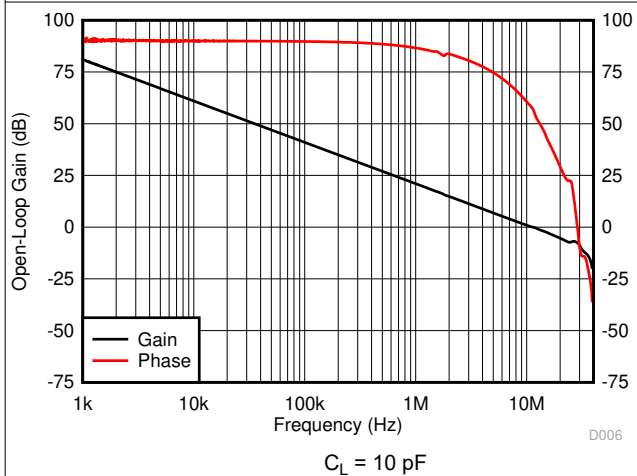

图 7-10. Closed-Loop Gain vs Frequency

D007

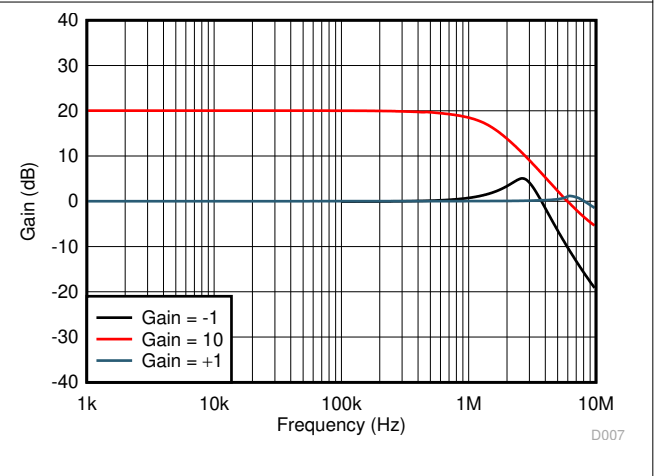

图 7-11.  $V_O$  vs  $I$  Sourcing and Sinking

D010

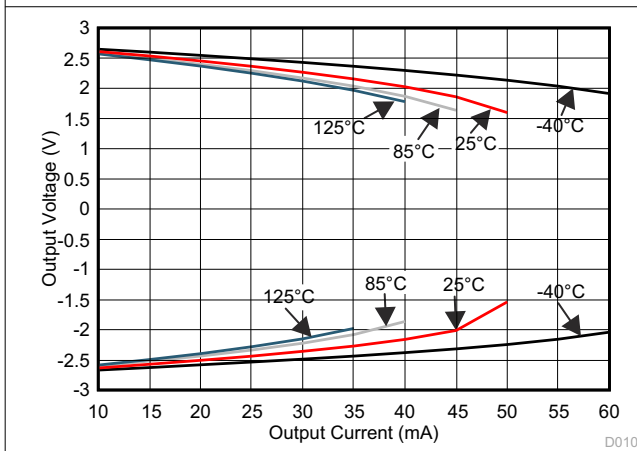

图 7-12. PSRR vs Frequency (Referred to Input)

D011

### 7.7 Typical Characteristics: OPA375 (continued)

at  $T_A = 25^\circ\text{C}$ ,  $V_S = 5.5\text{ V}$ ,  $R_L = 10\text{ k}\Omega$  connected to  $V_S / 2$ ,  $V_{CM} = V_S / 2$ , and  $V_{OUT} = V_S / 2$  (unless otherwise noted)

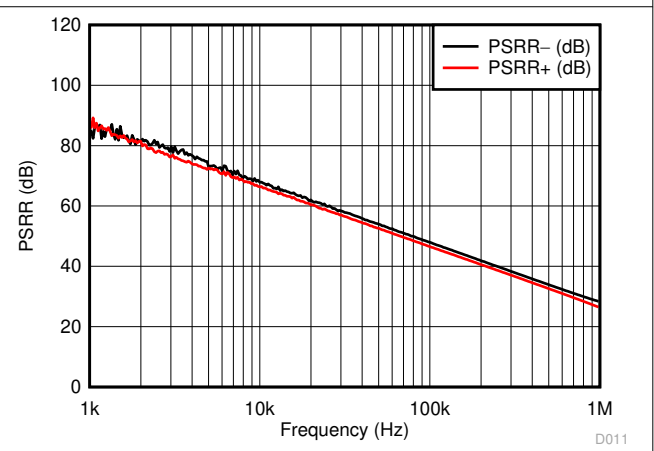

图 7-13. CMRR vs Frequency (Referred to Input)



$V_S = 5.5\text{ V}$   $T_A = -40^\circ\text{C to } 125^\circ\text{C}$   $V_{CM} = 0\text{ V to } 4.3\text{ V}$

图 7-14. CMRR vs Temperature

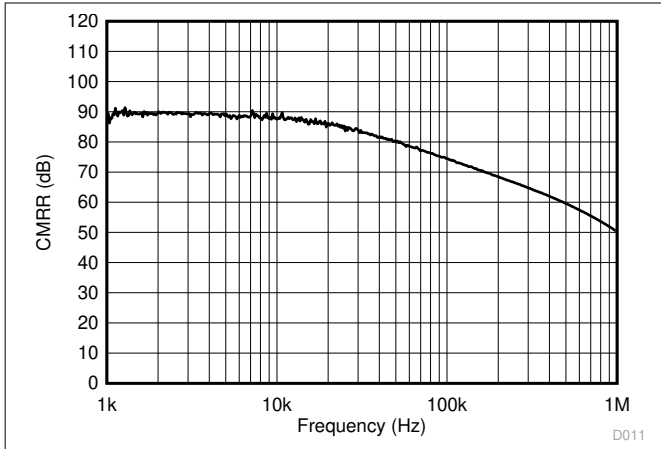
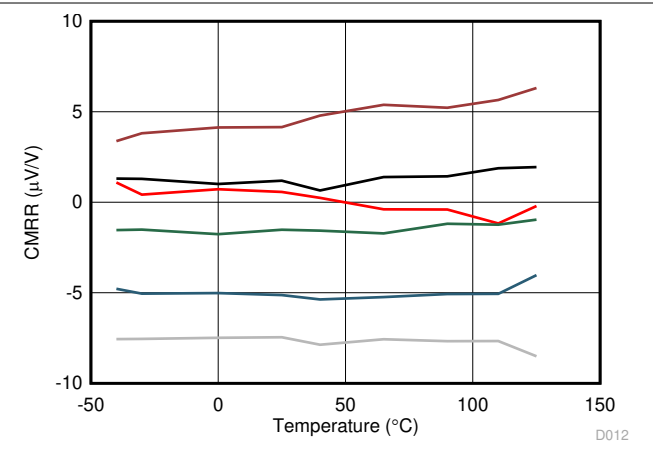

图 7-15. 0.1-Hz to 10-Hz Flicker Noise



图 7-16. Input Voltage Noise Spectral Density vs Frequency

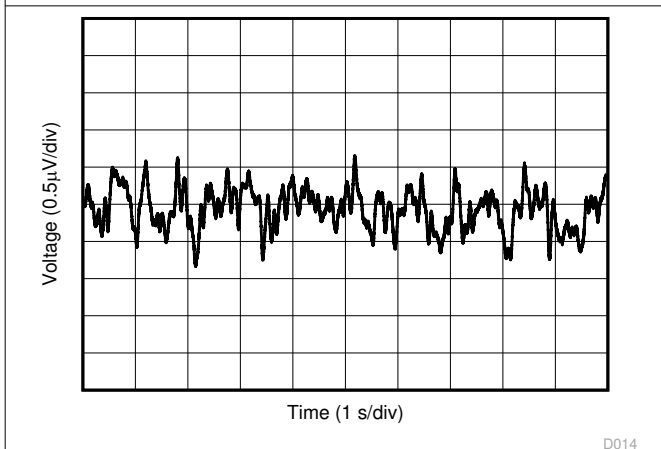

$V_S = 5.5\text{ V}$   $V_{ICM} = 2.5\text{ V}$   $R_L = 2\text{ k}\Omega$   
Gain = 1  $BW = 80\text{ kHz}$   $V_{OUT} = 0.5\text{ Vrms}$

图 7-17. THD + N vs Frequency

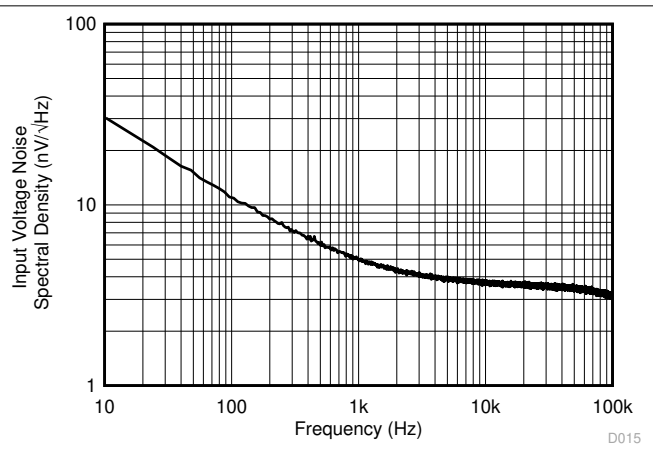
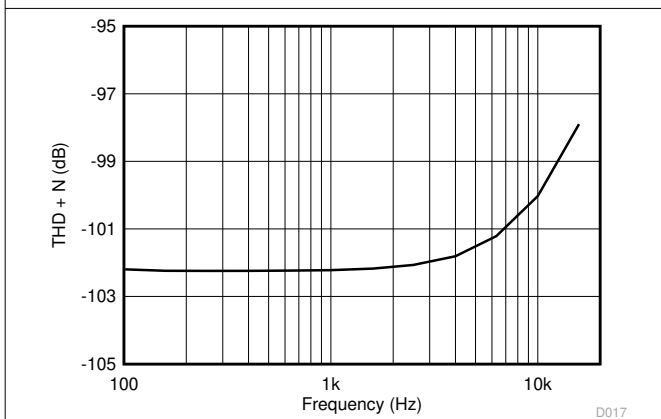
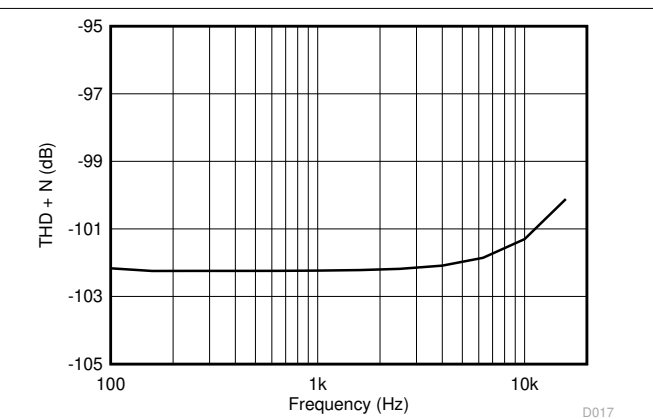

$V_S = 5.5\text{ V}$   $V_{ICM} = 2.5\text{ V}$   $R_L = 10\text{ k}\Omega$   
Gain = 1  $BW = 80\text{ kHz}$   $V_{OUT} = 0.5\text{ Vrms}$

图 7-18. THD + N vs Frequency

### 7.7 Typical Characteristics: OPA375 (continued)

at  $T_A = 25^\circ\text{C}$ ,  $V_S = 5.5\text{ V}$ ,  $R_L = 10\text{ k}\Omega$  connected to  $V_S / 2$ ,  $V_{\text{ICM}} = V_S / 2$ , and  $V_{\text{OUT}} = V_S / 2$  (unless otherwise noted)

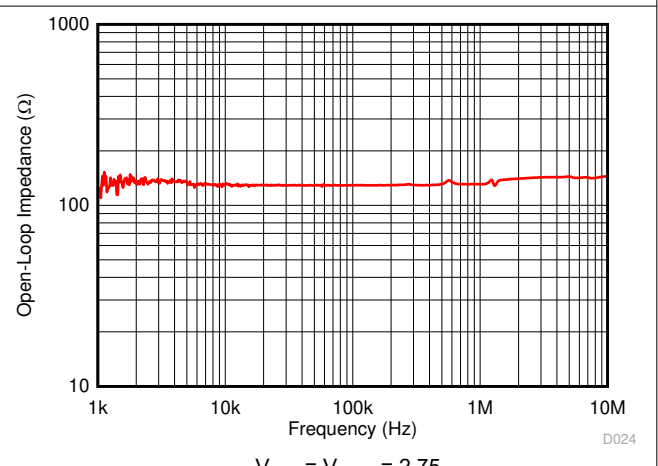
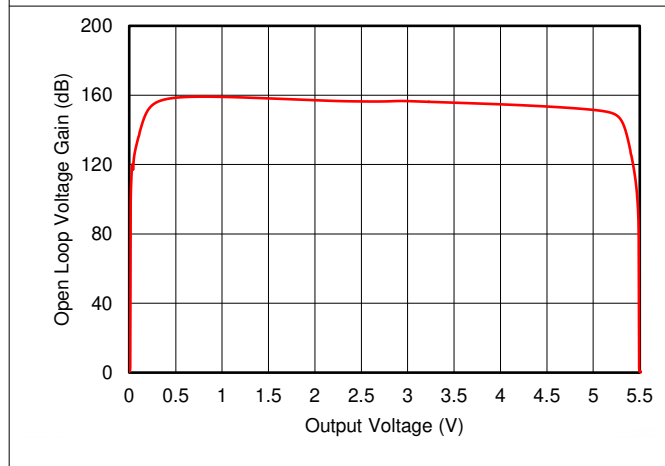
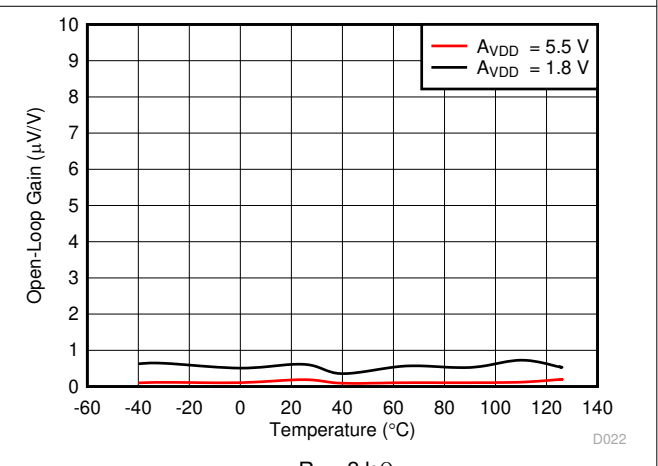
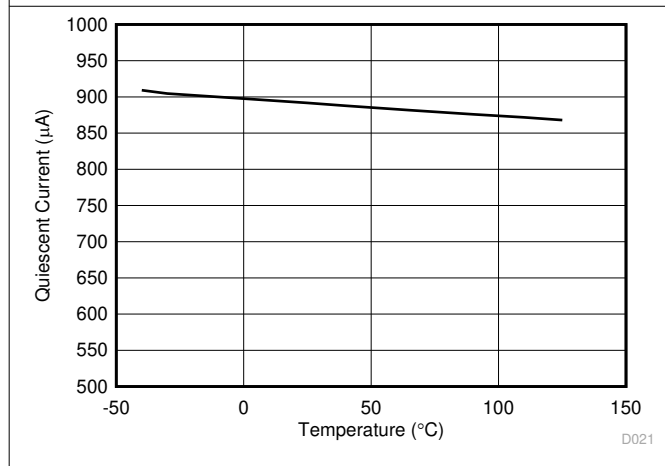
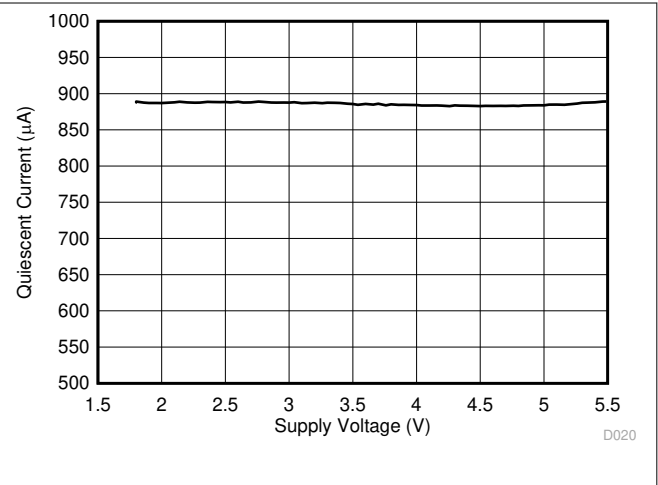
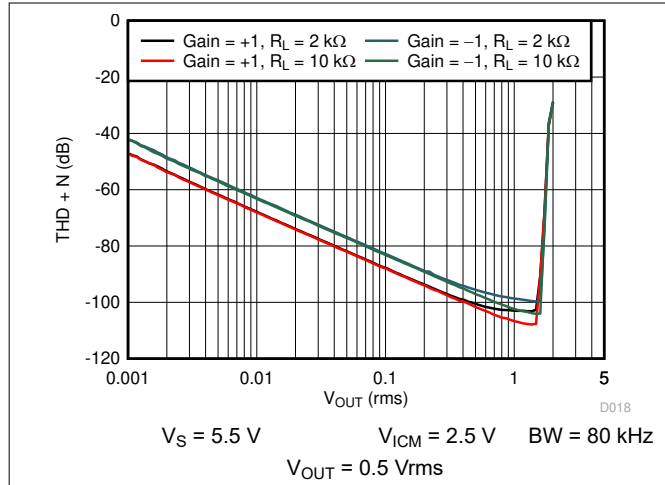

### 7.7 Typical Characteristics: OPA375 (continued)

at  $T_A = 25^\circ\text{C}$ ,  $V_S = 5.5\text{ V}$ ,  $R_L = 10\text{ k}\Omega$  connected to  $V_S / 2$ ,  $V_{CM} = V_S / 2$ , and  $V_{OUT} = V_S / 2$  (unless otherwise noted)



图 7-25. Small-Signal Overshoot vs Load Capacitance



图 7-26. Small-Signal Overshoot vs Load Capacitance

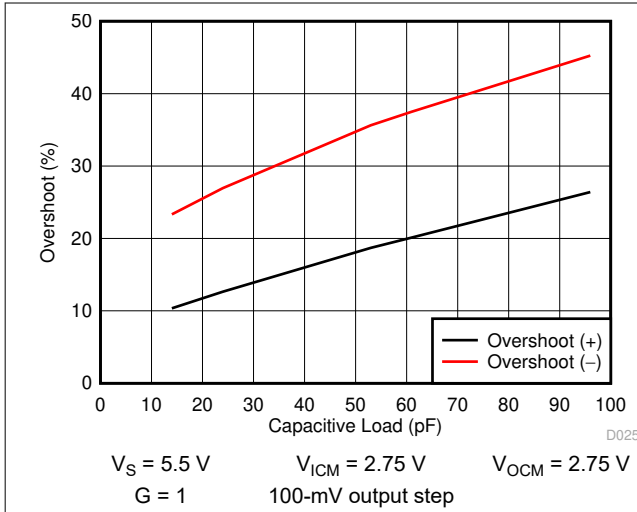

图 7-27. Small-Signal Overshoot vs Load Capacitance

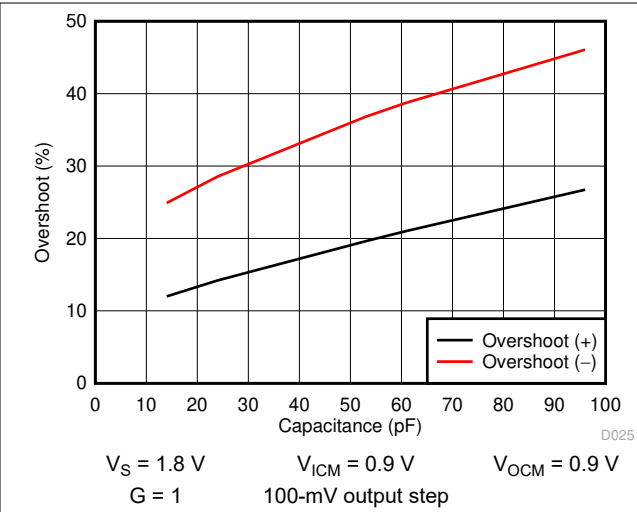

图 7-28. Small-Signal Overshoot vs Load Capacitance

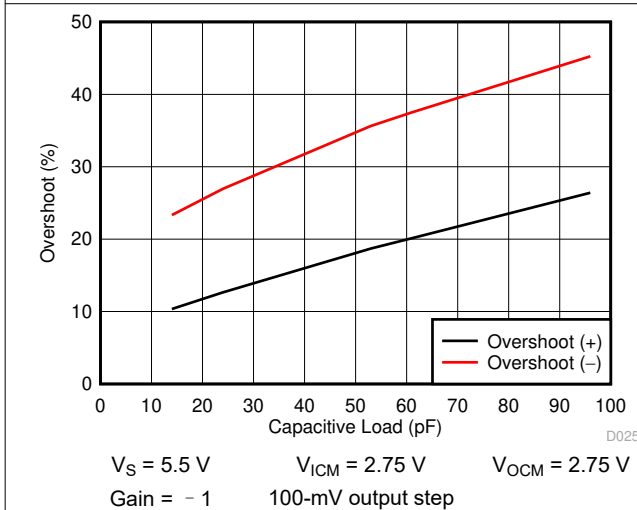

图 7-29. No Phase Reversal

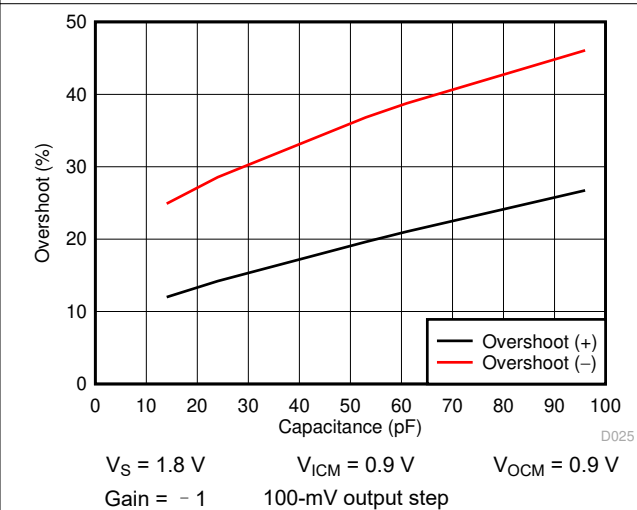

图 7-30. Overload Recovery

### 7.7 Typical Characteristics: OPA375 (continued)

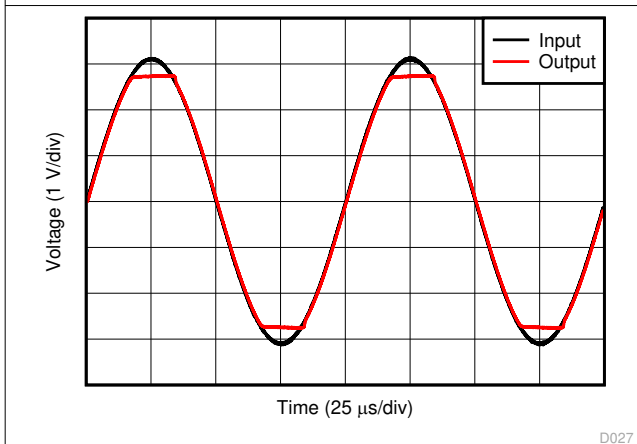
at  $T_A = 25^\circ\text{C}$ ,  $V_S = 5.5\text{ V}$ ,  $R_L = 10\text{ k}\Omega$  connected to  $V_S / 2$ ,  $V_{\text{ICM}} = V_S / 2$ , and  $V_{\text{OUT}} = V_S / 2$  (unless otherwise noted)

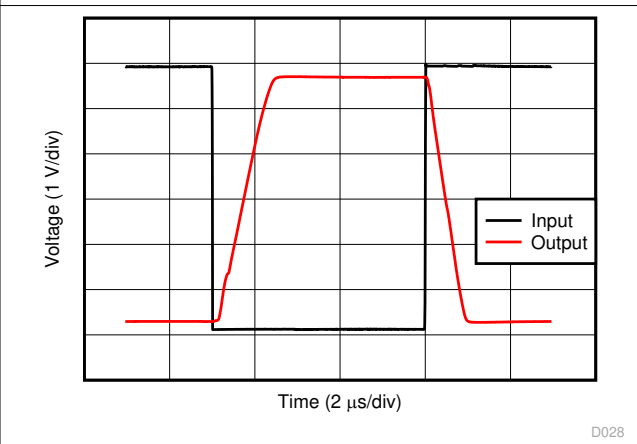
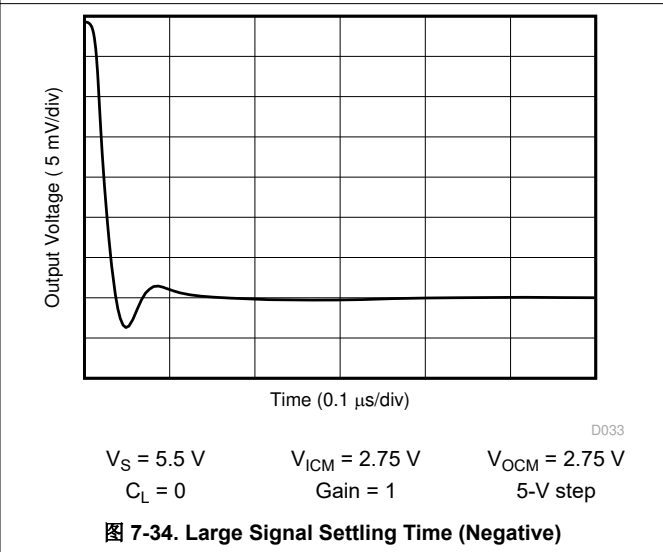
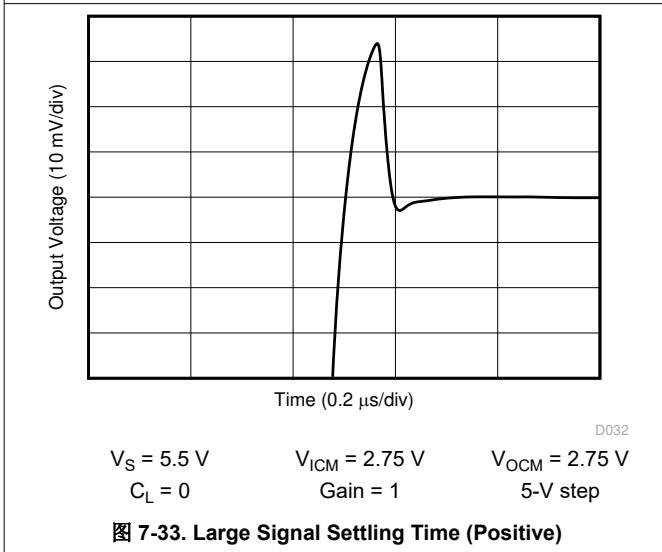
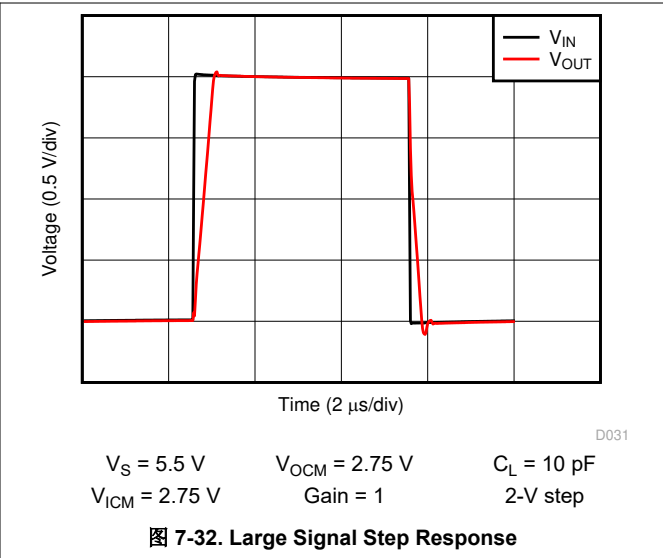
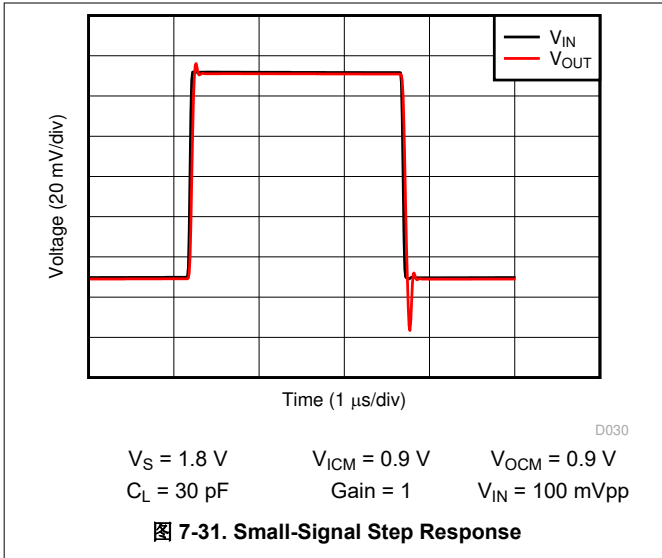

### 7.7 Typical Characteristics: OPA375 (continued)

at  $T_A = 25^\circ\text{C}$ ,  $V_S = 5.5\text{ V}$ ,  $R_L = 10\text{ k}\Omega$  connected to  $V_S / 2$ ,  $V_{CM} = V_S / 2$ , and  $V_{OUT} = V_S / 2$  (unless otherwise noted)



图 7-35. Short-Circuit Current vs Temperature



$V_{ICM} = V_S / 2$      $V_{OCM} = V_S / 2$      $C_L = 10\text{ pF}$   
Gain = 1

图 7-36. Maximum Output Voltage vs Frequency

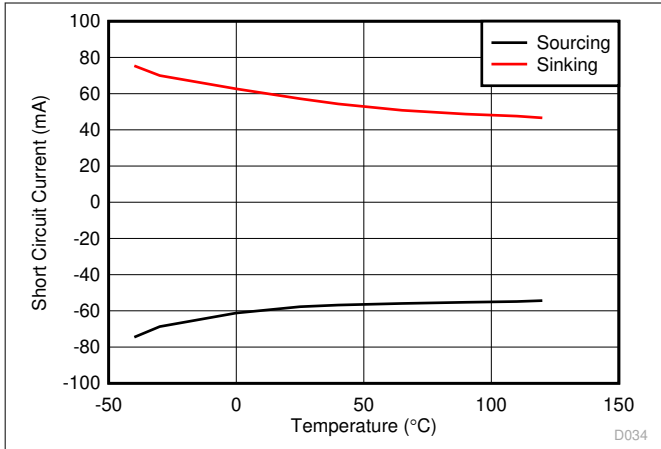
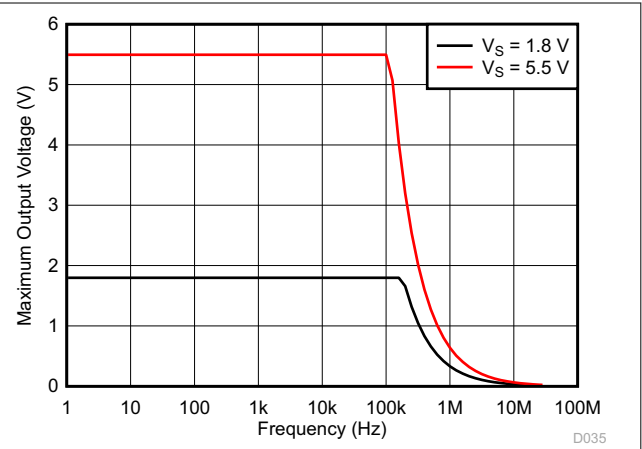

图 7-37. Electromagnetic Interference Rejection Ratio Referred to Noninverting Input (EMIRR+) vs Frequency



$V_{ICM} = V_{OCM} = V_S / 2$

图 7-38. Phase Margin vs Capacitive Load

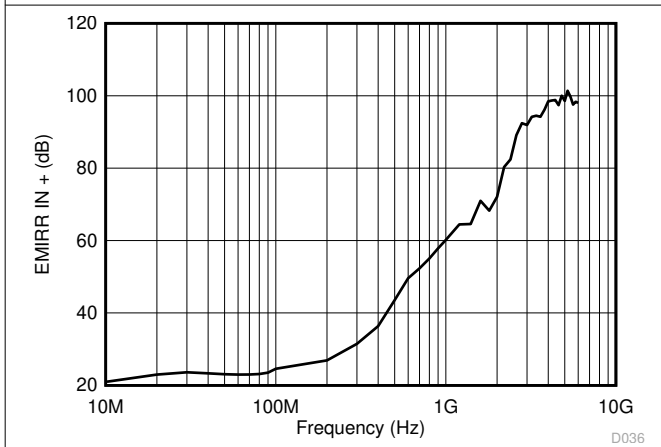
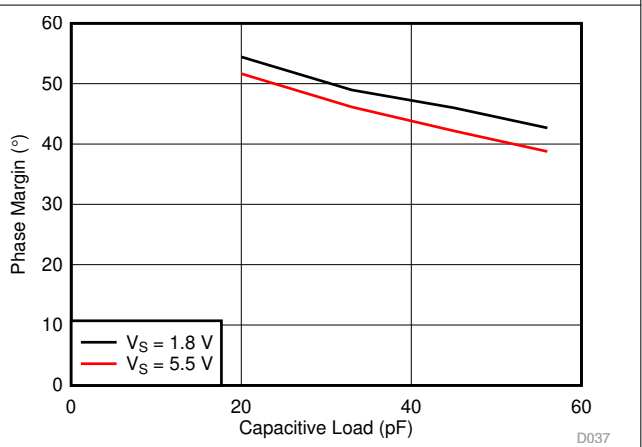
### 7.8 Typical Characteristics: OPA2375

at  $T_A = 25^\circ\text{C}$ ,  $V_S = \pm 2.75\text{ V}$ ,  $R_L = 10\text{ k}\Omega$  connected to  $V_S / 2$ ,  $V_{CM} = V_S / 2$ , and  $V_{OUT} = V_S / 2$ , unless otherwise noted.



图 7-39. Offset Voltage Production Distribution



图 7-40. Offset Voltage Drift Distribution

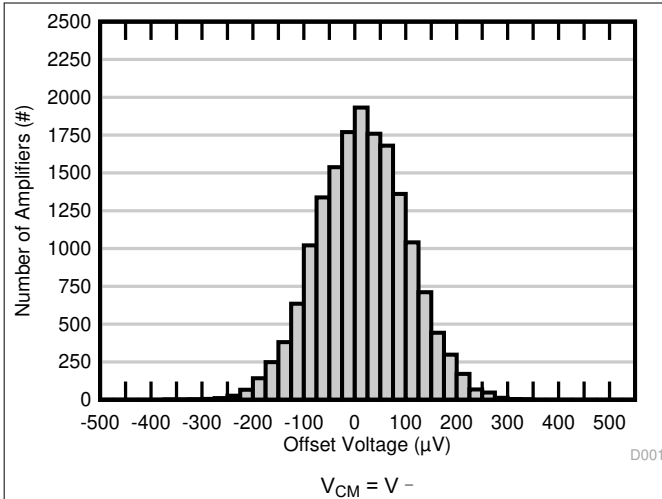

图 7-41. Offset Voltage vs Temperature (PMOS Input Pair)

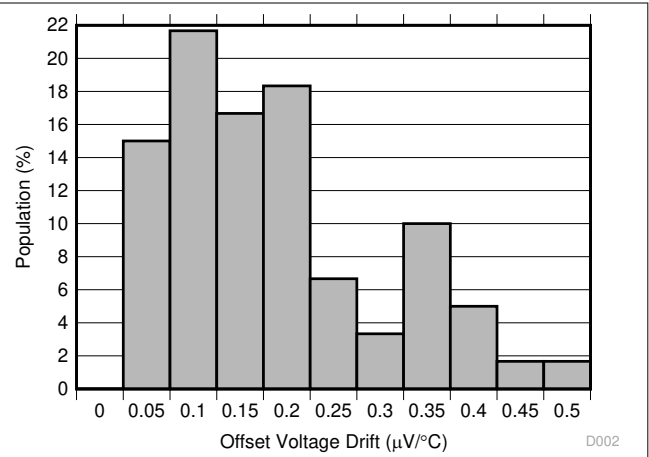

图 7-42. Offset Voltage vs Temperature (NMOS Input Pair)

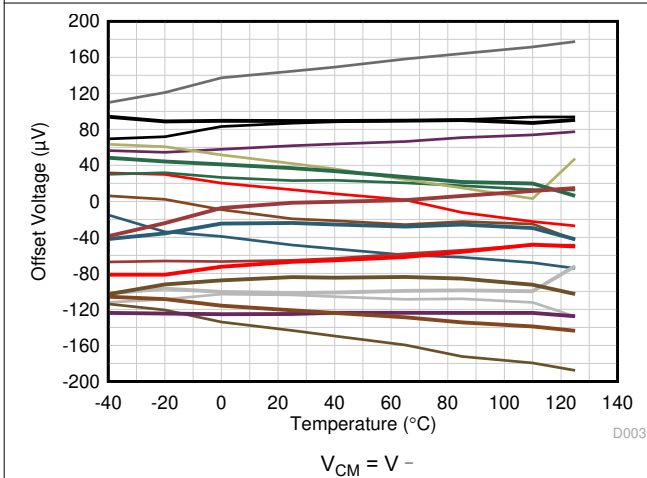

图 7-43. Offset Voltage vs Common-Mode Voltage (Full Range)

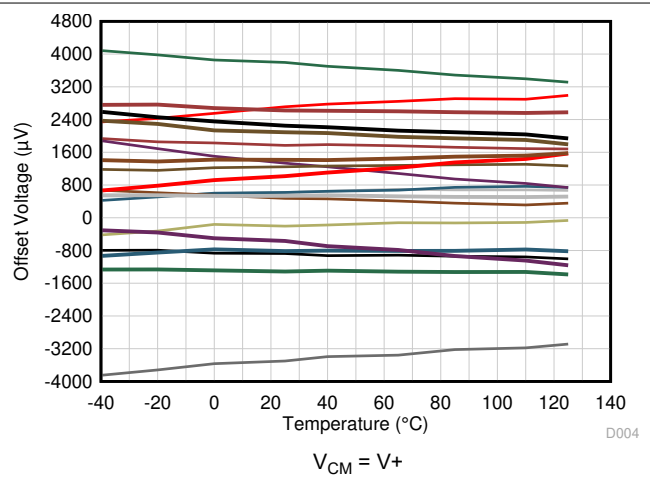

图 7-44. Offset Voltage vs Common-Mode Voltage (PMOS Input Pair)

### 7.8 Typical Characteristics: OPA2375 (continued)

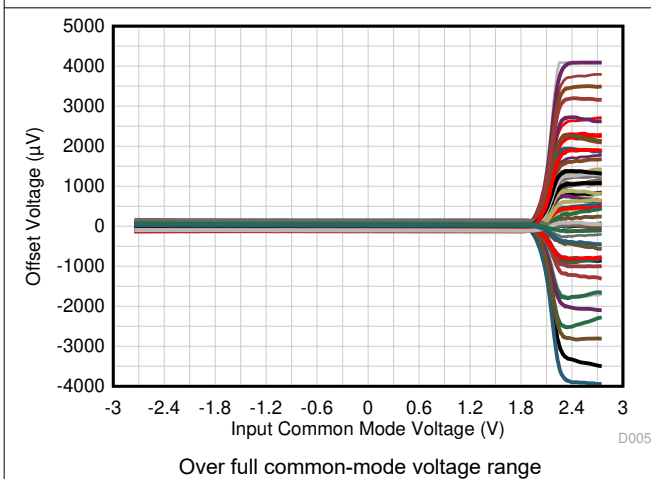
at  $T_A = 25^\circ\text{C}$ ,  $V_S = \pm 2.75\text{ V}$ ,  $R_L = 10\text{ k}\Omega$  connected to  $V_S / 2$ ,  $V_{CM} = V_S / 2$ , and  $V_{OUT} = V_S / 2$ , unless otherwise noted.

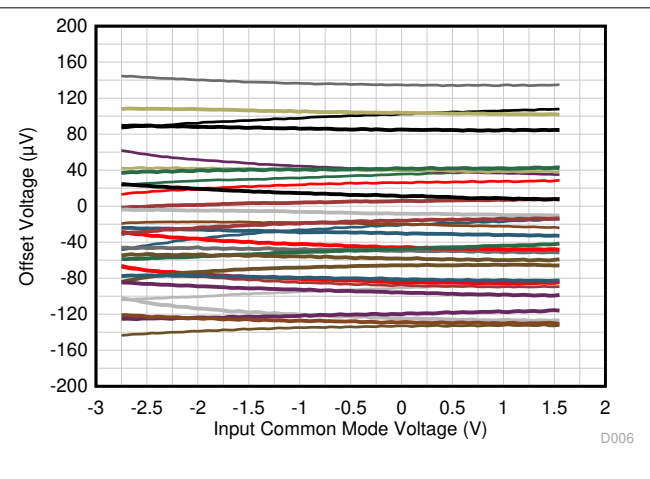

图 7-45. Offset Voltage vs Common-Mode Voltage (Transition Region)



图 7-46. Offset Voltage vs Power Supply

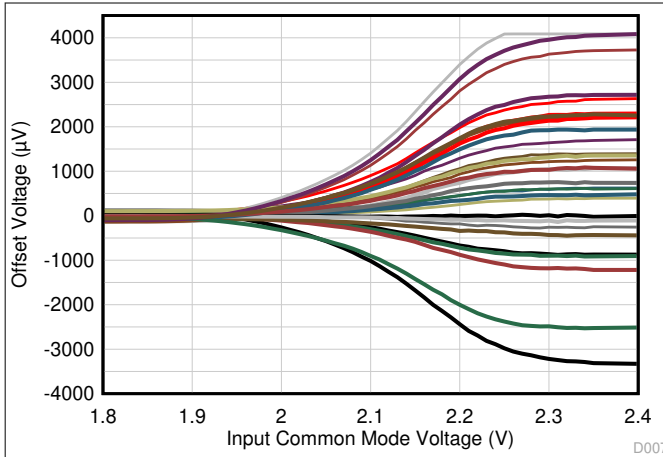

图 7-47.  $I_B$  and  $I_{OS}$  vs Common-Mode Voltage

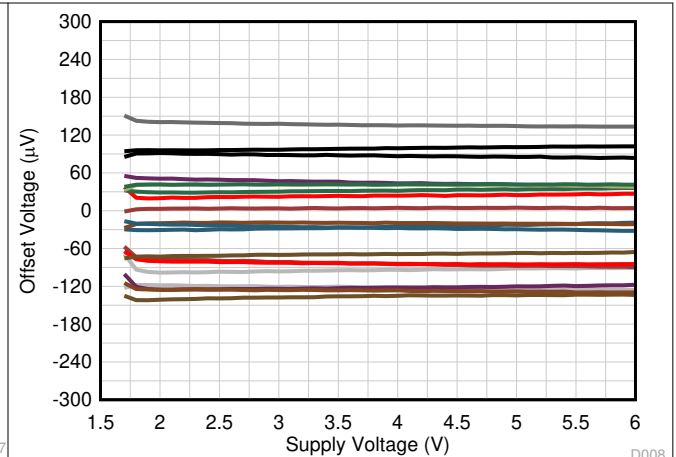

图 7-48.  $I_B$  and  $I_{OS}$  vs Temperature

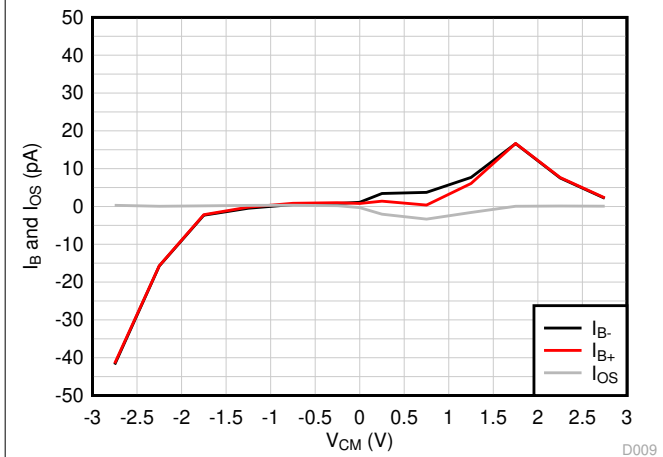

图 7-49. 0.1-Hz to 10-Hz Flicker Noise

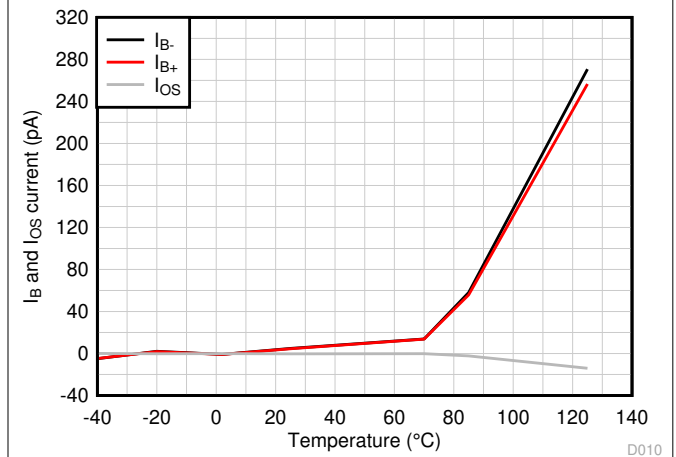

图 7-50. Input Voltage Noise Spectral Density vs Frequency

### 7.8 Typical Characteristics: OPA2375 (continued)

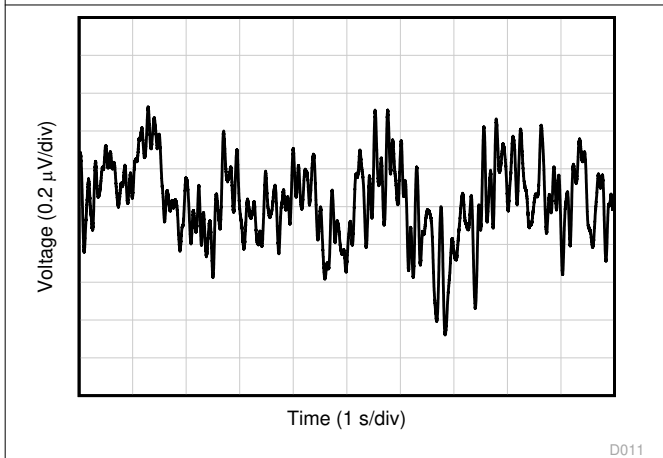
at  $T_A = 25^\circ\text{C}$ ,  $V_S = \pm 2.75\text{ V}$ ,  $R_L = 10\text{ k}\Omega$  connected to  $V_S / 2$ ,  $V_{CM} = V_S / 2$ , and  $V_{OUT} = V_S / 2$ , unless otherwise noted.

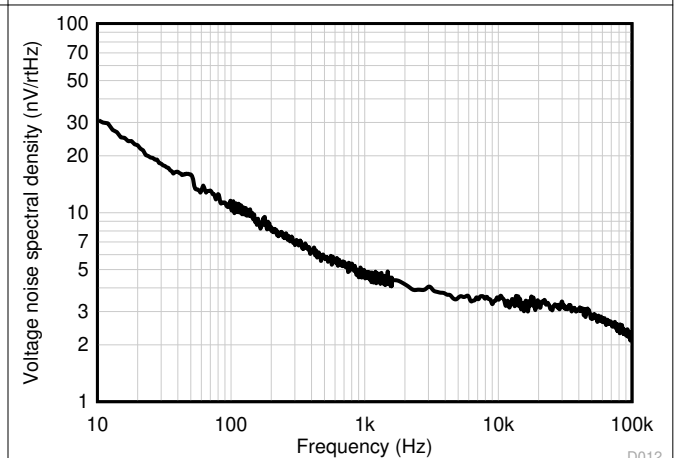

图 7-51. CMRR and PSRR vs Frequency (Referred to Input)



$V_S = 5.5\text{ V}$ ,  $V_{CM} = V^- \text{ to } (V^+) - 1.2\text{ V}$

图 7-52. CMRR vs Temperature

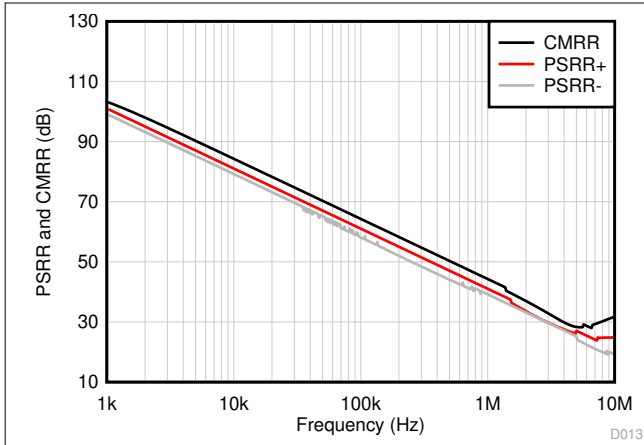
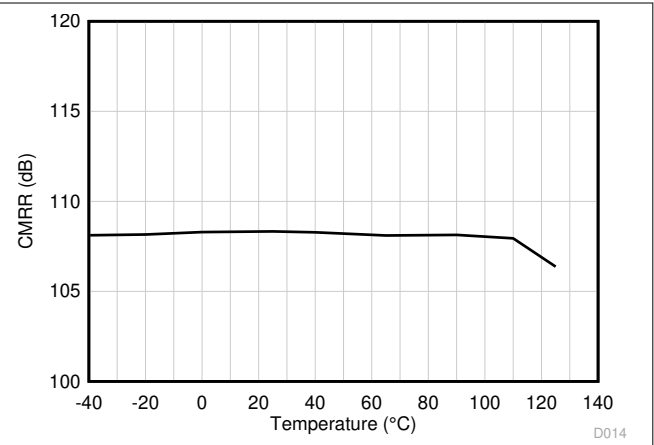
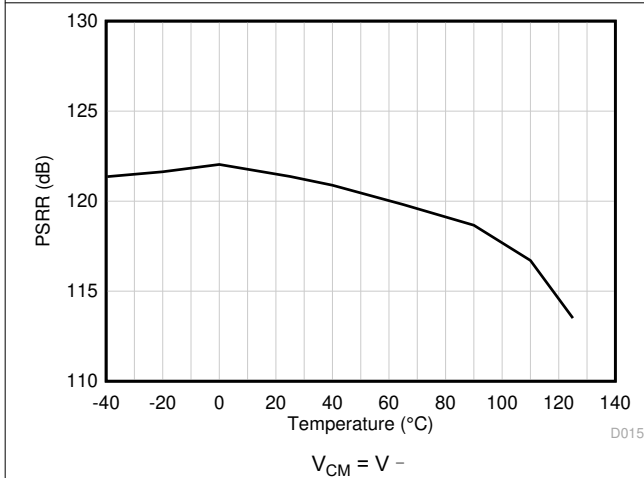

$V_{CM} = V^-$

图 7-53. PSRR vs Temperature

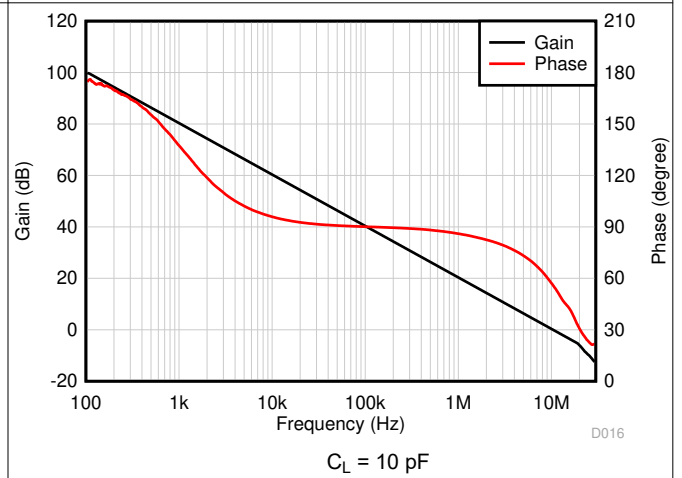

$C_L = 10\text{ pF}$

图 7-54. Open-Loop Gain and Phase vs Frequency

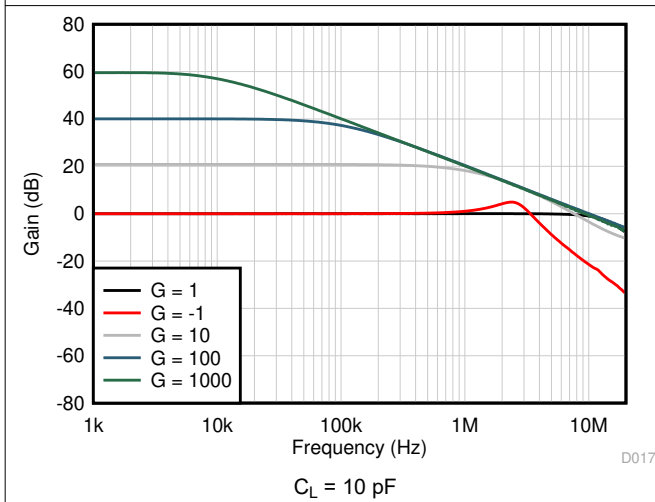

$C_L = 10\text{ pF}$

图 7-55. Closed-Loop Gain vs Frequency



图 7-56. Open-Loop Gain vs Temperature

## 7.8 Typical Characteristics: OPA2375 (continued)

at  $T_A = 25^\circ\text{C}$ ,  $V_S = \pm 2.75\text{ V}$ ,  $R_L = 10\text{ k}\Omega$  connected to  $V_S / 2$ ,  $V_{CM} = V_S / 2$ , and  $V_{OUT} = V_S / 2$ , unless otherwise noted.

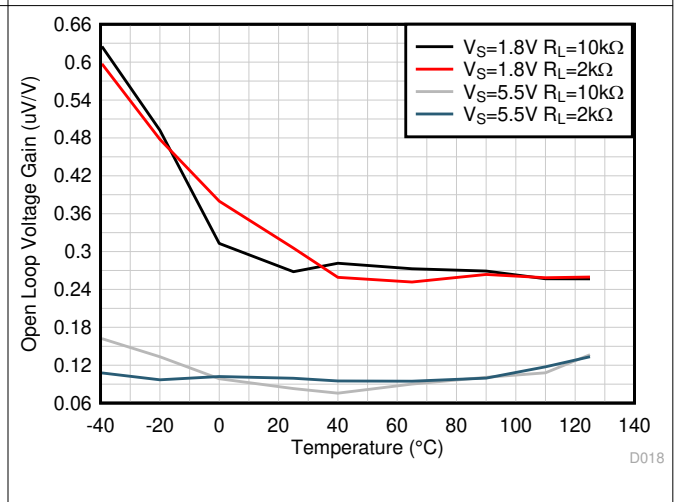
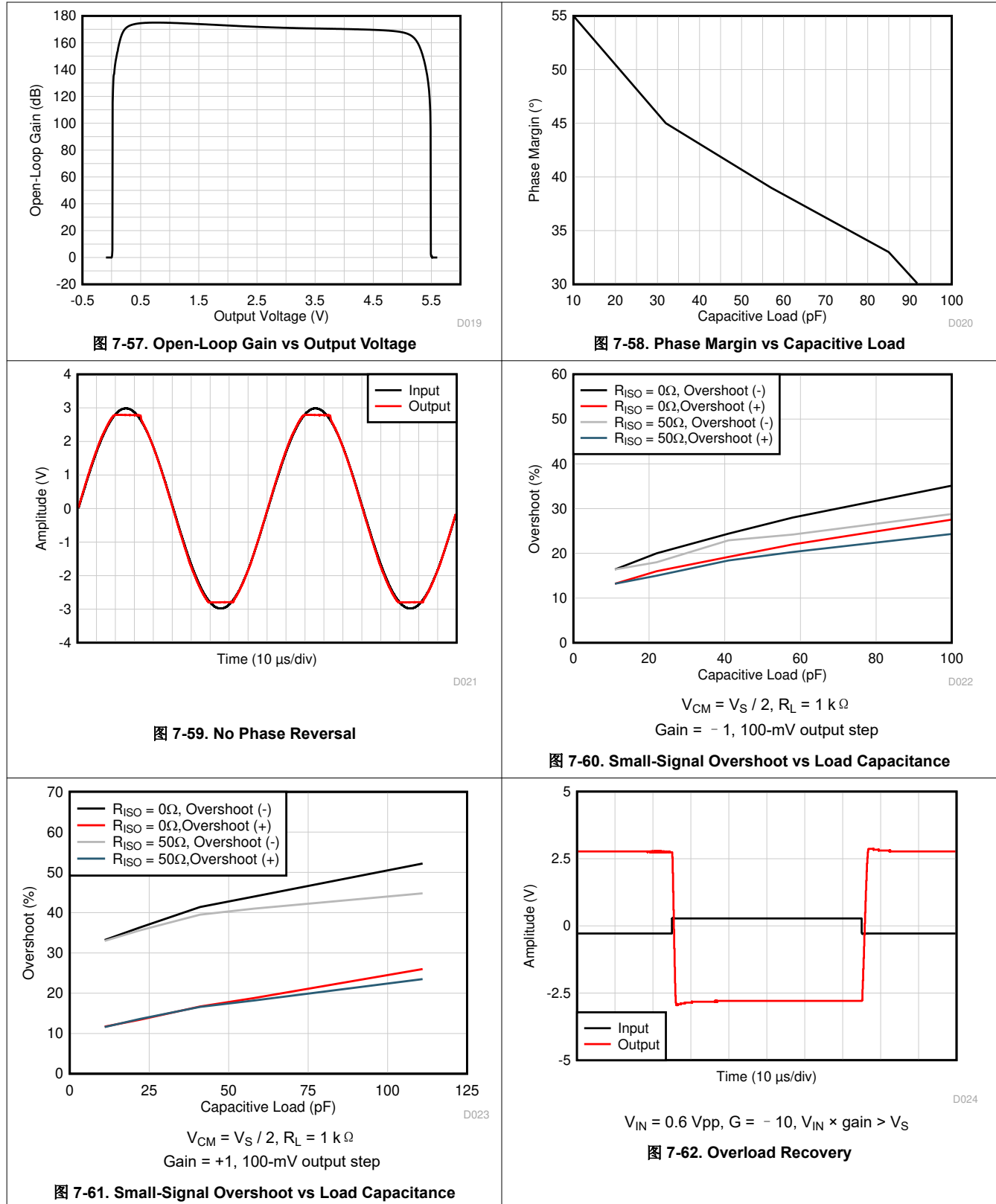

### 7.8 Typical Characteristics: OPA2375 (continued)

at  $T_A = 25^\circ\text{C}$ ,  $V_S = \pm 2.75\text{ V}$ ,  $R_L = 10\text{ k}\Omega$  connected to  $V_S / 2$ ,  $V_{CM} = V_S / 2$ , and  $V_{OUT} = V_S / 2$ , unless otherwise noted.

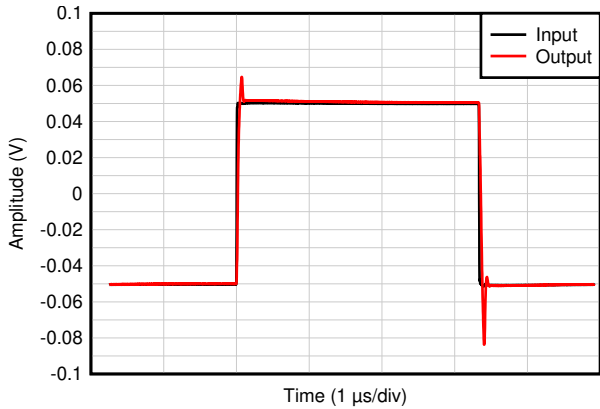

$C_L = 20\text{ pF}$ , Gain = 1,  $V_{IN} = 100\text{-mVpp}$ ,  $R_L = 1\text{ k}\Omega$

图 7-63. Small-Signal Step Response

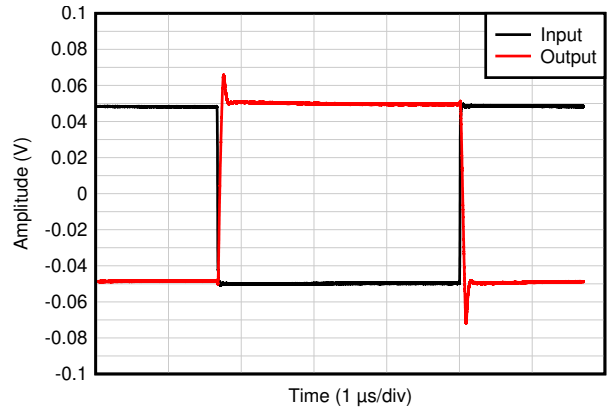

$C_L = 20\text{ pF}$ , Gain = - 1,  $V_{IN} = 100\text{-mVpp}$ ,  $R_L = 1\text{ k}\Omega$

图 7-64. Small-Signal Step Response

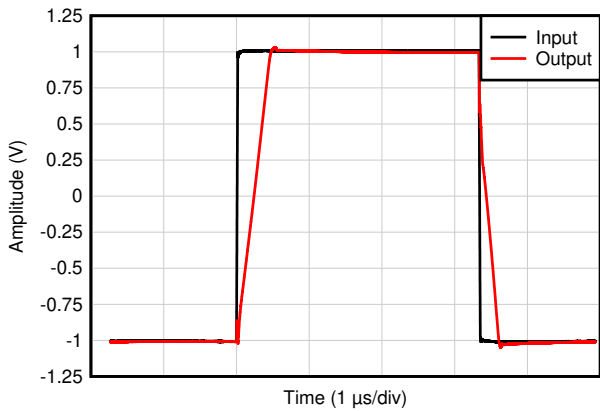

$C_L = 20\text{ pF}$ , Gain = +1,  $V_{IN} = 2\text{-V step}$ ,  $R_L = 1\text{ k}\Omega$

图 7-65. Large Signal Step Response

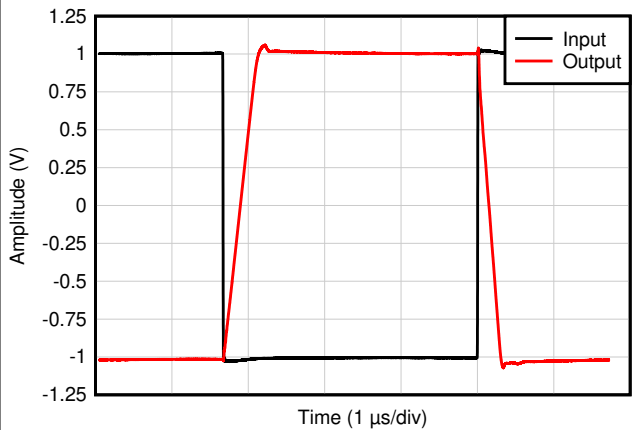

$C_L = 20\text{ pF}$ , Gain = - 1,  $V_{IN} = 2\text{-V step}$ ,  $R_L = 1\text{ k}\Omega$

图 7-66. Large Signal Step Response

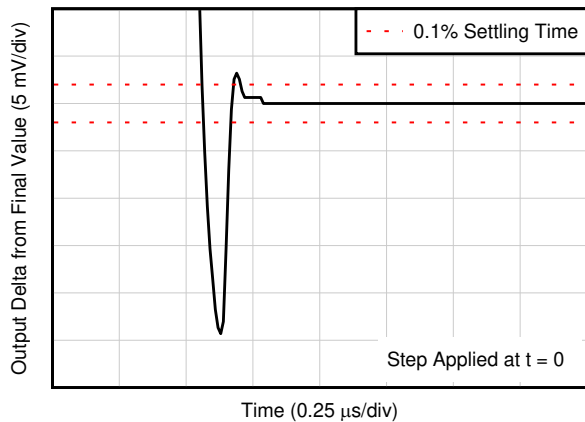

$C_L = 20\text{ pF}$ , Gain = 1,  $V_{IN} = 2\text{-V step}$

图 7-67. Large Signal Settling Time (Positive)

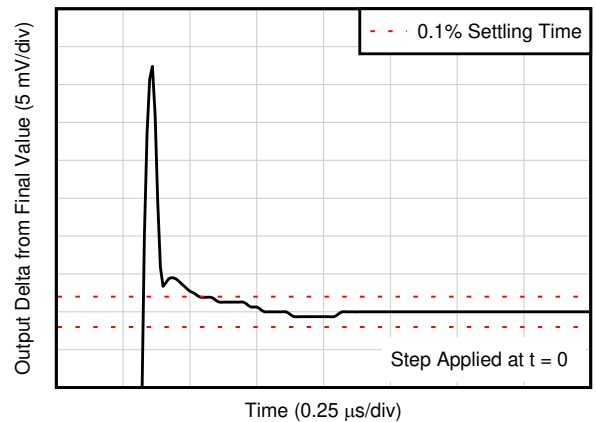

$C_L = 20\text{ pF}$ , Gain = - 1,  $V_{IN} = 2\text{-V step}$

图 7-68. Large Signal Settling Time (Negative)

## 7.8 Typical Characteristics: OPA2375 (continued)

at  $T_A = 25^\circ\text{C}$ ,  $V_S = \pm 2.75\text{ V}$ ,  $R_L = 10\text{ k}\Omega$  connected to  $V_S / 2$ ,  $V_{CM} = V_S / 2$ , and  $V_{OUT} = V_S / 2$ , unless otherwise noted.



图 7-69. THD + N vs Frequency



图 7-70. THD + N vs Amplitude

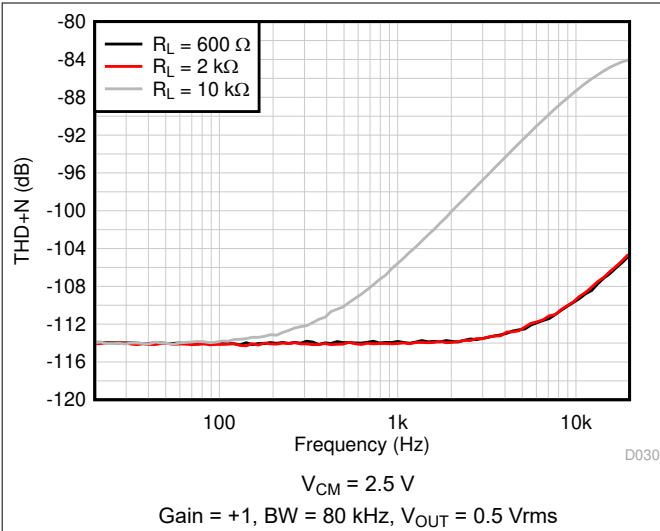

图 7-71.  $V_{OUT}$  vs Sourcing Current

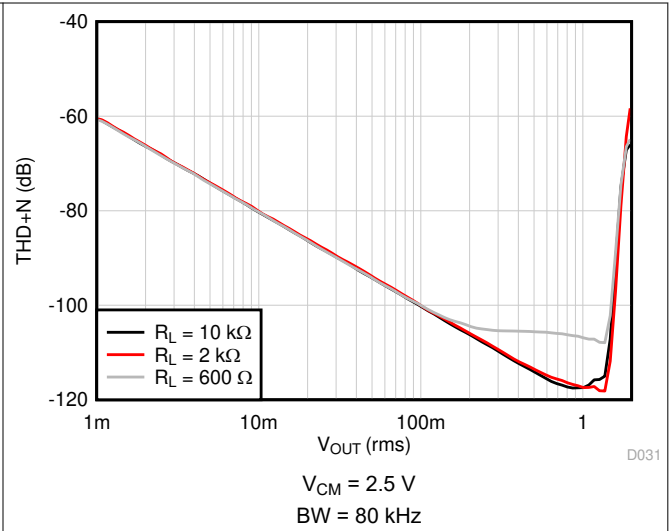

图 7-72.  $V_{OUT}$  vs Sinking Current

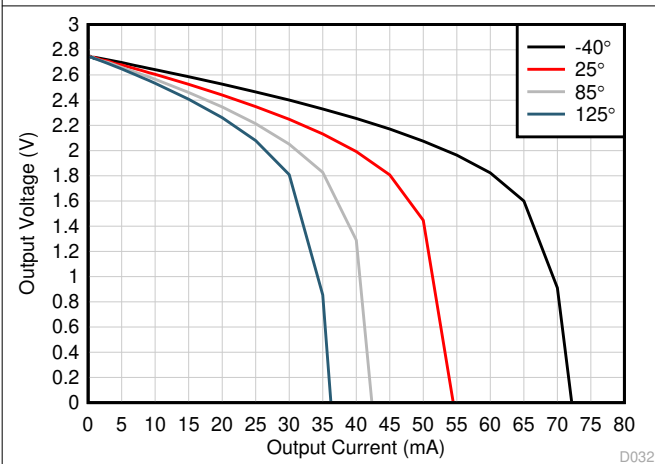

图 7-73. Maximum Output Voltage vs Frequency

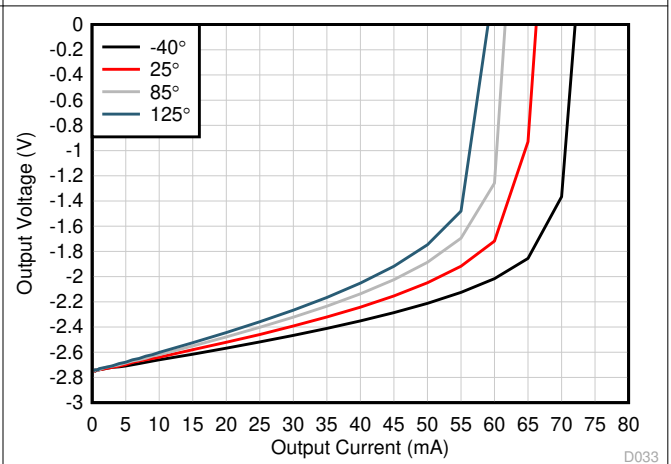

图 7-74. Short-Circuit Current vs Temperature

### 7.8 Typical Characteristics: OPA2375 (continued)

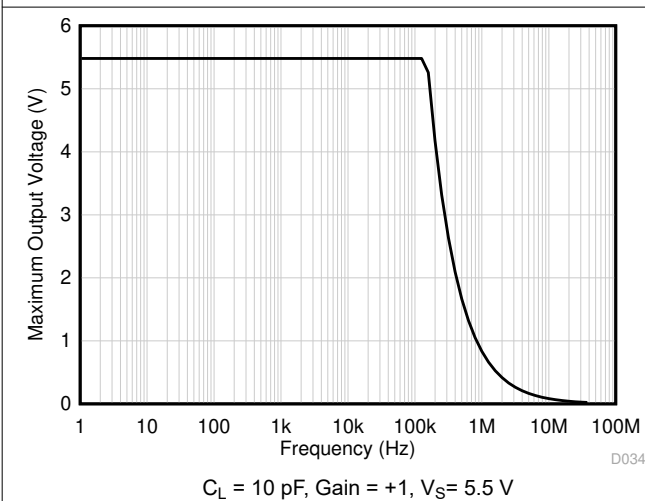
at  $T_A = 25^\circ\text{C}$ ,  $V_S = \pm 2.75\text{ V}$ ,  $R_L = 10\text{ k}\Omega$  connected to  $V_S / 2$ ,  $V_{CM} = V_S / 2$ , and  $V_{OUT} = V_S / 2$ , unless otherwise noted.

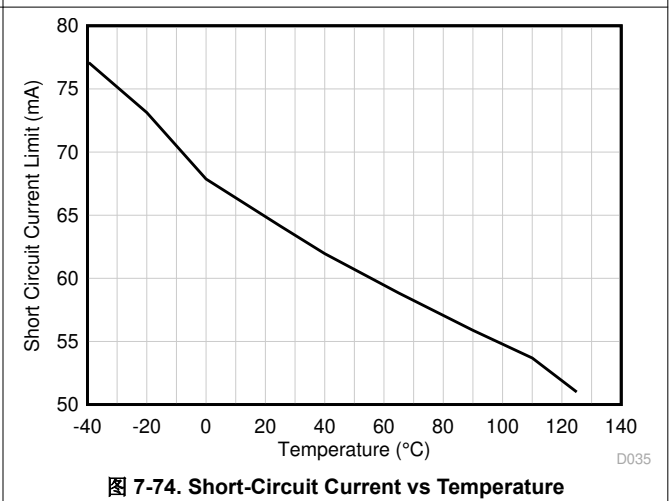

图 7-75. Quiescent Current vs Supply Voltage



图 7-76. Quiescent Current vs Temperature

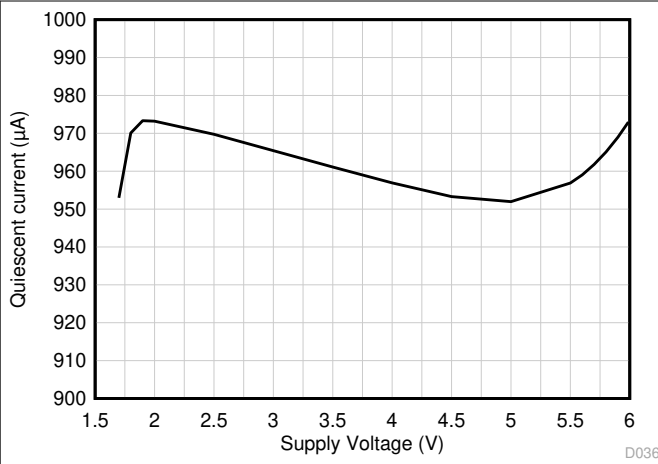

图 7-77. Open-Loop Output Impedance vs Frequency

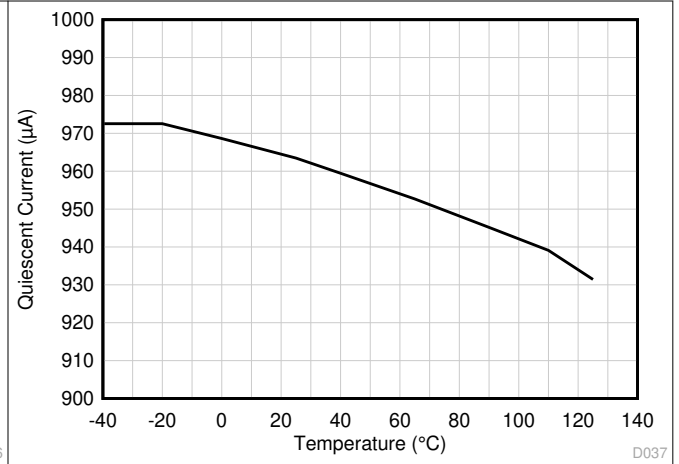

$A_{VDD} = 5.5\text{ V}$ ,  $V_{ICM} = V_{OCM} = 2.75\text{ V}$

图 7-78. Channel Separation vs Frequency

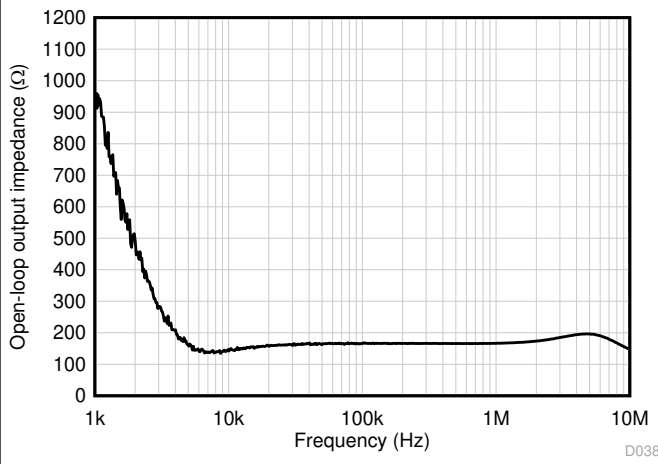
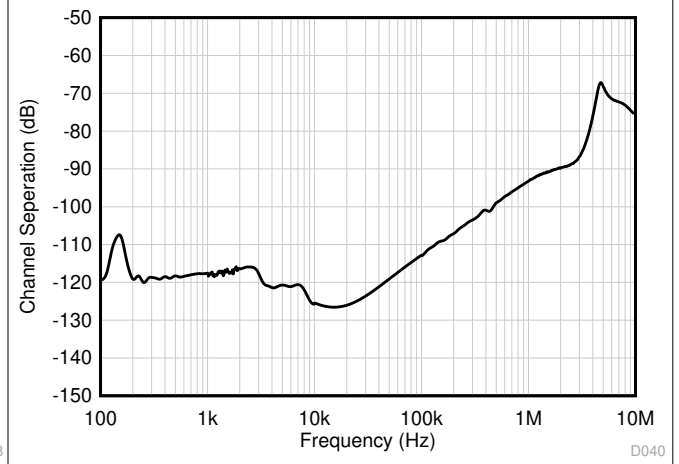

图 7-79. Electromagnetic Interference Rejection Ratio Referred to Noninverting Input (EMIRR+) vs Frequency



$V_S = 0\text{ to }5.5\text{ V}$ ,  $V_{OUT} = 0\text{ to }2.75\text{ V}$

图 7-80. Turn-On Time

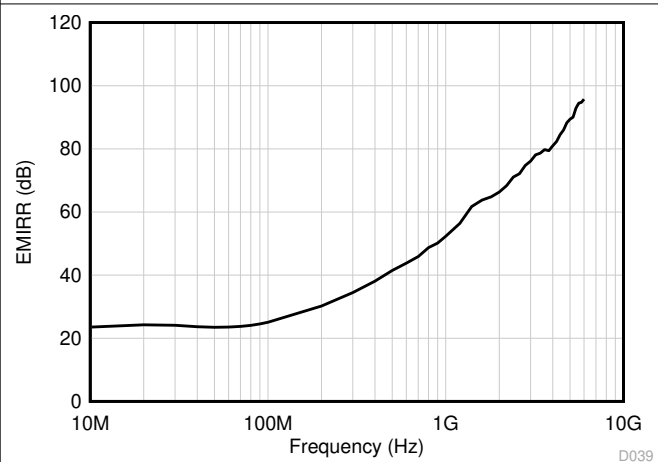
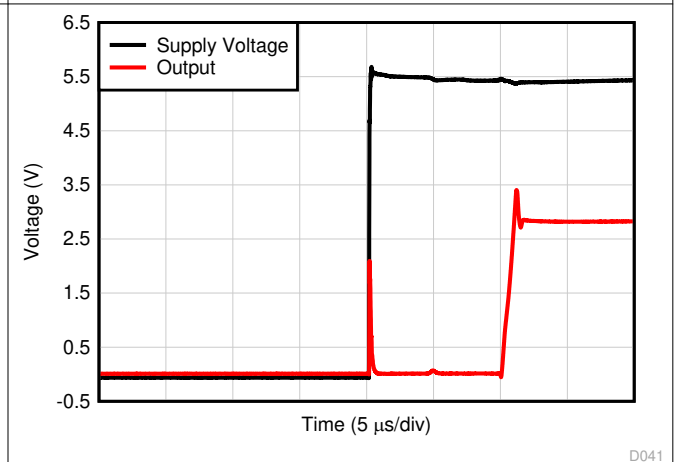
## 8 Detailed Description

### 8.1 Overview

The OPAx375 family is an ultra low-noise, rail-to-rail output operational amplifier. The device operates from a supply voltage of 2.25 V to 5.5 V (OPA375) and 1.7 V to 5.5 V (OPA2375 and OPA4375), are unity-gain stable, and suitable for a wide range of general-purpose applications. The input common-mode voltage range includes the negative rail and allows the OPAx375 op amp family to be used in most single-supply applications. Rail-to-rail output swing significantly increases dynamic range, especially in low-supply applications, and makes it suitable for many audio applications and driving sampling analog-to-digital converters (ADCs).

### 8.2 Functional Block Diagram

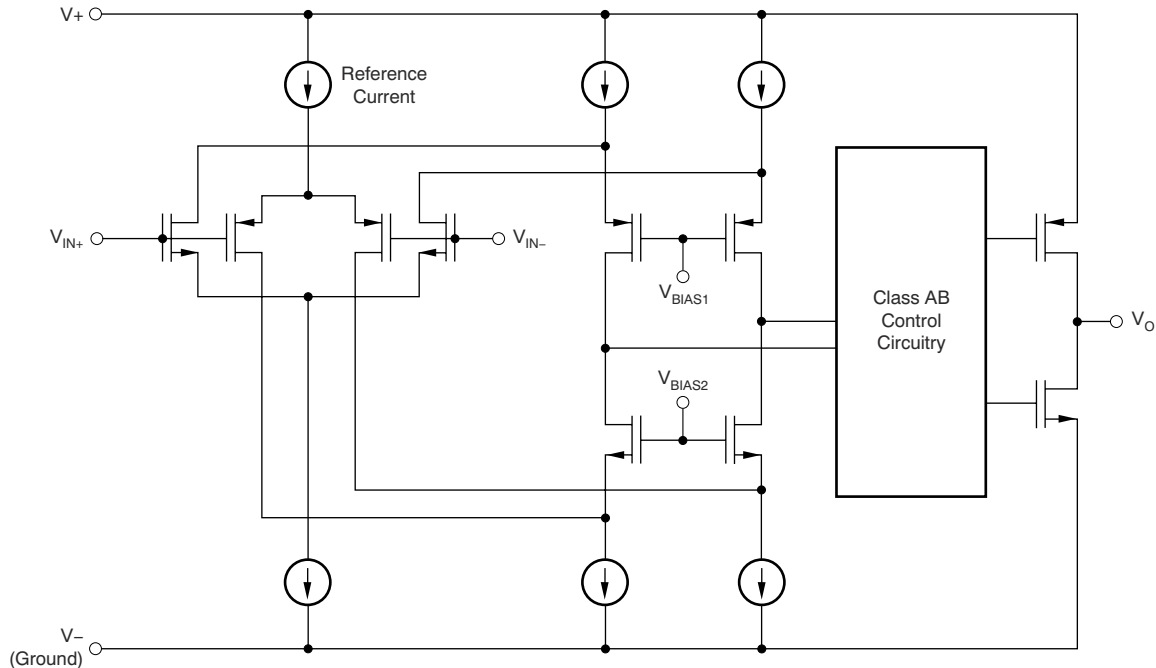

### 8.3 Feature Description

#### 8.3.1 THD + Noise Performance

The OPAx375 operational amplifier family has excellent distortion characteristics. OPA2375 and OPA4375 THD + Noise is below 0.00015% ( $G = +1$ ,  $V_O = 1 V_{RMS}$ ,  $V_{CM} = 1.8 V$ ,  $V_S = 5.5 V$ ) throughout the audio frequency range, 20 Hz to 20 kHz, with a 10-k $\Omega$  load. The broadband noise of the 3.5 nV/ $\sqrt{Hz}$  (OPA2375/4375) and 3.7 nV/ $\sqrt{Hz}$  (OPA375) is extremely low for a 10-MHz general purpose amplifier.

#### 8.3.2 Operating Voltage

The OPAx375 operational amplifier family is fully specified and can operate from 1.7 V to 5.5 V (OPA2375/4375) and 2.25 V to 5.5 V (OPA375). In addition, many specifications apply from  $-40^\circ\text{C}$  to  $125^\circ\text{C}$ . Power-supply pins must be bypassed with 0.1- $\mu\text{F}$  ceramic capacitors.

#### 8.3.3 Rail-to-Rail Output

Designed as low-power, low-voltage op amps, the OPAx375 devices deliver a robust output drive capability. A class AB output stage with common-source transistors achieves full rail-to-rail output swing capability. For resistive loads of 10 k $\Omega$ , the output swings to within few mV of either supply rail, regardless of the applied power-supply voltage. Different load conditions change the ability of the amplifier to swing close to the rails, see [图 7-71](#).

### 8.3.4 EMI Rejection

The TLV674x uses integrated electromagnetic interference (EMI) filtering to reduce the effects of EMI from sources such as wireless communications and densely-populated boards with a mix of analog signal chain and digital components. EMI immunity can be improved with circuit design techniques; the OPAx375 benefits from these design improvements. Texas Instruments has developed the ability to accurately measure and quantify the immunity of an operational amplifier over a broad frequency spectrum extending from 10 MHz to 6 GHz. 图 8-1 shows the results of this testing on the TLV674x. 表 8-1 shows the EMIRR IN+ values for the TLV674x at particular frequencies commonly encountered in real-world applications. The [EMI Rejection Ratio of Operational Amplifiers](#) application report contains detailed information on the topic of EMIRR performance as it relates to op amps and is available for download from [www.ti.com](http://www.ti.com).



图 8-1. EMIRR Testing

表 8-1. OPAx375 EMIRR IN+ for Frequencies of Interest

FREQUENCY	APPLICATION OR ALLOCATION	EMIRR IN+
400 MHz	Mobile radio, mobile satellite, space operation, weather, radar, ultra-high frequency (UHF) applications	59.5 dB
900 MHz	Global system for mobile communications (GSM) applications, radio communication, navigation, GPS (to 1.6 GHz), GSM, aeronautical mobile, UHF applications	68.9 dB
1.8 GHz	GSM applications, mobile personal communications, broadband, satellite, L-band (1 GHz to 2 GHz)	77.8 dB
2.4 GHz	802.11b, 802.11g, 802.11n, Bluetooth®, mobile personal communications, industrial, scientific and medical (ISM) radio band, amateur radio and satellite, S-band (2 GHz to 4 GHz)	78.0 dB
3.6 GHz	Radiolocation, aero communication and navigation, satellite, mobile, S-band	88.8 dB
5 GHz	802.11a, 802.11n, aero communication and navigation, mobile communication, space and satellite operation, C-band (4 GHz to 8 GHz)	87.6 dB

### 8.3.5 Electrical Overstress

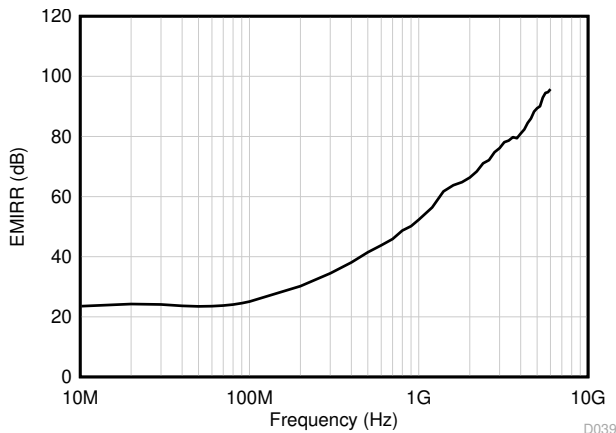
Designers often ask questions about the capability of an operational amplifier to withstand electrical overstress (EOS). These questions tend to focus on the device inputs, but may involve the supply voltage pins or even the output pin. Each of these different pin functions have electrical stress limits determined by the voltage breakdown characteristics of the particular semiconductor fabrication process and specific circuits connected to the pin. Additionally, internal electrostatic discharge (ESD) protection is built into these circuits to protect them from accidental ESD events both before and during product assembly.

Having a good understanding of this basic ESD circuitry and its relevance to an electrical overstress event is helpful. 图 8-2 shows an illustration of the ESD circuits contained in the OPAx375 (indicated by the dashed line area). The ESD protection circuitry involves several current-steering diodes connected from the input and output pins and routed back to the internal power-supply lines, where the diodes meet at an absorption device or the power-supply ESD cell, internal to the operational amplifier. This protection circuitry is intended to remain inactive during normal circuit operation.



图 8-2. Equivalent Internal ESD Circuitry Relative to a Typical Circuit Application

An ESD event is very short in duration and very high voltage (for example; 1 kV, 100 ns), whereas an EOS event is long in duration and lower voltage (for example; 50 V, 100 ms). The ESD diodes are designed for out-of-circuit ESD protection (that is, during assembly, test, and storage of the device before being soldered to the PCB). During an ESD event, the ESD signal is passed through the ESD steering diodes to an absorption circuit (labeled ESD power-supply circuit). The ESD absorption circuit clamps the supplies to a safe level.

Although this behavior is necessary for out-of-circuit protection, excessive current and damage is caused if activated in-circuit. A transient voltage suppressor (TVS) can be used to prevent against damage caused by turning on the ESD absorption circuit during an in-circuit ESD event. Using the appropriate current limiting resistors and TVS diodes allows for the use of device ESD diodes to protect against EOS events.

The OPAx375 family incorporates internal electrostatic discharge (ESD) protection circuits on all pins, as shown above. These ESD protection diodes also provide in-circuit, input overdrive protection, as long as the current is limited to 10 mA as stated in 节 7.1. 图 8-3 shows how a series input resistor may be added to the driven input to limit the input current. The added resistor contributes thermal noise at the amplifier input and its value should be kept to a minimum in noise-sensitive applications.

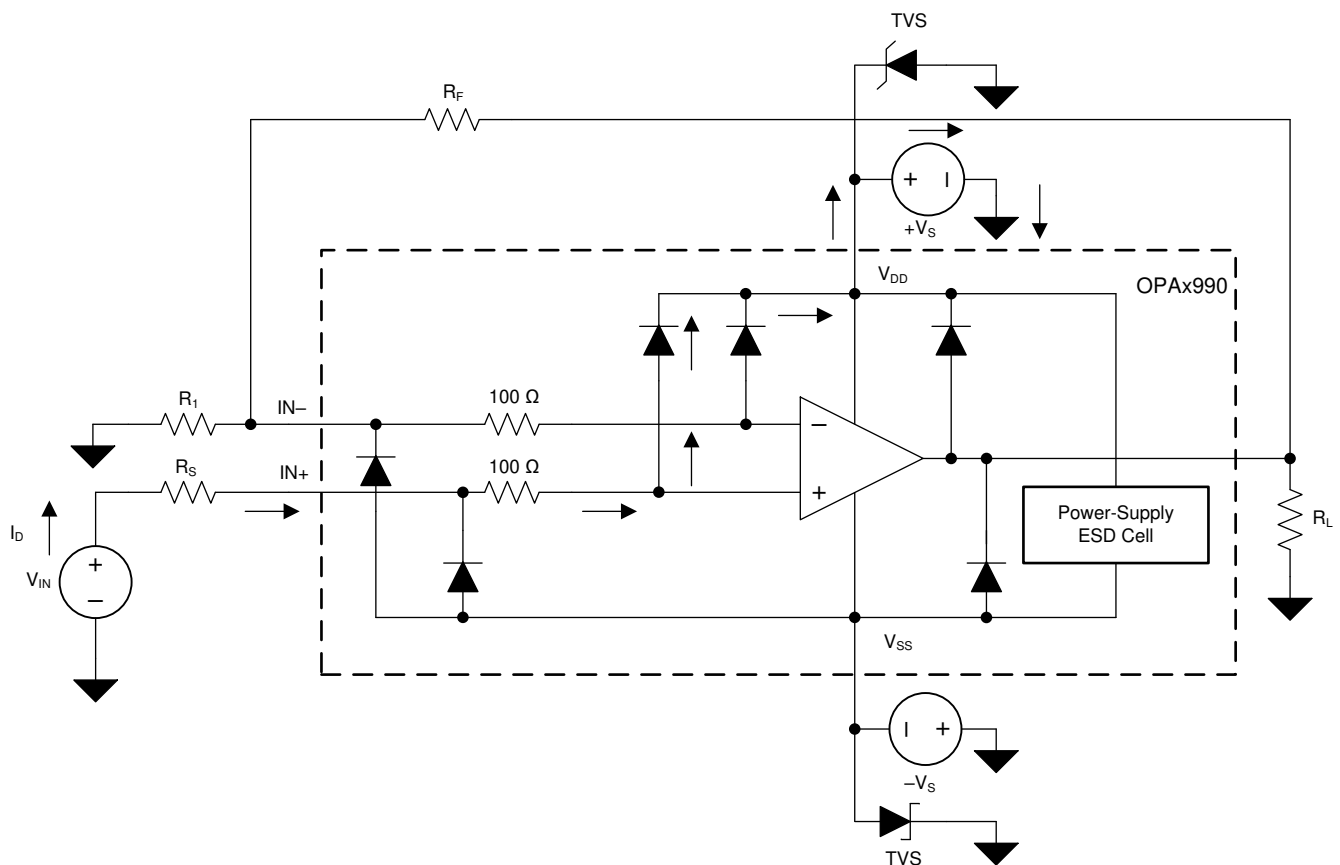

图 8-3. Input Current Protection

### 8.3.6 Typical Specifications and Distributions

Designers often have questions about a typical specification of an amplifier in order to design a more robust circuit. Due to natural variation in process technology and manufacturing procedures, every specification of an amplifier will exhibit some amount of deviation from the ideal value, like an amplifier's input offset voltage. These deviations often follow *Gaussian* ("bell curve"), or *normal*, distributions and circuit designers can leverage this information to guardband their system, even when there is not a minimum or maximum specification in 节 7.6.

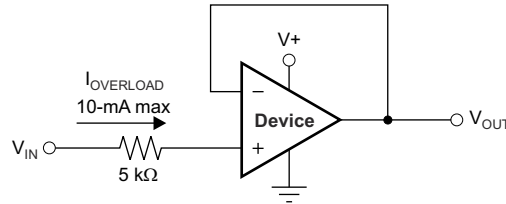

图 8-4. Ideal Gaussian Distribution

图 8-4 shows an example distribution, where  $\mu$ , or *mu*, is the mean of the distribution, and where  $\sigma$ , or *sigma*, is the standard deviation of a system. For a specification that exhibits this kind of distribution, approximately two-thirds (68.26%) of all units can be expected to have a value within one standard deviation, or one sigma, of the mean (from  $\mu - \sigma$  to  $\mu + \sigma$ ).

Depending on the specification, values listed in the *typical* column of 节 7.6 are represented in different ways. As a general rule of thumb, if a specification naturally has a nonzero mean (for example, like gain bandwidth), then the typical value is equal to the mean ( $\mu$ ). However, if a specification naturally has a mean near zero (like input

offset voltage), then the typical value is equal to the mean plus one standard deviation ( $\mu + \sigma$ ) in order to most accurately represent the typical value.

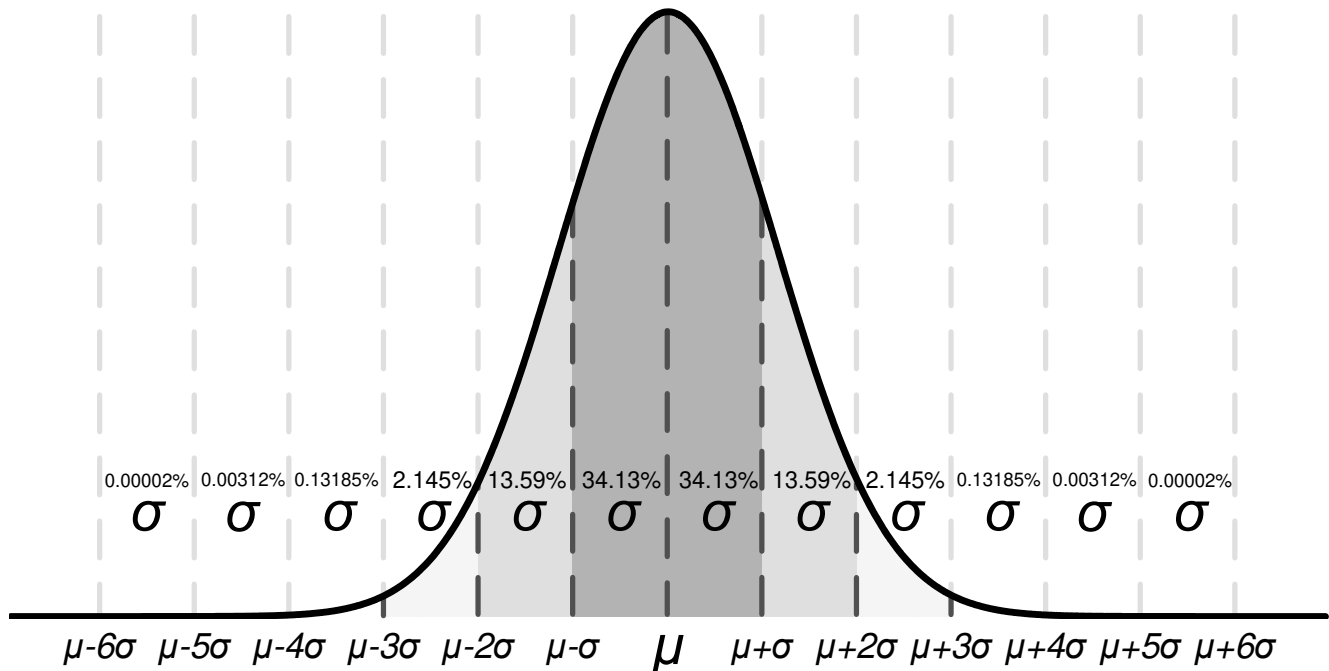
You can use this chart to calculate approximate probability of a specification in a unit; for example, for OPA2375, the typical input voltage offset is 150  $\mu\text{V}$ , so 68.2% of all OPA2375 devices are expected to have an offset from  $-150 \mu\text{V}$  to 150  $\mu\text{V}$ .

Specifications with a value in the minimum or maximum column are assured by TI, and units outside these limits will be removed from production material. For example, the OPA2375 device has a maximum offset voltage of 0.5 mV at 25°C, and even though this corresponds to 5  $\sigma$  ( $\approx 1$  in 1.7 million units), which is extremely unlikely, TI assures that any unit with a larger offset than 0.5 mV will be removed from production material.

For specifications with no value in the minimum or maximum column, consider selecting a sigma value of sufficient guardband for your application, and design worst-case conditions using this value. For example, the 6- $\sigma$  value corresponds to about 1 in 500 million units, which is an extremely unlikely chance, and could be an option as a wide guardband to design a system around. In this case, the OPA2375 does not have a maximum or minimum for offset voltage drift, but based on [Figure 7-40](#) and the typical value of 0.16  $\mu\text{V}/^\circ\text{C}$  in [Section 7.6](#), it can be calculated that the 6- $\sigma$  value for offset voltage drift is about 0.96  $\mu\text{V}/^\circ\text{C}$ . When designing for worst-case system conditions, this value can be used to estimate the worst possible offset across temperature without having an actual minimum or maximum value.

However, process variation and adjustments over time can shift typical means and standard deviations, and unless there is a value in the minimum or maximum specification column, TI cannot assure the performance of a device. This information should be used only to estimate the performance of a device.

### 8.3.7 Shutdown Function

The OPAx375S devices feature  $\overline{\text{SHDN}}$  pins that disable the op amp, placing it into a low-power standby mode. In this mode, the op amp typically consumes less than 1  $\mu\text{A}$ . The  $\overline{\text{SHDN}}$  pins are active-low, meaning that shutdown mode is enabled when the input to the  $\overline{\text{SHDN}}$  pin is a valid logic low.

The  $\overline{\text{SHDN}}$  pins are referenced to the negative supply voltage of the op amp. The threshold of the shutdown feature lies around 800 mV (typical) above the negative rail. Hysteresis has been included in the switching threshold to ensure smooth switching characteristics. To ensure optimal shutdown behavior, the  $\overline{\text{SHDN}}$  pins should be driven with valid logic signals. A valid logic low is defined as a voltage between  $V^-$  and  $V^- + 0.2 \text{ V}$ . A valid logic high is defined as a voltage between  $V^- + 1.2 \text{ V}$  and  $V^+$ . The shutdown pin must either be connected to a valid high or a low voltage or driven, and not left as an open circuit. There is **no** internal pull-up to enable the amplifier.

The  $\overline{\text{SHDN}}$  pins are high-impedance CMOS inputs. Dual op amp versions are independently controlled, and quad op amp versions are controlled in pairs with logic inputs. For battery-operated applications, this feature may be used to greatly reduce the average current and extend battery life. The enable time is 15  $\mu\text{s}$  for full shutdown of all channels; disable time is 3  $\mu\text{s}$ . When disabled, the output assumes a high-impedance state. This architecture allows the OPAx375S to be operated as a gated amplifier (or to have the device output multiplexed onto a common analog output bus). Shutdown time ( $t_{\text{OFF}}$ ) depends on loading conditions and increases as load resistance increases. To ensure shutdown (disable) within a specific shutdown time, the specified 10-k  $\Omega$  load to midsupply ( $V_S / 2$ ) is required. If using the OPAx375S without a load, the resulting turnoff time is significantly increased.

### 8.3.8 Packages With an Exposed Thermal Pad

The OPAx375 family is available in packages such as the WSON-8 (DSG) which feature an exposed thermal pad. Inside the package, the die is attached to this thermal pad using an electrically conductive compound. For this reason, when using a package with an exposed thermal pad, the thermal pad must either be connected to  $V^-$  or left floating. Attaching the thermal pad to a potential other than  $V^-$  is not allowed, and performance of the device is not assured when doing so.

### 8.3.9 Common Mode Voltage Range

The input common-mode voltage range of the OPAx375 family extends to the negative rail and within 2 V of the top rail for normal operation. However, this device can also operate with full rail-to-rail input 100 mV beyond the top rail, but with reduced performance within 2 V of the top rail. The typical performance in this range is summarized in for the OPA375. You can see the typical input offset voltage of the OPA2375/4375 in the [图 7-43](#) graph.

**表 8-2. OPA375 Typical Performance ( $V_S = 5\text{ V}$ ,  $V_{CM} > V_S - 1.2\text{ V}$ )**

PARAMETER	MIN	TYP	MAX	UNIT
Offset voltage		3		mV
Slew rate		1.5		V/ $\mu$ S
Input voltage noise density at f = 1 kHz		15		nV/ $\sqrt{\text{Hz}}$

### 8.4 Device Functional Modes

The OPAx375 family has a single functional mode. The OPA2375 and OPA4375 are powered on as long as the power-supply voltage is between 1.7 V ( $\pm 0.85\text{ V}$ ) and 5.5 V ( $\pm 2.75\text{ V}$ ). The OPA375 is powered on as long as the power-supply voltage is between 2.25 V ( $\pm 1.125\text{ V}$ ) and 5.5 V ( $\pm 2.75\text{ V}$ ).

## 9 Application and Implementation

### Note

Information in the following applications sections is not part of the TI component specification, and TI does not warrant its accuracy or completeness. TI's customers are responsible for determining suitability of components for their purposes. Customers should validate and test their design implementation to confirm system functionality.

### 9.1 Application Information

The OPAx375 family features 10-MHz bandwidth and 4.75-V/ $\mu$ s slew rate with 890  $\mu$ A (OPA375), 990  $\mu$ A (OPA2375/4375) of supply current per channel, providing good AC performance at low-power consumption. DC applications are well served with a low input noise voltage of 3.5 nV/ $\sqrt{\text{Hz}}$  (OPA2375/4375), 3.7 nV/ $\sqrt{\text{Hz}}$  (OPA375) at 10 kHz, low input bias current, and a typical input offset voltage of 0.15 mV.

### 9.2 Single-Supply Electret Microphone Preamp with Speech Filter

Electret microphones are commonly used in portable electronics because of the small size, low cost, and relatively good signal-to-noise ratio (SNR). The small package size, low operating voltage and AC performance of the OPA375 make the device a viable option for preamplifier circuits for electret microphones. The circuit shown in [Figure 9-1](#) is a single-supply preamplifier circuit for electret microphones.

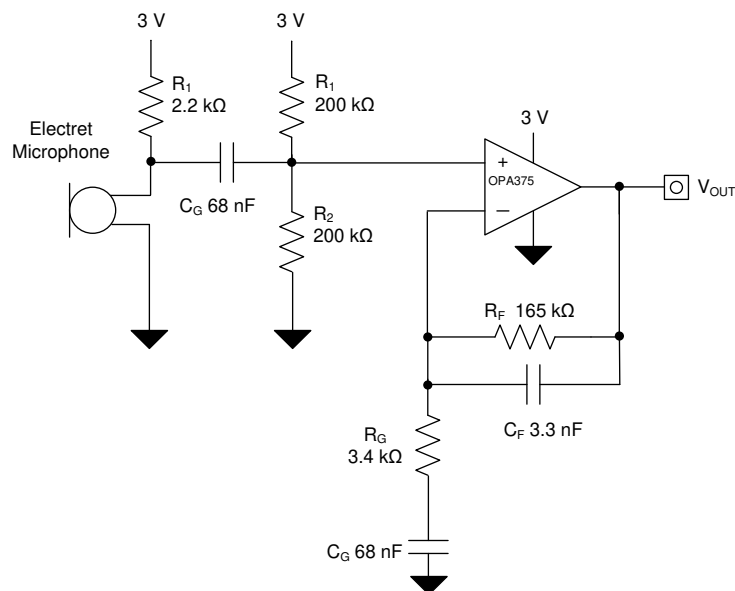

Copyright © 2017, Texas Instruments Incorporated

**Figure 9-1. Microphone Preamplifier**

#### 9.2.1 Design Requirements

The design requirements are as follows:

- Supply voltage: 3 V
- Input voltage: 7.93 mV<sub>RMS</sub> (0.63 Pa with a -38-dB SPL microphone)
- Output: 1 V<sub>RMS</sub>
- Bandwidth: 300 Hz to 3 kHz

### 9.2.2 Detailed Design Procedure

The transfer function defining the relationship between  $V_{OUT}$  and the AC input signal is shown in [方程式 1](#).

$$V_{OUT} = V_{IN\_AC} \times \left( 1 + \frac{R_F}{R_G} \right) \quad (1)$$

The required gain can be calculated based on the expected input signal level and desired output level as shown in [方程式 2](#).

$$G_{OPA} = \frac{V_{OUT}}{V_{IN\_AC}} = \frac{1V_{RMS}}{7.93mV_{RMS}} = 126 \frac{V}{V} \quad (2)$$

Select a standard 10-k $\Omega$  feedback resistor and calculate  $R_G$  from [方程式 3](#).

$$R_G = \frac{R_F}{G_{OPA} - 1} = \frac{10k\Omega}{126 \frac{V}{V} - 1} = 80\Omega \rightarrow 78.7\Omega \text{ (closest standard value)} \quad (3)$$

To minimize the attenuation in the desired passband from 300 Hz to 3 kHz, set the upper ( $f_H$ ) and lower ( $f_L$ ) cutoff frequencies outside of the desired bandwidth as:

$$f_L = 200 \text{ Hz} \quad (4)$$

and

$$f_H = 5 \text{ kHz} \quad (5)$$

Select  $C_G$  to set the  $f_L$  cutoff frequency using [方程式 6](#).

$$C_G = \frac{1}{2 \times \pi \times R_G \times f_L} = \frac{1}{2 \times \pi \times 78.7\Omega \times 200\text{Hz}} = 10.11\mu F \rightarrow 10\mu F \quad (6)$$

Select  $C_F$  to set the  $f_H$  cutoff frequency using [方程式 7](#).

$$C_F = \frac{1}{2 \times \pi \times R_F \times f_H} = \frac{1}{2 \times \pi \times 10k\Omega \times 5\text{kHz}} = 3.18nF \rightarrow 3.3nF \text{ (Standard Value)} \quad (7)$$

The input signal cutoff frequency must be set low enough such that low-frequency sound waves still pass through. Therefore select  $C_{IN}$  to achieve a 30-Hz cutoff frequency ( $f_{IN}$ ) using [方程式 8](#).

$$C_{IN} = \frac{1}{2 \times \pi \times (R_1 \parallel R_2) \times f_{IN}} = \frac{1}{2 \times \pi \times 100k\Omega \times 30\text{Hz}} = 53nF \rightarrow 68nF \text{ (Standard Value)} \quad (8)$$

The measured transfer function for the microphone preamplifier circuit is shown in [图 9-2](#) and the measured THD + N performance of the microphone preamplifier circuit is shown in [图 9-3](#).

### 9.2.3 Application Curves



图 9-2. Gain vs Frequency



图 9-3. THD + N vs RMS Output Voltage

## 10 Power Supply Recommendations

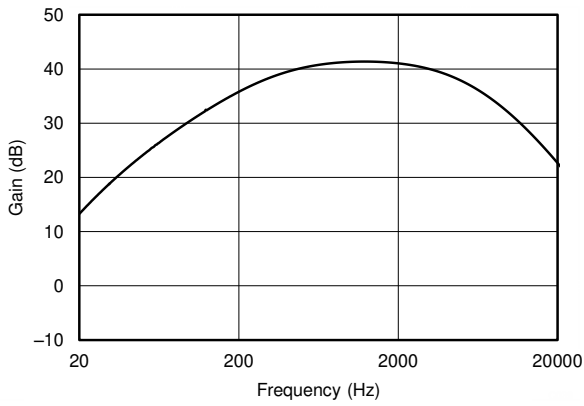
The OPA2375 and OPA4375 devices are specified for operation from 1.7 V to 5.5 V ( $\pm 0.85$  V to  $\pm 2.75$  V). The OPA375 device is specified for operation from 2.25 V to 5.5 V ( $\pm 1.125$  V to  $\pm 2.75$  V). Many specifications of the OPAx375 family apply from  $-40^{\circ}\text{C}$  to  $125^{\circ}\text{C}$ .

### CAUTION

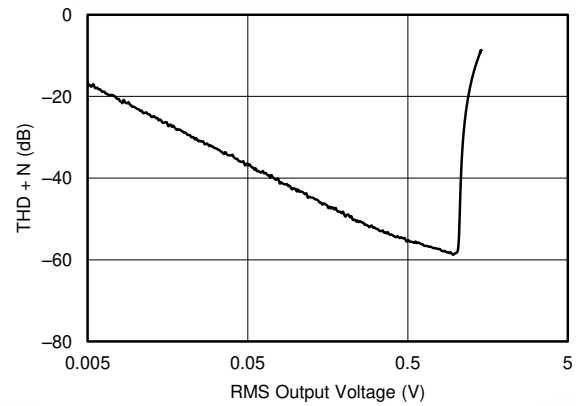
Supply voltages larger than 7 V can permanently damage the device (see [节 7.1](#)).

Place 0.1- $\mu\text{F}$  bypass capacitors close to the power-supply pins to reduce errors coupling in from noisy or high-impedance power supplies. For more detailed information on bypass capacitor placement, see [节 11.1](#).

## 11 Layout

### 11.1 Layout Guidelines

For best operational performance of the device, use good printed-circuit board (PCB) layout practices, including:

- Noise can propagate into analog circuitry through the power pins of the circuit as a whole and the operational amplifier. Bypass capacitors are used to reduce the coupled noise by providing low-impedance power sources local to the analog circuitry.
  - Connect low-ESR, 0.1- $\mu$ F ceramic bypass capacitors between each supply pin and ground, placed as close to the device as possible. A single bypass capacitor from V+ to ground is applicable for single-supply applications.
- Separate grounding for analog and digital portions of the circuitry is one of the simplest and most effective methods of noise suppression. One or more layers on multilayer PCBs are usually devoted to ground planes. A ground plane helps distribute heat and reduces EMI noise pickup. Make sure to physically separate digital and analog grounds, paying attention to the flow of the ground current.
- To reduce parasitic coupling, run the input traces as far away from the supply or output traces as possible. If these traces cannot be kept separate, crossing the sensitive trace perpendicularly is much better than crossing in parallel with the noisy trace.
- Place the external components as close to the device as possible. Keeping RF and RG close to the inverting input minimizes parasitic capacitance, as shown in [Figure 11-1](#).
- Keep the length of input traces as short as possible. Always remember that the input traces are the most sensitive part of the circuit.
- Consider a driven, low-impedance guard ring around the critical traces. A guard ring can significantly reduce leakage currents from nearby traces that are at different potentials.

## 11.2 Layout Example



图 11-1. Operational Amplifier Board Layout for Noninverting Configuration



Copyright © 2017, Texas Instruments Incorporated

图 11-2. Layout Example Schematic

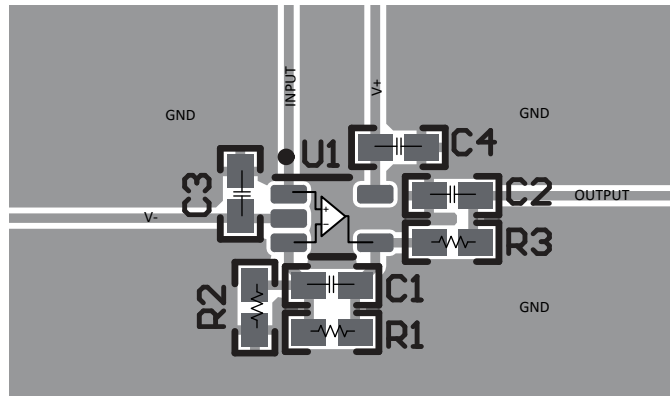
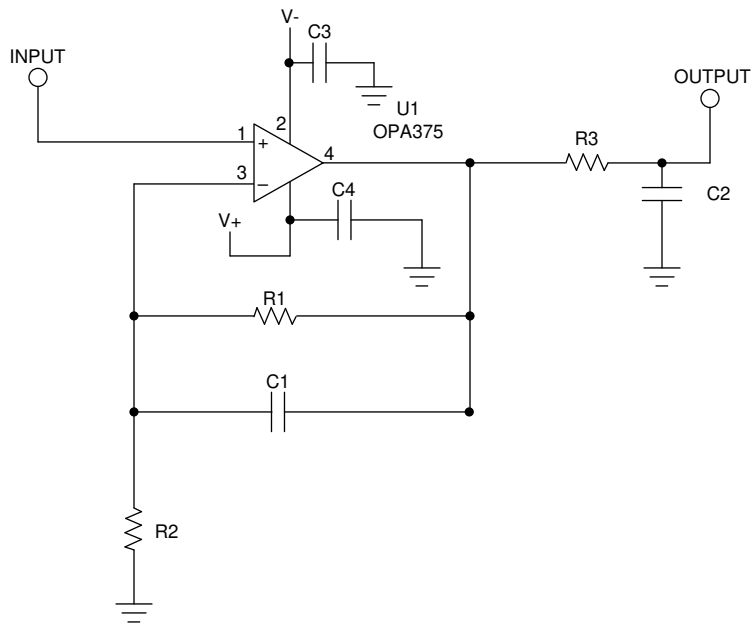

图 11-3. Example Layout for VSSOP-8 (DGK) Package

## 12 Device and Documentation Support

### 12.1 Documentation Support

#### 12.1.1 Related Documentation

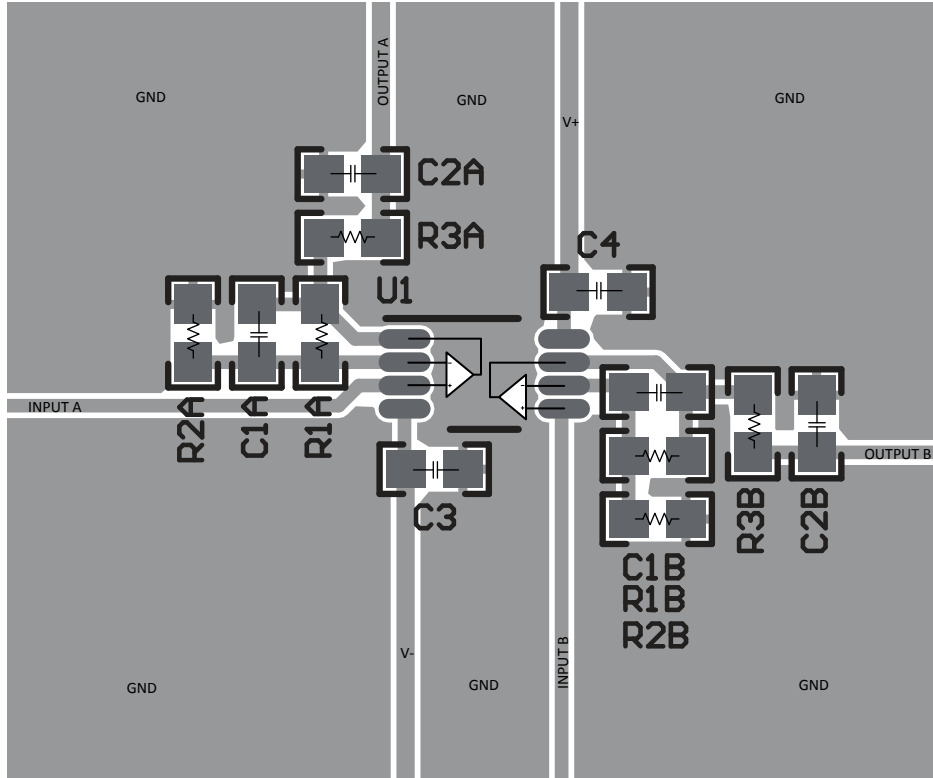
For related documentation see the following:

- Texas Instruments, [QFN/SON PCB Attachment](#)
- Texas Instruments, [Quad Flatpack No-Lead Logic Packages](#)
- Texas Instruments, [EMI Rejection Ratio of Operational Amplifiers](#)

### 12.2 接收文档更新通知

要接收文档更新通知，请导航至 [ti.com](http://ti.com) 上的器件产品文件夹。点击 [订阅更新](#) 进行注册，即可每周接收产品信息更改摘要。有关更改的详细信息，请查看任何已修订文档中包含的修订历史记录。

### 12.3 支持资源

[TI E2E™ 支持论坛](#) 是工程师的重要参考资料，可直接从专家获得快速、经过验证的解答和设计帮助。搜索现有解答或提出自己的问题可获得所需的快速设计帮助。

链接的内容由各个贡献者“按原样”提供。这些内容并不构成 TI 技术规范，并且不一定反映 TI 的观点；请参阅 TI 的 [《使用条款》](#)。

### 12.4 Trademarks

TI E2E™ is a trademark of Texas Instruments.

Bluetooth® is a registered trademark of Bluetooth SIG, Inc.

所有商标均为其各自所有者的财产。

### 12.5 Electrostatic Discharge Caution



This integrated circuit can be damaged by ESD. Texas Instruments recommends that all integrated circuits be handled with appropriate precautions. Failure to observe proper handling and installation procedures can cause damage.

ESD damage can range from subtle performance degradation to complete device failure. Precision integrated circuits may be more susceptible to damage because very small parametric changes could cause the device not to meet its published specifications.

### 12.6 术语表

[TI 术语表](#) 本术语表列出并解释了术语、首字母缩略词和定义。

## 13 Mechanical, Packaging, and Orderable Information

The following pages include mechanical, packaging, and orderable information. This information is the most current data available for the designated devices. This data is subject to change without notice and revision of this document. For browser-based versions of this data sheet, refer to the left-hand navigation.

## 重要声明和免责声明

TI 提供技术和可靠性数据 (包括数据表)、设计资源 (包括参考设计)、应用或其他设计建议、网络工具、安全信息和其他资源, 不保证没有瑕疵且不做任何明示或暗示的担保, 包括但不限于对适销性、某特定用途方面的适用性或不侵犯任何第三方知识产权的暗示担保。

这些资源可供使用 TI 产品进行设计的熟练开发人员使用。您将自行承担以下全部责任: (1) 针对您的应用选择合适的 TI 产品, (2) 设计、验证并测试您的应用, (3) 确保您的应用满足相应标准以及任何其他安全、安保或其他要求。这些资源如有变更, 恕不另行通知。TI 授权您仅可将这些资源用于研发本资源所述的 TI 产品的应用。严禁对这些资源进行其他复制或展示。您无权使用任何其他 TI 知识产权或任何第三方知识产权。您应全额赔偿因在这些资源的使用中对 TI 及其代表造成的任何索赔、损害、成本、损失和债务, TI 对此概不负责。

TI 提供的产品受 TI 的销售条款 (<https://www.ti.com/legal/termsofsale.html>) 或 [ti.com](https://www.ti.com) 上其他适用条款/TI 产品随附的其他适用条款的约束。TI 提供这些资源并不会扩展或以其他方式更改 TI 针对 TI 产品发布的适用的担保或担保免责声明。

邮寄地址: Texas Instruments, Post Office Box 655303, Dallas, Texas 75265  
Copyright © 2021, 德州仪器 (TI) 公司

**PACKAGING INFORMATION**

Orderable part number	Status (1)	Material type (2)	Package   Pins	Package qty   Carrier	RoHS (3)	Lead finish/ Ball material (4)	MSL rating/ Peak reflow (5)	Op temp (°C)	Part marking (6)
<a href="#">OPA2375IDDFR</a>	Active	Production	SOT-23-THIN (DDF)   8	3000   LARGE T&R	Yes	NIPDAU	Level-1-260C-UNLIM	-40 to 125	O75D
OPA2375IDDFR.A	Active	Production	SOT-23-THIN (DDF)   8	3000   LARGE T&R	Yes	NIPDAU	Level-1-260C-UNLIM	-40 to 125	O75D
<a href="#">OPA2375IDGKR</a>	Active	Production	VSSOP (DGK)   8	2500   LARGE T&R	Yes	NIPDAU   SN	Level-1-260C-UNLIM	-40 to 125	2J8T
OPA2375IDGKR.A	Active	Production	VSSOP (DGK)   8	2500   LARGE T&R	Yes	NIPDAU	Level-1-260C-UNLIM	-40 to 125	2J8T
<a href="#">OPA2375IDR</a>	Active	Production	SOIC (D)   8	2500   LARGE T&R	Yes	NIPDAU	Level-1-260C-UNLIM	-40 to 125	O2375D
OPA2375IDR.A	Active	Production	SOIC (D)   8	2500   LARGE T&R	Yes	NIPDAU	Level-1-260C-UNLIM	-40 to 125	O2375D
<a href="#">OPA2375IDSGR</a>	Active	Production	WSON (DSG)   8	3000   LARGE T&R	Yes	SN	Level-1-260C-UNLIM	-40 to 125	O75D
OPA2375IDSGR.A	Active	Production	WSON (DSG)   8	3000   LARGE T&R	Yes	SN	Level-1-260C-UNLIM	-40 to 125	O75D
<a href="#">OPA2375IPWR</a>	Active	Production	TSSOP (PW)   8	2000   LARGE T&R	Yes	NIPDAU	Level-1-260C-UNLIM	-40 to 125	O2375P
OPA2375IPWR.A	Active	Production	TSSOP (PW)   8	2000   LARGE T&R	Yes	NIPDAU	Level-1-260C-UNLIM	-40 to 125	O2375P
<a href="#">OPA2375SIRUGR</a>	Active	Production	X2QFN (RUG)   10	3000   LARGE T&R	Yes	NIPDAUAG	Level-2-260C-1 YEAR	-40 to 125	HIF
OPA2375SIRUGR.A	Active	Production	X2QFN (RUG)   10	3000   LARGE T&R	Yes	NIPDAUAG	Level-2-260C-1 YEAR	-40 to 125	HIF
<a href="#">OPA375IDCKR</a>	Active	Production	SC70 (DCK)   5	3000   LARGE T&R	Yes	NIPDAU	Level-2-260C-1 YEAR	-40 to 125	19W
OPA375IDCKR.A	Active	Production	SC70 (DCK)   5	3000   LARGE T&R	Yes	NIPDAU	Level-2-260C-1 YEAR	-40 to 125	19W
<a href="#">OPA375IDCKT</a>	Active	Production	SC70 (DCK)   5	250   SMALL T&R	Yes	NIPDAU	Level-2-260C-1 YEAR	-40 to 125	19W
OPA375IDCKT.A	Active	Production	SC70 (DCK)   5	250   SMALL T&R	Yes	NIPDAU	Level-2-260C-1 YEAR	-40 to 125	19W
OPA375IDCKTG4	Active	Production	SC70 (DCK)   5	250   SMALL T&R	Yes	NIPDAU	Level-2-260C-1 YEAR	-40 to 125	19W
OPA375IDCKTG4.A	Active	Production	SC70 (DCK)   5	250   SMALL T&R	Yes	NIPDAU	Level-2-260C-1 YEAR	-40 to 125	19W

(1) **Status:** For more details on status, see our [product life cycle](#).

(2) **Material type:** When designated, preproduction parts are prototypes/experimental devices, and are not yet approved or released for full production. Testing and final process, including without limitation quality assurance, reliability performance testing, and/or process qualification, may not yet be complete, and this item is subject to further changes or possible discontinuation. If available for ordering, purchases will be subject to an additional waiver at checkout, and are intended for early internal evaluation purposes only. These items are sold without warranties of any kind.

(3) **RoHS values:** Yes, No, RoHS Exempt. See the [TI RoHS Statement](#) for additional information and value definition.

(4) **Lead finish/Ball material:** Parts may have multiple material finish options. Finish options are separated by a vertical ruled line. Lead finish/Ball material values may wrap to two lines if the finish value exceeds the maximum column width.

(5) **MSL rating/Peak reflow:** The moisture sensitivity level ratings and peak solder (reflow) temperatures. In the event that a part has multiple moisture sensitivity ratings, only the lowest level per JEDEC standards is shown. Refer to the shipping label for the actual reflow temperature that will be used to mount the part to the printed circuit board.

(6) **Part marking:** There may be an additional marking, which relates to the logo, the lot trace code information, or the environmental category of the part.

Multiple part markings will be inside parentheses. Only one part marking contained in parentheses and separated by a "~" will appear on a part. If a line is indented then it is a continuation of the previous line and the two combined represent the entire part marking for that device.

**Important Information and Disclaimer:**The information provided on this page represents TI's knowledge and belief as of the date that it is provided. TI bases its knowledge and belief on information provided by third parties, and makes no representation or warranty as to the accuracy of such information. Efforts are underway to better integrate information from third parties. TI has taken and continues to take reasonable steps to provide representative and accurate information but may not have conducted destructive testing or chemical analysis on incoming materials and chemicals. TI and TI suppliers consider certain information to be proprietary, and thus CAS numbers and other limited information may not be available for release.

In no event shall TI's liability arising out of such information exceed the total purchase price of the TI part(s) at issue in this document sold by TI to Customer on an annual basis.

**TAPE AND REEL INFORMATION**

**QUADRANT ASSIGNMENTS FOR PIN 1 ORIENTATION IN TAPE**

\*All dimensions are nominal

Device	Package Type	Package Drawing	Pins	SPQ	Reel Diameter (mm)	Reel Width W1 (mm)	A0 (mm)	B0 (mm)	K0 (mm)	P1 (mm)	W (mm)	Pin1 Quadrant
OPA2375IDDFR	SOT-23-THIN	DDF	8	3000	180.0	8.4	3.2	3.2	1.4	4.0	8.0	Q3
OPA2375IDGKR	VSSOP	DGK	8	2500	330.0	12.4	5.3	3.4	1.4	8.0	12.0	Q1
OPA2375IDR	SOIC	D	8	2500	330.0	12.4	6.4	5.2	2.1	8.0	12.0	Q1
OPA2375IDSGR	WSOP	DSG	8	3000	180.0	8.4	2.3	2.3	1.15	4.0	8.0	Q2
OPA2375IPWR	TSSOP	PW	8	2000	330.0	12.4	7.0	3.6	1.6	8.0	12.0	Q1
OPA2375SIRUGR	X2QFN	RUG	10	3000	178.0	8.4	1.75	2.25	0.56	4.0	8.0	Q1
OPA375IDCKR	SC70	DCK	5	3000	178.0	9.0	2.4	2.5	1.2	4.0	8.0	Q3
OPA375IDCKT	SC70	DCK	5	250	178.0	9.0	2.4	2.5	1.2	4.0	8.0	Q3
OPA375IDCKTG4	SC70	DCK	5	250	178.0	9.0	2.4	2.5	1.2	4.0	8.0	Q3

**TAPE AND REEL BOX DIMENSIONS**

\*All dimensions are nominal

Device	Package Type	Package Drawing	Pins	SPQ	Length (mm)	Width (mm)	Height (mm)
OPA2375IDDFR	SOT-23-THIN	DDF	8	3000	210.0	185.0	35.0
OPA2375IDGKR	VSSOP	DGK	8	2500	353.0	353.0	32.0
OPA2375IDR	SOIC	D	8	2500	353.0	353.0	32.0
OPA2375IDSGR	WSON	DSG	8	3000	210.0	185.0	35.0
OPA2375IPWR	TSSOP	PW	8	2000	353.0	353.0	32.0
OPA2375SIRUGR	X2QFN	RUG	10	3000	205.0	200.0	33.0
OPA375IDCKR	SC70	DCK	5	3000	190.0	190.0	30.0
OPA375IDCKT	SC70	DCK	5	250	190.0	190.0	30.0
OPA375IDCKTG4	SC70	DCK	5	250	190.0	190.0	30.0

# DGK0008A



# PACKAGE OUTLINE

VSSOP - 1.1 mm max height

SMALL OUTLINE PACKAGE



4214862/A 04/2023

**NOTES:**

PowerPAD is a trademark of Texas Instruments.

1. All linear dimensions are in millimeters. Any dimensions in parenthesis are for reference only. Dimensioning and tolerancing per ASME Y14.5M.
2. This drawing is subject to change without notice.
3. This dimension does not include mold flash, protrusions, or gate burrs. Mold flash, protrusions, or gate burrs shall not exceed 0.15 mm per side.
4. This dimension does not include interlead flash. Interlead flash shall not exceed 0.25 mm per side.
5. Reference JEDEC registration MO-187.

# EXAMPLE BOARD LAYOUT

DGK0008A

™ VSSOP - 1.1 mm max height

SMALL OUTLINE PACKAGE



LAND PATTERN EXAMPLE  
EXPOSED METAL SHOWN  
SCALE: 15X



SOLDER MASK DETAILS

4214862/A 04/2023

NOTES: (continued)

6. Publication IPC-7351 may have alternate designs.
7. Solder mask tolerances between and around signal pads can vary based on board fabrication site.
8. Vias are optional depending on application, refer to device data sheet. If any vias are implemented, refer to their locations shown on this view. It is recommended that vias under paste be filled, plugged or tented.
9. Size of metal pad may vary due to creepage requirement.

# EXAMPLE STENCIL DESIGN

DGK0008A

<sup>TM</sup> VSSOP - 1.1 mm max height

SMALL OUTLINE PACKAGE



SOLDER PASTE EXAMPLE  
SCALE: 15X

4214862/A 04/2023

NOTES: (continued)

11. Laser cutting apertures with trapezoidal walls and rounded corners may offer better paste release. IPC-7525 may have alternate design recommendations.
12. Board assembly site may have different recommendations for stencil design.

## GENERIC PACKAGE VIEW

**RUG 10**

**X2QFN - 0.4 mm max height**

1.5 x 2, 0.5 mm pitch

PLASTIC QUAD FLATPACK - NO LEAD

This image is a representation of the package family, actual package may vary.  
Refer to the product data sheet for package details.



4231768/A



# EXAMPLE BOARD LAYOUT

RUG0010A

X2QFN - 0.4 mm max height

PLASTIC QUAD FLATPACK - NO LEAD

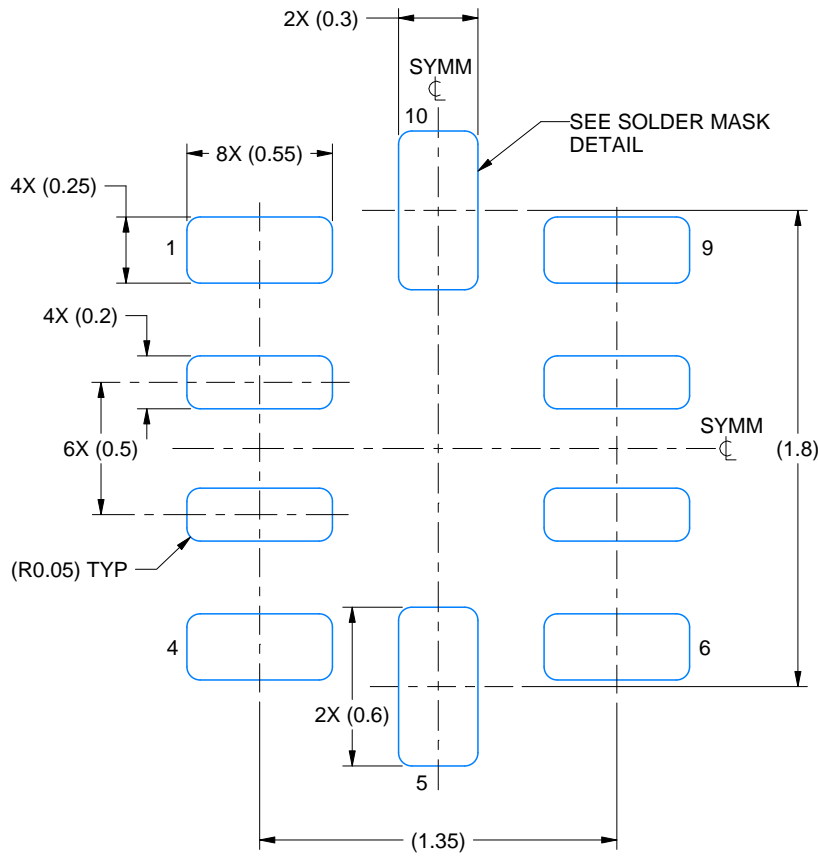

LAND PATTERN EXAMPLE  
EXPOSED METAL SHOWN  
SCALE: 35X

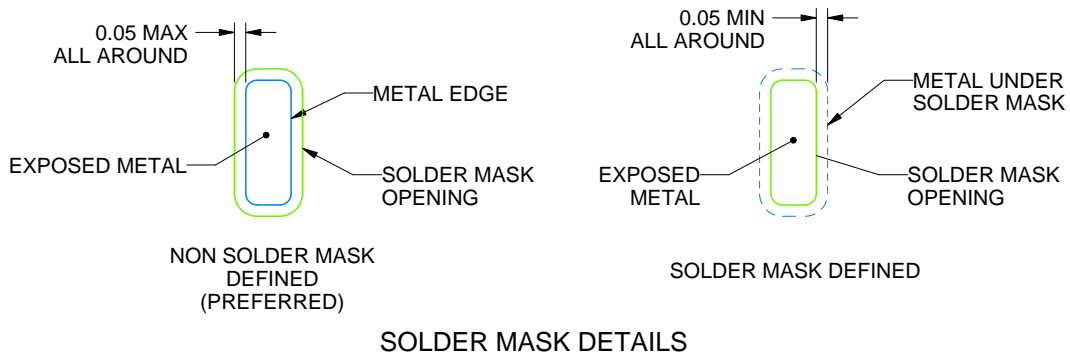

4231745/B 03/2026

NOTES: (continued)

3. For more information, see Texas Instruments literature number SLUA271 ([www.ti.com/lit/sluea271](http://www.ti.com/lit/sluea271)).

# EXAMPLE STENCIL DESIGN

RUG0010A

X2QFN - 0.4 mm max height

PLASTIC QUAD FLATPACK - NO LEAD

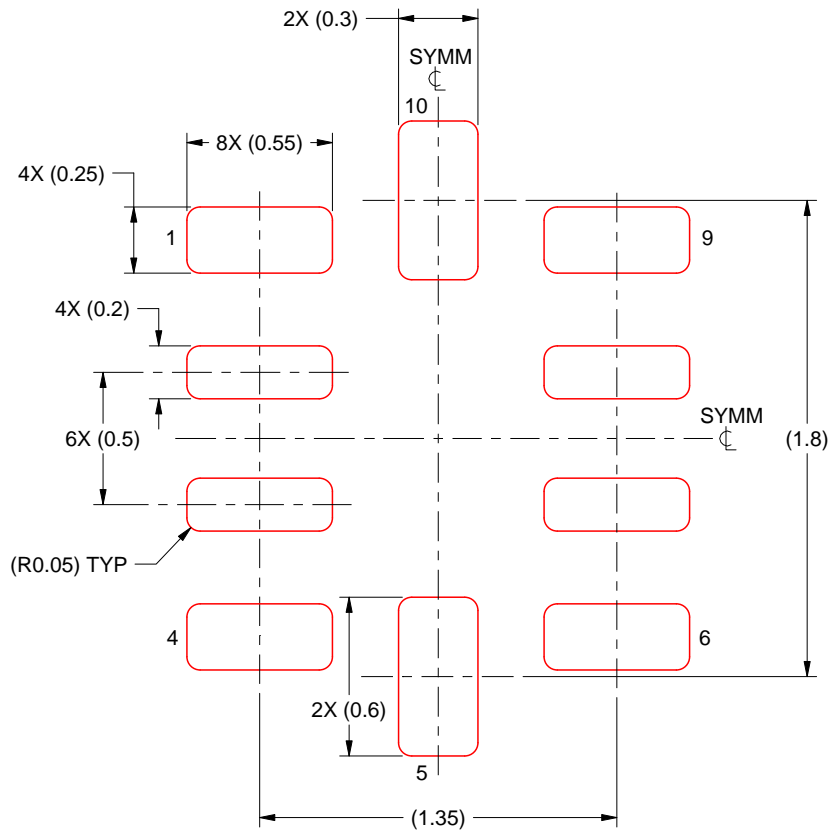

SOLDER PASTE EXAMPLE  
BASED ON 0.125 MM THICK STENCIL  
SCALE: 35X

4231745/B 03/2026

NOTES: (continued)

4. Laser cutting apertures with trapezoidal walls and rounded corners may offer better paste release. IPC-7525 may have alternate design recommendations.



# EXAMPLE BOARD LAYOUT

DCK0005A

SOT - 1.1 max height

SMALL OUTLINE TRANSISTOR



LAND PATTERN EXAMPLE  
EXPOSED METAL SHOWN  
SCALE:18X



SOLDER MASK DETAILS

4214834/G 11/2024

NOTES: (continued)

- 7. Publication IPC-7351 may have alternate designs.
- 8. Solder mask tolerances between and around signal pads can vary based on board fabrication site.

# EXAMPLE STENCIL DESIGN

DCK0005A

SOT - 1.1 max height

SMALL OUTLINE TRANSISTOR



SOLDER PASTE EXAMPLE  
BASED ON 0.125 THICK STENCIL  
SCALE:18X

4214834/G 11/2024

NOTES: (continued)

9. Laser cutting apertures with trapezoidal walls and rounded corners may offer better paste release. IPC-7525 may have alternate design recommendations.
10. Board assembly site may have different recommendations for stencil design.

# DDF0008A



# PACKAGE OUTLINE

## SOT-23-THIN - 1.1 mm max height

PLASTIC SMALL OUTLINE



4222047/E 07/2024

### NOTES:

1. All linear dimensions are in millimeters. Any dimensions in parenthesis are for reference only. Dimensioning and tolerancing per ASME Y14.5M.
2. This drawing is subject to change without notice.
3. This dimension does not include mold flash, protrusions, or gate burrs. Mold flash, protrusions, or gate burrs shall not exceed 0.15 mm per side.

# EXAMPLE BOARD LAYOUT

DDF0008A

SOT-23-THIN - 1.1 mm max height

PLASTIC SMALL OUTLINE

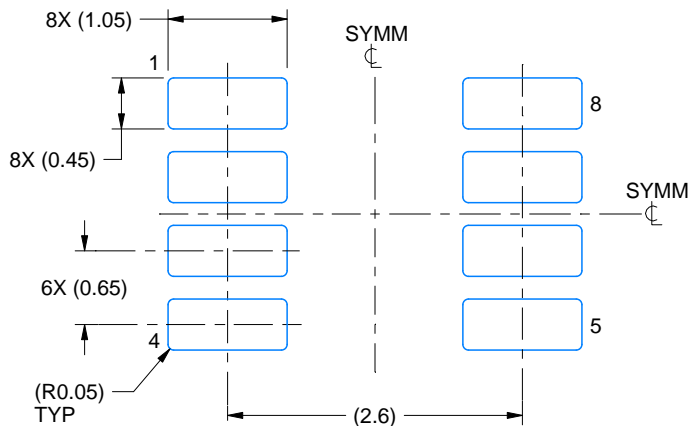

LAND PATTERN EXAMPLE  
EXPOSED METAL SHOWN  
SCALE:15X

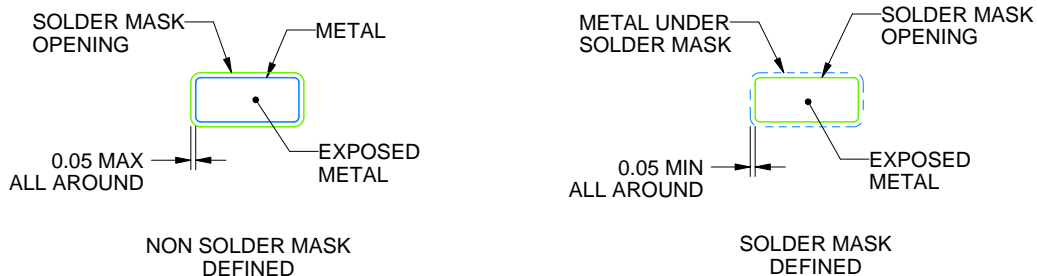

SOLDER MASK DETAILS

4222047/E 07/2024

NOTES: (continued)

- 4. Publication IPC-7351 may have alternate designs.
- 5. Solder mask tolerances between and around signal pads can vary based on board fabrication site.

# EXAMPLE STENCIL DESIGN

DDF0008A

SOT-23-THIN - 1.1 mm max height

PLASTIC SMALL OUTLINE



SOLDER PASTE EXAMPLE  
BASED ON 0.125 mm THICK STENCIL  
SCALE:15X

4222047/E 07/2024

NOTES: (continued)

6. Laser cutting apertures with trapezoidal walls and rounded corners may offer better paste release. IPC-7525 may have alternate design recommendations.
7. Board assembly site may have different recommendations for stencil design.



D0008A

# PACKAGE OUTLINE

SOIC - 1.75 mm max height

SMALL OUTLINE INTEGRATED CIRCUIT



4214825/C 02/2019

NOTES:

1. Linear dimensions are in inches [millimeters]. Dimensions in parenthesis are for reference only. Controlling dimensions are in inches. Dimensioning and tolerancing per ASME Y14.5M.
2. This drawing is subject to change without notice.
3. This dimension does not include mold flash, protrusions, or gate burrs. Mold flash, protrusions, or gate burrs shall not exceed  $.006$  [0.15] per side.
4. This dimension does not include interlead flash.
5. Reference JEDEC registration MS-012, variation AA.

# EXAMPLE BOARD LAYOUT

D0008A

SOIC - 1.75 mm max height

SMALL OUTLINE INTEGRATED CIRCUIT



LAND PATTERN EXAMPLE  
 EXPOSED METAL SHOWN  
 SCALE:8X



SOLDER MASK DETAILS

4214825/C 02/2019

NOTES: (continued)

- 6. Publication IPC-7351 may have alternate designs.
- 7. Solder mask tolerances between and around signal pads can vary based on board fabrication site.

# EXAMPLE STENCIL DESIGN

D0008A

SOIC - 1.75 mm max height

SMALL OUTLINE INTEGRATED CIRCUIT

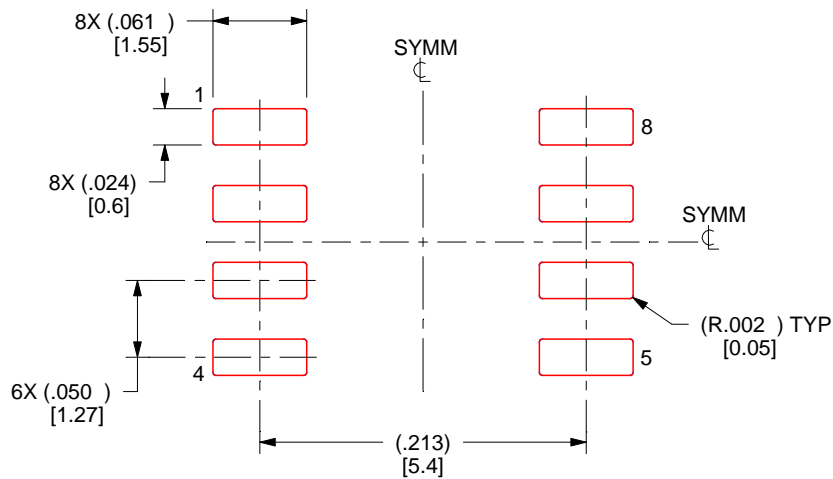

SOLDER PASTE EXAMPLE  
BASED ON .005 INCH [0.125 MM] THICK STENCIL  
SCALE:8X

4214825/C 02/2019

NOTES: (continued)

8. Laser cutting apertures with trapezoidal walls and rounded corners may offer better paste release. IPC-7525 may have alternate design recommendations.
9. Board assembly site may have different recommendations for stencil design.

## GENERIC PACKAGE VIEW

**DSG 8**

**WSON - 0.8 mm max height**

2 x 2, 0.5 mm pitch

PLASTIC SMALL OUTLINE - NO LEAD

This image is a representation of the package family, actual package may vary.  
Refer to the product data sheet for package details.

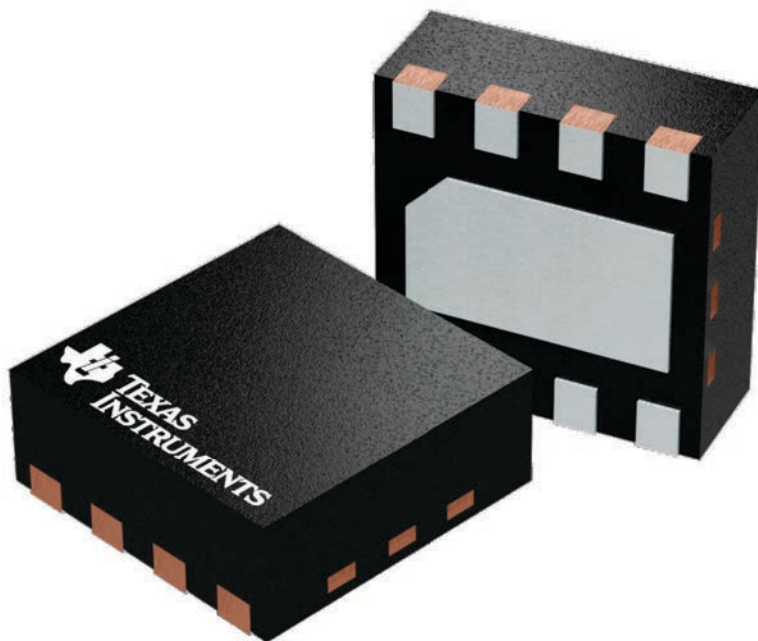

4224783/A

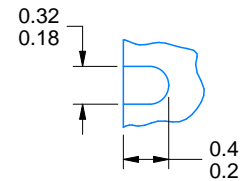
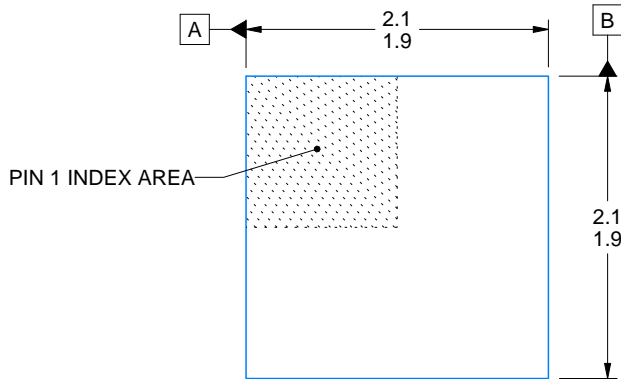
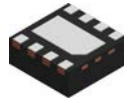

ALTERNATIVE TERMINAL SHAPE TYPICAL

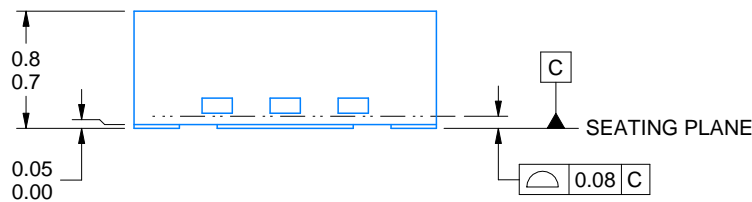

SIDE WALL METAL THICKNESS DIM A	
OPTION 1	OPTION 2
0.1	0.2

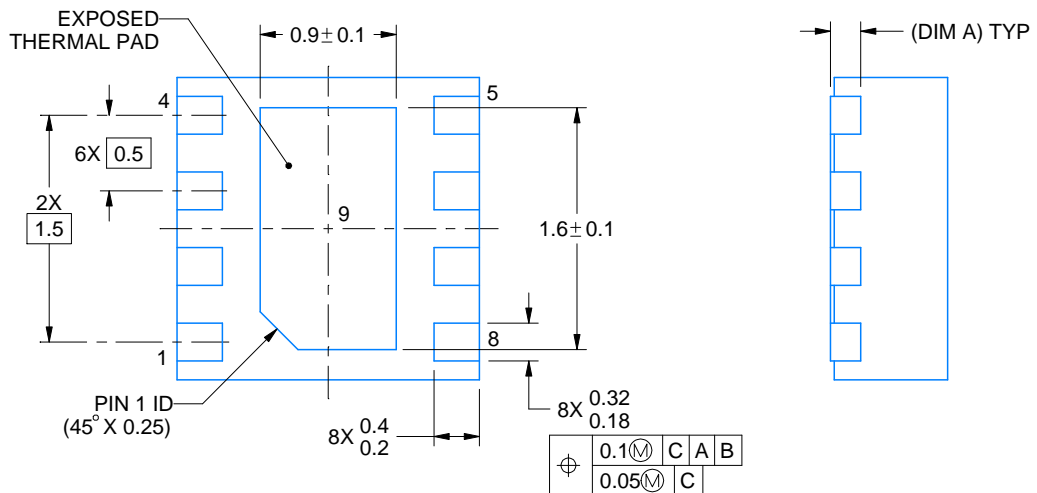

4218900/E 08/2022

NOTES:

1. All linear dimensions are in millimeters. Any dimensions in parenthesis are for reference only. Dimensioning and tolerancing per ASME Y14.5M.
2. This drawing is subject to change without notice.
3. The package thermal pad must be soldered to the printed circuit board for thermal and mechanical performance.

# EXAMPLE BOARD LAYOUT

DSG0008A

WSON - 0.8 mm max height

PLASTIC SMALL OUTLINE - NO LEAD

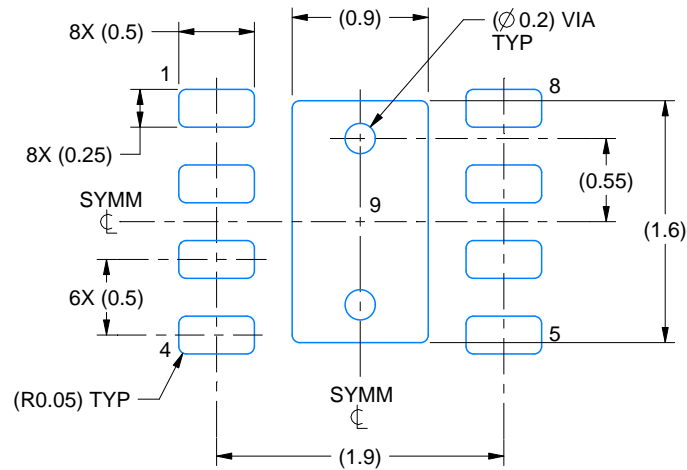

LAND PATTERN EXAMPLE  
SCALE:20X

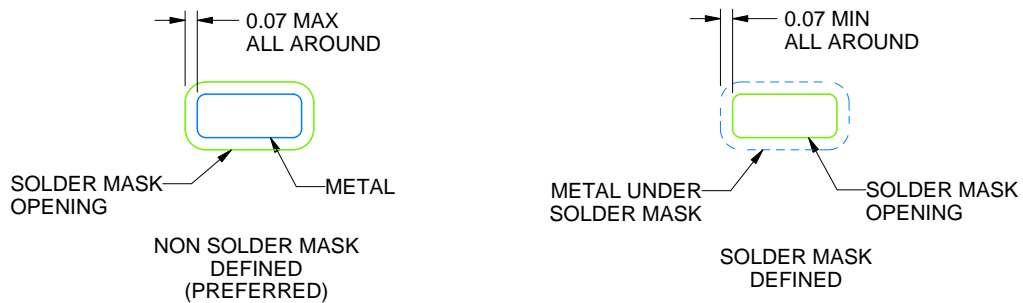

SOLDER MASK DETAILS

4218900/E 08/2022

NOTES: (continued)

4. This package is designed to be soldered to a thermal pad on the board. For more information, see Texas Instruments literature number SLUA271 ([www.ti.com/lit/slua271](http://www.ti.com/lit/slua271)).
5. Vias are optional depending on application, refer to device data sheet. If any vias are implemented, refer to their locations shown on this view. It is recommended that vias under paste be filled, plugged or tented.

# EXAMPLE STENCIL DESIGN

DSG0008A

WSON - 0.8 mm max height

PLASTIC SMALL OUTLINE - NO LEAD

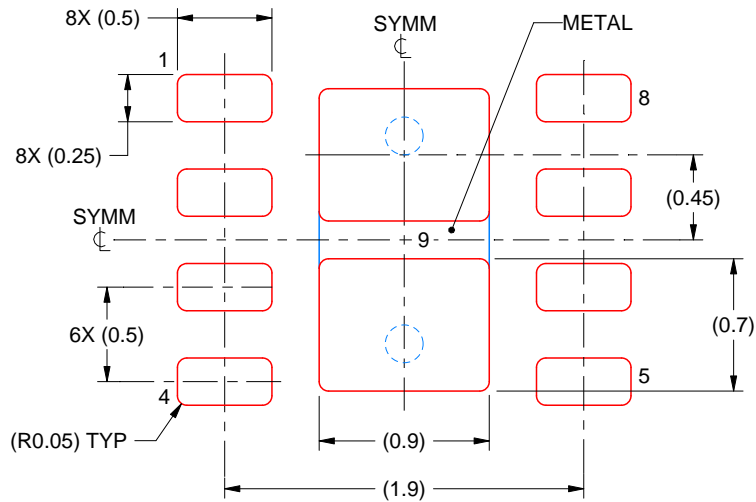

SOLDER PASTE EXAMPLE  
BASED ON 0.125 mm THICK STENCIL

EXPOSED PAD 9:  
87% PRINTED SOLDER COVERAGE BY AREA UNDER PACKAGE  
SCALE:25X

4218900/E 08/2022

NOTES: (continued)

6. Laser cutting apertures with trapezoidal walls and rounded corners may offer better paste release. IPC-7525 may have alternate design recommendations.

PW0008A



# PACKAGE OUTLINE

## TSSOP - 1.2 mm max height

SMALL OUTLINE PACKAGE



4221848/A 02/2015

### NOTES:

- All linear dimensions are in millimeters. Any dimensions in parenthesis are for reference only. Dimensioning and tolerancing per ASME Y14.5M.
- This drawing is subject to change without notice.
- This dimension does not include mold flash, protrusions, or gate burrs. Mold flash, protrusions, or gate burrs shall not exceed 0.15 mm per side.
- This dimension does not include interlead flash. Interlead flash shall not exceed 0.25 mm per side.
- Reference JEDEC registration MO-153, variation AA.

# EXAMPLE BOARD LAYOUT

PW0008A

TSSOP - 1.2 mm max height

SMALL OUTLINE PACKAGE



LAND PATTERN EXAMPLE  
SCALE:10X



SOLDER MASK DETAILS  
NOT TO SCALE

4221848/A 02/2015

NOTES: (continued)

- 6. Publication IPC-7351 may have alternate designs.
- 7. Solder mask tolerances between and around signal pads can vary based on board fabrication site.

# EXAMPLE STENCIL DESIGN

PW0008A

TSSOP - 1.2 mm max height

SMALL OUTLINE PACKAGE



SOLDER PASTE EXAMPLE  
BASED ON 0.125 mm THICK STENCIL  
SCALE:10X

4221848/A 02/2015

NOTES: (continued)

8. Laser cutting apertures with trapezoidal walls and rounded corners may offer better paste release. IPC-7525 may have alternate design recommendations.
9. Board assembly site may have different recommendations for stencil design.

## 重要通知和免责声明

TI“按原样”提供技术和可靠性数据（包括数据表）、设计资源（包括参考设计）、应用或其他设计建议、网络工具、安全信息和其他资源，不保证没有瑕疵且不做任何明示或暗示的担保，包括但不限于对适销性、与某特定用途的适用性或不侵犯任何第三方知识产权的暗示担保。

这些资源可供使用 TI 产品进行设计的熟练开发人员使用。您将自行承担以下全部责任：(1) 针对您的应用选择合适的 TI 产品，(2) 设计、验证并测试您的应用，(3) 确保您的应用满足相应标准以及任何其他安全、安保法规或其他要求。

这些资源如有变更，恕不另行通知。TI 授权您仅可将这些资源用于研发本资源所述的 TI 产品的相关应用。严禁以其他方式对这些资源进行复制或展示。您无权使用任何其他 TI 知识产权或任何第三方知识产权。对于因您对这些资源的使用而对 TI 及其代表造成的任何索赔、损害、成本、损失和债务，您将全额赔偿，TI 对此概不负责。

TI 提供的产品受 [TI 销售条款](#)、[TI 通用质量指南](#) 或 [ti.com](#) 上其他适用条款或 TI 产品随附的其他适用条款的约束。TI 提供这些资源并不会扩展或以其他方式更改 TI 针对 TI 产品发布的适用的担保或担保免责声明。除非德州仪器 (TI) 明确将某产品指定为定制产品或客户特定产品，否则其产品均为按确定价格收入目录的标准通用器件。

TI 反对并拒绝您可能提出的任何其他或不同的条款。

版权所有 © 2026，德州仪器 (TI) 公司

最后更新日期：2025 年 10 月