

## OPAx210 2.2nV/√Hz 精密低功耗 36V 运算放大器

### 1 特性

- 精密超级  $\beta$  输入性能：
  - 低失调电压：5 $\mu$ V (典型值)
  - 超低温漂：0.1 $\mu$ V/°C (典型值)
  - 低输入偏置电流：0.3nA (典型值)
- 超低噪声：
  - 0.1Hz 至 10Hz 低噪声：90nV<sub>PP</sub>
  - 低电压噪声：1kHz 时为 2.2nV/√Hz
- 高 CMRR：132dB (最小值)
- 增益带宽积：18MHz
- 压摆率：6.4 V/ $\mu$ s
- 低静态电流：2.5mA/每通道 (最大值)
- 短路电流：±65 mA
- 宽电源电压范围：±2.25V 至 ±18V
- 无相位反转
- 轨到轨输出
- 业界通用封装

### 2 应用

- 超声波扫描仪
- 多参数患者监护仪
- 商用网络和服务器 PSU
- 半导体测试
- 频谱分析仪
- 实验室和现场仪表
- 数据采集 (DAQ)
- 专业麦克风和无线系统

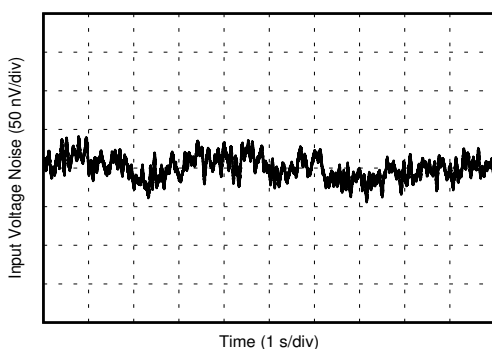

OPAx210 0.1Hz 至 10Hz 噪声

### 3 说明

OPA210 和 OPA2210 (OPAx210) 是 OPAx209 运算放大器的新一代产品。OPAx210 精密运算放大器基于 TI 的精密超级  $\beta$  互补双极半导体工艺进行构建，可提供超低闪烁噪声、低失调电压和低失调电压温漂。

OPAx210 可实现很低的电压噪声密度 (2.2nV/√Hz)，同时每个放大器仅消耗 2.5mA (最大值) 的电流。这两款器件还提供轨到轨输出摆幅，有助于更大限度地扩大动态范围。

在精密数据采集应用中，OPAx210 可实现精度达 16 位的快速稳定时间，即使输出摆幅为 10V 也是如此。出色的交流性能、仅 35 $\mu$ V (最大值) 的失调电压和 0.6 $\mu$ V/°C (最大值) 的温漂使 OPAx210 非常适用于高速、高精度应用。

OPAx210 可在 ±2.25V 至 ±18V 的双电源宽电压范围或 4.5V 至 36V 的单电源宽电压范围内运行，并且具有 -40°C 至 +125°C 的额定工作温度范围。

#### 器件信息

| 器件型号    | 封装 <sup>(1)</sup> | 封装尺寸 (标称值)      |
|---------|-------------------|-----------------|
| OPA210  | SOIC (8)          | 2.90mm × 1.60mm |
|         | SOT-23 (5)        | 2.90mm × 1.60mm |
|         | VSSOP (8)         | 3.00mm × 3.00mm |
| OPA2210 | SOIC (8)          | 4.90mm × 3.91mm |
|         | VSSOP (8)         | 3.00mm × 3.00mm |
|         | WSON (8)          | 3.00mm × 3.00mm |

(1) 如需了解所有可用封装，请参阅数据表末尾的封装选项附录。

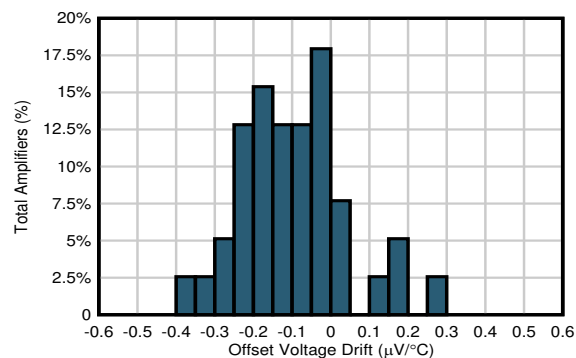

OPAx210 失调电压温漂分布图



## Table of Contents

|  |           |  |           |
|--|-----------|--|-----------|
| <b>1 特性</b> .....                              | <b>1</b>  | <b>8 Application and Implementation</b> .....                    | <b>19</b> |
| <b>2 应用</b> .....                              | <b>1</b>  | 8.1 Application Information.....                                 | 19        |
| <b>3 说明</b> .....                              | <b>1</b>  | 8.2 Typical Application.....                                     | 21        |
| <b>4 Revision History</b> .....                | <b>2</b>  | 8.3 System Example.....  | 22        |
| <b>5 Pin Configuration and Functions</b> ..... | <b>3</b>  | <b>9 Power Supply Recommendations</b> .....                      | <b>23</b> |
| <b>6 Specifications</b> .....                  | <b>4</b>  | <b>10 Layout</b> .....   | <b>23</b> |
| 6.1 Absolute Maximum Ratings .....             | 4         | 10.1 Layout Guidelines.....                                      | 23        |
| 6.2 ESD Ratings .....                          | 4         | 10.2 Layout Example.....   | 23        |
| 6.3 Recommended Operating Conditions .....     | 4         | <b>11 Device and Documentation Support</b> .....                 | <b>24</b> |
| 6.4 Thermal Information: OPA210 .....          | 5         | 11.1 Device Support.....   | 24        |
| 6.5 Thermal Information: OPA2210 .....         | 5         | 11.2 Documentation Support.....                                  | 26        |
| 6.6 Electrical Characteristics .....           | 6         | 11.3 接收文档更新通知.....   | 26        |
| 6.7 Typical Characteristics.....               | 8         | 11.4 支持资源.....   | 26        |
| <b>7 Detailed Description</b> .....            | <b>15</b> | 11.5 Trademarks.....   | 26        |
| 7.1 Overview.....                              | 15        | 11.6 Electrostatic Discharge Caution.....                        | 26        |
| 7.2 Functional Block Diagram.....              | 15        | 11.7 术语表.....  | 26        |
| 7.3 Feature Description.....                   | 16        | <b>12 Mechanical, Packaging, and Orderable Information</b> ..... | <b>26</b> |
| 7.4 Device Functional Modes.....               | 18        |  |           |

## 4 Revision History

注：以前版本的页码可能与当前版本的页码不同

|   |             |
|---|-------------|
| <b>Changes from Revision G (April 2021) to Revision H (August 2021)</b> .....       | <b>Page</b> |
| • 将 OPA210 DBV (SOT-23-5) 和 DGK (VSSOP-8) 封装从预告信息 (预发布) 更改为量产数据 (正在供货) ...          | 1           |
| <b>Changes from Revision F (January 2021) to Revision G (April 2021)</b> .....      | <b>Page</b> |
| • 将 OPA210 D (SOIC-8) 封装从预告信息 (预发布) 更改为量产数据 (正在供货) .....                            | 1           |
| • 添加了 OPA210 DBV (SOT-23-5) 封装, 作为预告信息 (预发布) .....                                  | 1           |
| <b>Changes from Revision E (November 2020) to Revision F (January 2021)</b> .....   | <b>Page</b> |
| • 添加了采用 D 和 DGK 封装的 OPA210 器件, 作为预告信息 (预发布) .....                                   | 1           |
| <b>Changes from Revision D (January 2020) to Revision E (November 2020)</b> .....   | <b>Page</b> |
| • 将 OPA2210 DRG 封装从预告信息 (预发布) 更改为量产数据 (正在供货) .....                                  | 1           |
| <b>Changes from Revision C (September 2019) to Revision D (January 2020)</b> .....  | <b>Page</b> |
| • 向数据表添加了 OPA2210 DRG 封装, 作为预告信息 (预发布) .....  | 1           |
| <b>Changes from Revision B (March 2019) to Revision C (September 2019)</b> .....    | <b>Page</b> |
| • 将 “super-β” (超级 β) 更改为 “super beta” (超级 β), 以便于搜索.....                            | 1           |
| • 添加了 SOIC 封装.....  | 1           |
| <b>Changes from Revision A (December 2018) to Revision B (February 2019)</b> .....  | <b>Page</b> |
| • Changed "OPAx145" to "OPA2210".....   | 19          |
| • Fixed link to TIDA-01427 .....  | 22          |
| <b>Changes from Revision * (September 2018) to Revision A (December 2018)</b> ..... | <b>Page</b> |
| • 首次发布量产数据数据表.....  | 1           |

## 5 Pin Configuration and Functions



图 5-1. OPA210: D (8-Pin SOIC) and DGK (8-Pin VSSOP) Packages, Top View



图 5-2. OPA210: DBV (5-Pin SOT-23) Package, Top View

表 5-1. Pin Functions: OPA210

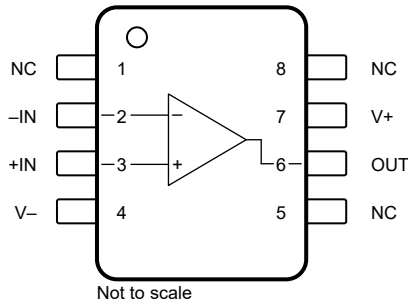
| NAME | PIN         |        | I/O | DESCRIPTION                     |
|------|-------------|--------|-----|---------------------------------|
|      | SOIC, VSSOP | SOT-23 |     |                                 |
| - IN | 2           | 4      | I   | Inverting input                 |
| +IN  | 3           | 3      | I   | Noninverting input              |
| NC   | 1, 5, 8     | —      | —   | No internal connection          |
| OUT  | 6           | 1      | O   | Output                          |
| V -  | 4           | 2      | —   | Negative (lowest) power supply  |
| V+   | 7           | 5      | —   | Positive (highest) power supply |

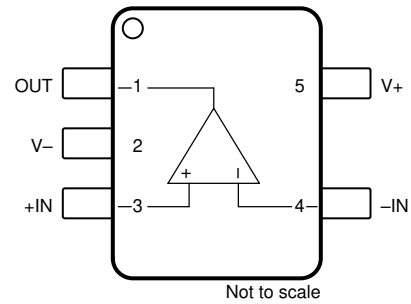

图 5-3. OPA2210: D (SOIC-8), DGK (VSSOP-8), and DRG (WSON-8) Packages, Top View

表 5-2. Pin Functions: OPA2210

| NAME   | PIN |  | I/O | DESCRIPTION                     |
|--------|-----|--|-----|---------------------------------|
|        | NO. |  |     |                                 |
| - IN A | 2   |  | I   | Inverting input, channel A      |
| +IN A  | 3   |  | I   | Noninverting input, channel A   |
| - IN B | 6   |  | I   | Inverting input, channel B      |
| +IN B  | 5   |  | I   | Noninverting input, channel B   |
| OUT A  | 1   |  | O   | Output, channel A               |
| OUT B  | 7   |  | O   | Output, channel B               |
| V -    | 4   |  | —   | Negative (lowest) power supply  |
| V+     | 8   |  | —   | Positive (highest) power supply |

## 6 Specifications

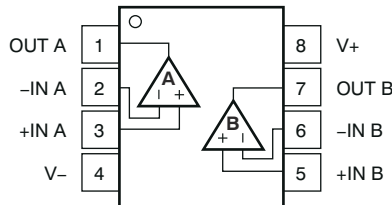
### 6.1 Absolute Maximum Ratings

over operating free-air temperature range (unless otherwise noted)<sup>(1)</sup>

|             |                                     | MIN          | MAX          | UNIT |
|-------------|-------------------------------------|--------------|--------------|------|
| Voltage     | Supply voltage, $V_S = (V+) - (V-)$ |              | 40           | V    |
|             | Signal input pins <sup>(2)</sup>    | $(V-) - 0.5$ | $(V+) + 0.5$ |      |
|             | Signal input pins                   |              | 1            |      |
| Current     | Signal input pins <sup>(2)</sup>    | - 10         | 10           | mA   |
|             | Output short circuit <sup>(3)</sup> | Continuous   |              |      |
| Temperature | Junction, $T_J$                     |              | 150          | °C   |
|             | Storage temperature, $T_{stg}$      | - 65         | 150          |      |

(1) Stresses beyond those listed under *Absolute Maximum Ratings* may cause permanent damage to the device. These are stress ratings only, which do not imply functional operation of the device at these or any other conditions beyond those indicated under *Recommended Operating Conditions*. Exposure to absolute-maximum-rated conditions for extended periods may affect device reliability.

(2) For input voltages beyond the power-supply rails, voltage or current must be limited.

(3) Short circuit to ground, one amplifier per package.

### 6.2 ESD Ratings

|             |                         |  | VALUE | UNIT |
|-------------|-------------------------|--|-------|------|
| $V_{(ESD)}$ | Electrostatic discharge | Human-body model (HBM), per ANSI/ESDA/JEDEC JS-001 <sup>(1)</sup>              | ±4000 | V    |
|             |                         | Charged-device model (CDM), per JEDEC specification JESD22-C101 <sup>(2)</sup> | ±1500 |      |

(1) JEDEC document JEP155 states that 500-V HBM allows safe manufacturing with a standard ESD control process.

(2) JEDEC document JEP157 states that 250-V CDM allows safe manufacturing with a standard ESD control process.

### 6.3 Recommended Operating Conditions

over operating free-air temperature range (unless otherwise noted)

|                              | MIN   | MAX | UNIT |
|------------------------------|-------|-----|------|
| Specified voltage, $V_S$     | ±2.25 | ±18 | V    |
| Specified temperature        | - 40  | 125 | °C   |
| Operating temperature, $T_A$ | - 55  | 150 | °C   |

## 6.4 Thermal Information: OPA210

| THERMAL METRIC <sup>(1)</sup> |  | OPA210   |             |              | UNIT |
|-------------------------------|--|----------|-------------|--------------|------|
|                               |  | D (SOIC) | DGK (VSSOP) | DBV (SOT-23) |      |
|                               |  | 8 PINS   | 8 PINS      | 5 PINS       |      |
| $R_{\theta JA}$               | Junction-to-ambient thermal resistance       | 131.2    | 171.3       | 180.4        | °C/W |
| $R_{\theta JC(top)}$          | Junction-to-case (top) thermal resistance    | 71.6     | 64.7        | 67.9         | °C/W |
| $R_{\theta JB}$               | Junction-to-board thermal resistance         | 74.6     | 92.4        | 102.1        | °C/W |
| $\psi_{JT}$                   | Junction-to-top characterization parameter   | 22.4     | 10.4        | 10.4         | °C/W |
| $\psi_{JB}$                   | Junction-to-board characterization parameter | 73.8     | 90.9        | 100.3        | °C/W |
| $R_{\theta JC(bottom)}$       | Junction-to-case (bottom) thermal resistance | N/A      | N/A         | N/A          | °C/W |

- (1) For more information about traditional and new thermal metrics, see the [Semiconductor and IC Package Thermal Metrics](#) application report.

## 6.5 Thermal Information: OPA2210

| THERMAL METRIC <sup>(1)</sup> |  | OPA2210  |             |           | UNIT |
|-------------------------------|--|----------|-------------|-----------|------|
|                               |  | D (SOIC) | DGK (VSSOP) | DRG (SON) |      |
|                               |  | 8 PINS   | 8 PINS      | 8 PINS    |      |
| $R_{\theta JA}$               | Junction-to-ambient thermal resistance       | 126.1    | 132.7       | 52.1      | °C/W |
| $R_{\theta JC(top)}$          | Junction-to-case (top) thermal resistance    | 65.7     | 38.5        | 51.8      | °C/W |
| $R_{\theta JB}$               | Junction-to-board thermal resistance         | 69.5     | 52.1        | 24.8      | °C/W |
| $\psi_{JT}$                   | Junction-to-top characterization parameter   | 17.4     | 2.4         | 1.1       | °C/W |
| $\psi_{JB}$                   | Junction-to-board characterization parameter | 68.9     | 52.8        | 24.8      | °C/W |
| $R_{\theta JC(bot)}$          | Junction-to-case (bottom) thermal resistance | n/a      | n/a         | 9.0       | °C/W |

- (1) For more information about traditional and new thermal metrics, see the [Semiconductor and IC Package Thermal Metrics](#) application report.

## 6.6 Electrical Characteristics

at  $V_S = \pm 15\text{ V}$ ,  $T_A = 25^\circ\text{C}$ ,  $R_L = 10\text{ k}\Omega$  connected to midsupply, and  $V_{CM} = V_{OUT} = \text{midsupply}$  (unless otherwise noted)

| PARAMETER                   |   | TEST CONDITIONS  |  | MIN           | TYP                  | MAX           | UNIT                                 |
|-----------------------------|---|--|--|---------------|----------------------|---------------|--------------------------------------|
| <b>OFFSET VOLTAGE</b>       |   |  |  |               |                      |               |                                      |
| $V_{OS}$                    | Input offset voltage                      | $V_S = \pm 15\text{ V}$ , $V_{CM} = 0\text{ V}$  |  |               | $\pm 5$              | $\pm 35$      | $\mu\text{V}$                        |
| $dV_{OS}/dT$                | Input offset voltage drift                | $T_A = -40^\circ\text{C}$ to $125^\circ\text{C}$   |  |               | $\pm 0.1$            | $\pm 0.5$     | $\mu\text{V}/^\circ\text{C}$         |
| $V_{OS}$ - matching         | Input offset voltage matching             |  |  |               | $\pm 5$              | $\pm 35$      | $\mu\text{V}$                        |
| PSRR                        | vs power supply                           | $V_S = \pm 2.25\text{ V}$ to $\pm 18\text{ V}$   | $T_A = 25^\circ\text{C}$                         |               | 0.05                 | 0.5           | $\mu\text{V}/\text{V}$               |
|                             |   |  | $T_A = -40^\circ\text{C}$ to $125^\circ\text{C}$ |               |                      | $\pm 1$       |                                      |
|                             | Channel separation                        | DC   |  |               | $\pm 0.1$            |               | $\mu\text{V}/\text{V}$               |
| <b>INPUT BIAS OPERATION</b> |   |  |  |               |                      |               |                                      |
| $I_B$                       | Input bias current                        | $V_{CM} = 0\text{ V}$  | $T_A = 25^\circ\text{C}$                         |               | $\pm 0.3$            | $\pm 2$       | nA                                   |
|                             |   |  | $T_A = -40^\circ\text{C}$ to $85^\circ\text{C}$  |               |                      | $\pm 4$       |                                      |
|                             |   |  | $T_A = -40^\circ\text{C}$ to $125^\circ\text{C}$ |               |                      | $\pm 7$       |                                      |
| $I_{OS}$                    | Input offset current                      | $V_{CM} = 0\text{ V}$  | $T_A = 25^\circ\text{C}$                         |               | $\pm 0.1$            | $\pm 2$       | nA                                   |
|                             |   |  | $T_A = -40^\circ\text{C}$ to $85^\circ\text{C}$  |               |                      | $\pm 4$       |                                      |
|                             |   |  | $T_A = -40^\circ\text{C}$ to $125^\circ\text{C}$ |               |                      | $\pm 7$       |                                      |
| <b>NOISE</b>                |   |  |  |               |                      |               |                                      |
| $e_{n\text{-pp}}$           | Input voltage noise                       | $f = 0.1\text{ Hz}$ to $10\text{ Hz}$  |  |               | 0.09                 |               | $\mu\text{V}_{PP}$                   |
| $e_n$                       | Noise density                             | $f = 10\text{ Hz}$   |  |               | 2.5                  |               | $\text{nV}/\sqrt{\text{Hz}}$         |
|                             |   | $f = 100\text{ Hz}$  |  |               | 2.25                 |               |                                      |
|                             |   | $f = 1\text{ kHz}$   |  |               | 2.2                  |               |                                      |
| $I_n$                       | Input current noise density               | $f = 1\text{ kHz}$   |  |               | 400                  |               | $\text{fA}/\sqrt{\text{Hz}}$         |
| <b>INPUT VOLTAGE RANGE</b>  |   |  |  |               |                      |               |                                      |
| $V_{CM}$                    | Common-mode voltage range                 |  |  | $(V_-) + 1.5$ |                      | $(V_+) - 1.5$ | V                                    |
| CMRR                        | Common-mode rejection ratio               | $(V_-) + 1.5\text{ V} < V_{CM} < (V_+) - 1.5\text{ V}$   |  | 132           | 140                  |               | dB                                   |
|                             |   | $(V_-) + 1.5\text{ V} < V_{CM} < (V_+) - 1.5\text{ V}$ ,<br>$T_A = -40^\circ\text{C}$ to $125^\circ\text{C}$ |  | 120           | 130                  |               |                                      |
| <b>INPUT IMPEDANCE</b>      |   |  |  |               |                      |               |                                      |
|                             | Differential                              |  |  |               | $400 \parallel 9$    |               | $\text{k}\Omega \parallel \text{pF}$ |
|                             | Common-mode                               |  |  |               | $10^9 \parallel 0.5$ |               | $\Omega \parallel \text{pF}$         |
| <b>OPEN-LOOP GAIN</b>       |   |  |  |               |                      |               |                                      |
| $A_{OL}$                    | Open-loop voltage gain                    | $(V_-) + 0.2\text{ V} < V_O < (V_+) - 0.2\text{ V}$ , $R_L = 10\text{ k}\Omega$                              | $T_A = 25^\circ\text{C}$                         | 126           | 132                  |               | dB                                   |
|                             |   |  | $T_A = -40^\circ\text{C}$ to $125^\circ\text{C}$ | 120           |                      |               |                                      |
|                             |   | $(V_-) + 0.6\text{ V} < V_O < (V_+) - 0.6\text{ V}$ , $R_L = 600\ \Omega$ <sup>(1)</sup>                     | $T_A = 25^\circ\text{C}$                         | 114           | 120                  |               |                                      |
|                             |   |  | $T_A = -40^\circ\text{C}$ to $85^\circ\text{C}$  | 110           |                      |               |                                      |
| <b>FREQUENCY RESPONSE</b>   |   |  |  |               |                      |               |                                      |
| GBW                         | Gain bandwidth product                    |  |  |               | 18                   |               | MHz                                  |
| SR                          | Slew rate                                 |  |  |               | 6.4                  |               | $\text{V}/\mu\text{s}$               |
|                             | Phase margin ( $\Phi_m$ )                 | $R_L = 10\text{ k}\Omega$ , $C_L = 25\text{ pF}$   |  |               | 80                   |               | degrees                              |
| $t_s$                       | Settling time                             | 0.1%, $G = -1$ , 10-V step, $C_L = 100\text{ pF}$  |  |               | 2.1                  |               | $\mu\text{s}$                        |
|                             |   | 0.0015% (16-bit), $G = -1$ , 10-V step, $C_L = 100\text{ pF}$  |  |               | 2.6                  |               |                                      |
|                             | Overload recovery time                    | $G = -10$  |  |               | 0.5                  |               | $\mu\text{s}$                        |
|                             | Total harmonic distortion + noise (THD+N) | $G = +1$ , $f = 1\text{ kHz}$ , $V_O = 20\text{ V}_{PP}$ , $600\ \Omega$                                     |  |               | 0.000025             |               | %                                    |

## 6.6 Electrical Characteristics (continued)

at  $V_S = \pm 15\text{ V}$ ,  $T_A = 25^\circ\text{C}$ ,  $R_L = 10\text{ k}\Omega$  connected to midsupply, and  $V_{CM} = V_{OUT} = \text{midsupply}$  (unless otherwise noted)

| PARAMETER            | TEST CONDITIONS   | MIN                     | TYP  | MAX           | UNIT |    |
|----------------------|---|-------------------------|--|---------------|------|----|
| <b>OUTPUT</b>        |   |                         |  |               |      |    |
| Voltage output swing | $R_L = 10\text{ k}\Omega$ , $A_{OL} > 130\text{ dB}$  | $(V_-) + 0.2$           |  | $(V_+) - 0.2$ | V    |    |
|                      | $R_L = 600\ \Omega$ , $A_{OL} > 114\text{ dB}$  | $(V_-) + 0.6$           |  | $(V_+) - 0.6$ |      |    |
|                      | $R_L = 10\text{ k}\Omega$ , $A_{OL} > 120\text{ dB}$ , $T_A = -40^\circ\text{C}$ to $125^\circ\text{C}$ | $(V_-) + 0.2$           |  | $(V_+) - 0.2$ |      |    |
| $I_{SC}$             | Short-circuit current   | $V_S = \pm 18\text{ V}$ |  | $\pm 65$      | mA   |    |
| $C_{LOAD}$           | Capacitive load drive (stable operation)  |                         |  | See # 6.7     |      |    |
| $Z_O$                | Open-loop output impedance  |                         |  | See # 6.7     |      |    |
| <b>POWER SUPPLY</b>  |   |                         |  |               |      |    |
| $I_Q$                | Quiescent current (per amplifier)   | $I_O = 0\text{ A}$      | $T_A = 25^\circ\text{C}$                         | 2.2           | 2.5  | mA |
|                      |   |                         | $T_A = -40^\circ\text{C}$ to $125^\circ\text{C}$ |               | 3.25 |    |

(1) Temperature range limited by thermal performance of the package.

## 6.7 Typical Characteristics

at  $T_A = 25^\circ\text{C}$ ,  $V_S = \pm 15\text{ V}$ ,  $R_L = 10\text{ k}\Omega$  connected to midsupply, and  $V_{CM} = V_{OUT} = \text{midsupply}$  (unless otherwise noted)

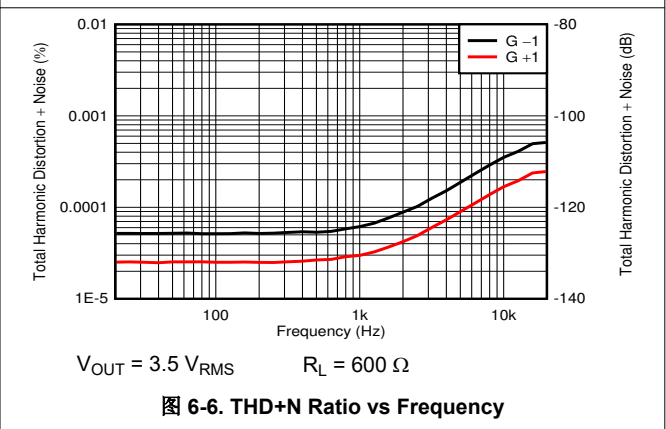
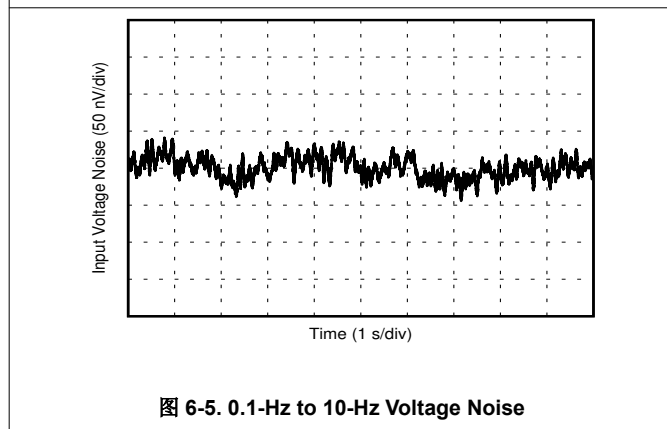
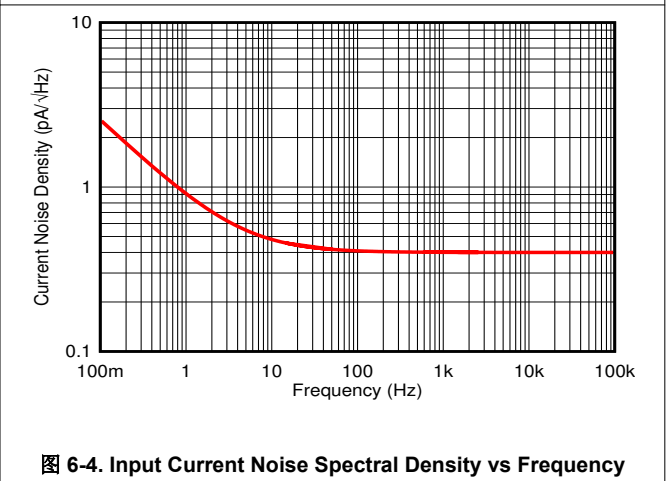
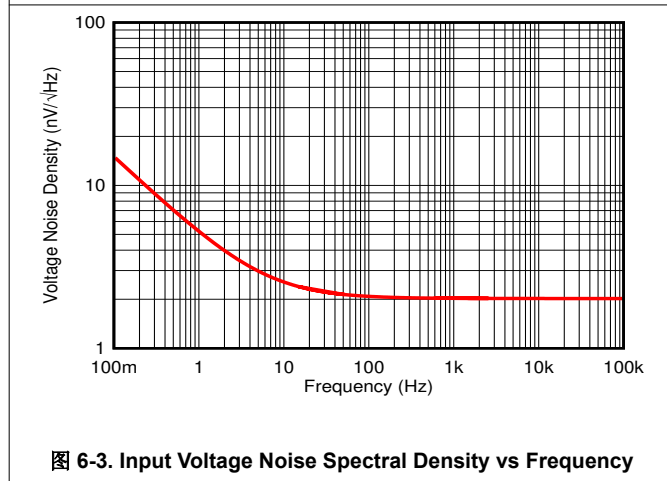
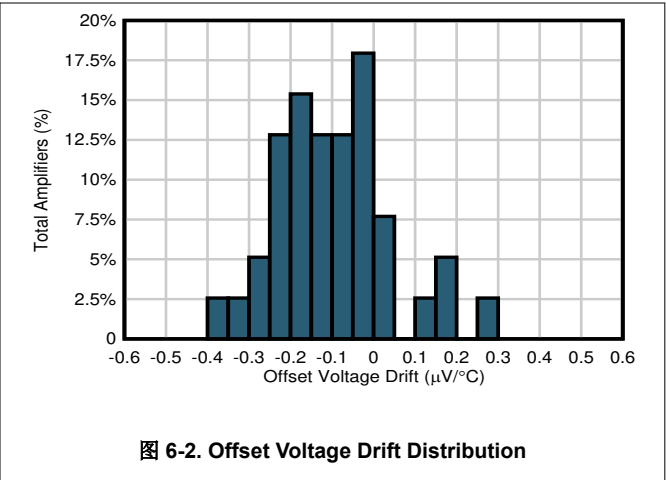
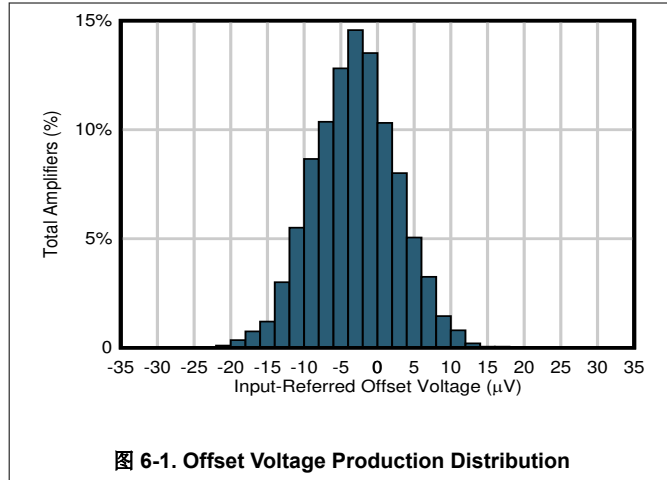

### 6.7 Typical Characteristics (continued)

at  $T_A = 25^\circ\text{C}$ ,  $V_S = \pm 15\text{ V}$ ,  $R_L = 10\text{ k}\Omega$  connected to midsupply, and  $V_{CM} = V_{OUT} = \text{midsupply}$  (unless otherwise noted)

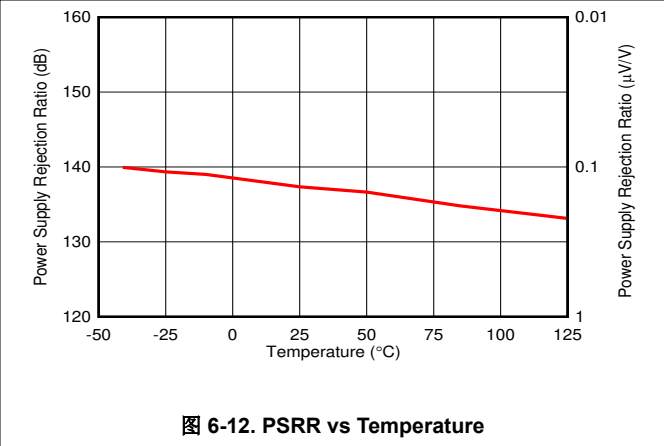
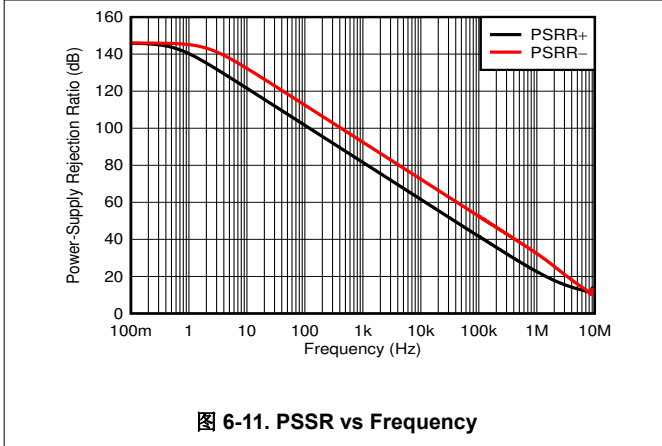
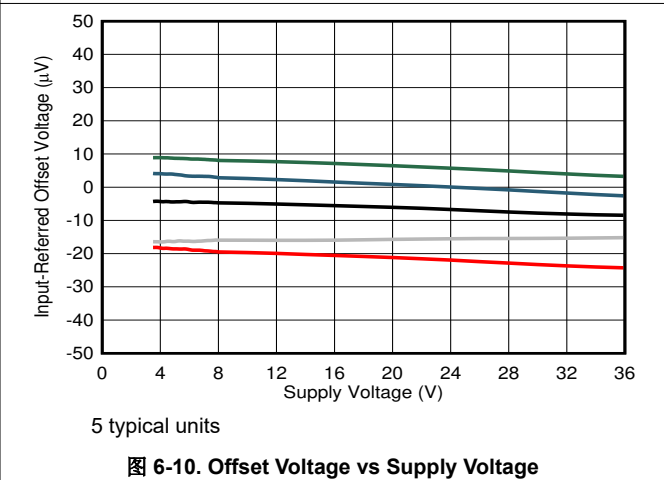
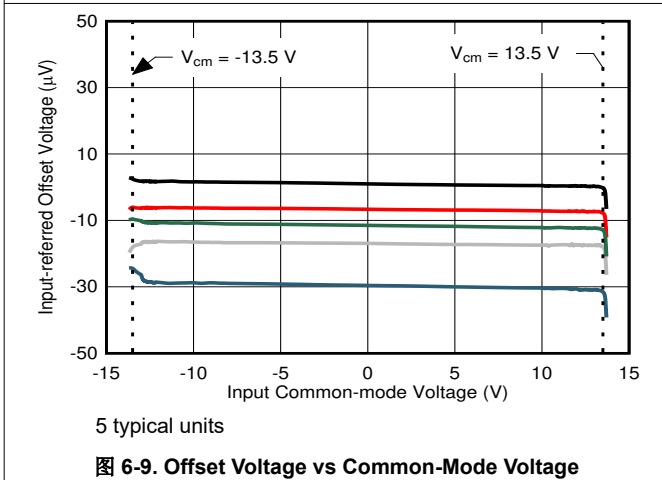
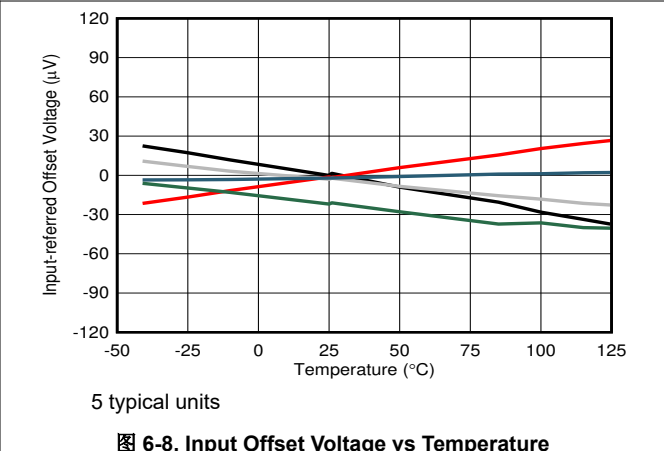
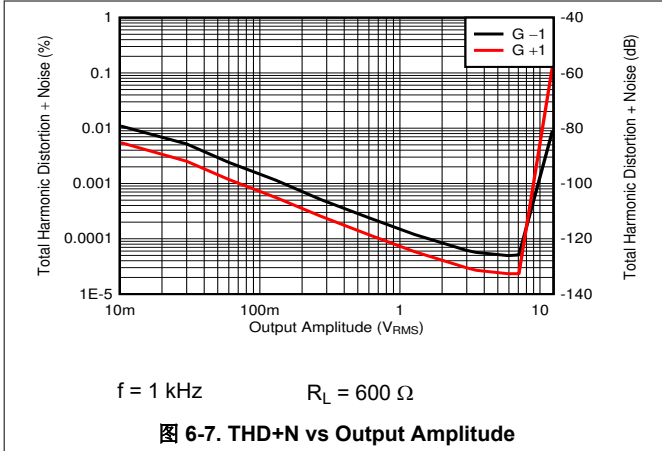

### 6.7 Typical Characteristics (continued)

at  $T_A = 25^\circ\text{C}$ ,  $V_S = \pm 15\text{ V}$ ,  $R_L = 10\text{ k}\Omega$  connected to midsupply, and  $V_{CM} = V_{OUT} = \text{midsupply}$  (unless otherwise noted)



图 6-13. CMRR vs Frequency



图 6-14. CMRR vs Temperature

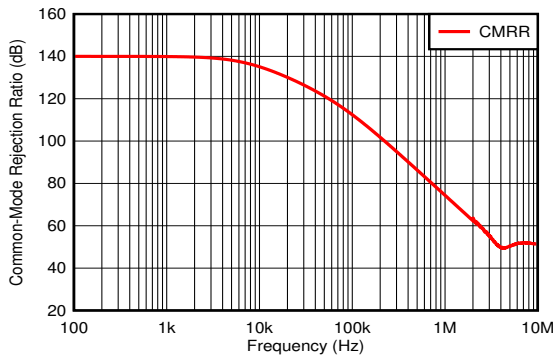

图 6-15. Open-Loop Output Impedance vs Frequency

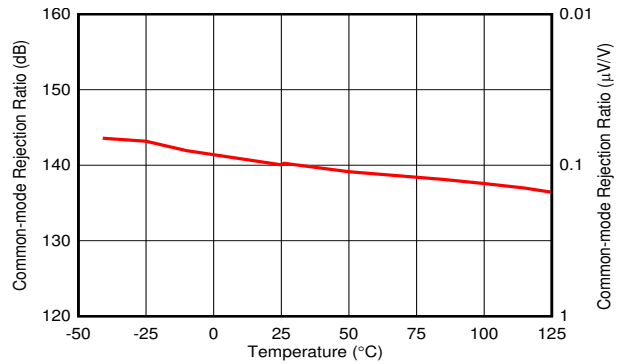

图 6-16. Open-Loop Gain and Phase vs Frequency

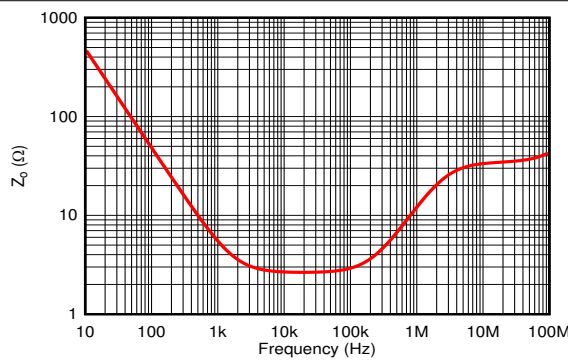

图 6-17. Open-Loop Gain vs Temperature

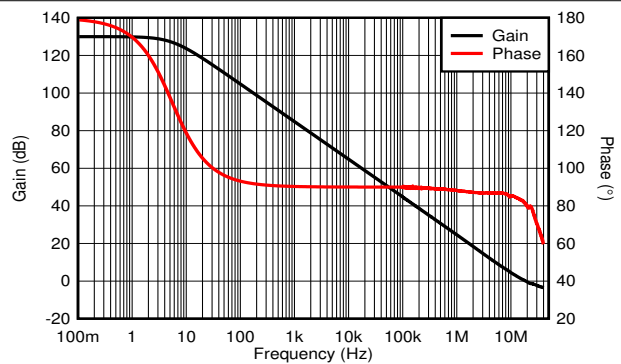

图 6-18. Positive Input Bias Current Production Distribution

### 6.7 Typical Characteristics (continued)

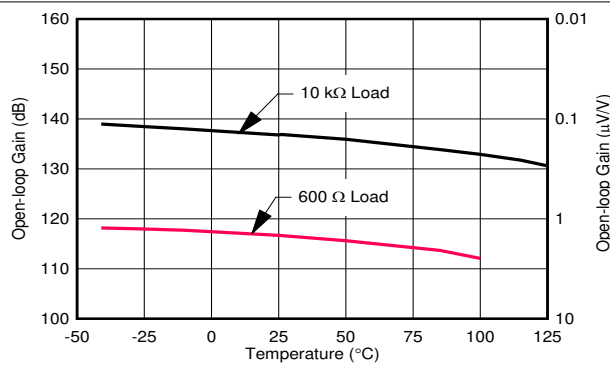
at  $T_A = 25^\circ\text{C}$ ,  $V_S = \pm 15\text{ V}$ ,  $R_L = 10\text{ k}\Omega$  connected to midsupply, and  $V_{CM} = V_{OUT} = \text{midsupply}$  (unless otherwise noted)

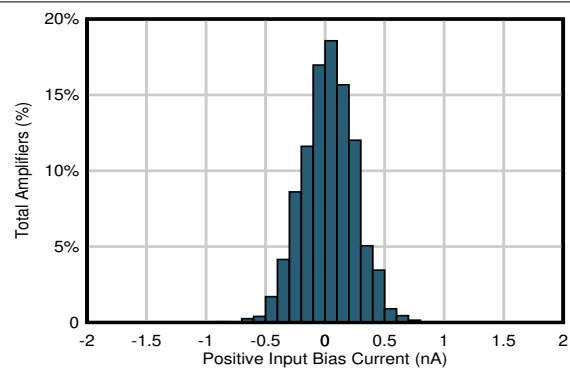

图 6-19. Negative Input Bias Current Production Distribution



图 6-20. Input Offset Current Production Distribution

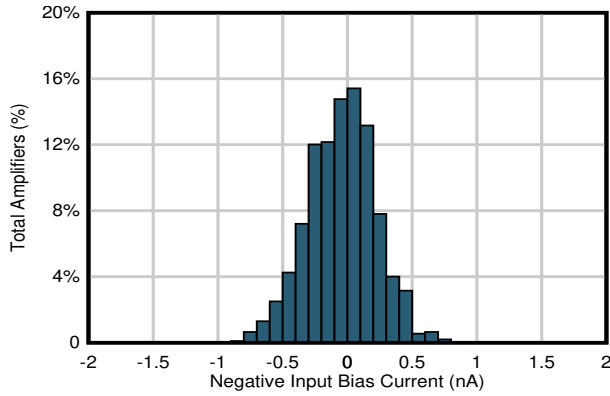

图 6-21. Input Bias and Input Offset Currents vs Temperature

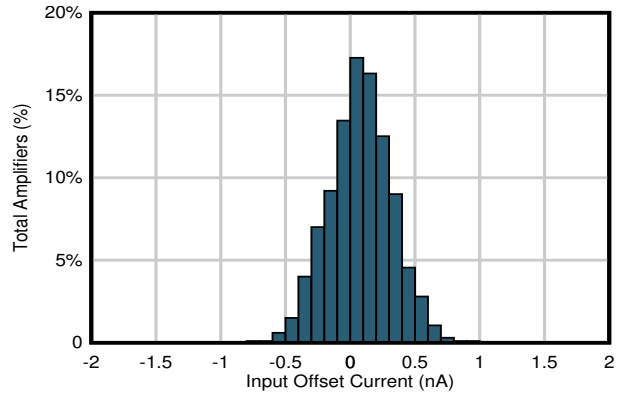

图 6-22. Positive Input Bias Current vs Common-Mode Voltage

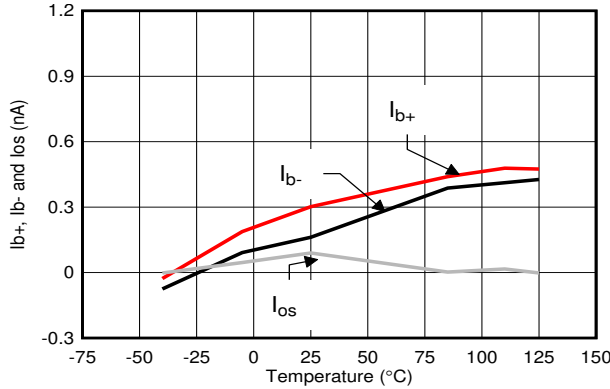

图 6-23. Negative Input Bias Current vs Common-Mode Voltage

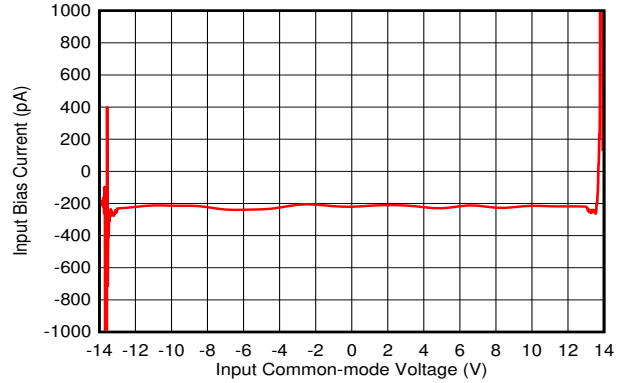

图 6-24. Input Offset Current vs Common-Mode Voltage

### 6.7 Typical Characteristics (continued)

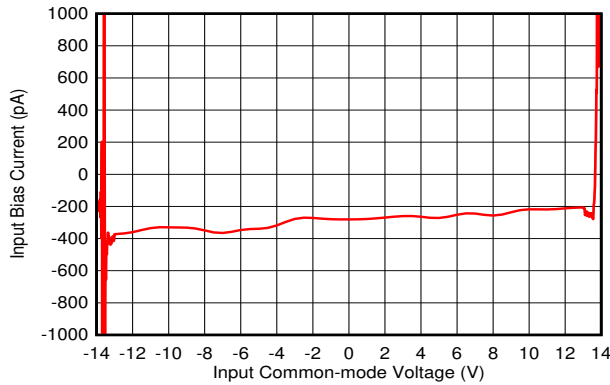
at  $T_A = 25^\circ\text{C}$ ,  $V_S = \pm 15\text{ V}$ ,  $R_L = 10\text{ k}\Omega$  connected to midsupply, and  $V_{CM} = V_{OUT} = \text{midsupply}$  (unless otherwise noted)

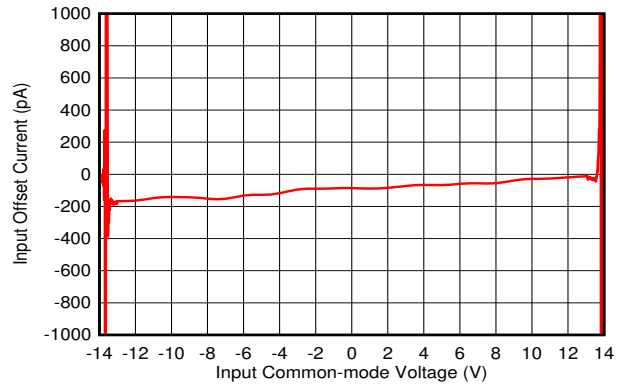

图 6-25. Quiescent Current vs Supply Voltage



图 6-26. Quiescent Current vs Temperature

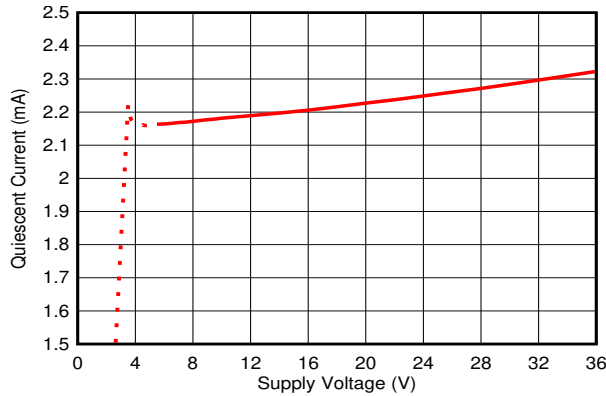

A.

图 6-27. Output Voltage vs Output Current (Sourcing)

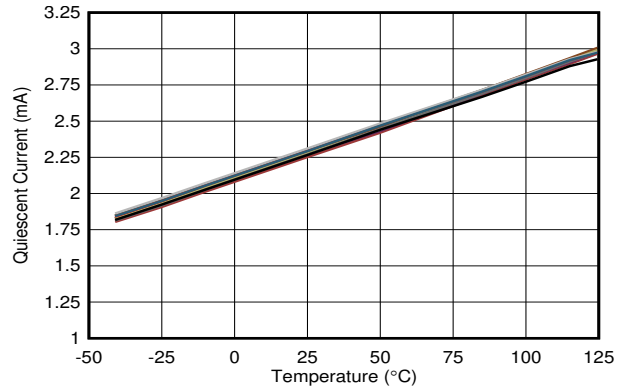
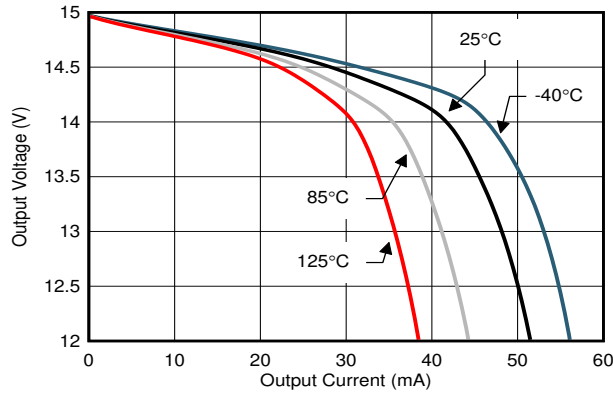
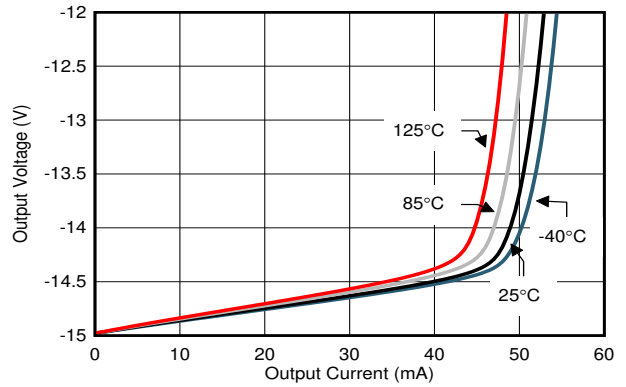

A.

图 6-28. Output Voltage vs Output Current (Sinking)



图 6-29. Short-Circuit Current vs Temperature



图 6-30. No Phase Reversal

## 6.7 Typical Characteristics (continued)

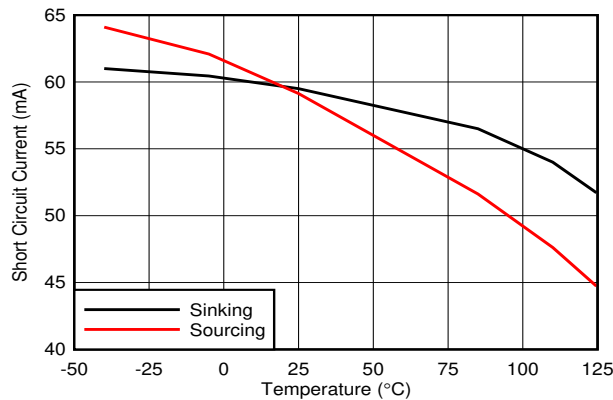
at  $T_A = 25^\circ\text{C}$ ,  $V_S = \pm 15\text{ V}$ ,  $R_L = 10\text{ k}\Omega$  connected to midsupply, and  $V_{CM} = V_{OUT} = \text{midsupply}$  (unless otherwise noted)

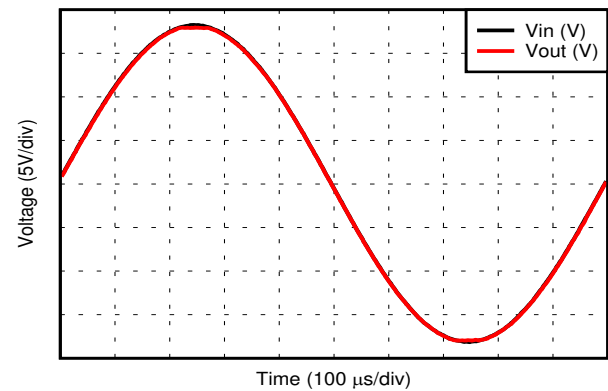

图 6-31. Positive Overload Recovery



图 6-32. Negative Overload Recovery

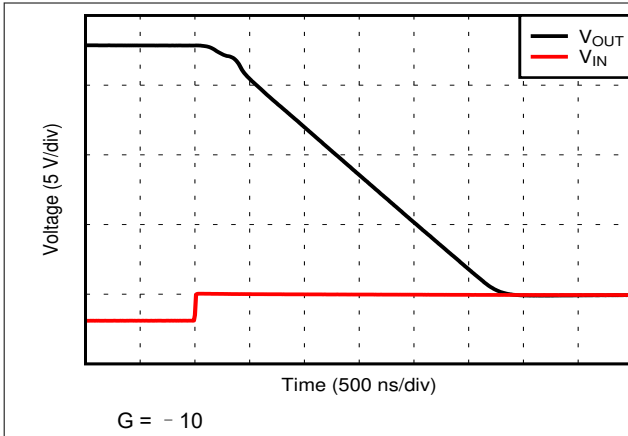

图 6-33. Small-Signal Step Response

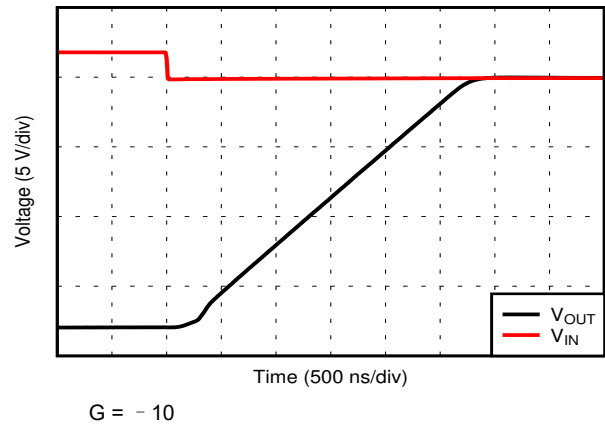

图 6-34. Small-Signal Step Response

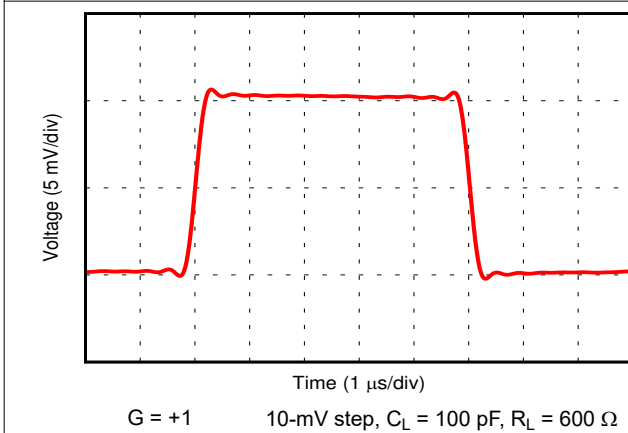

图 6-35. Large-Signal Step Response

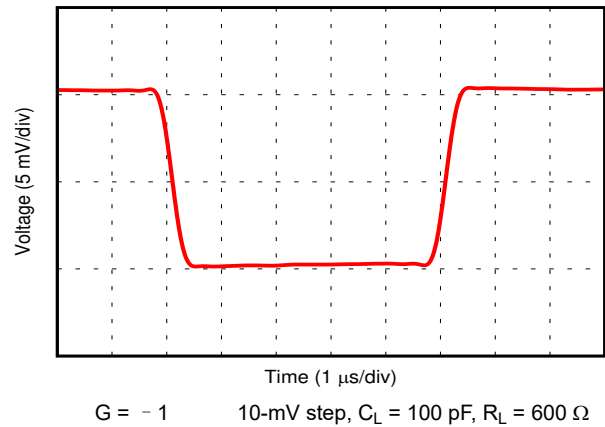

图 6-36. Large-Signal Step Response

## 6.7 Typical Characteristics (continued)

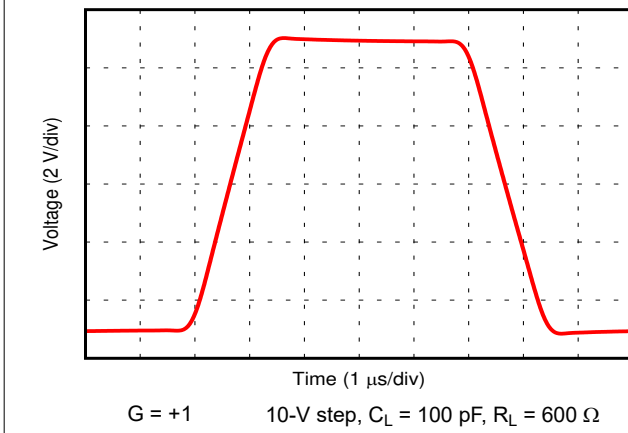
at  $T_A = 25^\circ\text{C}$ ,  $V_S = \pm 15\text{ V}$ ,  $R_L = 10\text{ k}\Omega$  connected to midsupply, and  $V_{CM} = V_{OUT} = \text{midsupply}$  (unless otherwise noted)

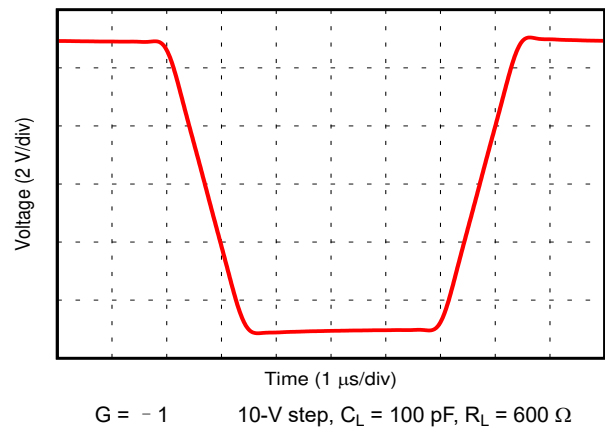
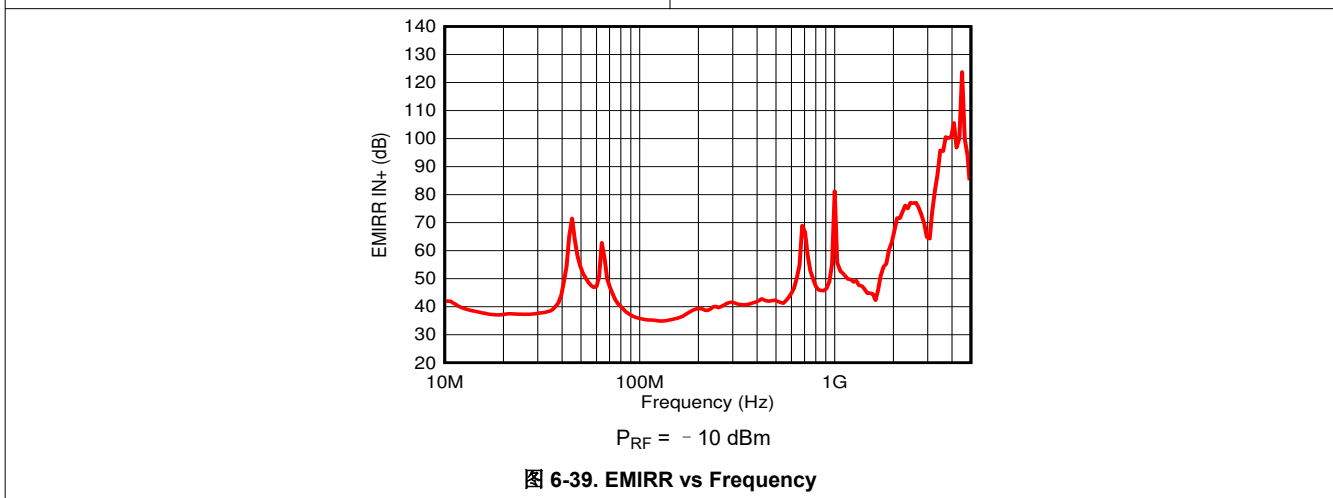
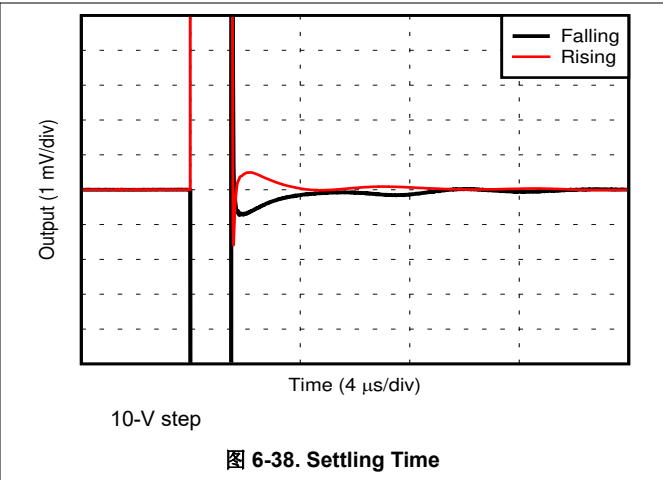
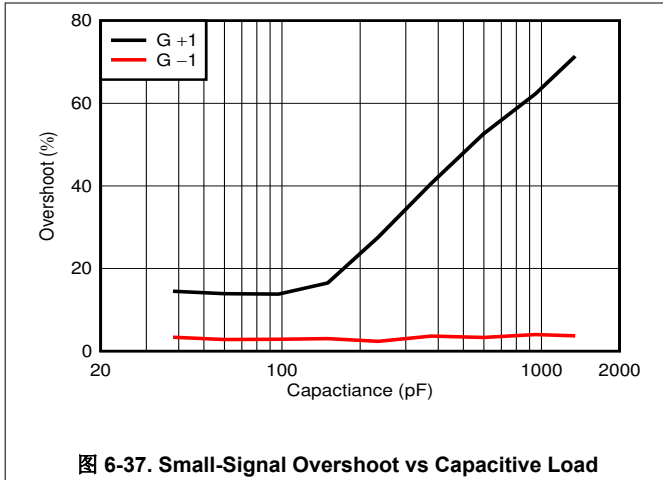

## 7 Detailed Description

### 7.1 Overview

The OPAX210 are the next generation of the OPAX209 operational amplifiers. The OPAX210 offer improved input offset voltage, offset voltage temperature drift, input bias current, and lower  $1/f$  noise corner frequency. In addition, these devices offer excellent overall performance with high CMRR, PSRR, and  $A_{OL}$ . The OPAX210 precision operational amplifiers are unity-gain stable, and free from unexpected output and phase reversal. Applications with noisy or high-impedance power supplies require decoupling capacitors placed close to the device pins. In most cases,  $0.1\text{-}\mu\text{F}$  capacitors are adequate. [# 7.2](#) shows a simplified schematic of the OPAX210. The die uses a SiGe bipolar process and contains 180 transistors.

### 7.2 Functional Block Diagram

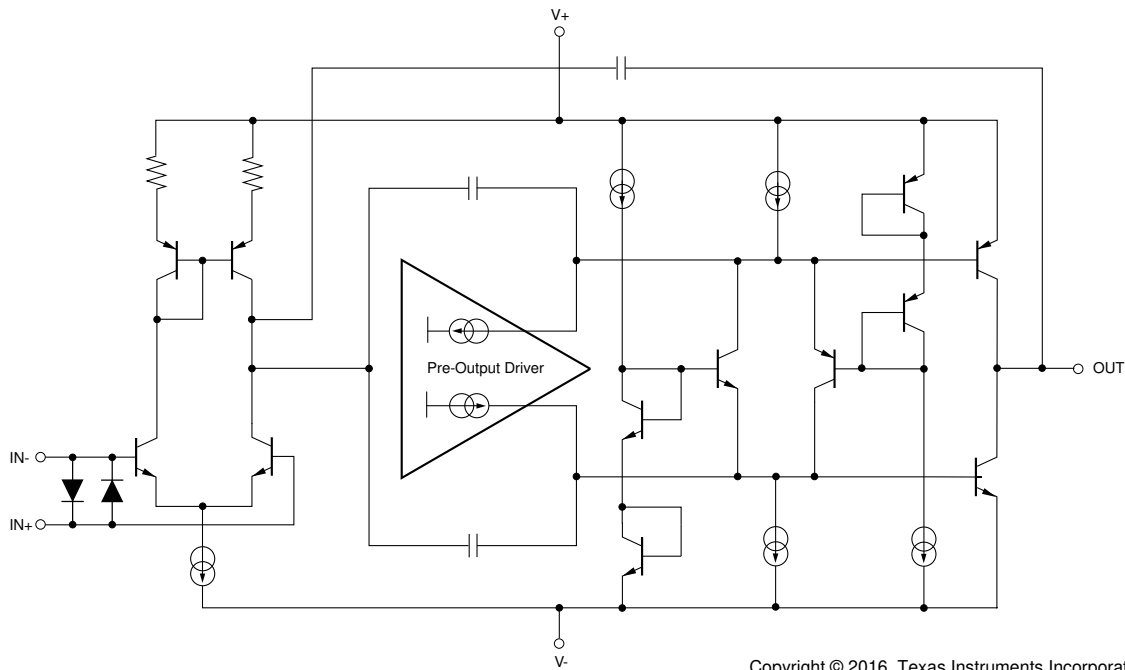

Copyright © 2016, Texas Instruments Incorporated

## 7.3 Feature Description

### 7.3.1 Operating Voltage

The OPAx210 op amps can be used with single or dual supplies within an operating range of  $V_S = 4.5\text{ V}$  ( $\pm 2.25\text{ V}$ ) up to  $36\text{ V}$  ( $\pm 18\text{ V}$ ).

#### CAUTION

Supply voltages greater than  $40\text{ V}$  total can permanently damage the device.

In addition, key parameters are specified over the temperature range of  $T_A = -40^\circ\text{C}$  to  $+125^\circ\text{C}$ . Parameters that vary significantly with operating voltage or temperature are shown in [§ 6.7](#).

### 7.3.2 Input Protection

The input pins of the OPAx210 are protected from excessive differential voltage with back-to-back diodes, as shown in [图 7-1](#). In most circuit applications, the input protection circuitry has no consequence. However, in low-gain or  $G = 1$  circuits, fast-ramping input signals can forward-bias these diodes because the output of the amplifier cannot respond rapidly enough to the input ramp. This effect is illustrated in [图 6-35](#) and [图 6-36](#) in [§ 6.7](#). If the input signal is fast enough to create this forward-bias condition, the input signal current must be limited to  $10\text{ mA}$  or less. If the input signal current is not inherently limited, an input series resistor can be used to limit the signal input current. This input series resistor degrades the low-noise performance of the OPAx210. See [§ 7.3.3](#) for further information on noise performance.

[图 7-1](#) shows an example configuration that implements a current-limiting feedback resistor.

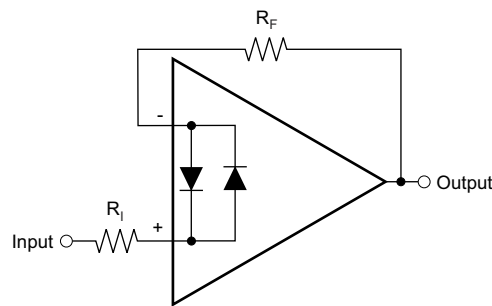

**图 7-1. Pulsed Operation**

### 7.3.3 Noise Performance

[图 7-2](#) shows the total circuit noise for varying source impedances with the op amp in a unity-gain configuration (no feedback resistor network, and therefore, no additional noise contributions). Two different op amps are shown with the total circuit noise calculated. The OPAx210 have very low voltage noise, making these devices a great choice for low source impedances (less than  $2\text{ k}\Omega$ ). As a comparable, precision FET-input op amp (very low current noise), the [OPA827](#) has somewhat higher voltage noise, but lower current noise. The device provides excellent noise performance at moderate to high source impedance ( $10\text{ k}\Omega$  and up). For source impedance lower than  $300\ \Omega$ , the [OPA211](#) may provide lower noise.

The equation in [图 7-2](#) shows the calculation of the total circuit noise, with these parameters:

- $e_n$  = voltage noise,
- $i_n$  = current noise,
- $R_S$  = source impedance,
- $k$  = Boltzmann's constant =  $1.38 \times 10^{-23}\text{ J/K}$ , and
- $T$  = temperature in kelvins

For more details on calculating noise, see [§ 8.1.1](#).



图 7-2. Noise Performance of the OPAx210 and OPA827 in Unity-Gain Buffer Configuration

### 7.3.4 Phase-Reversal Protection

The OPAx210 have internal phase-reversal protection. Many FET- and bipolar-input op amps exhibit a phase reversal when the input is driven beyond the linear common-mode range. This condition is most often encountered in noninverting circuits when the input is driven beyond the specified common-mode voltage range, causing the output to reverse into the opposite rail. The input circuitry of the OPAx210 prevents phase reversal with excessive common-mode voltage; instead, the output limits into the appropriate rail (see 图 6-30).

### 7.3.5 Electrical Overstress

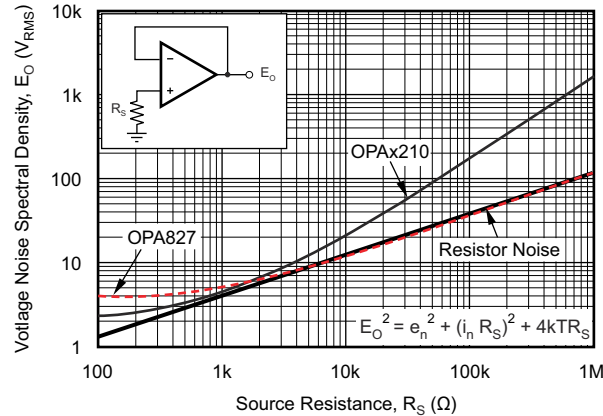
Designers often ask questions about the capability of an operational amplifier to withstand electrical overstress. These questions tend to focus on the device inputs, but may involve the supply voltage pins or even the output pin. Each of these different pin functions have electrical stress limits determined by the voltage breakdown characteristics of the particular semiconductor fabrication process and specific circuits connected to the pin. Additionally, internal electrostatic discharge (ESD) protection is built into these circuits to protect them from accidental ESD events both before and during product assembly.

It is helpful to have a good understanding of this basic ESD circuitry and its relevance to an electrical overstress event. See 图 7-3 for an illustration of the ESD circuits contained in the OPAx210 (indicated by the dashed line area). The ESD protection circuitry involves several current-steering diodes connected from the input and output pins and routed back to the internal power-supply lines, where they meet at an absorption device internal to the operational amplifier. This protection circuitry is intended to remain inactive during normal circuit operation.

An ESD event produces a short duration, high-voltage pulse that is transformed into a short duration, high-current pulse as it discharges through a semiconductor device. The ESD protection circuits are designed to provide a current path around the operational amplifier core to prevent it from being damaged. The energy absorbed by the protection circuitry is then dissipated as heat.

When an ESD voltage develops across two or more of the amplifier device pins, current flows through one or more of the steering diodes. Depending on the path that the current takes, the absorption device may activate. The absorption device has a trigger, or threshold voltage, that is greater than the normal operating voltage of the OPAx210 but less than the device breakdown voltage level. After this threshold is exceeded, the absorption device quickly activates and clamps the voltage across the supply rails to a safe level.

When the operational amplifier connects into a circuit such as the one 图 7-3 shows, the ESD protection components are intended to remain inactive and not become involved in the application circuit operation. However, circumstances may arise where an applied voltage exceeds the operating voltage range of a given pin. If this condition occur, there is a risk that some of the internal ESD protection circuits may be biased on, and conduct current. Any such current flow occurs through steering diode paths and rarely involves the absorption device.

图 7-3 depicts a specific example where the input voltage,  $V_{IN}$ , exceeds the positive supply voltage,  $+V_S$ , by 500 mV or more. Much of what happens in the circuit depends on the supply characteristics. If  $+V_S$  can sink the

current, one of the upper input steering diodes conducts and directs current to  $+V_S$ . Excessively high current levels can flow with increasingly higher  $V_{IN}$ . As a result, the data sheet specifications recommend that applications limit the input current to 10 mA.

If the supply is not capable of sinking the current,  $V_{IN}$  may begin sourcing current to the operational amplifier, and then take over as the source of positive supply voltage. The danger in this case is that the voltage can rise to levels that exceed the operational amplifier absolute maximum ratings.

Another common question involves what happens to the amplifier if an input signal is applied to the input while power supplies  $+V_S$ ,  $-V_S$ , or both are at 0 V.

Again, the answer depends on the supply characteristic while at 0 V, or at a level less than the input signal amplitude. If the supplies appear as high impedance, then the operational amplifier supply current may be supplied by the input source through the current steering diodes. This state is not a normal bias condition; the amplifier will not operate normally. If the supplies are low impedance, then the current through the steering diodes can become quite high. The current level depends on the ability of the input source to deliver current, and any resistance in the input path.

If there is an uncertainty about the ability of the supply to absorb this current, external transient voltage suppressor (TVS) diodes may be added to the supply pins as shown in [Figure 7-3](#). The breakdown voltage must be selected so that the diode does not turn on during normal operation. However, the breakdown voltage must be low enough so that the TVS diode conducts if the supply pin begins to rise to greater than the safe operating supply voltage level.

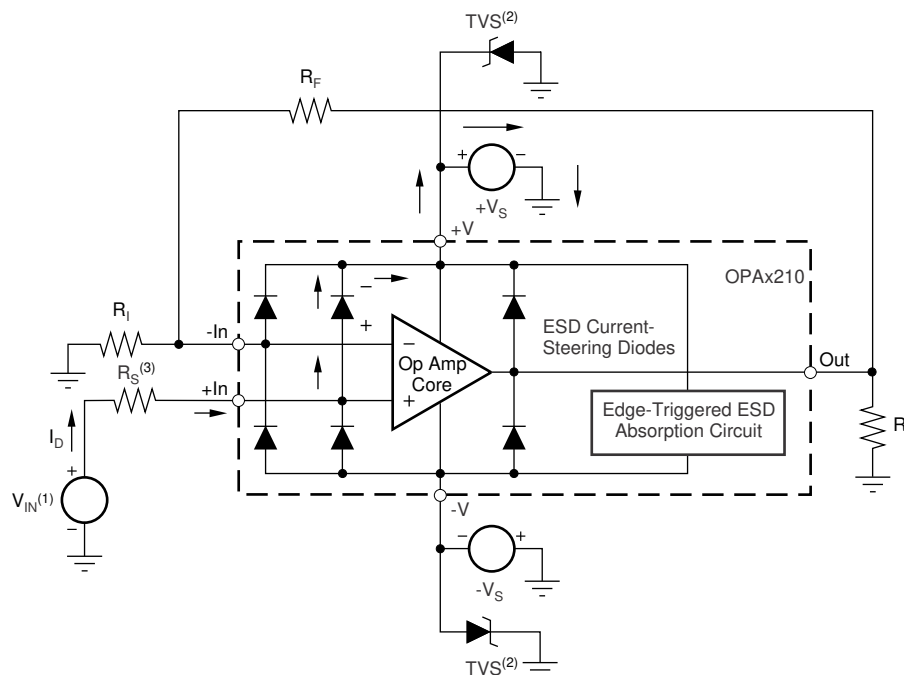

(1)  $V_{IN} = +V_S + 500 \text{ mV}$ .

(2) TVS:  $+V_{S(max)} > V_{TVSBR (Min)} > +V_S$ .

(3) Suggested value approximately  $1 \text{ k}\Omega$ .

**图 7-3. Equivalent Internal ESD Circuitry and Relation to a Typical Circuit Application**

## 7.4 Device Functional Modes

The OPAx210 are operational when the power-supply voltage is greater than 4.5 V ( $\pm 2.25 \text{ V}$ ). The maximum power-supply voltage for the OPAx210 is 36 V ( $\pm 18 \text{ V}$ ).

## 8 Application and Implementation

---

### Note

以下应用部分中的信息不属于 TI 器件规格的范围，TI 不担保其准确性和完整性。TI 的客户应负责确定器件是否适用于其应用。客户应验证并测试其设计，以确保系统功能。

---

### 8.1 Application Information

The OPAx210 are unity-gain stable, precision operational amplifiers with very low noise. Applications with noisy or high-impedance power supplies require decoupling capacitors close to the device pins. In most cases, 0.1- $\mu$ F capacitors are adequate.

#### 8.1.1 Basic Noise Calculations

Low-noise circuit design requires careful analysis of all noise sources. External noise sources can dominate in many cases; consider the effect of source resistance on overall op amp noise performance. Total noise of the circuit is the root-sum-square combination of all noise components.

The resistive portion of the source impedance produces thermal noise proportional to the square root of the resistance. This function is plotted in [图 7-2](#). The source impedance is usually fixed; consequently, select the op amp and the feedback resistors to minimize the respective contributions to the total noise.

[图 8-1](#) illustrates both noninverting (**A**) and inverting (**B**) op amp circuit configurations with gain. In circuit configurations with gain, the feedback network resistors also contribute noise. In general, the current noise of the op amp reacts with the feedback resistors to create additional noise components. However, the extremely low current noise of the OPAx210 means that the device current noise contribution can be neglected.

Generally, the feedback resistor values are chosen to make these noise sources negligible. Low impedance feedback resistors load the output of the amplifier. The equations for total noise are shown for both configurations.

**(A) Noise in Noninverting Gain Configuration**

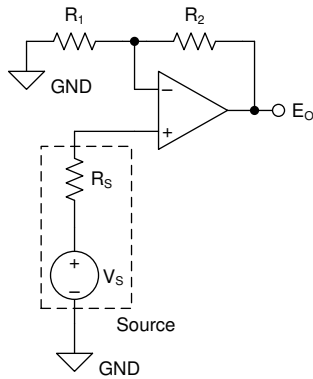

Noise at the output is given as  $E_O$ , where

$$(1) \quad E_O = \left(1 + \frac{R_2}{R_1}\right) \cdot \sqrt{(e_S)^2 + (e_N)^2 + (e_{R_1 \parallel R_2})^2 + (i_N \cdot R_S)^2 + \left(i_N \cdot \left[\frac{R_1 \cdot R_2}{R_1 + R_2}\right]\right)^2} \quad [V_{RMS}]$$

$$(2) \quad e_S = \sqrt{4 \cdot k_B \cdot T(K) \cdot R_S} \quad \left[\frac{V}{\sqrt{Hz}}\right] \quad \text{Thermal noise of } R_S$$

$$(3) \quad e_{R_1 \parallel R_2} = \sqrt{4 \cdot k_B \cdot T(K) \cdot \left[\frac{R_1 \cdot R_2}{R_1 + R_2}\right]} \quad \left[\frac{V}{\sqrt{Hz}}\right] \quad \text{Thermal noise of } R_1 \parallel R_2$$

$$(4) \quad k_B = 1.38065 \cdot 10^{-23} \quad \left[\frac{J}{K}\right] \quad \text{Boltzmann Constant}$$

$$(5) \quad T(K) = 237.15 + T(^{\circ}C) \quad [K] \quad \text{Temperature in kelvins}$$

**(B) Noise in Inverting Gain Configuration**

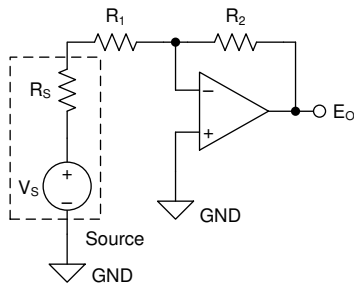

Noise at the output is given as  $E_O$ , where

$$(6) \quad E_O = \left(1 + \frac{R_2}{R_S + R_1}\right) \cdot \sqrt{(e_N)^2 + (e_{R_1 + R_S \parallel R_2})^2 + \left(i_N \cdot \left[\frac{(R_S + R_1) \cdot R_2}{R_S + R_1 + R_2}\right]\right)^2} \quad [V_{RMS}]$$

$$(7) \quad e_{R_1 + R_S \parallel R_2} = \sqrt{4 \cdot k_B \cdot T(K) \cdot \left[\frac{(R_S + R_1) \cdot R_2}{R_S + R_1 + R_2}\right]} \quad \left[\frac{V}{\sqrt{Hz}}\right] \quad \text{Thermal noise of } (R_1 + R_S) \parallel R_2$$

$$(8) \quad k_B = 1.38065 \cdot 10^{-23} \quad \left[\frac{J}{K}\right] \quad \text{Boltzmann Constant}$$

$$(9) \quad T(K) = 237.15 + T(^{\circ}C) \quad [K] \quad \text{Temperature in kelvins}$$

Copyright © 2017, Texas Instruments Incorporated

Where  $e_N$  is the voltage noise of the amplifier. For the OPAx210 op amp,  $e_N = 2.2 \text{ nV} / \sqrt{\text{Hz}}$  at 1 kHz.

Where  $i_N$  is the current noise of the amplifier. For the OPAx210 op amp,  $i_N = 400 \text{ fA} / \sqrt{\text{Hz}}$  at 1 kHz.

NOTE: For additional resources on noise calculations visit the [TI Precision Labs Series](#).

**图 8-1. Noise Calculation in Gain Configurations**

## 8.2 Typical Application



图 8-2. Low-Pass Filter

### 8.2.1 Design Requirements

Low-pass filters are commonly used in signal processing applications to reduce noise and prevent aliasing. The OPAx210 are designed to construct high-speed, high-precision active filters. 图 8-2 shows a second-order, low-pass filter commonly encountered in signal-processing applications.

Use the following parameters for this design example:

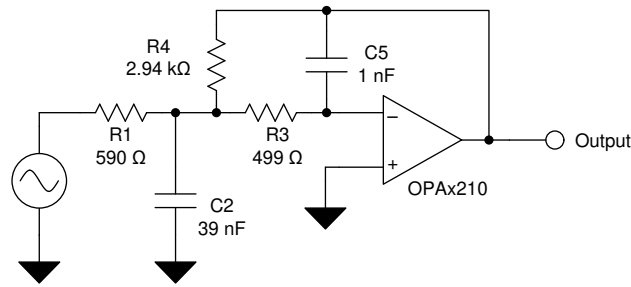
- Gain = 5 V/V (inverting gain)
- Low-pass cutoff frequency = 25 kHz
- Second-order Chebyshev filter response with 3-dB gain peaking in the pass band

### 8.2.2 Detailed Design Procedure

The infinite-gain, multiple-feedback circuit for a low-pass network function is shown in 图 8-2. Use 方程式 1 to calculate the voltage transfer function.

$$\frac{\text{Output}}{\text{Input}}(s) = \frac{-1/R_1 R_3 C_2 C_5}{s^2 + (s/C_2)(1/R_1 + 1/R_3 + 1/R_4) + 1/R_3 R_4 C_2 C_5} \quad (1)$$

This circuit produces a signal inversion. For this circuit, the gain at dc and the low-pass cutoff frequency are calculated by 方程式 2:

$$\text{Gain} = \frac{R_4}{R_1}$$

$$f_c = \frac{1}{2\pi} \sqrt{(1/R_3 R_4 C_2 C_5)} \quad (2)$$

### 8.2.3 Application Curve



图 8-3. OPAx210 Second-Order, 25-kHz, Chebyshev, Low-Pass Filter

## 8.3 System Example

### 8.3.1 Time Gain Control System for Ultrasound Applications

During an ultrasound send-receive cycle, the magnitude of reflected signal depends on the depth of penetration. The ultrasound signal incident on the receiver decreases in amplitude as a function of the time elapsed since transmission. The time gain control (TGC) system helps achieve the best possible signal-to-noise ratio (SNR), even with the decreasing signal amplitude. When the image is displayed, similar materials have similar brightness, regardless of depth. *Linear-in-dB* gain, which means the decibel gain is a linear function of the control voltage ( $V_{CNTL}$ ), is used to generate this image.

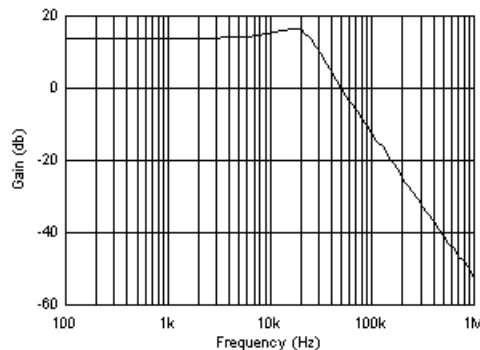
There are multiple approaches for a TGC control circuit that are based on the type of DAC. [Figure 8-4](#) shows a high-level block diagram for the topology using a current-output multiplying DAC (MDAC) to generate the drive for  $V_{CNTL}$ . The op amp used for current-to-voltage (I-to-V) conversion must have low-voltage noise, as well as low-current noise density. The current density helps reduce the overall noise performance because of the DAC output configuration. The DAC output can go up to  $\pm 10$  V; therefore, the op amp must have bipolar operation. The OPAx210 is used here because of the low-voltage noise density of  $2.2 \text{ nV}/\sqrt{\text{Hz}}$ , low-current noise density of  $500 \text{ fA}/\sqrt{\text{Hz}}$ , rail-to-rail output, and the ability to accept a wide supply range of  $\pm 2.25$  V to  $\pm 18$  V and provide rail-to-rail output. The low offset voltage and offset drift of the OPAx210 facilitate excellent dc accuracy for the circuit.

The OPAx210 is used to filter and buffer the 10-V reference voltage generated by the [REF5010](#). The REF5010 serves as the reference voltage for the [DAC8802](#), which generates a current output on  $I_{OUT}$  corresponding to the digital input code. The  $I_{OUT}$  pin of the DAC8802 is connected to the virtual ground (negative terminal) of the OPAx210; the feedback resistor ( $R_{FB}$  is internal to the DAC8802) is connected to the output of the OPAx210, and results in a current-to-voltage conversion. The output of the OPAx210 has a range of  $-10$  V to  $0$  V, which is fed to the [THS4130](#) configured as a Sallen-Key filter. Finally, the 10-V range is attenuated down to a 1.5-V range, with a common-mode voltage of  $0.75$  V using a resistive attenuator. See the [2.3-nV/ \$\sqrt{\text{Hz}}\$ , Differential, Time Gain Control DAC Reference Design for Ultrasound](#) for an in-depth analysis of [Figure 8-4](#).

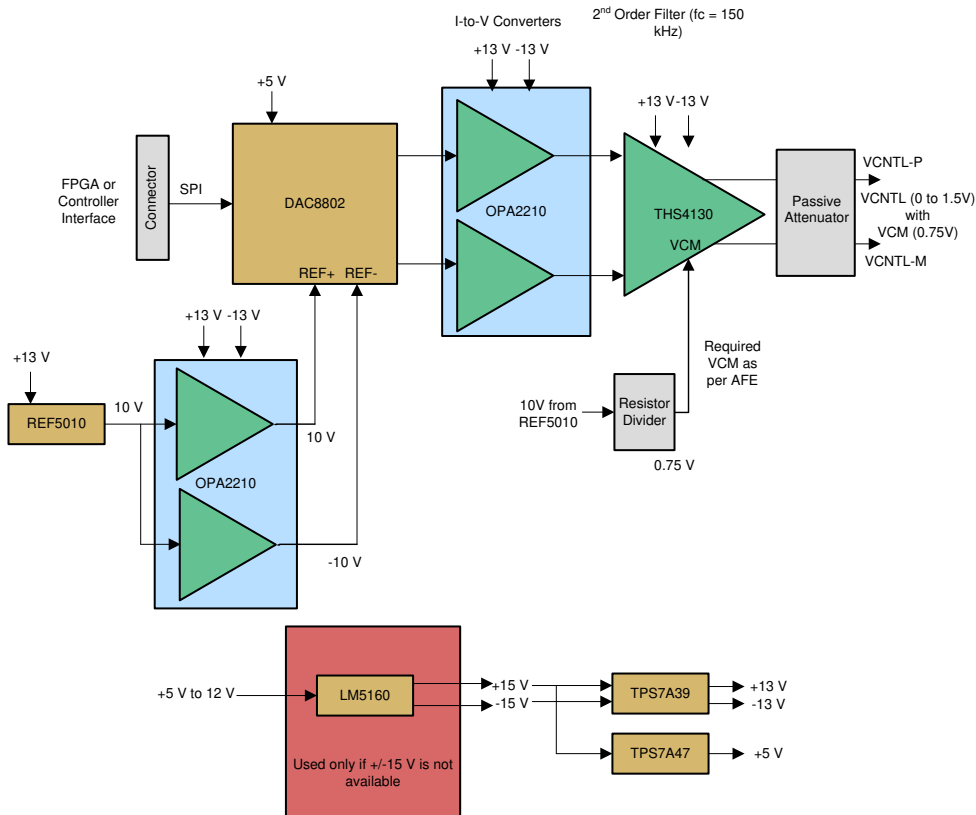

**图 8-4. Block Diagram for Time Gain Control System for Ultrasound**

## 9 Power Supply Recommendations

The OPAx210 are specified for operation from 4.5 V to 36 V ( $\pm 2.25$  V to  $\pm 18$  V); many specifications apply from  $-40^{\circ}\text{C}$  to  $+125^{\circ}\text{C}$ . Parameters that can exhibit significant variance with regard to operating voltage or temperature are presented in #6.7.

## 10 Layout

### 10.1 Layout Guidelines

For best operational performance of the device, use good printed circuit board (PCB) layout practices, including the following guidelines:

- Noise from the amplifier can propagate into other analog circuits through the power pins of the amplifiers. Use bypass capacitors to reduce the coupled noise by providing low-impedance power sources local to the analog circuitry.
- Connect low-ESR, 0.1- $\mu\text{F}$  ceramic bypass capacitors between each supply pin and ground, placed as close to the device as possible. A single bypass capacitor from V+ to ground is applicable for single-supply applications.
- Separate grounding for analog and digital portions of circuitry is one of the simplest and most-effective methods of noise suppression. One or more layers on multilayer PCBs are usually devoted to ground planes. A ground plane helps distribute heat and reduces EMI noise pickup. Make sure to physically separate digital and analog grounds paying attention to the flow of the ground current.
- To reduce parasitic coupling, run the input traces as far away from the supply or output traces as possible. If these traces cannot be kept separate, crossing the sensitive trace perpendicular is much better than running in parallel with the noisy trace.
- Place the external components as close to the device as possible.
- Keep the length of input traces as short as possible. Always remember that the input traces are the most sensitive part of the circuit.
- Consider a driven, low-impedance guard ring around the critical traces. A guard ring can significantly reduce leakage currents from nearby traces that are at different potentials.
- For best performance, clean the PCB following board assembly.
- Any precision integrated circuit may experience performance shifts due to moisture ingress into the plastic package. Following any aqueous PCB cleaning process, bake the PCB to remove moisture introduced into the device packaging during the cleaning process. A low-temperature, post-cleaning bake at  $85^{\circ}\text{C}$  for 30 minutes is sufficient for most circumstances.

### 10.2 Layout Example



图 10-1. OPA2210 Layout Example

## 11 Device and Documentation Support

### 11.1 Device Support

#### 11.1.1 Development Support

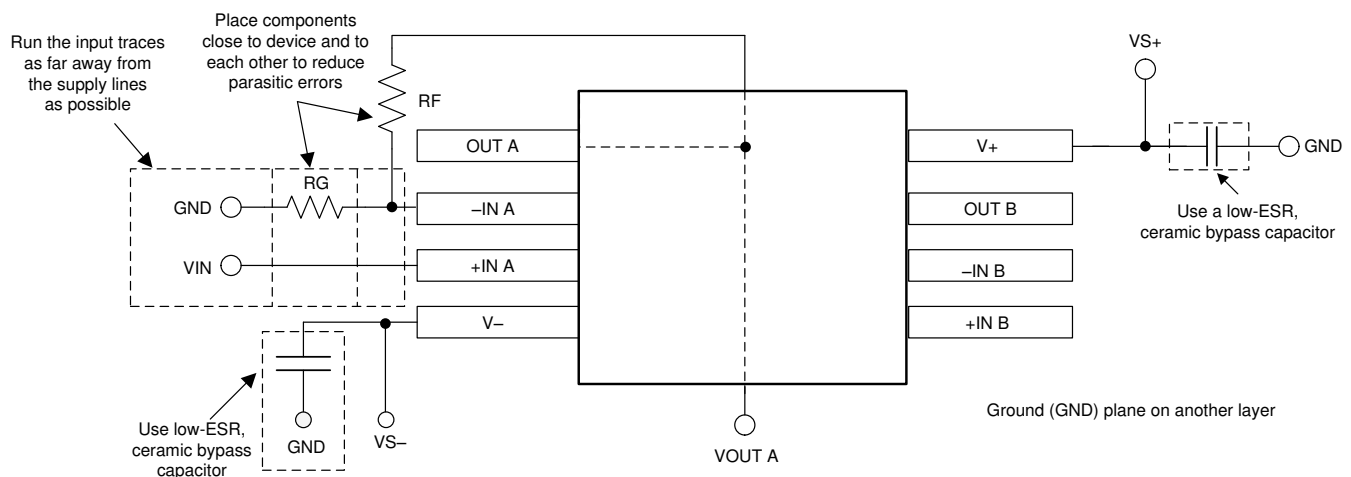
##### 11.1.1.1 TINA-TI™ Simulation Software (Free Download)

TINA™ is a simple, powerful, and easy-to-use circuit simulation program based on a SPICE engine. TINA-TI™ simulation software is a free, fully-functional version of the TINA software, preloaded with a library of macro models in addition to a range of both passive and active models. TINA-TI simulation software provides all the conventional dc, transient, and frequency domain analysis of SPICE, as well as additional design capabilities.

Available as a [free download](#) from the Analog eLab Design Center, TINA-TI simulation software offers extensive post-processing capability that allows users to format results in a variety of ways. Virtual instruments offer the ability to select input waveforms and probe circuit nodes, voltages, and waveforms, creating a dynamic quick-start tool.

---

#### Note

These files require that either the TINA software or TINA-TI software be installed. Download the free TINA-TI software from the [TINA-TI software folder](#).

---

##### 11.1.1.2 DIP Adapter EVM

The [DIP Adapter EVM](#) tool provides an easy, low-cost way to prototype small, surface-mount integrated circuits (ICs). The EVM includes footprint options for the following TI packages:

- D or U (SOIC-8)
- PW (TSSOP-8)
- DGK (VSSOP-8)
- DBV (SOT23-6, SOT23-5 and SOT23-3)
- DCK (SC70-6 and SC70-5)
- DRL (SOT563-6)

The DIP Adapter EVM may also be used with terminal strips or may be wired directly to existing circuits.

##### 11.1.1.3 Universal Operational Amplifier EVM

The [Universal Op Amp evaluation module \(EVM\)](#) is a series of general-purpose, blank circuit boards that simplify prototyping circuits for a variety of IC package types. The EVM board design allows many different circuits to be constructed easily and quickly. Five models are offered, with each model intended for a specific package type. The PDIP, SOIC, VSSOP, TSSOP, and SOT-23 packages are all supported.

---

#### Note

These boards are unpopulated, so users must provide their own ICs. TI recommends requesting several op amp device samples when ordering the Universal Op Amp EVM.

---

##### 11.1.1.4 TI Precision Designs

[TI Precision Designs](#) are analog solutions created by TI's precision analog applications experts. These designs offer the theory of operation, component selection, simulation, complete PCB schematic and layout, bill of materials, and measured performance of many useful circuits.

##### 11.1.1.5 WEBENCH® Filter Designer

The [WEBENCH® Filter Designer](#) is a simple, powerful, and easy-to-use active filter design program. The WEBENCH® Filter Designer lets you create optimized filter designs using a selection of TI operational amplifiers and passive components from TI's vendor partners.

Available as a web-based tool from the WEBENCH® Design Center, the WEBENCH® Filter Designer allows you to design, optimize, and simulate complete multistage active filter solutions within minutes.

## 11.2 Documentation Support

### 11.2.1 Related Documentation

The following documents are relevant to using the OPAx210 and recommended for reference. All are available for download at [www.ti.com](http://www.ti.com) (unless otherwise noted):

- Texas Instruments, [OPA827 Low-Noise, High-Precision, JFET-Input Operational Amplifier data sheet](#)
- Texas Instruments, [OPA2x11 1.1-nV/√Hz Noise, Low-Power, Precision Operational Amplifier data sheet](#)
- Texas Instruments, [OPA210, OPA2210, OPA4210 EMI Immunity Performance technical brief](#)
- Texas Instruments, [OPAx209 2.2-nV/√Hz, Low-Power, 36-V Operational Amplifier data sheet](#)
- Texas Instruments, [Microcontroller PWM to 12-Bit Analog Out design guide](#)
- Texas Instruments, [Capacitive Load Drive Solution Using an Isolation Resistor design guide](#)
- Texas Instruments, [Noise Measurement Post Amp design guide](#)

### 11.3 接收文档更新通知

要接收文档更新通知，请导航至 [ti.com](http://ti.com) 上的器件产品文件夹。点击 [订阅更新](#) 进行注册，即可每周接收产品信息更改摘要。有关更改的详细信息，请查看任何已修订文档中包含的修订历史记录。

### 11.4 支持资源

[TI E2E™ 支持论坛](#) 是工程师的重要参考资料，可直接从专家获得快速、经过验证的解答和设计帮助。搜索现有解答或提出自己的问题可获得所需的快速设计帮助。

链接的内容由各个贡献者“按原样”提供。这些内容并不构成 TI 技术规范，并且不一定反映 TI 的观点；请参阅 TI 的《[使用条款](#)》。

### 11.5 Trademarks

TINA™ is a trademark of DesignSoft, Inc.

TINA-TI™ and TI E2E™ are trademarks of Texas Instruments.

WEBENCH® is a registered trademark of Texas Instruments.

所有商标均为其各自所有者的财产。

### 11.6 Electrostatic Discharge Caution



This integrated circuit can be damaged by ESD. Texas Instruments recommends that all integrated circuits be handled with appropriate precautions. Failure to observe proper handling and installation procedures can cause damage.

ESD damage can range from subtle performance degradation to complete device failure. Precision integrated circuits may be more susceptible to damage because very small parametric changes could cause the device not to meet its published specifications.

### 11.7 术语表

[TI 术语表](#) 本术语表列出并解释了术语、首字母缩略词和定义。

## 12 Mechanical, Packaging, and Orderable Information

The following pages include mechanical, packaging, and orderable information. This information is the most current data available for the designated devices. This data is subject to change without notice and revision of this document. For browser-based versions of this data sheet, refer to the left-hand navigation.

## 重要声明和免责声明

TI 提供技术和可靠性数据 (包括数据表)、设计资源 (包括参考设计)、应用或其他设计建议、网络工具、安全信息和其他资源, 不保证没有瑕疵且不做任何明示或暗示的担保, 包括但不限于对适销性、某特定用途方面的适用性或不侵犯任何第三方知识产权的暗示担保。

这些资源可供使用 TI 产品进行设计的熟练开发人员使用。您将自行承担以下全部责任: (1) 针对您的应用选择合适的 TI 产品, (2) 设计、验证并测试您的应用, (3) 确保您的应用满足相应标准以及任何其他安全、安保或其他要求。这些资源如有变更, 恕不另行通知。TI 授权您仅可将这些资源用于研发本资源所述的 TI 产品的应用。严禁对这些资源进行其他复制或展示。您无权使用任何其他 TI 知识产权或任何第三方知识产权。您应全额赔偿因在这些资源的使用中对 TI 及其代表造成的任何索赔、损害、成本、损失和债务, TI 对此概不负责。

TI 提供的产品受 TI 的销售条款 (<https://www.ti.com/legal/termsofsale.html>) 或 [ti.com](https://www.ti.com) 上其他适用条款/TI 产品随附的其他适用条款的约束。TI 提供这些资源并不会扩展或以其他方式更改 TI 针对 TI 产品发布的适用的担保或担保免责声明。

邮寄地址: Texas Instruments, Post Office Box 655303, Dallas, Texas 75265

Copyright © 2021, 德州仪器 (TI) 公司

**PACKAGING INFORMATION**

| Orderable part number        | Status<br>(1) | Material type<br>(2) | Package   Pins   | Package qty   Carrier | RoHS<br>(3) | Lead finish/<br>Ball material<br>(4) | MSL rating/<br>Peak reflow<br>(5) | Op temp (°C) | Part marking<br>(6) |
|------------------------------|---------------|----------------------|------------------|-----------------------|-------------|--------------------------------------|-----------------------------------|--------------|---------------------|
| <a href="#">OPA210IDBVR</a>  | Active        | Production           | SOT-23 (DBV)   5 | 3000   LARGE T&R      | Yes         | NIPDAU                               | Level-2-260C-1 YEAR               | -40 to 125   | 26T2                |
| OPA210IDBVR.B                | Active        | Production           | SOT-23 (DBV)   5 | 3000   LARGE T&R      | Yes         | NIPDAU                               | Level-2-260C-1 YEAR               | -40 to 125   | 26T2                |
| <a href="#">OPA210IDBVT</a>  | Active        | Production           | SOT-23 (DBV)   5 | 250   SMALL T&R       | Yes         | NIPDAU                               | Level-2-260C-1 YEAR               | -40 to 125   | 26T2                |
| OPA210IDBVT.B                | Active        | Production           | SOT-23 (DBV)   5 | 250   SMALL T&R       | Yes         | NIPDAU                               | Level-2-260C-1 YEAR               | -40 to 125   | 26T2                |
| OPA210IDBVTG4                | Active        | Production           | SOT-23 (DBV)   5 | 250   SMALL T&R       | Yes         | NIPDAU                               | Level-2-260C-1 YEAR               | -40 to 125   | 26T2                |
| OPA210IDBVTG4.B              | Active        | Production           | SOT-23 (DBV)   5 | 250   SMALL T&R       | Yes         | NIPDAU                               | Level-2-260C-1 YEAR               | -40 to 125   | 26T2                |
| <a href="#">OPA210IDGKR</a>  | Active        | Production           | VSSOP (DGK)   8  | 2500   LARGE T&R      | Yes         | NIPDAU                               | Level-2-260C-1 YEAR               | -40 to 125   | 2D5J                |
| OPA210IDGKR.B                | Active        | Production           | VSSOP (DGK)   8  | 2500   LARGE T&R      | Yes         | NIPDAU                               | Level-2-260C-1 YEAR               | -40 to 125   | 2D5J                |
| OPA210IDGKRG4                | Active        | Production           | VSSOP (DGK)   8  | 2500   LARGE T&R      | Yes         | NIPDAU                               | Level-2-260C-1 YEAR               | -40 to 125   | 2D5J                |
| OPA210IDGKRG4.B              | Active        | Production           | VSSOP (DGK)   8  | 2500   LARGE T&R      | Yes         | NIPDAU                               | Level-2-260C-1 YEAR               | -40 to 125   | 2D5J                |
| <a href="#">OPA210IDGKT</a>  | Active        | Production           | VSSOP (DGK)   8  | 250   SMALL T&R       | Yes         | NIPDAU                               | Level-2-260C-1 YEAR               | -40 to 125   | 2D5J                |
| OPA210IDGKT.B                | Active        | Production           | VSSOP (DGK)   8  | 250   SMALL T&R       | Yes         | NIPDAU                               | Level-2-260C-1 YEAR               | -40 to 125   | 2D5J                |
| <a href="#">OPA210IDR</a>    | Active        | Production           | SOIC (D)   8     | 3000   LARGE T&R      | Yes         | NIPDAU                               | Level-2-260C-1 YEAR               | -40 to 125   | OPA210              |
| OPA210IDR.B                  | Active        | Production           | SOIC (D)   8     | 3000   LARGE T&R      | Yes         | NIPDAU                               | Level-2-260C-1 YEAR               | -40 to 125   | OPA210              |
| <a href="#">OPA210IDT</a>    | Active        | Production           | SOIC (D)   8     | 250   SMALL T&R       | Yes         | NIPDAU                               | Level-2-260C-1 YEAR               | -40 to 125   | OPA210              |
| OPA210IDT.B                  | Active        | Production           | SOIC (D)   8     | 250   SMALL T&R       | Yes         | NIPDAU                               | Level-2-260C-1 YEAR               | -40 to 125   | OPA210              |
| <a href="#">OPA2210ID</a>    | Active        | Production           | SOIC (D)   8     | 75   TUBE             | Yes         | NIPDAU                               | Level-2-260C-1 YEAR               | -40 to 125   | OP2210              |
| OPA2210ID.B                  | Active        | Production           | SOIC (D)   8     | 75   TUBE             | Yes         | NIPDAU                               | Level-2-260C-1 YEAR               | -40 to 125   | OP2210              |
| OPA2210IDG4                  | Active        | Production           | SOIC (D)   8     | 75   TUBE             | Yes         | NIPDAU                               | Level-2-260C-1 YEAR               | -40 to 125   | OP2210              |
| OPA2210IDG4.B                | Active        | Production           | SOIC (D)   8     | 75   TUBE             | Yes         | NIPDAU                               | Level-2-260C-1 YEAR               | -40 to 125   | OP2210              |
| <a href="#">OPA2210IDGKR</a> | Active        | Production           | VSSOP (DGK)   8  | 2500   LARGE T&R      | Yes         | NIPDAU   SN<br>  NIPDAUAG            | Level-2-260C-1 YEAR               | -40 to 125   | 1OHQ                |
| OPA2210IDGKR.B               | Active        | Production           | VSSOP (DGK)   8  | 2500   LARGE T&R      | Yes         | NIPDAU                               | Level-2-260C-1 YEAR               | -40 to 125   | 1OHQ                |
| <a href="#">OPA2210IDGKT</a> | Active        | Production           | VSSOP (DGK)   8  | 250   SMALL T&R       | Yes         | NIPDAU   SN<br>  NIPDAUAG            | Level-2-260C-1 YEAR               | -40 to 125   | 1OHQ                |
| OPA2210IDGKT.B               | Active        | Production           | VSSOP (DGK)   8  | 250   SMALL T&R       | Yes         | NIPDAU                               | Level-2-260C-1 YEAR               | -40 to 125   | 1OHQ                |
| <a href="#">OPA2210IDR</a>   | Active        | Production           | SOIC (D)   8     | 2500   LARGE T&R      | Yes         | NIPDAU                               | Level-2-260C-1 YEAR               | -40 to 125   | OP2210              |
| OPA2210IDR.B                 | Active        | Production           | SOIC (D)   8     | 2500   LARGE T&R      | Yes         | NIPDAU                               | Level-2-260C-1 YEAR               | -40 to 125   | OP2210              |
| <a href="#">OPA2210IDRGR</a> | Active        | Production           | SON (DRG)   8    | 3000   LARGE T&R      | Yes         | NIPDAU                               | Level-1-260C-UNLIM                | -40 to 125   | O2210               |
| OPA2210IDRGR.B               | Active        | Production           | SON (DRG)   8    | 3000   LARGE T&R      | Yes         | NIPDAU                               | Level-1-260C-UNLIM                | -40 to 125   | O2210               |

| Orderable part number        | Status<br>(1) | Material type<br>(2) | Package   Pins | Package qty   Carrier | RoHS<br>(3) | Lead finish/<br>Ball material<br>(4) | MSL rating/<br>Peak reflow<br>(5) | Op temp (°C) | Part marking<br>(6) |
|------------------------------|---------------|----------------------|----------------|-----------------------|-------------|--------------------------------------|-----------------------------------|--------------|---------------------|
| <a href="#">OPA2210IDRGT</a> | Active        | Production           | SON (DRG)   8  | 250   SMALL T&R       | Yes         | NIPDAU                               | Level-1-260C-UNLIM                | -40 to 125   | O2210               |
| OPA2210IDRGT.B               | Active        | Production           | SON (DRG)   8  | 250   SMALL T&R       | Yes         | NIPDAU                               | Level-1-260C-UNLIM                | -40 to 125   | O2210               |

**(1) Status:** For more details on status, see our [product life cycle](#).

**(2) Material type:** When designated, preproduction parts are prototypes/experimental devices, and are not yet approved or released for full production. Testing and final process, including without limitation quality assurance, reliability performance testing, and/or process qualification, may not yet be complete, and this item is subject to further changes or possible discontinuation. If available for ordering, purchases will be subject to an additional waiver at checkout, and are intended for early internal evaluation purposes only. These items are sold without warranties of any kind.

**(3) RoHS values:** Yes, No, RoHS Exempt. See the [TI RoHS Statement](#) for additional information and value definition.

**(4) Lead finish/Ball material:** Parts may have multiple material finish options. Finish options are separated by a vertical ruled line. Lead finish/Ball material values may wrap to two lines if the finish value exceeds the maximum column width.

**(5) MSL rating/Peak reflow:** The moisture sensitivity level ratings and peak solder (reflow) temperatures. In the event that a part has multiple moisture sensitivity ratings, only the lowest level per JEDEC standards is shown. Refer to the shipping label for the actual reflow temperature that will be used to mount the part to the printed circuit board.

**(6) Part marking:** There may be an additional marking, which relates to the logo, the lot trace code information, or the environmental category of the part.

Multiple part markings will be inside parentheses. Only one part marking contained in parentheses and separated by a "-" will appear on a part. If a line is indented then it is a continuation of the previous line and the two combined represent the entire part marking for that device.

**Important Information and Disclaimer:** The information provided on this page represents TI's knowledge and belief as of the date that it is provided. TI bases its knowledge and belief on information provided by third parties, and makes no representation or warranty as to the accuracy of such information. Efforts are underway to better integrate information from third parties. TI has taken and continues to take reasonable steps to provide representative and accurate information but may not have conducted destructive testing or chemical analysis on incoming materials and chemicals. TI and TI suppliers consider certain information to be proprietary, and thus CAS numbers and other limited information may not be available for release.

In no event shall TI's liability arising out of such information exceed the total purchase price of the TI part(s) at issue in this document sold by TI to Customer on an annual basis.

**TAPE AND REEL INFORMATION**

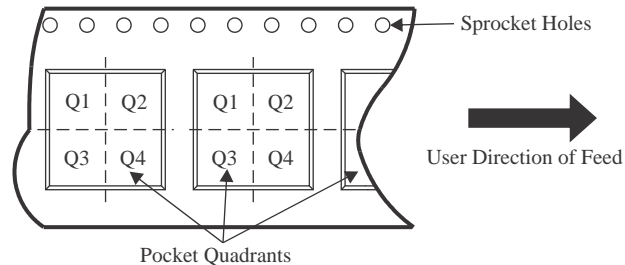
**QUADRANT ASSIGNMENTS FOR PIN 1 ORIENTATION IN TAPE**

\*All dimensions are nominal

| Device        | Package Type | Package Drawing | Pins | SPQ  | Reel Diameter (mm) | Reel Width W1 (mm) | A0 (mm) | B0 (mm) | K0 (mm) | P1 (mm) | W (mm) | Pin1 Quadrant |
|---------------|--------------|-----------------|------|------|--------------------|--------------------|---------|---------|---------|---------|--------|---------------|
| OPA210IDBVR   | SOT-23       | DBV             | 5    | 3000 | 180.0              | 8.4                | 3.23    | 3.17    | 1.37    | 4.0     | 8.0    | Q3            |
| OPA210IDBVT   | SOT-23       | DBV             | 5    | 250  | 180.0              | 8.4                | 3.23    | 3.17    | 1.37    | 4.0     | 8.0    | Q3            |
| OPA210IDBVTG4 | SOT-23       | DBV             | 5    | 250  | 180.0              | 8.4                | 3.23    | 3.17    | 1.37    | 4.0     | 8.0    | Q3            |
| OPA210IDGKR   | VSSOP        | DGK             | 8    | 2500 | 330.0              | 12.4               | 5.3     | 3.4     | 1.4     | 8.0     | 12.0   | Q1            |
| OPA210IDGKRG4 | VSSOP        | DGK             | 8    | 2500 | 330.0              | 12.4               | 5.3     | 3.4     | 1.4     | 8.0     | 12.0   | Q1            |
| OPA210IDGKT   | VSSOP        | DGK             | 8    | 250  | 180.0              | 12.4               | 5.3     | 3.4     | 1.4     | 8.0     | 12.0   | Q1            |
| OPA210IDR     | SOIC         | D               | 8    | 3000 | 330.0              | 12.4               | 6.4     | 5.2     | 2.1     | 8.0     | 12.0   | Q1            |
| OPA2210IDGKR  | VSSOP        | DGK             | 8    | 2500 | 330.0              | 12.4               | 5.25    | 3.35    | 1.25    | 8.0     | 12.0   | Q1            |
| OPA2210IDGKT  | VSSOP        | DGK             | 8    | 250  | 330.0              | 12.4               | 5.25    | 3.35    | 1.25    | 8.0     | 12.0   | Q1            |
| OPA2210IDR    | SOIC         | D               | 8    | 2500 | 330.0              | 12.4               | 6.4     | 5.2     | 2.1     | 8.0     | 12.0   | Q1            |
| OPA2210IDRGR  | SON          | DRG             | 8    | 3000 | 330.0              | 12.4               | 3.3     | 3.3     | 1.1     | 8.0     | 12.0   | Q2            |
| OPA2210IDRGT  | SON          | DRG             | 8    | 250  | 180.0              | 12.4               | 3.3     | 3.3     | 1.1     | 8.0     | 12.0   | Q2            |

**TAPE AND REEL BOX DIMENSIONS**

\*All dimensions are nominal

| Device        | Package Type | Package Drawing | Pins | SPQ  | Length (mm) | Width (mm) | Height (mm) |
|---------------|--------------|-----------------|------|------|-------------|------------|-------------|
| OPA210IDBVR   | SOT-23       | DBV             | 5    | 3000 | 213.0       | 191.0      | 35.0        |
| OPA210IDBVT   | SOT-23       | DBV             | 5    | 250  | 213.0       | 191.0      | 35.0        |
| OPA210IDBVTG4 | SOT-23       | DBV             | 5    | 250  | 213.0       | 191.0      | 35.0        |
| OPA210IDGKR   | VSSOP        | DGK             | 8    | 2500 | 353.0       | 353.0      | 32.0        |
| OPA210IDGKRG4 | VSSOP        | DGK             | 8    | 2500 | 353.0       | 353.0      | 32.0        |
| OPA210IDGKT   | VSSOP        | DGK             | 8    | 250  | 213.0       | 191.0      | 35.0        |
| OPA210IDR     | SOIC         | D               | 8    | 3000 | 353.0       | 353.0      | 32.0        |
| OPA2210IDGKR  | VSSOP        | DGK             | 8    | 2500 | 366.0       | 364.0      | 50.0        |
| OPA2210IDGKT  | VSSOP        | DGK             | 8    | 250  | 366.0       | 364.0      | 50.0        |
| OPA2210IDR    | SOIC         | D               | 8    | 2500 | 353.0       | 353.0      | 32.0        |
| OPA2210IDRGR  | SON          | DRG             | 8    | 3000 | 367.0       | 367.0      | 35.0        |
| OPA2210IDRGT  | SON          | DRG             | 8    | 250  | 210.0       | 185.0      | 35.0        |

**TUBE**

\*All dimensions are nominal

| Device        | Package Name | Package Type | Pins | SPQ | L (mm) | W (mm) | T (μm) | B (mm) |
|---------------|--------------|--------------|------|-----|--------|--------|--------|--------|
| OPA2210ID     | D            | SOIC         | 8    | 75  | 506.6  | 8      | 3940   | 4.32   |
| OPA2210ID.B   | D            | SOIC         | 8    | 75  | 506.6  | 8      | 3940   | 4.32   |
| OPA2210IDG4   | D            | SOIC         | 8    | 75  | 506.6  | 8      | 3940   | 4.32   |
| OPA2210IDG4.B | D            | SOIC         | 8    | 75  | 506.6  | 8      | 3940   | 4.32   |



# EXAMPLE BOARD LAYOUT

DBV0005A

SOT-23 - 1.45 mm max height

SMALL OUTLINE TRANSISTOR



LAND PATTERN EXAMPLE  
EXPOSED METAL SHOWN  
SCALE:15X

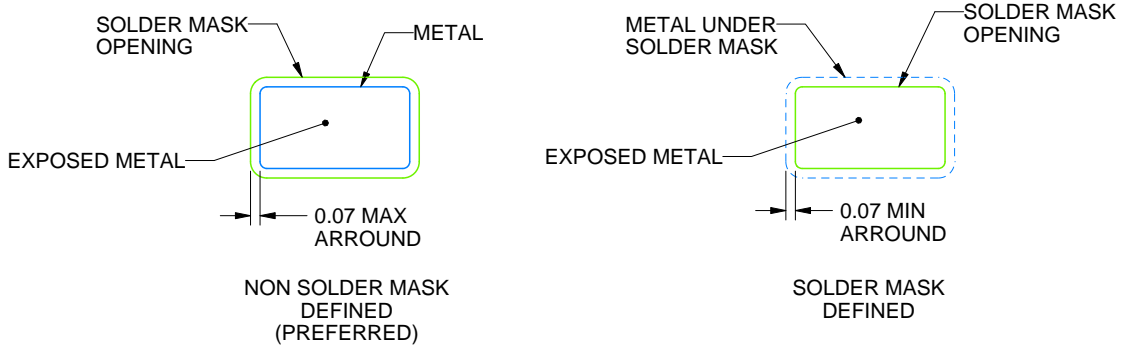

SOLDER MASK DETAILS

4214839/K 08/2024

NOTES: (continued)

- 6. Publication IPC-7351 may have alternate designs.
- 7. Solder mask tolerances between and around signal pads can vary based on board fabrication site.

# EXAMPLE STENCIL DESIGN

DBV0005A

SOT-23 - 1.45 mm max height

SMALL OUTLINE TRANSISTOR



SOLDER PASTE EXAMPLE  
BASED ON 0.125 mm THICK STENCIL  
SCALE:15X

4214839/K 08/2024

NOTES: (continued)

8. Laser cutting apertures with trapezoidal walls and rounded corners may offer better paste release. IPC-7525 may have alternate design recommendations.
9. Board assembly site may have different recommendations for stencil design.

# DGK0008A



# PACKAGE OUTLINE

VSSOP - 1.1 mm max height

SMALL OUTLINE PACKAGE



**NOTES:**

PowerPAD is a trademark of Texas Instruments.

1. All linear dimensions are in millimeters. Any dimensions in parenthesis are for reference only. Dimensioning and tolerancing per ASME Y14.5M.
2. This drawing is subject to change without notice.
3. This dimension does not include mold flash, protrusions, or gate burrs. Mold flash, protrusions, or gate burrs shall not exceed 0.15 mm per side.
4. This dimension does not include interlead flash. Interlead flash shall not exceed 0.25 mm per side.
5. Reference JEDEC registration MO-187.

# EXAMPLE BOARD LAYOUT

DGK0008A

™ VSSOP - 1.1 mm max height

SMALL OUTLINE PACKAGE



LAND PATTERN EXAMPLE  
EXPOSED METAL SHOWN  
SCALE: 15X

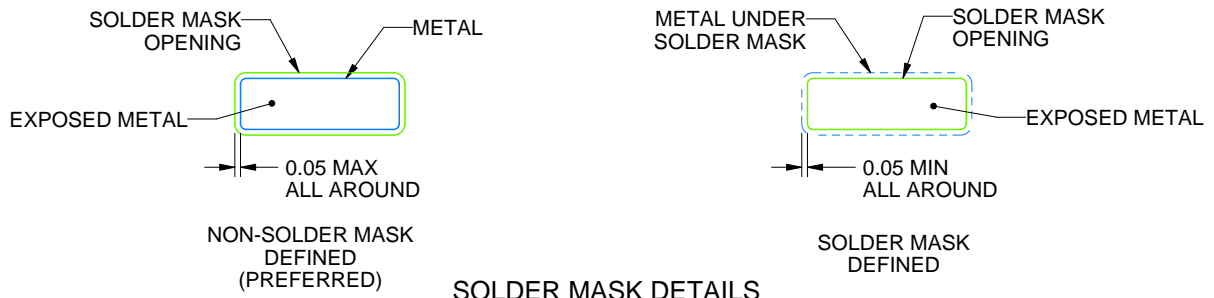

SOLDER MASK DETAILS

4214862/A 04/2023

NOTES: (continued)

6. Publication IPC-7351 may have alternate designs.
7. Solder mask tolerances between and around signal pads can vary based on board fabrication site.
8. Vias are optional depending on application, refer to device data sheet. If any vias are implemented, refer to their locations shown on this view. It is recommended that vias under paste be filled, plugged or tented.
9. Size of metal pad may vary due to creepage requirement.

# EXAMPLE STENCIL DESIGN

DGK0008A

™ VSSOP - 1.1 mm max height

SMALL OUTLINE PACKAGE

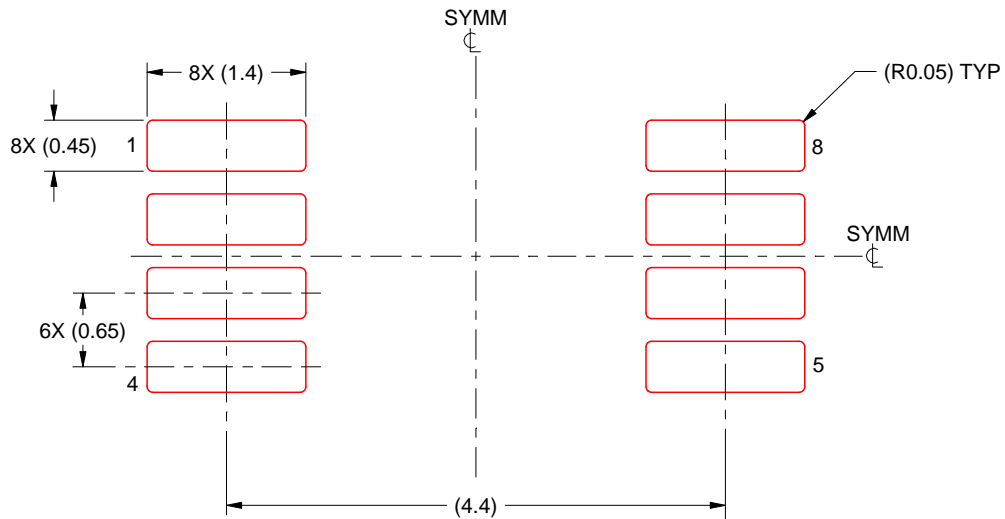

SOLDER PASTE EXAMPLE  
SCALE: 15X

4214862/A 04/2023

NOTES: (continued)

11. Laser cutting apertures with trapezoidal walls and rounded corners may offer better paste release. IPC-7525 may have alternate design recommendations.
12. Board assembly site may have different recommendations for stencil design.

## GENERIC PACKAGE VIEW

**DRG 8**

**WSO - 0.8 mm max height**

3 x 3, 0.5 mm pitch

PLASTIC SMALL OUTLINE - NO LEAD

This image is a representation of the package family, actual package may vary.  
Refer to the product data sheet for package details.

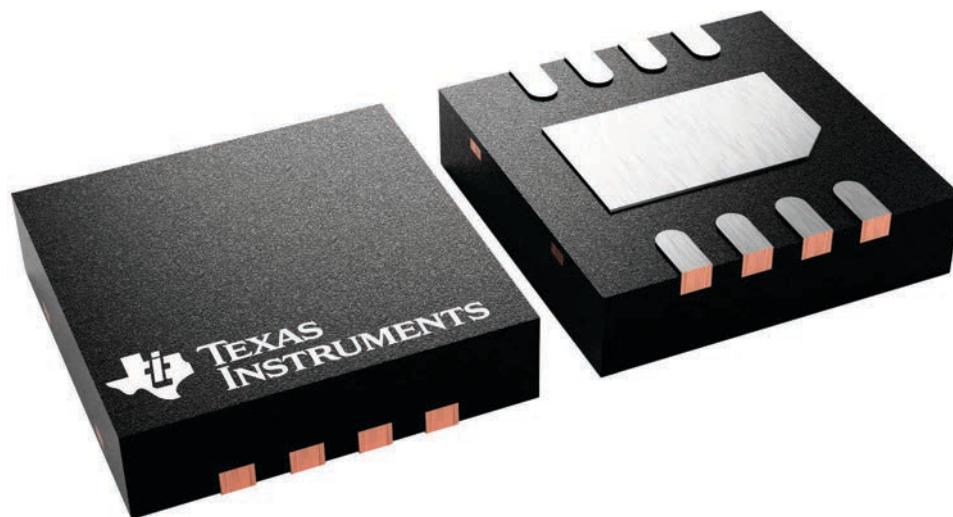

4225794/A

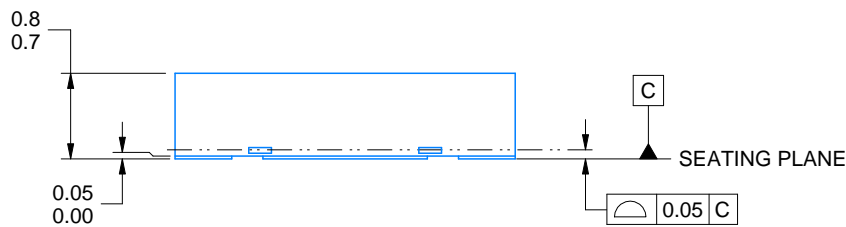
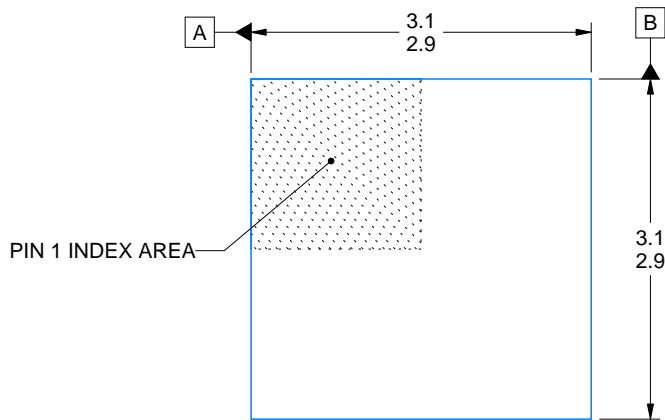
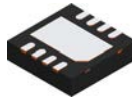

| DIMENSION A |       |
|-------------|-------|
| OPTION 01   | (0.1) |
| OPTION 02   | (0.2) |

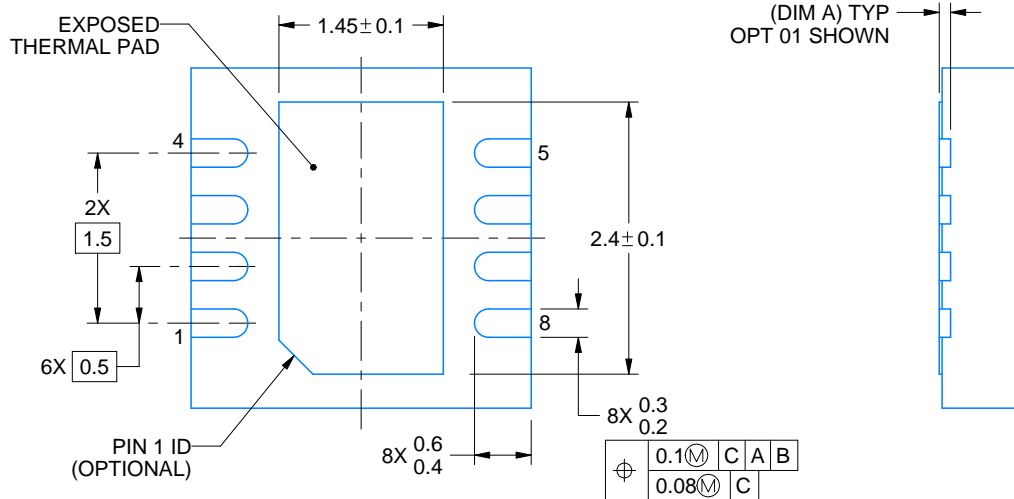

4218886/A 01/2020

NOTES:

1. All linear dimensions are in millimeters. Any dimensions in parenthesis are for reference only. Dimensioning and tolerancing per ASME Y14.5M.
2. This drawing is subject to change without notice.
3. The package thermal pad must be soldered to the printed circuit board for thermal and mechanical performance.



# EXAMPLE STENCIL DESIGN

DRG0008B

WSO - 0.8 mm max height

PLASTIC SMALL OUTLINE - NO LEAD

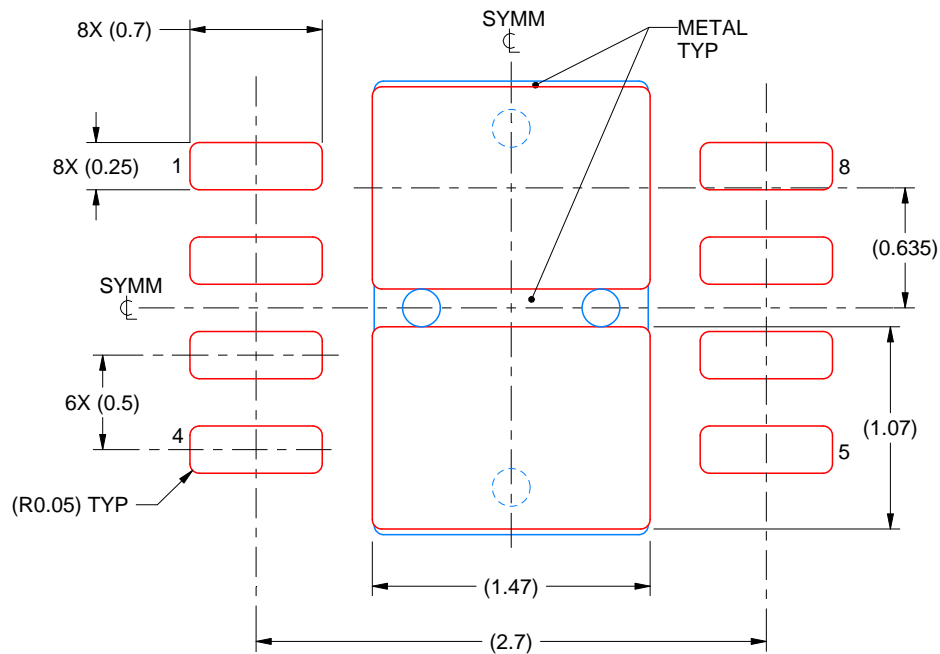

SOLDER PASTE EXAMPLE  
BASED ON 0.125 mm THICK STENCIL

EXPOSED PAD  
82% PRINTED SOLDER COVERAGE BY AREA  
SCALE:25X

4218886/A 01/2020

NOTES: (continued)

6. Laser cutting apertures with trapezoidal walls and rounded corners may offer better paste release. IPC-7525 may have alternate design recommendations.



D0008A

# PACKAGE OUTLINE

SOIC - 1.75 mm max height

SMALL OUTLINE INTEGRATED CIRCUIT



4214825/C 02/2019

### NOTES:

1. Linear dimensions are in inches [millimeters]. Dimensions in parenthesis are for reference only. Controlling dimensions are in inches. Dimensioning and tolerancing per ASME Y14.5M.
2. This drawing is subject to change without notice.
3. This dimension does not include mold flash, protrusions, or gate burrs. Mold flash, protrusions, or gate burrs shall not exceed  $.006$  [0.15] per side.
4. This dimension does not include interlead flash.
5. Reference JEDEC registration MS-012, variation AA.

# EXAMPLE BOARD LAYOUT

D0008A

SOIC - 1.75 mm max height

SMALL OUTLINE INTEGRATED CIRCUIT



LAND PATTERN EXAMPLE  
EXPOSED METAL SHOWN  
SCALE:8X



SOLDER MASK DETAILS

4214825/C 02/2019

NOTES: (continued)

6. Publication IPC-7351 may have alternate designs.

7. Solder mask tolerances between and around signal pads can vary based on board fabrication site.

# EXAMPLE STENCIL DESIGN

D0008A

SOIC - 1.75 mm max height

SMALL OUTLINE INTEGRATED CIRCUIT



SOLDER PASTE EXAMPLE  
BASED ON .005 INCH [0.125 MM] THICK STENCIL  
SCALE:8X

4214825/C 02/2019

NOTES: (continued)

8. Laser cutting apertures with trapezoidal walls and rounded corners may offer better paste release. IPC-7525 may have alternate design recommendations.
9. Board assembly site may have different recommendations for stencil design.

## 重要通知和免责声明

TI“按原样”提供技术和可靠性数据（包括数据表）、设计资源（包括参考设计）、应用或其他设计建议、网络工具、安全信息和其他资源，不保证没有瑕疵且不做任何明示或暗示的担保，包括但不限于对适销性、与某特定用途的适用性或不侵犯任何第三方知识产权的暗示担保。

这些资源可供使用 TI 产品进行设计的熟练开发人员使用。您将自行承担以下全部责任：(1) 针对您的应用选择合适的 TI 产品，(2) 设计、验证并测试您的应用，(3) 确保您的应用满足相应标准以及任何其他安全、安保法规或其他要求。

这些资源如有变更，恕不另行通知。TI 授权您仅可将这些资源用于研发本资源所述的 TI 产品的相关应用。严禁以其他方式对这些资源进行复制或展示。您无权使用任何其他 TI 知识产权或任何第三方知识产权。对于因您对这些资源的使用而对 TI 及其代表造成的任何索赔、损害、成本、损失和债务，您将全额赔偿，TI 对此概不负责。

TI 提供的产品受 [TI 销售条款](#)、[TI 通用质量指南](#) 或 [ti.com](#) 上其他适用条款或 TI 产品随附的其他适用条款的约束。TI 提供这些资源并不会扩展或以其他方式更改 TI 针对 TI 产品发布的适用的担保或担保免责声明。除非德州仪器 (TI) 明确将某产品指定为定制产品或客户特定产品，否则其产品均为按确定价格收入目录的标准通用器件。

TI 反对并拒绝您可能提出的任何其他或不同的条款。

版权所有 © 2026，德州仪器 (TI) 公司

最后更新日期：2025 年 10 月