

## LP3881 0.8A Fast-Response Ultra Low Dropout Linear Regulators

Check for Samples: [LP3881](#)

### FEATURES

- Ultra Low Dropout Voltage (75 mV @ 0.8A Typ)
- Low Ground Pin Current
- Load Regulation of 0.04%/A
- 60 nA Typical Quiescent Current in Shutdown
- 1.5% Output Accuracy (25°C)
- TO-220, TO-263 and SOIC-8 Packages
- Over Temperature/Over Current Protection
- -40°C to +125°C Junction Temperature Range

### APPLICATIONS

- DSP Power Supplies
- Server Core and I/O Supplies
- PC Add-in-Cards
- Local Regulators in Set-Top Boxes
- Microcontroller Power Supplies
- High Efficiency Power Supplies
- SMPS Post-Regulators

### DESCRIPTION

The LP3881 is a high current, fast response regulator which can maintain output voltage regulation with minimum input to output voltage drop. Fabricated on a CMOS process, the device operates from two input voltages: V<sub>bias</sub> provides voltage to drive the gate of the N-MOS power transistor, while V<sub>in</sub> is the input voltage which supplies power to the load. The use of an external bias rail allows the part to operate from ultra low V<sub>in</sub> voltages. Unlike bipolar regulators, the CMOS architecture consumes extremely low quiescent current at any output load current. The use of an N-MOS power transistor results in wide bandwidth, yet minimum external capacitance is required to maintain loop stability.

The fast transient response of these devices makes them suitable for use in powering DSP, Microcontroller Core voltages and Switch Mode Power Supply post regulators. The parts are available in TO-220, TO-263 and SOIC-8 packages.

**Dropout Voltage:** 75 mV (typ) @ 0.8A load current.

**Ground Pin Current:** 3 mA (typ) at full load.

**Shutdown Current:** 60 nA (typ) when S/D pin is low.

**Precision Output Voltage:** 1.5% room temperature accuracy.

### TYPICAL APPLICATION CIRCUIT

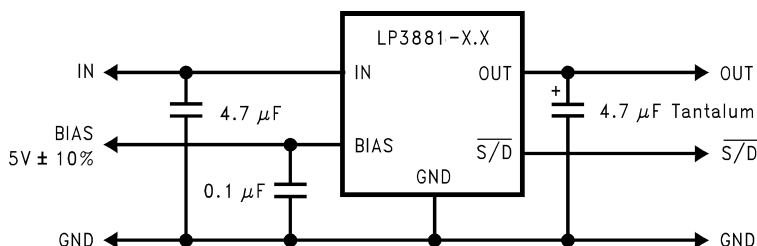

At least 4.7 µF of input and output capacitance is required for stability.



Please be aware that an important notice concerning availability, standard warranty, and use in critical applications of Texas Instruments semiconductor products and disclaimers thereto appears at the end of this data sheet.

All trademarks are the property of their respective owners.

### Connection Diagrams

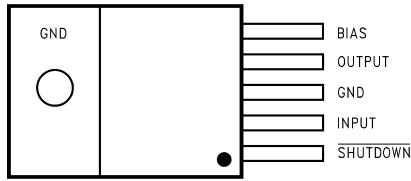

Figure 1. TO-220, Top View

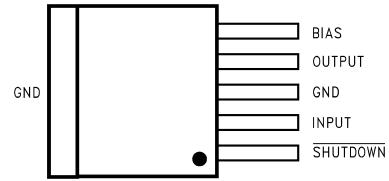

Figure 2. TO-263, Top View

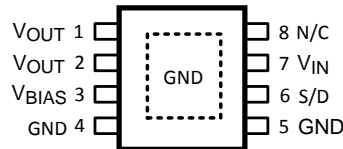
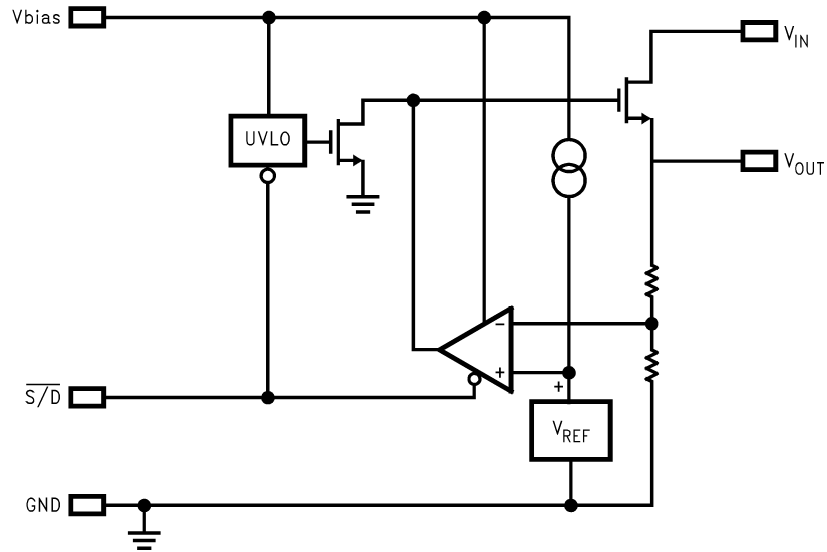

Figure 3. SOIC-8, Top View

### Block Diagram



These devices have limited built-in ESD protection. The leads should be shorted together or the device placed in conductive foam during storage or handling to prevent electrostatic damage to the MOS gates.

**ABSOLUTE MAXIMUM RATINGS** <sup>(1)</sup>

Storage Temperature Range		-65°C to +150°C
Lead Temp. (Soldering, 5 seconds)		260°C
ESD Rating	Human Body Model <sup>(2)</sup>	2 kV
	Machine Model <sup>(3)</sup>	200V
Power Dissipation <sup>(4)</sup>		Internally Limited
$V_{IN}$ Supply Voltage (Survival)		-0.3V to +6V
$V_{BIAS}$ Supply Voltage (Survival)		-0.3V to +7V
Shutdown Input Voltage (Survival)		-0.3V to +7V
$I_{OUT}$ (Survival)		Internally Limited
Output Voltage (Survival)		-0.3V to +6V
Junction Temperature		-40°C to +150°C

- (1) Absolute maximum ratings indicate limits beyond which damage to the component may occur. Operating ratings indicate conditions for which the device is intended to be functional, but do not ensure specific performance limits. For ensured specifications, see Electrical Characteristics. Specifications do not apply when operating the device outside of its rated operating conditions.
- (2) The human body model is a 100 pF capacitor discharged through a 1.5k resistor into each pin.
- (3) The machine model is a 220 pF capacitor discharged directly into each pin. The machine model ESD rating of pin 5 is 100V.
- (4) At elevated temperatures, device power dissipation must be derated based on package thermal resistance and heatsink thermal values.  $\theta_{J-A}$  for TO-220 devices is 65°C/W if no heatsink is used. If the TO-220 device is attached to a heatsink, a  $\theta_{J-S}$  value of 4°C/W can be assumed.  $\theta_{J-A}$  for TO-263 devices is approximately 40°C/W if soldered down to a copper plane which is at least 1.5 square inches in area.  $\theta_{J-A}$  value for typical SOIC-8 PC board mounting is 166°C/W. If power dissipation causes the junction temperature to exceed specified limits, the device will go into thermal shutdown.

**OPERATING RATINGS**

$V_{IN}$ Supply Voltage	( $V_{OUT} + V_{DO}$ ) to 5.5V
Shutdown Input Voltage	0 to +6V
$I_{OUT}$	0.8A
Operating Junction Temperature Range	-40°C to +125°C
$V_{BIAS}$ Supply Voltage	4.5V to 6V

## ELECTRICAL CHARACTERISTICS

Limits in standard typeface are for  $T_J = 25^\circ\text{C}$ , and limits in **boldface type** apply over the full operating temperature range. Unless otherwise specified:  $V_{IN} = V_O(\text{NOM}) + 1\text{V}$ ,  $V_{BIAS} = 4.5\text{V}$ ,  $I_L = 10\text{ mA}$ ,  $C_{IN} = C_{OUT} = 4.7\ \mu\text{F}$ ,  $V_{S/D} = V_{BIAS}$ .

Symbol	Parameter	Conditions	Min <sup>(1)</sup>	Typical <sup>(2)</sup>	Max <sup>(1)</sup>	Units
$V_O$	Output Voltage Tolerance	$10\text{ mA} < I_L < 0.8\text{A}$ $V_O(\text{NOM}) + 1\text{V} \leq V_{IN} \leq 5.5\text{V}$ $4.5\text{V} \leq V_{BIAS} \leq 6\text{V}$	1.198	1.216	1.234	V
			<b>1.186</b>		<b>1.246</b>	
			1.478	1.5	1.522	
			<b>1.455</b>		<b>1.545</b>	
		1.773	1.8	1.827		
		<b>1.746</b>		<b>1.854</b>		
$\Delta V_O/\Delta V_{IN}$	Output Voltage Line Regulation <sup>(3)</sup>	$V_O(\text{NOM}) + 1\text{V} \leq V_{IN} \leq 5.5\text{V}$		0.01		%/V
$\Delta V_O/\Delta I_L$	Output Voltage Load Regulation <sup>(4)</sup>	$10\text{ mA} < I_L < 0.8\text{A}$		0.04 <b>0.06</b>		%/A
$V_{DO}$	Dropout Voltage <sup>(5)</sup>	$I_L = 0.8\text{A}$ (TO220 and TO263 only)		75	120 <b>160</b>	mV
		$I_L = 0.8\text{A}$ (SOIC only)		80	140 <b>190</b>	
$I_Q(V_{IN})$	Quiescent Current Drawn from $V_{IN}$ Supply	$10\text{ mA} < I_L < 0.8\text{A}$		3	7 <b>8</b>	mA
		$\overline{V_{S/D}} \leq 0.3\text{V}$		0.03	1 <b>30</b>	
$I_Q(V_{BIAS})$	Quiescent Current Drawn from $V_{BIAS}$ Supply	$10\text{ mA} < I_L < 0.8\text{A}$		1	2 <b>3</b>	mA
		$\overline{V_{S/D}} \leq 0.3\text{V}$		0.03	1 <b>30</b>	
$I_{SC}$	Short-Circuit Current	$V_{OUT} = 0\text{V}$		2.5		A
<b>Shutdown Input</b>						
$V_{SDT}$	Output Turn-off Threshold	Output = ON	<b>1.3</b>	0.7		V
		Output = OFF		0.7	<b>0.3</b>	
$T_d(\text{OFF})$	Turn-OFF Delay	$R_{LOAD} \times C_{OUT} \ll T_d(\text{OFF})$		20		$\mu\text{s}$
$T_d(\text{ON})$	Turn-ON Delay	$R_{LOAD} \times C_{OUT} \ll T_d(\text{ON})$		15		
$I_{S/D}$	$\overline{S/D}$ Input Current	$\overline{V_{S/D}} = 1.3\text{V}$		1		$\mu\text{A}$
		$\overline{V_{S/D}} \leq 0.3\text{V}$		-1		
<b>AC Parameters</b>						
PSRR ( $V_{IN}$ )	Ripple Rejection for $V_{IN}$ Input Voltage	$V_{IN} = V_{OUT} + 1\text{V}$ , $f = 120\text{ Hz}$		80		dB
		$V_{IN} = V_{OUT} + 1\text{V}$ , $f = 1\text{ kHz}$		65		
PSRR ( $V_{BIAS}$ )	Ripple Rejection for $V_{BIAS}$ Voltage	$V_{BIAS} = V_{OUT} + 3\text{V}$ , $f = 120\text{ Hz}$		70		
		$V_{BIAS} = V_{OUT} + 3\text{V}$ , $f = 1\text{ kHz}$		65		
	Output Noise Density	$f = 120\text{ Hz}$		1		$\mu\text{V}/\text{root-Hz}$
$e_n$	Output Noise Voltage $V_{OUT} = 1.8\text{V}$	$\text{BW} = 10\text{ Hz} - 100\text{ kHz}$		150		$\mu\text{V (rms)}$
		$\text{BW} = 300\text{ Hz} - 300\text{ kHz}$		90		

- (1) Limits are specified through testing, statistical correlation, or design.
- (2) Typical numbers represent the most likely parametric norm for  $25^\circ\text{C}$  operation.
- (3) Output voltage line regulation is defined as the change in output voltage from nominal value resulting from a change in input voltage.
- (4) Output voltage load regulation is defined as the change in output voltage from nominal value as the load current increases from no load to full load.
- (5) Dropout voltage is defined as the minimum input to output differential required to maintain the output with 2% of nominal value. The SOIC-8 package devices have a slightly higher dropout voltage due to increased band wire resistance.

**TYPICAL PERFORMANCE CHARACTERISTICS**

Unless otherwise specified:  $T_A = 25^\circ\text{C}$ ,  $C_{OUT} = 4.7\mu\text{F}$ ,  $C_{in} = 4.7\mu\text{F}$ ,  $\overline{S/D}$  pin is tied to  $V_{BIAS}$ ,  $V_{IN} = 2.2\text{V}$ ,  $V_{OUT} = 1.8\text{V}$

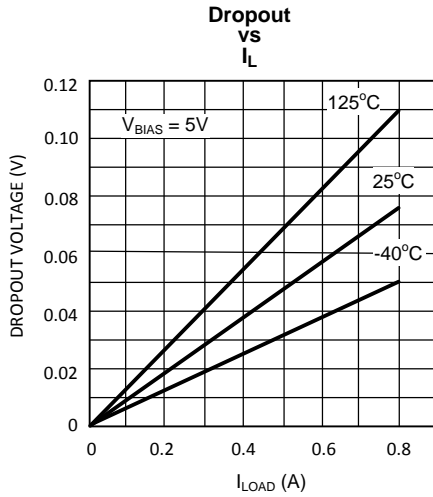

Figure 4.

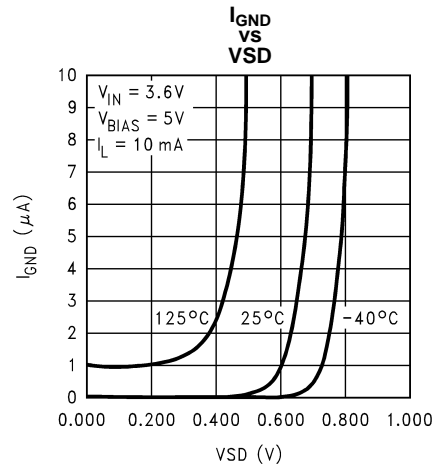

Figure 5.

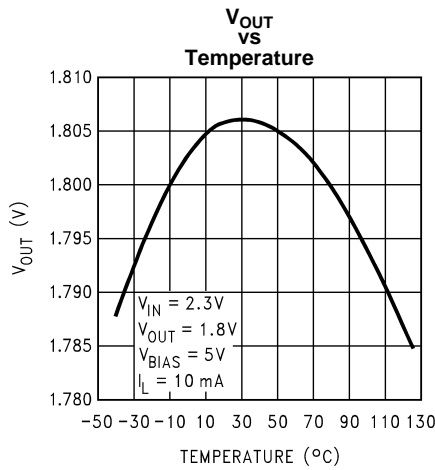

Figure 6.

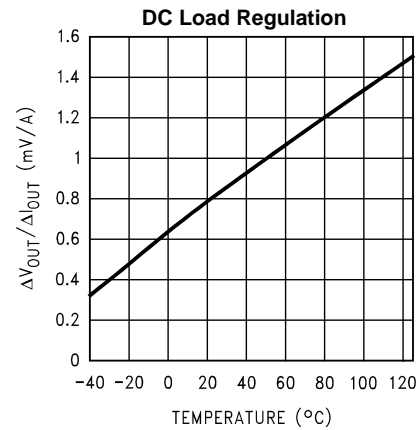

Figure 7.

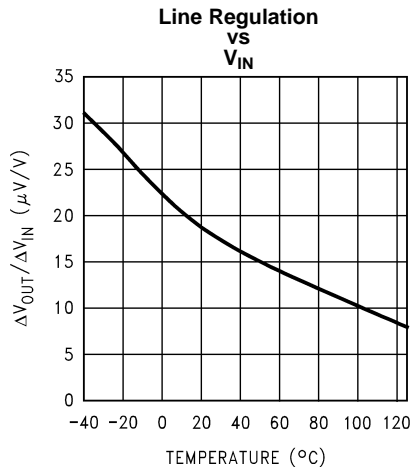

Figure 8.

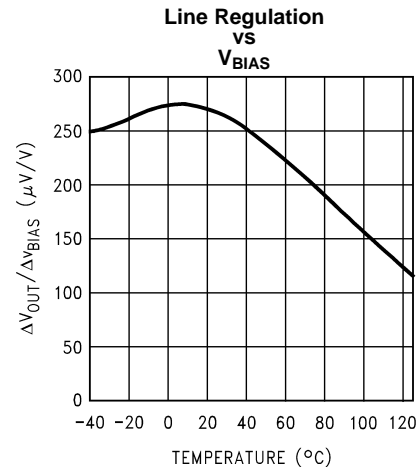

Figure 9.

### TYPICAL PERFORMANCE CHARACTERISTICS (continued)

Unless otherwise specified:  $T_A = 25^\circ\text{C}$ ,  $C_{OUT} = 4.7\mu\text{F}$ ,  $C_{in} = 4.7\mu\text{F}$ ,  $\overline{S/D}$  pin is tied to  $V_{BIAS}$ ,  $V_{IN} = 2.2\text{V}$ ,  $V_{OUT} = 1.8\text{V}$

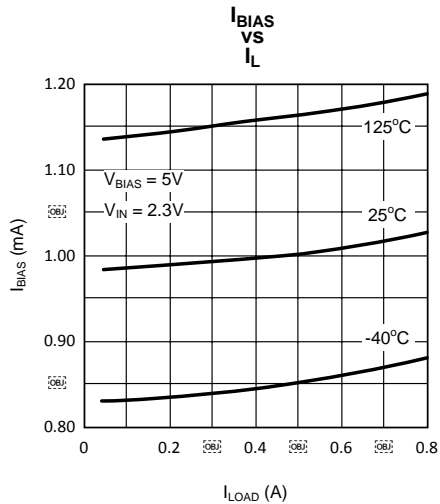

Figure 10.

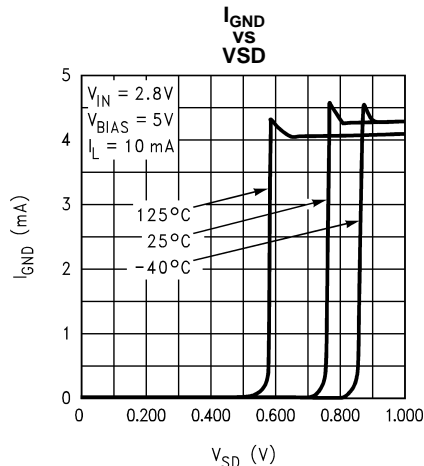

Figure 11.

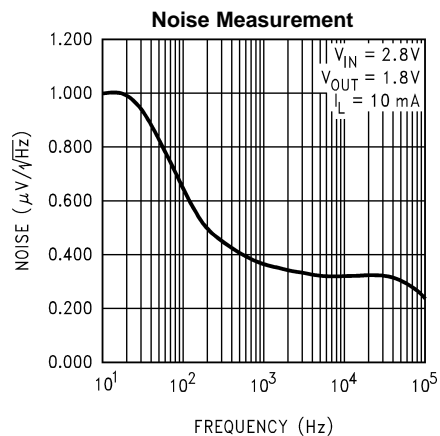

Figure 12.

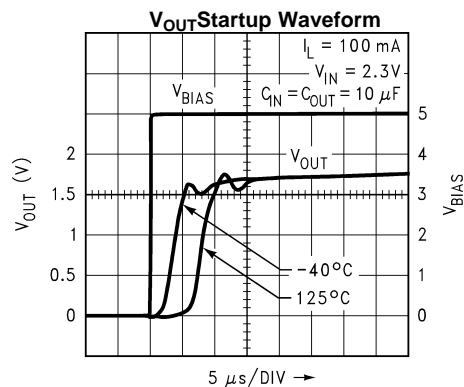

Figure 13.

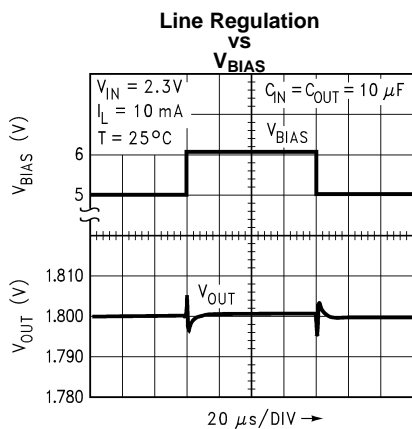

Figure 14.

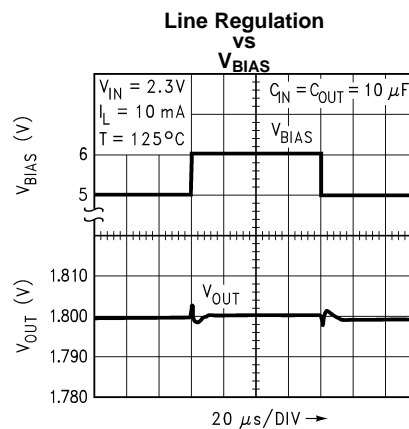

Figure 15.

**TYPICAL PERFORMANCE CHARACTERISTICS (continued)**

Unless otherwise specified:  $T_A = 25^\circ\text{C}$ ,  $C_{OUT} = 4.7\mu\text{F}$ ,  $C_{in} = 4.7\mu\text{F}$ ,  $\overline{S/D}$  pin is tied to  $V_{BIAS}$ ,  $V_{IN} = 2.2\text{V}$ ,  $V_{OUT} = 1.8\text{V}$

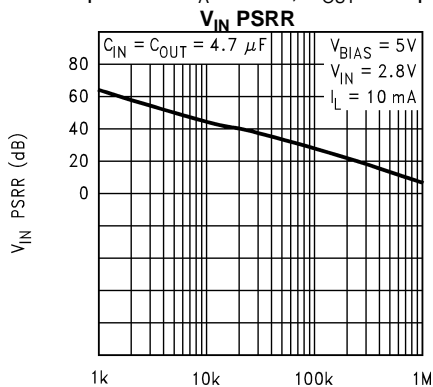

Figure 16.

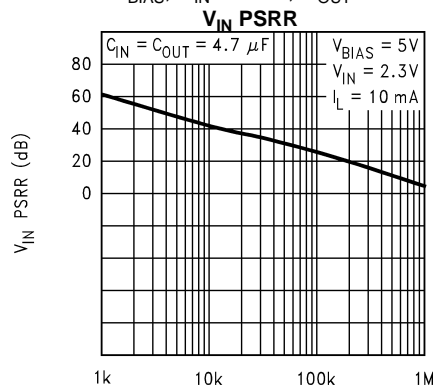

Figure 17.

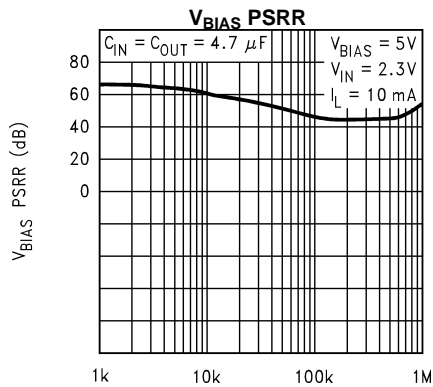

Figure 18.

## APPLICATION INFORMATION

### Application Hints

#### EXTERNAL CAPACITORS

To assure regulator stability, input and output capacitors are required as shown in the Typical Application Circuit.

#### OUTPUT CAPACITOR

At least 4.7 $\mu$ F of output capacitance is required for stability (the amount of capacitance can be increased without limit). The output capacitor must be located less than 1 cm from the output pin of the IC and returned to a clean analog ground. The ESR (equivalent series resistance) of the output capacitor must be within the "stable" range as shown in the graph below over the full operating temperature range for stable operation.

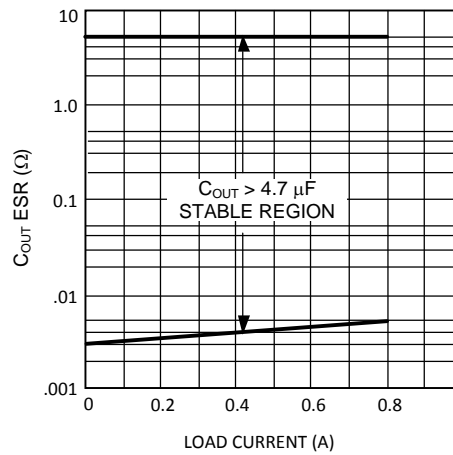

**Figure 19. Minimum ESR vs Output Load Current**

Tantalum capacitors are recommended for the output as their ESR is ideally suited to the part's requirements and the ESR is very stable over temperature. Aluminum electrolytics are not recommended because their ESR increases very rapidly at temperatures below 10C. Aluminum caps can only be used in applications where lower temperature operation is not required.

A second problem with Al caps is that many have ESR's which are only specified at low frequencies. The typical loop bandwidth of a linear regulator is a few hundred kHz to several MHz. If an Al cap is used for the output cap, it must be one whose ESR is specified at a frequency of 100 kHz or more.

Because the ESR of ceramic capacitors is only a few milli Ohms, they are not suitable for use as output capacitors on LP388X devices. The regulator output can tolerate ceramic capacitance totaling up to 15% of the amount of Tantalum capacitance connected from the output to ground.

#### OUTPUT "BYPASS" CAPACITORS

Many designers place small value "bypass" capacitors at various circuit points to reduce noise. Ceramic capacitors in the value range of about 1000pF to 0.1 $\mu$ F placed directly on the output of a PNP or P-FET LDO regulator can cause a loss of phase margin which can result in oscillations, even when a Tantalum output capacitor is in parallel with it. This is not unique to Texas Instruments LDO regulators, it is true of any P-type LDO regulator.

The reason for this is that PNP or P-FET regulators have a higher output impedance (compared to an NPN regulator), which results in a pole-zero pair being formed by every different capacitor connected to the output.

The zero frequency is approximately:

$$F_z = 1 / (2 \times \pi \times \text{ESR} \times C)$$

where

- ESR is the equivalent series resistance of the capacitor

- C is the value of capacitance (1)

The pole frequency is:

$$F_p = 1 / (2 \times \pi \times R_L \times C)$$

where

- $R_L$  is the load resistance connected to the regulator output (2)

To understand why a small capacitor can reduce phase margin: assume a typical LDO with a bandwidth of 1MHz, which is delivering 0.5A of current from a 2.5V output (which means  $R_L$  is 5 Ohms). We then place a .047  $\mu$ F capacitor on the output. This creates a pole whose frequency is:

$$F_p = 1 / (2 \times \pi \times 5 \times .047 \times 10E-6) = 677 \text{ kHz} \quad (3)$$

This pole would add close to 60 degrees of phase lag at the crossover (unity gain) frequency of 1 MHz, which would almost certainly make this regulator oscillate. Depending on the load current, output voltage, and bandwidth, there are usually values of small capacitors which can seriously reduce phase margin. If the capacitors are ceramic, they tend to oscillate more easily because they have very little internal inductance to damp it out. If bypass capacitors are used, it is best to place them near the load and use trace inductance to "decouple" them from the regulator output.

### INPUT CAPACITOR

The input capacitor must be at least 4.7  $\mu$ F, but can be increased without limit. It's purpose is to provide a low source impedance for the regulator input. Ceramic capacitors work best for this, but Tantalums are also very good. There is no ESR limitation on the input capacitor (the lower, the better). Aluminum electrolytics can be used, but their ESR increase very quickly at cold temperatures. They are not recommended for any application where temperatures go below about 10°C.

### BIAS CAPACITOR

The 0.1 $\mu$ F capacitor on the bias line can be any good quality capacitor (ceramic is recommended).

### BIAS VOLTAGE

The bias voltage is an external voltage rail required to get gate drive for the N-FET pass transistor. Bias voltage must be in the range of 4.5 - 6V to assure proper operation of the part.

### UNDER VOLTAGE LOCKOUT

The bias voltage is monitored by a circuit which prevents the regulator output from turning on if the bias voltage is below approximately 4V.

### SHUTDOWN OPERATION

Pulling down the shutdown ( $\overline{S/D}$ ) pin will turn-off the regulator. Pin  $\overline{S/D}$  must be actively terminated through a pull-up resistor (10 k $\Omega$  to 100 k $\Omega$ ) for a proper operation. If this pin is driven from a source that actively pulls high and low (such as a CMOS rail to rail comparator), the pull-up resistor is not required. This pin must be tied to  $V_{in}$  if not used.

### POWER DISSIPATION/HEATSINKING

A heatsink may be required depending on the maximum power dissipation and maximum ambient temperature of the application. Under all possible conditions, the junction temperature must be within the range specified under operating conditions. The total power dissipation of the device is given by:

$$P_D = (V_{IN} - V_{OUT})I_{OUT} + (V_{IN})I_{GND}$$

where

- $I_{GND}$  is the operating ground current of the device (4)

The maximum allowable temperature rise ( $T_{Rmax}$ ) depends on the maximum ambient temperature ( $T_{Amax}$ ) of the application, and the maximum allowable junction temperature ( $T_{Jmax}$ ):

$$T_{Rmax} = T_{Jmax} - T_{Amax}$$

The maximum allowable value for junction to ambient Thermal Resistance,  $\theta_{JA}$ , can be calculated using the formula:

$$\theta_{JA} = T_{Rmax} / P_D$$

These parts are available in TO-220 and TO-263 packages. The thermal resistance depends on amount of copper area or heat sink, and on air flow. If the maximum allowable value of  $\theta_{JA}$  calculated above is  $\geq 60$  °C/W for TO-220 package and  $\geq 60$  °C/W for TO-263 package no heatsink is needed since the package can dissipate enough heat to satisfy these requirements. If the value for allowable  $\theta_{JA}$  falls below these limits, a heat sink is required.

### HEATSINKING TO-220 PACKAGE

The thermal resistance of a TO220 package can be reduced by attaching it to a heat sink or a copper plane on a PC board. If a copper plane is to be used, the values of  $\theta_{JA}$  will be same as shown in next section for TO263 package.

The heatsink to be used in the application should have a heatsink to ambient thermal resistance,

$$\theta_{HA} \leq \theta_{JA} - \theta_{CH} - \theta_{JC}$$

In this equation,  $\theta_{CH}$  is the thermal resistance from the case to the surface of the heat sink and  $\theta_{JC}$  is the thermal resistance from the junction to the surface of the case.  $\theta_{JC}$  is about 3°C/W for a TO220 package. The value for  $\theta_{CH}$  depends on method of attachment, insulator, etc.  $\theta_{CH}$  varies between 1.5°C/W to 2.5°C/W. If the exact value is unknown, 2°C/W can be assumed.

### HEATSINKING TO-263 PACKAGE

The TO-263 package uses the copper plane on the PCB as a heatsink. The tab of these packages are soldered to the copper plane for heat sinking. The graph below shows a curve for the  $\theta_{JA}$  of TO-263 package for different copper area sizes, using a typical PCB with 1 ounce copper and no solder mask over the copper area for heat sinking.

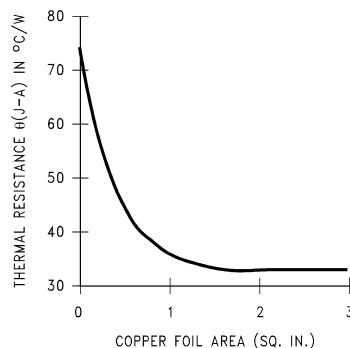

**Figure 20.  $\theta_{JA}$  vs Copper (1 Ounce) Area for TO-263 package**

As shown in the graph below, increasing the copper area beyond 1 square inch produces very little improvement. The minimum value for  $\theta_{JA}$  for the TO-263 package mounted to a PCB is 32°C/W.

**Figure 21** shows the maximum allowable power dissipation for TO-263 packages for different ambient temperatures, assuming  $\theta_{JA}$  is 35°C/W and the maximum junction temperature is 125°C.

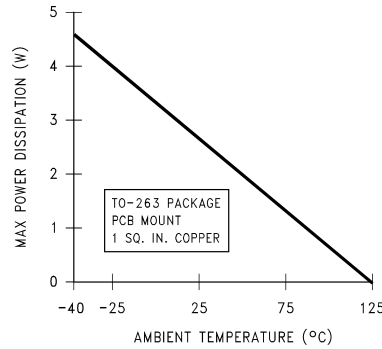

Figure 21. Maximum power dissipation vs ambient temperature for TO-263 package

### HEATSINKING SOIC PACKAGE

Heatsinking for the SOIC-8 package is accomplished by allowing heat to flow through the ground slug on the bottom of the package into the copper on the PC board. The heat slug must be soldered down to a copper plane to get good heat transfer. It can also be connected through vias to internal copper planes. Since the heat slug is at ground potential, traces must not be routed under it which are not at ground potential. Under all possible conditions, the junction temperature must be within the range specified under operating conditions.

Figure 22 shows a curve for the  $\theta_{JA}$  of the SOIC package for different copper area sizes using a typical PCB with one ounce copper in still air.

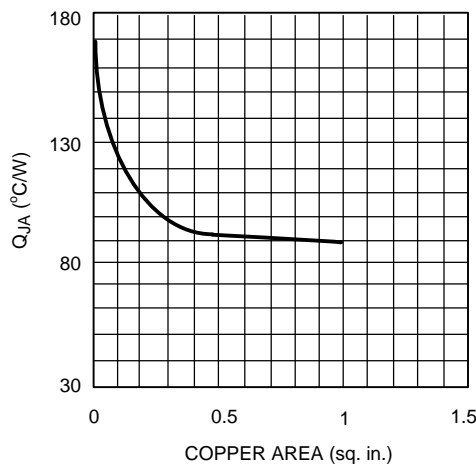

Figure 22.  $\theta_{JA}$  vs. Copper (1 ounce) Area for SOIC Package

## REVISION HISTORY

Changes from Revision E (April 2013) to Revision F	Page
• Changed layout of National Data Sheet to TI format .....	<a href="#">11</a>

**PACKAGING INFORMATION**

Orderable part number	Status (1)	Material type (2)	Package   Pins	Package qty   Carrier	RoHS (3)	Lead finish/ Ball material (4)	MSL rating/ Peak reflow (5)	Op temp (°C)	Part marking (6)
<a href="#">LP3881ES-1.2/NOPB</a>	Active	Production	DDPAK/ TO-263 (KTT)   5	45   TUBE	ROHS Exempt	SN	Level-3-245C-168 HR	-40 to 125	LP3881ES -1.2
LP3881ES-1.2/NOPB.A	Active	Production	DDPAK/ TO-263 (KTT)   5	45   TUBE	ROHS Exempt	SN	Level-3-245C-168 HR	-40 to 125	LP3881ES -1.2
<a href="#">LP3881ES-1.5/NOPB</a>	Active	Production	DDPAK/ TO-263 (KTT)   5	45   TUBE	ROHS Exempt	SN	Level-3-245C-168 HR	-40 to 125	LP3881ES -1.5
LP3881ES-1.5/NOPB.A	Active	Production	DDPAK/ TO-263 (KTT)   5	45   TUBE	ROHS Exempt	SN	Level-3-245C-168 HR	-40 to 125	LP3881ES -1.5
<a href="#">LP3881ES-1.8/NOPB</a>	Active	Production	DDPAK/ TO-263 (KTT)   5	45   TUBE	ROHS Exempt	SN	Level-3-245C-168 HR	-40 to 125	LP3881ES -1.8
LP3881ES-1.8/NOPB.A	Active	Production	DDPAK/ TO-263 (KTT)   5	45   TUBE	ROHS Exempt	SN	Level-3-245C-168 HR	-40 to 125	LP3881ES -1.8
<a href="#">LP3881ESX-1.2/NOPB</a>	Active	Production	DDPAK/ TO-263 (KTT)   5	500   LARGE T&R	ROHS Exempt	SN	Level-3-245C-168 HR	-40 to 125	LP3881ES -1.2
LP3881ESX-1.2/NOPB.A	Active	Production	DDPAK/ TO-263 (KTT)   5	500   LARGE T&R	ROHS Exempt	SN	Level-3-245C-168 HR	-40 to 125	LP3881ES -1.2
<a href="#">LP3881ESX-1.8/NOPB</a>	Active	Production	DDPAK/ TO-263 (KTT)   5	500   LARGE T&R	ROHS Exempt	SN	Level-3-245C-168 HR	-40 to 125	LP3881ES -1.8
LP3881ESX-1.8/NOPB.A	Active	Production	DDPAK/ TO-263 (KTT)   5	500   LARGE T&R	ROHS Exempt	SN	Level-3-245C-168 HR	-40 to 125	LP3881ES -1.8

(1) **Status:** For more details on status, see our [product life cycle](#).

(2) **Material type:** When designated, preproduction parts are prototypes/experimental devices, and are not yet approved or released for full production. Testing and final process, including without limitation quality assurance, reliability performance testing, and/or process qualification, may not yet be complete, and this item is subject to further changes or possible discontinuation. If available for ordering, purchases will be subject to an additional waiver at checkout, and are intended for early internal evaluation purposes only. These items are sold without warranties of any kind.

(3) **RoHS values:** Yes, No, RoHS Exempt. See the [TI RoHS Statement](#) for additional information and value definition.

(4) **Lead finish/Ball material:** Parts may have multiple material finish options. Finish options are separated by a vertical ruled line. Lead finish/Ball material values may wrap to two lines if the finish value exceeds the maximum column width.

(5) **MSL rating/Peak reflow:** The moisture sensitivity level ratings and peak solder (reflow) temperatures. In the event that a part has multiple moisture sensitivity ratings, only the lowest level per JEDEC standards is shown. Refer to the shipping label for the actual reflow temperature that will be used to mount the part to the printed circuit board.

(6) **Part marking:** There may be an additional marking, which relates to the logo, the lot trace code information, or the environmental category of the part.

Multiple part markings will be inside parentheses. Only one part marking contained in parentheses and separated by a "~" will appear on a part. If a line is indented then it is a continuation of the previous line and the two combined represent the entire part marking for that device.

**Important Information and Disclaimer:**The information provided on this page represents TI's knowledge and belief as of the date that it is provided. TI bases its knowledge and belief on information provided by third parties, and makes no representation or warranty as to the accuracy of such information. Efforts are underway to better integrate information from third parties. TI has taken and continues to take reasonable steps to provide representative and accurate information but may not have conducted destructive testing or chemical analysis on incoming materials and chemicals. TI and TI suppliers consider certain information to be proprietary, and thus CAS numbers and other limited information may not be available for release.

In no event shall TI's liability arising out of such information exceed the total purchase price of the TI part(s) at issue in this document sold by TI to Customer on an annual basis.

**TAPE AND REEL INFORMATION**

**QUADRANT ASSIGNMENTS FOR PIN 1 ORIENTATION IN TAPE**

\*All dimensions are nominal

Device	Package Type	Package Drawing	Pins	SPQ	Reel Diameter (mm)	Reel Width W1 (mm)	A0 (mm)	B0 (mm)	K0 (mm)	P1 (mm)	W (mm)	Pin1 Quadrant
LP3881ESX-1.2/NOPB	DDPAK/TO-263	KTT	5	500	330.0	24.4	10.75	14.85	5.0	16.0	24.0	Q2
LP3881ESX-1.8/NOPB	DDPAK/TO-263	KTT	5	500	330.0	24.4	10.75	14.85	5.0	16.0	24.0	Q2

**TAPE AND REEL BOX DIMENSIONS**

\*All dimensions are nominal

Device	Package Type	Package Drawing	Pins	SPQ	Length (mm)	Width (mm)	Height (mm)
LP3881ESX-1.2/NOPB	DDPAK/TO-263	KTT	5	500	356.0	356.0	45.0
LP3881ESX-1.8/NOPB	DDPAK/TO-263	KTT	5	500	356.0	356.0	45.0

**TUBE**

\*All dimensions are nominal

Device	Package Name	Package Type	Pins	SPQ	L (mm)	W (mm)	T (μm)	B (mm)
LP3881ES-1.2/NOPB	KTT	TO-263	5	45	502	25	8204.2	9.19
LP3881ES-1.2/NOPB.A	KTT	TO-263	5	45	502	25	8204.2	9.19
LP3881ES-1.5/NOPB	KTT	TO-263	5	45	502	25	8204.2	9.19
LP3881ES-1.5/NOPB.A	KTT	TO-263	5	45	502	25	8204.2	9.19
LP3881ES-1.8/NOPB	KTT	TO-263	5	45	502	25	8204.2	9.19
LP3881ES-1.8/NOPB.A	KTT	TO-263	5	45	502	25	8204.2	9.19

KTT0005B



TS5B (Rev D)

## IMPORTANT NOTICE AND DISCLAIMER

TI PROVIDES TECHNICAL AND RELIABILITY DATA (INCLUDING DATASHEETS), DESIGN RESOURCES (INCLUDING REFERENCE DESIGNS), APPLICATION OR OTHER DESIGN ADVICE, WEB TOOLS, SAFETY INFORMATION, AND OTHER RESOURCES "AS IS" AND WITH ALL FAULTS, AND DISCLAIMS ALL WARRANTIES, EXPRESS AND IMPLIED, INCLUDING WITHOUT LIMITATION ANY IMPLIED WARRANTIES OF MERCHANTABILITY, FITNESS FOR A PARTICULAR PURPOSE OR NON-INFRINGEMENT OF THIRD PARTY INTELLECTUAL PROPERTY RIGHTS.

These resources are intended for skilled developers designing with TI products. You are solely responsible for (1) selecting the appropriate TI products for your application, (2) designing, validating and testing your application, and (3) ensuring your application meets applicable standards, and any other safety, security, regulatory or other requirements.

These resources are subject to change without notice. TI grants you permission to use these resources only for development of an application that uses the TI products described in the resource. Other reproduction and display of these resources is prohibited. No license is granted to any other TI intellectual property right or to any third party intellectual property right. TI disclaims responsibility for, and you fully indemnify TI and its representatives against any claims, damages, costs, losses, and liabilities arising out of your use of these resources.

TI's products are provided subject to [TI's Terms of Sale](#), [TI's General Quality Guidelines](#), or other applicable terms available either on [ti.com](http://ti.com) or provided in conjunction with such TI products. TI's provision of these resources does not expand or otherwise alter TI's applicable warranties or warranty disclaimers for TI products. Unless TI explicitly designates a product as custom or customer-specified, TI products are standard, catalog, general purpose devices.

TI objects to and rejects any additional or different terms you may propose.

Copyright © 2026, Texas Instruments Incorporated

Last updated 10/2025