

具有可调输出的 LP38690-ADJ, LP38692-ADJ 1A 低压降 CMOS 线性稳压器 与陶瓷输出电容器一起使用时保持稳定

查询样品: [LP38690-ADJ](#), [LP38692-ADJ](#)

特性

- 1.25V - 9V 的输出电压范围
- 2.0% 调节引脚电压精度 (25°C)
- 低压降: 1A (典型值, 5V 输出) 时为 450mV
- 宽输入电压范围 (2.7V 至 10V)
- 精密 (已调整) 带隙基准
- 确保了 -40°C 至 +125°C 温度范围内的技术规格
- 1µA 关闭状态静态电流
- 热过载保护
- 折返电流限制
- 小外形尺寸晶体管 (SOT)-223 封装和 6 引线晶圆级小外形尺寸封装 (WSON) 封装
- 使能引脚 (LP38692-ADJ)

应用范围

- 硬盘驱动器
- 笔记本电脑
- 电池供电类器件
- 便携式仪表

典型应用电路

说明

LP38690/2-ADJ 低压降 CMOS 线性稳压器提供 2.0% 精密基准电压, 极低压降 (在负载电流为 1A, $V_{\text{输出}}=5\text{V}$ 时为 450mV) 以及采用超低等效串联电阻 (ESR) 陶瓷输出电容器时所具有出色 AC 性能。

WSON 和 SON-223 封装所具有的的低热阻, 即使在周围温度较高的环境中也可实现满运行电流。

PMOS 功率晶体管的使用意味着无需 DC 基驱动电流对其进行偏置, 从而无论负载电流、输入电压或者运行温度是多少时均可将接地引脚电流保持在低于 100µA 的水平上。

压降电压: 450mV (典型值), 这是在电流为 1A (典型值 5V 输出) 时的值。

接地引脚电流: 满负载时为 55µA (典型值)。

调节引脚电压: 2.0% (25°C) 精度。

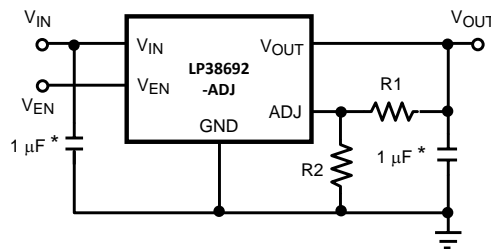
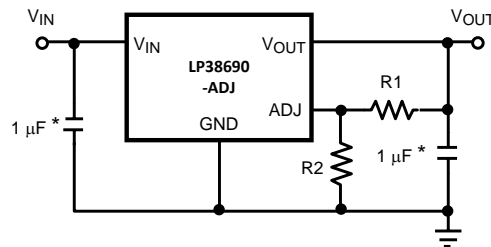

$$V_{\text{输出}} = V_{\text{ADJ}} \times (1 + R1/R2)$$

* 稳定需要的最小值。



Please be aware that an important notice concerning availability, standard warranty, and use in critical applications of Texas Instruments semiconductor products and disclaimers thereto appears at the end of this data sheet.

All trademarks are the property of their respective owners.

连接图



图 1. SOT-223 (LP38692MP-ADJ) - 顶视图
请见封装编号 NDC0005A



图 2. 6 引线 WSON (LP38690SD-ADJ) - 顶视图
请见封装编号 NGG0006A

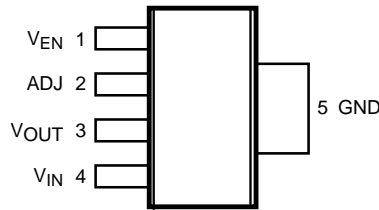

图 3. 6 引线 WSON (LP38692SD-ADJ) 顶视图
请见封装编号 NGG

引脚说明

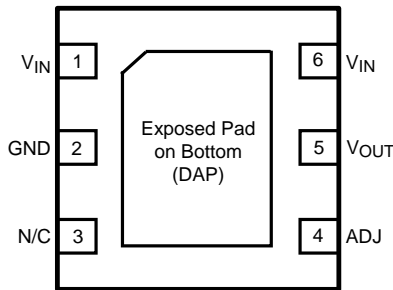
| 引脚 | 说明 |
|-----------------|--|
| V _{输入} | 这是到稳压器的输入电源电压。对于 WSON 封装器件，两个 V _{输入} 引脚必须被接在一起以实现满电流运行（每引脚最大电流 500mA）。 |
| GND | 针对稳压器的电路接地。对于 SOT-223 封装，它被热接至裸片，并在被焊接到一个较大铜覆区下面时用作一个散热连接。 |
| V _{输出} | 经稳压调节的输出电压。 |
| V _{EN} | 可通过将使能引脚拉至高电平或低电平来打开和关闭此部件。 |
| ADJ | 通过将其连接至外部电阻器 R1 和 R2，此调节引脚被用来设定经稳压的输出电压（请见典型应用电路）。 |
| DAP | 只适用于 WSON 封装 - DAP（外露垫）在焊接到铜覆区时被用作散热连接。更多信息请见 WSON MOUNTING 部分，此部分在 APPLICATION HINTS 中。 |

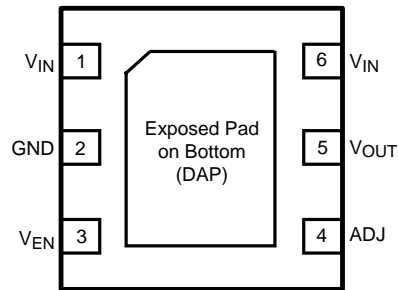

These devices have limited built-in ESD protection. The leads should be shorted together or the device placed in conductive foam during storage or handling to prevent electrostatic damage to the MOS gates.

ABSOLUTE MAXIMUM RATINGS⁽¹⁾⁽²⁾

| | |
|---------------------------------------|--------------------|
| Storage Temperature Range | -65°C to +150°C |
| Lead Temp. (Soldering, 5 seconds) | 260°C |
| ESD Rating ⁽³⁾ | 2 kV |
| Power Dissipation ⁽⁴⁾ | Internally Limited |
| V(max) All pins (with respect to GND) | -0.3V to 12V |
| I _{OUT} ⁽⁵⁾ | Internally Limited |
| Junction Temperature | -40°C to +150°C |

- (1) Absolute maximum ratings indicate limits beyond which damage to the component may occur. Operating ratings indicate conditions for which the device is intended to be functional, but do not ensure specific performance limits. For ensured specifications, see Electrical Characteristics. Specifications do not apply when operating the device outside of its rated operating conditions.
- (2) If Military/Aerospace specified devices are required, please contact the TI Sales Office/ Distributors for availability and specifications.
- (3) ESD is tested using the human body model which is a 100pF capacitor discharged through a 1.5k resistor into each pin.
- (4) At elevated temperatures, device power dissipation must be derated based on package thermal resistance and heatsink values (if a heatsink is used). The junction-to-ambient thermal resistance (θ_{J-A}) for the SOT-223 is approximately 125 °C/W for a PC board mounting with the device soldered down to minimum copper area (less than 0.1 square inch). If one square inch of copper is used as a heat dissipator for the SOT-223, the θ_{J-A} drops to approximately 70 °C/W. The θ_{J-A} values for the WSON package are also dependent on trace area, copper thickness, and the number of thermal vias used (refer to the TI [AN-1187 Application Report](#) and the [WSON MOUNTING](#) section in this datasheet). If power dissipation causes the junction temperature to exceed specified limits, the device will go into thermal shutdown.
- (5) If used in a dual-supply system where the regulator load is returned to a negative supply, the output pin must be diode clamped to ground.

OPERATING RATINGS

| | |
|--------------------------------------|-----------------|
| V _{IN} Supply Voltage | 2.7V to 10V |
| Operating Junction Temperature Range | -40°C to +125°C |

ELECTRICAL CHARACTERISTICS

Limits in standard typeface are for $T_J = 25^\circ\text{C}$, and limits in **boldface type** apply over the full operating temperature range. Unless otherwise specified: $V_{IN} = V_{OUT} + 1\text{V}$, $C_{IN} = C_{OUT} = 10\ \mu\text{F}$, $I_{LOAD} = 10\text{mA}$. Min/Max limits are specified through testing, statistical correlation, or design.

| Symbol | Parameter | Conditions | Min | Typ ⁽¹⁾ | Max | Units |
|------------------------------|---|--|--------------|--------------------|---------------------------|--------------------------------|
| V_{ADJ} | ADJ Pin Voltage | $V_{IN} = 2.7\text{V}$ | 1.219 | 1.25 | 1.281 | V |
| | | $3.2\text{V} \leq V_{IN} \leq 10\text{V}$ $100\ \mu\text{A} < I_L < 1\text{A}$ | 1.187 | 1.25 | 1.313 | |
| $\Delta V_O / \Delta V_{IN}$ | Output Voltage Line Regulation ⁽²⁾ | $V_O + 0.5\text{V} \leq V_{IN} \leq 10\text{V}$ $I_L = 25\text{mA}$ | | 0.03 | 0.1 | %/V |
| $\Delta V_O / \Delta I_L$ | Output Voltage Load Regulation ⁽³⁾ | $1\ \text{mA} < I_L < 1\text{A}$ $V_{IN} = V_O + 1\text{V}$ | | 1.8 | 5 | %/A |
| $V_{IN} - V_O$ | Dropout Voltage ⁽⁴⁾ | $(V_O = 1.8\text{V})$ $I_L = 1\text{A}$ | | 950 | 1600 | mV |
| | | $(V_O = 2.5\text{V})$ $I_L = 0.1\text{A}$ $I_L = 1\text{A}$ | | 80 800 | 145 1300 | |
| | | $(V_O = 3.3\text{V})$ $I_L = 0.1\text{A}$ $I_L = 1\text{A}$ | | 65 650 | 110 1000 | |
| | | $(V_O = 5\text{V})$ $I_L = 0.1\text{A}$ $I_L = 1\text{A}$ | | 45 450 | 100 800 | |
| I_Q | Quiescent Current | $V_{IN} \leq 10\text{V}$, $I_L = 100\ \mu\text{A} - 1\text{A}$ | | 55 | 100 | μA |
| | | $V_{EN} \leq 0.4\text{V}$, (LP38692-ADJ Only) | | 0.001 | 1 | |
| $I_L(\text{MIN})$ | Minimum Load Current | $V_{IN} - V_O \leq 4\text{V}$ | | | 100 | |
| I_{FB} | Foldback Current Limit | $V_{IN} - V_O > 5\text{V}$ | | 450 | | mA |
| | | $V_{IN} - V_O < 4\text{V}$ | | 1500 | | |
| PSRR | Ripple Rejection | $V_{IN} = V_O + 2\text{V}(\text{DC})$, with $1\text{V}(\text{p-p}) / 120\text{Hz}$ Ripple | | 55 | | dB |
| T_{SD} | Thermal Shutdown Activation (Junction Temp) | | | 160 | | $^\circ\text{C}$ |
| $T_{SD}(\text{HYST})$ | Thermal Shutdown Hysteresis (Junction Temp) | | | 10 | | |
| I_{ADJ} | ADJ Input Leakage Current | $V_{ADJ} = 0 - 1.5\text{V}$ $V_{IN} = 10\text{V}$ | -100 | 0.01 | 100 | nA |
| e_n | Output Noise | $\text{BW} = 10\text{Hz to } 10\text{kHz}$ $V_O = 3.3\text{V}$ | | 0.7 | | $\mu\text{V}/\sqrt{\text{Hz}}$ |
| $V_O(\text{LEAK})$ | Output Leakage Current | $V_O = V_O(\text{NOM}) + 1\text{V} @ 10V_{IN}$ | | 0.5 | 2 | μA |
| V_{EN} | Enable Voltage (LP38692-ADJ Only) | Output = OFF | | | 0.4 | V |
| | | Output = ON, $V_{IN} = 4\text{V}$ | 1.8 | | | |
| | | Output = ON, $V_{IN} = 6\text{V}$ | 3.0 | | | |
| | | Output = ON, $V_{IN} = 10\text{V}$ | 4.0 | | | |
| I_{EN} | Enable Pin Leakage (LP38692-ADJ Only) | $V_{EN} = 0\text{V or } 10\text{V}$, $V_{IN} = 10\text{V}$ | -1 | 0.001 | 1 | μA |

- (1) Typical numbers represent the most likely parametric norm for 25°C operation.
- (2) Output voltage line regulation is defined as the change in output voltage from nominal value resulting from a change in input voltage.
- (3) Output voltage load regulation is defined as the change in output voltage from nominal value as the load current increases from 1mA to full load.
- (4) Dropout voltage is defined as the minimum input to output differential required to maintain the output within 100mV of nominal value.

BLOCK DIAGRAMS

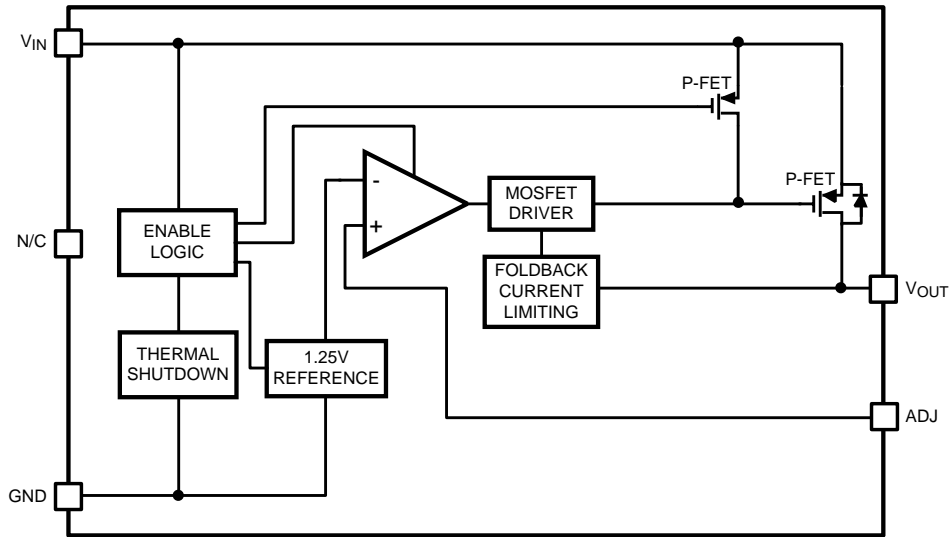

Figure 4. LP38690-ADJ Functional Diagram (WSON)

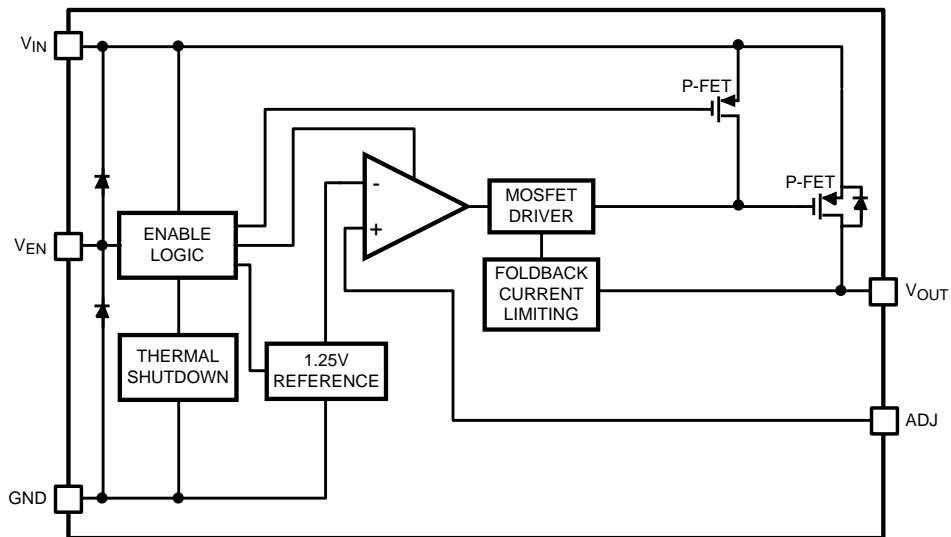

Figure 5. LP38692-ADJ Functional Diagram (SOT-223, WSON)

TYPICAL PERFORMANCE CHARACTERISTICS

Unless otherwise specified: $T_J = 25^\circ\text{C}$, $C_{IN} = C_{OUT} = 10\ \mu\text{F}$, enable pin is tied to V_{IN} (LP38692-ADJ only), $V_O = 1.25\text{V}$, $V_{IN} = 2.7\text{V}$, $I_L = 10\text{mA}$.

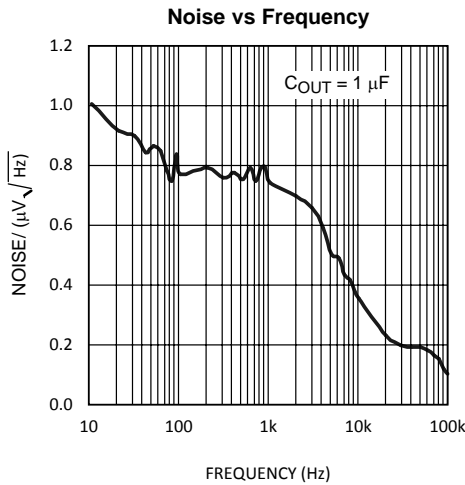

Figure 6.

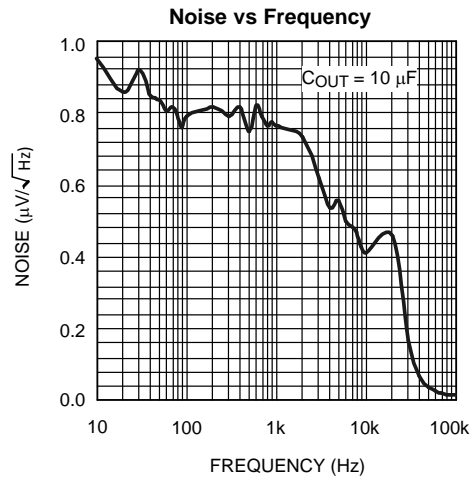

Figure 7.

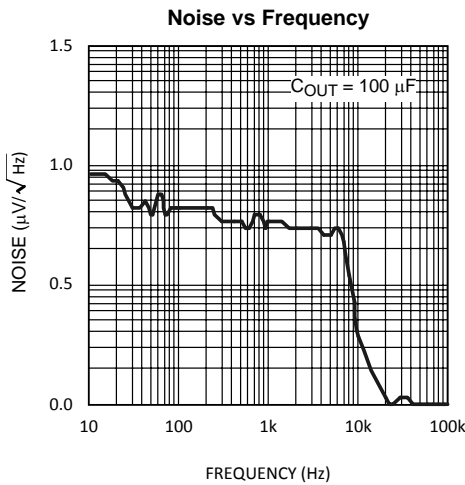

Figure 8.

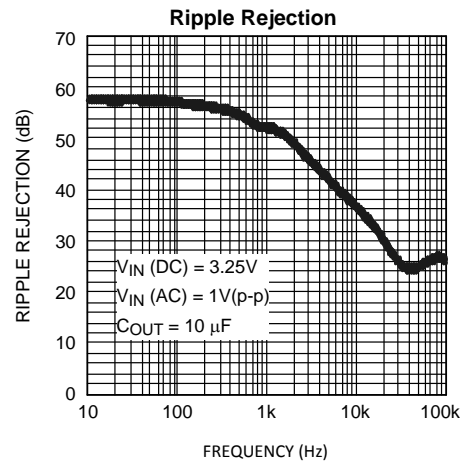

Figure 9.

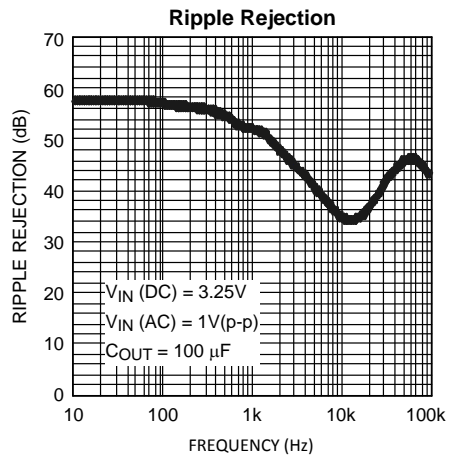

Figure 10.

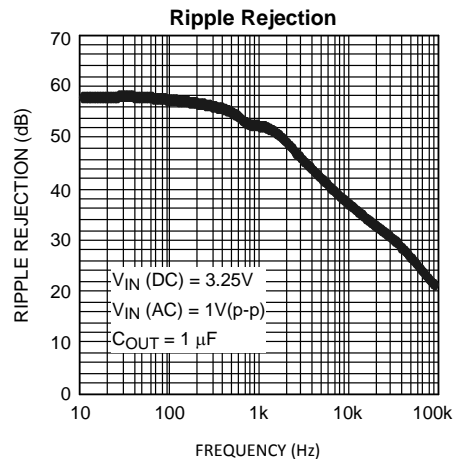

Figure 11.

TYPICAL PERFORMANCE CHARACTERISTICS (continued)

Unless otherwise specified: $T_J = 25^\circ\text{C}$, $C_{IN} = C_{OUT} = 10\ \mu\text{F}$, enable pin is tied to V_{IN} (LP38692-ADJ only), $V_O = 1.25\text{V}$, $V_{IN} = 2.7\text{V}$, $I_L = 10\text{mA}$.

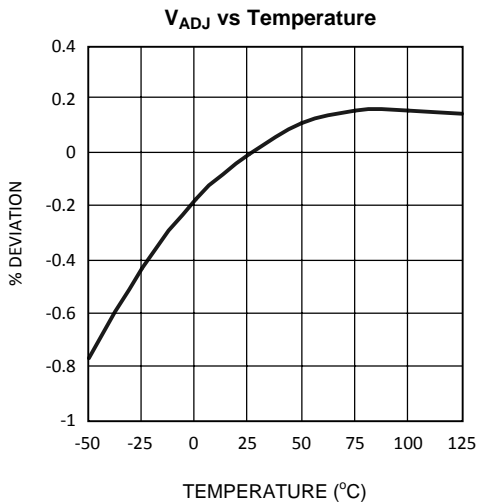

Figure 12.

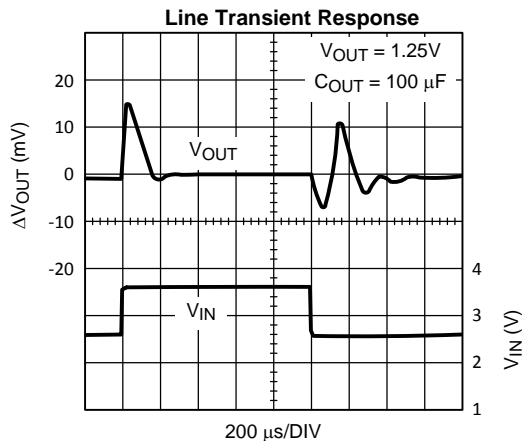

Figure 13.

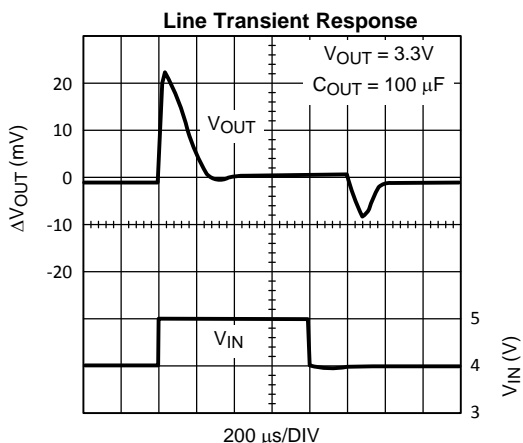

Figure 14.

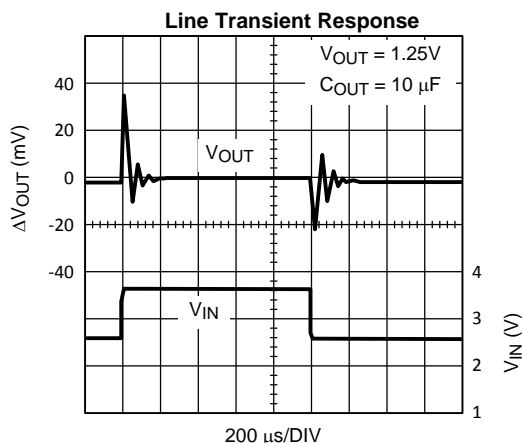

Figure 15.

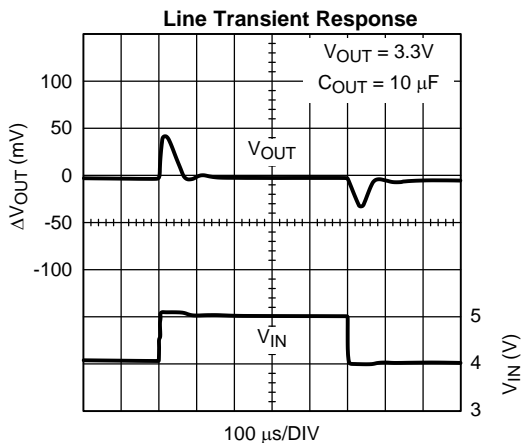

Figure 16.

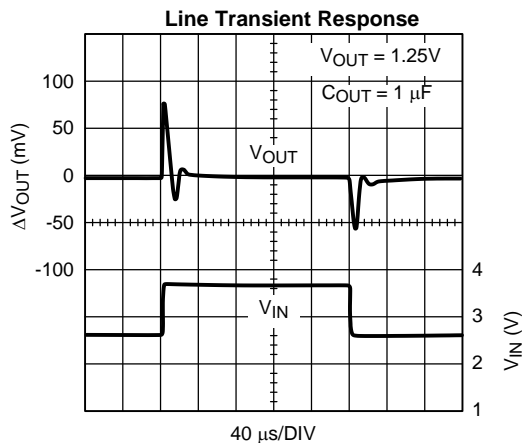

Figure 17.

TYPICAL PERFORMANCE CHARACTERISTICS (continued)

Unless otherwise specified: $T_J = 25^\circ\text{C}$, $C_{IN} = C_{OUT} = 10\ \mu\text{F}$, enable pin is tied to V_{IN} (LP38692-ADJ only), $V_O = 1.25\text{V}$, $V_{IN} = 2.7\text{V}$, $I_L = 10\text{mA}$.

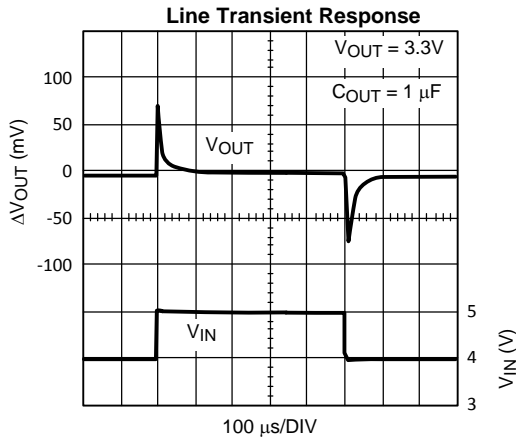

Figure 18.

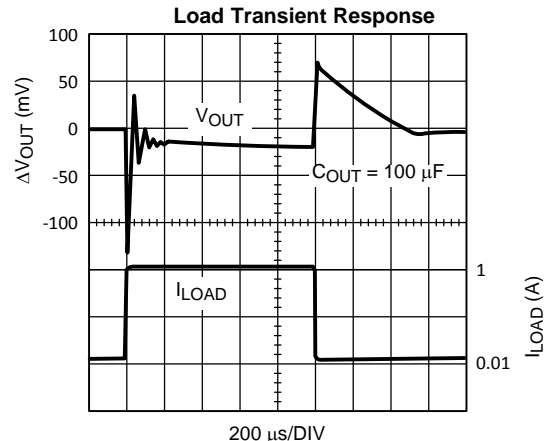

Figure 19.

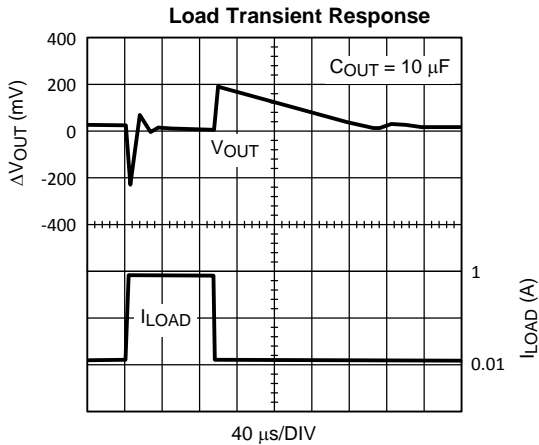

Figure 20.

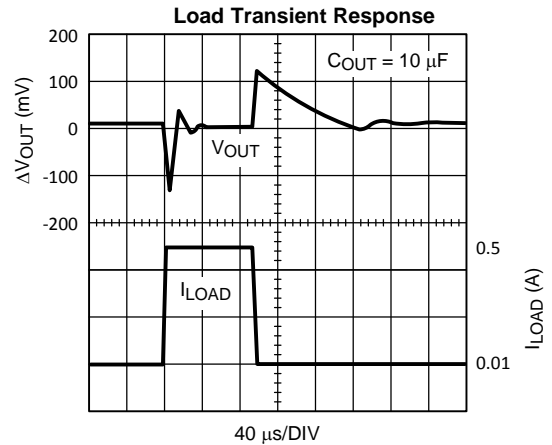

Figure 21.

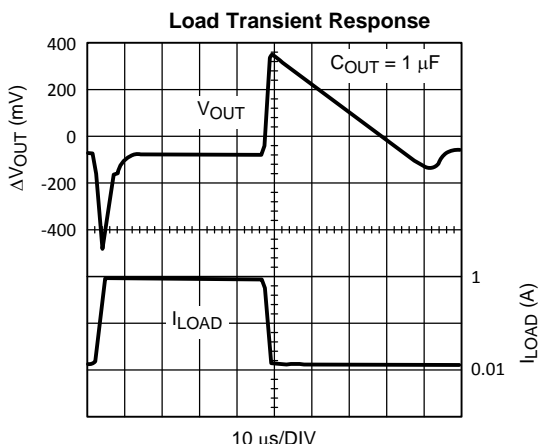

Figure 22.

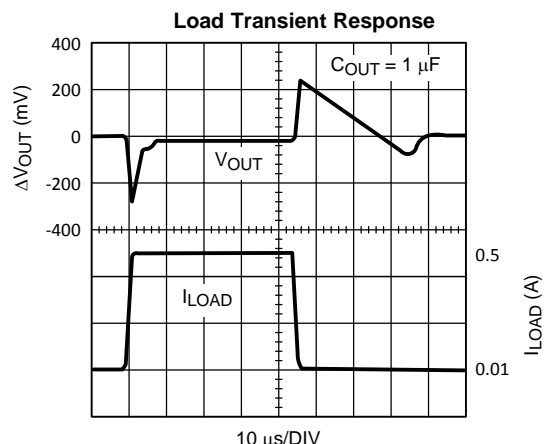

Figure 23.

TYPICAL PERFORMANCE CHARACTERISTICS (continued)

Unless otherwise specified: $T_J = 25^\circ\text{C}$, $C_{IN} = C_{OUT} = 10 \mu\text{F}$, enable pin is tied to V_{IN} (LP38692-ADJ only), $V_O = 1.25\text{V}$, $V_{IN} = 2.7\text{V}$, $I_L = 10\text{mA}$.

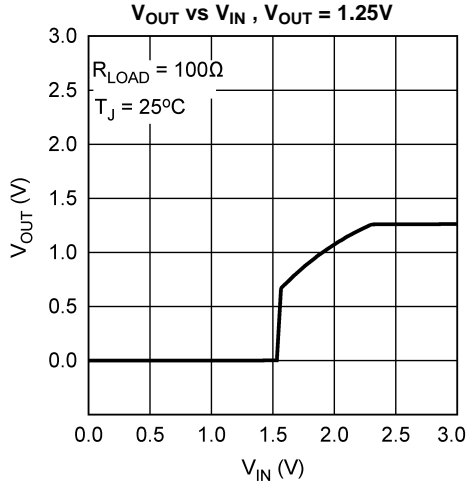

Figure 24.

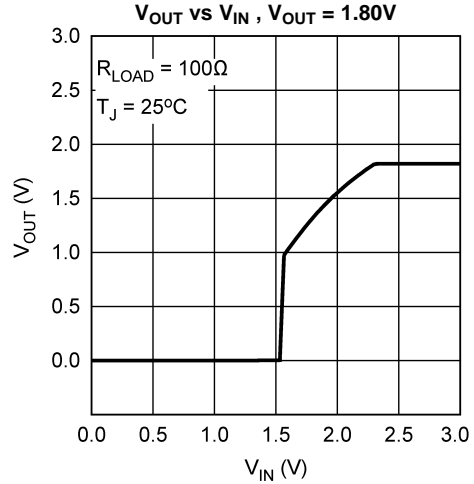

Figure 25.

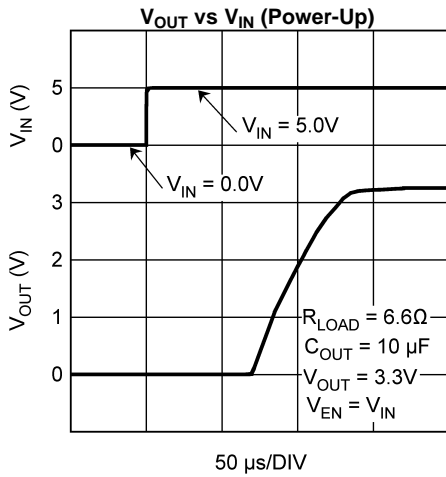

Figure 26.

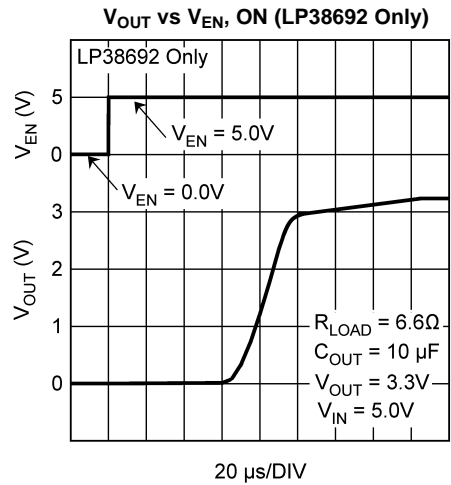

Figure 27.

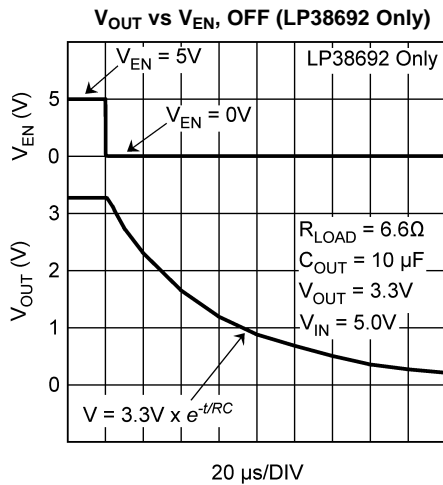

Figure 28.

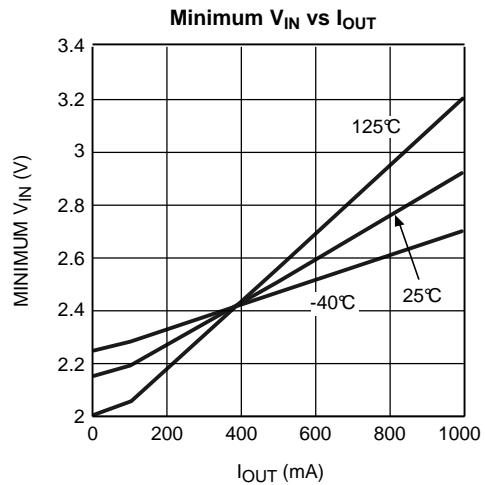

Figure 29.

TYPICAL PERFORMANCE CHARACTERISTICS (continued)

Unless otherwise specified: $T_J = 25^\circ\text{C}$, $C_{IN} = C_{OUT} = 10\ \mu\text{F}$, enable pin is tied to V_{IN} (LP38692-ADJ only), $V_O = 1.25\text{V}$, $V_{IN} = 2.7\text{V}$, $I_L = 10\text{mA}$.

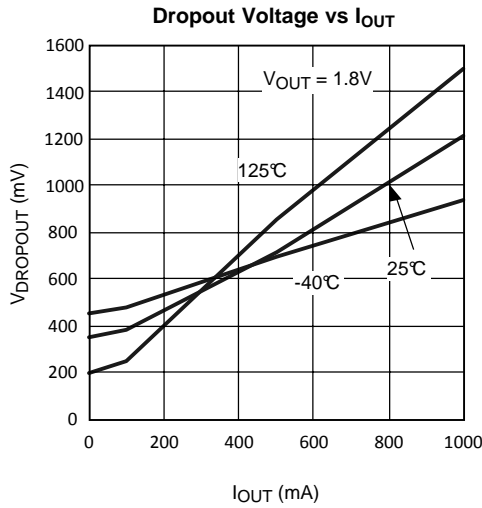

Figure 30.

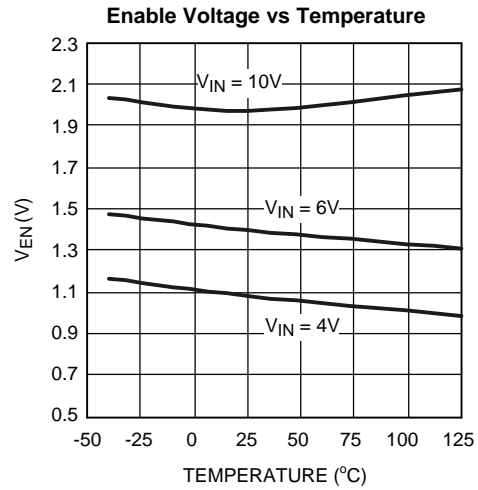

Figure 31.

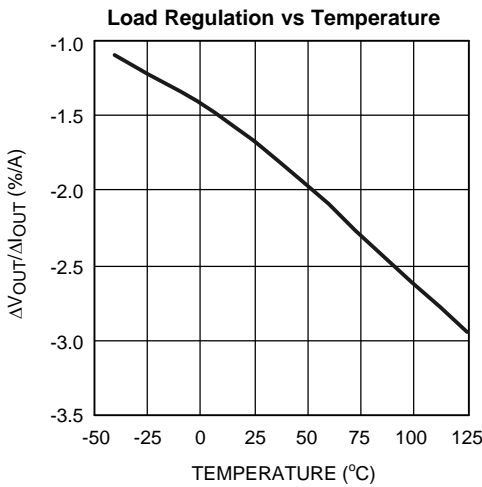

Figure 32.

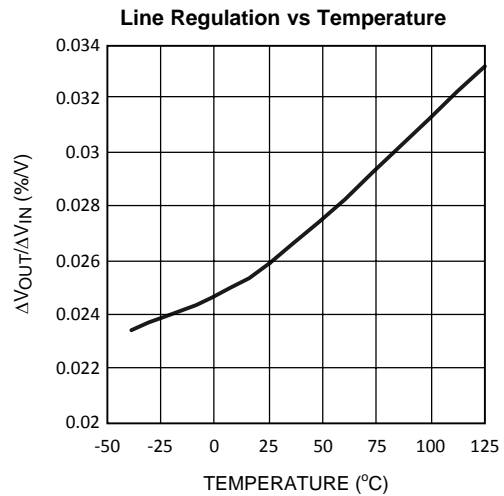

Figure 33.

APPLICATION HINTS

EXTERNAL CAPACITORS

Like any low-dropout regulator, external capacitors are required to assure stability. These capacitors must be correctly selected for proper performance.

INPUT CAPACITOR:

An input capacitor of at least 1 μ F is required (ceramic recommended). The capacitor must be located not more than one centimeter from the input pin and returned to a clean analog ground.

OUTPUT CAPACITOR:

An output capacitor is required for loop stability. It must be located less than 1 centimeter from the device and connected directly to the output and ground pins using traces which have no other currents flowing through them.

The minimum amount of output capacitance that can be used for stable operation is 1 μ F. Ceramic capacitors are recommended (the LP38690/2-ADJ was designed for use with ultra low ESR capacitors). The LP38690/2-ADJ is stable with any output capacitor ESR between zero and 100 Ohms.

SETTING THE OUTPUT VOLTAGE:

The output voltage is set using the external resistors R1 and R2 (see [典型应用电路](#)). The output voltage will be given by the equation:

$$V_{OUT} = V_{ADJ} \times (1 + (R1 / R2)) \quad (1)$$

Because the part has a minimum load current requirement of 100 μ A, it is recommended that R2 always be 12k Ohms or less to provide adequate loading. Even if a minimum load is always provided by other means, it is not recommended that very high value resistors be used for R1 and R2 because it can make the ADJ node susceptible to noise pickup. A maximum value of 100k is recommended for R2 to prevent this from occurring.

ENABLE PIN (LP38692-ADJ only):

The LP38692-ADJ has an Enable pin (EN) which allows an external control signal to turn the regulator output On and Off. The Enable On/Off threshold has no hysteresis. The voltage signal must rise and fall cleanly, and promptly, through the ON and OFF voltage thresholds. The Enable pin has no internal pull-up or pull-down to establish a default condition and, as a result, this pin must be terminated either actively or passively. If the Enable pin is driven from a source that actively pulls high and low, the drive voltage should not be allowed to go below ground potential or higher than V_{IN} . If the application does not require the Enable function, the pin should be connected directly to the V_{IN} pin.

FOLDBACK CURRENT LIMITING:

Foldback current limiting is built into the LP38690/2-ADJ which reduces the amount of output current the part can deliver as the output voltage is reduced. The amount of load current is dependent on the differential voltage between V_{IN} and V_{OUT} . Typically, when this differential voltage exceeds 5V, the load current will limit at about 450 mA. When the $V_{IN} - V_{OUT}$ differential is reduced below 4V, load current is limited to about 1500 mA.

SELECTING A CAPACITOR

It is important to note that capacitance tolerance and variation with temperature must be taken into consideration when selecting a capacitor so that the minimum required amount of capacitance is provided over the full operating temperature range.

Capacitor Characteristics

CERAMIC

For values of capacitance in the 10 to 100 μ F range, ceramics are usually larger and more costly than tantalums but give superior AC performance for bypassing high frequency noise because of very low ESR (typically less than 10 m Ω). However, some dielectric types do not have good capacitance characteristics as a function of voltage and temperature.

Z5U and Y5V dielectric ceramics have capacitance that drops severely with applied voltage. A typical Z5U or Y5V capacitor can lose 60% of its rated capacitance with half of the rated voltage applied to it. The Z5U and Y5V also exhibit a severe temperature effect, losing more than 50% of nominal capacitance at high and low limits of the temperature range.

X7R and X5R dielectric ceramic capacitors are strongly recommended if ceramics are used, as they typically maintain a capacitance range within $\pm 20\%$ of nominal over full operating ratings of temperature and voltage. Of course, they are typically larger and more costly than Z5U/Y5U types for a given voltage and capacitance.

TANTALUM

Solid Tantalum capacitors have good temperature stability: a high quality Tantalum will typically show a capacitance value that varies less than 10-15% across the full temperature range of -40°C to 125°C . ESR will vary only about 2X going from the high to low temperature limits.

The increasing ESR at lower temperatures can cause oscillations when marginal quality capacitors are used (if the ESR of the capacitor is near the upper limit of the stability range at room temperature).

REVERSE VOLTAGE

A reverse voltage condition will exist when the voltage at the output pin is higher than the voltage at the input pin. Typically this will happen when V_{IN} is abruptly taken low and C_{OUT} continues to hold a sufficient charge such that the input to output voltage becomes reversed. A less common condition is when an alternate voltage source is connected to the output.

There are two possible paths for current to flow from the output pin back to the input during a reverse voltage condition.

1) While V_{IN} is high enough to keep the control circuitry alive, and the Enable pin (LP38692-ADJ only) is above the $V_{\text{EN(ON)}}$ threshold, the control circuitry will attempt to regulate the output voltage. If the input voltage is less than the programmed output voltage, the control circuit will drive the gate of the pass element to the full ON condition. In this condition, reverse current will flow from the output pin to the input pin, limited only by the $R_{\text{DS(ON)}}$ of the pass element and the output to input voltage differential. Discharging an output capacitor up to 1000 μF in this manner will not damage the device as the current will rapidly decay. However, continuous reverse current should be avoided. When the Enable pin is low this condition will be prevented.

2) The internal PFET pass element has an inherent parasitic diode. During normal operation, the input voltage is higher than the output voltage and the parasitic diode is reverse biased. However, when V_{IN} is below the value where the control circuitry is alive, or the Enable pin is low (LP38692-ADJ only), and the output voltage is more than 500 mV (typical) above the input voltage the parasitic diode becomes forward biased and current flows from the output pin to the input pin through the diode. The current in the parasitic diode should be limited to less than 1A continuous and 5A peak.

If used in a dual-supply system where the regulator output load is returned to a negative supply, the output pin must be diode clamped to ground to limit the negative voltage transition. A Schottky diode is recommended for this protective clamp.

PCB LAYOUT

Good PC layout practices must be used or instability can be induced because of ground loops and voltage drops. The input and output capacitors must be directly connected to the input, output, and ground pins of the regulator using traces which do not have other currents flowing in them (Kelvin connect).

The best way to do this is to lay out C_{IN} and C_{OUT} near the device with short traces to the V_{IN} , V_{OUT} , and ground pins. The regulator ground pin should be connected to the external circuit ground so that the regulator and its capacitors have a "single point ground".

It should be noted that stability problems have been seen in applications where "vias" to an internal ground plane were used at the ground points of the IC and the input and output capacitors. This was caused by varying ground potentials at these nodes resulting from current flowing through the ground plane. Using a single point ground technique for the regulator and its capacitors fixed the problem. Since high current flows through the traces going into V_{IN} and coming from V_{OUT} , Kelvin connect the capacitor leads to these pins so there is no voltage drop in series with the input and output capacitors.

WSON MOUNTING

The NGG0006A (No Pullback) 6-Lead WSON package requires specific mounting techniques which are detailed in the TI [AN-1187 Application Report](#). Referring to the section **PCB Design Recommendations** (Page 5), it should be noted that the pad style which should be used with the WSON package is the NSMD (non-solder mask defined) type. Additionally, it is recommended the PCB terminal pads to be 0.2 mm longer than the package pads to create a solder fillet to improve reliability and inspection.

The input current is split between two V_{IN} pins, 1 and 6. The two V_{IN} pins must be connected together to ensure that the device can meet all specifications at the rated current.

The thermal dissipation of the WSON package is directly related to the printed circuit board construction and the amount of additional copper area connected to the DAP.

The DAP (exposed pad) on the bottom of the WSON package is connected to the die substrate with a conductive die attach adhesive. The DAP has no direct electrical (wire) connection to any of the pins. There is a parasitic PN junction between the die substrate and the device ground. As such, it is strongly recommend that the DAP be connected directly to the ground at device lead 2 (i.e. GND). Alternately, but not recommended, the DAP may be left floating (i.e. no electrical connection). The DAP must not be connected to any potential other than ground.

For the LP38690-ADJ and LP38692-ADJ in the NGG0006A 6-Lead WSON package, the junction-to-case thermal rating, θ_{JC} , is 10.4°C/W, where the case is the bottom of the package at the center of the DAP. The junction-to-ambient thermal performance for the LP38690-ADJ and LP38692-ADJ in the NGG0006A 6-Lead WSON package, using the JEDEC JESD51 standards is summarized in the following table:

| Board Type | Thermal Vias | θ_{JC} | θ_{JA} |
|----------------------------|--------------|---------------|---------------|
| JEDEC 2-Layer JESD 51-3 | None | 10.4°C/W | 237°C/W |
| JEDEC 4-Layer JESD 51-7 | 1 | 10.4°C/W | 74°C/W |
| | 2 | 10.4°C/W | 60°C/W |
| | 4 | 10.4°C/W | 49°C/W |
| | 6 | 10.4°C/W | 45°C/W |

RFI/EMI SUSCEPTIBILITY

RFI (radio frequency interference) and EMI (electromagnetic interference) can degrade any integrated circuit's performance because of the small dimensions of the geometries inside the device. In applications where circuit sources are present which generate signals with significant high frequency energy content (> 1 MHz), care must be taken to ensure that this does not affect the IC regulator.

If RFI/EMI noise is present on the input side of the regulator (such as applications where the input source comes from the output of a switching regulator), good ceramic bypass capacitors must be used at the input pin of the IC.

If a load is connected to the IC output which switches at high speed (such as a clock), the high-frequency current pulses required by the load must be supplied by the capacitors on the IC output. Since the bandwidth of the regulator loop is less than 100 kHz, the control circuitry cannot respond to load changes above that frequency. This means the effective output impedance of the IC at frequencies above 100 kHz is determined only by the output capacitor(s).

In applications where the load is switching at high speed, the output of the IC may need RF isolation from the load. It is recommended that some inductance be placed between the output capacitor and the load, and good RF bypass capacitors be placed directly across the load.

PCB layout is also critical in high noise environments, since RFI/EMI is easily radiated directly into PC traces. Noisy circuitry should be isolated from "clean" circuits where possible, and grounded through a separate path. At MHz frequencies, ground planes begin to look inductive and RFI/EMI can cause ground bounce across the ground plane. In multi-layer PCB applications, care should be taken in layout so that noisy power and ground planes do not radiate directly into adjacent layers which carry analog power and ground.

OUTPUT NOISE

Noise is specified in two ways- **Spot Noise** or **Output Noise** density is the RMS sum of all noise sources, measured at the regulator output, at a specific frequency (measured with a 1Hz bandwidth). This type of noise is usually plotted on a curve as a function of frequency. **Total Output Noise** or **Broad-Band Noise** is the RMS sum of spot noise over a specified bandwidth, usually several decades of frequencies.

Attention should be paid to the units of measurement. Spot noise is measured in units $\mu\text{V}/\sqrt{\text{Hz}}$ or $\text{nV}/\sqrt{\text{Hz}}$ and total output noise is measured in $\mu\text{V}(\text{rms})$

The primary source of noise in low-dropout regulators is the internal reference. Noise can be reduced in two ways: by increasing the transistor area or by increasing the current drawn by the internal reference. Increasing the area will decrease the chance of fitting the die into a smaller package. Increasing the current drawn by the internal reference increases the total supply current (ground pin current).

REVISION HISTORY

| Changes from Revision G (April 2013) to Revision H | Page |
|--|--------------------|
| • Changed layout of National Data Sheet to TI format | 14 |

PACKAGING INFORMATION

| Orderable part number | Status (1) | Material type (2) | Package Pins | Package qty Carrier | RoHS (3) | Lead finish/ Ball material (4) | MSL rating/ Peak reflow (5) | Op temp (°C) | Part marking (6) |
|-------------------------------------|---------------|----------------------|-------------------|-----------------------|-------------|--------------------------------------|-----------------------------------|--------------|---------------------|
| LP38690SD-ADJ/NOPB | Active | Production | WSON (NGG) 6 | 1000 SMALL T&R | Yes | NIPDAU SN | Level-1-260C-UNLIM | -40 to 125 | L112B |
| LP38690SD-ADJ/NOPB.A | Active | Production | WSON (NGG) 6 | 1000 SMALL T&R | Yes | SN | Level-1-260C-UNLIM | -40 to 125 | L112B |
| LP38690SD-ADJ/NOPB.B | Active | Production | WSON (NGG) 6 | 1000 SMALL T&R | Yes | SN | Level-1-260C-UNLIM | -40 to 125 | L112B |
| LP38690SDX-ADJ/NO.A | Active | Production | WSON (NGG) 6 | 4500 LARGE T&R | Yes | SN | Level-1-260C-UNLIM | -40 to 125 | L112B |
| LP38690SDX-ADJ/NOPB | Active | Production | WSON (NGG) 6 | 4500 LARGE T&R | Yes | NIPDAU SN | Level-1-260C-UNLIM | -40 to 125 | L112B |
| LP38692MP-ADJ/NOPB | Active | Production | SOT-223 (NDC) 5 | 1000 SMALL T&R | Yes | SN | Level-1-260C-UNLIM | -40 to 125 | LJNB |
| LP38692MP-ADJ/NOPB.A | Active | Production | SOT-223 (NDC) 5 | 1000 SMALL T&R | Yes | SN | Level-1-260C-UNLIM | -40 to 125 | LJNB |
| LP38692MP-ADJ/NOPB.B | Active | Production | SOT-223 (NDC) 5 | 1000 SMALL T&R | Yes | SN | Level-1-260C-UNLIM | -40 to 125 | LJNB |
| LP38692MPX-ADJ/NO.A | Active | Production | SOT-223 (NDC) 5 | 2000 LARGE T&R | Yes | SN | Level-1-260C-UNLIM | -40 to 125 | LJNB |
| LP38692MPX-ADJ/NO.B | Active | Production | SOT-223 (NDC) 5 | 2000 LARGE T&R | Yes | SN | Level-1-260C-UNLIM | -40 to 125 | LJNB |
| LP38692MPX-ADJ/NOPB | Active | Production | SOT-223 (NDC) 5 | 2000 LARGE T&R | Yes | SN | Level-1-260C-UNLIM | -40 to 125 | LJNB |
| LP38692SD-ADJ/NOPB | Active | Production | WSON (NGG) 6 | 1000 SMALL T&R | Yes | SN | Level-1-260C-UNLIM | -40 to 125 | L122B |
| LP38692SD-ADJ/NOPB.A | Active | Production | WSON (NGG) 6 | 1000 SMALL T&R | Yes | SN | Level-1-260C-UNLIM | -40 to 125 | L122B |
| LP38692SD-ADJ/NOPB.B | Active | Production | WSON (NGG) 6 | 1000 SMALL T&R | Yes | SN | Level-1-260C-UNLIM | -40 to 125 | L122B |
| LP38692SDX-ADJ/NO.A | Active | Production | WSON (NGG) 6 | 4500 LARGE T&R | Yes | SN | Level-1-260C-UNLIM | -40 to 125 | L122B |
| LP38692SDX-ADJ/NOPB | Active | Production | WSON (NGG) 6 | 4500 LARGE T&R | Yes | SN | Level-1-260C-UNLIM | -40 to 125 | L122B |

(1) **Status:** For more details on status, see our [product life cycle](#).

(2) **Material type:** When designated, preproduction parts are prototypes/experimental devices, and are not yet approved or released for full production. Testing and final process, including without limitation quality assurance, reliability performance testing, and/or process qualification, may not yet be complete, and this item is subject to further changes or possible discontinuation. If available for ordering, purchases will be subject to an additional waiver at checkout, and are intended for early internal evaluation purposes only. These items are sold without warranties of any kind.

(3) **RoHS values:** Yes, No, RoHS Exempt. See the [TI RoHS Statement](#) for additional information and value definition.

(4) **Lead finish/Ball material:** Parts may have multiple material finish options. Finish options are separated by a vertical ruled line. Lead finish/Ball material values may wrap to two lines if the finish value exceeds the maximum column width.

(5) **MSL rating/Peak reflow:** The moisture sensitivity level ratings and peak solder (reflow) temperatures. In the event that a part has multiple moisture sensitivity ratings, only the lowest level per JEDEC standards is shown. Refer to the shipping label for the actual reflow temperature that will be used to mount the part to the printed circuit board.

(6) Part marking: There may be an additional marking, which relates to the logo, the lot trace code information, or the environmental category of the part.

Multiple part markings will be inside parentheses. Only one part marking contained in parentheses and separated by a "-" will appear on a part. If a line is indented then it is a continuation of the previous line and the two combined represent the entire part marking for that device.

Important Information and Disclaimer:The information provided on this page represents TI's knowledge and belief as of the date that it is provided. TI bases its knowledge and belief on information provided by third parties, and makes no representation or warranty as to the accuracy of such information. Efforts are underway to better integrate information from third parties. TI has taken and continues to take reasonable steps to provide representative and accurate information but may not have conducted destructive testing or chemical analysis on incoming materials and chemicals. TI and TI suppliers consider certain information to be proprietary, and thus CAS numbers and other limited information may not be available for release.

In no event shall TI's liability arising out of such information exceed the total purchase price of the TI part(s) at issue in this document sold by TI to Customer on an annual basis.

TAPE AND REEL INFORMATION

QUADRANT ASSIGNMENTS FOR PIN 1 ORIENTATION IN TAPE

*All dimensions are nominal

| Device | Package Type | Package Drawing | Pins | SPQ | Reel Diameter (mm) | Reel Width W1 (mm) | A0 (mm) | B0 (mm) | K0 (mm) | P1 (mm) | W (mm) | Pin1 Quadrant |
|---------------------|--------------|-----------------|------|------|--------------------|--------------------|---------|---------|---------|---------|--------|---------------|
| LP38690SD-ADJ/NOPB | WSON | NGG | 6 | 1000 | 177.8 | 12.4 | 3.3 | 3.3 | 1.0 | 8.0 | 12.0 | Q1 |
| LP38690SDX-ADJ/NOPB | WSON | NGG | 6 | 4500 | 330.0 | 12.4 | 3.3 | 3.3 | 1.0 | 8.0 | 12.0 | Q1 |
| LP38692MP-ADJ/NOPB | SOT-223 | NDC | 5 | 1000 | 330.0 | 16.4 | 7.0 | 7.5 | 2.2 | 12.0 | 16.0 | Q3 |
| LP38692MPX-ADJ/NOPB | SOT-223 | NDC | 5 | 2000 | 330.0 | 16.4 | 7.0 | 7.5 | 2.2 | 12.0 | 16.0 | Q3 |
| LP38692SD-ADJ/NOPB | WSON | NGG | 6 | 1000 | 177.8 | 12.4 | 3.3 | 3.3 | 1.0 | 8.0 | 12.0 | Q1 |
| LP38692SDX-ADJ/NOPB | WSON | NGG | 6 | 4500 | 330.0 | 12.4 | 3.3 | 3.3 | 1.0 | 8.0 | 12.0 | Q1 |

TAPE AND REEL BOX DIMENSIONS

*All dimensions are nominal

| Device | Package Type | Package Drawing | Pins | SPQ | Length (mm) | Width (mm) | Height (mm) |
|---------------------|--------------|-----------------|------|------|-------------|------------|-------------|
| LP38690SD-ADJ/NOPB | WSON | NGG | 6 | 1000 | 208.0 | 191.0 | 35.0 |
| LP38690SDX-ADJ/NOPB | WSON | NGG | 6 | 4500 | 367.0 | 367.0 | 35.0 |
| LP38692MP-ADJ/NOPB | SOT-223 | NDC | 5 | 1000 | 367.0 | 367.0 | 35.0 |
| LP38692MPX-ADJ/NOPB | SOT-223 | NDC | 5 | 2000 | 367.0 | 367.0 | 35.0 |
| LP38692SD-ADJ/NOPB | WSON | NGG | 6 | 1000 | 208.0 | 191.0 | 35.0 |
| LP38692SDX-ADJ/NOPB | WSON | NGG | 6 | 4500 | 367.0 | 367.0 | 35.0 |

NDC0005A

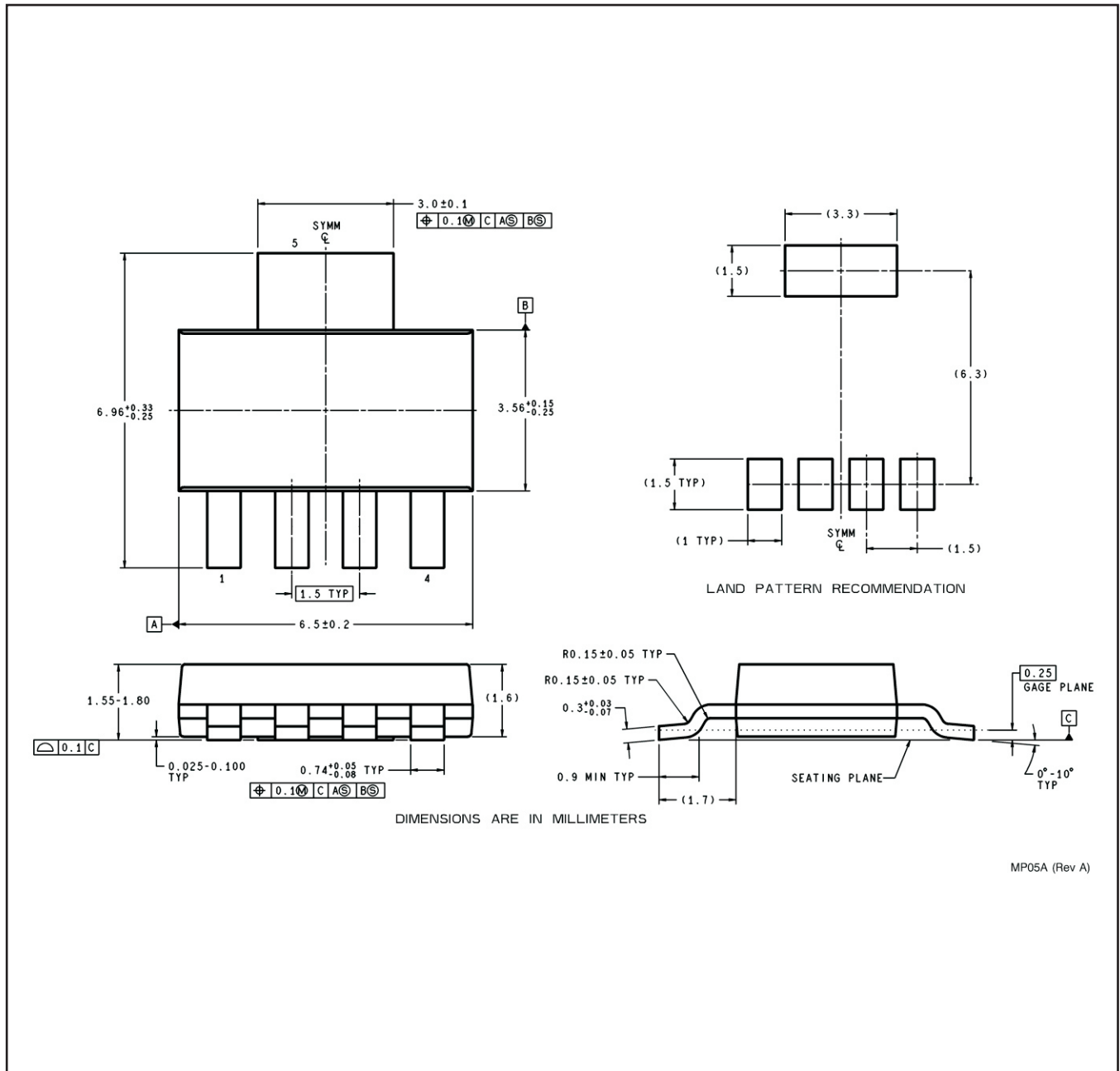

MP05A (Rev A)

NGG0006A

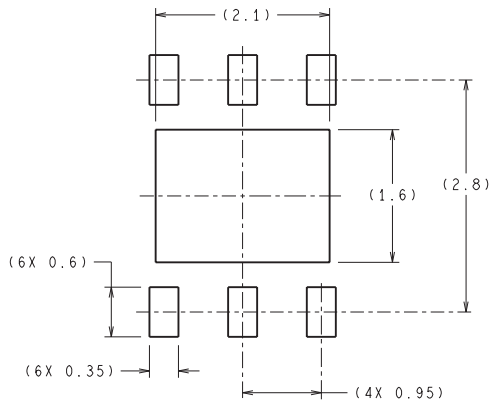

RECOMMENDED LAND PATTERN

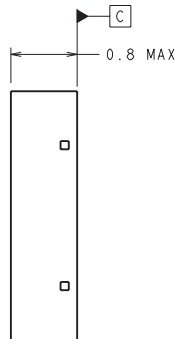
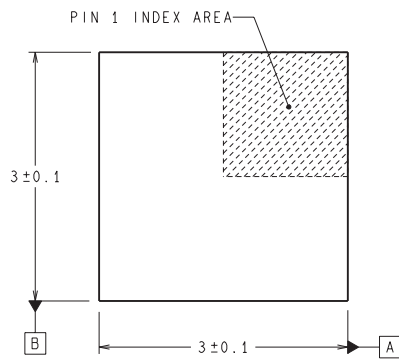

DIMENSIONS ARE IN MILLIMETERS
DIMENSION IN () FOR REFERENCE ONLY

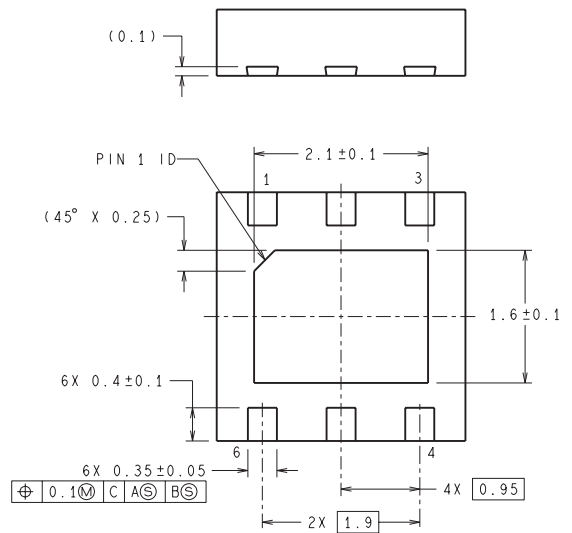

SDE06A (Rev A)

重要通知和免责声明

TI“按原样”提供技术和可靠性数据（包括数据表）、设计资源（包括参考设计）、应用或其他设计建议、网络工具、安全信息和其他资源，不保证没有瑕疵且不做任何明示或暗示的担保，包括但不限于对适销性、某特定用途方面的适用性或不侵犯任何第三方知识产权的暗示担保。

这些资源可供使用 TI 产品进行设计的熟练开发人员使用。您将自行承担以下全部责任：(1) 针对您的应用选择合适的 TI 产品，(2) 设计、验证并测试您的应用，(3) 确保您的应用满足相应标准以及任何其他功能安全、信息安全、监管或其他要求。

这些资源如有变更，恕不另行通知。TI 授权您仅可将这些资源用于研发本资源所述的 TI 产品的相关应用。严禁以其他方式对这些资源进行复制或展示。您无权使用任何其他 TI 知识产权或任何第三方知识产权。您应全额赔偿因在这些资源的使用中对 TI 及其代表造成的任何索赔、损害、成本、损失和债务，TI 对此概不负责。

TI 提供的产品受 [TI 的销售条款](#) 或 [ti.com](#) 上其他适用条款/TI 产品随附的其他适用条款的约束。TI 提供这些资源并不会扩展或以其他方式更改 TI 针对 TI 产品发布的适用的担保或担保免责声明。

TI 反对并拒绝您可能提出的任何其他或不同的条款。

邮寄地址：Texas Instruments, Post Office Box 655303, Dallas, Texas 75265
版权所有 © 2025，德州仪器 (TI) 公司