

LP2980-ADJ 16V、50mA、低功耗、可调节低压降稳压器

1 特性

- V_{IN} 范围：
 - 旧芯片：2.2V 至 16V
 - 新芯片：2.5V 至 16V
- V_{OUT} 范围：
 - 旧芯片：1.23V 至 15.0V
 - 新芯片：1.2V 至 15.0V
- V_{OUT} 精度（典型值）：
 - 旧芯片： $\pm 1\%$
 - 新芯片： $\pm 0.5\%$
- 在整个负载和温度范围内的输出精度：
 - 旧芯片： $\pm 3.5\%$
 - 新芯片： $\pm 1\%$
- 输出电流：高达 50mA
- 静态电流，低 I_Q （新芯片）：
 - $I_{LOAD} = 0 \text{ mA}$ 时为 $55 \mu\text{A}$
 - $I_{LOAD} = 50 \text{ mA}$ 时为 $350 \mu\text{A}$
- 关断电流与温度间的关系：
 - 旧芯片： $< 1 \mu\text{A}$
 - 新芯片： $\leq 0.8 \mu\text{A}$
- 输出电流限制和热保护
- 使用 $2.2\mu\text{F}$ 陶瓷电容器实现稳定工作（新芯片）
- 高 PSRR（新芯片）：
 - 1kHz 频率下为 70dB，1MHz 频率下为 42dB
- 工作结温： -40°C 至 $+125^\circ\text{C}$
- 封装：5 引脚 SOT-23 (DBV)

2 应用

- 家用断路器
- 固态硬盘 (SSD)
- 电表
- 电器
- 楼宇自动化

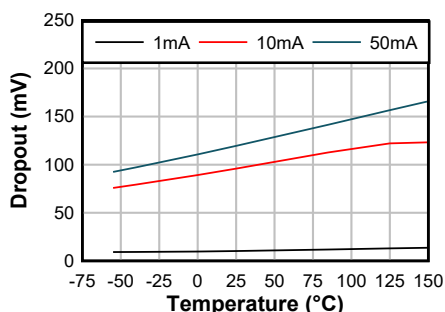

新芯片的压降电压与温度间的关系

3 说明

LP2980-ADJ 是一款可调输出、宽输入、低压降稳压器，支持高达 16V 的输入电压和高达 50mA 的负载电流。LP2980-ADJ 支持 1.2V 至 15.0V（新芯片）和 1.23V 至 15.0V（旧芯片）的输出范围。

此外，LP2980-ADJ（新芯片）在整个负载和温度范围内具有 1% 的输出精度，可满足低压微控制器 (MCU) 和处理器的需求。

在该新芯片中，高带宽 PSRR 性能在 1kHz 时大于 70dB，在 1MHz 时大于 45dB，因此有助于衰减上游直流/直流转换器的开关频率，并尽可能地减少后置稳压器滤波。

内部软启动时间和电流限制保护可减小启动期间的浪涌电流，从而尽可能降低输入电容。还包括标准保护特性，例如过流和过热保护。

LP2980-ADJ 采用 5 引脚、2.9mm × 1.6mm SOT-23 (DBV) 封装。

封装信息

| 器件型号 | 封装 ⁽¹⁾ | 封装尺寸 ⁽²⁾ |
|------------|-------------------|---------------------|
| LP2980-ADJ | DBV (SOT-23, 5) | 2.9mm × 2.8mm |

- (1) 如需了解所有可用封装，请参阅数据表末尾的可订购产品目录。
- (2) 封装尺寸（长 × 宽）为标称值，并包括引脚（如适用）。

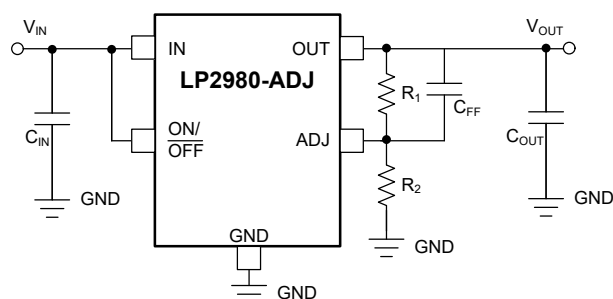

典型应用电路



Table of Contents

| | | | |
|-----------------------------------------------|-----------|------------------------------------------------|-----------|
| 1 特性..... | 1 | 7.4 Device Functional Modes..... | 19 |
| 2 应用..... | 1 | 8 Application and Implementation..... | 21 |
| 3 说明..... | 1 | 8.1 Application Information..... | 21 |
| 4 Revision History..... | 2 | 8.2 Typical Application..... | 25 |
| 5 Pin Configuration and Functions..... | 3 | 8.3 Power Supply Recommendations..... | 28 |
| 6 Specifications..... | 4 | 8.4 Layout..... | 28 |
| 6.1 Absolute Maximum Ratings..... | 4 | 9 Device and Documentation Support..... | 29 |
| 6.2 ESD Ratings..... | 4 | 9.1 Device Support..... | 29 |
| 6.3 Recommended Operating Conditions..... | 5 | 9.2 接收文档更新通知..... | 29 |
| 6.4 Thermal Information..... | 5 | 9.3 支持资源..... | 29 |
| 6.5 Electrical Characteristics..... | 6 | 9.4 Trademarks..... | 29 |
| 6.6 Typical Characteristics..... | 9 | 9.5 静电放电警告..... | 29 |
| 7 Detailed Description..... | 17 | 9.6 术语表..... | 29 |
| 7.1 Overview..... | 17 | 10 Mechanical, Packaging, and Orderable | |
| 7.2 Functional Block Diagram..... | 17 | Information..... | 29 |
| 7.3 Feature Description..... | 17 | | |

4 Revision History

注：以前版本的页码可能与当前版本的页码不同

| Changes from Revision E (April 2013) to Revision F (July 2023) | Page |
|-------------------------------------------------------------------------------------------------------------------------------------|------|
| • 添加了 ESD 等级表、概述部分、特性说明部分、器件功能模式部分、应用和实施部分、典型应用部分、电源建议部分、布局部分、器件和文档支持部分，以及机械、封装和可订购信息部分..... | 1 |
| • 在文档中添加了新芯片 (M3 后缀) 信息..... | 1 |
| • 更改了文档标题以及特性、应用和说明部分..... | 1 |
| • 删除了应用提示部分..... | 1 |
| • Changed <i>Pin Configuration and Functions</i> title and section..... | 3 |
| • Changed title, condition statement, and curve titles and added curves for new chip in <i>Typical Characteristics</i> section..... | 9 |
| • Changed <i>Functional Block Diagram</i> figure..... | 17 |
| • Added <i>Device Nomenclature</i> section..... | 29 |
| Changes from Revision D (April 2013) to Revision E (April 2013) | Page |
| • Changed layout of National Data Sheet to TI format..... | 26 |

5 Pin Configuration and Functions



图 5-1. DBV Package, 5-Pin SOT-23 (Top View)

表 5-1. Pin Functions

| PIN | | TYPE | DESCRIPTION |
|-----------|-----|------|-----------------------------------------------------------------------------------------------------------------------------------------------------------------------------------------------------------------------------------------------------------------------------------|
| NAME | NO. | | |
| ADJ | 4 | I/O | Feedback pin to set the output voltage with help of the feedback divider. See the Recommended Operating Conditions section for more information. |
| GND | 2 | — | Ground |
| ON/OFF | 3 | I | Enable pin for the LDO. Driving the ON/OFF pin high enables the device. Driving this pin low disables the device. High and low thresholds are listed in the Electrical Characteristics table. Tie this pin to V_{IN} if unused. |
| V_{IN} | 1 | I | Input supply pin. Use a capacitor with a value of 1 μF or larger from this pin to ground. See the Input and Output Capacitor Requirements section for more information. |
| V_{OUT} | 5 | O | Output of the regulator. Use a capacitor with a value of 4.7 μF (for legacy chip) and 2.2 μF (for new chip) or larger from this pin to ground. ⁽¹⁾ See the Input and Output Capacitor Requirements section for more information. |

- (1) The nominal output capacitance must be greater than 1 μF (for the new chip) and 2.2 μF (for the legacy chip). Throughout this document, the nominal derating on these capacitors is 50%. Make sure that the effective capacitance at the pin is greater than 1 μF (for the new chip) and 2.2 μF (for the legacy chip).

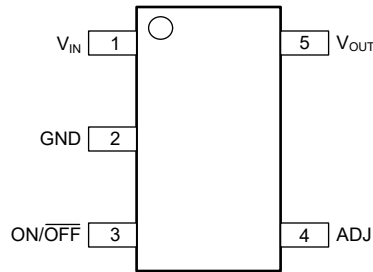
6 Specifications

6.1 Absolute Maximum Ratings

over operating free-air temperature range (unless otherwise noted)^{(1) (2)}

| | | MIN | MAX | UNIT | |
|---------------------------------------------------|--------------------------------------------------|--------------------|----------------------------------------------------|------|----|
| V _{IN} | Continuous input voltage range (for legacy chip) | - 0.3 | 16 | V | |
| | Continuous input voltage range (for new chip) | - 0.3 | 18 | | |
| V _{OUT} | Output voltage range (for legacy chip) | - 0.3 | 16 | | |
| | Output voltage range (for new chip) | - 0.3 | V _{IN} + 0.3 or 18 (whichever is smaller) | | |
| V _{ADJ} | ADJ pin voltage range (for new chip) | - 0.3 | 3 | | |
| V _{IN} - V _{OUT} ⁽³⁾ | Input - Output voltage (for legacy chip) | - 0.3 | 16 | | |
| V _{ON/OFF} | ON/OFF pin voltage range (for legacy chip) | - 0.3 | 16 | | |
| | ON/OFF pin voltage range (for new chip) | - 0.3 | 18 | | |
| Current | Maximum output | Internally limited | | | A |
| Temperature | Operating junction, T _J | - 55 | 150 | | °C |
| | Storage, T _{stg} | - 65 | 150 | | |

- (1) Stresses beyond those listed under *Absolute Maximum Ratings* may cause permanent damage to the device. These are stress ratings only, which do not imply functional operation of the device at these or any other conditions beyond those indicated under *Recommended Operating Conditions*. Exposure to absolute-maximum-rated conditions for extended periods may affect device reliability.
- (2) All voltages with respect to GND.
- (3) In legacy chip, the output PNP structure contains a diode between the V_{IN} and V_{OUT} terminals that is normally reverse-biased. Reversing the polarity from V_{IN} to V_{OUT} will turn on this diode

6.2 ESD Ratings

| | | | VALUE (Legacy Chip) | VALUE (New Chip) | UNIT |
|--------------------|-------------------------|--------------------------------------------------------------------------------|---------------------------|------------------------|------|
| V _(ESD) | Electrostatic discharge | Human body model (HBM), per ANSI/ESDA/JEDEC JS-001 ⁽¹⁾ | ±2000 | ±3000 | V |
| | | Charged device model (CDM), per JEDEC specification JESD22-C101 ⁽²⁾ | NA | ±1000 | |

- (1) JEDEC document JEP155 states that 2-kV HBM allows safe manufacturing with a standard ESD control process.
- (2) JEDEC document JEP157 states that 500-V CDM allows safe manufacturing with a standard ESD control process.

6.3 Recommended Operating Conditions

| | | MIN | NOM | MAX | UNIT | |
|--------------------------------|---------------------------------------------------|-------|-------|-----------------|------|-----|
| V _{IN} | Supply input voltage (for legacy chip) | 2.2 | | 16 | V | |
| | Supply input voltage (for new chip) | 2.5 | | 16 | | |
| V _{OUT} | Output voltage (for legacy chip) | 1.225 | | 15.0 | | |
| | Output voltage (for new chip) | 1.2 | | 15.0 | | |
| V _{ADJ} | ADJ voltage (for legacy chip) | | 1.225 | | | |
| | ADJ voltage (for new chip) | | 1.2 | | | |
| V _{ON/OFF} | Enable voltage (for legacy chip) | 0 | | V _{IN} | | |
| | Enable voltage (for new chip) | 0 | | 16 | | |
| I _{OUT} | Output current | 0 | | 50 | | mA |
| C _{IN} ⁽³⁾ | Input capacitor | | 1 | | | μ F |
| C _{OUT} | Output capacitor (for legacy chip) ⁽²⁾ | 2.2 | 4.7 | | | |
| | Output capacitance (for new chip) ⁽¹⁾ | 1 | 2.2 | 200 | | |
| C _{FF} ⁽⁴⁾ | Feed-forward capacitor (for legacy chip) | | 7 | | pF | |
| | Feed-forward capacitor (for new chip) | | 10 | | | |
| T _J | Operating junction temperature | - 40 | | 125 | °C | |

- (1) For new chip, all capacitor values are assumed to derate to 50% of the nominal capacitor value. Maintain an effective output capacitance of 1 μ F minimum for stability.
- (2) For legacy chip, minimum output capacitance of 2.2 μ F is required with ESR range suggested in the *Recommended Capacitor Types* section
- (3) For legacy chip, an input capacitor of value ≥ 1 μ F is required. It must be located not more than 0.5" from the input pin and returned to a clean analog ground.
- (4) Regarding the requirement of feed-forward capacitor (C_{FF}), see the *Feed-Forward Capacitor* section.

6.4 Thermal Information

| THERMAL METRIC ⁽²⁾ ⁽¹⁾ | | Legacy Chip | New Chip | UNIT |
|----------------------------------------------|----------------------------------------------|---------------|---------------|------|
| | | DBV (SOT23-5) | DBV (SOT23-5) | |
| | | 5 PINS | 5 PINS | |
| R _{θJA} | Junction-to-ambient thermal resistance | 205.4 | 178.6 | °C/W |
| R _{θJC(top)} | Junction-to-case (top) thermal resistance | 78.8 | 77.9 | °C/W |
| R _{θJB} | Junction-to-board thermal resistance | 46.7 | 47.2 | °C/W |
| ψ _{JT} | Junction-to-top characterization parameter | 8.3 | 15.9 | °C/W |
| ψ _{JB} | Junction-to-board characterization parameter | 46.3 | 46.9 | °C/W |

- (1) For more information about traditional and new thermal metrics, see the [Semiconductor and IC Package Thermal Metrics](#) application note.
- (2) Thermal performance results are based on the JEDEC standard of 2s2p PCB configuration. These thermal metric parameters can be further improved by 35-55% based on thermally optimized PCB layout designs. See the analysis of the [Impact of board layout on LDO thermal performance](#) application report.

6.5 Electrical Characteristics

specified at $T_J = 25^\circ\text{C}$, $V_{IN} = V_{OUT(nom)} + 1.0\text{ V}$ or $V_{IN} = 2.5\text{ V}$ (whichever is greater), $I_{OUT} = 1\text{ mA}$, $V_{ON/OFF} = 2\text{ V}$, $C_{IN} = 1.0\text{ }\mu\text{F}$, and $C_{OUT} = 2.2\text{ }\mu\text{F}$ (unless otherwise noted)

| PARAMETER | | TEST CONDITIONS | MIN | TYP | MAX | UNIT | |
|--------------------------------|-----------------------------------|-----------------|--------------------------------------------------------------------------------------------------------------------------------------|--------|-------|--------|---|
| V_{REF} | Reference Voltage | Legacy Chip | $I_L = 1\text{ mA}$ | 1.213 | 1.225 | 1.237 | V |
| | | New Chip | | 1.194 | 1.2 | 1.206 | |
| | | Legacy Chip | $1\text{ mA} < I_L < 50\text{ mA}$, $V_{OUT} + 1 \leq V_{IN} \leq 16\text{V}$, $T_J = 25^\circ\text{C}$ | 1.206 | 1.225 | 1.243 | |
| | | New Chip | | 1.1928 | 1.2 | 1.206 | |
| | | Legacy Chip | $1\text{ mA} < I_L < 50\text{ mA}$, $V_{OUT} + 1 \leq V_{IN} \leq 16\text{V}$, $-40^\circ\text{C} \leq T_J \leq 125^\circ\text{C}$ | 1.182 | 1.225 | 1.268 | |
| | | New Chip | | 1.1892 | 1.2 | 1.2108 | |
| $\Delta V_{REF}/\Delta V_{IN}$ | Reference Voltage Line Regulation | Legacy Chip | $2.5\text{V} \leq V_{IN} \leq 16\text{V}$, $T_J = 25^\circ\text{C}$ | 3.0 | 6.0 | mV | |
| | | New Chip | | -0.5 | 4.0 | | |
| | | Legacy Chip | $2.5\text{V} \leq V_{IN} \leq 16\text{V}$, $-40^\circ\text{C} \leq T_J \leq 125^\circ\text{C}$ | | 15.0 | | |
| | | New Chip | | | 4.25 | | |
| $V_{IN} - V_{OUT}$ | Dropout voltage | Legacy Chip | $I_L = 0\text{ mA}$ | 1 | 3 | mV | |
| | | New Chip | | 1 | 3.5 | | |
| | | Legacy Chip | $I_L = 0\text{ mA}$, $-40^\circ\text{C} \leq T_J \leq 125^\circ\text{C}$ | | 5 | | |
| | | New Chip | | | 5.5 | | |
| | | Legacy Chip | $I_L = 1\text{ mA}$ | 7 | 10 | | |
| | | New Chip | | 10.5 | 15.5 | | |
| | | Legacy Chip | $I_L = 1\text{ mA}$, $-40^\circ\text{C} \leq T_J \leq 125^\circ\text{C}$ | | 15 | | |
| | | New Chip | | | 18.5 | | |
| | | Legacy Chip | $I_L = 10\text{ mA}$ | 40 | 60 | | |
| | | New Chip | | 95 | 115 | | |
| | | Legacy Chip | $I_L = 10\text{ mA}$, $-40^\circ\text{C} \leq T_J \leq 125^\circ\text{C}$ | | 90 | | |
| | | New Chip | | | 148 | | |
| | | Legacy Chip | $I_L = 50\text{ mA}$ | 120 | 150 | | |
| | | New Chip | | 120 | 145 | | |
| | | Legacy Chip | $I_L = 50\text{ mA}$, $-40^\circ\text{C} \leq T_J \leq 125^\circ\text{C}$ | | 225 | | |
| | | New Chip | | | 184 | | |

6.5 Electrical Characteristics (continued)

specified at $T_J = 25^\circ\text{C}$, $V_{IN} = V_{OUT(nom)} + 1.0\text{ V}$ or $V_{IN} = 2.5\text{ V}$ (whichever is greater), $I_{OUT} = 1\text{ mA}$, $V_{ON/OFF} = 2\text{ V}$, $C_{IN} = 1.0\ \mu\text{F}$, and $C_{OUT} = 2.2\ \mu\text{F}$ (unless otherwise noted)

| PARAMETER | | TEST CONDITIONS | | MIN | TYP | MAX | UNIT | |
|------------------|-----------------------------------------------------------------------------------------------------------|-----------------|-------------------------------------------------------------------------|-----|-----------------------------------------------------|------|---------------|-------|
| I_{GND} | Ground Pin Current | Legacy Chip | $I_L = 0\text{ mA}$ | | 60 | 95 | μA | |
| | | New Chip | | | 55 | 70 | | |
| | | Legacy Chip | $I_L = 0\text{ mA}, -40^\circ\text{C} \leq T_J \leq 125^\circ\text{C}$ | | | 125 | | |
| | | New Chip | | | | 90 | | |
| | | Legacy Chip | $I_L = 1\text{ mA}$ | | 80 | 110 | | |
| | | New Chip | | | 70 | 82 | | |
| | | Legacy Chip | $I_L = 1\text{ mA}, -40^\circ\text{C} \leq T_J \leq 125^\circ\text{C}$ | | | 170 | | |
| | | New Chip | | | | 105 | | |
| | | Legacy Chip | $I_L = 10\text{ mA}$ | | 120 | 220 | | |
| | | New Chip | | | 150 | 188 | | |
| | | Legacy Chip | $I_L = 10\text{ mA}, -40^\circ\text{C} \leq T_J \leq 125^\circ\text{C}$ | | | 460 | | |
| | | New Chip | | | | 220 | | |
| | | Legacy Chip | $I_L = 50\text{ mA}$ | | 320 | 600 | | |
| | | New Chip | | | 350 | 420 | | |
| | | Legacy Chip | $I_L = 50\text{ mA}, -40^\circ\text{C} \leq T_J \leq 125^\circ\text{C}$ | | | 1200 | | |
| | | New Chip | | | | 600 | | |
| Legacy Chip | $V_{ON/OFF} < 0.18\text{ V}, V_{IN} \leq 4.3\text{ V}, -40^\circ\text{C} \leq T_J \leq 125^\circ\text{C}$ | | 0.01 | 1 | | | | |
| New Chip | | | 0.2 | 0.8 | | | | |
| New Chip | $V_{ON/OFF} < 0.18\text{ V}, V_{IN} = 16\text{ V}, -40^\circ\text{C} \leq T_J \leq 125^\circ\text{C}$ | | | 2.5 | | | | |
| I_{ADJ} | ADJ Pin Bias Current | Legacy Chip | $1\text{ mA} \leq I_L \leq 50\text{ mA}$ | | 150 | 350 | nA | |
| | | New Chip | | | 0.35 | 30 | | |
| V_{UVLO+} | Rising bias supply UVLO | New Chip | V_{IN} rising, $-40^\circ\text{C} \leq T_J \leq 125^\circ\text{C}$ | | 2.2 | 2.4 | V | |
| V_{UVLO-} | Falling bias supply UVLO | | | | 1.9 | 2.07 | | |
| $V_{UVLO(HYST)}$ | UVLO hysteresis | | | | $-40^\circ\text{C} \leq T_J \leq 125^\circ\text{C}$ | | | 0.130 |
| $V_{ON/OFF}$ | ON/OFF input voltage | Legacy Chip | High = O/P ON | | 1.6 | 1.4 | V | |
| | | | Low = O/P OFF | | 0.55 | 0.18 | | |
| | | New Chip | High = O/P ON | | 1.6 | 0.82 | | |
| | | | Low = O/P OFF | | 0.7 | 0.18 | | |
| $I_{ON/OFF}$ | ON/OFF input Current | Legacy Chip | $V_{ON/OFF} = 0$ | | 0.01 | -1 | μA | |
| | | | $V_{ON/OFF} = 5\text{ V}$ | | 5 | 15 | | |
| | | New Chip | $V_{ON/OFF} = 0$ | | -0.35 | -0.7 | | |
| | | | $V_{ON/OFF} = 5\text{ V}$ | | 0.008 | 0.5 | | |
| $I_O(PK)$ | Peak Output Current | Legacy Chip | $V_{OUT} \geq V_O(NOM) - 5\%$ | | 100 | 150 | mA | |
| | | New Chip | | | 130 | 150 | | |
| $I_O(MAX)$ | Short Circuit Current | Legacy Chip | $R_L = 0$ (Steady State) | | 150 | | mA | |
| | | New Chip | | | 160 | | | |
| e_n | Output Noise Voltage (RMS) | Legacy Chip | $BW = 300\text{ Hz to }50\text{ kHz}, C_{OUT} = 10\ \mu\text{F}$ | | 160 | | μV | |
| | | New Chip | $BW = 300\text{ Hz to }50\text{ kHz}, C_{OUT} = 2.2\ \mu\text{F}$ | | 160 | | | |
| | | | $BW = 10\text{ Hz to }100\text{ kHz}, C_{OUT} = 2.2\ \mu\text{F}$ | | 220 | | | |

6.5 Electrical Characteristics (continued)

specified at $T_J = 25^\circ\text{C}$, $V_{IN} = V_{OUT(nom)} + 1.0\text{ V}$ or $V_{IN} = 2.5\text{ V}$ (whichever is greater), $I_{OUT} = 1\text{ mA}$, $V_{ON/OFF} = 2\text{ V}$, $C_{IN} = 1.0\ \mu\text{F}$, and $C_{OUT} = 2.2\ \mu\text{F}$ (unless otherwise noted)

| PARAMETER | | TEST CONDITIONS | | MIN | TYP | MAX | UNIT |
|----------------------------------------|----------------------------|-----------------|-----------------------------------------------------|-----|-----|-----|------------------|
| $\frac{\Delta V_{OUT}}{\Delta V_{IN}}$ | Ripple Rejection | Legacy Chip | $f = 1\text{ kHz}$, $C_{OUT} = 10\ \mu\text{F}$ | | 68 | | dB |
| | | New Chip | $f = 1\text{ kHz}$, $C_{OUT} = 2.2\ \mu\text{F}$ | | 68 | | |
| | | | $f = 100\text{ kHz}$, $C_{OUT} = 2.2\ \mu\text{F}$ | | 45 | | |
| $T_{sd(\text{shutdo wn})}$ | Thermal shutdown threshold | New Chip | Shutdown, temperature increasing | | 170 | | $^\circ\text{C}$ |
| $T_{sd(\text{reset})}$ | | | Reset, temperature decreasing | | 150 | | |

6.6 Typical Characteristics

at operating temperature $T_J = 25^\circ\text{C}$, $V_{IN} = V_{OUT(NOM)} + 1.0\text{ V}$ or 2.5 V (whichever is greater), $I_{OUT} = 1\text{ mA}$, ON/OFF pin tied to V_{IN} , $C_{IN} = 1.0\text{ }\mu\text{F}$, and $C_{OUT} = 4.7\text{ }\mu\text{F}$ (unless otherwise noted)



图 6-1. Output Voltage vs Temperature for Legacy Chip



图 6-2. Output Voltage vs Temperature for New Chip

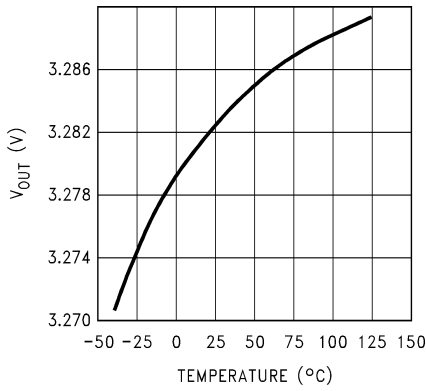

图 6-3. Output Voltage vs V_{IN} for Legacy Chip

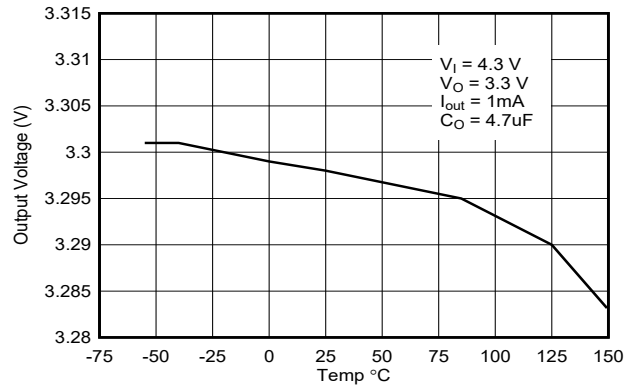

图 6-4. Output Voltage vs V_{IN} for New Chip

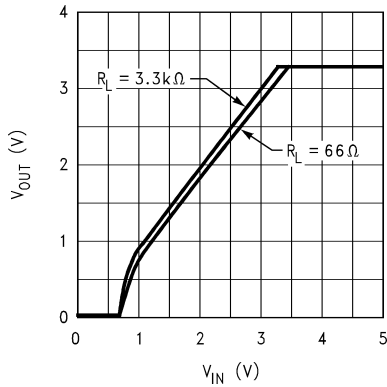

图 6-5. Dropout Voltage vs V_{IN} for New Chip

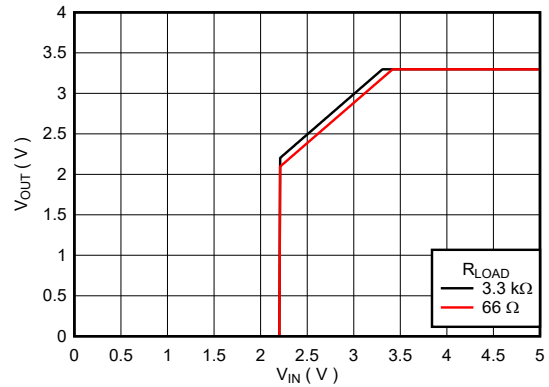

图 6-6. Dropout Voltage vs V_{IN} and Temperature for New Chip

6.6 Typical Characteristics (continued)

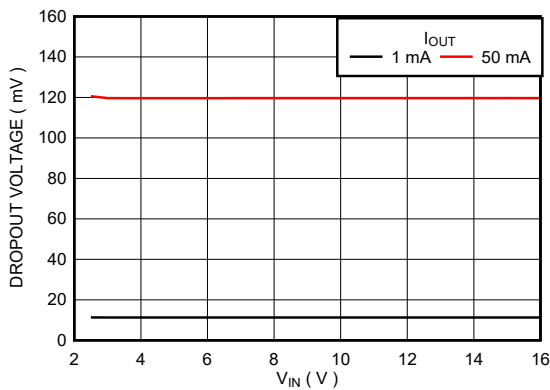
at operating temperature $T_J = 25^\circ\text{C}$, $V_{IN} = V_{OUT(NOM)} + 1.0\text{ V}$ or 2.5 V (whichever is greater), $I_{OUT} = 1\text{ mA}$, ON/OFF pin tied to V_{IN} , $C_{IN} = 1.0\ \mu\text{F}$, and $C_{OUT} = 4.7\ \mu\text{F}$ (unless otherwise noted)

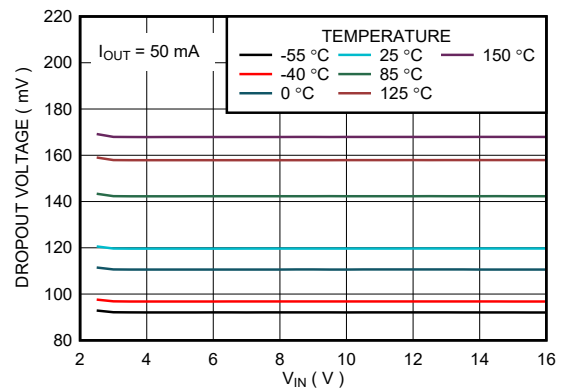

图 6-7. Dropout Voltage vs Temperature for Legacy Chip



图 6-8. Dropout Voltage vs Temperature for New Chip

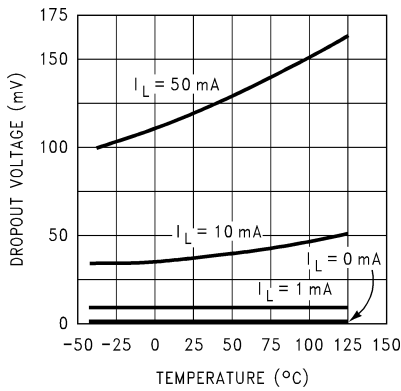

图 6-9. Dropout Voltage vs Load Current for Legacy Chip

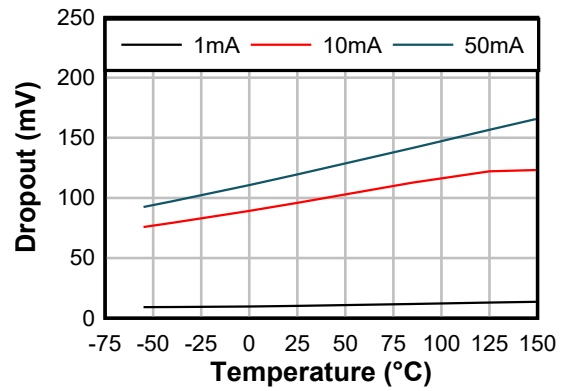

图 6-10. Dropout Voltage vs Load Current for New Chip

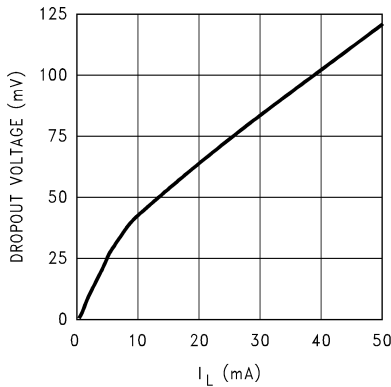

图 6-11. Output Regulation vs Load Current for Legacy Chip

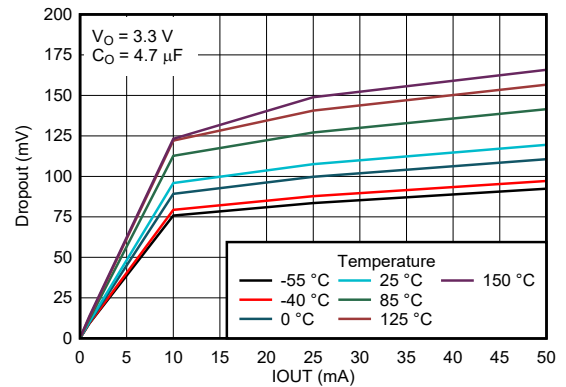

图 6-12. Output Regulation vs Load Current for New Chip

6.6 Typical Characteristics (continued)

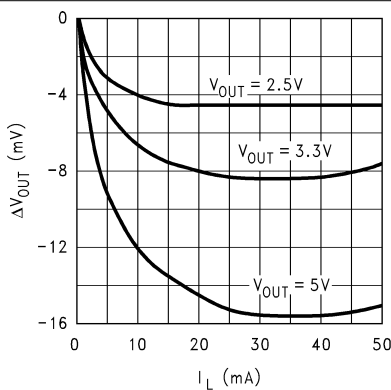
at operating temperature $T_J = 25^\circ\text{C}$, $V_{IN} = V_{OUT(NOM)} + 1.0\text{ V}$ or 2.5 V (whichever is greater), $I_{OUT} = 1\text{ mA}$, ON/OFF pin tied to V_{IN} , $C_{IN} = 1.0\ \mu\text{F}$, and $C_{OUT} = 4.7\ \mu\text{F}$ (unless otherwise noted)

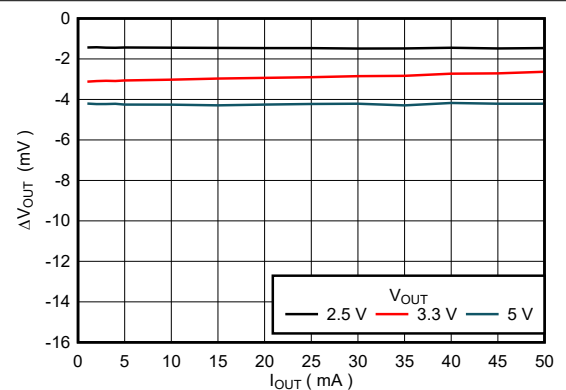

图 6-13. Output Regulation vs Load Current and Temperature for New Chip



图 6-14. Output Regulation vs Input Voltage for New Chip

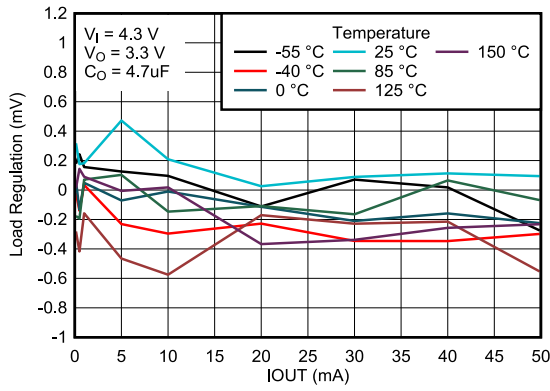

图 6-15. Ground-Pin Current vs Temperature for Legacy Chip

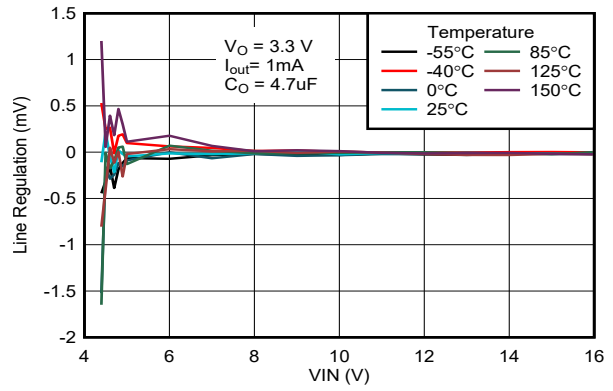

图 6-16. Ground-Pin Current vs Temperature for New Chip

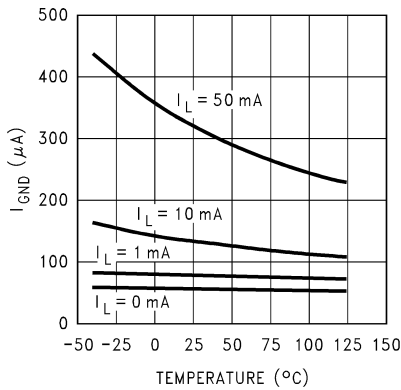

图 6-17. Ground Pin Current vs Load Current for Legacy Chip

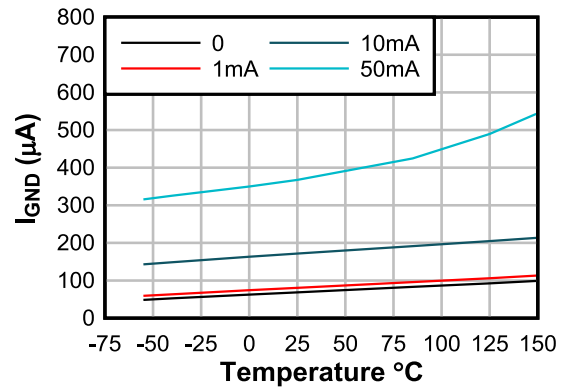

图 6-18. Ground Pin Current vs Load Current for New Chip

6.6 Typical Characteristics (continued)

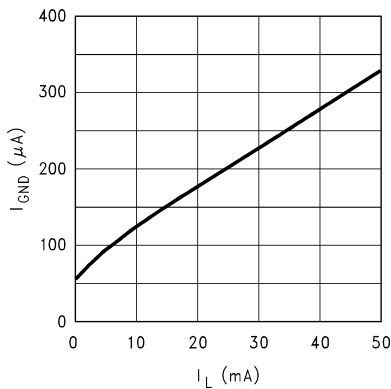
at operating temperature $T_J = 25^\circ\text{C}$, $V_{IN} = V_{OUT(NOM)} + 1.0\text{ V}$ or 2.5 V (whichever is greater), $I_{OUT} = 1\text{ mA}$, ON/OFF pin tied to V_{IN} , $C_{IN} = 1.0\text{ }\mu\text{F}$, and $C_{OUT} = 4.7\text{ }\mu\text{F}$ (unless otherwise noted)

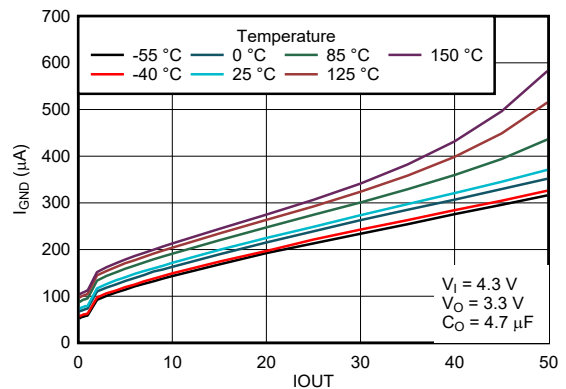

图 6-19. Input Current vs Input Voltage for Legacy Chip



图 6-20. Input Current vs Input Voltage for New Chip

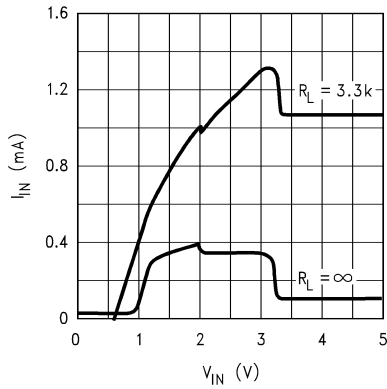

图 6-21. Short-Circuit Current vs Time for Legacy Chip

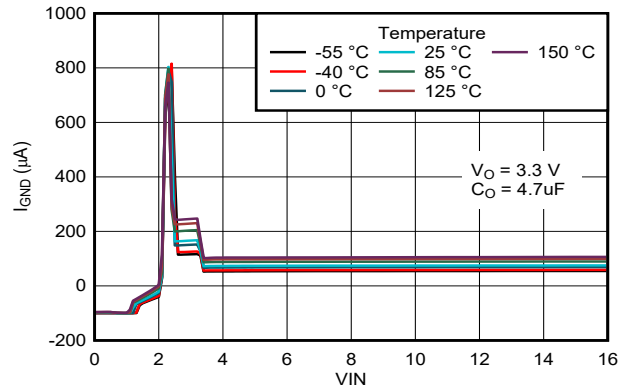

图 6-22. Short-Circuit Current vs Time for New Chip

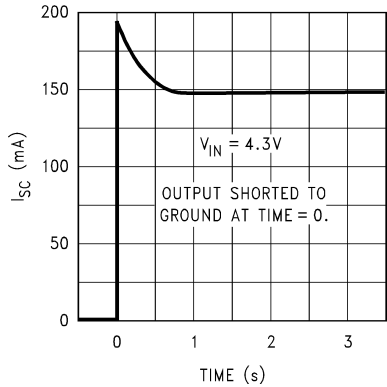

图 6-23. Short-Circuit Current vs Time for Legacy Chip

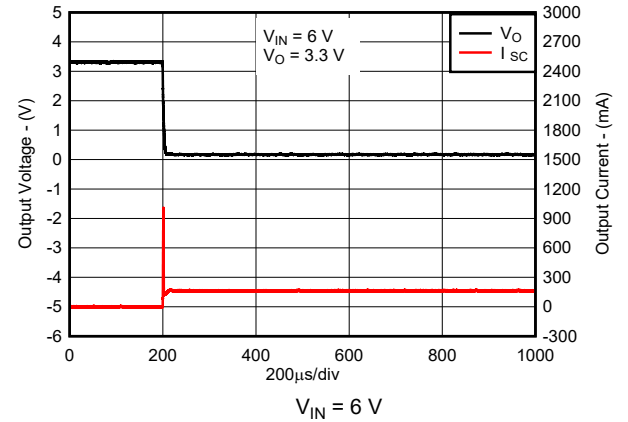

图 6-24. Short-Circuit Current vs Time for New Chip

6.6 Typical Characteristics (continued)

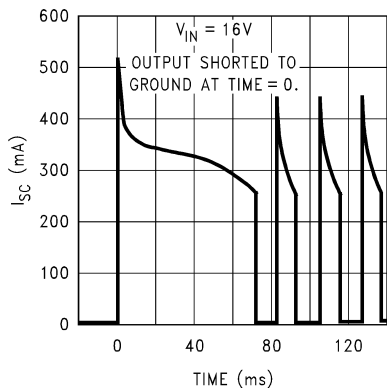
at operating temperature $T_J = 25^\circ\text{C}$, $V_{IN} = V_{OUT(\text{NOM})} + 1.0\text{ V}$ or 2.5 V (whichever is greater), $I_{OUT} = 1\text{ mA}$, ON/OFF pin tied to V_{IN} , $C_{IN} = 1.0\text{ }\mu\text{F}$, and $C_{OUT} = 4.7\text{ }\mu\text{F}$ (unless otherwise noted)

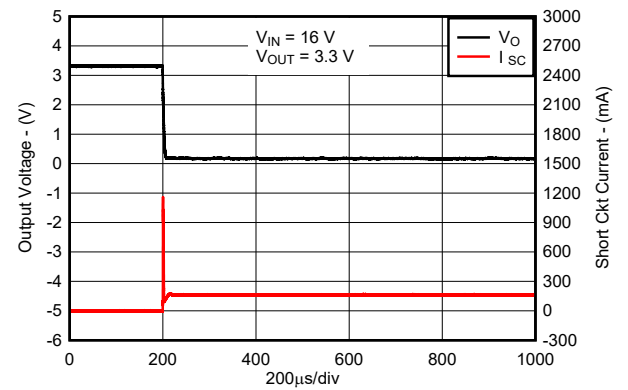

图 6-25. Short-Circuit Current vs Output Voltage for Legacy Chip



图 6-26. Short-Circuit Current vs Output Voltage for New Chip

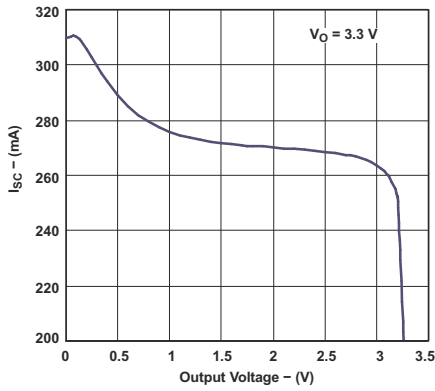

图 6-27. Short-Circuit Current vs Temperature for New Chip

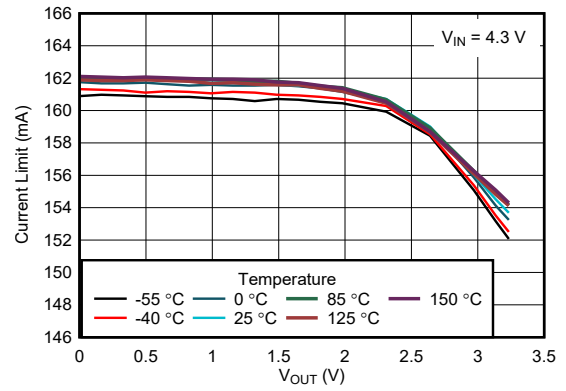

图 6-28. ADJ Pin Bias Current vs. Load Current for Legacy Chip

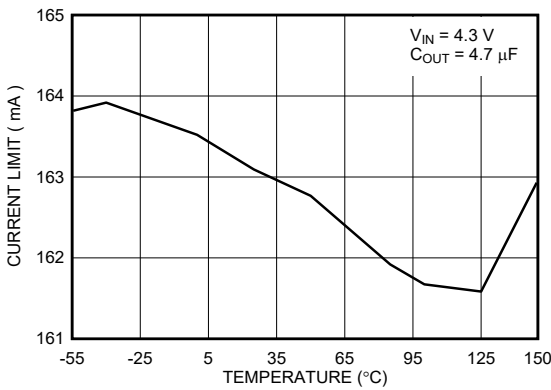

图 6-29. ADJ Pin Bias Current vs Load Current for New Chip

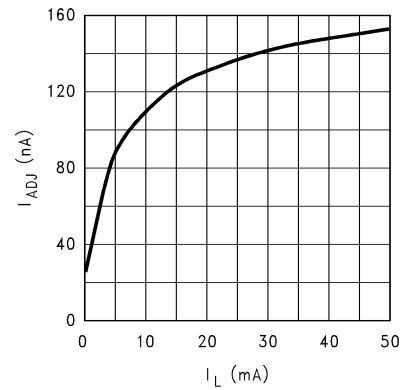

图 6-30. ADJ Pin Bias Current vs Temperature for Legacy Chip

6.6 Typical Characteristics (continued)

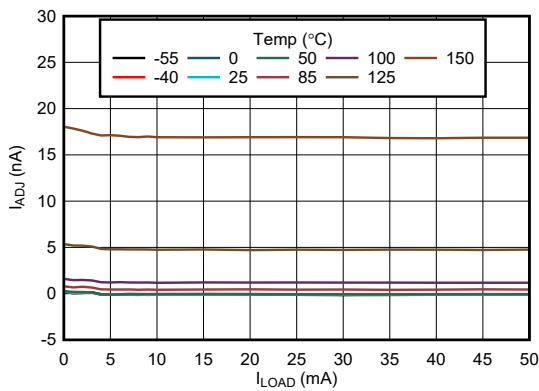
at operating temperature $T_J = 25^\circ\text{C}$, $V_{IN} = V_{OUT(NOM)} + 1.0\text{ V}$ or 2.5 V (whichever is greater), $I_{OUT} = 1\text{ mA}$, ON/OFF pin tied to V_{IN} , $C_{IN} = 1.0\text{ }\mu\text{F}$, and $C_{OUT} = 4.7\text{ }\mu\text{F}$ (unless otherwise noted)

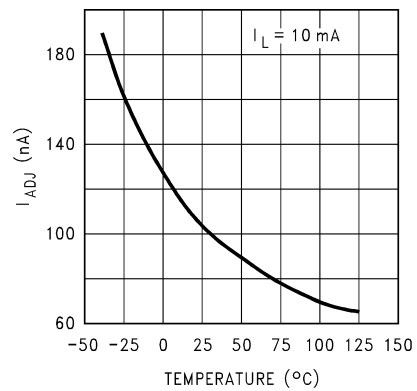

图 6-31. ADJ Pin Bias Current vs Temperature for New Chip



图 6-32. ON/OFF Threshold vs Temperature for Legacy Chip

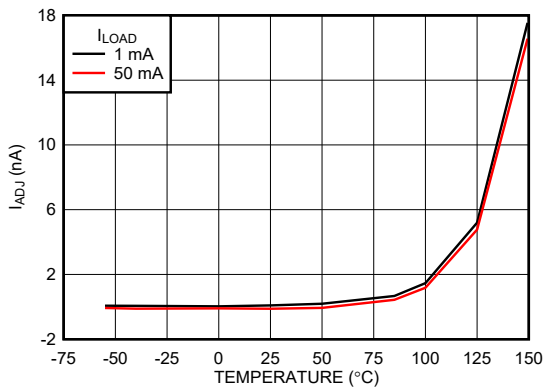

图 6-33. ON/OFF Threshold vs Temperature for New Chip

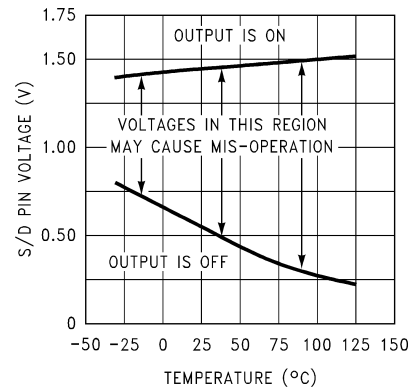

图 6-34. Output Noise Density for Legacy Chip

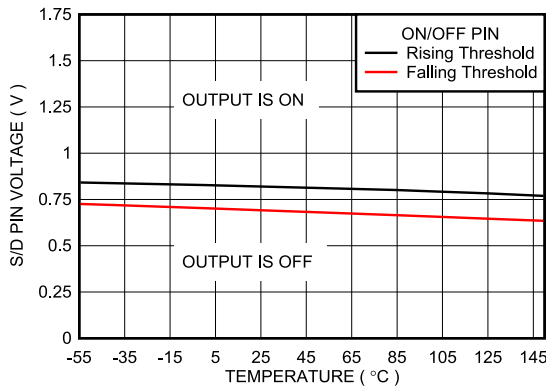

$V_{IN} = 4.3\text{ V}$, $V_{OUT} = 3.3\text{ V}$, $I_{OUT} = 50\text{ mA}$, $C_{OUT} = 2.2\text{ }\mu\text{F}$

图 6-35. Output Noise Density vs C_{FF} for New Chip

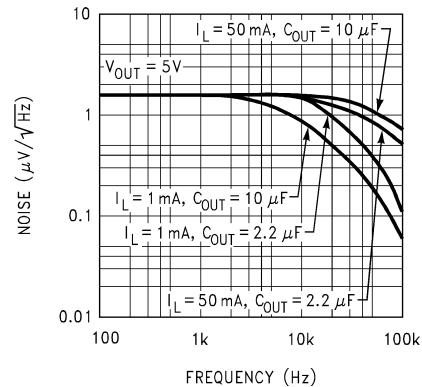
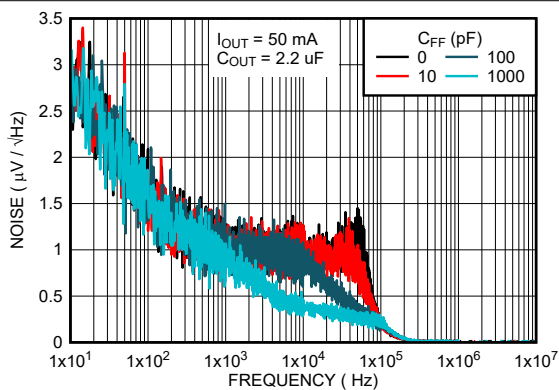
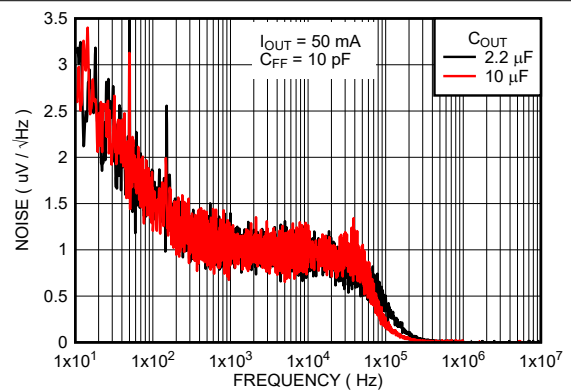

$V_{IN} = 4.3\text{ V}$, $V_{OUT} = 3.3\text{ V}$, $I_{OUT} = 50\text{ mA}$, $C_{FF} = 10\text{ pF}$

图 6-36. Output Noise Density vs C_{OUT} for New Chip

6.6 Typical Characteristics (continued)

at operating temperature $T_J = 25^\circ\text{C}$, $V_{IN} = V_{OUT(\text{NOM})} + 1.0\text{ V}$ or 2.5 V (whichever is greater), $I_{OUT} = 1\text{ mA}$, ON/OFF pin tied to V_{IN} , $C_{IN} = 1.0\text{ }\mu\text{F}$, and $C_{OUT} = 4.7\text{ }\mu\text{F}$ (unless otherwise noted)

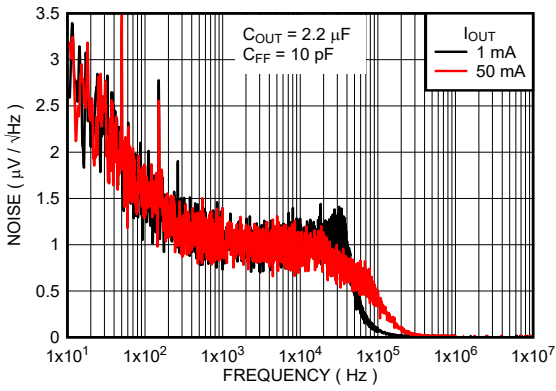

$V_{IN} = 4.3\text{ V}$, $V_{OUT} = 3.3\text{ V}$, $C_{OUT} = 2.2\text{ }\mu\text{F}$, $C_{FF} = 10\text{ pF}$

图 6-37. Output Noise Density vs I_{OUT} for New Chip



图 6-38. Ripple Rejection for Legacy Chip



$V_{IN} = 4.3\text{ V}$, $V_{OUT} = 3.3\text{ V}$, $I_{OUT} = 50\text{ mA}$, $C_{OUT} = 2.2\text{ }\mu\text{F}$

图 6-39. Ripple Rejection vs C_{FF} for New Chip

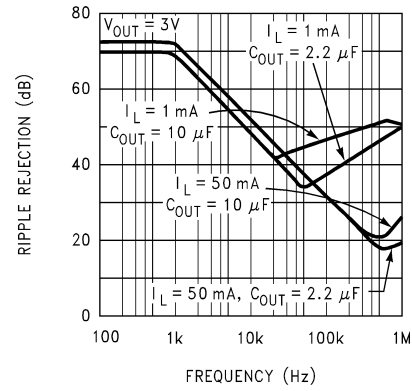
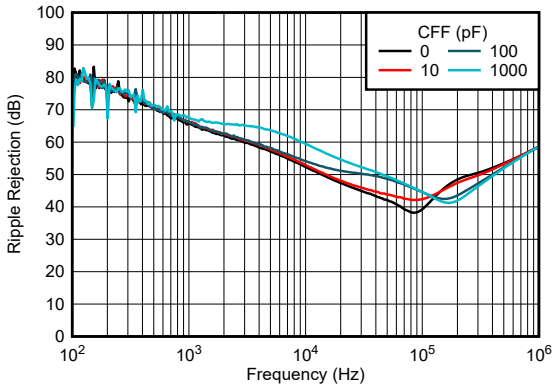
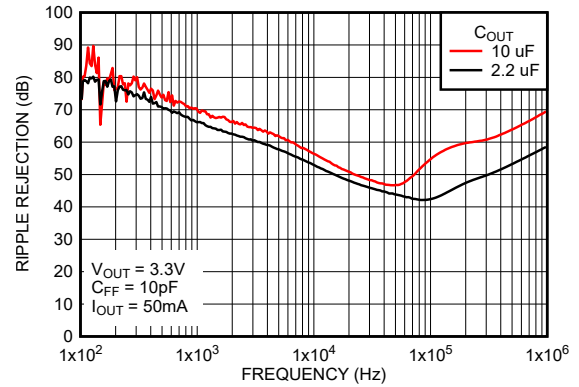

$V_{IN} = 4.3\text{ V}$, $V_{OUT} = 3.3\text{ V}$, $I_{OUT} = 50\text{ mA}$, $C_{FF} = 10\text{ pF}$

图 6-40. Ripple Rejection vs C_{OUT} for New Chip

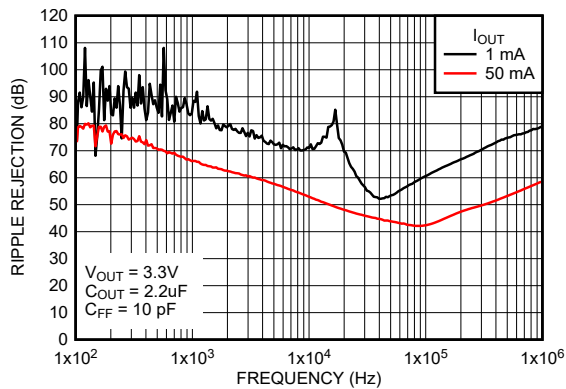

$V_{IN} = 4.3\text{ V}$, $V_{OUT} = 3.3\text{ V}$, $C_{OUT} = 2.2\text{ }\mu\text{F}$, $C_{FF} = 10\text{ pF}$

图 6-41. Ripple Rejection vs I_{OUT} for New Chip



图 6-42. 2.2- μF ESR Curves for Legacy Chip

6.6 Typical Characteristics (continued)

at operating temperature $T_J = 25^\circ\text{C}$, $V_{IN} = V_{OUT(NOM)} + 1.0\text{ V}$ or 2.5 V (whichever is greater), $I_{OUT} = 1\text{ mA}$, ON/OFF pin tied to V_{IN} , $C_{IN} = 1.0\ \mu\text{F}$, and $C_{OUT} = 4.7\ \mu\text{F}$ (unless otherwise noted)

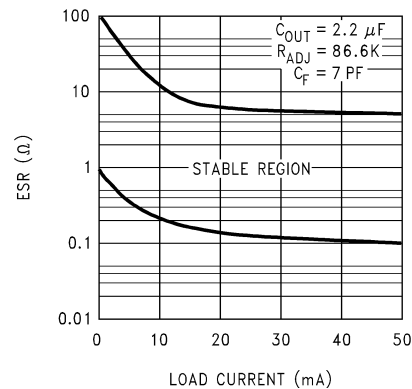

图 6-43. 4.7- μF ESR Curves for Legacy Chip

7 Detailed Description

7.1 Overview

The LP2980-ADJ is an adjustable-output, low-dropout regulator that offers exceptional, cost-effective performance for both portable and nonportable applications. The LP2980-ADJ has an output tolerance of 1% across line, load, and temperature variation (for the new chip) and is capable of delivering 50 mA of continuous load current.

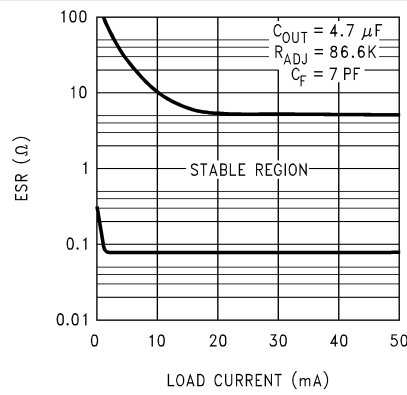
This device features integrated overcurrent protection, thermal shutdown, output enable, and internal output pulldown and has a built-in soft-start mechanism for controlled inrush current. This device delivers excellent line and load transient performance. The operating ambient temperature range of the device is -40°C to $+125^{\circ}\text{C}$.

7.2 Functional Block Diagram

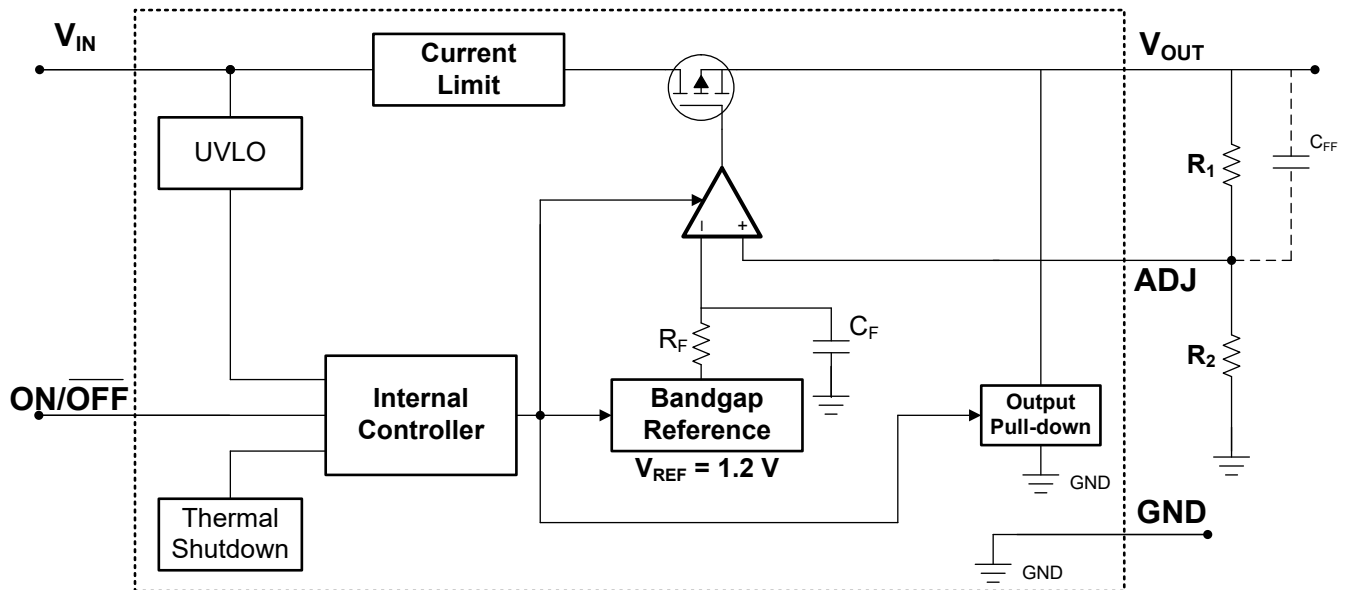

7.3 Feature Description

7.3.1 Output Enable

The ON/ $\overline{\text{OFF}}$ pin for the device is an active-high pin. The output voltage is enabled when the voltage of the ON/ $\overline{\text{OFF}}$ pin is greater than the high-level input voltage of the ON/ $\overline{\text{OFF}}$ pin and disabled when the ON/ $\overline{\text{OFF}}$ pin voltage is less than the low-level input voltage of the ON/ $\overline{\text{OFF}}$ pin. If independent control of the output voltage is not needed, connect the ON/ $\overline{\text{OFF}}$ pin to the input of the device.

For the new chip, the device has an internal pulldown circuit that activates when the device is disabled by pulling the ON/ $\overline{\text{OFF}}$ pin voltage lower than the low-level input voltage of the ON/ $\overline{\text{OFF}}$ pin, to actively discharge the output voltage.

7.3.2 Dropout Voltage

Dropout voltage (V_{DO}) is defined as the input voltage minus the output voltage ($V_{\text{IN}} - V_{\text{OUT}}$) at the rated output current (I_{RATED}), where the pass transistor is fully on. I_{RATED} is the maximum I_{OUT} listed in the [Recommended Operating Conditions](#) table. The pass transistor is in the ohmic or triode region of operation, and acts as a switch. The dropout voltage indirectly specifies a minimum input voltage greater than the nominal programmed output voltage at which the output voltage is expected to stay in regulation. If the input voltage falls to less than the nominal output regulation, then the output voltage falls as well.

For a CMOS regulator, the dropout voltage is determined by the drain-source on-state resistance ($R_{\text{DS(ON)}}$) of the pass transistor. Therefore, if the linear regulator operates at less than the rated current, the dropout voltage for that current scales accordingly. The following equation calculates the $R_{\text{DS(ON)}}$ of the device.

$$R_{DS(ON)} = \frac{V_{DO}}{I_{RATED}} \quad (1)$$

7.3.3 Current Limit

The device has an internal current limit circuit that protects the regulator during transient high-load current faults or shorting events. The current limit is a brick-wall scheme. In a high-load current fault, the brick-wall scheme limits the output current to the current limit (I_{CL}). I_{CL} is listed in the [Electrical Characteristics](#) table.

The output voltage is not regulated when the device is in current limit. When a current limit event occurs, the device begins to heat up because of the increase in power dissipation. When the device is in brick-wall current limit, the pass transistor dissipates power $[(V_{IN} - V_{OUT}) \times I_{CL}]$. If thermal shutdown is triggered, the device turns off. After the device cools down, the internal thermal shutdown circuit turns the device back on. If the output current fault condition continues, the device cycles between current limit and thermal shutdown. For more information on current limits, see the [Know Your Limits application note](#).

Figure 7-1 shows a diagram of the current limit.



图 7-1. Current Limit

7.3.4 Undervoltage Lockout (UVLO)

For the new chip, the device has an independent undervoltage lockout (UVLO) circuit that monitors the input voltage, allowing a controlled and consistent turn on and off of the output voltage. To prevent the device from turning off if the input drops during turn on, the UVLO has hysteresis as specified in the [Electrical Characteristics](#) table.

7.3.5 Output Pulldown

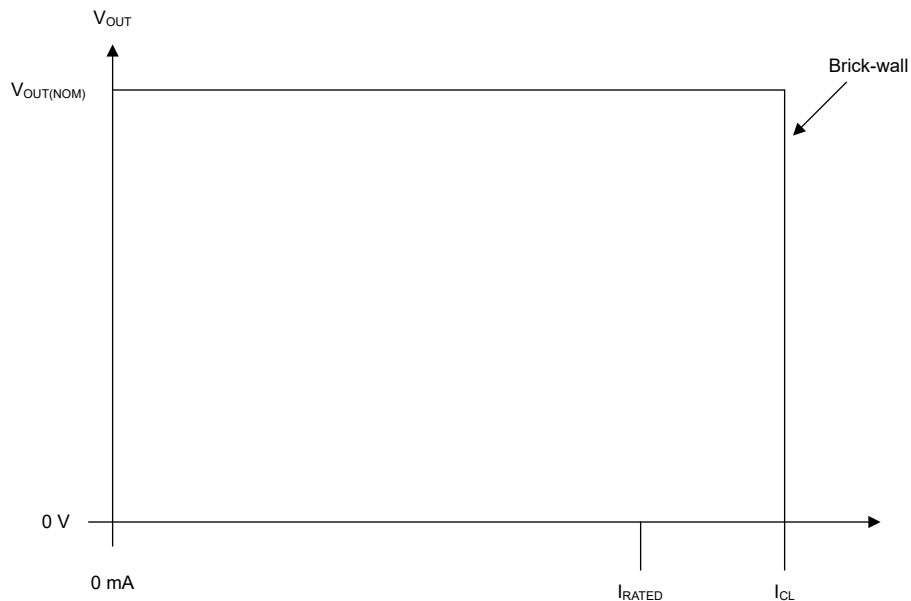
The new chip has an output pulldown circuit. The output pulldown activates in the following conditions:

- When the device is disabled ($V_{ON/OFF} < V_{ON/OFF(LOW)}$)
- If $1.0\text{ V} < V_{IN} < V_{UVLO}$

Do not rely on the output pulldown circuit for discharging a large amount of output capacitance after the input supply has collapsed because reverse current can flow from the output to the input. This reverse current flow can cause damage to the device. See the [Reverse Current](#) section for more details.

7.3.6 Thermal Shutdown

The device contains a thermal shutdown protection circuit to disable the device when the junction temperature (T_J) of the pass transistor rises to $T_{SD(shutdown)}$ (typical). Thermal shutdown hysteresis assures that the device resets (turns on) when the temperature falls to $T_{SD(reset)}$ (typical).

The thermal time-constant of the semiconductor die is fairly short, thus the device can cycle on and off when thermal shutdown is reached until power dissipation is reduced. Power dissipation during start up can be high from large $V_{IN} - V_{OUT}$ voltage drops across the device or from high inrush currents charging large output capacitors. Under some conditions, the thermal shutdown protection disables the device before start-up completes.

For reliable operation, limit the junction temperature to the maximum listed in the [Recommended Operating Conditions](#) table. Operation above this maximum temperature causes the device to exceed operational specifications. Although the internal protection circuitry of the device is designed to protect against thermal overall conditions, this circuitry is not intended to replace proper heat sinking. Continuously running the device into thermal shutdown or above the maximum recommended junction temperature reduces long-term reliability.

7.4 Device Functional Modes

7.4.1 Device Functional Mode Comparison

表 7-1 shows the conditions that lead to the different modes of operation. See the [Electrical Characteristics](#) table for parameter values.

表 7-1. Device Functional Mode Comparison

| OPERATING MODE | PARAMETER | | | |
|------------------------------------------------------|-------------------------------------------------------------|--------------------------------|--------------------------|--------------------------|
| | V_{IN} | $V_{ON/OFF}$ | I_{OUT} | T_J |
| Normal operation | $V_{IN} > V_{OUT(nom)} + V_{DO}$ and $V_{IN} > V_{IN(min)}$ | $V_{ON/OFF} > V_{ON/OFF(HI)}$ | $I_{OUT} < I_{OUT(max)}$ | $T_J < T_{SD(shutdown)}$ |
| Dropout operation | $V_{IN(min)} < V_{IN} < V_{OUT(nom)} + V_{DO}$ | $V_{ON/OFF} > V_{ON/OFF(HI)}$ | $I_{OUT} < I_{OUT(max)}$ | $T_J < T_{SD(shutdown)}$ |
| Disabled (any true condition disables the device) | $V_{IN} < V_{UVLO}$ | $V_{ON/OFF} < V_{ON/OFF(LOW)}$ | Not applicable | $T_J > T_{SD(shutdown)}$ |

7.4.2 Normal Operation

The device regulates to the nominal output voltage when the following conditions are met:

- The input voltage is greater than the nominal output voltage plus the dropout voltage ($V_{OUT(nom)} + V_{DO}$)
- The output voltage is set by using ADJ pin (see [External Feedback Resistors](#))
- The output current is less than the current limit ($I_{OUT} < I_{CL}$)
- The device junction temperature is less than the thermal shutdown temperature ($T_J < T_{SD}$)
- The ON/OFF voltage has previously exceeded the ON/OFF rising threshold voltage and has not yet decreased to less than the enable falling threshold

7.4.3 Dropout Operation

If the input voltage is lower than the nominal output voltage plus the specified dropout voltage, but all other conditions are met for normal operation, the device operates in dropout mode. In this mode, the output voltage tracks the input voltage. During this mode, the transient performance of the device becomes significantly degraded because the pass transistor is in the ohmic or triode region, and acts as a switch. Line or load transients in dropout can result in large output-voltage deviations.

When the device is in a steady dropout state (defined as when the device is in dropout, $V_{IN} < V_{OUT(NOM)} + V_{DO}$, directly after being in a normal regulation state, but *not* during start up), the pass transistor is driven into the ohmic or triode region. When the input voltage returns to a value greater than or equal to the nominal output voltage plus the dropout voltage ($V_{OUT(NOM)} + V_{DO}$), the output voltage can overshoot for a short period of time while the device pulls the pass transistor back into the linear region.

7.4.4 Disabled

The output of the device can be shutdown by forcing the voltage of the ON/OFF pin to less than the maximum ON/OFF pin low-level input voltage (see the [Electrical Characteristics](#) table). When disabled, the pass transistor is turned off, internal circuits are shutdown, and the output voltage is actively discharged to ground by an internal discharge circuit from the output to ground.

8 Application and Implementation

备注

以下应用部分中的信息不属于 TI 器件规格的范围，TI 不担保其准确性和完整性。TI 的客户应负责确定器件是否适用于其应用。客户应验证并测试其设计，以确保系统功能。

8.1 Application Information

8.1.1 External Feedback Resistors

The output voltage is set using the ADJ pin with help of the external feedback resistors, R_1 and R_2 (see [图 8-2](#)), according to the following equation:

$$V_{OUT} = V_{ADJ} \times (1 + R_1 / R_2) \quad (2)$$

For the legacy chip, use a resistor from the ADJ pin to ground with a value of 51.1 k Ω .

For the new chip, to ignore the ADJ pin current error term in the V_{OUT} equation, set the feedback divider current to 100 times the ADJ pin current listed in the [Electrical Characteristics](#) table. This setting provides the maximum feedback divider series resistance, as shown in the following equation:

$$R_1 + R_2 \leq V_{OUT} / (I_{ADJ} \times 100) \quad (3)$$

8.1.2 Recommended Capacitor Types

This section describes the recommended capacitors for both the new chip and the legacy chip.

8.1.2.1 Recommended Capacitors for the New Chip

The new chip is designed to be stable using low equivalent series resistance (ESR) ceramic capacitors at the input and output. Multilayer ceramic capacitors have become the industry standard for these types of applications and are recommended, but must be used with good judgment. Ceramic capacitors that employ X7R-, X5R-, and C0G-rated dielectric materials provide relatively good capacitive stability across temperature, whereas the use of Y5V-rated capacitors is discouraged because of large variations in capacitance.

Regardless of the ceramic capacitor type selected, the effective capacitance varies with operating voltage and temperature. Generally, expect the effective capacitance to decrease by as much as 50%. The input and output capacitors listed in the [Recommended Operating Conditions](#) table account for an effective capacitance of approximately 50% of the nominal value.

8.1.2.2 Recommended Capacitors for the Legacy Chip

The ESR of a good-quality tantalum capacitor is almost directly centered in the middle of the *stable* range of the ESR curve (approximately 0.5 Ω - 1 Ω). The temperature stability of tantalum capacitors is typically very good, with a total variation of only approximately 2:1 over the temperature range of -40°C to +125°C (ESR increases at colder temperatures). Avoid off-brand capacitors because some poor-quality tantalum capacitors are available with ESR values greater than 10 Ω , which usually causes oscillation problems. One caution regarding tantalum capacitors is that if used on the input, the ESR is low enough to be destroyed by a surge current if the capacitor is powered up from a low impedance source (such as a battery) that has no limit on inrush current. In this case, use a ceramic input capacitor that does not have this problem.

Ceramic capacitors are generally larger and more costly than tantalum capacitors for a given amount of capacitance. These capacitors also have a very low ESR that is quite stable with temperature. However, the ESR of a ceramic capacitor is typically low enough to make an LDO oscillate. A 2.2- μ F ceramic demonstrated an ESR of approximately 15 m Ω when tested. If used as an output capacitor, this ESR can cause instability (see the ESR curves in the [Typical Characteristics](#) section). If a ceramic capacitor is used on the output of an LDO, place a small resistor (approximately 1 Ω) in series with the capacitor. If used as an input capacitor, no resistor is needed because there is no requirement for ESR on capacitors used on the input.

8.1.3 Input and Output Capacitor Requirements

For the legacy chip, an input capacitor (C_{IN}) ≥ 1 μ F is required (the amount of capacitance can be increased without limit). Any good-quality tantalum or ceramic capacitor can be used. The capacitor must be located no more than half an inch from the input pin and returned to a clean analog ground.

For the new chip, although an input capacitor is not required for stability, good analog design practice is to connect a capacitor from IN to GND. This capacitor counteracts reactive input sources and improves transient response, input ripple, and PSRR. Use an input capacitor if the source impedance is more than 0.5 Ω . A higher value capacitor can be necessary if large, fast rise-time load or line transients are anticipated or if the device is located several inches from the input power source.

Dynamic performance of the device is improved with the use of an output capacitor. Use an output capacitor within the range specified in the [Recommended Operating Conditions](#) table for stability.

8.1.4 Feed-Forward Capacitor (C_{FF})

A feed-forward capacitor (C_{FF}) can be connected from the V_{OUT} pin to the ADJ pin. C_{FF} improves transient, noise, and PSRR performance, but is not required for regulator stability. Recommended C_{FF} values are listed in the [Recommended Operating Conditions](#) table. A higher capacitance C_{FF} can be used; however, the start-up time increases. For a detailed description of C_{FF} tradeoffs, see the [Pros and Cons of Using a Feedforward Capacitor with a Low-Dropout Regulator application note](#).

C_{FF} and R_1 form a zero in the loop gain at frequency f_Z , whereas C_{FF} , R_1 , and R_2 form a pole in the loop gain at frequency f_P . C_{FF} zero and pole frequencies can be calculated from the following equations:

$$f_Z = 1 / (2 \times \pi \times C_{FF} \times R_1) \quad (4)$$

$$f_P = 1 / (2 \times \pi \times C_{FF} \times (R_1 \parallel R_2)) \quad (5)$$

For the legacy chip, a feed-forward capacitor (C_{FF}) of 7 pF is required, because this capacitor provides the lead compensation necessary for loop stability. Use a temperature-stable ceramic capacitor (NPO or COG type).

For the new chip, a $C_{FF} \geq 10$ pF is required for stability only if the feedback divider current is less than 5 μ A. The following equation calculates the feedback divider current.

$$I_{FB_Divider} = V_{OUT} / (R_1 + R_2) \quad (6)$$

To avoid start-up time increases from C_{FF} , limit the product $C_{FF} \times R_1 < 50$ μ s.

For an output voltage of 1.2 V with the ADJ pin tied to the V_{OUT} pin, no C_{FF} is used.

8.1.5 Reverse Current

Excessive reverse current can damage this device. Reverse current flows through the intrinsic body diode of the pass transistor instead of the normal conducting channel. At high magnitudes, this current flow degrades the long-term reliability of the device.

Conditions where reverse current can occur are outlined in this section, all of which can exceed the absolute maximum rating of $V_{OUT} \leq V_{IN} + 0.3$ V.

- If the device has a large C_{OUT} and the input supply collapses with little or no load current
- The output is biased when the input supply is not established

- The output is biased above the input supply

If reverse current flow is expected in the application, use external protection to protect the device. Reverse current is not limited in the device, so external limiting is required if extended reverse voltage operation is anticipated.

图 8-1 shows one approach for protecting the device.



图 8-1. Example Circuit for Reverse Current Protection Using a Schottky Diode

8.1.6 Power Dissipation (P_D)

Circuit reliability requires consideration of the device power dissipation, location of the circuit on the printed circuit board (PCB), and correct sizing of the thermal plane. The PCB area around the regulator must have few or no other heat-generating devices that cause added thermal stress.

To first-order approximation, power dissipation in the regulator depends on the input-to-output voltage difference and load conditions. The following equation calculates power dissipation (P_D).

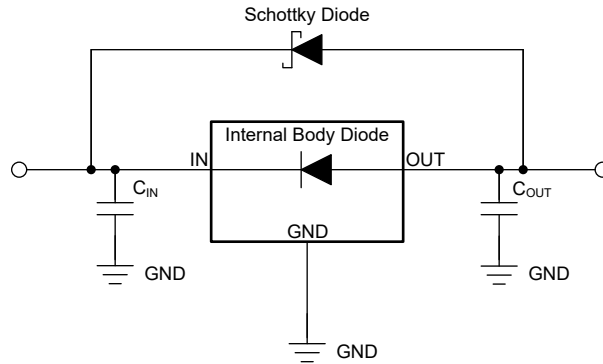
$$P_D = (V_{IN} - V_{OUT}) \times I_{OUT} \quad (7)$$

备注

Power dissipation can be minimized, and therefore greater efficiency can be achieved, by correct selection of the system voltage rails. For the lowest power dissipation use the minimum input voltage required for correct output regulation.

For devices with a thermal pad, the primary heat conduction path for the device package is through the thermal pad to the PCB. Solder the thermal pad to a copper pad area under the device. This pad area must contain an array of plated vias that conduct heat to additional copper planes for increased heat dissipation.

The maximum power dissipation determines the maximum allowable ambient temperature (T_A) for the device. According to the following equation, power dissipation and junction temperature are most often related by the junction-to-ambient thermal resistance ($R_{\theta JA}$) of the combined PCB and device package and the temperature of the ambient air (T_A).

$$T_J = T_A + (R_{\theta JA} \times P_D) \quad (8)$$

Thermal resistance ($R_{\theta JA}$) is highly dependent on the heat-spreading capability built into the particular PCB design, and therefore varies according to the total copper area, copper weight, and location of the planes. The junction-to-ambient thermal resistance listed in the [Thermal Information](#) table is determined by the JEDEC standard PCB and copper-spreading area, and is used as a relative measure of package thermal performance. As mentioned in the [An empirical analysis of the impact of board layout on LDO thermal performance application note](#), $R_{\theta JA}$ can be improved by 35% to 55% compared to the [Thermal Information](#) table value with the PCB board layout optimization.

8.1.7 Estimating Junction Temperature

The JEDEC standard now recommends the use of psi (Ψ) thermal metrics to estimate the junction temperatures of the linear regulator when in-circuit on a typical PCB board application. These metrics are not thermal resistance parameters and instead offer a practical and relative way to estimate junction temperature. These psi metrics are determined to be significantly independent of the copper area available for heat-spreading. The [Thermal Information](#) table lists the primary thermal metrics, which are the junction-to-top characterization parameter (ψ_{JT}) and junction-to-board characterization parameter (ψ_{JB}). These parameters provide two methods for calculating the junction temperature (T_J), as described in the following equations. Use the junction-to-top characterization parameter (ψ_{JT}) with the temperature at the center-top of device package (T_T) to calculate the junction temperature. Use the junction-to-board characterization parameter (ψ_{JB}) with the PCB surface temperature 1 mm from the device package (T_B) to calculate the junction temperature.

$$T_J = T_T + \psi_{JT} \times P_D \quad (9)$$

where:

- P_D is the dissipated power
- T_T is the temperature at the center-top of the device package

$$T_J = T_B + \psi_{JB} \times P_D \quad (10)$$

where:

- T_B is the PCB surface temperature measured 1 mm from the device package and centered on the package edge

For detailed information on the thermal metrics and how to use them, see the [Semiconductor and IC Package Thermal Metrics](#) application note.

8.2 Typical Application

图 8-2 shows the standard usage of the LP2980-ADJ as a low-dropout regulator.



图 8-2. LP2980-ADJ Typical Application

8.2.1 Design Requirements

For this design, use the minimum C_{OUT} value for stability (which can be increased without limit for improved stability and transient response). The ON/OFF pin must be actively terminated. Connect this pin to V_{IN} if the shutdown feature is not used. Set the output voltage using a feedback divider between the V_{OUT} pin and the ADJ pin. Use an optional C_{FF} capacitor for improved transient, noise, and PSRR performance.

For the new chip, 表 8-1 summarizes the design requirements for 图 8-2.

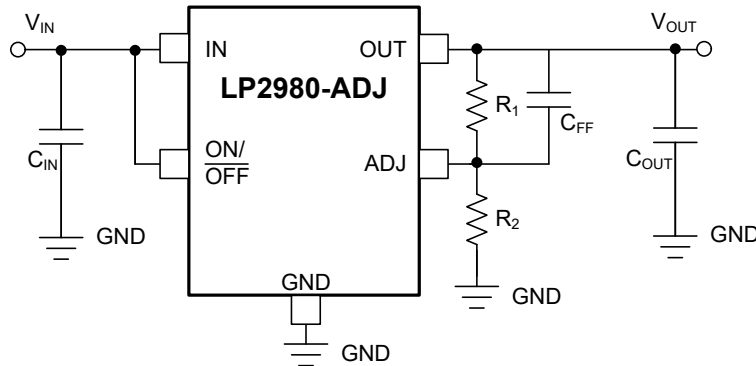
表 8-1. Design Parameters

| PARAMETER | DESIGN REQUIREMENT |
|-----------------------------|--------------------|
| Input voltage | 12 V |
| Output voltage | 2.5 V |
| Output current | 50 mA |
| R_1 (feedback resistance) | 108.33 k Ω |
| R_2 (feedback resistance) | 100.00 k Ω |

8.2.2 Detailed Design Procedure

8.2.2.1 Setting V_{OUT} For the LP2980-ADJ LDO

As illustrated in 图 8-2, the LP2980-ADJ uses the feedback divider to set the output voltage. The output voltage operating range is 1.2 V to 15 V, and is calculated using:

$$V_{OUT} = V_{ADJ} \times (1 + R_1/R_2) \quad (11)$$

where:

- $V_{REF} = 1.2$ V (typical)

Choose resistors R_1 and R_2 as suggested in the [External Feedback Resistors](#) section.

图 8-2 depicts this configuration.

8.2.2.2 ON/OFF Input Operation

The LP2980-ADJ is shut off by driving the ON/OFF input low, and turned on by pulling the ON/OFF input high. If this feature is not used, the ON/OFF input must be tied to V_{IN} to keep the regulator output on at all times (the ON/OFF input must not be left floating).

To ensure proper operation, the signal source used to drive the ON/OFF input must be able to swing above and below the specified turn-on/turn-off voltage thresholds that specify an ON or OFF state (see the [Electrical Characteristics](#) table).

For the legacy chip, the turn-on (and turn-off) voltage signals applied to the ON/OFF input must have a slew rate which is greater than 40 mV/ μ s.

For the new chip, there is no restriction on the slew rate of the voltage signals applied to the ON/OFF input. Both fast and slow ramping voltage signals can be used to drive the ON/OFF pin.

备注

For the legacy chip only, the ON/OFF function does not operate correctly if a slow-moving signal is used to drive the ON/OFF input.

8.2.3 Application Curves

at operating temperature $T_J = 25^\circ\text{C}$, $V_{IN} = V_{OUT(NOM)} + 1.0\text{ V}$ or 2.5 V (whichever is greater), $I_{OUT} = 1\text{ mA}$, ON/OFF pin tied to V_{IN} , $C_{IN} = 1.0\ \mu\text{F}$, and $C_{OUT} = 4.7\ \mu\text{F}$ (unless otherwise noted)



图 8-3. Load Transient Response for Legacy Chip



图 8-4. Load Transient Response for New Chip

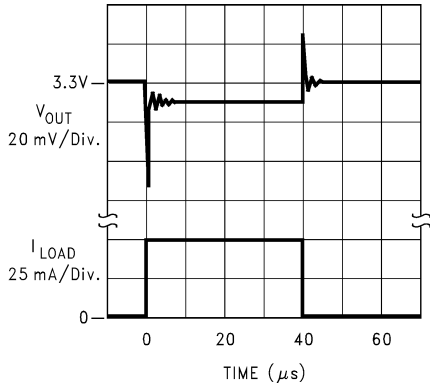

图 8-5. Line Transient Response for Legacy Chip

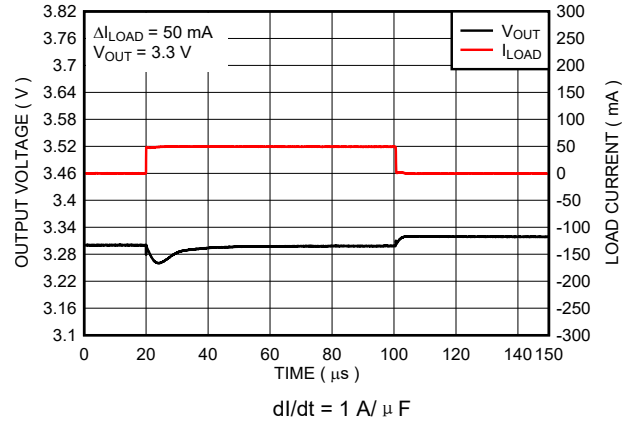

图 8-6. Line Transient Response for New Chip

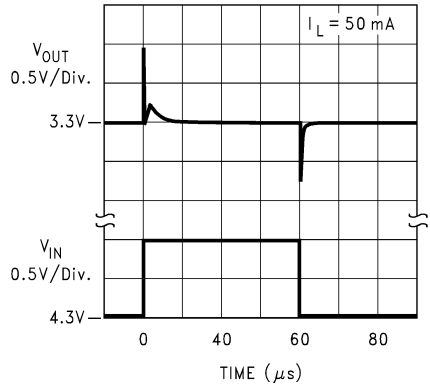

图 8-7. Start-Up vs C_{FF} for New Chip

8.3 Power Supply Recommendations

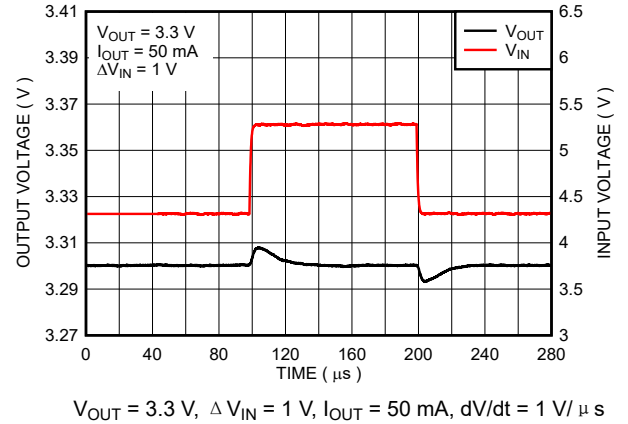
A power supply can be used at the input voltage within the ranges given in the [Recommended Operating Conditions](#) table. Use bypass capacitors as described in the [Layout Guidelines](#) section.

8.4 Layout

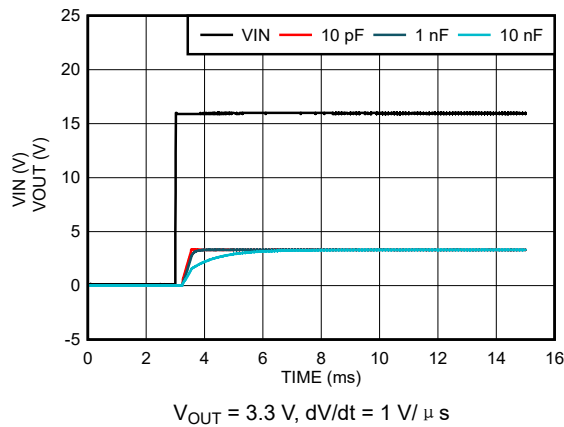
8.4.1 Layout Guidelines

- Bypass the input pin to ground with a bypass capacitor.
- The optimum placement of the bypass capacitor is closest to the V_{IN} of the device and GND of the system. Care must be taken to minimize the loop area formed by the bypass capacitor connection, the V_{IN} pin, and the GND pin of the system.
- For operation at full-rated load, use wide trace lengths to eliminate IR drop and heat dissipation.

8.4.2 Layout Example



图 8-8. Layout Diagram

9 Device and Documentation Support

9.1 Device Support

9.1.1 Device Nomenclature

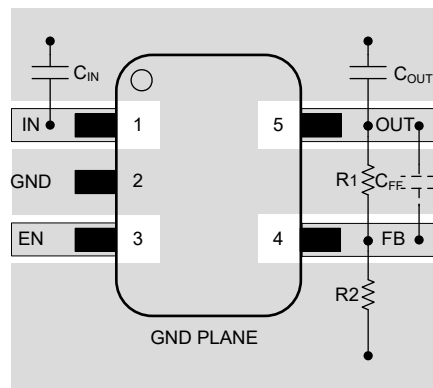
表 9-1. Available Options⁽¹⁾

| PRODUCT | V _{OUT} |
|-------------------------------------|--------------------------------------------------------------------------------------------------------------------------------------------------------------------------------------------------------------------------------------------------------------------------------------------|
| LP2980cxxxz-ADJ/NOPB Legacy chip | A is for higher accuracy and non-A is for standard grade. c is the accuracy specification. xxx is the package designator. z is the package quantity. X is for large quantity reel and non-X is for small quantity reel. |
| LP2980Axxxz-ADJ/M3 New chip | A is for higher accuracy and non-A is for standard grade. xxx is the package designator. z is the package quantity. X is for large quantity reel and non-X is for small quantity reel. M3 is a suffix designator for newer chip redesigns, fabricated on the latest TI process technology. |

(1) For the most current package and ordering information, see the Package Option Addendum at the end of this document, or visit the device product folder at www.ti.com.

9.2 接收文档更新通知

要接收文档更新通知，请导航至 ti.com 上的器件产品文件夹。点击 [订阅更新](#) 进行注册，即可每周接收产品信息更改摘要。有关更改的详细信息，请查看任何已修订文档中包含的修订历史记录。

9.3 支持资源

[TI E2E™ 支持论坛](#) 是工程师的重要参考资料，可直接从专家获得快速、经过验证的解答和设计帮助。搜索现有解答或提出自己的问题可获得所需的快速设计帮助。

链接的内容由各个贡献者“按原样”提供。这些内容并不构成 TI 技术规范，并且不一定反映 TI 的观点；请参阅 TI 的《[使用条款](#)》。

9.4 Trademarks

TI E2E™ is a trademark of Texas Instruments.

所有商标均为其各自所有者的财产。

9.5 静电放电警告



静电放电 (ESD) 会损坏这个集成电路。德州仪器 (TI) 建议通过适当的预防措施处理所有集成电路。如果不遵守正确的处理和安装程序，可能会损坏集成电路。

ESD 的损坏小至导致微小的性能降级，大至整个器件故障。精密的集成电路可能更容易受到损坏，这是因为非常细微的参数更改都可能会导致器件与其发布的规格不相符。

9.6 术语表

[TI 术语表](#) 本术语表列出并解释了术语、首字母缩略词和定义。

10 Mechanical, Packaging, and Orderable Information

The following pages include mechanical, packaging, and orderable information. This information is the most current data available for the designated devices. This data is subject to change without notice and revision of this document. For browser-based versions of this data sheet, refer to the left-hand navigation.

PACKAGING INFORMATION

| Orderable part number | Status (1) | Material type (2) | Package Pins | Package qty Carrier | RoHS (3) | Lead finish/ Ball material (4) | MSL rating/ Peak reflow (5) | Op temp (°C) | Part marking (6) |
|-------------------------------------|---------------|----------------------|------------------|-----------------------|-------------|--------------------------------------|-----------------------------------|--------------|---------------------|
| LP2980IM5-ADJ/NOM3 | Active | Production | SOT-23 (DBV) 5 | 3000 LARGE T&R | Yes | NIPDAU SN | Level-1-260C-UNLIM | -40 to 125 | L06B |
| LP2980IM5-ADJ/NOM3.A | Active | Production | SOT-23 (DBV) 5 | 3000 LARGE T&R | Yes | NIPDAU | Level-1-260C-UNLIM | -40 to 125 | L06B |
| LP2980IM5-ADJ/NOPB | Active | Production | SOT-23 (DBV) 5 | 3000 LARGE T&R | Yes | SN | Level-1-260C-UNLIM | -40 to 125 | L06B |
| LP2980IM5-ADJ/NOPB.A | Active | Production | SOT-23 (DBV) 5 | 3000 LARGE T&R | Yes | SN | Level-1-260C-UNLIM | -40 to 125 | L06B |
| LP2980IM5X-ADJ/NO.A | Active | Production | SOT-23 (DBV) 5 | 3000 LARGE T&R | Yes | SN | Level-1-260C-UNLIM | -40 to 125 | L06B |
| LP2980IM5X-ADJ/NOPB | Active | Production | SOT-23 (DBV) 5 | 3000 LARGE T&R | Yes | SN | Level-1-260C-UNLIM | -40 to 125 | L06B |

(1) **Status:** For more details on status, see our [product life cycle](#).

(2) **Material type:** When designated, preproduction parts are prototypes/experimental devices, and are not yet approved or released for full production. Testing and final process, including without limitation quality assurance, reliability performance testing, and/or process qualification, may not yet be complete, and this item is subject to further changes or possible discontinuation. If available for ordering, purchases will be subject to an additional waiver at checkout, and are intended for early internal evaluation purposes only. These items are sold without warranties of any kind.

(3) **RoHS values:** Yes, No, RoHS Exempt. See the [TI RoHS Statement](#) for additional information and value definition.

(4) **Lead finish/Ball material:** Parts may have multiple material finish options. Finish options are separated by a vertical ruled line. Lead finish/Ball material values may wrap to two lines if the finish value exceeds the maximum column width.

(5) **MSL rating/Peak reflow:** The moisture sensitivity level ratings and peak solder (reflow) temperatures. In the event that a part has multiple moisture sensitivity ratings, only the lowest level per JEDEC standards is shown. Refer to the shipping label for the actual reflow temperature that will be used to mount the part to the printed circuit board.

(6) **Part marking:** There may be an additional marking, which relates to the logo, the lot trace code information, or the environmental category of the part.

Multiple part markings will be inside parentheses. Only one part marking contained in parentheses and separated by a "~" will appear on a part. If a line is indented then it is a continuation of the previous line and the two combined represent the entire part marking for that device.

Important Information and Disclaimer: The information provided on this page represents TI's knowledge and belief as of the date that it is provided. TI bases its knowledge and belief on information provided by third parties, and makes no representation or warranty as to the accuracy of such information. Efforts are underway to better integrate information from third parties. TI has taken and continues to take reasonable steps to provide representative and accurate information but may not have conducted destructive testing or chemical analysis on incoming materials and chemicals. TI and TI suppliers consider certain information to be proprietary, and thus CAS numbers and other limited information may not be available for release.

In no event shall TI's liability arising out of such information exceed the total purchase price of the TI part(s) at issue in this document sold by TI to Customer on an annual basis.

TAPE AND REEL INFORMATION

QUADRANT ASSIGNMENTS FOR PIN 1 ORIENTATION IN TAPE

*All dimensions are nominal

| Device | Package Type | Package Drawing | Pins | SPQ | Reel Diameter (mm) | Reel Width W1 (mm) | A0 (mm) | B0 (mm) | K0 (mm) | P1 (mm) | W (mm) | Pin1 Quadrant |
|---------------------|--------------|-----------------|------|------|--------------------|--------------------|---------|---------|---------|---------|--------|---------------|
| LP2980IM5-ADJ/NOM3 | SOT-23 | DBV | 5 | 3000 | 180.0 | 8.4 | 3.2 | 3.2 | 1.4 | 4.0 | 8.0 | Q3 |
| LP2980IM5-ADJ/NOM3 | SOT-23 | DBV | 5 | 3000 | 180.0 | 8.4 | 3.2 | 3.2 | 1.4 | 4.0 | 8.0 | Q3 |
| LP2980IM5-ADJ/NOPB | SOT-23 | DBV | 5 | 3000 | 178.0 | 8.4 | 3.2 | 3.2 | 1.4 | 4.0 | 8.0 | Q3 |
| LP2980IM5X-ADJ/NOPB | SOT-23 | DBV | 5 | 3000 | 178.0 | 8.4 | 3.2 | 3.2 | 1.4 | 4.0 | 8.0 | Q3 |

TAPE AND REEL BOX DIMENSIONS



*All dimensions are nominal

| Device | Package Type | Package Drawing | Pins | SPQ | Length (mm) | Width (mm) | Height (mm) |
|---------------------|--------------|-----------------|------|------|-------------|------------|-------------|
| LP2980IM5-ADJ/NOM3 | SOT-23 | DBV | 5 | 3000 | 210.0 | 185.0 | 35.0 |
| LP2980IM5-ADJ/NOM3 | SOT-23 | DBV | 5 | 3000 | 210.0 | 185.0 | 35.0 |
| LP2980IM5-ADJ/NOPB | SOT-23 | DBV | 5 | 3000 | 208.0 | 191.0 | 35.0 |
| LP2980IM5X-ADJ/NOPB | SOT-23 | DBV | 5 | 3000 | 208.0 | 191.0 | 35.0 |

EXAMPLE BOARD LAYOUT

DBV0005A

SOT-23 - 1.45 mm max height

SMALL OUTLINE TRANSISTOR



LAND PATTERN EXAMPLE
EXPOSED METAL SHOWN
SCALE:15X



SOLDER MASK DETAILS

4214839/K 08/2024

NOTES: (continued)

- 6. Publication IPC-7351 may have alternate designs.
- 7. Solder mask tolerances between and around signal pads can vary based on board fabrication site.

EXAMPLE STENCIL DESIGN

DBV0005A

SOT-23 - 1.45 mm max height

SMALL OUTLINE TRANSISTOR



SOLDER PASTE EXAMPLE
BASED ON 0.125 mm THICK STENCIL
SCALE:15X

4214839/K 08/2024

NOTES: (continued)

8. Laser cutting apertures with trapezoidal walls and rounded corners may offer better paste release. IPC-7525 may have alternate design recommendations.
9. Board assembly site may have different recommendations for stencil design.

重要通知和免责声明

TI“按原样”提供技术和可靠性数据（包括数据表）、设计资源（包括参考设计）、应用或其他设计建议、网络工具、安全信息和其他资源，不保证没有瑕疵且不做任何明示或暗示的担保，包括但不限于对适销性、与某特定用途的适用性或不侵犯任何第三方知识产权的暗示担保。

这些资源可供使用 TI 产品进行设计的熟练开发人员使用。您将自行承担以下全部责任：(1) 针对您的应用选择合适的 TI 产品，(2) 设计、验证并测试您的应用，(3) 确保您的应用满足相应标准以及任何其他安全、安保法规或其他要求。

这些资源如有变更，恕不另行通知。TI 授权您仅可将这些资源用于研发本资源所述的 TI 产品的相关应用。严禁以其他方式对这些资源进行复制或展示。您无权使用任何其他 TI 知识产权或任何第三方知识产权。对于因您对这些资源的使用而对 TI 及其代表造成的任何索赔、损害、成本、损失和债务，您将全额赔偿，TI 对此概不负责。

TI 提供的产品受 [TI 销售条款](#)、[TI 通用质量指南](#) 或 [ti.com](#) 上其他适用条款或 TI 产品随附的其他适用条款的约束。TI 提供这些资源并不会扩展或以其他方式更改 TI 针对 TI 产品发布的适用的担保或担保免责声明。除非德州仪器 (TI) 明确将某产品指定为定制产品或客户特定产品，否则其产品均为按确定价格收入目录的标准通用器件。

TI 反对并拒绝您可能提出的任何其他或不同的条款。

版权所有 © 2026，德州仪器 (TI) 公司

最后更新日期：2025 年 10 月