

## LMV851/LMV852/LMV854 8 MHz Low Power CMOS, EMI Hardened Operational Amplifiers

 Check for Samples: [LMV851](#), [LMV852](#), [LMV854](#)

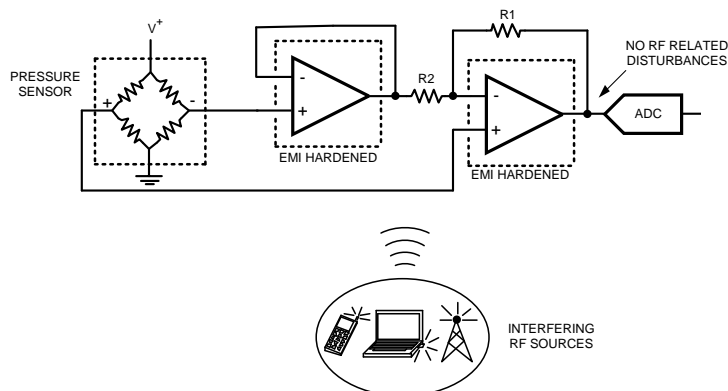
### FEATURES

- Unless Otherwise Noted, Typical Values at  $T_A = 25^\circ\text{C}$ ,  $V_{\text{SUPPLY}} = 3.3\text{V}$
- Supply Voltage 2.7V to 5.5V
- Supply Current (Per Channel) 0.4 mA
- Input Offset Voltage 1 mV max
- Input Bias Current 0.1 pA
- GBW 8 MHz
- EMIRR at 1.8 GHz 87 dB
- Input Noise Voltage at 1 kHz 11 nV/√Hz
- Slew Rate 4.5 V/μs
- Output Voltage Swing Rail-to-Rail
- Output Current Drive 30 mA
- Operating Ambient Temperature Range  $-40^\circ\text{C}$  to  $125^\circ\text{C}$

### APPLICATIONS

- Photodiode Preamp
- Piezoelectric Sensors
- Portable/Battery-Powered Electronic Equipment
- Filters/Buffers
- PDAs/Phone Accessories
- Medical Diagnosis Equipment

### Typical Application



**Figure 1. Sensor Amplifiers Close to RF Sources**



Please be aware that an important notice concerning availability, standard warranty, and use in critical applications of Texas Instruments semiconductor products and disclaimers thereto appears at the end of this data sheet.

All trademarks are the property of their respective owners.



These devices have limited built-in ESD protection. The leads should be shorted together or the device placed in conductive foam during storage or handling to prevent electrostatic damage to the MOS gates.

### Absolute Maximum Ratings <sup>(1)</sup>

ESD Tolerance <sup>(2)</sup>	
Human Body Model	2 kV
Charge-Device Model	1 kV
Machine Model	200V
V <sub>IN</sub> Differential	± Supply Voltage
Supply Voltage (V <sup>+</sup> – V <sup>-</sup> )	6V
Voltage at Input/Output Pins	V <sup>+</sup> +0.4V V <sup>-</sup> -0.4V
Storage Temperature Range	-65°C to +150°C
Junction Temperature <sup>(3)</sup>	+150°C
Soldering Information	
Infrared or Convection (20 sec)	+260°C

- (1) Absolute Maximum Ratings indicate limits beyond which damage to the device may occur. Operating Ratings indicate conditions for which the device is intended to be functional, but specific performance is not ensured. For ensured specifications and the test conditions, see the Electrical Characteristics Tables.
- (2) Human Body Model, applicable std. MIL-STD-883, Method 3015.7. Machine Model, applicable std. JESD22-A115-A (ESD MM std. of JEDEC) Field-Induced Charge-Device Model, applicable std. JESD22-C101-C (ESD FICDM std. of JEDEC).
- (3) The maximum power dissipation is a function of T<sub>J(MAX)</sub>, θ<sub>JA</sub>, and T<sub>A</sub>. The maximum allowable power dissipation at any ambient temperature is P<sub>D</sub> = (T<sub>J(MAX)</sub> - T<sub>A</sub>) / θ<sub>JA</sub>. All numbers apply for packages soldered directly onto a PC board.

### Operating Ratings <sup>(1)</sup>

Temperature Range <sup>(2)</sup>	-40°C to +125°C
Supply Voltage (V <sup>+</sup> – V <sup>-</sup> )	2.7V to 5.5V
Package Thermal Resistance (θ <sub>JA</sub> ) <sup>(2)</sup>	
5-Pin SC70	313 °C/W
8-Pin VSSOP	217 °C/W
14-Pin TSSOP	135 °C/W

- (1) Absolute Maximum Ratings indicate limits beyond which damage to the device may occur. Operating Ratings indicate conditions for which the device is intended to be functional, but specific performance is not ensured. For ensured specifications and the test conditions, see the Electrical Characteristics Tables.
- (2) The maximum power dissipation is a function of T<sub>J(MAX)</sub>, θ<sub>JA</sub>, and T<sub>A</sub>. The maximum allowable power dissipation at any ambient temperature is P<sub>D</sub> = (T<sub>J(MAX)</sub> - T<sub>A</sub>) / θ<sub>JA</sub>. All numbers apply for packages soldered directly onto a PC board.

### 3.3V Electrical Characteristics <sup>(1)</sup>

Unless otherwise specified, all limits are specified for T<sub>A</sub> = 25°C, V<sup>+</sup> = 3.3V, V<sup>-</sup> = 0V, V<sub>CM</sub> = V<sup>+</sup>/2, and R<sub>L</sub> = 10 kΩ to V<sup>+</sup>/2.

**Boldface** limits apply at the temperature extremes.

Parameter		Test Conditions	Min <sup>(2)</sup>	Typ <sup>(3)</sup>	Max <sup>(2)</sup>	Units
V <sub>OS</sub>	Input Offset Voltage			±0.26 See <sup>(4)</sup>	±1 <b>±1.2</b>	mV
TCV <sub>OS</sub>	Input Offset Voltage Drift <sup>(5)</sup>			±0.4 See <sup>(4)</sup>	±2	µV/°C
I <sub>B</sub>	Input Bias Current <sup>(5)</sup>			0.1	10 <b>500</b>	pA

- (1) Electrical table values apply only for factory testing conditions at the temperature indicated. Factory testing conditions result in very limited self-heating of the device.
- (2) Limits are 100% production tested at 25°C. Limits over the operating temperature range are specified through correlations using statistical quality control (SQC) method.
- (3) Typical values represent the most likely parametric norm as determined at the time of characterization. Actual typical values may vary over time and will also depend on the application and configuration. The typical values are not tested and are not ensured on shipped production material.
- (4) The typical value is calculated by applying absolute value transform to the distribution, then taking the statistical average of the resulting distribution
- (5) This parameter is specified by design and/or characterization and is not tested in production.

### 3.3V Electrical Characteristics <sup>(1)</sup> (continued)

Unless otherwise specified, all limits are specified for  $T_A = 25^\circ\text{C}$ ,  $V^+ = 3.3\text{V}$ ,  $V^- = 0\text{V}$ ,  $V_{\text{CM}} = V^+/2$ , and  $R_L = 10\text{ k}\Omega$  to  $V^+/2$ .

**Boldface** limits apply at the temperature extremes.

Parameter		Test Conditions	Min <sup>(2)</sup>	Typ <sup>(3)</sup>	Max <sup>(2)</sup>	Units
$I_{\text{OS}}$	Input Offset Current			1		pA
CMRR	Common Mode Rejection Ratio	$-0.2\text{V} < V_{\text{CM}} < V^+ - 1.2\text{V}$	76 <b>75</b>	92 See <sup>(4)</sup>		dB
PSRR	Power Supply Rejection Ratio	$2.7\text{V} \leq V^+ \leq 5.5\text{V}$ , $V_{\text{OUT}} = 1\text{V}$	75 <b>74</b>	93 <sup>(4)</sup>		dB
EMIRR	EMI Rejection Ratio, IN+ and IN- <sup>(6)</sup>	$V_{\text{RFpeak}} = 100\text{ mV}_P$ ( $-20\text{ dBV}_P$ ), $f = 400\text{ MHz}$		64		dB
		$V_{\text{RFpeak}} = 100\text{ mV}_P$ ( $-20\text{ dBV}_P$ ), $f = 900\text{ MHz}$		78		
		$V_{\text{RFpeak}} = 100\text{ mV}_P$ ( $-20\text{ dBV}_P$ ), $f = 1800\text{ MHz}$		87		
		$V_{\text{RFpeak}} = 100\text{ mV}_P$ ( $-20\text{ dBV}_P$ ), $f = 2400\text{ MHz}$		90		
CMVR	Input Common-Mode Voltage Range	CMRR $\geq 76\text{ dB}$	-0.2		2.1	V
$A_{\text{VOL}}$	Large Signal Voltage Gain <sup>(7)</sup>	$R_L = 2\text{ k}\Omega$ , $V_{\text{OUT}} = 0.15\text{V to } 1.65\text{V}$ , $V_{\text{OUT}} = 3.15\text{V to } 1.65\text{V}$	100 <b>97</b>	114		dB
		$R_L = 10\text{ k}\Omega$ , $V_{\text{OUT}} = 0.1\text{V to } 1.65\text{V}$ , $V_{\text{OUT}} = 3.2\text{V to } 1.65\text{V}$	100 <b>97</b>	115		
$V_{\text{O}}$	Output Swing High, (measured from $V^+$ )	$R_L = 2\text{ k}\Omega$ to $V^+/2$		31	35 <b>43</b>	mV
		$R_L = 10\text{ k}\Omega$ to $V^+/2$		7	10 <b>12</b>	
	Output Swing Low, (measured from $V^-$ )	$R_L = 2\text{ k}\Omega$ to $V^+/2$		26	32 <b>43</b>	mV
		$R_L = 10\text{ k}\Omega$ to $V^+/2$		6	11 <b>14</b>	
$I_{\text{O}}$	Output Short Circuit Current	Sourcing, $V_{\text{OUT}} = V_{\text{CM}}$ , $V_{\text{IN}} = 100\text{ mV}$	25 <b>20</b>	28		mA
		Sinking, $V_{\text{OUT}} = V_{\text{CM}}$ , $V_{\text{IN}} = -100\text{ mV}$	28 <b>20</b>	31		
$I_{\text{S}}$	Supply Current	LMV851		0.42	0.50 <b>0.58</b>	mA
		LMV852		0.79	0.90 <b>1.06</b>	
		LMV854		1.54	1.67 <b>1.99</b>	
SR	Slew Rate <sup>(8)</sup>	$A_V = +1$ , $V_{\text{OUT}} = 1\text{ V}_{\text{PP}}$ , 10% to 90%		4.5		V/ $\mu\text{s}$
GBW	Gain Bandwidth Product			8		MHz
$\Phi_m$	Phase Margin			62		deg
$e_n$	Input-Referred Voltage Noise	$f = 1\text{ kHz}$		11		nV/ $\sqrt{\text{Hz}}$
		$f = 10\text{ kHz}$		10		
$i_n$	Input-Referred Current Noise	$f = 1\text{ kHz}$		0.005		pA/ $\sqrt{\text{Hz}}$
$R_{\text{OUT}}$	Closed Loop Output Impedance	$f = 6\text{ MHz}$		400		$\Omega$
$C_{\text{IN}}$	Common-Mode Input Capacitance			11		pF
	Differential-Mode Input Capacitance			6		
THD+N	Total Harmonic Distortion + Noise	$f = 1\text{ kHz}$ , $A_V = 1$ , BW = $>500\text{ kHz}$		0.006		%

(6) The EMI Rejection Ratio is defined as  $\text{EMIRR} = 20\log(V_{\text{RFpeak}}/\Delta V_{\text{OS}})$ .

(7) The specified limits represent the lower of the measured values for each output range condition.

(8) Number specified is the slower of positive and negative slew rates.

### 5V Electrical Characteristics <sup>(1)</sup>

Unless otherwise specified, all limits are specified for  $T_A = 25^\circ\text{C}$ ,  $V^+ = 5\text{V}$ ,  $V^- = 0\text{V}$ ,  $V_{\text{CM}} = V^+/2$ , and  $R_L = 10\text{ k}\Omega$  to  $V^+/2$ .

**Boldface** limits apply at the temperature extremes.

Parameter		Test Conditions	Min <sup>(2)</sup>	Typ <sup>(3)</sup>	Max <sup>(2)</sup>	Units
$V_{\text{OS}}$	Input Offset Voltage			$\pm 0.26$ See <sup>(4)</sup>	$\pm 1$ <b><math>\pm 1.2</math></b>	mV
$\text{TCV}_{\text{OS}}$	Input Offset Voltage Drift <sup>(5)</sup>			$\pm 0.4$ See <sup>(4)</sup>	$\pm 2$	$\mu\text{V}/^\circ\text{C}$
$I_{\text{B}}$	Input Bias Current <sup>(5)</sup>			0.1	10 <b>500</b>	$\mu\text{A}$
$I_{\text{OS}}$	Input Offset Current			1		$\mu\text{A}$
CMRR	Common Mode Rejection Ratio	$-0.2\text{V} \leq V_{\text{CM}} \leq V^+ - 1.2\text{V}$	77 <b>76</b>	94 See <sup>(4)</sup>		dB
PSRR	Power Supply Rejection Ratio	$2.7\text{V} \leq V^+ \leq 5.5\text{V}$ , $V_{\text{OUT}} = 1\text{V}$	75 <b>74</b>	93 See <sup>(4)</sup>		dB
EMIRR	EMI Rejection Ratio, IN+ and IN- <sup>(6)</sup>	$V_{\text{RFpeak}} = 100\text{ mV}_\text{P}$ ( $-20\text{ dBV}_\text{P}$ ), $f = 400\text{ MHz}$		64		dB
		$V_{\text{RFpeak}} = 100\text{ mV}_\text{P}$ ( $-20\text{ dBV}_\text{P}$ ), $f = 900\text{ MHz}$		76		
		$V_{\text{RFpeak}} = 100\text{ mV}_\text{P}$ ( $-20\text{ dBV}_\text{P}$ ), $f = 1800\text{ MHz}$		84		
		$V_{\text{RFpeak}} = 100\text{ mV}_\text{P}$ ( $-20\text{ dBV}_\text{P}$ ), $f = 2400\text{ MHz}$		89		
CMVR	Input Common-Mode Voltage Range	CMRR $\geq 77\text{ dB}$	-0.2		3.8	V
$A_{\text{VOL}}$	Large Signal Voltage Gain <sup>(7)</sup>	$R_L = 2\text{ k}\Omega$ , $V_{\text{OUT}} = 0.15\text{V}$ to $2.5\text{V}$ , $V_{\text{OUT}} = 4.85\text{V}$ to $2.5\text{V}$	105 <b>102</b>	118		dB
		$R_L = 10\text{ k}\Omega$ , $V_{\text{OUT}} = 0.1\text{V}$ to $2.5\text{V}$ , $V_{\text{OUT}} = 4.9\text{V}$ to $2.5\text{V}$	105 <b>102</b>	120		
$V_{\text{O}}$	Output Swing High, (measured from $V^+$ )	$R_L = 2\text{ k}\Omega$ to $V^+/2$		34	39 <b>47</b>	mV
		$R_L = 10\text{ k}\Omega$ to $V^+/2$		7	11 <b>13</b>	
	Output Swing Low, (measured from $V^-$ )	$R_L = 2\text{ k}\Omega$ to $V^+/2$		31	38 <b>50</b>	mV
		$R_L = 10\text{ k}\Omega$ to $V^+/2$		7	12 <b>15</b>	
$I_{\text{O}}$	Output Short Circuit Current	Sourcing, $V_{\text{OUT}} = V_{\text{CM}}$ , $V_{\text{IN}} = 100\text{ mV}$	60 <b>48</b>	65		mA
		Sinking, $V_{\text{OUT}} = V_{\text{CM}}$ , $V_{\text{IN}} = -100\text{ mV}$	58 <b>44</b>	62		
$I_{\text{S}}$	Supply Current	LMV851		0.43	0.52 <b>0.60</b>	mA
		LMV852		0.82	0.93 <b>1.09</b>	
		LMV854		1.59	1.73 <b>2.05</b>	

- Electrical table values apply only for factory testing conditions at the temperature indicated. Factory testing conditions result in very limited self-heating of the device.
- Limits are 100% production tested at  $25^\circ\text{C}$ . Limits over the operating temperature range are specified through correlations using statistical quality control (SQC) method.
- Typical values represent the most likely parametric norm as determined at the time of characterization. Actual typical values may vary over time and will also depend on the application and configuration. The typical values are not tested and are not ensured on shipped production material.
- The typical value is calculated by applying absolute value transform to the distribution, then taking the statistical average of the resulting distribution
- This parameter is specified by design and/or characterization and is not tested in production.
- The EMI Rejection Ratio is defined as  $\text{EMIRR} = 20\log (V_{\text{RFpeak}}/\Delta V_{\text{OS}})$ .
- The specified limits represent the lower of the measured values for each output range condition.

### 5V Electrical Characteristics <sup>(1)</sup> (continued)

Unless otherwise specified, all limits are specified for  $T_A = 25^\circ\text{C}$ ,  $V^+ = 5\text{V}$ ,  $V^- = 0\text{V}$ ,  $V_{\text{CM}} = V^+/2$ , and  $R_L = 10\text{ k}\Omega$  to  $V^+/2$ .

**Boldface** limits apply at the temperature extremes.

Parameter		Test Conditions	Min <sup>(2)</sup>	Typ <sup>(3)</sup>	Max <sup>(2)</sup>	Units
SR	Slew Rate <sup>(8)</sup>	$A_V = +1$ , $V_{\text{OUT}} = 2 V_{\text{PP}}$ , 10% to 90%		4.5		V/ $\mu\text{s}$
GBW	Gain Bandwidth Product			8		MHz
$\Phi_m$	Phase Margin			64		deg
$e_n$	Input-Referred Voltage Noise	$f = 1\text{ kHz}$		11		nV/ $\sqrt{\text{Hz}}$
		$f = 10\text{ kHz}$		10		
$i_n$	Input-Referred Current Noise	$f = 1\text{ kHz}$		0.005		pA/ $\sqrt{\text{Hz}}$
$R_{\text{OUT}}$	Closed Loop Output Impedance	$f = 6\text{ MHz}$		400		$\Omega$
$C_{\text{IN}}$	Common-Mode Input Capacitance			11		pF
	Differential-Mode Input Capacitance			6		
THD+N	Total Harmonic Distortion + Noise	$f = 1\text{ kHz}$ , $A_V = 1$ , $\text{BW} = >500\text{ kHz}$		0.003		%

(8) Number specified is the slower of positive and negative slew rates.

### Connection Diagrams

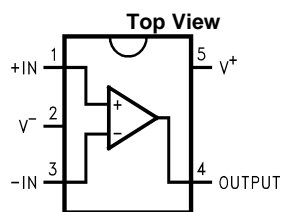


Figure 2. 5-Pin SC70 Package  
See Package Number DCK0005A

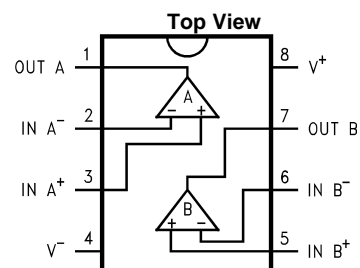


Figure 3. 8-Pin VSSOP Package  
See Package Number DGK0008A

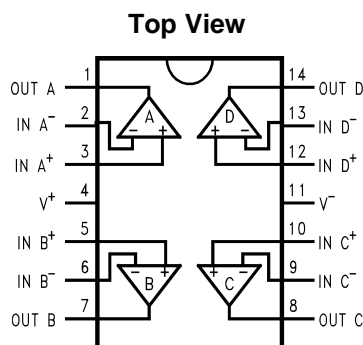


Figure 4. 14-Pin TSSOP Package  
See Package Number PW0014A

### Typical Performance Characteristics

At  $T_A = 25^\circ\text{C}$ ,  $R_L = 10\text{ k}\Omega$ ,  $V_S = 3.3\text{V}$ , unless otherwise specified.

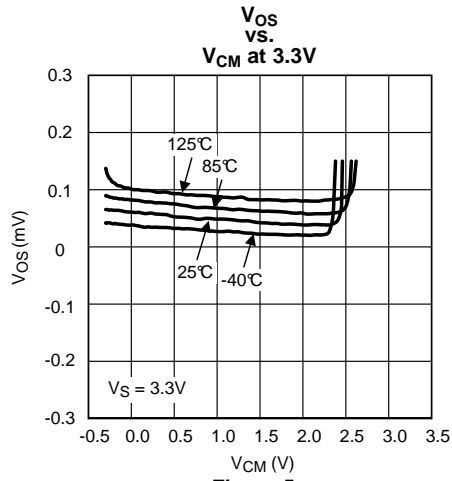


Figure 5.

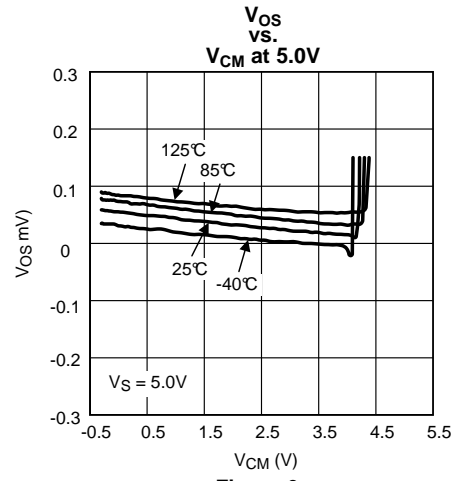


Figure 6.

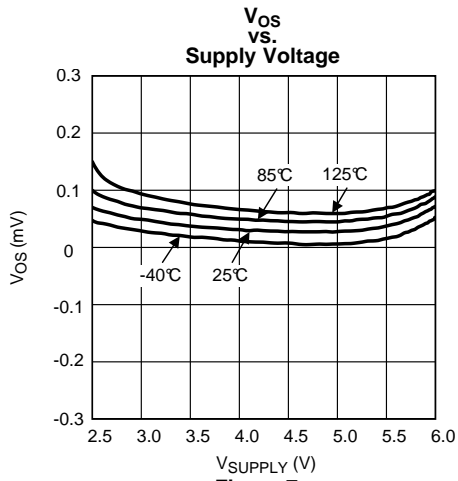


Figure 7.

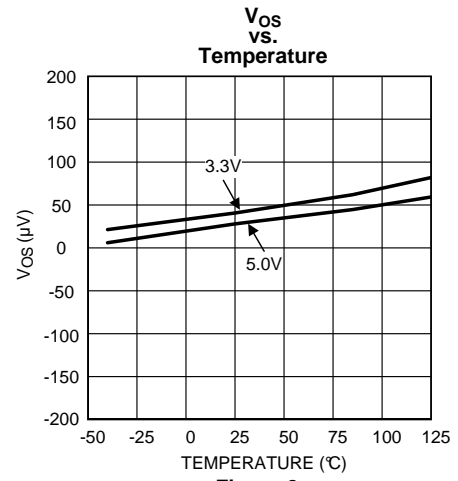


Figure 8.

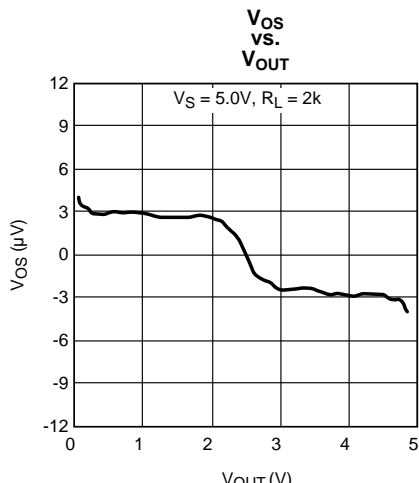


Figure 9.

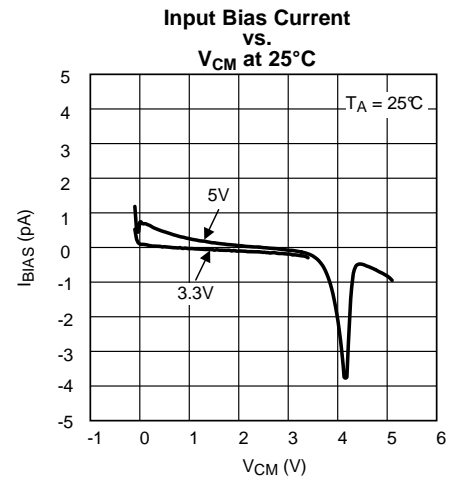


Figure 10.

Typical Performance Characteristics (continued)

At  $T_A = 25^\circ\text{C}$ ,  $R_L = 10\text{ k}\Omega$ ,  $V_S = 3.3\text{V}$ , unless otherwise specified.

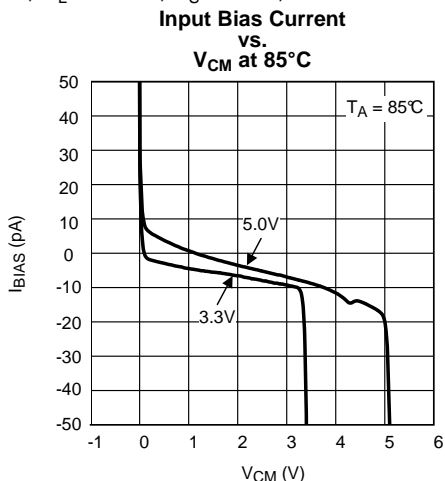


Figure 11.

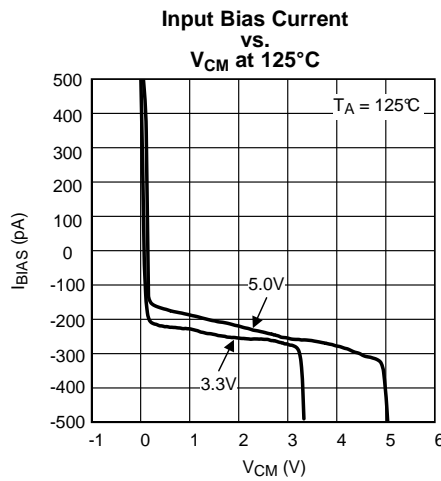


Figure 12.

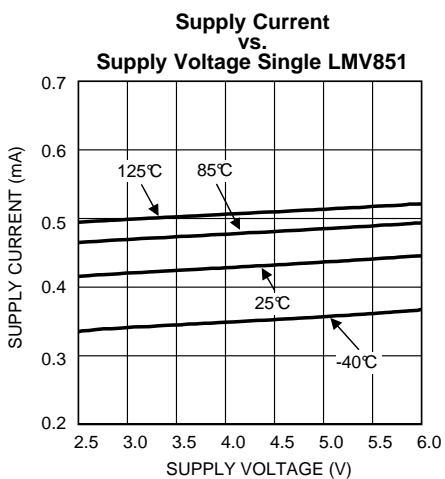


Figure 13.

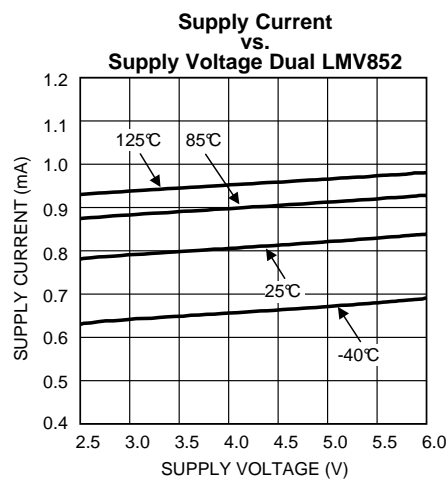


Figure 14.

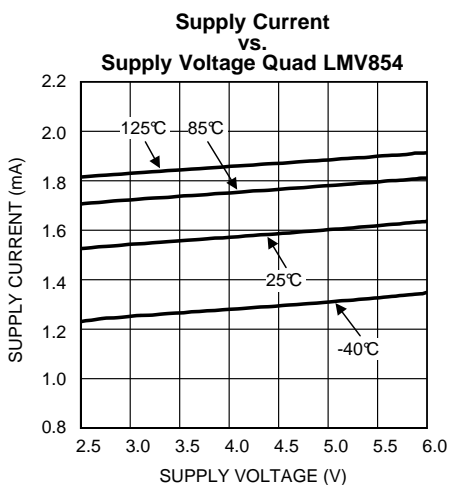


Figure 15.

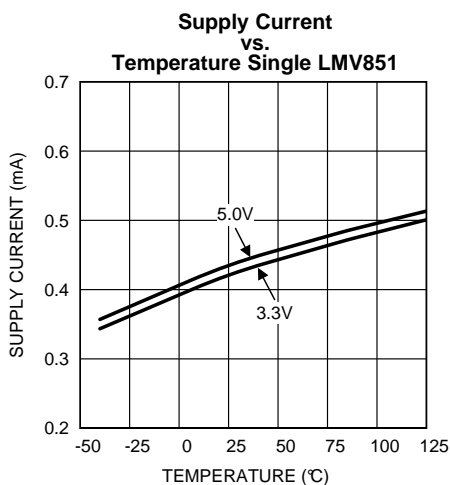


Figure 16.

**Typical Performance Characteristics (continued)**

At  $T_A = 25^\circ\text{C}$ ,  $R_L = 10\text{ k}\Omega$ ,  $V_S = 3.3\text{V}$ , unless otherwise specified.

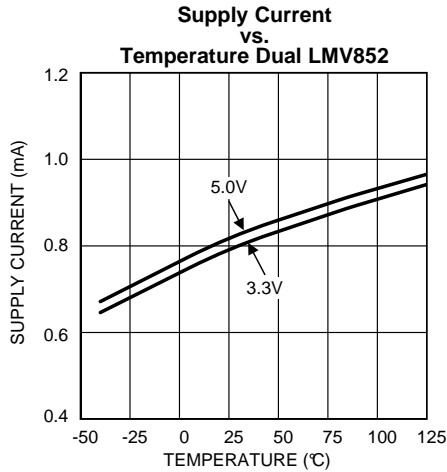


Figure 17.

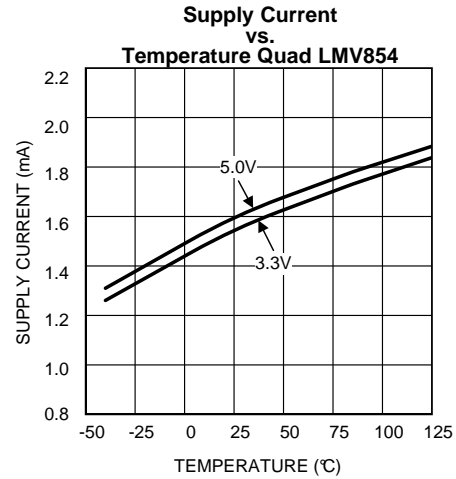


Figure 18.

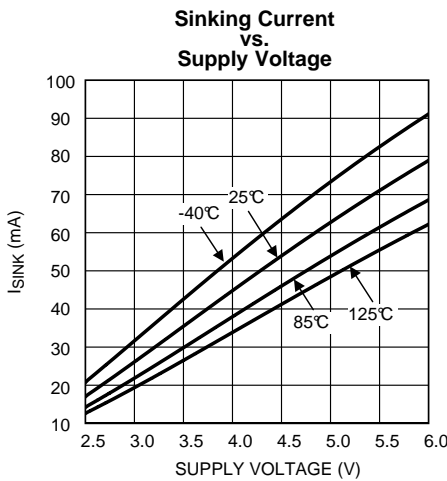


Figure 19.

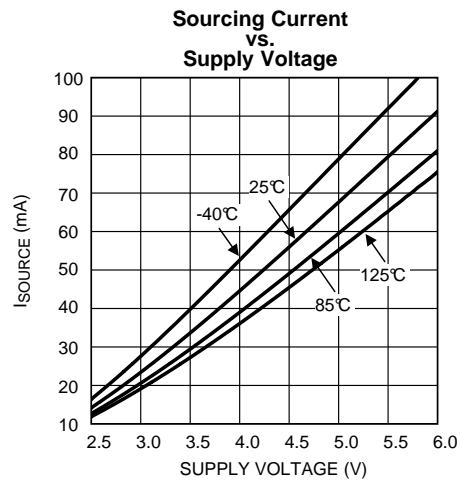


Figure 20.

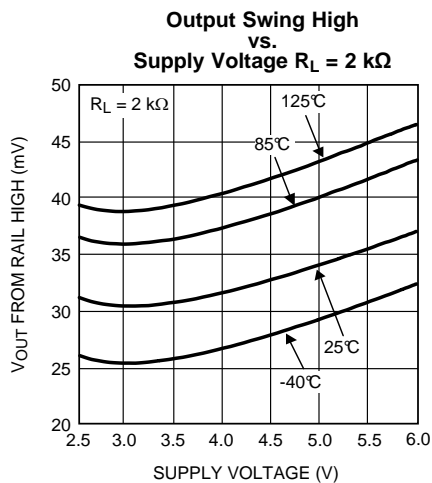


Figure 21.

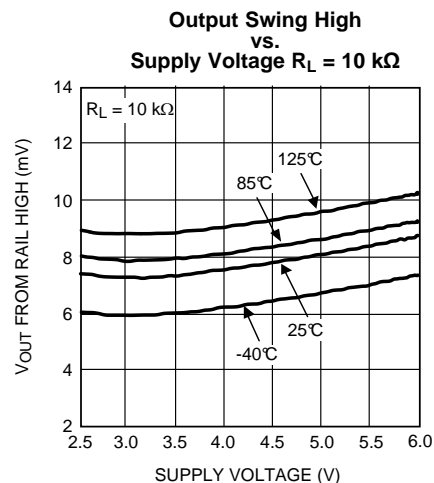


Figure 22.



Typical Performance Characteristics (continued)

At  $T_A = 25^\circ\text{C}$ ,  $R_L = 10\text{ k}\Omega$ ,  $V_S = 3.3\text{V}$ , unless otherwise specified.

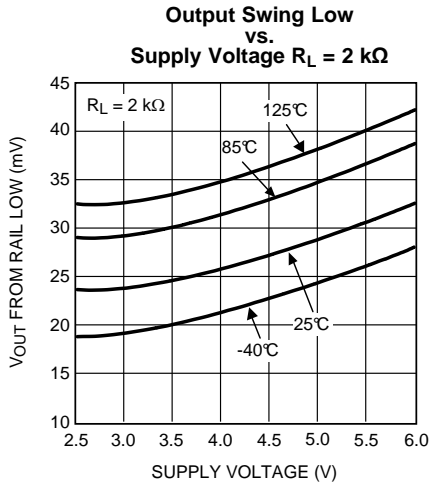


Figure 23.

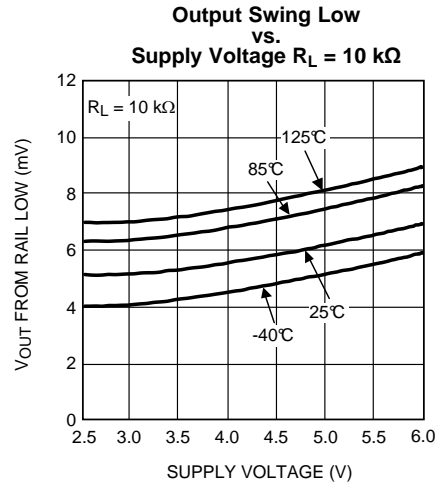


Figure 24.

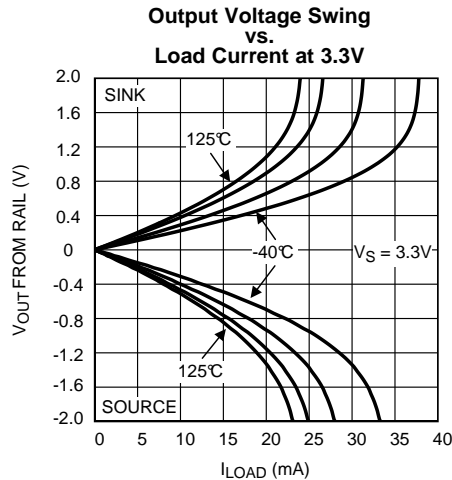


Figure 25.

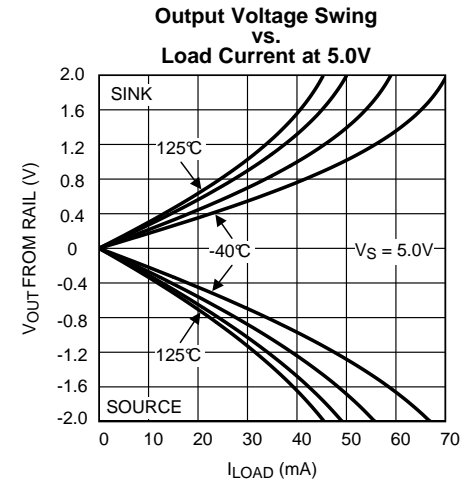


Figure 26.

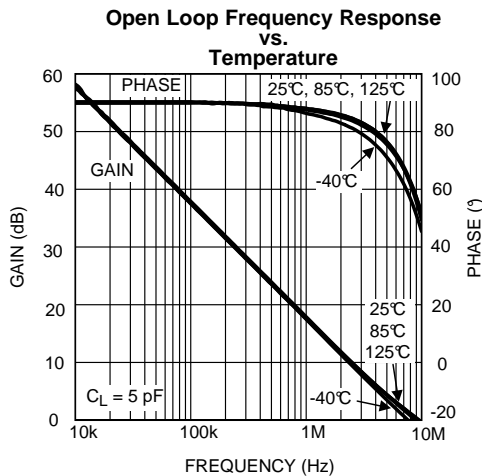


Figure 27.

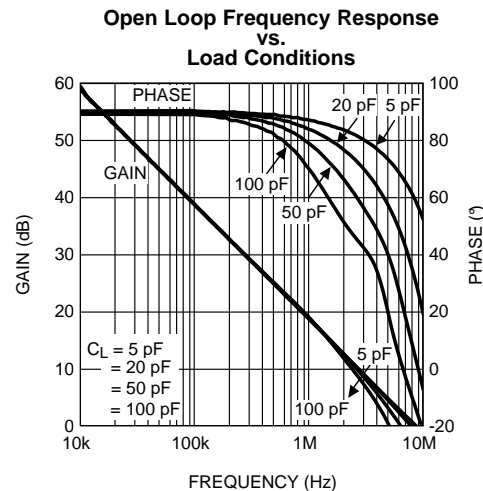
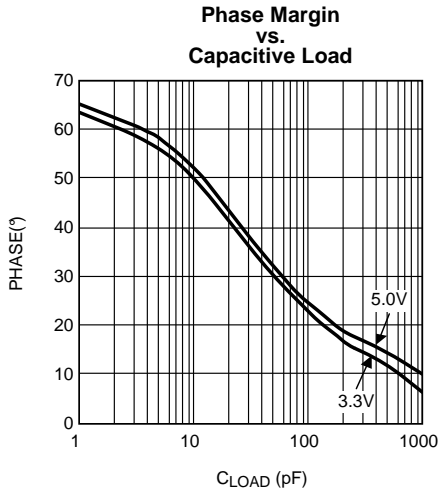


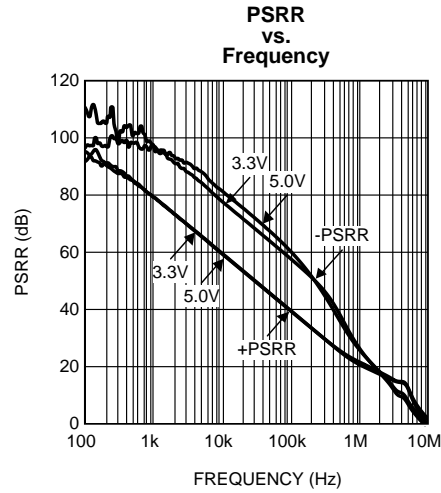
Figure 28.

**Typical Performance Characteristics (continued)**

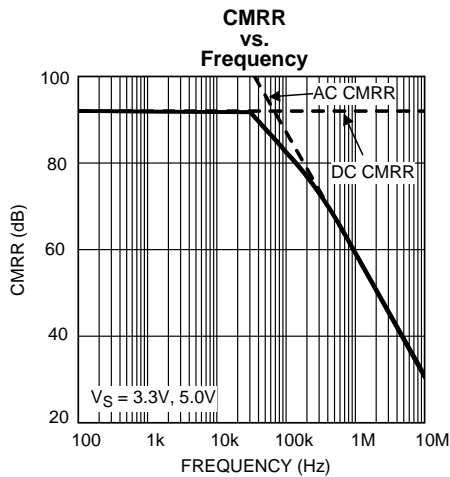
At  $T_A = 25^\circ\text{C}$ ,  $R_L = 10\text{ k}\Omega$ ,  $V_S = 3.3\text{V}$ , unless otherwise specified.



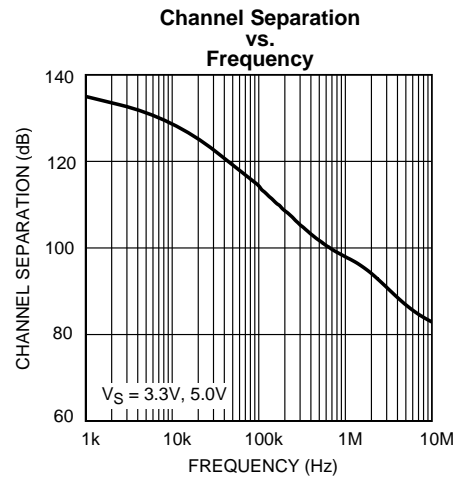
**Figure 29.**



**Figure 30.**

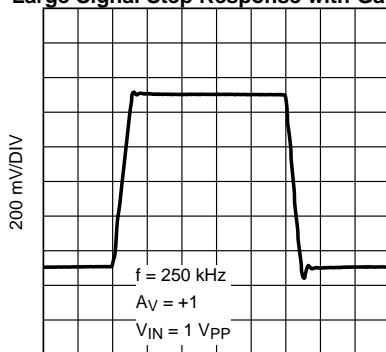


**Figure 31.**



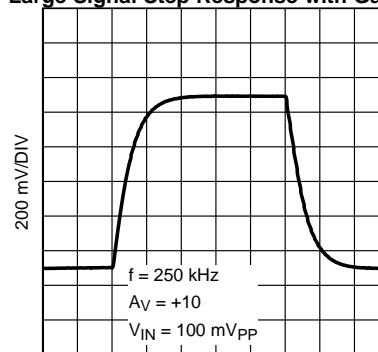
**Figure 32.**

**Large Signal Step Response with Gain = 1**



**Figure 33.**

**Large Signal Step Response with Gain = 10**



**Figure 34.**

Typical Performance Characteristics (continued)

At  $T_A = 25^\circ\text{C}$ ,  $R_L = 10\text{ k}\Omega$ ,  $V_S = 3.3\text{V}$ , unless otherwise specified.

Small Signal Step Response with Gain = 1

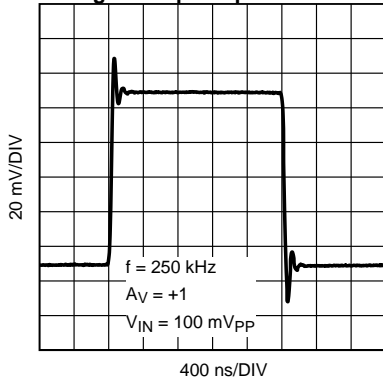


Figure 35.

Small Signal Step Response with Gain = 10

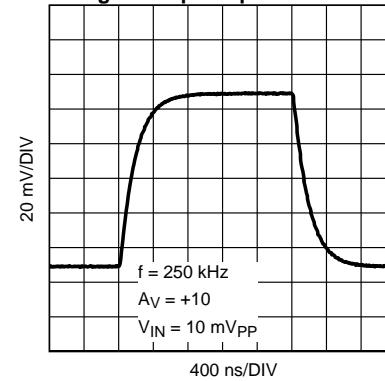


Figure 36.

Slew Rate vs. Supply Voltage

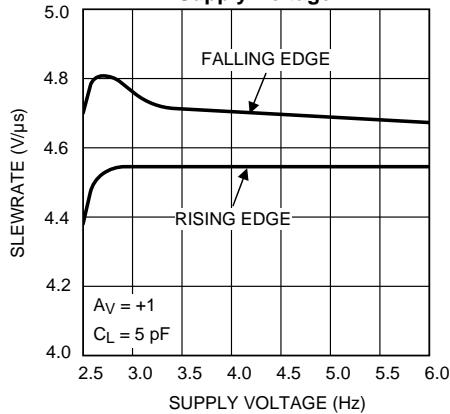


Figure 37.

Overshoot vs. Capacitive Load

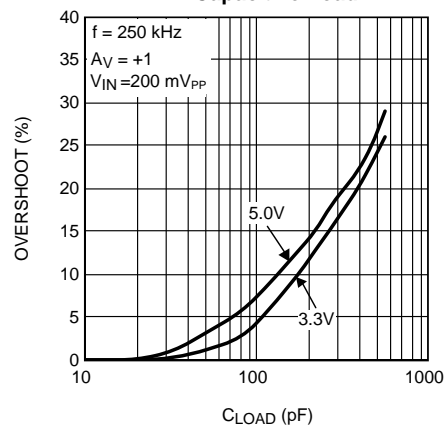


Figure 38.

Input Voltage Noise vs. Frequency

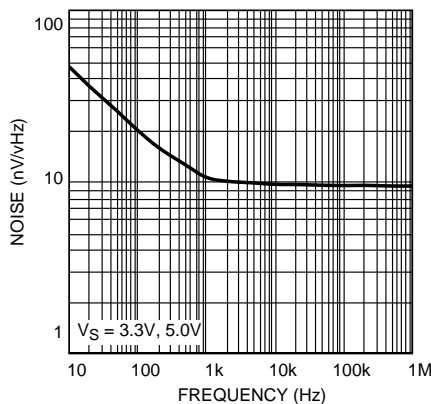


Figure 39.

THD+N vs. Frequency

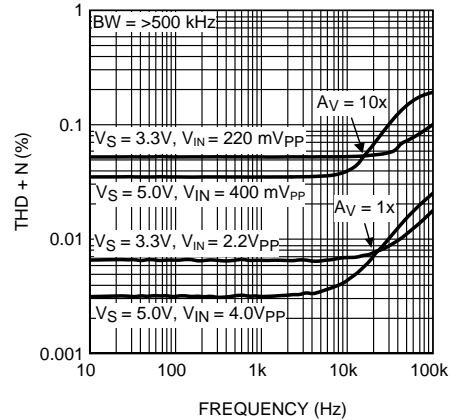


Figure 40.

**Typical Performance Characteristics (continued)**

At  $T_A = 25^\circ\text{C}$ ,  $R_L = 10\text{ k}\Omega$ ,  $V_S = 3.3\text{V}$ , unless otherwise specified.

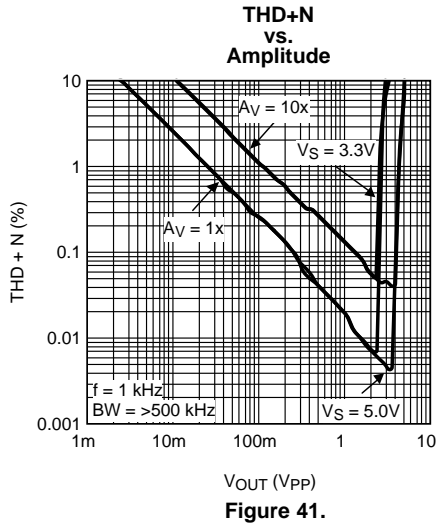


Figure 41.

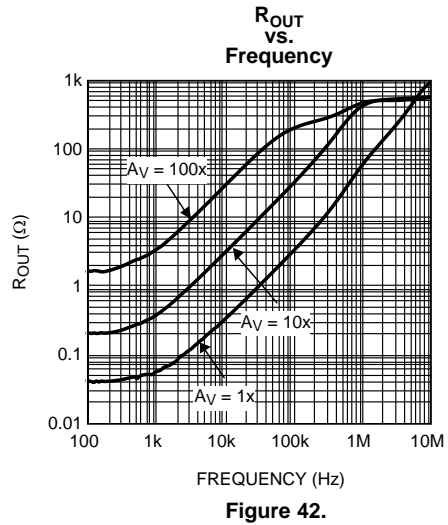


Figure 42.

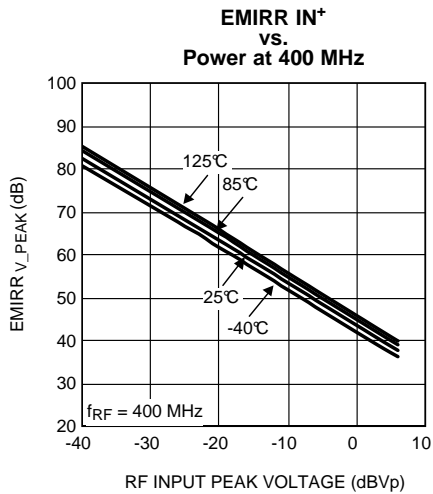


Figure 43.

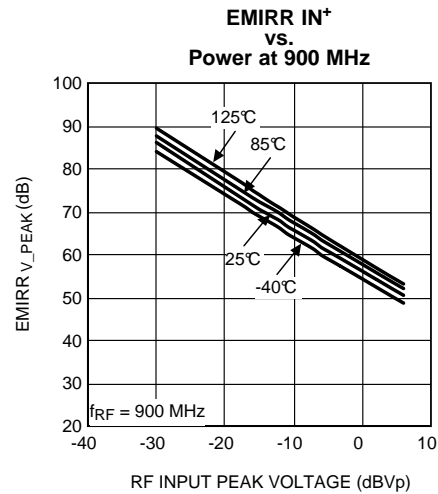


Figure 44.

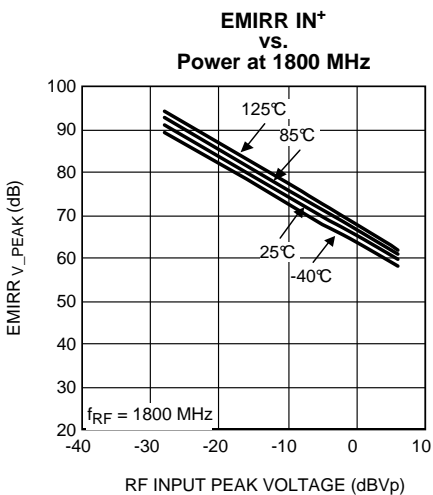


Figure 45.

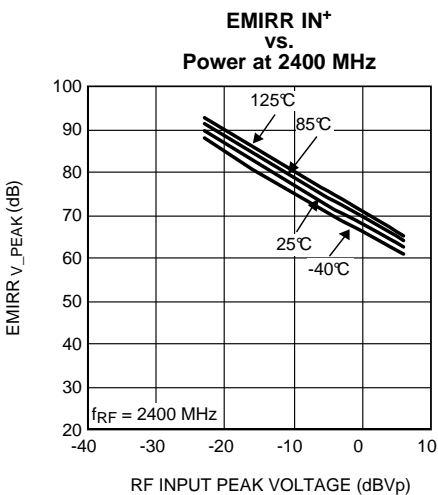
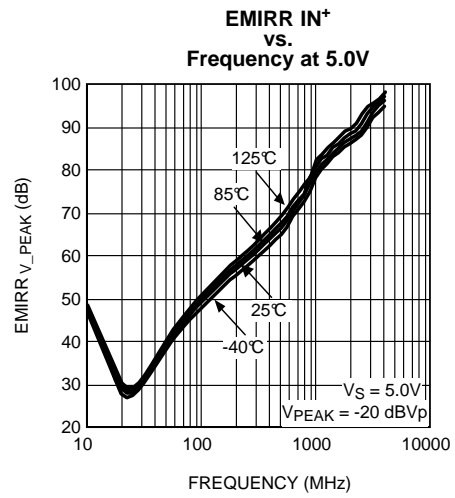
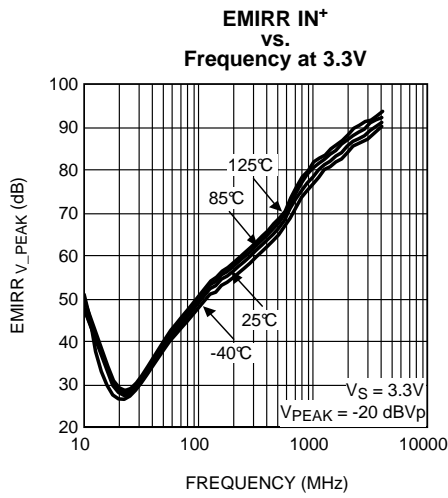


Figure 46.

**Typical Performance Characteristics (continued)**

At  $T_A = 25^\circ\text{C}$ ,  $R_L = 10\text{ k}\Omega$ ,  $V_S = 3.3\text{V}$ , unless otherwise specified.



## APPLICATION INFORMATION

### INTRODUCTION

The LMV851/LMV852/LMV854 are operational amplifiers with very good specifications, such as low offset, low noise and a rail-to-rail output. These specifications make the LMV851/LMV852/LMV854 great choices to use in areas such as medical and instrumentation. The low supply current is perfect for battery powered equipment. The small packages, SC-70 package for the LMV851, the VSSOP package for the dual LMV852 and the TSSOP package for the quad LMV854, make any of these parts a perfect choice for portable electronics. Additionally, the EMI hardening makes the LMV851/LMV852 or LMV854 a must for almost all op amp applications. Most applications are exposed to Radio Frequency (RF) signals such as the signals transmitted by mobile phones or wireless computer peripherals. The LMV851/LMV852/LMV854 will effectively reduce disturbances caused by RF signals to a level that will be hardly noticeable. This again reduces the need for additional filtering and shielding. Using this EMI resistant series of op amps will thus reduce the number of components and space needed for applications that are affected by EMI, and will help applications, not yet identified as possible EMI sensitive, to be more robust for EMI.

### INPUT CHARACTERISTICS

The input common mode voltage range of the LMV851/LMV852/LMV854 includes ground, and can even sense well below ground. The CMRR level does not degrade for input levels up to 1.2V below the supply voltage. For a supply voltage of 5V, the maximum voltage that should be applied to the input for best CMRR performance is thus 3.8V.

When not configured as unity gain, this input limitation will usually not degrade the effective signal range. The output is rail-to-rail and therefore will introduce no limitations to the signal range.

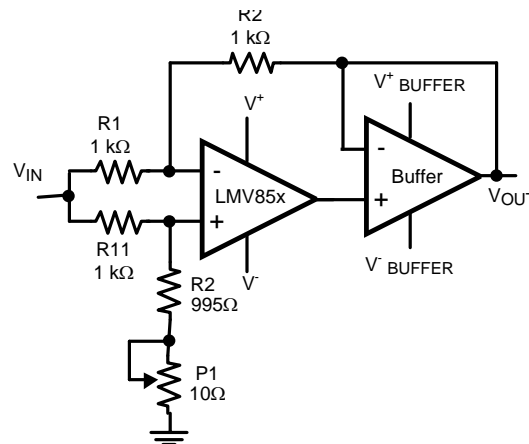
The typical offset is only 0.26 mV, and the  $TCV_{OS}$  is 0.4  $\mu\text{V}/^\circ\text{C}$ , specifications close to precision op amps.

### CMRR MEASUREMENT

The CMRR measurement results may need some clarification. This is because different setups are used to measure the AC CMRR and the DC CMRR.

The DC CMRR is derived from  $\Delta V_{OS}$  versus  $\Delta V_{CM}$ . This value is stated in the tables, and is tested during production testing.

The AC CMRR is measured with the test circuit shown in [Figure 49](#).



**Figure 49. AC CMRR Measurement Setup**

The configuration is largely the usually applied balanced configuration. With potentiometer P1, the balance can be tuned to compensate for the DC offset in the DUT. The main difference is the addition of the buffer. This buffer prevents the open-loop output impedance of the DUT from affecting the balance of the feedback network. Now the closed-loop output impedance of the buffer is a part of the balance. But as the closed-loop output impedance is much lower, and by careful selection of the buffer also has a larger bandwidth, the total effect is that the CMRR of the DUT can be measured much more accurately. The differences are apparent in the larger measured bandwidth of the AC CMRR.

One artifact from this test circuit is that the low frequency CMRR results appear higher than expected. This is because in the AC CMRR test circuit the potentiometer is used to compensate for the DC mismatches. So, mainly AC mismatch is all that remains. Therefore, the obtained DC CMRR from this AC CMRR test circuit tends to be higher than the actual DC CMRR based on DC measurements.

The CMRR curve in Figure 50 shows a combination of the AC CMRR and the DC CMRR.

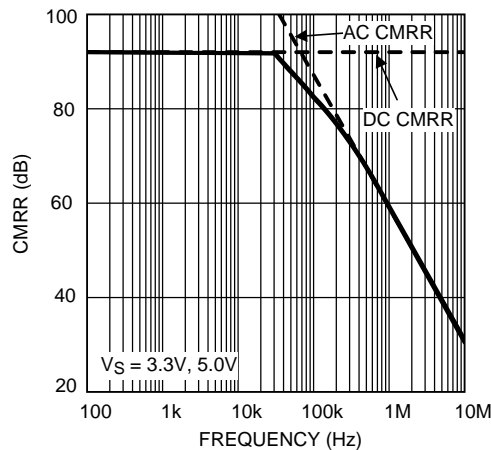


Figure 50. CMRR Curve

## OUTPUT CHARACTERISTICS

As already mentioned the output is rail to rail. When loading the output with a 10 kΩ resistor the maximum swing of the output is typically 7 mV from the positive and negative rail

The LMV851/LMV852/LMV854 can be connected as non-inverting unity gain amplifiers. This configuration is the most sensitive to capacitive loading. The combination of a capacitive load placed at the output of an amplifier along with the amplifier's output impedance creates a phase lag, which reduces the phase margin of the amplifier. If the phase margin is significantly reduced, the response will be under damped which causes peaking in the transfer and, when there is too much peaking, the op amp might start oscillating. The LMV851/LMV852/LMV854 can directly drive capacitive loads up to 200 pF without any stability issues. In order to drive heavier capacitive loads, an isolation resistor,  $R_{ISO}$ , should be used, as shown in Figure 51. By using this isolation resistor, the capacitive load is isolated from the amplifier's output, and hence, the pole caused by  $C_L$  is no longer in the feedback loop. The larger the value of  $R_{ISO}$ , the more stable the amplifier will be. If the value of  $R_{ISO}$  is sufficiently large, the feedback loop will be stable, independent of the value of  $C_L$ . However, larger values of  $R_{ISO}$  result in reduced output swing and reduced output current drive.

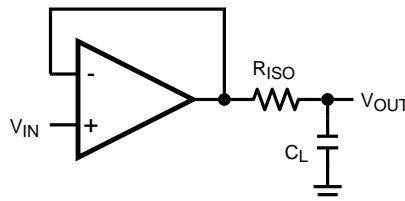


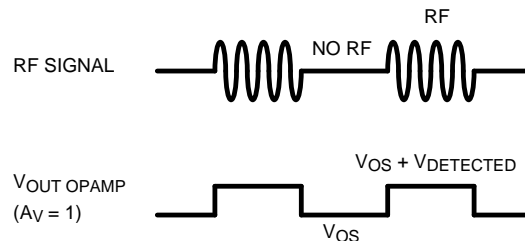
Figure 51. Isolating Capacitive Load

## EMIRR

With the increase of RF transmitting devices in the world, the electromagnetic interference (EMI) between those devices and other equipment becomes a bigger challenge. The LMV851/LMV852/LMV854 are EMI hardened op amps which are specifically designed to overcome electromagnetic interference. Along with EMI hardened op amps, the EMIRR parameter is introduced to unambiguously specify the EMI performance of an op amp. This section presents an overview of EMIRR. A detailed description on this specification for EMI hardened op amps can be found in Application Note AN-1698([SNOA497](#)).

The dimensions of an op amp IC are relatively small compared to the wavelength of the disturbing RF signals. As a result the op amp itself will hardly receive any disturbances. The RF signals interfering with the op amp are dominantly received by the PCB and wiring connected to the op amp. As a result the RF signals on the pins of the op amp can be represented by voltages and currents. This representation significantly simplifies the unambiguous measurement and specification of the EMI performance of an op amp.

RF signals interfere with op amps via the non-linearity of the op amp circuitry. This non-linearity results in the detection of the so called out-of-band signals. The obtained effect is that the amplitude modulation of the out-of-band signal is down-converted into the base band. This base band can easily overlap with the band of the op amp circuit. As an example [Figure 52](#) depicts a typical output signal of a unity-gain connected op amp in the presence of an interfering RF signal. Clearly the output voltage varies in the rhythm of the on-off keying of the RF carrier.



**Figure 52. Offset Voltage Variation Due to an Interfering RF Signal**

### EMIRR Definition

To identify EMI hardened op amps, a parameter is needed that quantitatively describes the EMI performance of op amps. A quantitative measure enables the comparison and the ranking of op amps on their EMI robustness. Therefore the EMI Rejection Ratio (EMIRR) is introduced. This parameter describes the resulting input-referred offset voltage shift of an op amp as a result of an applied RF carrier (interference) with a certain frequency and level. The definition of EMIRR is given by:

$$\text{EMIRR}_{V_{\text{RF\_PEAK}}} = 20 \log \left( \frac{V_{\text{RF\_PEAK}}}{\Delta V_{\text{OS}}} \right) \quad (1)$$

In which  $V_{\text{RF\_PEAK}}$  is the amplitude of the applied un-modulated RF signal (V) and  $\Delta V_{\text{OS}}$  is the resulting input-referred offset voltage shift (V). The offset voltage depends quadratically on the applied RF level, and therefore, the RF level at which the EMIRR is determined should be specified. The standard level for the RF signal is 100 mV<sub>p</sub>. Application Note AN-1698([SNOA497](#)) addresses the conversion of an EMIRR measured for another signal level than 100 mV<sub>p</sub>. The interpretation of the EMIRR parameter is straightforward. When two op amps have an EMIRR which differ by 20 dB, the resulting error signals when used in identical configurations, differs by 20 dB as well. So, the higher the EMIRR, the more robust the op amp.

### Coupling an RF Signal to the IN<sup>+</sup> Pin

Each of the op amp pins can be tested separately on EMIRR. In this section the measurements on the IN<sup>+</sup> pin (which, based on symmetry considerations, also apply to the IN<sup>-</sup> pin) are discussed. In Application Note AN-1698([SNOA497](#)) the other pins of the op amp are treated as well. For testing the IN<sup>+</sup> pin the op amp is connected in the unity gain configuration. Applying the RF signal is straightforward as it can be connected directly to the IN<sup>+</sup> pin. As a result the RF signal path has a minimum of components that might affect the RF signal level at the pin. The circuit diagram is shown in [Figure 53](#). The PCB trace from RF<sub>IN</sub> to the IN<sup>+</sup> pin should



be a 50Ω stripline in order to match the RF impedance of the cabling and the RF generator. On the PCB a 50Ω termination is used. This 50Ω resistor is also used to set the bias level of the IN+ pin to ground level. For determining the EMIRR, two measurements are needed: one is measuring the DC output level when the RF signal is off; and the other is measuring the DC output level when the RF signal is switched on. The difference of the two DC levels is the output voltage shift as a result of the RF signal. As the op amp is in the unity gain configuration, the input referred offset voltage shift corresponds one-to-one to the measured output voltage shift.

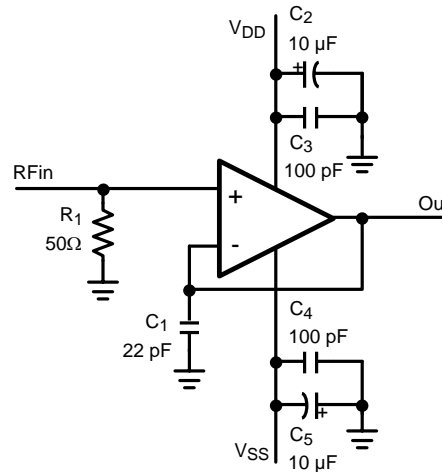


Figure 53. Circuit for Coupling the RF Signal to IN+

### Cell Phone Call

The effect of electromagnetic interference is demonstrated in a setup where a cell phone interferes with a pressure sensor application (Figure 55). This application needs two op amps and therefore a dual op amp is used. The experiment is performed on two different dual op amps: a typical standard op amp and the LMV852, EMI hardened dual op amp. The op amps are placed in a single supply configuration. The cell phone is placed on a fixed position a couple of centimeters from the op amps.

When the cell phone is called, the PCB and wiring connected to the op amps receive the RF signal. Subsequently, the op amps detect the RF voltages and currents that end up at their pins. The resulting effect on the output of the second op amp is shown in Figure 54.

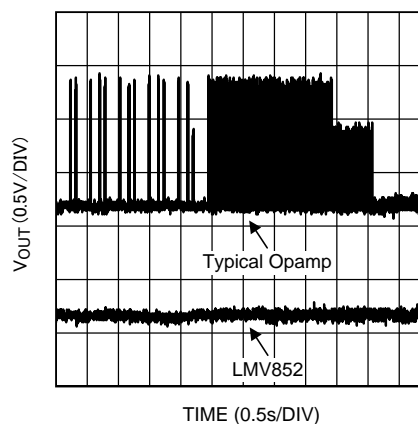


Figure 54. Comparing EMI Robustness

The difference between the two types of dual op amps is clearly visible. The typical standard dual op amp has an output shift (disturbed signal) larger than 1V as a result of the RF signal transmitted by the cell phone. The LMV852, EMI hardened op amp does not show any significant disturbances.

## DECOUPLING AND LAYOUT

Care must be given when creating a board layout for the op amp. For decoupling the supply lines it is suggested that 10 nF capacitors be placed as close as possible to the op amp. For single supply, place a capacitor between  $V^+$  and  $V^-$ . For dual supplies, place one capacitor between  $V^+$  and the board ground, and a second capacitor between ground and  $V^-$ . Even with the LMV851/LMV852/LMV854 inherent hardening against EMI, it is still recommended to keep the input traces short and as far as possible from RF sources. Then the RF signals entering the chip are as low as possible, and the remaining EMI can be, almost, completely eliminated in the chip by the EMI reducing features of the LMV851/LMV852/LMV854.

## PRESSURE SENSOR APPLICATION

The LMV851/LMV852/LMV854 can be used for pressure sensor applications. Because of their low power the LMV851/LMV852/LMV854 are ideal for portable applications, such as blood pressure measurement devices, or portable barometers. This example describes a universal pressure sensor that can be used as a starting point for different types of sensors and applications.

### Pressure Sensor Characteristics

The pressure sensor used in this example functions as a Wheatstone bridge. The value of the resistors in the bridge change when pressure is applied to the sensor. This change of the resistor values will result in a differential output voltage, depending on the sensitivity of the sensor and the applied pressure. The difference between the output at full scale pressure and the output at zero pressure is defined as the span of the pressure sensor. A typical value for the span is 100 mV. A typical value for the resistors in the bridge is 5 k $\Omega$ . Loading of the resistor bridge could result in incorrect output voltages of the sensor. Therefore the selection of the circuit configuration, which connects to the sensor, should take into account a minimum loading of the sensor.

### Pressure Sensor Example

The configuration shown in [Figure 55](#) is simple, and is very useful for the read out of pressure sensors. With two op amps in this application, the dual LMV852 fits very well.

The op amp configured as a buffer and connected at the negative output of the pressure sensor prevents the loading of the bridge by resistor R2. The buffer also prevents the resistors of the sensor from affecting the gain of the following gain stage. Given the differential output voltage  $V_S$  of the pressure sensor, the output signal of this op amp configuration,  $V_{OUT}$ , equals:

$$V_{OUT} = \frac{V_{DD}}{2} - \frac{V_S}{2} \left( 1 + 2 \times \frac{R1}{R2} \right) \quad (2)$$

To align the pressure range with the full range of an ADC, the power supply voltage and the span of the pressure sensor are needed. For this example a power supply of 5V is used and the span of the sensor is 100 mV.

When a 100 $\Omega$  resistor is used for R2, and a 2.4 k $\Omega$  resistor is used for R1, the maximum voltage at the output is 4.95V and the minimum voltage is 0.05V. This signal is covering almost the full input range of the ADC. Further processing can take place in the microprocessor following the ADC.

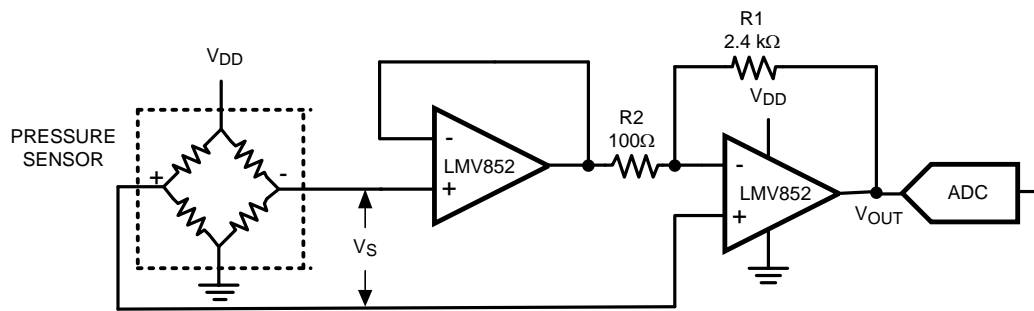


Figure 55. Pressure Sensor Application

## THERMOCOUPLE AMPLIFIER

The following circuit is a typical example for a thermocouple amplifier application using an LMV851/LMV852, or LMV854. A thermocouple converts a temperature into a voltage. This signal is then amplified by the LMV851/LMV852, or LMV854. An ADC can convert the amplified signal to a digital signal. For further processing the digital signal can be processed by a microprocessor and used to display or log the temperature. The temperature data can for instance be used in a fabrication process.

### Characteristics of a Thermocouple

A thermocouple is a junction of two different metals. These metals produce a small voltage that increases with temperature.

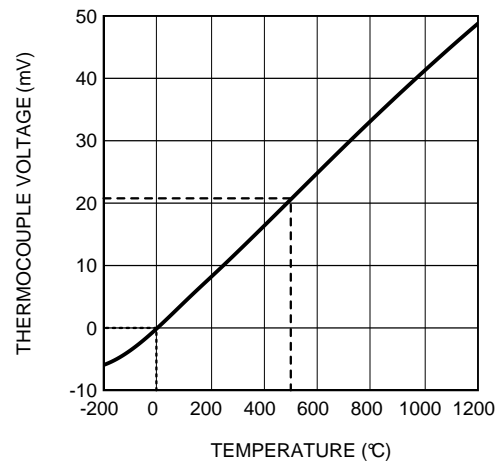
The thermocouple used in this application is a K-type thermocouple. A K-type thermocouple is a junction between Nickel-Chromium and Nickel-Aluminum. This is one of the most commonly used thermocouples. There are several reasons for using the K-type thermocouple, these include: temperature range, the linearity, the sensitivity, and the cost.

A K-type thermocouple has a wide temperature range. The range of this thermocouple is from approximately  $-200^{\circ}\text{C}$  to approximately  $1200^{\circ}\text{C}$ , as can be seen in [Figure 56](#). This covers the generally used temperature ranges.

Over the main part of the temperature range the output voltage depends linearly on the temperature. This is important for easily converting the measured signal levels to a temperature reading.

The K-type thermocouple has good sensitivity when compared to many other types; the sensitivity is about  $41\ \mu\text{V}/^{\circ}\text{C}$ . Lower sensitivity requires more gain and makes the application more sensitive to noise.

In addition, a K-type thermocouple is not expensive, many other thermocouples consist of more expensive materials or are more difficult to produce.



**Figure 56. K-Type Thermocouple Response**

### Thermocouple Example

For this example, suppose the range of interest is 0°C to 500°C, and the resolution needed is 0.5°C. The power supply for both the LMV851/LMV852, or LMV854 and the ADC is 3.3V.

The temperature range of 0°C to 500°C results in a voltage range from 0 mV to 20.6 mV produced by the thermocouple. This is indicated in Figure 56 by the dotted lines.

To obtain the highest resolution, the full ADC range of 0 to 3.3V is used. The gain needed for the full range can be calculated as follows:

$$A_V = 3.3V / 0.0206V = 160 \quad (3)$$

If  $R_G$  is 2 k $\Omega$ , then the value for  $R_F$  can be calculated for a gain of 160. Since  $A_V = R_F / R_G$ ,  $R_F$  can be calculated as follows:

$$R_F = A_V \times R_G = 160 \times 2 \text{ k}\Omega = 320 \text{ k}\Omega \quad (4)$$

To get a resolution of 0.5°C, the LSB of the ADC should be smaller than  $0.5^\circ\text{C} / 500^\circ\text{C} = 1/1000$ . A 10-bit ADC would be sufficient as this gives 1024 steps. A 10-bit ADC such as the two channel 10-bit ADC102S021 can be used.

### Unwanted Thermocouple Effect

At the point where the thermocouple wires are connected to the circuit, usually copper wires or traces, an unwanted thermocouple effect will occur.

At this connection, this could be the connector on a PCB, the thermocouple wiring forms a second thermocouple with the connector. This second thermocouple disturbs the measurements from the intended thermocouple.

Using an isothermal block as a reference enables correction for this unwanted thermocouple effect. An isothermal block is a good heat conductor. This means that the two thermocouple connections both have the same temperature. The temperature of the isothermal block can be measured, and thereby the temperature of the thermocouple connections. This is usually called the cold junction reference temperature.

In the example, an LM35 is used to measure this temperature. This semiconductor temperature sensor can accurately measure temperatures from  $-55^\circ\text{C}$  to  $150^\circ\text{C}$ .

The two channel ADC in this example also converts the signal from the LM35 to a digital signal. Now the microprocessor can compensate the amplified thermocouple signal, for the unwanted thermocouple effect.



---

## REVISION HISTORY

Changes from Original (March 2013) to Revision D

Page

---

**PACKAGING INFORMATION**

Orderable part number	Status (1)	Material type (2)	Package   Pins	Package qty   Carrier	RoHS (3)	Lead finish/ Ball material (4)	MSL rating/ Peak reflow (5)	Op temp (°C)	Part marking (6)
<a href="#">LMV851MG/NOPB</a>	Active	Production	SC70 (DCK)   5	1000   SMALL T&R	Yes	SN	Level-1-260C-UNLIM	-40 to 125	A98
LMV851MG/NOPB.A	Active	Production	SC70 (DCK)   5	1000   SMALL T&R	Yes	SN	Level-1-260C-UNLIM	-40 to 125	A98
<a href="#">LMV851MGE/NOPB</a>	Active	Production	SC70 (DCK)   5	250   SMALL T&R	Yes	SN	Level-1-260C-UNLIM	-40 to 125	A98
LMV851MGE/NOPB.A	Active	Production	SC70 (DCK)   5	250   SMALL T&R	Yes	SN	Level-1-260C-UNLIM	-40 to 125	A98
<a href="#">LMV851MGX/NOPB</a>	Active	Production	SC70 (DCK)   5	3000   LARGE T&R	Yes	SN	Level-1-260C-UNLIM	-40 to 125	A98
LMV851MGX/NOPB.A	Active	Production	SC70 (DCK)   5	3000   LARGE T&R	Yes	SN	Level-1-260C-UNLIM	-40 to 125	A98
<a href="#">LMV852MM/NOPB</a>	Active	Production	VSSOP (DGK)   8	1000   SMALL T&R	Yes	NIPDAUAG   SN	Level-1-260C-UNLIM	-40 to 125	AB5A
LMV852MM/NOPB.A	Active	Production	VSSOP (DGK)   8	1000   SMALL T&R	Yes	SN	Level-1-260C-UNLIM	-40 to 125	AB5A
<a href="#">LMV852MME/NOPB</a>	Active	Production	VSSOP (DGK)   8	250   SMALL T&R	Yes	NIPDAUAG   SN	Level-1-260C-UNLIM	-40 to 125	AB5A
LMV852MME/NOPB.A	Active	Production	VSSOP (DGK)   8	250   SMALL T&R	Yes	SN	Level-1-260C-UNLIM	-40 to 125	AB5A
<a href="#">LMV852MMX/NOPB</a>	Active	Production	VSSOP (DGK)   8	3500   LARGE T&R	Yes	NIPDAUAG   SN	Level-1-260C-UNLIM	-40 to 125	AB5A
LMV852MMX/NOPB.A	Active	Production	VSSOP (DGK)   8	3500   LARGE T&R	Yes	SN	Level-1-260C-UNLIM	-40 to 125	AB5A
<a href="#">LMV854MT/NOPB</a>	Active	Production	TSSOP (PW)   14	94   TUBE	Yes	SN	Level-1-260C-UNLIM	-40 to 125	LMV854 MT
LMV854MT/NOPB.A	Active	Production	TSSOP (PW)   14	94   TUBE	Yes	SN	Level-1-260C-UNLIM	-40 to 125	LMV854 MT
<a href="#">LMV854MTX/NOPB</a>	Active	Production	TSSOP (PW)   14	2500   LARGE T&R	Yes	SN	Level-1-260C-UNLIM	-40 to 125	LMV854 MT
LMV854MTX/NOPB.A	Active	Production	TSSOP (PW)   14	2500   LARGE T&R	Yes	SN	Level-1-260C-UNLIM	-40 to 125	LMV854 MT

(1) **Status:** For more details on status, see our [product life cycle](#).

(2) **Material type:** When designated, preproduction parts are prototypes/experimental devices, and are not yet approved or released for full production. Testing and final process, including without limitation quality assurance, reliability performance testing, and/or process qualification, may not yet be complete, and this item is subject to further changes or possible discontinuation. If available for ordering, purchases will be subject to an additional waiver at checkout, and are intended for early internal evaluation purposes only. These items are sold without warranties of any kind.

(3) **RoHS values:** Yes, No, RoHS Exempt. See the [TI RoHS Statement](#) for additional information and value definition.

(4) **Lead finish/Ball material:** Parts may have multiple material finish options. Finish options are separated by a vertical ruled line. Lead finish/Ball material values may wrap to two lines if the finish value exceeds the maximum column width.

<sup>(5)</sup> **MSL rating/Peak reflow:** The moisture sensitivity level ratings and peak solder (reflow) temperatures. In the event that a part has multiple moisture sensitivity ratings, only the lowest level per JEDEC standards is shown. Refer to the shipping label for the actual reflow temperature that will be used to mount the part to the printed circuit board.

<sup>(6)</sup> **Part marking:** There may be an additional marking, which relates to the logo, the lot trace code information, or the environmental category of the part.

Multiple part markings will be inside parentheses. Only one part marking contained in parentheses and separated by a "~" will appear on a part. If a line is indented then it is a continuation of the previous line and the two combined represent the entire part marking for that device.

**Important Information and Disclaimer:** The information provided on this page represents TI's knowledge and belief as of the date that it is provided. TI bases its knowledge and belief on information provided by third parties, and makes no representation or warranty as to the accuracy of such information. Efforts are underway to better integrate information from third parties. TI has taken and continues to take reasonable steps to provide representative and accurate information but may not have conducted destructive testing or chemical analysis on incoming materials and chemicals. TI and TI suppliers consider certain information to be proprietary, and thus CAS numbers and other limited information may not be available for release.

In no event shall TI's liability arising out of such information exceed the total purchase price of the TI part(s) at issue in this document sold by TI to Customer on an annual basis.



**TAPE AND REEL INFORMATION**

**QUADRANT ASSIGNMENTS FOR PIN 1 ORIENTATION IN TAPE**


\*All dimensions are nominal

Device	Package Type	Package Drawing	Pins	SPQ	Reel Diameter (mm)	Reel Width W1 (mm)	A0 (mm)	B0 (mm)	K0 (mm)	P1 (mm)	W (mm)	Pin1 Quadrant
LMV851MG/NOPB	SC70	DCK	5	1000	178.0	8.4	2.25	2.45	1.2	4.0	8.0	Q3
LMV851MGE/NOPB	SC70	DCK	5	250	178.0	8.4	2.25	2.45	1.2	4.0	8.0	Q3
LMV851MGX/NOPB	SC70	DCK	5	3000	178.0	8.4	2.25	2.45	1.2	4.0	8.0	Q3
LMV852MM/NOPB	VSSOP	DGK	8	1000	177.8	12.4	5.3	3.4	1.4	8.0	12.0	Q1
LMV852MME/NOPB	VSSOP	DGK	8	250	177.8	12.4	5.3	3.4	1.4	8.0	12.0	Q1
LMV852MMX/NOPB	VSSOP	DGK	8	3500	330.0	12.4	5.3	3.4	1.4	8.0	12.0	Q1
LMV854MTX/NOPB	TSSOP	PW	14	2500	330.0	12.4	6.95	5.6	1.6	8.0	12.0	Q1

**TAPE AND REEL BOX DIMENSIONS**


\*All dimensions are nominal

Device	Package Type	Package Drawing	Pins	SPQ	Length (mm)	Width (mm)	Height (mm)
LMV851MG/NOPB	SC70	DCK	5	1000	208.0	191.0	35.0
LMV851MGE/NOPB	SC70	DCK	5	250	208.0	191.0	35.0
LMV851MGX/NOPB	SC70	DCK	5	3000	208.0	191.0	35.0
LMV852MM/NOPB	VSSOP	DGK	8	1000	208.0	191.0	35.0
LMV852MME/NOPB	VSSOP	DGK	8	250	208.0	191.0	35.0
LMV852MMX/NOPB	VSSOP	DGK	8	3500	367.0	367.0	35.0
LMV854MTX/NOPB	TSSOP	PW	14	2500	367.0	367.0	35.0

**TUBE**


\*All dimensions are nominal

Device	Package Name	Package Type	Pins	SPQ	L (mm)	W (mm)	T (μm)	B (mm)
LMV854MT/NOPB	PW	TSSOP	14	94	495	8	2514.6	4.06
LMV854MT/NOPB.A	PW	TSSOP	14	94	495	8	2514.6	4.06



# EXAMPLE BOARD LAYOUT

DCK0005A

SOT - 1.1 max height

SMALL OUTLINE TRANSISTOR



LAND PATTERN EXAMPLE  
EXPOSED METAL SHOWN  
SCALE:18X



SOLDER MASK DETAILS

4214834/G 11/2024

NOTES: (continued)

- 7. Publication IPC-7351 may have alternate designs.
- 8. Solder mask tolerances between and around signal pads can vary based on board fabrication site.

# EXAMPLE STENCIL DESIGN

DCK0005A

SOT - 1.1 max height

SMALL OUTLINE TRANSISTOR



SOLDER PASTE EXAMPLE  
BASED ON 0.125 THICK STENCIL  
SCALE: 18X

4214834/G 11/2024

NOTES: (continued)

9. Laser cutting apertures with trapezoidal walls and rounded corners may offer better paste release. IPC-7525 may have alternate design recommendations.
10. Board assembly site may have different recommendations for stencil design.



4220202/B 12/2023

NOTES:

1. All linear dimensions are in millimeters. Any dimensions in parenthesis are for reference only. Dimensioning and tolerancing per ASME Y14.5M.
2. This drawing is subject to change without notice.
3. This dimension does not include mold flash, protrusions, or gate burrs. Mold flash, protrusions, or gate burrs shall not exceed 0.15 mm per side.
4. This dimension does not include interlead flash. Interlead flash shall not exceed 0.25 mm per side.
5. Reference JEDEC registration MO-153.

# EXAMPLE BOARD LAYOUT

PW0014A

TSSOP - 1.2 mm max height

SMALL OUTLINE PACKAGE



LAND PATTERN EXAMPLE  
EXPOSED METAL SHOWN  
SCALE: 10X



4220202/B 12/2023

NOTES: (continued)

- 6. Publication IPC-7351 may have alternate designs.
- 7. Solder mask tolerances between and around signal pads can vary based on board fabrication site.



# EXAMPLE STENCIL DESIGN

PW0014A

TSSOP - 1.2 mm max height

SMALL OUTLINE PACKAGE



SOLDER PASTE EXAMPLE  
BASED ON 0.125 mm THICK STENCIL  
SCALE: 10X

4220202/B 12/2023

NOTES: (continued)

8. Laser cutting apertures with trapezoidal walls and rounded corners may offer better paste release. IPC-7525 may have alternate design recommendations.
9. Board assembly site may have different recommendations for stencil design.

# DGK0008A



# PACKAGE OUTLINE

VSSOP - 1.1 mm max height

SMALL OUTLINE PACKAGE



4214862/A 04/2023

**NOTES:**

PowerPAD is a trademark of Texas Instruments.

1. All linear dimensions are in millimeters. Any dimensions in parenthesis are for reference only. Dimensioning and tolerancing per ASME Y14.5M.
2. This drawing is subject to change without notice.
3. This dimension does not include mold flash, protrusions, or gate burrs. Mold flash, protrusions, or gate burrs shall not exceed 0.15 mm per side.
4. This dimension does not include interlead flash. Interlead flash shall not exceed 0.25 mm per side.
5. Reference JEDEC registration MO-187.

# EXAMPLE BOARD LAYOUT

DGK0008A

™ VSSOP - 1.1 mm max height

SMALL OUTLINE PACKAGE



LAND PATTERN EXAMPLE  
EXPOSED METAL SHOWN  
SCALE: 15X



SOLDER MASK DETAILS

4214862/A 04/2023

NOTES: (continued)

6. Publication IPC-7351 may have alternate designs.
7. Solder mask tolerances between and around signal pads can vary based on board fabrication site.
8. Vias are optional depending on application, refer to device data sheet. If any vias are implemented, refer to their locations shown on this view. It is recommended that vias under paste be filled, plugged or tented.
9. Size of metal pad may vary due to creepage requirement.

# EXAMPLE STENCIL DESIGN

DGK0008A

™ VSSOP - 1.1 mm max height

SMALL OUTLINE PACKAGE



SOLDER PASTE EXAMPLE  
SCALE: 15X

4214862/A 04/2023

NOTES: (continued)

11. Laser cutting apertures with trapezoidal walls and rounded corners may offer better paste release. IPC-7525 may have alternate design recommendations.
12. Board assembly site may have different recommendations for stencil design.

## IMPORTANT NOTICE AND DISCLAIMER

TI PROVIDES TECHNICAL AND RELIABILITY DATA (INCLUDING DATASHEETS), DESIGN RESOURCES (INCLUDING REFERENCE DESIGNS), APPLICATION OR OTHER DESIGN ADVICE, WEB TOOLS, SAFETY INFORMATION, AND OTHER RESOURCES "AS IS" AND WITH ALL FAULTS, AND DISCLAIMS ALL WARRANTIES, EXPRESS AND IMPLIED, INCLUDING WITHOUT LIMITATION ANY IMPLIED WARRANTIES OF MERCHANTABILITY, FITNESS FOR A PARTICULAR PURPOSE OR NON-INFRINGEMENT OF THIRD PARTY INTELLECTUAL PROPERTY RIGHTS.

These resources are intended for skilled developers designing with TI products. You are solely responsible for (1) selecting the appropriate TI products for your application, (2) designing, validating and testing your application, and (3) ensuring your application meets applicable standards, and any other safety, security, regulatory or other requirements.

These resources are subject to change without notice. TI grants you permission to use these resources only for development of an application that uses the TI products described in the resource. Other reproduction and display of these resources is prohibited. No license is granted to any other TI intellectual property right or to any third party intellectual property right. TI disclaims responsibility for, and you fully indemnify TI and its representatives against any claims, damages, costs, losses, and liabilities arising out of your use of these resources.

TI's products are provided subject to [TI's Terms of Sale](#), [TI's General Quality Guidelines](#), or other applicable terms available either on [ti.com](http://ti.com) or provided in conjunction with such TI products. TI's provision of these resources does not expand or otherwise alter TI's applicable warranties or warranty disclaimers for TI products. Unless TI explicitly designates a product as custom or customer-specified, TI products are standard, catalog, general purpose devices.

TI objects to and rejects any additional or different terms you may propose.

Copyright © 2026, Texas Instruments Incorporated

Last updated 10/2025