

LM6172QML Dual High Speed, Low Power, Low Distortion, Voltage Feedback Amplifiers

 Check for Samples: [LM6172QML](#)

FEATURES

- Available with Radiation Specification
 - High Dose Rate 300 krad(Si)
 - ELDRS Free 100 krad(Si)
- Easy to Use Voltage Feedback Topology
- High Slew Rate 3000V/μs
- Wide Unity-Gain Bandwidth 100MHz
- Low Supply Current 2.3mA / Amplifier
- High Output Current 50mA / Amplifier
- Specified for ±15V and ±5V Operation

APPLICATIONS

- Scanner I- to -V Converters
- ADSL/HDSL Drivers
- Multimedia Broadcast Systems
- Video Amplifiers
- NTSC, PAL[®] and SECAM Systems
- ADC/DAC Buffers
- Pulse Amplifiers and Peak Detectors

DESCRIPTION

The LM6172 is a dual high speed voltage feedback amplifier. It is unity-gain stable and provides excellent DC and AC performance. With 100MHz unity-gain bandwidth, 3000V/μs slew rate and 50mA of output current per channel, the LM6172 offers high performance in dual amplifiers; yet it only consumes 2.3mA of supply current each channel.

The LM6172 operates on ±15V power supply for systems requiring large voltage swings, such as ADSL, scanners and ultrasound equipment. It is also specified at ±5V power supply for low voltage applications such as portable video systems.

The LM6172 is built with TI's advanced VIP[™] III (Vertically Integrated PNP) complementary bipolar process.

Connection Diagram

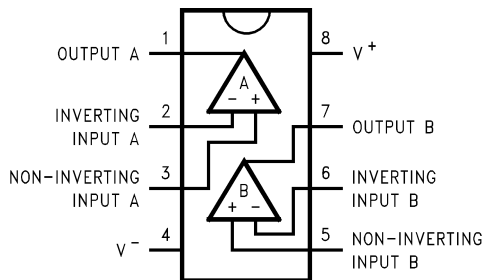

**Figure 1. 8-Pin CDIP
Top View**

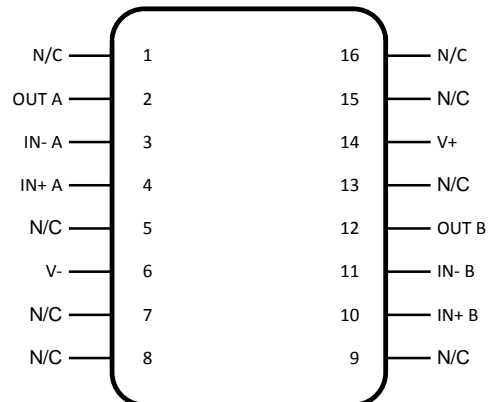

**Figure 2. 16LD CLGA
Top View**



Please be aware that an important notice concerning availability, standard warranty, and use in critical applications of Texas Instruments semiconductor products and disclaimers thereto appears at the end of this data sheet.

VIP is a trademark of Texas Instruments.

PAL is a registered trademark of and used under license from Advanced Micro Devices, Inc..

All other trademarks are the property of their respective owners.

LM6172 Driving Capacitive Load

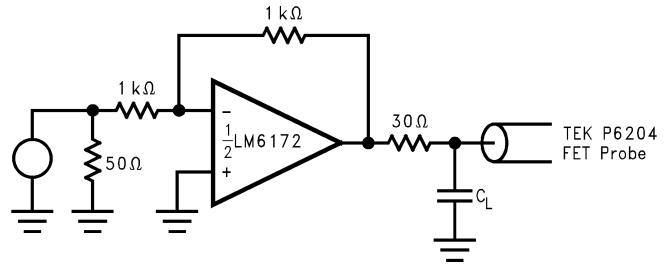
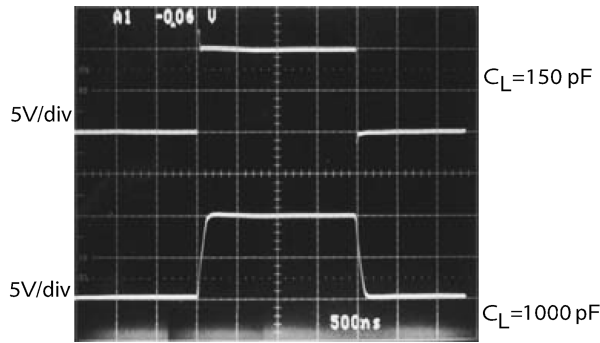

LM6172 Simplified Schematic (Each Amplifier)

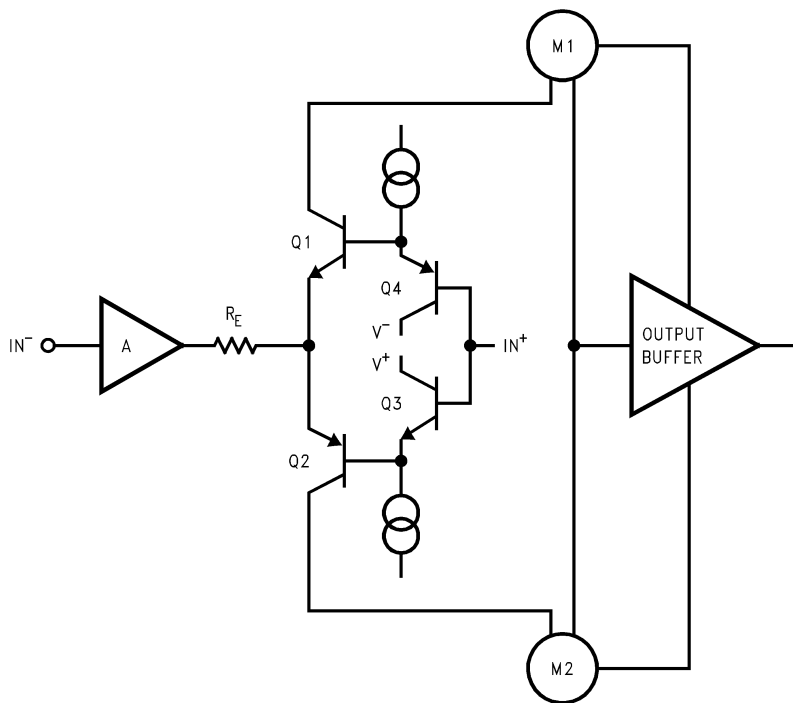

These devices have limited built-in ESD protection. The leads should be shorted together or the device placed in conductive foam during storage or handling to prevent electrostatic damage to the MOS gates.

ABSOLUTE MAXIMUM RATINGS ⁽¹⁾

Supply Voltage ($V^+ - V^-$)		36V	
Differential Input Voltage ⁽²⁾		$\pm 10V$	
Maximum Junction Temperature		150°C	
Power Dissipation ^{(3), (4)}		1.03W	
Output Short Circuit to Ground ⁽⁵⁾		Continuous	
Storage Temperature Range		$-65^\circ\text{C} \leq T_A \leq +150^\circ\text{C}$	
Common Mode Voltage Range		$V^+ +0.3V$ to $V^- -0.3V$	
Input Current		$\pm 10\text{mA}$	
Thermal Resistance ⁽⁶⁾	θ_{JA}	8LD CDIP (Still Air)	100°C/W
		8LD CDIP (500LF/Min Air Flow)	46°C/W
		16LD CLGA (Still Air) "WG"	124°C/W
		16LD CLGA (500LF/Min Air Flow) "WG"	74°C/W
		16LD CLGA (Still Air) "GW"	135°C/W
		16LD CLGA (500LF/Min Air Flow) "GW"	85°C/W
	θ_{JC}	8LD CDIP ⁽⁴⁾	2°C/W
16LD CLGA "WG" ⁽⁴⁾		6°C/W	
16LD CLGA "GW"		7°C/W	
Package Weight	8LD CDIP		980mg
	16LD CLGA "WG"		365mg
	16LD CLGA "GW"		410mg
ESD Tolerance ⁽⁷⁾		4KV	

- (1) Absolute Maximum Ratings indicate limits beyond which damage to the device may occur. Operating Ratings indicate conditions for which the device is functional, but do not ensure specific performance limits. For ensured specifications and test conditions, see the Electrical Characteristics. The ensured specifications apply only for the test conditions listed. Some performance characteristics may degrade when the device is not operated under the listed test conditions.
- (2) Differential Input Voltage is measured at $V_S = \pm 15V$.
- (3) The maximum power dissipation must be derated at elevated temperatures and is dictated by T_{Jmax} (maximum junction temperature), θ_{JA} (package junction to ambient thermal resistance), and T_A (ambient temperature). The maximum allowable power dissipation at any temperature is $P_{Dmax} = (T_{Jmax} - T_A)/\theta_{JA}$ or the number given in the Absolute Maximum Ratings, whichever is lower.
- (4) The package material for these devices allows much improved heat transfer over our standard ceramic packages. In order to take full advantage of this improved heat transfer, heat sinking must be provided between the package base (directly beneath the die), and either metal traces on, or thermal vias through, the printed circuit board. Without this additional heat sinking, device power dissipation must be calculated using θ_{JA} , rather than θ_{JC} , thermal resistance. It must not be assumed that the device leads will provide substantial heat transfer out the package, since the thermal resistance of the leadframe material is very poor, relative to the material of the package base. The stated θ_{JC} thermal resistance is for the package material only, and does not account for the additional thermal resistance between the package base and the printed circuit board. The user must determine the value of the additional thermal resistance and must combine this with the stated value for the package, to calculate the total allowed power dissipation for the device.
- (5) Continuous short circuit operation can result in exceeding the maximum allowed junction temperature of 150°C
- (6) All numbers apply for packages soldered directly into a PC board.
- (7) Human body model, 1.5 k Ω in series with 100 pF.

RECOMMENDED OPERATING CONDITIONS ⁽¹⁾

Supply Voltage	$5.5V \leq V_S \leq 36V$
Operating Temperature Range	$-55^\circ\text{C} \leq T_A \leq +125^\circ\text{C}$

- (1) Absolute Maximum Ratings indicate limits beyond which damage to the device may occur. Operating Ratings indicate conditions for which the device is functional, but do not ensure specific performance limits. For ensured specifications and test conditions, see the Electrical Characteristics. The ensured specifications apply only for the test conditions listed. Some performance characteristics may degrade when the device is not operated under the listed test conditions.

QUALITY CONFORMANCE INSPECTION

Mil-Std-883, Method 5005 - Group A

Subgroup	Description	Temp (°C)
1	Static tests at	+25
2	Static tests at	+125
3	Static tests at	-55
4	Dynamic tests at	+25
5	Dynamic tests at	+125
6	Dynamic tests at	-55
7	Functional tests at	+25
8A	Functional tests at	+125
8B	Functional tests at	-55
9	Switching tests at	+25
10	Switching tests at	+125
11	Switching tests at	-55
12	Settling time at	+25
13	Settling time at	+125
14	Settling time at	-55

LM6172 ($\pm 5V$) ELECTRICAL CHARACTERISTICS ⁽¹⁾ DC PARAMETERS

The following conditions apply, unless otherwise specified. $T_J = 25^\circ\text{C}$, $V^+ = +5V$, $V^- = -5V$, $V_{CM} = 0V$ & $R_L > 1M\Omega$

Symbol	Parameter	Conditions	Notes	Min	Max	Units	Sub-groups
V_{IO}	Input Offset Voltage				1.0	mV	1
					3.0	mV	2, 3
I_{IB}	Input Bias Current				2.5	μA	1
					3.5	μA	2, 3
I_{IO}	Input Offset Current				1.5	μA	1
					2.2	μA	2, 3
CMRR	Common Mode Rejection Ratio	$V_{CM} = \pm 2.5V$		70		dB	1
				65		dB	2, 3
PSRR	Power Supply Rejection Ratio	$V_S = \pm 15V$ to $\pm 5V$		75		dB	1
				70		dB	2, 3
A_V	Large Signal Voltage Gain	$R_L = 1K\Omega$	See ⁽²⁾	70		dB	1
			See ⁽²⁾	65		dB	2, 3
		$R_L = 100\Omega$	See ⁽²⁾	65		dB	1
			See ⁽²⁾	60		dB	2, 3
V_O	Output Swing	$R_L = 1K\Omega$		3.1	-3.1	V	1
				3.0	-3.0	V	2, 3
		$R_L = 100\Omega$		2.5	-2.4	V	1
				2.4	-2.3	V	2, 3

(1) Pre and post irradiation limits are identical to those listed under AC and DC electrical characteristics. These parts may be dose rate sensitive in a space environment and demonstrate enhanced low dose rate effect. Radiation end point limits for the noted parameters are specified only for the conditions as specified in Mil-Std-883, Method 1019.5, Condition A.

(2) Large signal voltage gain is the total output swing divided by the input signal required to produce that swing. For $V_S = \pm 15V$, $V_{OUT} = \pm 5V$. For $V_S = \pm 5V$, $V_{OUT} = \pm 1V$.

LM6172 ($\pm 5V$) ELECTRICAL CHARACTERISTICS ⁽¹⁾

DC PARAMETERS (continued)

The following conditions apply, unless otherwise specified. $T_J = 25^\circ C$, $V^+ = +5V$, $V^- = -5V$, $V_{CM} = 0V$ & $R_L > 1M\Omega$

Symbol	Parameter	Conditions	Notes	Min	Max	Units	Sub-groups	
I_L	Output Current (Open Loop)	Sourcing $R_L = 100\Omega$	See ⁽³⁾	25		mA	1	
			See ⁽³⁾	24		mA	2, 3	
		Sinking $R_L = 100\Omega$	See ⁽³⁾		-24		mA	1
			See ⁽³⁾		-23		mA	2, 3
I_S	Supply Current	Both Amplifiers			6.0	mA	1	
					7.0	mA	2, 3	

(3) The open loop output current is specified by measurement of the open loop output voltage swing using 100Ω output load.

DC DRIFT PARAMETERS ⁽¹⁾

The following conditions apply, unless otherwise specified. $T_J = 25^\circ C$, $V^+ = +5V$, $V^- = -5V$, $V_{CM} = 0V$ & $R_L > 1M\Omega$
Delta calculations performed on QMLV devices at group B , subgroup 5.

Symbol	Parameter	Conditions	Notes	Min	Max	Units	Sub-groups
V_{IO}	Input Offset Voltage			-0.25	0.25	mV	1
I_{IB}	Input Bias Current			-0.50	0.50	μA	1
I_{IO}	Input Offset Current			-0.25	0.25	μA	1

(1) Pre and post irradiation limits are identical to those listed under AC and DC electrical characteristics. These parts may be dose rate sensitive in a space environment and demonstrate enhanced low dose rate effect. Radiation end point limits for the noted parameters are specified only for the conditions as specified in Mil-Std-883, Method 1019.5, Condition A.

LM6172 ($\pm 15V$) ELECTRICAL CHARACTERISTICS ⁽¹⁾

DC PARAMETERS ⁽¹⁾

The following conditions apply, unless otherwise specified. $T_J = 25^\circ C$, $V^+ = +15V$, $V^- = -15V$, $V_{CM} = 0V$, & $R_L = 1M\Omega$

Symbol	Parameter	Conditions	Notes	Min	Max	Units	Sub-groups
V_{IO}	Input Offset Voltage				1.5	mV	1
					3.5	mV	2, 3
I_{IB}	Input Bias Current				3.0	μA	1
					4.0	μA	2, 3
I_{IO}	Input Offset Current				2.0	μA	1
					3.0	μA	2, 3
CMRR	Common Mode Rejection Ratio	$V_{CM} = \pm 10V$		70		dB	1
				65		dB	2, 3
PSRR	Power Supply Rejection Ratio	$V_S = \pm 15V$ to $\pm 5V$		75		dB	1
				70		dB	2, 3
A_V	Large Signal Voltage Gain	$R_L = 1K\Omega$	See ⁽²⁾	75		dB	1
			See ⁽²⁾	70		dB	2, 3
		$R_L = 100\Omega$	See ⁽²⁾	65		dB	1
			See ⁽²⁾	60		dB	2, 3

(1) Pre and post irradiation limits are identical to those listed under AC and DC electrical characteristics. These parts may be dose rate sensitive in a space environment and demonstrate enhanced low dose rate effect. Radiation end point limits for the noted parameters are specified only for the conditions as specified in Mil-Std-883, Method 1019.5, Condition A.

(2) Large signal voltage gain is the total output swing divided by the input signal required to produce that swing. For $V_S = \pm 15V$, $V_{OUT} = \pm 5V$. For $V_S = \pm 5V$, $V_{OUT} = \pm 1V$.

LM6172 ($\pm 15V$) ELECTRICAL CHARACTERISTICS

DC PARAMETERS ⁽¹⁾ (continued)

The following conditions apply, unless otherwise specified. $T_J = 25^\circ C$, $V^+ = +15V$, $V^- = -15V$, $V_{CM} = 0V$, & $R_L = 1M\Omega$

Symbol	Parameter	Conditions	Notes	Min	Max	Units	Sub-groups	
V_O	Output Swing	$R_L = 1K\Omega$		12.5	-12.5	V	1	
				12	-12	V	2, 3	
		$R_L = 100\Omega$		6.0	-6.0	V	1	
				5.0	-5.0	V	2, 3	
I_L	Output Current (Open Loop)	Sourcing $R_L = 100\Omega$	See ⁽³⁾	60		mA	1	
			See ⁽³⁾	50		mA	2, 3	
		Sinking $R_L = 100\Omega$	See ⁽³⁾		-60		mA	1
			See ⁽³⁾		-50		mA	2, 3
I_S	Supply Current	Both Amplifiers			8.0	mA	1	
					9.0	mA	2, 3	

(3) The open loop output current is specified by measurement of the open loop output voltage swing using 100 Ω output load.

AC PARAMETERS ⁽¹⁾

The following conditions apply, unless otherwise specified. $T_J = 25^\circ C$, $V^+ = +15V$, $V^- = -15V$, $V_{CM} = 0V$

Symbol	Parameter	Conditions	Notes	Min	Max	Units	Sub-groups
SR	Slew Rate	$A_V = 2$, $V_I = \pm 2.5V$ 3nS Rise & Fall time	See ⁽²⁾ , ⁽³⁾	1700		V/ μ S	4
GBW	Unity-Gain Bandwidth		See ⁽⁴⁾	80		MHz	4

(1) Pre and post irradiation limits are identical to those listed under AC and DC electrical characteristics. These parts may be dose rate sensitive in a space environment and demonstrate enhanced low dose rate effect. Radiation end point limits for the noted parameters are specified only for the conditions as specified in Mil-Std-883, Method 1019.5, Condition A.

(2) See AN0009 for SR test circuit.

(3) Slew Rate measured between $\pm 4V$.

(4) See AN0009 for GBW test circuit.

DC DRIFT PARAMETERS ⁽¹⁾

The following conditions apply, unless otherwise specified. $T_J = 25^\circ C$, $V^+ = +15V$, $V^- = -15V$, $V_{CM} = 0V$

Delta calculations performed on QMLV devices at group B, subgroup 5.

Symbol	Parameter	Conditions	Notes	Min	Max	Units	Sub-groups
V_{IO}	Input Offset Voltage			-0.25	0.25	mV	1
I_{IB}	Input Bias Current			-0.50	0.50	μ A	1
I_{IO}	Input Offset Current			-0.25	0.25	μ A	1

(1) Pre and post irradiation limits are identical to those listed under AC and DC electrical characteristics. These parts may be dose rate sensitive in a space environment and demonstrate enhanced low dose rate effect. Radiation end point limits for the noted parameters are specified only for the conditions as specified in Mil-Std-883, Method 1019.5, Condition A.

TYPICAL PERFORMANCE CHARACTERISTICS

Unless otherwise noted, $T_A = 25^\circ\text{C}$

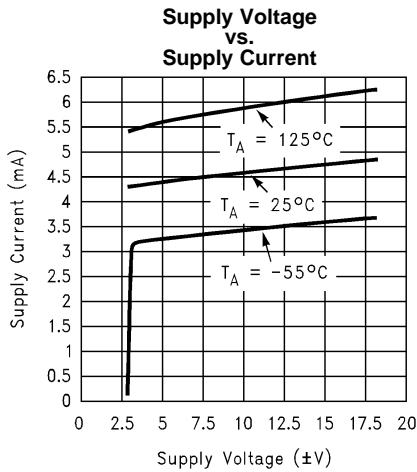

Figure 3.

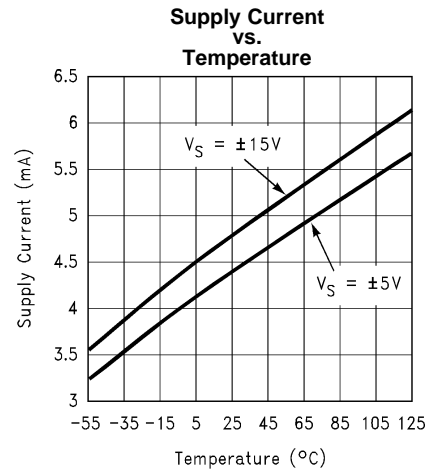

Figure 4.

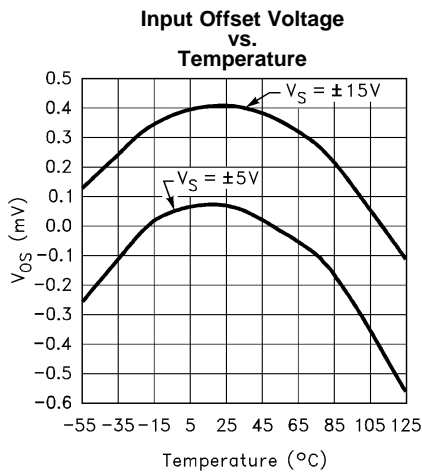

Figure 5.

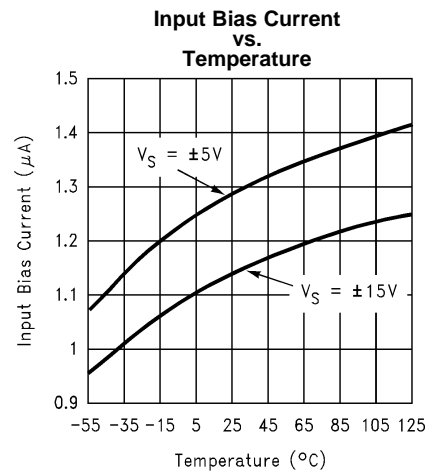

Figure 6.

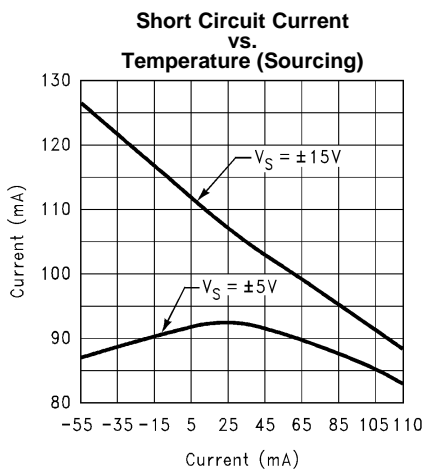

Figure 7.

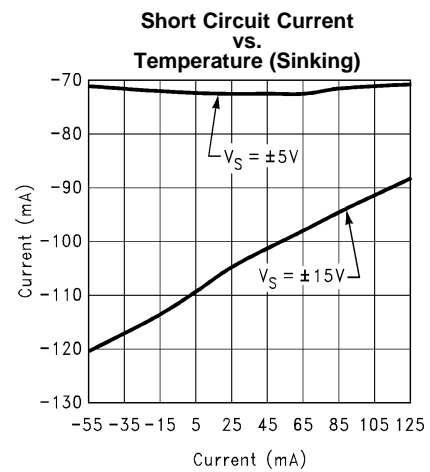

Figure 8.

TYPICAL PERFORMANCE CHARACTERISTICS (continued)

Unless otherwise noted, $T_A = 25^\circ\text{C}$

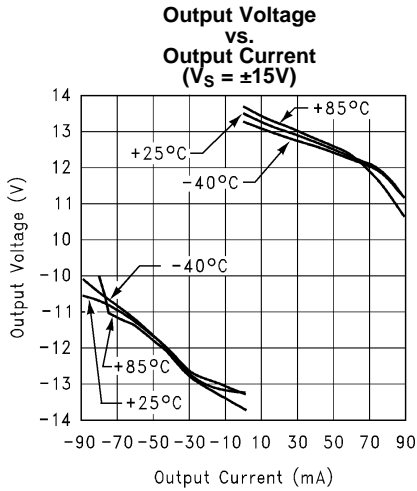

Figure 9.

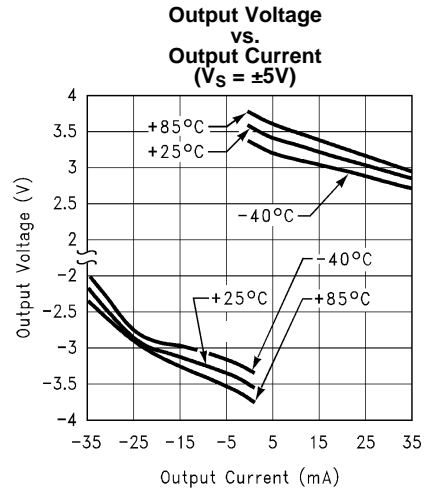

Figure 10.

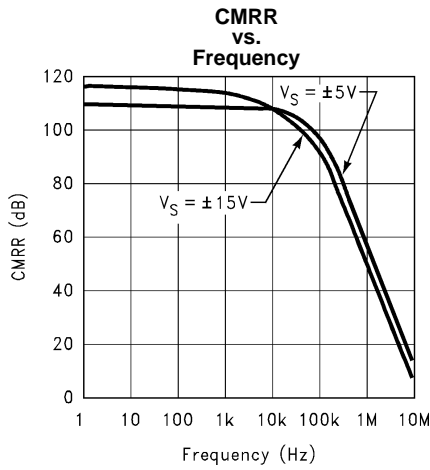

Figure 11.

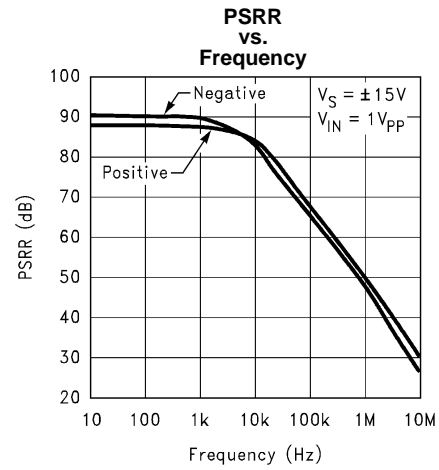

Figure 12.

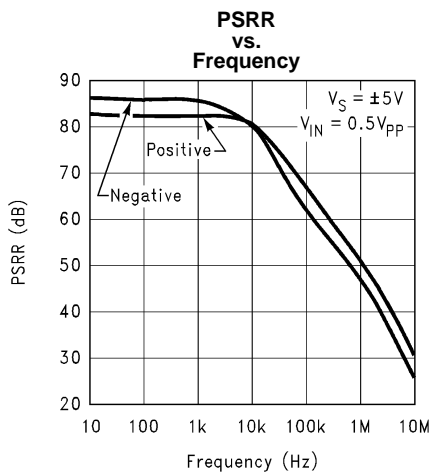

Figure 13.

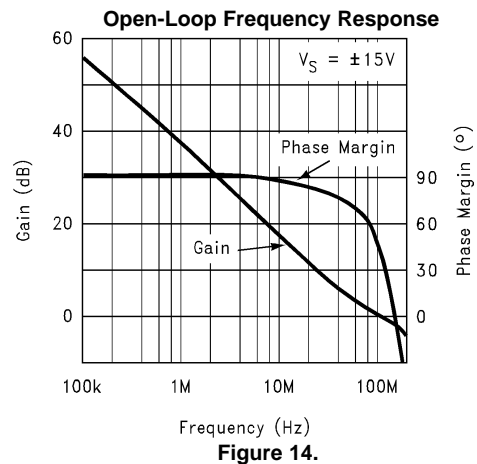

Figure 14.

TYPICAL PERFORMANCE CHARACTERISTICS (continued)

Unless otherwise noted, $T_A = 25^\circ\text{C}$

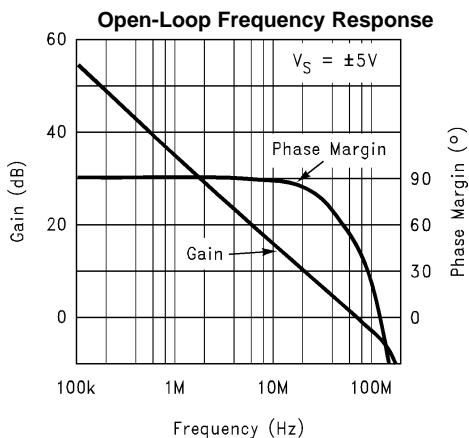

Figure 15.

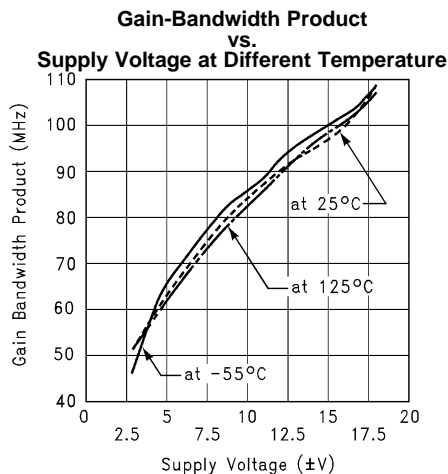

Figure 16.

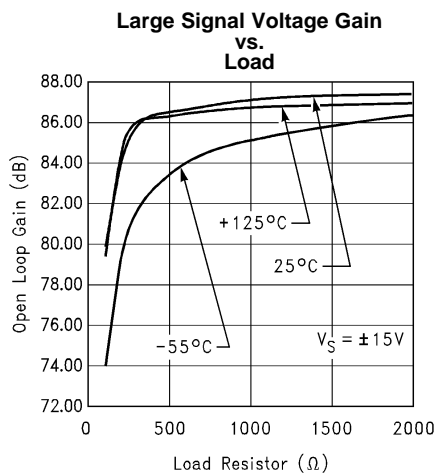

Figure 17.

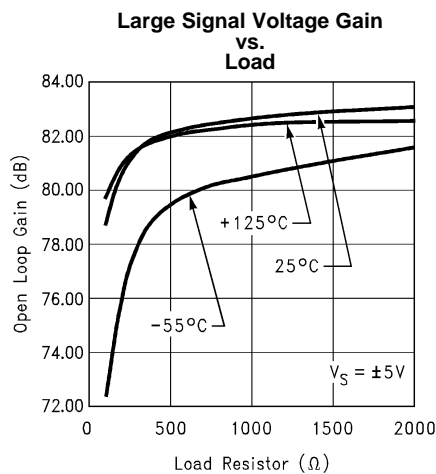

Figure 18.

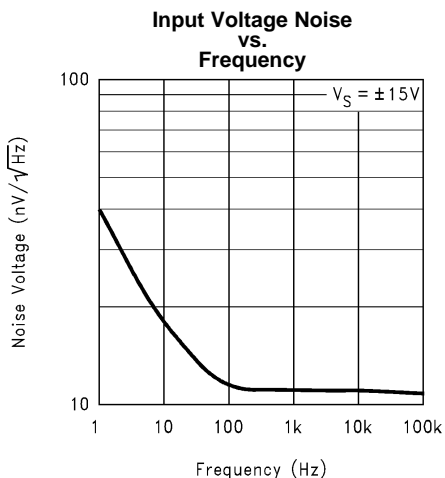

Figure 19.

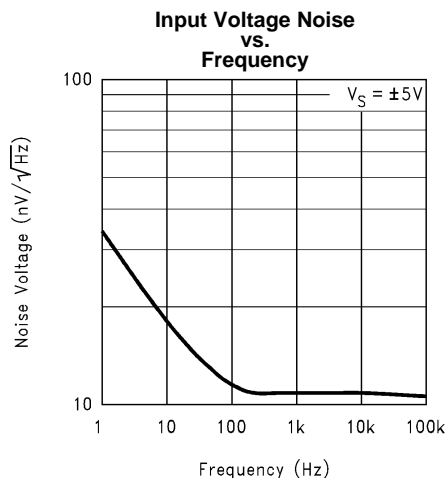

Figure 20.

TYPICAL PERFORMANCE CHARACTERISTICS (continued)

Unless otherwise noted, $T_A = 25^\circ\text{C}$

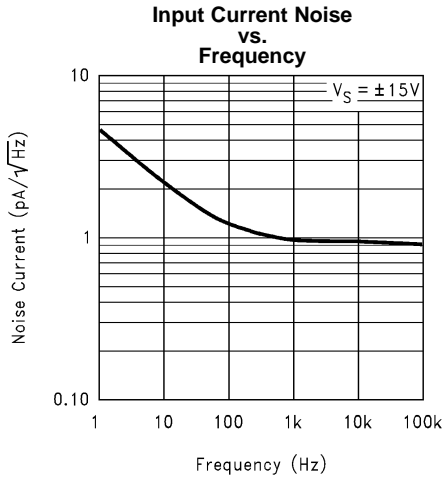

Figure 21.

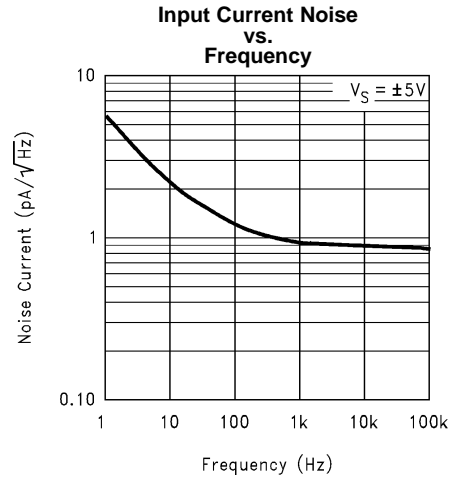

Figure 22.

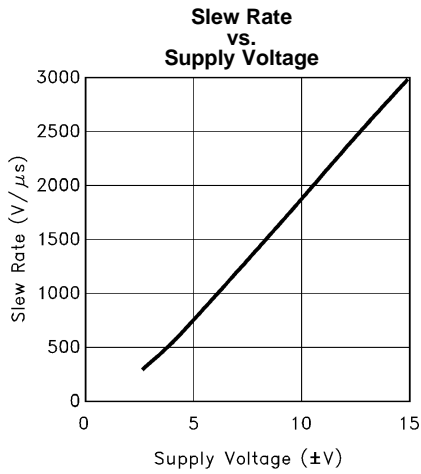

Figure 23.

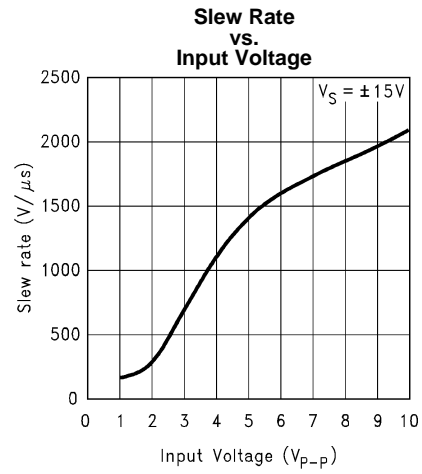

Figure 24.

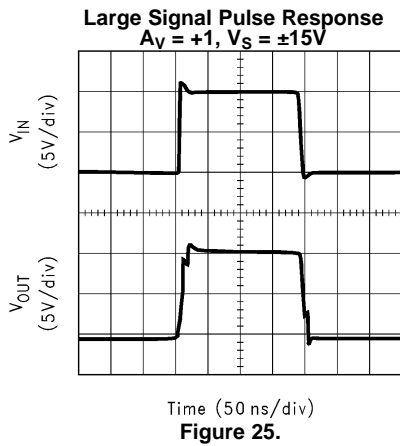

Figure 25.

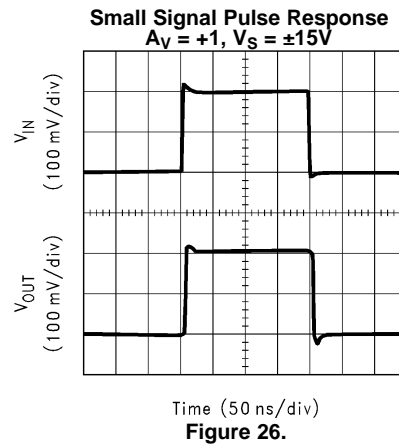
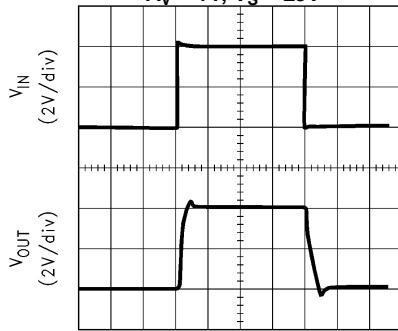

Figure 26.

TYPICAL PERFORMANCE CHARACTERISTICS (continued)

Unless otherwise noted, $T_A = 25^\circ\text{C}$

Large Signal Pulse Response
 $A_V = +1, V_S = \pm 5\text{V}$



Time (50 ns/div)
Figure 27.

Small Signal Pulse Response
 $A_V = +1, V_S = \pm 5\text{V}$

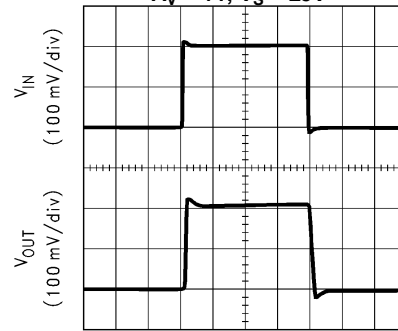

Time (50 ns/div)
Figure 28.

Large Signal Pulse Response
 $A_V = +2, V_S = \pm 15\text{V}$

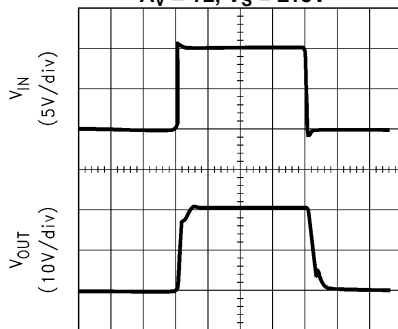

Time (50 ns/div)
Figure 29.

Small Signal Pulse Response
 $A_V = +2, V_S = \pm 15\text{V}$

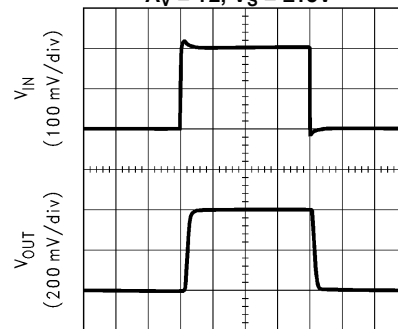

Time (50 ns/div)
Figure 30.

Large Signal Pulse Response
 $A_V = +2, V_S = \pm 5\text{V}$

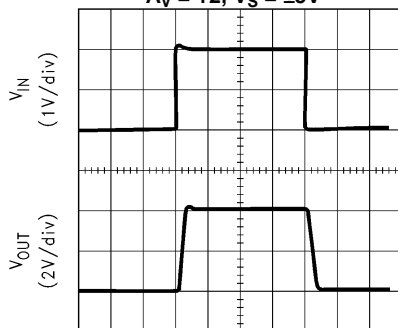

Time (50 ns/div)
Figure 31.

Small Signal Pulse Response
 $A_V = +2, V_S = \pm 5\text{V}$

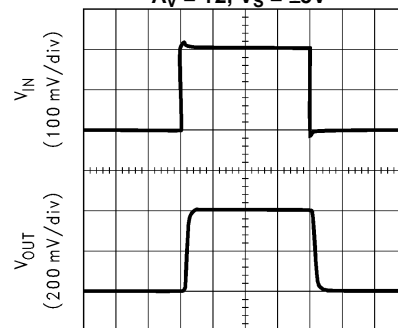

Time (50 ns/div)
Figure 32.

TYPICAL PERFORMANCE CHARACTERISTICS (continued)

Unless otherwise noted, $T_A = 25^\circ\text{C}$

Large Signal Pulse Response
 $A_V = -1, V_S = \pm 15\text{V}$

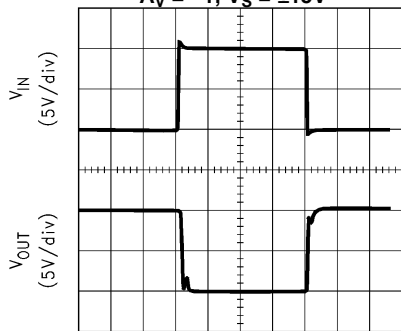

Time (50 ns/div)
Figure 33.

Small Signal Pulse Response
 $A_V = -1, V_S = \pm 15\text{V}$

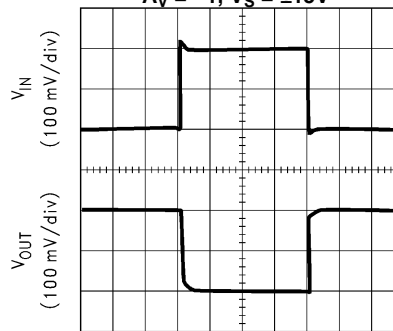

Time (50 ns/div)
Figure 34.

Large Signal Pulse Response
 $A_V = -1, V_S = \pm 5\text{V}$

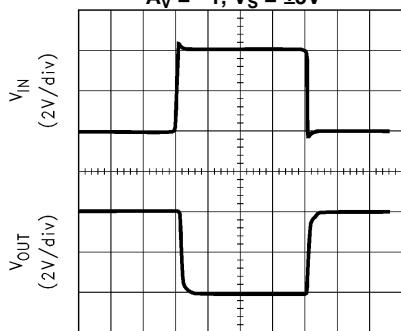

Time (50 ns/div)
Figure 35.

Small Signal Pulse Response
 $A_V = -1, V_S = \pm 5\text{V}$

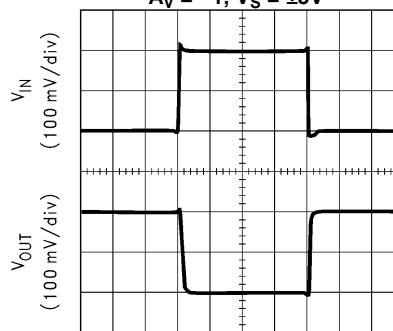

Time (50 ns/div)
Figure 36.

Closed Loop Frequency Response vs. Supply Voltage
 $(A_V = +1)$

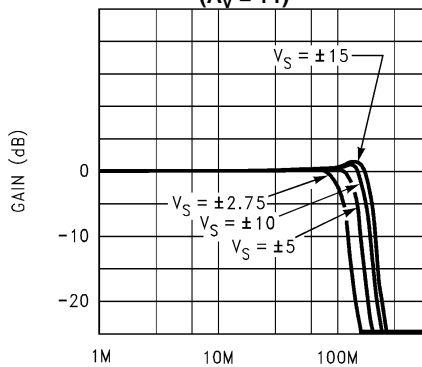

Figure 37.

Closed Loop Frequency Response vs. Supply Voltage
 $(A_V = +2)$

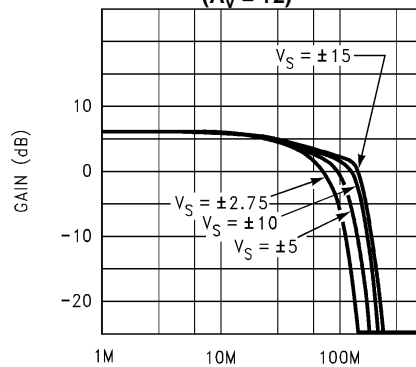

Figure 38.

TYPICAL PERFORMANCE CHARACTERISTICS (continued)

Unless otherwise noted, $T_A = 25^\circ\text{C}$

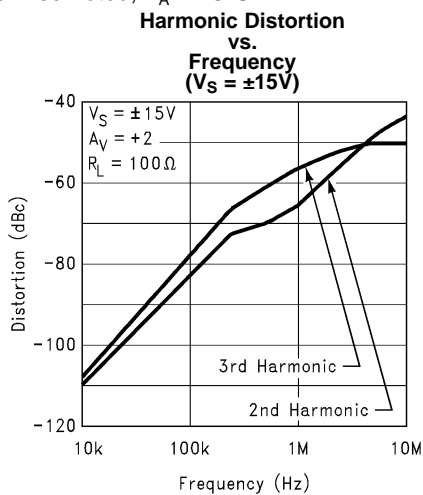

Figure 39.

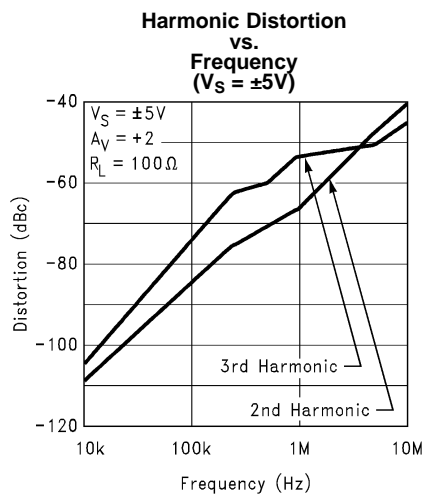

Figure 40.

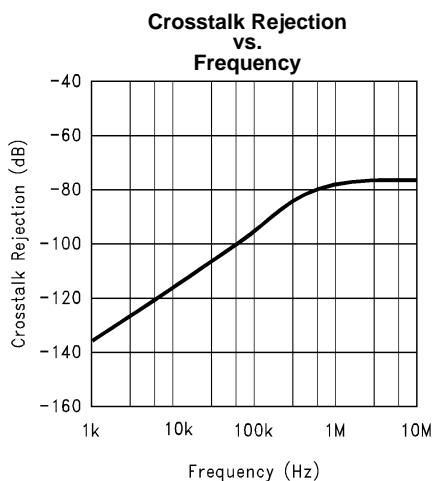

Figure 41.

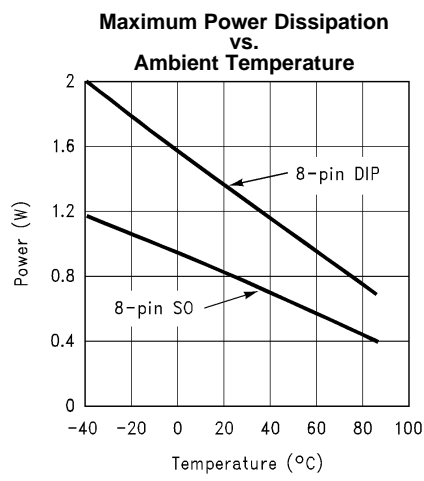

Figure 42.

APPLICATION NOTES

LM6172 PERFORMANCE DISCUSSION

The LM6172 is a dual high-speed, low power, voltage feedback amplifier. It is unity-gain stable and offers outstanding performance with only 2.3mA of supply current per channel. The combination of 100MHz unity-gain bandwidth, 3000V/ μ s slew rate, 50mA per channel output current and other attractive features makes it easy to implement the LM6172 in various applications. Quiescent power of the LM6172 is 138mW operating at \pm 15V supply and 46mW at \pm 5V supply.

LM6172 CIRCUIT OPERATION

The class AB input stage in LM6172 is fully symmetrical and has a similar slewing characteristic to the current feedback amplifiers. In the LM6172 Simplified Schematic (Page 2), Q1 through Q4 form the equivalent of the current feedback input buffer, R_E the equivalent of the feedback resistor, and stage A buffers the inverting input. The triple-buffered output stage isolates the gain stage from the load to provide low output impedance.

LM6172 SLEW RATE CHARACTERISTIC

The slew rate of LM6172 is determined by the current available to charge and discharge an internal high impedance node capacitor. This current is the differential input voltage divided by the total degeneration resistor R_E . Therefore, the slew rate is proportional to the input voltage level, and the higher slew rates are achievable in the lower gain configurations.

When a very fast large signal pulse is applied to the input of an amplifier, some overshoot or undershoot occurs. By placing an external series resistor such as 1k Ω to the input of LM6172, the slew rate is reduced to help lower the overshoot, which reduces settling time.

REDUCING SETTling TIME

The LM6172 has a very fast slew rate that causes overshoot and undershoot. To reduce settling time on LM6172, a 1k Ω resistor can be placed in series with the input signal to decrease slew rate. A feedback capacitor can also be used to reduce overshoot and undershoot. This feedback capacitor serves as a zero to increase the stability of the amplifier circuit. A 2pF feedback capacitor is recommended for initial evaluation. When the LM6172 is configured as a buffer, a feedback resistor of 1k Ω must be added in parallel to the feedback capacitor.

Another possible source of overshoot and undershoot comes from capacitive load at the output. Please see the section “[Driving Capacitive Loads](#)” for more detail.

DRIVING CAPACITIVE LOADS

Amplifiers driving capacitive loads can oscillate or have ringing at the output. To eliminate oscillation or reduce ringing, an isolation resistor can be placed as shown in [Figure 43](#). The combination of the isolation resistor and the load capacitor forms a pole to increase stability by adding more phase margin to the overall system. The desired performance depends upon the value of the isolation resistor; the bigger the isolation resistor, the more damped (slow) the pulse response becomes. For LM6172, a 50 Ω isolation resistor is recommended for initial evaluation.

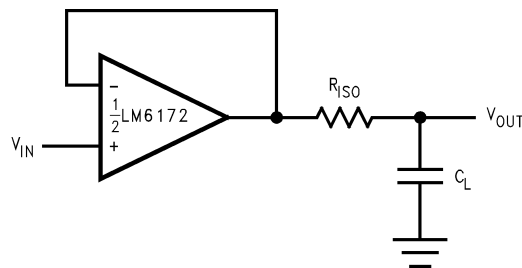

Figure 43. Isolation Resistor Used to Drive Capacitive Load

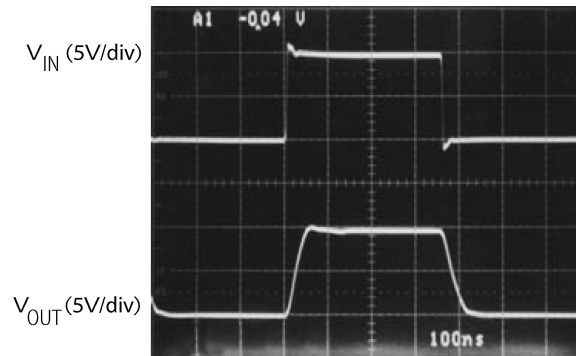

Figure 44. The LM6172 Driving a 510pF Load with a 30Ω Isolation Resistor

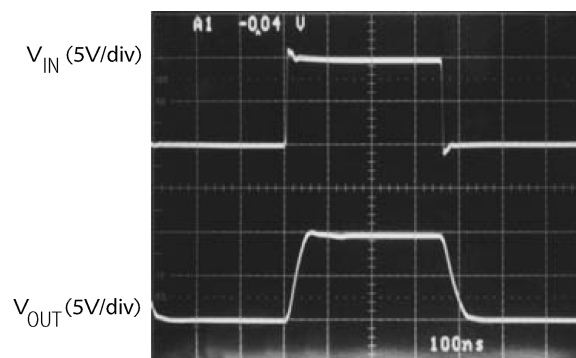

Figure 45. The LM6172 Driving a 220 pF Load with a 50Ω Isolation Resistor

LAYOUT CONSIDERATION

Printed Circuit Boards And High Speed Op Amps

There are many things to consider when designing PC boards for high speed op amps. Without proper caution, it is very easy to have excessive ringing, oscillation and other degraded AC performance in high speed circuits. As a rule, the signal traces should be short and wide to provide low inductance and low impedance paths. Any unused board space needs to be grounded to reduce stray signal pickup. Critical components should also be grounded at a common point to eliminate voltage drop. Sockets add capacitance to the board and can affect frequency performance. It is better to solder the amplifier directly into the PC board without using any socket.

Using Probes

Active (FET) probes are ideal for taking high frequency measurements because they have wide bandwidth, high input impedance and low input capacitance. However, the probe ground leads provide a long ground loop that will produce errors in measurement. Instead, the probes can be grounded directly by removing the ground leads and probe jackets and using scope probe jacks.

Components Selection And Feedback Resistor

It is important in high speed applications to keep all component leads short because wires are inductive at high frequency. For discrete components, choose carbon composition-type resistors and mica-type capacitors. Surface mount components are preferred over discrete components for minimum inductive effect.

Large values of feedback resistors can couple with parasitic capacitance and cause undesirable effects such as ringing or oscillation in high speed amplifiers. For LM6172, a feedback resistor less than 1kΩ gives optimal performance.

COMPENSATION FOR INPUT CAPACITANCE

The combination of an amplifier's input capacitance with the gain setting resistors adds a pole that can cause peaking or oscillation. To solve this problem, a feedback capacitor with a value

$$C_F > (R_G \times C_{IN})/R_F$$

can be used to cancel that pole. For LM6172, a feedback capacitor of 2pF is recommended. [Figure 46](#) illustrates the compensation circuit.

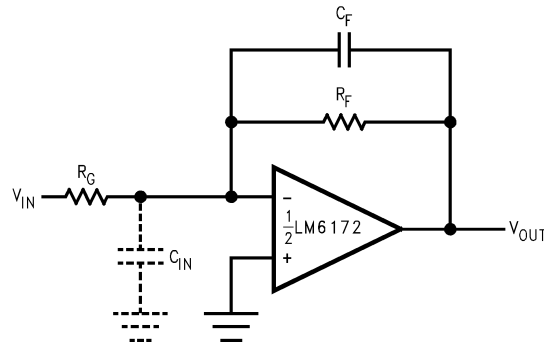

Figure 46. Compensating for Input Capacitance

POWER SUPPLY BYPASSING

Bypassing the power supply is necessary to maintain low power supply impedance across frequency. Both positive and negative power supplies should be bypassed individually by placing 0.01μF ceramic capacitors directly to power supply pins and 2.2μF tantalum capacitors close to the power supply pins.

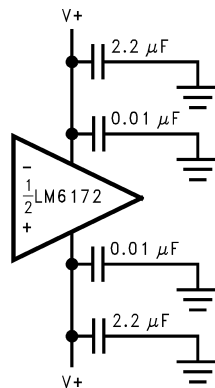

Figure 47. Power Supply Bypassing

TERMINATION

In high frequency applications, reflections occur if signals are not properly terminated. [Figure 48](#) shows a properly terminated signal while [Figure 49](#) shows an improperly terminated signal.

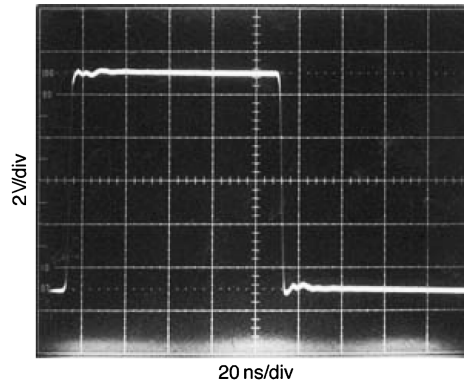

Figure 48. Properly Terminated Signal

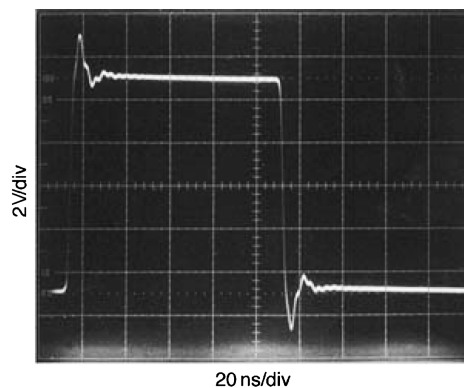

Figure 49. Improperly Terminated Signal

To minimize reflection, coaxial cable with matching characteristic impedance to the signal source should be used. The other end of the cable should be terminated with the same value terminator or resistor. For the commonly used cables, RG59 has 75Ω characteristic impedance, and RG58 has 50Ω characteristic impedance.

POWER DISSIPATION

The maximum power allowed to dissipate in a device is defined as:

$$P_D = (T_{J(max)} - T_A) / \theta_{JA}$$

Where

- P_D is the power dissipation in a device
- $T_{J(max)}$ is the maximum junction temperature
- T_A is the ambient temperature
- θ_{JA} is the thermal resistance of a particular package

For example, for the LM6172 in a SOIC-16 package, the maximum power dissipation at 25°C ambient temperature is 1000mW.

Thermal resistance, θ_{JA} , depends on parameters such as die size, package size and package material. The smaller the die size and package, the higher θ_{JA} becomes. The 8-pin CDIP package has a lower thermal resistance (95°C/W) than that of 8-pin SOIC (160°C/W). Therefore, for higher dissipation capability, use an 8-pin CDIP package.

The total power dissipated in a device can be calculated as:

$$P_D = P_Q + P_L$$

- P_Q is the quiescent power dissipated in a device with no load connected at the output.
- P_L is the power dissipated in the device with a load connected at the output; it is not the power dissipated by

the load.

Furthermore,

- P_Q : = supply current x total supply voltage with no load
- P_L : = output current x (voltage difference between supply voltage and output voltage of the same supply)

For example, the total power dissipated by the LM6172 with $V_S = \pm 15V$ and both channels swinging output voltage of 10V into 1k Ω is

$$P_D: = P_Q + P_L$$

$$: = 2[(2.3mA)(30V)] + 2[(10mA)(15V - 10V)]$$

$$: = 138mW + 100mW$$

$$: = 238mW$$

Application Circuits

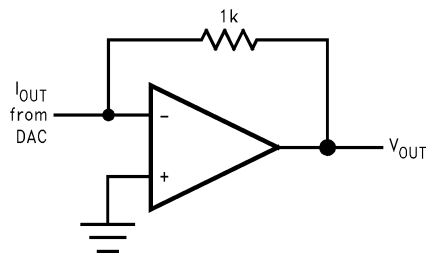

Figure 50. I- to -V Converters

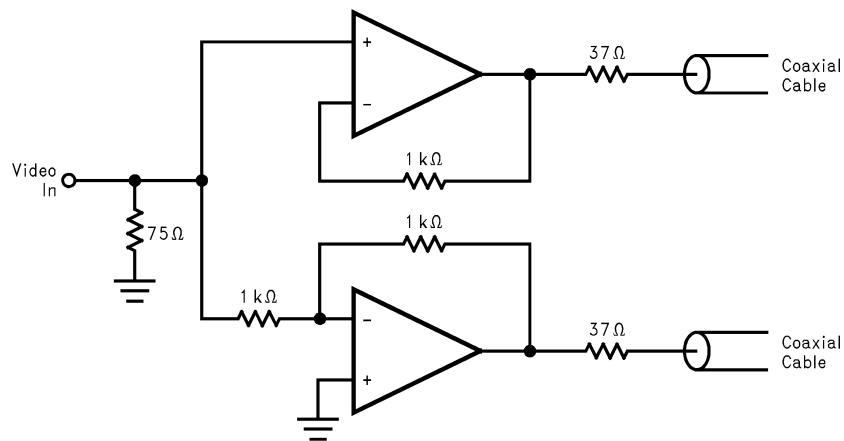

Figure 51. Differential Line Driver

REVISION HISTORY

Released	Revision	Section	Changes
12/08/2010	A	New Release, Corporate format	1 MDS data sheet converted into one Corp. data sheet format. MNLM6172AM-X-RH Rev 0A0 will be archived.
10/05/2011	B	Features, Ordering Information, Abs Max Ratings, Footnotes	Update Radiation, Add new ELDRS FREE die id, 'GW' NSID'S w/coresponding SMD numbers. Add 'GW' Theta JA & Theta JC along with weight. Add Note 15, Modify Note 14. LM6172QML Rev A will be archived.

PACKAGING INFORMATION

Orderable part number	Status (1)	Material type (2)	Package Pins	Package qty Carrier	RoHS (3)	Lead finish/ Ball material (4)	MSL rating/ Peak reflow (5)	Op temp (°C)	Part marking (6)
5962-9560401QPA	Active	Production	CDIP (NAB) 8	40 TUBE	No	SNPB	Level-1-NA-UNLIM	-55 to 125	LM6172AMJQML 5962-95604 01QPA Q ACO 01QPA Q >T
5962-9560402QXA	Active	Production	CFP (NAC) 16	88 JEDEC TRAY (5+1)	No	SNPB	Level-1-NA-UNLIM	-55 to 125	LM6172AMGW -QML Q 5962-95604 02QXA ACO 02QXA >T
5962F9560401V9A	Active	Production	DIESALE (Y) 0	39 NOT REQUIRED	Yes	Call TI	Level-1-NA-UNLIM	-55 to 125	
5962F9560401VPA	Active	Production	CDIP (NAB) 8	40 TUBE	No	SNPB	Level-1-NA-UNLIM	-55 to 125	LM6172AMJFQV 5962F95604 01VPA Q ACO 01VPA Q >T
5962F9560402VXA	Active	Production	CFP (NAC) 16	88 JEDEC TRAY (5+1)	No	SNPB	Level-1-NA-UNLIM	-55 to 125	LM6172AMGWF QMLV Q 5962F95604 02VXA ACO 02VXA >T
5962R9560403V9A	Last Time Buy	Production	DIESALE (Y) 0	39 NOT REQUIRED	Yes	Call TI	Level-1-NA-UNLIM	-55 to 125	
5962R9560403VXA	Active	Production	CFP (NAC) 16	88 JEDEC TRAY (5+1)	No	SNPB	Level-1-NA-UNLIM	-55 to 125	LM6172AMGW RLQMLV Q 5962R95604 03VXA ACO 03VXA >T
LM6172 MDR	Active	Production	DIESALE (Y) 0	39 NOT REQUIRED	Yes	Call TI	Level-1-NA-UNLIM	-55 to 125	
LM6172-MDE	Last Time Buy	Production	DIESALE (Y) 0	39 NOT REQUIRED	Yes	Call TI	Level-1-NA-UNLIM	-55 to 125	
LM6172-MDE.A	Last Time Buy	Production	DIESALE (Y) 0	39 NOT REQUIRED	Yes	Call TI	Level-1-NA-UNLIM	-55 to 125	
LM6172-MDR.A	Active	Production	DIESALE (Y) 0	39 NOT REQUIRED	Yes	Call TI	Level-1-NA-UNLIM	-55 to 125	

Orderable part number	Status (1)	Material type (2)	Package Pins	Package qty Carrier	RoHS (3)	Lead finish/ Ball material (4)	MSL rating/ Peak reflow (5)	Op temp (°C)	Part marking (6)
LM6172AMGW-QML	Active	Production	CFP (NAC) 16	88 JEDEC TRAY (5+1)	No	SNPB	Level-1-NA-UNLIM	-55 to 125	LM6172AMGW -QML Q 5962-95604 02QXA ACO 02QXA >T
LM6172AMGW-QML.A	Active	Production	CFP (NAC) 16	88 JEDEC TRAY (5+1)	No	SNPB	Level-1-NA-UNLIM	-55 to 125	LM6172AMGW -QML Q 5962-95604 02QXA ACO 02QXA >T
LM6172AMGWFQMLV	Active	Production	CFP (NAC) 16	88 JEDEC TRAY (5+1)	No	SNPB	Level-1-NA-UNLIM	-55 to 125	LM6172AMGWF QMLV Q 5962F95604 02VXA ACO 02VXA >T
LM6172AMGWFQMLV.A	Active	Production	CFP (NAC) 16	88 JEDEC TRAY (5+1)	No	SNPB	Level-1-NA-UNLIM	-55 to 125	LM6172AMGWF QMLV Q 5962F95604 02VXA ACO 02VXA >T
LM6172AMGWRLQV	Active	Production	CFP (NAC) 16	88 JEDEC TRAY (5+1)	No	SNPB	Level-1-NA-UNLIM	-55 to 125	LM6172AMGW RLQMLV Q 5962R95604 03VXA ACO 03VXA >T
LM6172AMGWRLQV.A	Active	Production	CFP (NAC) 16	88 JEDEC TRAY (5+1)	No	SNPB	Level-1-NA-UNLIM	-55 to 125	LM6172AMGW RLQMLV Q 5962R95604 03VXA ACO 03VXA >T
LM6172AMJ-QML	Active	Production	CDIP (NAB) 8	40 TUBE	No	SNPB	Level-1-NA-UNLIM	-55 to 125	LM6172AMJQML 5962-95604 01QPA Q ACO 01QPA Q >T
LM6172AMJ-QML.A	Active	Production	CDIP (NAB) 8	40 TUBE	No	SNPB	Level-1-NA-UNLIM	-55 to 125	LM6172AMJQML 5962-95604 01QPA Q ACO 01QPA Q >T

Orderable part number	Status (1)	Material type (2)	Package Pins	Package qty Carrier	RoHS (3)	Lead finish/ Ball material (4)	MSL rating/ Peak reflow (5)	Op temp (°C)	Part marking (6)
LM6172AMJFQMLV	Active	Production	CDIP (NAB) 8	40 TUBE	No	SNPB	Level-1-NA-UNLIM	-55 to 125	LM6172AMJFQV 5962F95604 01VPA Q ACO 01VPA Q >T
LM6172AMJFQMLV.A	Active	Production	CDIP (NAB) 8	40 TUBE	No	SNPB	Level-1-NA-UNLIM	-55 to 125	LM6172AMJFQV 5962F95604 01VPA Q ACO 01VPA Q >T
LM6172NAB/EM	Active	Production	CDIP (NAB) 8	40 TUBE	No	SNPB	Level-1-NA-UNLIM	-55 to 125	LM6172NABEM EVAL ONLY ACO

(1) Status: For more details on status, see our [product life cycle](#).

(2) Material type: When designated, preproduction parts are prototypes/experimental devices, and are not yet approved or released for full production. Testing and final process, including without limitation quality assurance, reliability performance testing, and/or process qualification, may not yet be complete, and this item is subject to further changes or possible discontinuation. If available for ordering, purchases will be subject to an additional waiver at checkout, and are intended for early internal evaluation purposes only. These items are sold without warranties of any kind.

(3) RoHS values: Yes, No, RoHS Exempt. See the [TI RoHS Statement](#) for additional information and value definition.

(4) Lead finish/Ball material: Parts may have multiple material finish options. Finish options are separated by a vertical ruled line. Lead finish/Ball material values may wrap to two lines if the finish value exceeds the maximum column width.

(5) MSL rating/Peak reflow: The moisture sensitivity level ratings and peak solder (reflow) temperatures. In the event that a part has multiple moisture sensitivity ratings, only the lowest level per JEDEC standards is shown. Refer to the shipping label for the actual reflow temperature that will be used to mount the part to the printed circuit board.

(6) Part marking: There may be an additional marking, which relates to the logo, the lot trace code information, or the environmental category of the part.

Multiple part markings will be inside parentheses. Only one part marking contained in parentheses and separated by a "~" will appear on a part. If a line is indented then it is a continuation of the previous line and the two combined represent the entire part marking for that device.

Important Information and Disclaimer: The information provided on this page represents TI's knowledge and belief as of the date that it is provided. TI bases its knowledge and belief on information provided by third parties, and makes no representation or warranty as to the accuracy of such information. Efforts are underway to better integrate information from third parties. TI has taken and continues to take reasonable steps to provide representative and accurate information but may not have conducted destructive testing or chemical analysis on incoming materials and chemicals. TI and TI suppliers consider certain information to be proprietary, and thus CAS numbers and other limited information may not be available for release.

In no event shall TI's liability arising out of such information exceed the total purchase price of the TI part(s) at issue in this document sold by TI to Customer on an annual basis.

OTHER QUALIFIED VERSIONS OF LM6172QML, LM6172QML-SP :

- Military : [LM6172QML](#)
- Space : [LM6172QML-SP](#)

NOTE: Qualified Version Definitions:

- Military - QML certified for Military and Defense Applications
- Space - Radiation tolerant, ceramic packaging and qualified for use in Space-based application

TUBE



*All dimensions are nominal

Device	Package Name	Package Type	Pins	SPQ	L (mm)	W (mm)	T (μm)	B (mm)
5962-9560401QPA	NAB	CDIP	8	40	506.98	15.24	13440	NA
5962F9560401VPA	NAB	CDIP	8	40	506.98	15.24	13440	NA
LM6172AMJ-QML	NAB	CDIP	8	40	506.98	15.24	13440	NA
LM6172AMJ-QML.A	NAB	CDIP	8	40	506.98	15.24	13440	NA
LM6172AMJFQMLV	NAB	CDIP	8	40	506.98	15.24	13440	NA
LM6172AMJFQMLV.A	NAB	CDIP	8	40	506.98	15.24	13440	NA
LM6172NAB/EM	NAB	CDIP	8	40	506.98	15.24	13440	NA

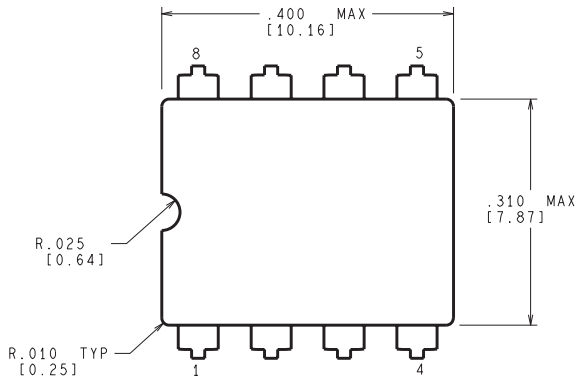
NAB0008A

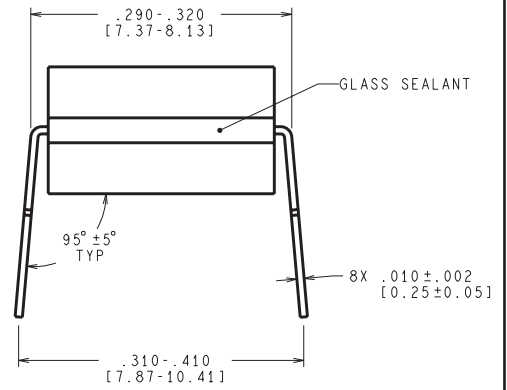
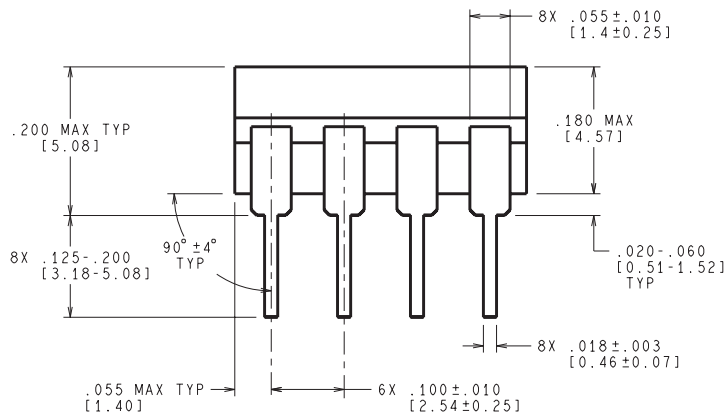

CONTROLLING DIMENSION IS INCH
VALUES IN [] ARE MILLIMETERS



J08A (Rev M)

EXAMPLE BOARD LAYOUT

NAC0016A

CFP - 2.33mm max height

CERAMIC FLATPACK

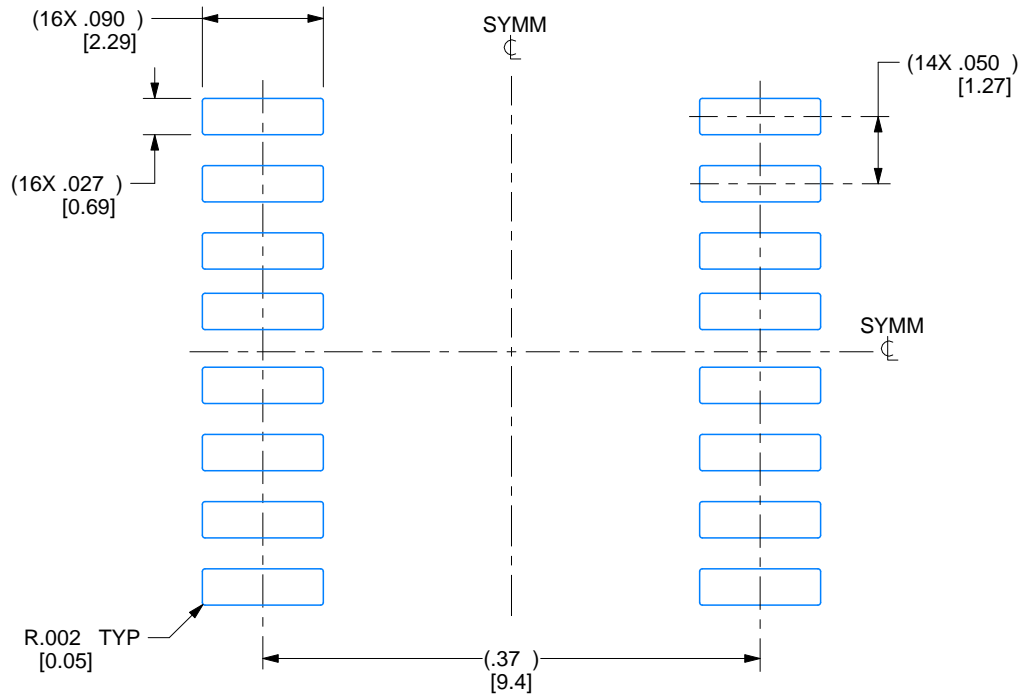

RECOMMENDED LAND PATTERN

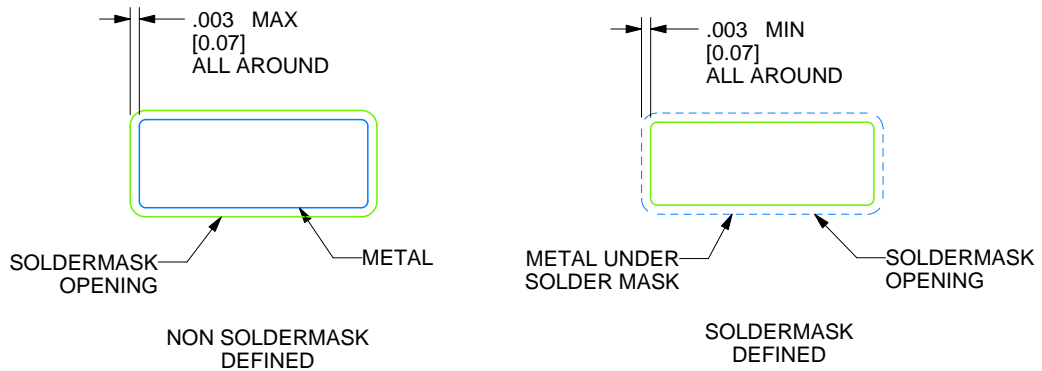

4215198/C 08/2022

REVISIONS

REV	DESCRIPTION	E.C.N.	DATE	BY/APP'D
A	RELEASE TO DOCUMENT CONTROL	2197879	12/30/2021	TINA TRAN / ANIS FAUZI
B	NO CHANGE TO DRAWING; REVISION FOR YODA RELEASE;	2198832	02/15/2022	K. SINCERBOX
C	.387±.003 WAS .39000±.00012;	2200917	08/08/2022	D. CHIN / K. SINCERBOX

IMPORTANT NOTICE AND DISCLAIMER

TI PROVIDES TECHNICAL AND RELIABILITY DATA (INCLUDING DATASHEETS), DESIGN RESOURCES (INCLUDING REFERENCE DESIGNS), APPLICATION OR OTHER DESIGN ADVICE, WEB TOOLS, SAFETY INFORMATION, AND OTHER RESOURCES "AS IS" AND WITH ALL FAULTS, AND DISCLAIMS ALL WARRANTIES, EXPRESS AND IMPLIED, INCLUDING WITHOUT LIMITATION ANY IMPLIED WARRANTIES OF MERCHANTABILITY, FITNESS FOR A PARTICULAR PURPOSE OR NON-INFRINGEMENT OF THIRD PARTY INTELLECTUAL PROPERTY RIGHTS.

These resources are intended for skilled developers designing with TI products. You are solely responsible for (1) selecting the appropriate TI products for your application, (2) designing, validating and testing your application, and (3) ensuring your application meets applicable standards, and any other safety, security, regulatory or other requirements.

These resources are subject to change without notice. TI grants you permission to use these resources only for development of an application that uses the TI products described in the resource. Other reproduction and display of these resources is prohibited. No license is granted to any other TI intellectual property right or to any third party intellectual property right. TI disclaims responsibility for, and you fully indemnify TI and its representatives against any claims, damages, costs, losses, and liabilities arising out of your use of these resources.

TI's products are provided subject to [TI's Terms of Sale](#), [TI's General Quality Guidelines](#), or other applicable terms available either on ti.com or provided in conjunction with such TI products. TI's provision of these resources does not expand or otherwise alter TI's applicable warranties or warranty disclaimers for TI products. Unless TI explicitly designates a product as custom or customer-specified, TI products are standard, catalog, general purpose devices.

TI objects to and rejects any additional or different terms you may propose.

Copyright © 2026, Texas Instruments Incorporated

Last updated 10/2025