

LM6142/LM6144 17 MHz Rail-to-Rail Input-Output Operational Amplifiers

 Check for Samples: [LM6142](#), [LM6144](#)

FEATURES

 At $V_S = 5V$. Typ Unless Noted.

- Rail-to-rail Input CMVR $-0.25V$ to $5.25V$
- Rail-to-Rail Output Swing $0.005V$ to $4.995V$
- Wide Gain-Bandwidth: $17MHz$ at $50kHz$ (typ)
- Slew Rate:
 - Small Signal, $5V/\mu s$
 - Large Signal, $30V/\mu s$
- Low Supply Current $650\mu A/Amplifier$
- Wide Supply Range $1.8V$ to $24V$
- CMRR $107dB$
- Gain $108dB$ with $R_L = 10k$
- PSRR $87dB$

APPLICATIONS

- Battery Operated Instrumentation
- Depth Sounders/Fish Finders
- Barcode Scanners
- Wireless Communications
- Rail-to-Rail in-out Instrumentation Amps

Connection Diagrams

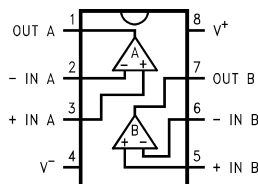
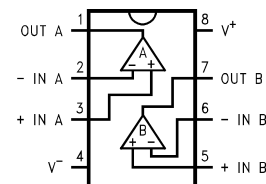
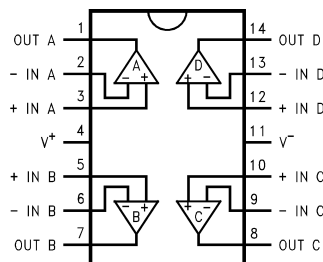
**Figure 1. 8-Pin CDIP
Top View**

**Figure 2. 8-Pin PDIP/SOIC
Top View**

**Figure 3. 14-Pin PDIP/SOIC
Top View**

DESCRIPTION

Using patent pending new circuit topologies, the LM6142/LM6144 provides new levels of performance in applications where low voltage supplies or power limitations previously made compromise necessary. Operating on supplies of $1.8V$ to over $24V$, the LM6142/LM6144 is an excellent choice for battery operated systems, portable instrumentation and others.

The greater than rail-to-rail input voltage range eliminates concern over exceeding the common-mode voltage range. The rail-to-rail output swing provides the maximum possible dynamic range at the output. This is particularly important when operating on low supply voltages.

High gain-bandwidth with $650\mu A/Amplifier$ supply current opens new battery powered applications where previous higher power consumption reduced battery life to unacceptable levels. The ability to drive large capacitive loads without oscillating functionally removes this common problem.



Please be aware that an important notice concerning availability, standard warranty, and use in critical applications of Texas Instruments semiconductor products and disclaimers thereto appears at the end of this data sheet.

All trademarks are the property of their respective owners.



These devices have limited built-in ESD protection. The leads should be shorted together or the device placed in conductive foam during storage or handling to prevent electrostatic damage to the MOS gates.

Absolute Maximum Ratings⁽¹⁾⁽²⁾

ESD Tolerance ⁽³⁾	2500V
Differential Input Voltage	15V
Voltage at Input/Output Pin	(V ⁺) + 0.3V, (V ⁻) - 0.3V
Supply Voltage (V ⁺ - V ⁻)	35V
Current at Input Pin	±10mA
Current at Output Pin ⁽⁴⁾	±25mA
Current at Power Supply Pin	50mA
Lead Temperature (soldering, 10 sec)	260°C
Storage Temp. Range	-65°C to +150°C
Junction Temperature ⁽⁵⁾	150°C

- (1) Absolute Maximum Ratings indicate limits beyond which damage to the device may occur. Operating Ratings indicate conditions for which the device is intended to be functional, but specific performance is not guaranteed. For guaranteed specifications and the test conditions, see the Electrical Characteristics.
- (2) If Military/Aerospace specified devices are required, please contact the Texas Instruments Sales Office/ Distributors for availability and specifications.
- (3) Human body model, 1.5kΩ in series with 100pF.
- (4) Applies to both single-supply and split-supply operation. Continuous short circuit operation at elevated ambient temperature can result in exceeding the maximum allowed junction temperature of 150°C.
- (5) The maximum power dissipation is a function of T_{J(MAX)}, θ_{JA}, and T_A. The maximum allowable power dissipation at any ambient temperature is P_D = (T_{J(MAX)} - T_A)/θ_{JA}. All numbers apply for packages soldered directly into a PC board.

Operating Ratings⁽¹⁾

Supply Voltage	1.8V ≤ V ⁺ ≤ 24V	
Temperature Range LM6142, LM6144	-40°C ≤ T _A ≤ +85°C	
Thermal Resistance (θ _{JA})	P Package, 8-Pin PDIP	115°C/W
	D Package, 8-Pin SOIC	193°C/W
	NFF Package, 14-Pin PDIP	81°C/W
	D Package, 14-Pin SOIC	126°C/W

- (1) Absolute Maximum Ratings indicate limits beyond which damage to the device may occur. Operating Ratings indicate conditions for which the device is intended to be functional, but specific performance is not guaranteed. For guaranteed specifications and the test conditions, see the Electrical Characteristics.

5.0V DC Electrical Characteristics⁽¹⁾

Unless otherwise specified, all limits guaranteed for T_A = 25°C, V⁺ = 5.0V, V⁻ = 0V, V_{CM} = V_O = V⁺/2 and R_L > 1 MΩ to V⁺/2.

Boldface limits apply at the temperature extremes.

Symbol	Parameter	Conditions	Typ ⁽²⁾	LM6144AI LM6142AI Limit ⁽³⁾	LM6144BI LM6142BI Limit ⁽³⁾	Units
V _{OS}	Input Offset Voltage		0.3	1.0	2.5	mV
				2.2	3.3	max
TCV _{OS}	Input Offset Voltage Average Drift		3			μV/°C
I _B	Input Bias Current		170	250	300	nA
		0V ≤ V _{CM} ≤ 5V	180	280		max
				526	526	

- (1) Electrical Table values apply only for factory testing conditions at the temperature indicated. Factory testing conditions result in very limited self-heating of the device such that T_J = T_A. No guarantee of parametric performance is indicated in the electrical tables under conditions of the internal self heating where T_J > T_A.
- (2) Typical values represent the most likely parametric norm.
- (3) All limits are guaranteed by testing or statistical analysis.

5.0V DC Electrical Characteristics⁽¹⁾ (continued)

Unless otherwise specified, all limits guaranteed for $T_A = 25^\circ\text{C}$, $V^+ = 5.0\text{V}$, $V^- = 0\text{V}$, $V_{\text{CM}} = V_O = V^+/2$ and $R_L > 1\text{M}\Omega$ to $V^+/2$. **Boldface limits** apply at the temperature extremes.

Symbol	Parameter	Conditions	Typ ⁽²⁾	LM6144AI LM6142AI Limit ⁽³⁾	LM6144BI LM6142BI Limit ⁽³⁾	Units
I_{OS}	Input Offset Current		3	30 80	30 80	nA max
R_{IN}	Input Resistance, C_M		126			M Ω
CMRR	Common Mode Rejection Ratio	$0\text{V} \leq V_{\text{CM}} \leq 4\text{V}$	107	84 78	84 78	dB min
		$0\text{V} \leq V_{\text{CM}} \leq 5\text{V}$	82 79	66 64	66 64	
PSRR	Power Supply Rejection Ratio	$5\text{V} \leq V^+ \leq 24\text{V}$	87	80 78	80 78	
V_{CM}	Input Common-Mode Voltage Range		-0.25 5.25	0 5.0	0 5.0	V
A_V	Large Signal Voltage Gain	$R_L = 10\text{k}$	270 70	100 33	80 25	V/mV min
V_O	Output Swing	$R_L = 100\text{k}$	0.005	0.01 0.013	0.01 0.013	V max
			4.995	4.98 4.93	4.98 4.93	V min
		$R_L = 10\text{k}$	0.02			V max
			4.97			V min
		$R_L = 2\text{k}$	0.06	0.1 0.133	0.1 0.133	V max
4.90	4.86 4.80		4.86 4.80	V min		
I_{SC}	Output Short Circuit Current LM6142	Sourcing	13	10 4.9 35	8 4 35	mA min mA max
			24	10 5.3 35	10 5.3 35	mA min mA max
		Sinking	8	6 3 35	6 3 35	mA min mA max
			22	8 4 35	8 4 35	mA min mA max
I_{S}	Supply Current	Per Amplifier	650	800 880	800 880	μA max

5.0V AC Electrical Characteristics⁽¹⁾

Unless Otherwise Specified, All Limits Guaranteed for $T_A = 25^\circ\text{C}$, $V^+ = 5.0\text{V}$, $V^- = 0\text{V}$, $V_{\text{CM}} = V_O = V^+/2$ and $R_L > 1\text{ M}\Omega$ to $V^+/2$. **Boldface limits** apply at the temperature extremes.

Symbol	Parameter	Conditions	Typ ⁽²⁾	LM6144AI LM6142AI Limit ⁽³⁾	LM6144BI LM6142BI Limit ⁽³⁾	Units
SR	Slew Rate	8 V_{PP} @ $V^+ 12\text{V}$ $R_S > 1\text{ k}\Omega$	25	15	13	V/ μs min
				13	11	
GBW	Gain-Bandwidth Product	$f = 50\text{ kHz}$	17	10	10	MHz min
				6	6	
ϕ_m	Phase Margin		38			Deg
	Amp-to-Amp Isolation		130			dB
e_n	Input-Referred Voltage Noise	$f = 1\text{ kHz}$	16			$\frac{\text{nV}}{\sqrt{\text{Hz}}}$
i_n	Input-Referred Current Noise	$f = 1\text{ kHz}$	0.22			$\frac{\text{pA}}{\sqrt{\text{Hz}}}$
T.H.D.	Total Harmonic Distortion	$f = 10\text{ kHz}$, $R_L = 10\text{ k}\Omega$,	0.003			%

- (1) Electrical Table values apply only for factory testing conditions at the temperature indicated. Factory testing conditions result in very limited self-heating of the device such that $T_J = T_A$. No guarantee of parametric performance is indicated in the electrical tables under conditions of the internal self heating where $T_J > T_A$.
- (2) Typical values represent the most likely parametric norm.
- (3) All limits are guaranteed by testing or statistical analysis.

2.7V DC Electrical Characteristics⁽¹⁾

Unless Otherwise Specified, All Limits Guaranteed for $T_A = 25^\circ\text{C}$, $V^+ = 2.7\text{V}$, $V^- = 0\text{V}$, $V_{\text{CM}} = V_O = V^+/2$ and $R_L > 1\text{ M}\Omega$ to $V^+/2$. **Boldface limits** apply at the temperature extreme

Symbol	Parameter	Conditions	Typ ⁽²⁾	LM6144AI LM6142AI Limit ⁽³⁾	LM6144BI LM6142BI Limit ⁽³⁾	Units
V_{OS}	Input Offset Voltage		0.4	1.8	2.5	mV max
				4.3	5	
I_B	Input Bias Current		150	250	300	nA max
				526	526	
I_{OS}	Input Offset Current		4	30	30	nA max
				80	80	
R_{IN}	Input Resistance		128			$\text{M}\Omega$
CMRR	Common Mode Rejection Ratio	$0\text{V} \leq V_{\text{CM}} \leq 1.8\text{V}$	90			dB min
		$0\text{V} \leq V_{\text{CM}} \leq 2.7\text{V}$	76			
PSRR	Power Supply Rejection Ratio	$3\text{V} \leq V^+ \leq 5\text{V}$	79			
V_{CM}	Input Common-Mode Voltage Range		-0.25	0	0	V min
			2.95	2.7	2.7	V max
A_V	Large Signal Voltage Gain	$R_L = 10\text{k}$	55			V/mV min
V_O	Output Swing	$R_L = 100\text{k}\Omega$	0.019	0.08	0.08	V max
				0.112	0.112	
				2.67	2.66	
				2.25	2.25	

- (1) Electrical Table values apply only for factory testing conditions at the temperature indicated. Factory testing conditions result in very limited self-heating of the device such that $T_J = T_A$. No guarantee of parametric performance is indicated in the electrical tables under conditions of the internal self heating where $T_J > T_A$.
- (2) Typical values represent the most likely parametric norm.
- (3) All limits are guaranteed by testing or statistical analysis.

2.7V DC Electrical Characteristics⁽¹⁾ (continued)

Unless Otherwise Specified, All Limits Guaranteed for $T_A = 25^\circ\text{C}$, $V^+ = 2.7\text{V}$, $V^- = 0\text{V}$, $V_{\text{CM}} = V_O = V^+/2$ and $R_L > 1\text{ M}\Omega$ to $V^+/2$.

Boldface limits apply at the temperature extreme

Symbol	Parameter	Conditions	Typ ⁽²⁾	LM6144AI LM6142AI Limit ⁽³⁾	LM6144BI LM6142BI Limit ⁽³⁾	Units
I_S	Supply Current	Per Amplifier	510	800 880	800 880	μA max

2.7V AC Electrical Characteristics⁽¹⁾

Unless Otherwise Specified, All Limits Guaranteed for $T_A = 25^\circ\text{C}$, $V^+ = 2.7\text{V}$, $V^- = 0\text{V}$, $V_{\text{CM}} = V_O = V^+/2$ and $R_L > 1\text{ M}\Omega$ to $V^+/2$.

Boldface limits apply at the temperature extreme

Symbol	Parameter	Conditions	Typ ⁽²⁾	LM6144AI LM6142AI Limit ⁽³⁾	LM6144BI LM6142BI Limit ⁽³⁾	Units
GBW	Gain-Bandwidth Product	$f = 50\text{ kHz}$	9			MHz
Φ_m	Phase Margin		36			Deg
G_m	Gain Margin		6			dB

(1) Electrical Table values apply only for factory testing conditions at the temperature indicated. Factory testing conditions result in very limited self-heating of the device such that $T_J = T_A$. No guarantee of parametric performance is indicated in the electrical tables under conditions of the internal self heating where $T_J > T_A$.

(2) Typical values represent the most likely parametric norm.

(3) All limits are guaranteed by testing or statistical analysis.

24V Electrical Characteristics⁽¹⁾

Unless Otherwise Specified, All Limits Guaranteed for $T_A = 25^\circ\text{C}$, $V^+ = 24\text{V}$, $V^- = 0\text{V}$, $V_{\text{CM}} = V_O = V^+/2$ and $R_L > 1\text{ M}\Omega$ to $V^+/2$.

Boldface limits apply at the temperature extreme

Symbol	Parameter	Conditions	Typ ⁽²⁾	LM6144AI LM6142AI Limit ⁽³⁾	LM6144BI LM6142BI Limit ⁽³⁾	Units
V_{OS}	Input Offset Voltage		1.3	2 4.8	3.8 4.8	mV max
I_B	Input Bias Current		174			nA max
I_{OS}	Input Offset Current		5			nA max
R_{IN}	Input Resistance		288			$\text{M}\Omega$
CMRR	Common Mode Rejection Ratio	$0\text{V} \leq V_{\text{CM}} \leq 23\text{V}$	114			dB
		$0\text{V} \leq V_{\text{CM}} \leq 24\text{V}$	100			min
PSRR	Power Supply Rejection Ratio	$0\text{V} \leq V_{\text{CM}} \leq 24\text{V}$	87			
V_{CM}	Input Common-Mode Voltage Range		-0.25	0	0	V min
			24.25	24	24	V max
A_V	Large Signal Voltage Gain	$R_L = 10\text{k}$	500			V/mV min
V_O	Output Swing	$R_L = 10\text{ k}\Omega$	0.07	0.15 0.185	0.15 0.185	V max
			23.85	23.81	23.81	V
				23.62	23.62	min

(1) Electrical Table values apply only for factory testing conditions at the temperature indicated. Factory testing conditions result in very limited self-heating of the device such that $T_J = T_A$. No guarantee of parametric performance is indicated in the electrical tables under conditions of the internal self heating where $T_J > T_A$.

(2) Typical values represent the most likely parametric norm.

(3) All limits are guaranteed by testing or statistical analysis.

24V Electrical Characteristics⁽¹⁾ (continued)

Unless Otherwise Specified, All Limits Guaranteed for $T_A = 25^\circ\text{C}$, $V^+ = 24\text{V}$, $V^- = 0\text{V}$, $V_{\text{CM}} = V_O = V^+/2$ and $R_L > 1\text{ M}\Omega$ to $V^+/2$.

Boldface limits apply at the temperature extreme

Symbol	Parameter	Conditions	Typ ⁽²⁾	LM6144AI LM6142AI Limit ⁽³⁾	LM6144BI LM6142BI Limit ⁽³⁾	Units
I_S	Supply Current	Per Amplifier	750	1100 1150	1100 1150	μA max
GBW	Gain-Bandwidth Product	$f = 50\text{ kHz}$	18			MHz

Typical Performance Characteristics

$T_A = 25^\circ\text{C}$, $R_L = 10\text{ k}\Omega$ Unless Otherwise Specified

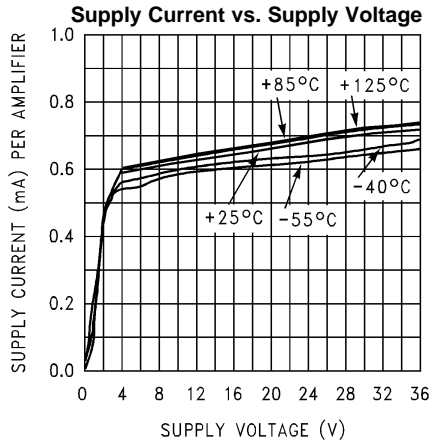

Figure 4.

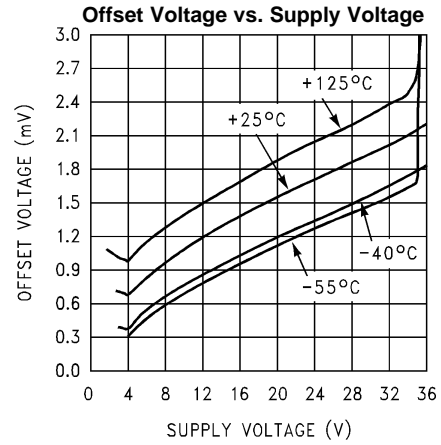

Figure 5.

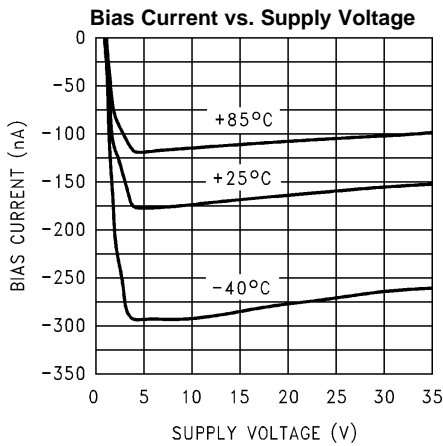

Figure 6.

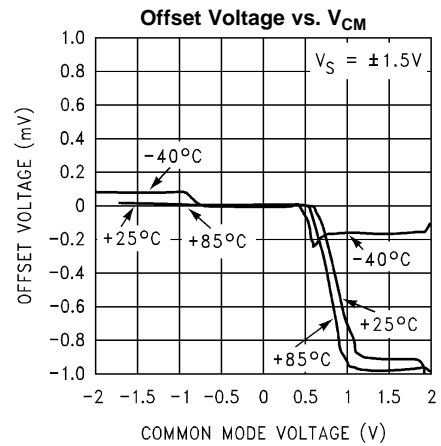

Figure 7.

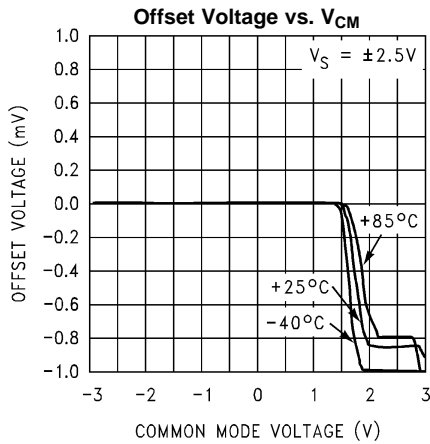

Figure 8.

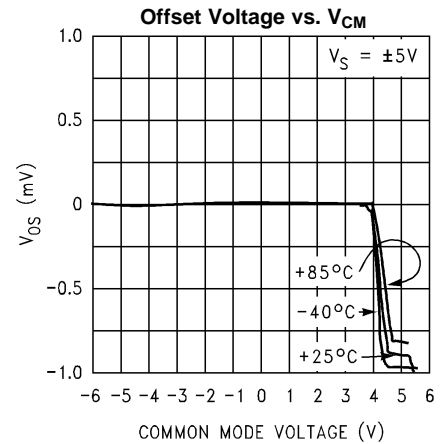

Figure 9.

Typical Performance Characteristics (continued)

$T_A = 25^\circ\text{C}$, $R_L = 10\text{ k}\Omega$ Unless Otherwise Specified

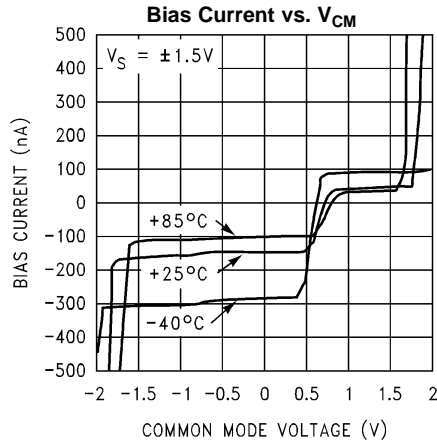

Figure 10.

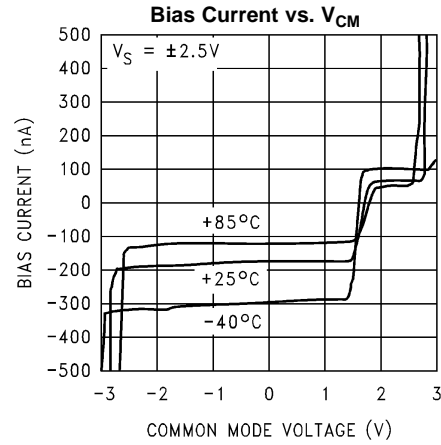

Figure 11.

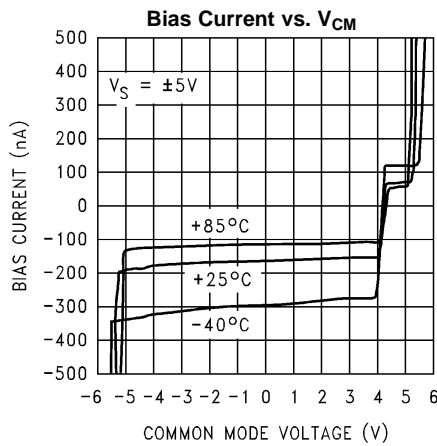

Figure 12.

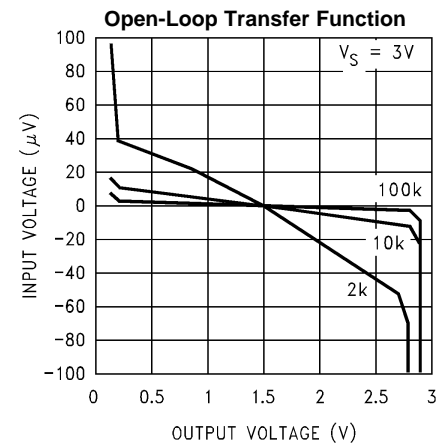

Figure 13.

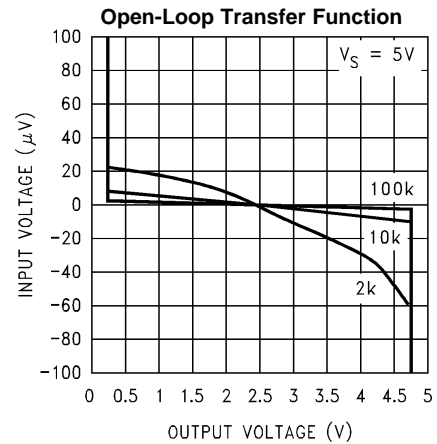

Figure 14.

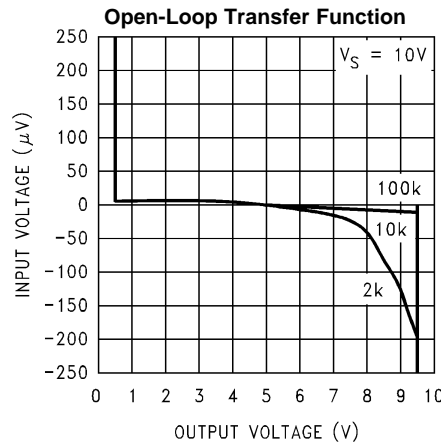

Figure 15.

Typical Performance Characteristics (continued)

T_A = 25°C, R_L = 10 kΩ Unless Otherwise Specified

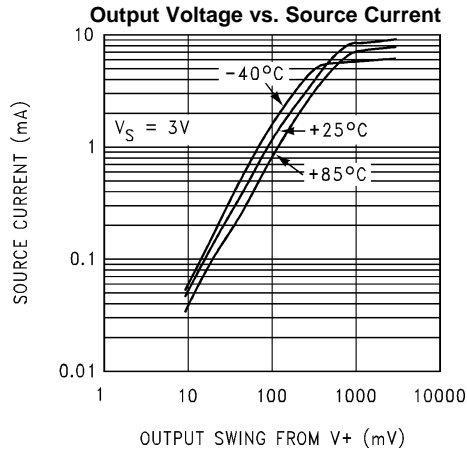

Figure 16.

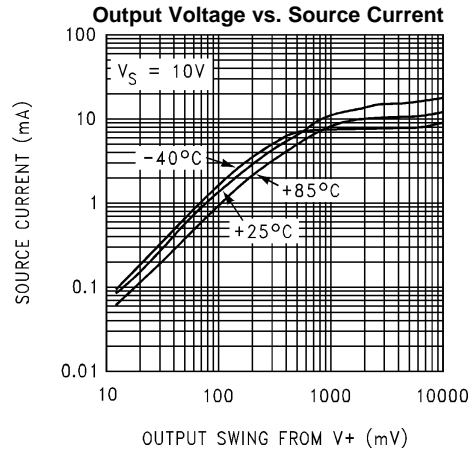

Figure 17.

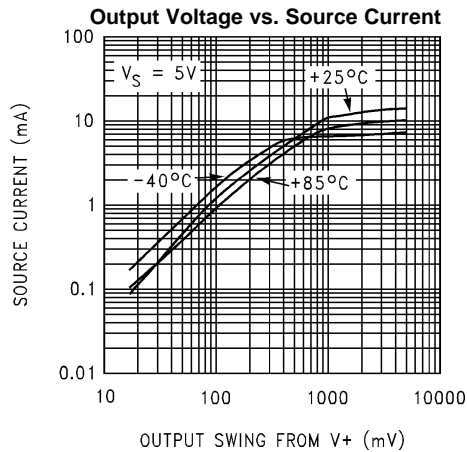

Figure 18.

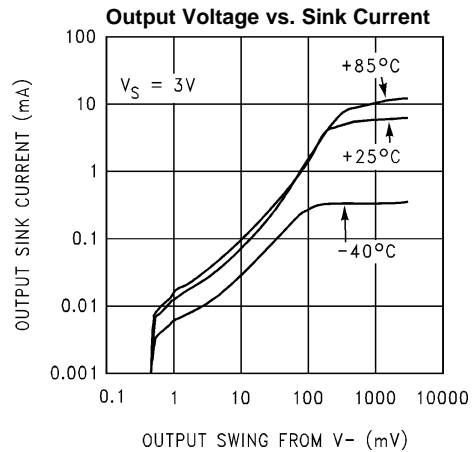

Figure 19.

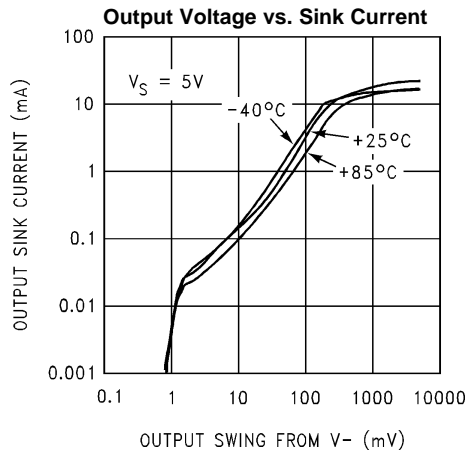

Figure 20.

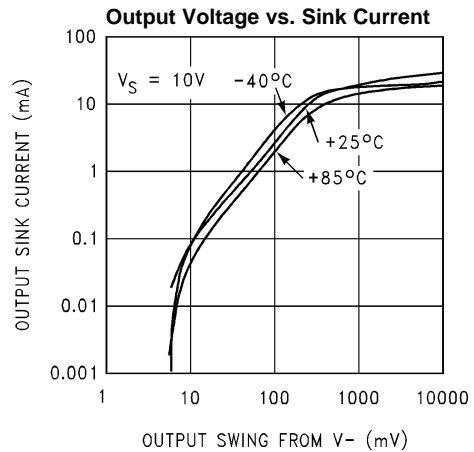

Figure 21.

Typical Performance Characteristics (continued)

$T_A = 25^\circ\text{C}$, $R_L = 10\text{ k}\Omega$ Unless Otherwise Specified

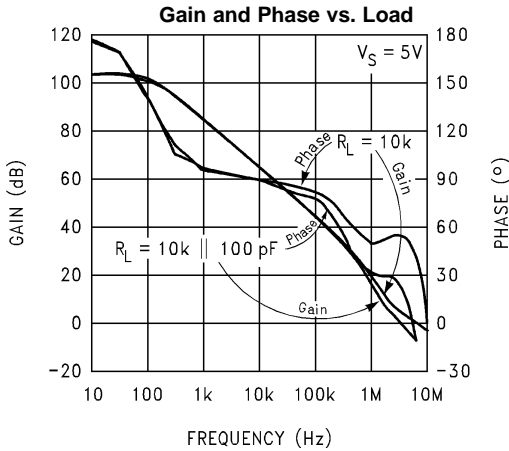

Figure 22.

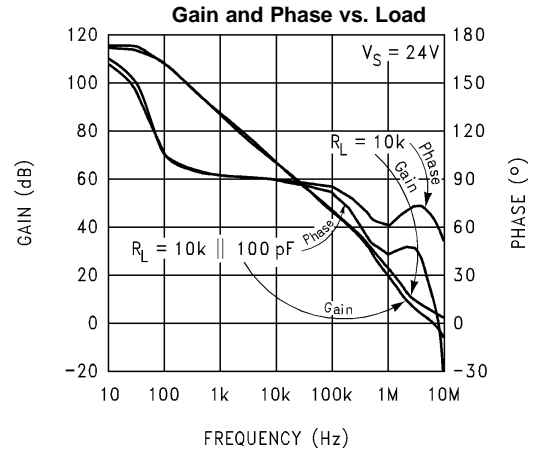

Figure 23.

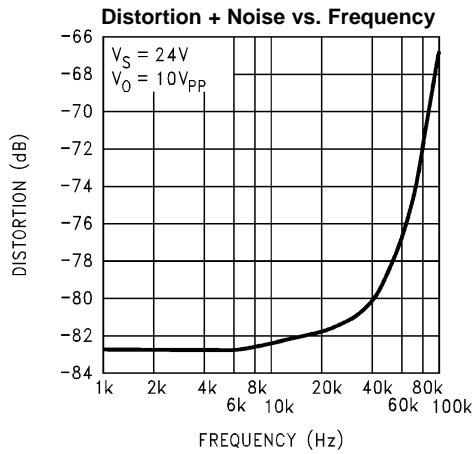

Figure 24.

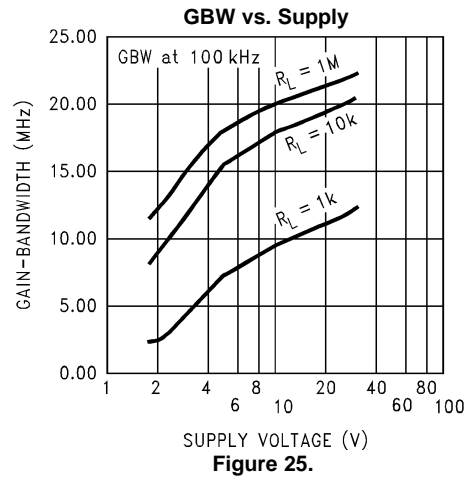

Figure 25.

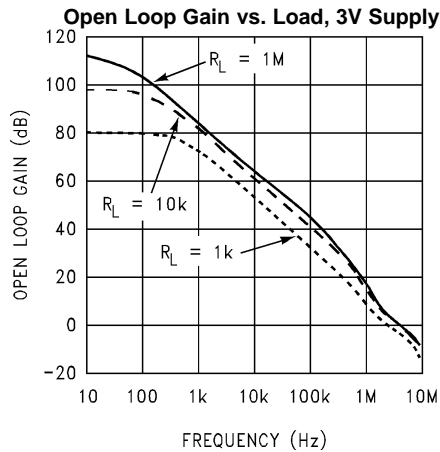

Figure 26.

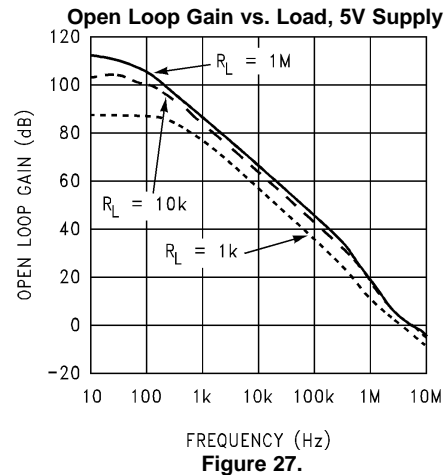

Figure 27.

Typical Performance Characteristics (continued)

T_A = 25°C, R_L = 10 kΩ Unless Otherwise Specified

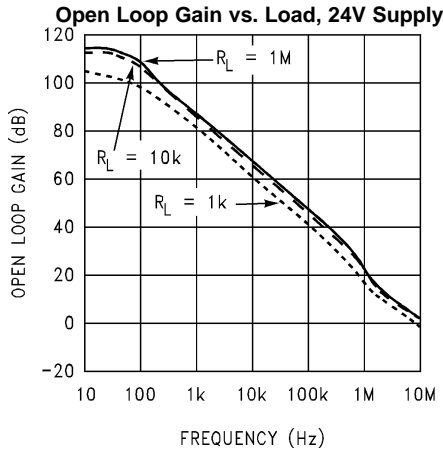

Figure 28.

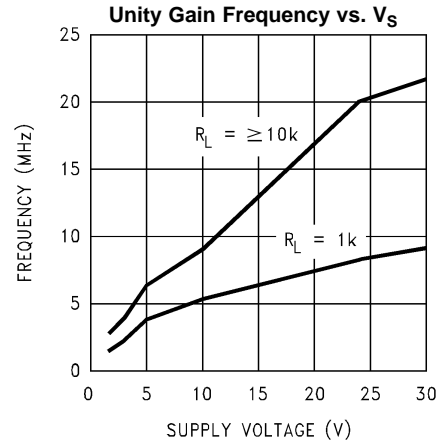

Figure 29.

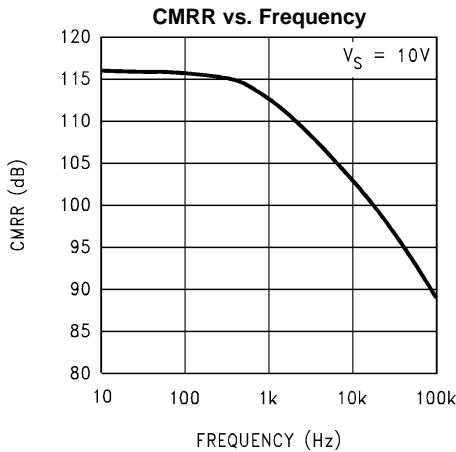

Figure 30.

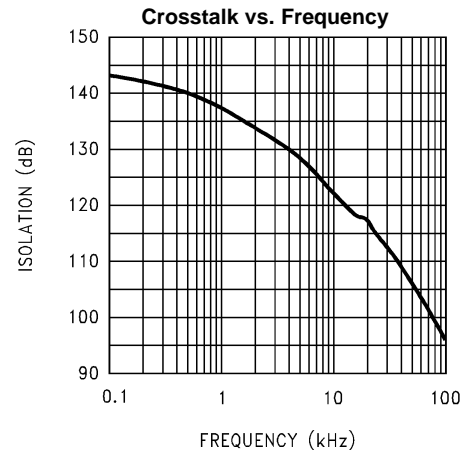

Figure 31.

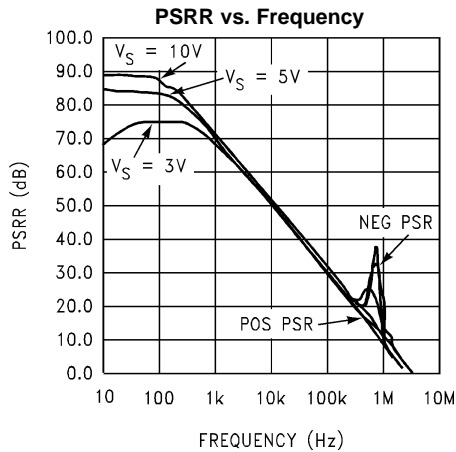

Figure 32.

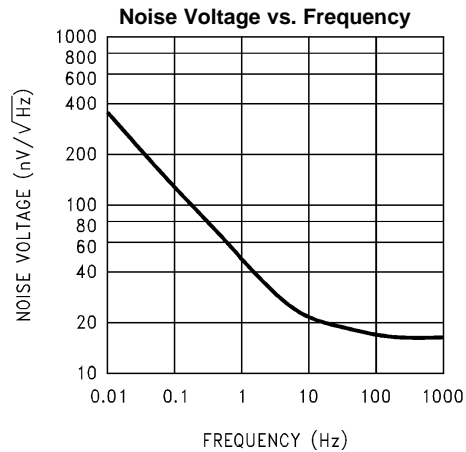
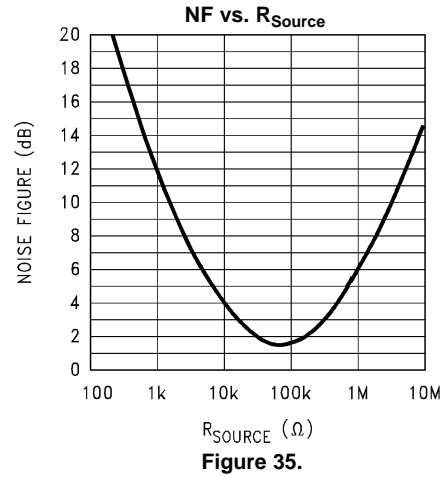
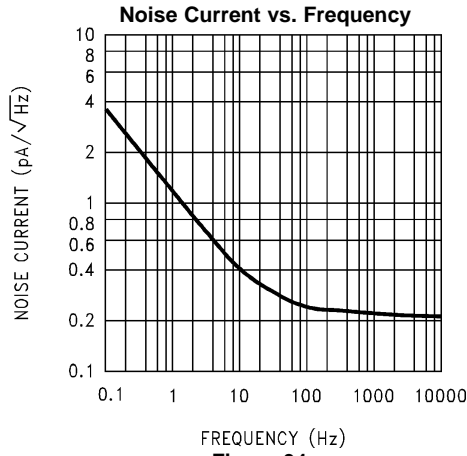

Figure 33.

Typical Performance Characteristics (continued)

$T_A = 25^\circ\text{C}$, $R_L = 10\text{ k}\Omega$ Unless Otherwise Specified



LM6142/LM6144 APPLICATION IDEAS

The LM6142 brings a new level of ease of use to op amp system design.

With greater than rail-to-rail input voltage range concern over exceeding the common-mode voltage range is eliminated.

Rail-to-rail output swing provides the maximum possible dynamic range at the output. This is particularly important when operating on low supply voltages.

The high gain-bandwidth with low supply current opens new battery powered applications, where high power consumption, previously reduced battery life to unacceptable levels.

To take advantage of these features, some ideas should be kept in mind.

ENHANCED SLEW RATE

Unlike most bipolar op amps, the unique phase reversal prevention/speed-up circuit in the input stage causes the slew rate to be very much a function of the input signal amplitude.

Figure 36 shows how excess input signal, is routed around the input collector-base junctions, directly to the current mirrors.

The LM6142/LM6144 input stage converts the input voltage change to a current change. This current change drives the current mirrors through the collectors of Q1–Q2, Q3–Q4 when the input levels are normal.

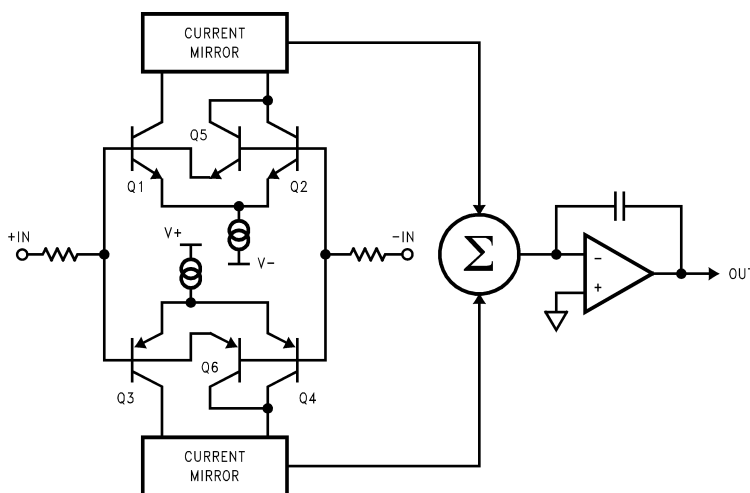

Figure 36.

If the input signal exceeds the slew rate of the input stage, the differential input voltage rises above two diode drops. This excess signal bypasses the normal input transistors, (Q1–Q4), and is routed in correct phase through the two additional transistors, (Q5, Q6), directly into the current mirrors.

This rerouting of excess signal allows the slew-rate to increase by a factor of 10 to 1 or more. (See Figure 37.)

As the overdrive increases, the op amp reacts better than a conventional op amp. Large fast pulses will raise the slew- rate to around 30V to 60V/μs.

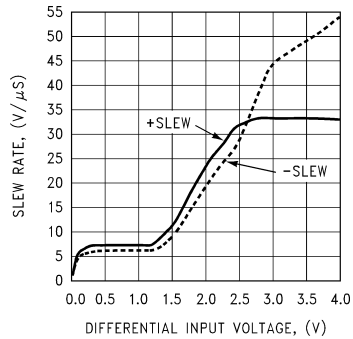

Figure 37. Slew Rate vs. ΔV_{IN}
 $V_S = \pm 5V$

This effect is most noticeable at higher supply voltages and lower gains where incoming signals are likely to be large.

This new input circuit also eliminates the phase reversal seen in many op amps when they are overdriven.

This speed-up action adds stability to the system when driving large capacitive loads.

DRIVING CAPACITIVE LOADS

Capacitive loads decrease the phase margin of all op amps. This is caused by the output resistance of the amplifier and the load capacitance forming an R-C phase lag network. This can lead to overshoot, ringing and oscillation. Slew rate limiting can also cause additional lag. Most op amps with a fixed maximum slew-rate will lag further and further behind when driving capacitive loads even though the differential input voltage raises. With the LM6142, the lag causes the slew rate to raise. The increased slew-rate keeps the output following the input much better. This effectively reduces phase lag. After the output has caught up with the input, the differential input voltage drops down and the amplifier settles rapidly.

These features allow the LM6142 to drive capacitive loads as large as 1000pF at unity gain and not oscillate. The scope photos (Figure 38 and Figure 39) above show the LM6142 driving a 1000pF load. In Figure 38, the upper trace is with no capacitive load and the lower trace is with a 1000pF load. Here we are operating on $\pm 12V$ supplies with a 20 V_{PP} pulse. Excellent response is obtained with a C_f of 10pF. In Figure 39, the supplies have been reduced to $\pm 2.5V$, the pulse is 4 V_{PP} and C_f is 39pF. The best value for the compensation capacitor is best established after the board layout is finished because the value is dependent on board stray capacity, the value of the feedback resistor, the closed loop gain and, to some extent, the supply voltage.

Another effect that is common to all op amps is the phase shift caused by the feedback resistor and the input capacitance. This phase shift also reduces phase margin. This effect is taken care of at the same time as the effect of the capacitive load when the capacitor is placed across the feedback resistor.

The circuit shown in Figure 40 was used for these scope photos.

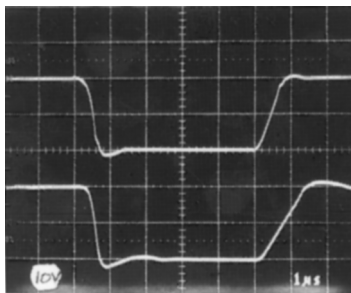

Figure 38.

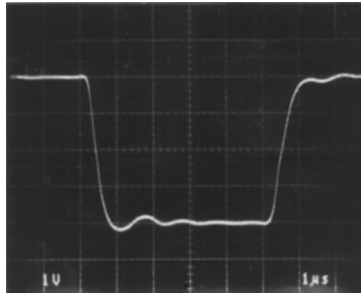

Figure 39.

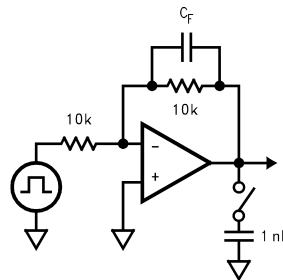

Figure 40.

Typical Applications

FISH FINDER/ DEPTH SOUNDER.

The LM6142/LM6144 is an excellent choice for battery operated fish finders. The low supply current, high gain-bandwidth and full rail to rail output swing of the LM6142 provides an ideal combination for use in this and similar applications.

ANALOG TO DIGITAL CONVERTER BUFFER

The high capacitive load driving ability, rail-to-rail input and output range with the excellent CMR of 82 dB, make the LM6142/LM6144 a good choice for buffering the inputs of A to D converters.

3 OP AMP INSTRUMENTATION AMP WITH RAIL-TO-RAIL INPUT AND OUTPUT

Using the LM6144, a 3 op amp instrumentation amplifier with rail-to-rail inputs and rail to rail output can be made. These features make these instrumentation amplifiers ideal for single supply systems.

Some manufacturers use a precision voltage divider array of 5 resistors to divide the common-mode voltage to get an input range of rail-to-rail or greater. The problem with this method is that it also divides the signal, so to even get unity gain, the amplifier must be run at high closed loop gains. This raises the noise and drift by the internal gain factor and lowers the input impedance. Any mismatch in these precision resistors reduces the CMR as well. Using the LM6144, all of these problems are eliminated.

In this example, amplifiers A and B act as buffers to the differential stage (Figure 41). These buffers assure that the input impedance is over 100M Ω and they eliminate the requirement for precision matched resistors in the input stage. They also assure that the difference amp is driven from a voltage source. This is necessary to maintain the CMR set by the matching of R1–R2 with R3–R4.

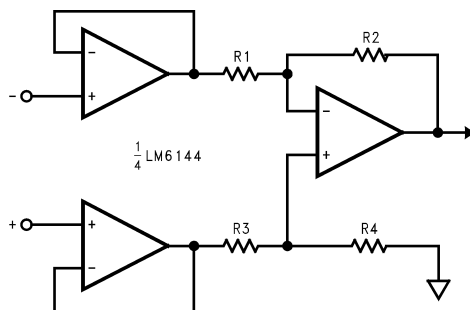
**Figure 41.**

The gain is set by the ratio of $R2/R1$ and $R3$ should equal $R1$ and $R4$ equal $R2$. Making $R4$ slightly smaller than $R2$ and adding a trim pot equal to twice the difference between $R2$ and $R4$ will allow the CMR to be adjusted for optimum.

With both rail to rail input and output ranges, the inputs and outputs are only limited by the supply voltages. Remember that even with rail-to-rail output, the output can not swing past the supplies so the combined common mode voltage plus the signal should not be greater than the supplies or limiting will occur.

SPICE MACROMODEL

A SPICE macromodel of this and many other Texas Instruments op amps is available http://www.ti.com/ww/en/analog/webench/index.shtml?DCMP=hpa_sva_webench&HQS=webench-bb.

REVISION HISTORY

Changes from Revision C (March 2013) to Revision D	Page
• Changed layout of National Data Sheet to TI format	16

PACKAGING INFORMATION

Orderable part number	Status (1)	Material type (2)	Package Pins	Package qty Carrier	RoHS (3)	Lead finish/ Ball material (4)	MSL rating/ Peak reflow (5)	Op temp (°C)	Part marking (6)
LM6142AIM/NOPB	Obsolete	Production	SOIC (D) 8	-	-	Call TI	Call TI	-40 to 85	LM614 2AIM
LM6142AIMX/NOPB	Active	Production	SOIC (D) 8	2500 LARGE T&R	Yes	SN	Level-1-260C-UNLIM	-40 to 85	LM614 2AIM
LM6142AIMX/NOPB.A	Active	Production	SOIC (D) 8	2500 LARGE T&R	Yes	SN	Level-1-260C-UNLIM	-40 to 85	LM614 2AIM
LM6142AIMX/NOPB.B	Active	Production	SOIC (D) 8	2500 LARGE T&R	Yes	SN	Level-1-260C-UNLIM	-40 to 85	LM614 2AIM
LM6142BIM/NOPB	Obsolete	Production	SOIC (D) 8	-	-	Call TI	Call TI	-40 to 85	LM614 2BIM
LM6142BIMX/NOPB	Active	Production	SOIC (D) 8	2500 LARGE T&R	Yes	SN	Level-1-260C-UNLIM	-40 to 85	LM614 2BIM
LM6142BIMX/NOPB.A	Active	Production	SOIC (D) 8	2500 LARGE T&R	Yes	SN	Level-1-260C-UNLIM	-40 to 85	LM614 2BIM
LM6142BIMX/NOPB.B	Active	Production	SOIC (D) 8	2500 LARGE T&R	Yes	SN	Level-1-260C-UNLIM	-40 to 85	LM614 2BIM
LM6142BIN/NOPB	Active	Production	PDIP (P) 8	40 TUBE	Yes	NIPDAU	Level-1-NA-UNLIM	-40 to 85	LM6142 BIN
LM6142BIN/NOPB.A	Active	Production	PDIP (P) 8	40 TUBE	Yes	NIPDAU	Level-1-NA-UNLIM	-40 to 85	LM6142 BIN
LM6142BIN/NOPB.B	Active	Production	PDIP (P) 8	40 TUBE	Yes	NIPDAU	Level-1-NA-UNLIM	-40 to 85	LM6142 BIN
LM6144AIM/NOPB	Obsolete	Production	SOIC (D) 14	-	-	Call TI	Call TI	-40 to 85	LM6144 AIM
LM6144AIMX/NOPB	Active	Production	SOIC (D) 14	2500 LARGE T&R	Yes	SN	Level-1-260C-UNLIM	-40 to 85	LM6144 AIM
LM6144AIMX/NOPB.A	Active	Production	SOIC (D) 14	2500 LARGE T&R	Yes	SN	Level-1-260C-UNLIM	-40 to 85	LM6144 AIM
LM6144AIMX/NOPB.B	Active	Production	SOIC (D) 14	2500 LARGE T&R	-	Call TI	Call TI	-40 to 85	
LM6144BIM/NOPB	Obsolete	Production	SOIC (D) 14	-	-	Call TI	Call TI	-40 to 85	LM6144 BIM
LM6144BIMX/NOPB	Active	Production	SOIC (D) 14	2500 LARGE T&R	Yes	SN	Level-1-260C-UNLIM	-40 to 85	LM6144 BIM

Orderable part number	Status (1)	Material type (2)	Package Pins	Package qty Carrier	RoHS (3)	Lead finish/ Ball material (4)	MSL rating/ Peak reflow (5)	Op temp (°C)	Part marking (6)
LM6144BIMX/NOPB.A	Active	Production	SOIC (D) 14	2500 LARGE T&R	Yes	SN	Level-1-260C-UNLIM	-40 to 85	LM6144 BIM
LM6144BIMX/NOPB.B	Active	Production	SOIC (D) 14	2500 LARGE T&R	-	Call TI	Call TI	-40 to 85	
LM6144BIN/NOPB	Active	Production	PDIP (N) 14	25 TUBE	Yes	NIPDAU	Level-1-NA-UNLIM	-40 to 85	LM6144BIN
LM6144BIN/NOPB.A	Active	Production	PDIP (N) 14	25 TUBE	Yes	NIPDAU	Level-1-NA-UNLIM	-40 to 85	LM6144BIN
LM6144BIN/NOPB.B	Active	Production	PDIP (N) 14	25 TUBE	-	Call TI	Call TI	-40 to 85	

(1) **Status:** For more details on status, see our [product life cycle](#).

(2) **Material type:** When designated, preproduction parts are prototypes/experimental devices, and are not yet approved or released for full production. Testing and final process, including without limitation quality assurance, reliability performance testing, and/or process qualification, may not yet be complete, and this item is subject to further changes or possible discontinuation. If available for ordering, purchases will be subject to an additional waiver at checkout, and are intended for early internal evaluation purposes only. These items are sold without warranties of any kind.

(3) **RoHS values:** Yes, No, RoHS Exempt. See the [TI RoHS Statement](#) for additional information and value definition.

(4) **Lead finish/Ball material:** Parts may have multiple material finish options. Finish options are separated by a vertical ruled line. Lead finish/Ball material values may wrap to two lines if the finish value exceeds the maximum column width.

(5) **MSL rating/Peak reflow:** The moisture sensitivity level ratings and peak solder (reflow) temperatures. In the event that a part has multiple moisture sensitivity ratings, only the lowest level per JEDEC standards is shown. Refer to the shipping label for the actual reflow temperature that will be used to mount the part to the printed circuit board.

(6) **Part marking:** There may be an additional marking, which relates to the logo, the lot trace code information, or the environmental category of the part.

Multiple part markings will be inside parentheses. Only one part marking contained in parentheses and separated by a "-" will appear on a part. If a line is indented then it is a continuation of the previous line and the two combined represent the entire part marking for that device.

Important Information and Disclaimer: The information provided on this page represents TI's knowledge and belief as of the date that it is provided. TI bases its knowledge and belief on information provided by third parties, and makes no representation or warranty as to the accuracy of such information. Efforts are underway to better integrate information from third parties. TI has taken and continues to take reasonable steps to provide representative and accurate information but may not have conducted destructive testing or chemical analysis on incoming materials and chemicals. TI and TI suppliers consider certain information to be proprietary, and thus CAS numbers and other limited information may not be available for release.

In no event shall TI's liability arising out of such information exceed the total purchase price of the TI part(s) at issue in this document sold by TI to Customer on an annual basis.

TAPE AND REEL INFORMATION

QUADRANT ASSIGNMENTS FOR PIN 1 ORIENTATION IN TAPE

*All dimensions are nominal

Device	Package Type	Package Drawing	Pins	SPQ	Reel Diameter (mm)	Reel Width W1 (mm)	A0 (mm)	B0 (mm)	K0 (mm)	P1 (mm)	W (mm)	Pin1 Quadrant
LM6142AIMX/NOPB	SOIC	D	8	2500	330.0	12.4	6.5	5.4	2.0	8.0	12.0	Q1
LM6142BIMX/NOPB	SOIC	D	8	2500	330.0	12.4	6.5	5.4	2.0	8.0	12.0	Q1
LM6144AIMX/NOPB	SOIC	D	14	2500	330.0	16.4	6.5	9.35	2.3	8.0	16.0	Q1
LM6144BIMX/NOPB	SOIC	D	14	2500	330.0	16.4	6.5	9.35	2.3	8.0	16.0	Q1

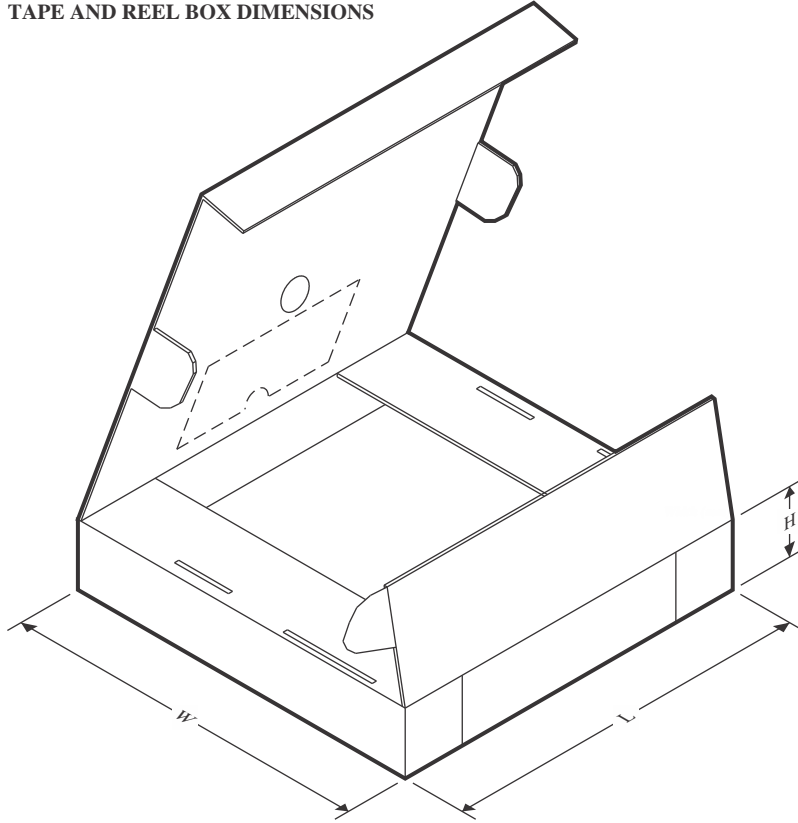
TAPE AND REEL BOX DIMENSIONS

*All dimensions are nominal

Device	Package Type	Package Drawing	Pins	SPQ	Length (mm)	Width (mm)	Height (mm)
LM6142AIMX/NOPB	SOIC	D	8	2500	367.0	367.0	35.0
LM6142BIMX/NOPB	SOIC	D	8	2500	367.0	367.0	35.0
LM6144AIMX/NOPB	SOIC	D	14	2500	367.0	367.0	35.0
LM6144BIMX/NOPB	SOIC	D	14	2500	367.0	367.0	35.0

TUBE

*All dimensions are nominal

Device	Package Name	Package Type	Pins	SPQ	L (mm)	W (mm)	T (μm)	B (mm)
LM6142BIN/NOPB	P	PDIP	8	40	502	14	11938	4.32
LM6142BIN/NOPB.A	P	PDIP	8	40	502	14	11938	4.32
LM6142BIN/NOPB.B	P	PDIP	8	40	502	14	11938	4.32
LM6144BIN/NOPB	N	PDIP	14	25	502	14	11938	4.32
LM6144BIN/NOPB.A	N	PDIP	14	25	502	14	11938	4.32

D0014A

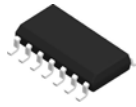

PACKAGE OUTLINE

SOIC - 1.75 mm max height

SMALL OUTLINE INTEGRATED CIRCUIT

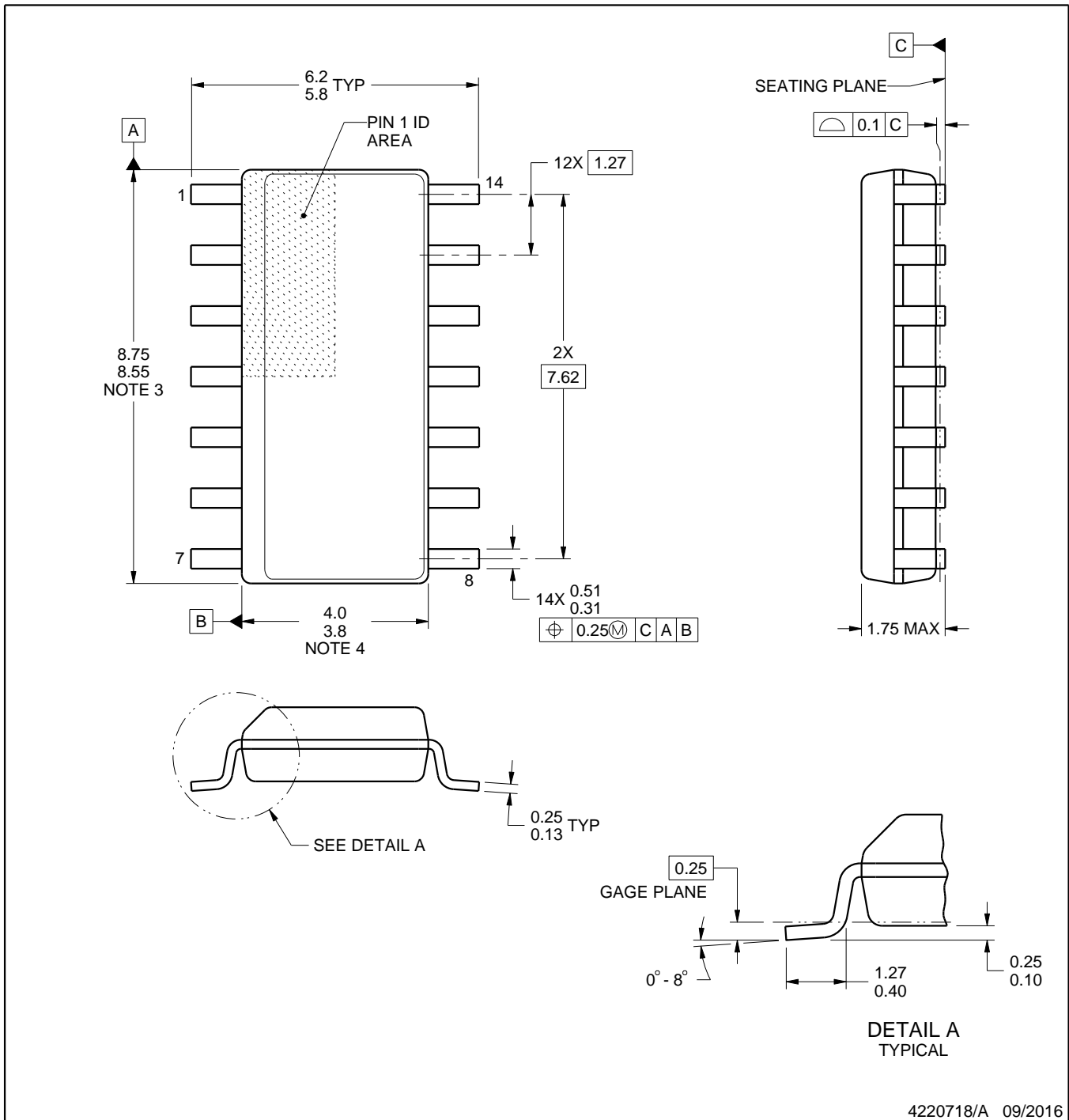

4220718/A 09/2016

NOTES:

- All linear dimensions are in millimeters. Dimensions in parenthesis are for reference only. Dimensioning and tolerancing per ASME Y14.5M.
- This drawing is subject to change without notice.
- This dimension does not include mold flash, protrusions, or gate burrs. Mold flash, protrusions, or gate burrs shall not exceed 0.15 mm, per side.
- This dimension does not include interlead flash. Interlead flash shall not exceed 0.43 mm, per side.
- Reference JEDEC registration MS-012, variation AB.

EXAMPLE BOARD LAYOUT

D0014A

SOIC - 1.75 mm max height

SMALL OUTLINE INTEGRATED CIRCUIT



LAND PATTERN EXAMPLE
SCALE:8X

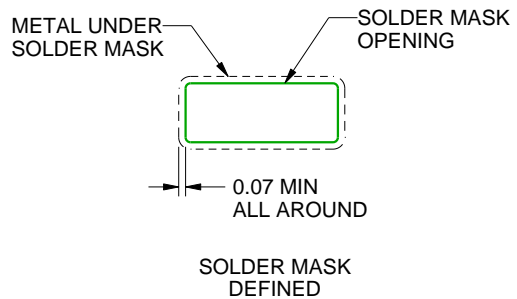
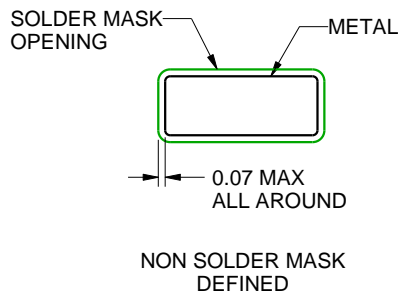

SOLDER MASK DETAILS

4220718/A 09/2016

NOTES: (continued)

6. Publication IPC-7351 may have alternate designs.
7. Solder mask tolerances between and around signal pads can vary based on board fabrication site.

EXAMPLE STENCIL DESIGN

D0014A

SOIC - 1.75 mm max height

SMALL OUTLINE INTEGRATED CIRCUIT



SOLDER PASTE EXAMPLE
BASED ON 0.125 mm THICK STENCIL
SCALE:8X

4220718/A 09/2016

NOTES: (continued)

8. Laser cutting apertures with trapezoidal walls and rounded corners may offer better paste release. IPC-7525 may have alternate design recommendations.
9. Board assembly site may have different recommendations for stencil design.



D0008A

PACKAGE OUTLINE

SOIC - 1.75 mm max height

SMALL OUTLINE INTEGRATED CIRCUIT

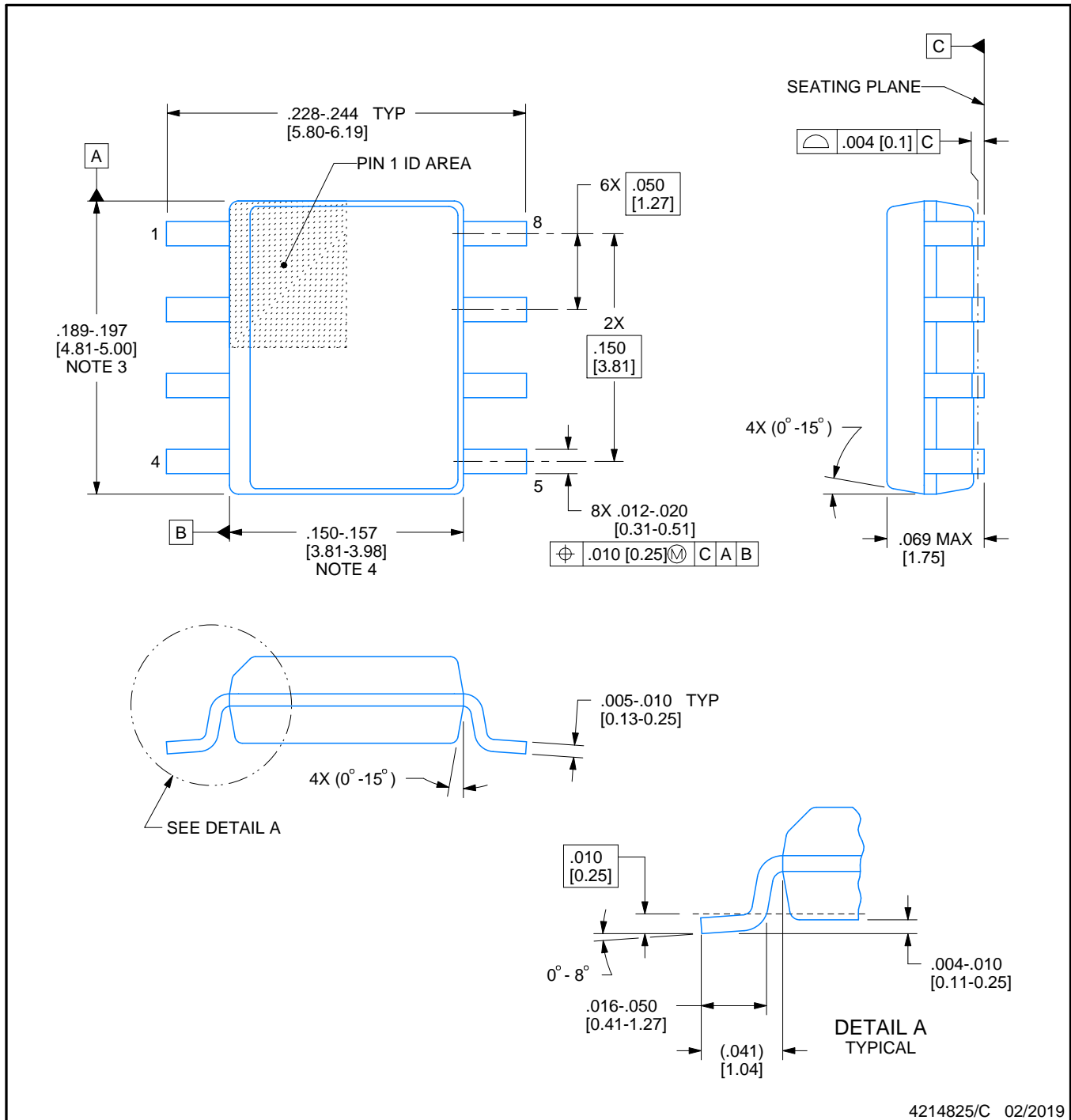

4214825/C 02/2019

NOTES:

- Linear dimensions are in inches [millimeters]. Dimensions in parenthesis are for reference only. Controlling dimensions are in inches. Dimensioning and tolerancing per ASME Y14.5M.
- This drawing is subject to change without notice.
- This dimension does not include mold flash, protrusions, or gate burrs. Mold flash, protrusions, or gate burrs shall not exceed .006 [0.15] per side.
- This dimension does not include interlead flash.
- Reference JEDEC registration MS-012, variation AA.

EXAMPLE BOARD LAYOUT

D0008A

SOIC - 1.75 mm max height

SMALL OUTLINE INTEGRATED CIRCUIT



LAND PATTERN EXAMPLE
EXPOSED METAL SHOWN
SCALE:8X



SOLDER MASK DETAILS

4214825/C 02/2019

NOTES: (continued)

6. Publication IPC-7351 may have alternate designs.

7. Solder mask tolerances between and around signal pads can vary based on board fabrication site.

EXAMPLE STENCIL DESIGN

D0008A

SOIC - 1.75 mm max height

SMALL OUTLINE INTEGRATED CIRCUIT



SOLDER PASTE EXAMPLE
BASED ON .005 INCH [0.125 MM] THICK STENCIL
SCALE:8X

4214825/C 02/2019

NOTES: (continued)

8. Laser cutting apertures with trapezoidal walls and rounded corners may offer better paste release. IPC-7525 may have alternate design recommendations.
9. Board assembly site may have different recommendations for stencil design.

P (R-PDIP-T8)

PLASTIC DUAL-IN-LINE PACKAGE



- NOTES:
- A. All linear dimensions are in inches (millimeters).
 - B. This drawing is subject to change without notice.
 - C. Falls within JEDEC MS-001 variation BA.

N (R-PDIP-T**)

PLASTIC DUAL-IN-LINE PACKAGE

16 PINS SHOWN



- NOTES:
- A. All linear dimensions are in inches (millimeters).
 - B. This drawing is subject to change without notice.
 - (C) Falls within JEDEC MS-001, except 18 and 20 pin minimum body length (Dim A).
 - (D) The 20 pin end lead shoulder width is a vendor option, either half or full width.

IMPORTANT NOTICE AND DISCLAIMER

TI PROVIDES TECHNICAL AND RELIABILITY DATA (INCLUDING DATASHEETS), DESIGN RESOURCES (INCLUDING REFERENCE DESIGNS), APPLICATION OR OTHER DESIGN ADVICE, WEB TOOLS, SAFETY INFORMATION, AND OTHER RESOURCES "AS IS" AND WITH ALL FAULTS, AND DISCLAIMS ALL WARRANTIES, EXPRESS AND IMPLIED, INCLUDING WITHOUT LIMITATION ANY IMPLIED WARRANTIES OF MERCHANTABILITY, FITNESS FOR A PARTICULAR PURPOSE OR NON-INFRINGEMENT OF THIRD PARTY INTELLECTUAL PROPERTY RIGHTS.

These resources are intended for skilled developers designing with TI products. You are solely responsible for (1) selecting the appropriate TI products for your application, (2) designing, validating and testing your application, and (3) ensuring your application meets applicable standards, and any other safety, security, regulatory or other requirements.

These resources are subject to change without notice. TI grants you permission to use these resources only for development of an application that uses the TI products described in the resource. Other reproduction and display of these resources is prohibited. No license is granted to any other TI intellectual property right or to any third party intellectual property right. TI disclaims responsibility for, and you fully indemnify TI and its representatives against any claims, damages, costs, losses, and liabilities arising out of your use of these resources.

TI's products are provided subject to [TI's Terms of Sale](#), [TI's General Quality Guidelines](#), or other applicable terms available either on ti.com or provided in conjunction with such TI products. TI's provision of these resources does not expand or otherwise alter TI's applicable warranties or warranty disclaimers for TI products. Unless TI explicitly designates a product as custom or customer-specified, TI products are standard, catalog, general purpose devices.

TI objects to and rejects any additional or different terms you may propose.

Copyright © 2025, Texas Instruments Incorporated

Last updated 10/2025