

LM339B、LM2901B、LM339、LM239、LM139、LM2901 四路差分比较器

1 特性

- 全新 **LM339B** 和 **LM2901B**
- 改进了 B 版本的规格
 - 最大额定值：高达 38V
 - ESD 等级 (HBM)：2kV
 - 低输入失调电压：0.37mV
 - 低输入偏置电流：3.5nA
 - 低电源电流：每个比较器 200 μ A
 - 更短的响应时间 (1 μ s)
 - **LM339B** 的工作温度范围
- B 版本可直接取代 LM239、LM339 和 LM2901 的 A 和 V 版本
- 共模输入电压范围包括接地
- 差分输入电压范围等于最大额定电源电压： $\pm 38V$
- 低输出饱和电压
- 输出与 TTL、MOS 和 CMOS 兼容
- 对于单通道版本，请参阅 **TL331B**
- 对于双通道版本，请参阅 **LM393B** 或 **LM2903B**

2 应用

- 扫地机器人
- 单相 UPS
- 服务器 PSU
- 无绳电动工具
- 无线基础设施
- 电器
- 楼宇自动化
- 工厂自动化与控制
- 电机驱动器
- 信息娱乐系统与仪表组

3 说明

LM339B 和 **LM2901B** 器件是业界通用 **LM339** 和 **LM2901** 比较器系列的下一代版本。下一代 B 版本比较器具有更低的失调电压、更高的电源电压能力、更低的电源电流、更低的输入偏置电流和更低的传播延迟，并通过专用 ESD 钳位提高了 2kV ESD 性能和输入耐用性。**LM339B** 和 **LM2901B** 可直接替代 **LM239**、**LM339** 和 **LM2901** (“A” 和 “V” 版本)。

所有器件都包含四个独立的电压比较器，这些比较器可在宽电压范围内由单电源供电运行。静态电流不受电源电压的影响。

器件信息

| 器件型号 | 封装 ⁽¹⁾ | 本体尺寸 (标称值) |
|---|-------------------|------------------|
| LM139x、LM239x、 LM339x、LM2901x、 LM339B、LM2901B | SOIC (14) | 8.70mm × 3.90mm |
| LM239、LM339x、LM2901 | PDIP (14) | 19.30mm × 6.40mm |
| LM239、LM2901、 LM339B、LM2901B | TSSOP (14) | 5.00mm × 4.40mm |
| LM339x、LM2901 | SOP (14) | 10.20mm × 5.30mm |
| LM339x、LM2901 | SSOP (14) | 6.50mm × 5.30mm |
| LM2901B | SOT-23 (14) | 4.20mm × 2.00mm |
| LM339B、LM2901B | WQFN (16) | 3.00mm × 3.00mm |

(1) 如需了解所有可用封装，请参阅数据表末尾的可订购产品附录。

系列比较表

| 规格 | LM339B | LM2901B | LM339 LM339A | LM2901 LM2901A | LM2901V LM2901AV | LM139 LM139A | LM239 LM239A | 单位 |
|-------------------------|-----------|-----------|--------------------|---------------------|---------------------|--------------------|--------------------|-----------|
| 电源电压 | 2 至 36 | 2 至 36 | 2 至 30 | 2 至 30 | 2 至 32 | 2 至 30 | 2 至 30 | V |
| 总电源电流 (5V 至 36V 最大值) | 0.8 至 1 | 0.8 至 1 | 1 至 2.5 | 1 至 2.5 | 1 至 2.5 | 1 至 2.5 | 1 至 2.5 | mA |
| 温度范围 | -40 至 85 | -40 至 125 | 0 至 70 | -40 至 125 | -40 至 125 | -55 至 125 | -25 至 85 | °C |
| ESD (HBM) | 2000 | 2000 | 2000 | 2000 | 2000 | 2000 | 2000 | V |
| 失调电压 (整个温度范围内的最大值) | ± 5.5 | ± 5.5 | ± 9 ± 4 | ± 15 ± 4 | ± 15 ± 4 | ± 9 ± 4 | ± 9 ± 4 | mV |
| 输入偏置电流 (典型值/最大值) | 3.5/25 | 3.5/25 | 25/250 | 25/250 | 25/250 | 25/100 | 25/250 | nA |
| 响应时间 (典型值) | 1 | 1 | 1.3 | 1.3 | 1.3 | 1.3 | 1.3 | μ sec |



Table of Contents

| | | | |
|--|----|--|----|
| 1 特性 | 1 | 6.14 Switching Characteristics for LMx39 and LMx39A.. | 12 |
| 2 应用 | 1 | 6.15 Switching Characteristics for LM2901..... | 12 |
| 3 说明 | 1 | 6.16 Typical Characteristics..... | 13 |
| 4 Other Versions | 3 | 7 Detailed Description | 19 |
| 5 Pin Configuration and Functions | 4 | 7.1 Overview..... | 19 |
| 6 Specifications | 5 | 7.2 Functional Block Diagram..... | 19 |
| 6.1 Absolute Maximum Ratings for LM339B and LM2901B | 5 | 7.3 Feature Description..... | 19 |
| 6.2 Absolute Maximum Ratings for Non-B Versions..... | 5 | 7.4 Device Functional Modes..... | 19 |
| 6.3 ESD Ratings..... | 6 | 8 Application and Implementation | 20 |
| 6.4 Recommended Operating Conditions for LM339B and LM2901B | 6 | 8.1 Application Information..... | 20 |
| 6.5 Recommended Operating Conditions, Non-B Versions..... | 6 | 8.2 Typical Application..... | 20 |
| 6.6 Thermal Information..... | 6 | 8.3 Power Supply Recommendations..... | 22 |
| 6.7 Electrical Characteristics for LM339B..... | 7 | 8.4 Layout..... | 22 |
| 6.8 Electrical Characteristics for LM2901B | 8 | 9 Device and Documentation Support | 23 |
| 6.9 Electrical Characteristics for LM139 and LM139A..... | 9 | 9.1 Related Links..... | 23 |
| 6.10 Electrical Characteristics for LMx39 and LMx39A.. | 10 | 9.2 Receiving Notification of Documentation Updates.... | 23 |
| 6.11 Electrical Characteristics for LM2901, LM2901V and LM2901AV..... | 11 | 9.3 支持资源..... | 23 |
| 6.12 Switching Characteristics for LM139 and LM139A..... | 12 | 9.4 Trademarks..... | 23 |
| 6.13 Switching Characteristics for LM339B and LM2901B | 12 | 9.5 静电放电警告..... | 23 |
| | | 9.6 术语表..... | 23 |
| | | 10 Revision History | 24 |
| | | 11 Mechanical, Packaging, and Orderable Information | 26 |

4 Other Versions

OTHER QUALIFIED VERSIONS OF LM139-SP, LM239A, LM2901, LM2901AV, LM2901V:

- Automotive Q100: [LM239A-Q1](#), [LM2901B-Q1](#), [LM2901-Q1](#), [LM2901AV-Q1](#), [LM2901V-Q1](#)
- Enhanced Product: [LM239A-EP](#)
- Space: [LM139-SP](#)

5 Pin Configuration and Functions



图 5-1. D, DB, N, NS, PW Packages
 14-Pin SOIC, SSOP, PDIP, SOP, TSSOP
 Top View



NOTE: Connect exposed thermal pad directly to GND pin.

图 5-2. RTE Package
 16-Pad WQFN With Exposed Thermal Pad
 Top View

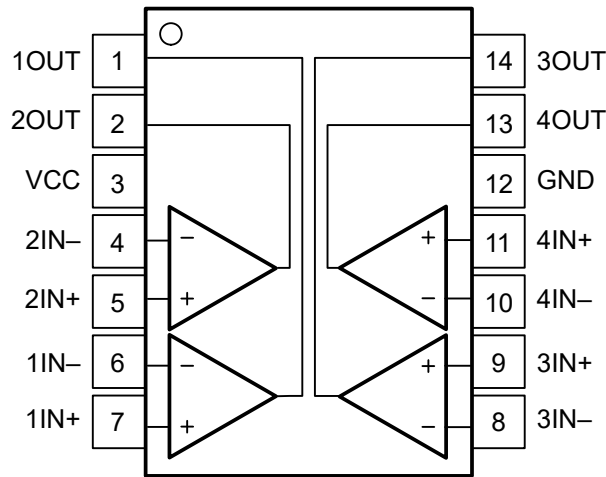
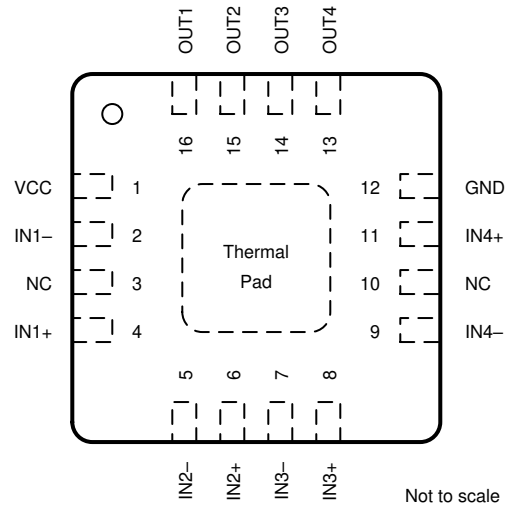
表 5-1. Pin Functions

| NAME ⁽¹⁾ | PIN | | I/O | DESCRIPTION |
|----------------------|--------------------------|------|--------|--|
| | D, DB, N, NS, PW, DYY, J | WQFN | | |
| OUT1 ⁽¹⁾ | 1 | 16 | Output | Output pin of the comparator 2 |
| OUT2 ⁽¹⁾ | 2 | 15 | Output | Output pin of the comparator 1 |
| V _{CC} | 3 | 1 | — | Positive supply |
| IN2 ⁻ (1) | 4 | 5 | Input | Negative input pin of the comparator 1 |
| IN2 ⁺ (1) | 5 | 6 | Input | Positive input pin of the comparator 1 |
| IN1 ⁻ (1) | 6 | 2 | Input | Negative input pin of the comparator 2 |
| IN1 ⁺ (1) | 7 | 4 | Input | Positive input pin of the comparator 2 |
| IN3 ⁻ | 8 | 7 | Input | Negative input pin of the comparator 3 |
| IN3 ⁺ | 9 | 8 | Input | Positive input pin of the comparator 3 |
| IN4 ⁻ | 10 | 9 | Input | Negative input pin of the comparator 4 |
| IN4 ⁺ | 11 | 11 | Input | Positive input pin of the comparator 4 |
| GND | 12 | 12 | — | Negative supply |
| OUT4 | 13 | 13 | Output | Output pin of the comparator 4 |
| OUT3 | 14 | 14 | Output | Output pin of the comparator 3 |
| NC | — | 3 | — | No Internal Connection - Leave floating or GND |
| NC | — | 10 | — | No Internal Connection - Leave floating or GND |
| Thermal Pad | — | PAD | — | Connect directly to GND pin |

(1) Some manufacturers transpose the names of channels 1 & 2. Electrically the pinouts are identical, just a difference in the channel naming convention.

6 Specifications

6.1 Absolute Maximum Ratings for LM339B and LM2901B

over operating free-air temperature range (unless otherwise noted)⁽¹⁾

| | MIN | MAX | UNIT |
|---|------|-----------|------|
| Supply voltage: $V_S = (V+) - (V-)$ | -0.3 | 38 | V |
| Differential input voltage: V_{ID} ⁽²⁾ | | ±38 | V |
| Input pins (IN+, IN-) | -0.3 | 38 | V |
| Current into input pins (IN+, IN-) | | -50 | mA |
| Output pin (OUT) | -0.3 | 38 | V |
| Output sink current | | 25 | mA |
| Output short-circuit duration ⁽³⁾ | | Unlimited | s |
| Junction temperature, T_J | | 150 | °C |
| Storage temperature, T_{stg} | -65 | 150 | °C |

- (1) Stresses beyond those listed under *Absolute Maximum Ratings* can cause permanent damage to the device. These are stress ratings only, which do not imply functional operation of the device at these or any other conditions beyond those indicated under *Recommended Operating Conditions*. Exposure to absolute-maximum-rated conditions for extended periods can affect device reliability.
- (2) Differential voltages are at IN+ with respect to IN-
- (3) Short circuits from outputs to V+ can cause excessive heating and eventual destruction.

6.2 Absolute Maximum Ratings for Non-B Versions

over operating free-air temperature range (unless otherwise noted)⁽¹⁾

| | MIN | MAX | UNIT |
|---|------|------------|--------|
| V_{CC} Supply voltage ⁽²⁾ | | 36 | V |
| V_{ID} Differential input voltage ⁽³⁾ | | ±36 | V |
| V_I Input voltage range (either input) | -0.3 | 36 | V |
| I_K Input current ⁽⁵⁾ | | -50 | mA |
| V_O Output voltage | | 36 | V |
| I_O Output current | | 20 | mA |
| Duration of output short circuit to ground ⁽⁴⁾ | | Unlimited | |
| T_J Operating virtual-junction temperature | | 150 | °C |
| Case temperature for 60s | | FK package | 260 °C |
| Lead temperature 1.6mm (1/16in) from case for 60s | | J package | 300 °C |
| T_{stg} Storage temperature | -65 | 150 | °C |

- (1) Stresses beyond those listed under *Absolute Maximum Ratings* can cause permanent damage to the device. These are stress ratings only, and functional operation of the device at these or any other conditions beyond those indicated under *Recommended Operating Conditions* is not implied. Exposure to absolute-maximum-rated conditions for extended periods can affect device reliability.
- (2) All voltage values, except differential voltages, are with respect to network ground.
- (3) Differential voltages are at xIN+ with respect to xIN-.
- (4) Short circuits from outputs to V_{CC} can cause excessive heating and eventual destruction.
- (5) Input current flows through parasitic diode to ground and can turn on parasitic transistors that can increase I_{CC} and can cause output to be incorrect. Normal operation resumes when the input is removed.

6.3 ESD Ratings

| | | VALUE | UNIT |
|--------------------|-------------------------|---|-------|
| V _(ESD) | Electrostatic discharge | Human-body model (HBM), per ANSI/ESDA/JEDEC JS-001 ⁽¹⁾ | ±2000 |
| | | Human-body model (CDM), per ANSI/ESDA/JEDEC JS-002 ⁽²⁾ | ±1000 |

- (1) JEDEC document JEP155 states that 500V HBM allows safe manufacturing with a standard ESD control process
 (2) JEDEC document JEP157 states that 250V CDM allows safe manufacturing with a standard ESD control process

6.4 Recommended Operating Conditions for LM339B and LM2901B

over operating free-air temperature range (unless otherwise noted)

| | MIN | MAX | UNIT |
|---|------------|------------|------|
| Supply voltage: V _S = (V+) - (V-) | 2 | 36 | V |
| Ambient temperature, T _A , LM339B | - 40 | 85 | °C |
| Ambient temperature, T _A , LM2901B | - 40 | 125 | °C |
| Input Voltage Range, V _{IVR} | (V-) - 0.1 | (V+) - 2.0 | V |

6.5 Recommended Operating Conditions, Non-B Versions

over operating free-air temperature range (unless otherwise noted)

| | | MIN | MAX | UNIT | |
|-----------------|----------------------|---------------|------|------|----|
| V _{CC} | Supply voltage | Non-V devices | 2 | 30 | V |
| | | V devices | 2 | 32 | V |
| T _J | Junction temperature | LM139x | - 55 | 125 | °C |
| | | LM239x | - 25 | 85 | |
| | | LM339x | - 0 | 70 | |
| | | LM2901x | - 40 | 125 | |

6.6 Thermal Information

| THERMAL METRIC ⁽¹⁾ | | All Devices | | | | | | UNIT |
|-------------------------------|--|-------------|-------------|---------------|--------------|-------------|--------------|------|
| | | N (PDIP) | D (SOIC) | PW (TSSOP) | DB (SSOP) | NS (SOP) | RTE (QFN) | |
| | | 14 PINS | 14 PINS | 14 PINS | 14 PINS | 14 PINS | 16 PINS | |
| R _{θJA} | Junction-to-ambient thermal resistance | 114.9 | 111.2 | 136.6 | 111.8 | 96.2 | 67.6 | °C/W |
| R _{θJC(top)} | Junction-to-case (top) thermal resistance | 93.8 | 66.9 | 66.6 | 63.6 | 56.1 | 72.3 | °C/W |
| R _{θJB} | Junction-to-board thermal resistance | 77.7 | 67.8 | 79.8 | 60.5 | 56.9 | 43.1 | °C/W |
| ψ _{JT} | Junction-to-top characterization parameter | 60.4 | 28.0 | 17.8 | 26.2 | 24.8 | 6.3 | °C/W |
| ψ _{JB} | Junction-to-board characterization parameter | 76.7 | 67.4 | 79.3 | 58.5 | 56.4 | 42.8 | °C/W |
| R _{θJC(bot)} | Junction-to-case (bottom) thermal resistance | - | - | - | - | - | 26.4 | °C/W |

- (1) For more information about traditional and new thermal metrics, see the Semiconductor and IC Package Thermal Metrics report, [SPRA953](#).

6.7 Electrical Characteristics for LM339B

$V_S = 5V$, $V_{CM} = (V^-)$; $T_A = 25^\circ C$ (unless otherwise noted).

| PARAMETER | | TEST CONDITIONS | MIN | TYP | MAX | UNIT |
|--------------|---|--|---------|------------|---------------|------|
| V_{IO} | Input offset voltage | $V_S = 5$ to $36V$ | - 3.5 | ± 0.37 | 3.5 | mV |
| | | $V_S = 5$ to $36V$, $T_A = -40^\circ C$ to $+85^\circ C$ | - 5.5 | | 5.5 | |
| I_B | Input bias current | | | - 3.5 | - 25 | nA |
| | | $T_A = -40^\circ C$ to $+85^\circ C$ | | | - 50 | nA |
| I_{OS} | Input offset current | | - 25 | ± 0.5 | 25 | nA |
| | | $T_A = -40^\circ C$ to $+85^\circ C$ | - 50 | | 50 | nA |
| V_{CM} | Common mode range ⁽¹⁾ | $V_S = 3$ to $36V$ | (V^-) | | $(V^+) - 1.5$ | V |
| | | $V_S = 3$ to $36V$, $T_A = -40^\circ C$ to $+85^\circ C$ | (V^-) | | $(V^+) - 2.0$ | V |
| A_{VD} | Large signal differential voltage amplification | $V_S = 15V$, $V_O = 1.4V$ to $11.4V$; $R_L \geq 15k$ to (V^+) | 50 | 200 | | V/mV |
| V_{OL} | Low level output Voltage {swing from (V^-) } | $I_{SINK} \leq 4mA$, $V_{ID} = -1V$ | | 110 | 400 | mV |
| | | $I_{SINK} \leq 4mA$, $V_{ID} = -1V$ $T_A = -40^\circ C$ to $+85^\circ C$ | | | 550 | mV |
| I_{OH-LKG} | High-level output leakage current | $(V^+) = V_O = 5V$; $V_{ID} = 1V$ | | 0.1 | 50 | nA |
| | | $(V^+) = V_O = 36V$; $V_{ID} = 1V$ | | | 100 | nA |
| I_{OL} | Low level output current | $V_{OL} = 1.5V$; $V_{ID} = -1V$; $V_S = 5V$ | 6 | 21 | | mA |
| I_Q | Quiescent current (all comparators) | $V_S = 5V$, no load | | 0.8 | 1.2 | mA |
| | | $V_S = 36V$, no load, $T_A = -40^\circ C$ to $+85^\circ C$ | | 1 | 1.6 | mA |

- (1) When the voltage at either input goes negative by more than 0.3V, the output can be incorrect and excessive input current can flow. The upper end of the common-mode voltage range is limited by $V_{CC} - 2V$. However only one input needs to be in the valid common mode range, the other input can go up the maximum V_{CC} level and the comparator provides a proper output state. Either or both inputs can go to maximum V_{CC} level without damage.

6.8 Electrical Characteristics for LM2901B

$V_S = 5V$, $V_{CM} = (V -)$; $T_A = 25^\circ C$ (unless otherwise noted).

| PARAMETER | | TEST CONDITIONS | MIN | TYP | MAX | UNIT |
|--------------|---|---|-------|------------|------------|------|
| V_{IO} | Input offset voltage | $V_S = 5$ to $36V$ | - 3.5 | ± 0.37 | 3.5 | mV |
| | | $V_S = 5$ to $36V$, $T_A = -40^\circ C$ to $+125^\circ C$ | - 5.5 | | 5.5 | |
| I_B | Input bias current | | | - 3.5 | - 25 | nA |
| | | $T_A = -40^\circ C$ to $+125^\circ C$ | | | - 50 | nA |
| I_{OS} | Input offset current | | - 25 | ± 0.5 | 25 | nA |
| | | $T_A = -40^\circ C$ to $+125^\circ C$ | - 50 | | 50 | nA |
| V_{CM} | Common mode range ⁽¹⁾ | $V_S = 3$ to $36V$ | (V -) | | (V+) - 1.5 | V |
| | | $V_S = 3$ to $36V$, $T_A = -40^\circ C$ to $+125^\circ C$ | (V -) | | (V+) - 2.0 | V |
| A_{VD} | Large signal differential voltage amplification | $V_S = 15V$, $V_O = 1.4V$ to $11.4V$; $R_L \geq 15k$ to (V+) | 50 | 200 | | V/mV |
| V_{OL} | Low level output Voltage {swing from (V -)} | $I_{SINK} \leq 4mA$, $V_{ID} = -1V$ | | 110 | 400 | mV |
| | | $I_{SINK} \leq 4mA$, $V_{ID} = -1V$ $T_A = -40^\circ C$ to $+125^\circ C$ | | | 550 | mV |
| I_{OH-LKG} | High-level output leakage current | (V+) = $V_O = 5V$; $V_{ID} = 1V$ | | 0.1 | 50 | nA |
| | | (V+) = $V_O = 36V$; $V_{ID} = 1V$ | | | 100 | nA |
| I_{OL} | Low level output current | $V_{OL} = 1.5V$; $V_{ID} = -1V$; $V_S = 5V$ | 6 | 21 | | mA |
| I_Q | Quiescent current (all comparators) | $V_S = 5V$, no load | | 0.8 | 1.2 | mA |
| | | $V_S = 36V$, no load, $T_A = -40^\circ C$ to $+125^\circ C$ | | 1 | 1.6 | mA |

- (1) When the voltage at either input goes negative by more than 0.3V, the output can be incorrect and excessive input current can flow. The upper end of the common-mode voltage range is limited by $V_{CC} - 2V$. However only one input needs to be in the valid common mode range, the other input can go up the maximum V_{CC} level and the comparator provides a proper output state. Either or both inputs can go to maximum V_{CC} level without damage.

6.9 Electrical Characteristics for LM139 and LM139A

at specified free-air temperature, $V_{CC} = 5V$ (unless otherwise noted)

| PARAMETER | TEST CONDITIONS ⁽¹⁾ | T_A ⁽²⁾ | LM139 | | | LM139A | | | UNIT |
|--|---|----------------------|----------------|------|-----|----------------|------|---------|------|
| | | | MIN | TYP | MAX | MIN | TYP | MAX | |
| V_{IO} Input offset voltage | $V_{CC} = 5V$ to $30V$, $V_{IC} = V_{ICR}$ min, $V_O = 1.4V$ | 25°C | | 2 | 5 | | 1 | 2 | mV |
| | | Full range | | | 9 | | | 4 | |
| I_{IO} Input offset current | $V_O = 1.4V$ | 25°C | | 3 | 25 | | 3 | 25 | nA |
| | | Full range | | | 100 | | | 100 | |
| I_{IB} Input bias current | $V_O = 1.4V$ | 25°C | | - 25 | - | | - 25 | - 100 | nA |
| | | Full range | | | 300 | | | - 300 | |
| V_{ICR} Common-mode input-voltage range ⁽³⁾ | | 25°C | $V_{CC} - 1.5$ | 0 to | | $V_{CC} - 1.5$ | 0 to | | V |
| | | Full range | $V_{CC} - 2$ | 0 to | | $V_{CC} - 2$ | 0 to | | |
| A_{VD} Large-signal differential-voltage amplification | $V_{CC+} = \pm 7.5V$, $V_O = -5V$ to $5V$ | 25°C | | 200 | | 50 | 200 | V/mV | |
| I_{OH} High-level output current | $V_{ID} = 1V$ | $V_{OH} = 5V$ | 25°C | | 0.1 | | 0.1 | nA | |
| | | $V_{OH} = 30V$ | Full range | | 1 | | 1 | μA | |
| V_{OL} Low-level output voltage | $V_{ID} = -1V$, $I_{OL} = 4mA$ | 25°C | | 150 | 400 | | 150 | 400 | mV |
| | | Full range | | | 700 | | | 700 | |
| I_{OL} Low-level output current | $V_{ID} = -1V$, $V_{OL} = 1.5V$ | 25°C | | 6 | 16 | | 6 | 16 | mA |
| I_{CC} Supply current (four comparators) | $V_O = 2.5V$, No load | 25°C | | 0.8 | 2 | | 0.8 | 2 | mA |

- (1) All characteristics are measured with zero common-mode input voltage, unless otherwise specified.
- (2) Full range (MIN to MAX) for LM139 and LM139A is $-55^\circ C$ to $+125^\circ C$. All characteristics are measured with zero common-mode input voltage, unless otherwise specified.
- (3) The voltage at either input or common-mode must not be allowed to go negative by more than 0.3V. The upper end of the common-mode voltage range is $V_{CC+} - 1.5V$; however, one input can exceed V_{CC} , and the comparator provides a proper output state as long as the other input remains in the common-mode range. Either or both inputs can go to 30V without damage.

6.10 Electrical Characteristics for LMx39 and LMx39A

at specified free-air temperature, $V_{CC} = 5V$ (unless otherwise noted)

| PARAMETER | TEST CONDITIONS ⁽¹⁾ | T_A ⁽²⁾ | LM239 LM339 | | | LM239A LM339A | | | UNIT | |
|--|---|----------------------|----------------|---------------------------|-----|------------------|---------------------------|-------|------|---------|
| | | | MIN | TYP | MAX | MIN | TYP | MAX | | |
| V_{IO} Input offset voltage | $V_{CC} = 5V$ to $30V$, $V_{IC} = V_{ICR}$ min, $V_O = 1.4V$ | 25°C | | 2 | 5 | | 1 | 3 | mV | |
| | | Full range | | | 9 | | | 4 | | |
| I_{IO} Input offset current | $V_O = 1.4V$ | 25°C | | 5 | 50 | | 5 | 50 | nA | |
| | | Full range | | | 150 | | | 150 | | |
| I_{IB} Input bias current | $V_O = 1.4V$ | 25°C | | - 25 | - | | - 25 | - 250 | nA | |
| | | Full range | | | 400 | | | - 400 | | |
| V_{ICR} Common-mode input-voltage range ⁽³⁾ | | 25°C | | 0 to $V_{CC} -$ 1.5 | | | 0 to $V_{CC} -$ 1.5 | | V | |
| | | Full range | | 0 to $V_{CC} -$ 2 | | | 0 to $V_{CC} -$ 2 | | | |
| A_{VD} Large-signal differential-voltage amplification | $V_{CC} = 15V$, $V_O = 1.4V$ to $11.4V$, $R_L \geq 15k\Omega$ to V_{CC} | 25°C | | 50 | 200 | | 50 | 200 | V/mV | |
| I_{OH} High-level output current | $V_{ID} = 1V$ | $V_{OH} = 5V$ | 25°C | | 0.1 | 50 | | 0.1 | 50 | nA |
| | | $V_{OH} = 30V$ | Full range | | | 1 | | | 1 | μA |
| V_{OL} Low-level output voltage | $V_{ID} = -1V$, $I_{OL} = 4mA$ | 25°C | | 150 | 400 | | 150 | 400 | mV | |
| | | Full range | | | 700 | | | 700 | | |
| I_{OL} Low-level output current | $V_{ID} = -1V$, $V_{OL} = 1.5V$ | 25°C | | 6 | 16 | | 6 | 16 | mA | |
| I_{CC} Supply current (four comparators) | $V_O = 2.5V$, No load | 25°C | | 0.8 | 2 | | 0.8 | 2 | mA | |

- (1) All characteristics are measured with zero common-mode input voltage, unless otherwise specified.
- (2) Full range (MIN to MAX) for LM239/LM239A is $-25^\circ C$ to $+85^\circ C$, and for LM339/LM339A is $0^\circ C$ to $70^\circ C$. All characteristics are measured with zero common-mode input voltage, unless otherwise specified.
- (3) The voltage at either input or common-mode must not be allowed to go negative by more than 0.3V. The upper end of the common-mode voltage range is $V_{CC+} - 1.5V$; however, one input can exceed V_{CC} , and the comparator provides a proper output state as long as the other input remains in the common-mode range. Either or both inputs can go to 30V without damage.

6.11 Electrical Characteristics for LM2901, LM2901V and LM2901AV

at specified free-air temperature, $V_{CC} = 5V$ (unless otherwise noted)

| PARAMETER | TEST CONDITIONS ⁽¹⁾ | | T_A ⁽²⁾ | LM2901 | | | UNIT |
|--|--|-------------------------------------|----------------------|------------------------|-------|---------|------|
| | | | | MIN | TYP | MAX | |
| V_{IO} Input offset voltage | $V_{IC} = V_{ICR} \text{ min,}$ $V_O = 1.4V,$ $V_{CC} = 5V \text{ to MAX}^{(3)}$ | Non-A devices | 25°C | 2 | 7 | mV | |
| | | | Full range | | 15 | | |
| | | A-suffix devices | 25°C | 1 | 2 | | |
| | | | Full range | | 4 | | |
| I_{IO} Input offset current | $V_O = 1.4V$ | | 25°C | 5 | 50 | nA | |
| | | | Full range | | 200 | | |
| I_{IB} Input bias current | $V_O = 1.4V$ | | 25°C | - 25 | - 250 | nA | |
| | | | Full range | | - 500 | | |
| V_{ICR} Common-mode input-voltage range ⁽⁴⁾ | | | 25°C | 0 to $V_{CC} - 1.5$ | | V | |
| | | | Full range | 0 to $V_{CC} - 2$ | | | |
| A_{VD} Large-signal differential-voltage amplification | $V_{CC} = 15V, V_O = 1.4V \text{ to } 11.4V,$ $R_L \geq 15k\Omega \text{ to } V_{CC}$ | | 25°C | 25 | 100 | V/mV | |
| I_{OH} High-level output current | $V_{ID} = 1V$ | $V_{OH} = 5V$ | 25°C | 0.1 | 50 | nA | |
| | | $V_{OH} = V_{CC} \text{ MAX}^{(3)}$ | Full range | | 1 | μA | |
| V_{OL} Low-level output voltage | $V_{ID} = - 1V,$ $I_{OL} = 4mA$ | Non-V devices | 25°C | 150 | 500 | mV | |
| | | V-suffix devices | | 150 | 400 | | |
| | | All devices | Full range | | 700 | | |
| I_{OL} Low-level output current | $V_{ID} = - 1V,$ | $V_{OL} = 1.5V$ | 25°C | 6 | 16 | mA | |
| I_{CC} Supply current (four comparators) | $V_O = 2.5V,$ No load | $V_{CC} = 5V$ | 25°C | 0.8 | 2 | mA | |
| | | $V_{CC} = \text{MAX}^{(3)}$ | | 1 | 2.5 | | |

- (1) All characteristics are measured with zero common-mode input voltage, unless otherwise specified.
- (2) Full range (MIN to MAX) for LM2901 is $- 40^\circ C$ to $+125^\circ C$. All characteristics are measured with zero common-mode input voltage, unless otherwise specified.
- (3) $V_{CC} \text{ MAX} = 30V$ for non-V devices, and $32V$ for V-suffix devices
- (4) The voltage at either input or common-mode must not be allowed to go negative by more than $0.3V$. The upper end of the common-mode voltage range is $V_{CC+} - 1.5V$; however, one input can exceed V_{CC} , and the comparator provides a proper output state as long as the other input remains in the common-mode range. Either or both inputs can go to $V_{CC} \text{ MAX}$ without damage.

6.12 Switching Characteristics for LM139 and LM139A

$$V_{CC} = 5V, T_A = 25^\circ C$$

| PARAMETER | TEST CONDITIONS | | LM139 LM139A | UNIT |
|---------------|---|-------------------------------------|-----------------|---------|
| | | | TYP | |
| Response time | R_L connected to 5V through 5.1k Ω , $C_L = 15pF^{(1) (2)}$ | 100mV input step with 5mV overdrive | 1.3 | μs |
| | | TTL-level input step | 0.3 | |

(1) C_L includes probe and jig capacitance.

(2) The response time specified is the interval between the input step function and the instant when the output crosses 1.4V.

6.13 Switching Characteristics for LM339B and LM2901B

$$V_S = 5V, V_{O_PULLUP} = 5V, V_{CM} = V_S/2, C_L = 15pF, R_L = 5.1k\Omega, T_A = 25^\circ C \text{ (unless otherwise noted).}$$

| PARAMETER | | TEST CONDITIONS | MIN | TYP | MAX | UNIT |
|----------------|---|---|-----|------|-----|------|
| $t_{response}$ | Propagation delay time, high-to-low; Small scale input signal ⁽¹⁾ | Input overdrive = 5mV, Input step = 100mV | | 1000 | | ns |
| $t_{response}$ | Propagation delay time, high-to-low; TTL input signal ⁽¹⁾ | TTL input with $V_{ref} = 1.4V$ | | 300 | | ns |

(1) High-to-low and low-to-high refers to the transition at the input.

6.14 Switching Characteristics for LMx39 and LMx39A

$$V_{CC} = 5V, T_A = 25^\circ C$$

| PARAMETER | TEST CONDITIONS | | LM239 LM239A LM339 LM339A | UNIT |
|---------------|---|-------------------------------------|------------------------------------|---------|
| | | | TYP | |
| Response time | R_L connected to 5V through 5.1k Ω , $C_L = 15pF^{(1) (2)}$ | 100mV input step with 5mV overdrive | 1.3 | μs |
| | | TTL-level input step | 0.3 | |

(1) C_L includes probe and jig capacitance.

(2) The response time specified is the interval between the input step function and the instant when the output crosses 1.4V.

6.15 Switching Characteristics for LM2901

$$V_{CC} = 5V, T_A = 25^\circ C$$

| PARAMETER | TEST CONDITIONS | | LM2901 | UNIT |
|---------------|---|-------------------------------------|--------|---------|
| | | | TYP | |
| Response time | R_L connected to 5V through 5.1k Ω , $C_L = 15pF^{(1) (2)}$ | 100mV input step with 5mV overdrive | 1.3 | μs |
| | | TTL-level input step | 0.3 | |

(1) C_L includes probe and jig capacitance.

(2) The response time specified is the interval between the input step function and the instant when the output crosses 1.4V.

6.16 Typical Characteristics

$T_A = 25^\circ\text{C}$, $V_S = 5\text{V}$, $R_{\text{PULLUP}} = 5.1\text{k}$, $C_L = 15\text{pF}$, $V_{\text{CM}} = 0\text{V}$, $V_{\text{UNDERDRIVE}} = 100\text{mV}$, $V_{\text{OVERDRIVE}} = 100\text{mV}$ unless otherwise noted.



图 6-1. Total Supply Current vs. Supply Voltage



图 6-2. Total Supply Current vs. Input Voltage at 3V

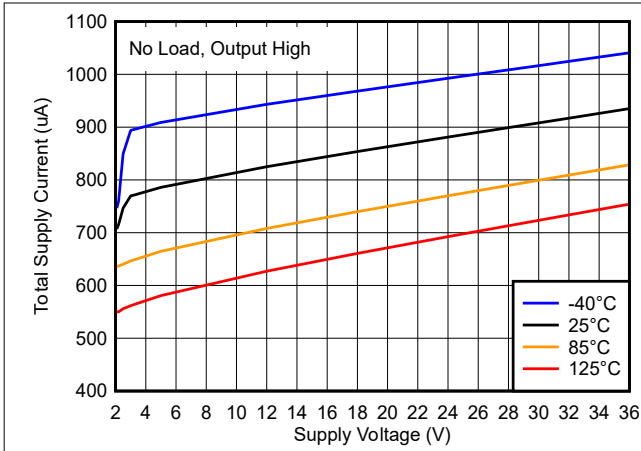

图 6-3. Total Supply Current vs. Input Voltage at 3.3V

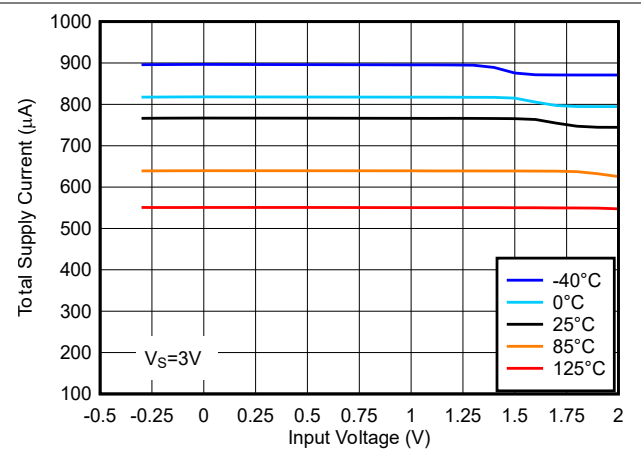

图 6-4. Total Supply Current vs. Input Voltage at 5V

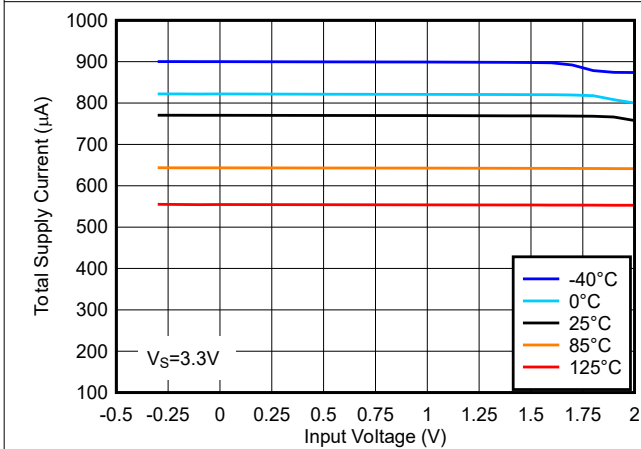

图 6-5. Total Supply Current vs. Input Voltage at 12V

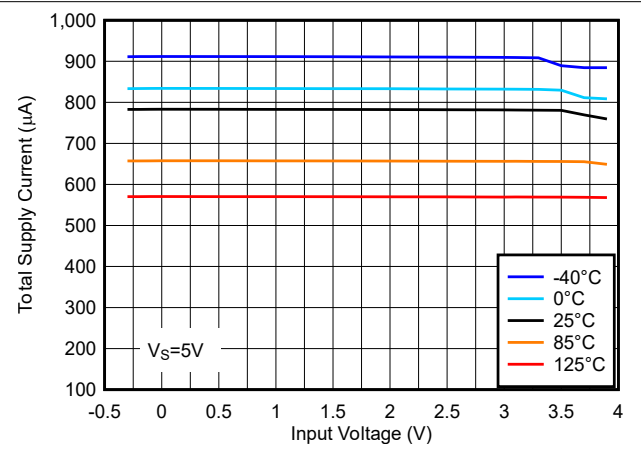

图 6-6. Total Supply Current vs. Input Voltage at 36V

6.16 Typical Characteristics (continued)

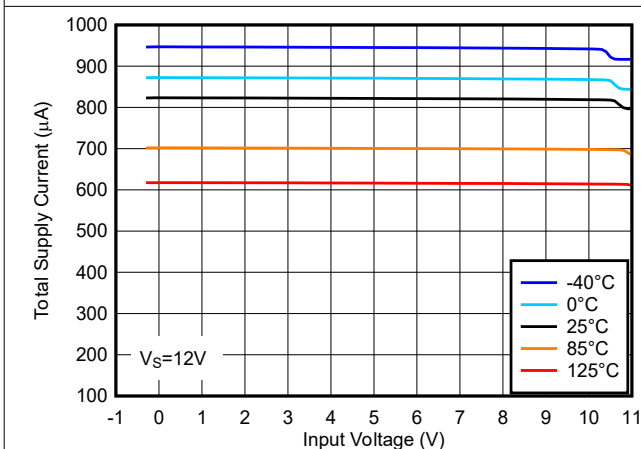
$T_A = 25^\circ\text{C}$, $V_S = 5\text{V}$, $R_{\text{PULLUP}} = 5.1\text{k}$, $C_L = 15\text{pF}$, $V_{\text{CM}} = 0\text{V}$, $V_{\text{UNDERDRIVE}} = 100\text{mV}$, $V_{\text{OVERDRIVE}} = 100\text{mV}$ unless otherwise noted.

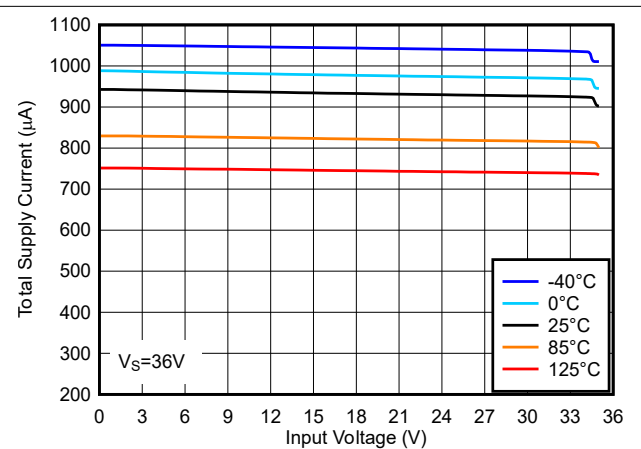

图 6-7. Input Offset Voltage vs. Temperature at 3V



图 6-8. Input Offset Voltage vs. Temperature at 5V

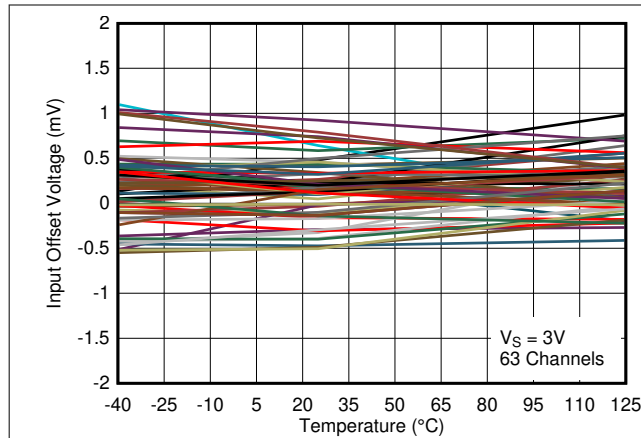

图 6-9. Input Offset Voltage vs. Temperature at 12V

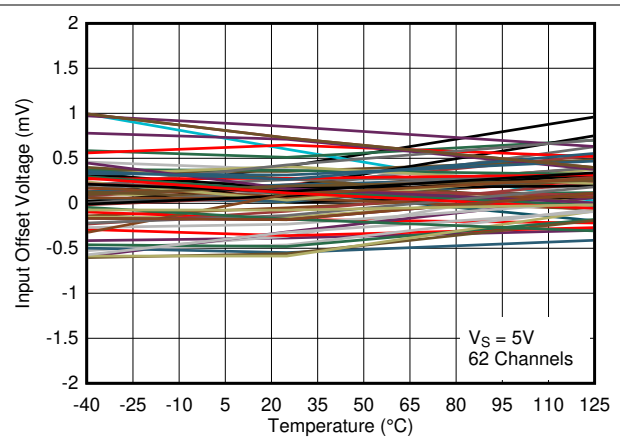

图 6-10. Input Offset Voltage vs. Temperature at 36V

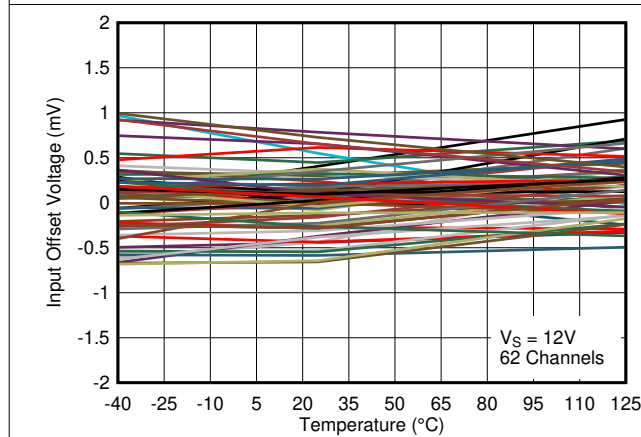

图 6-11. Input Offset Voltage vs. Supply Voltage at -40°C

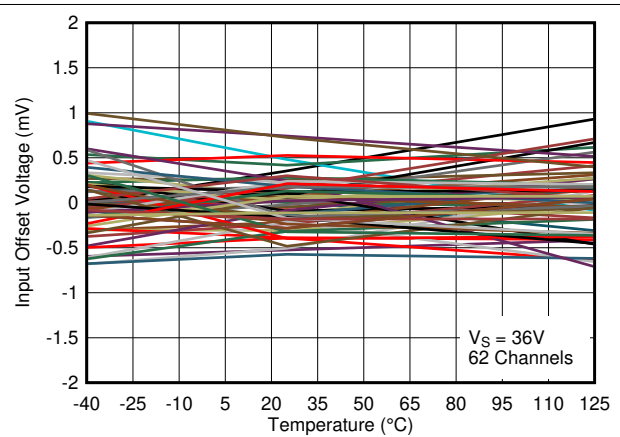

图 6-12. Input Offset Voltage vs. Supply Voltage at 25°C

6.16 Typical Characteristics (continued)

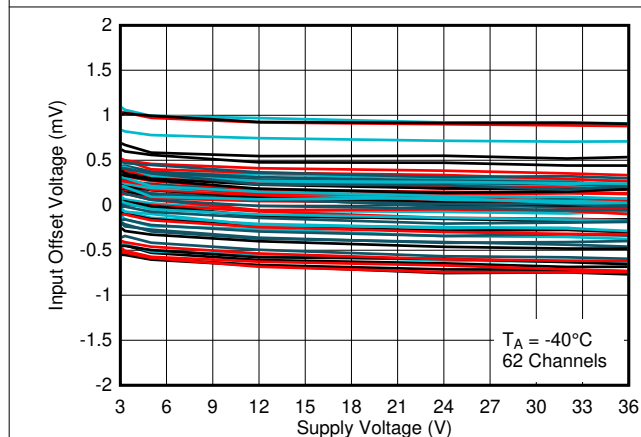
$T_A = 25^\circ\text{C}$, $V_S = 5\text{V}$, $R_{\text{PULLUP}} = 5.1\text{k}$, $C_L = 15\text{pF}$, $V_{\text{CM}} = 0\text{V}$, $V_{\text{UNDERDRIVE}} = 100\text{mV}$, $V_{\text{OVERDRIVE}} = 100\text{mV}$ unless otherwise noted.

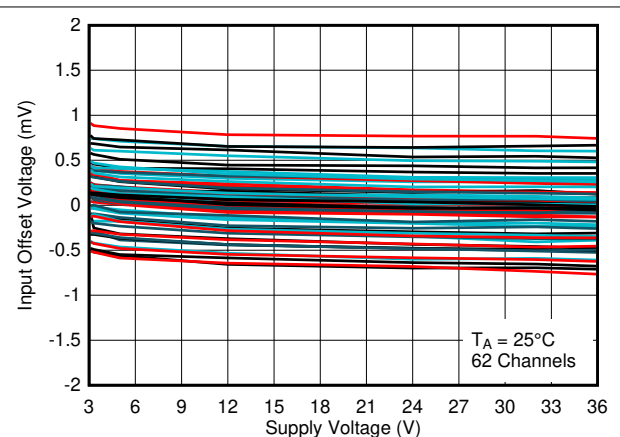

图 6-13. Input Offset Voltage vs. Supply Voltage at 85°C



图 6-14. Input Offset Voltage vs. Supply Voltage at 125°C

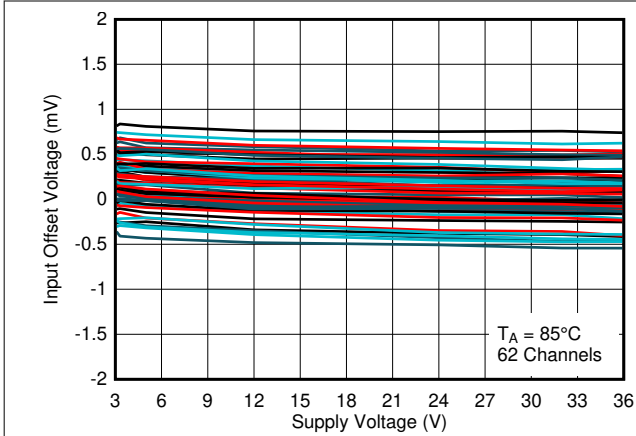

图 6-15. Input Bias Current vs. Supply Voltage

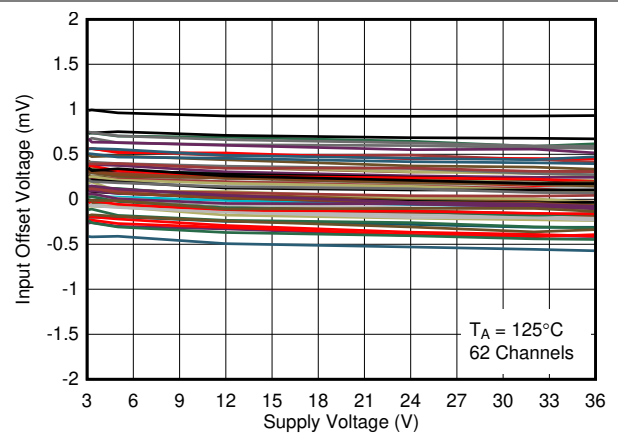

图 6-16. Input Bias Current vs. Input Voltage at 5V

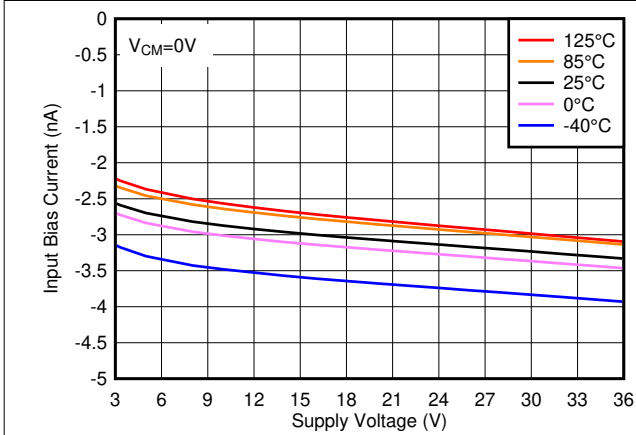

图 6-17. Input Bias Current vs. Input Voltage at 12V

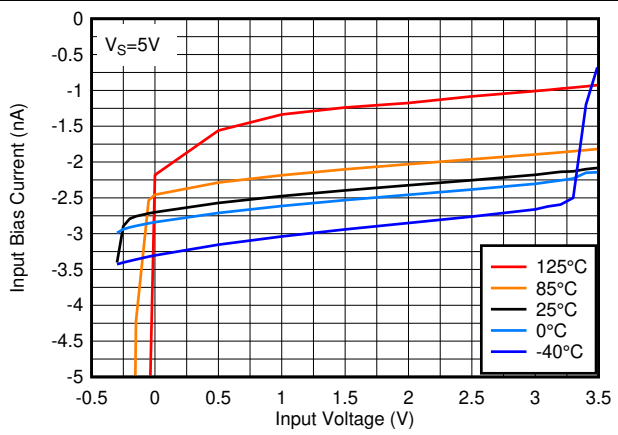

图 6-18. Input Bias Current vs. Input Voltage at 36V

6.16 Typical Characteristics (continued)

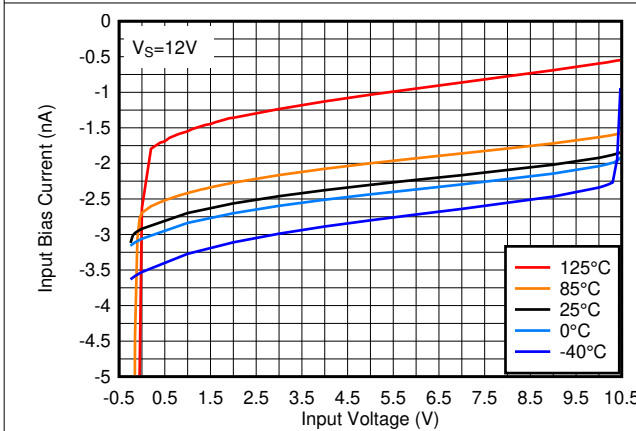
$T_A = 25^\circ\text{C}$, $V_S = 5\text{V}$, $R_{\text{PULLUP}} = 5.1\text{k}$, $C_L = 15\text{pF}$, $V_{\text{CM}} = 0\text{V}$, $V_{\text{UNDERDRIVE}} = 100\text{mV}$, $V_{\text{OVERDRIVE}} = 100\text{mV}$ unless otherwise noted.

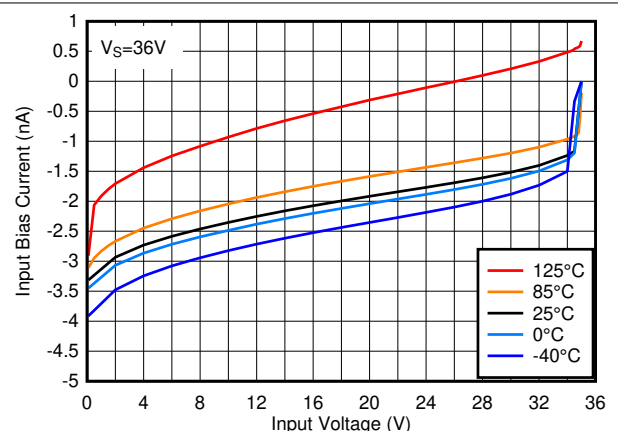

图 6-19. Output Low Voltage vs. Output Sinking Current at 3V



图 6-20. Output Low Voltage vs. Output Sinking Current at 5V

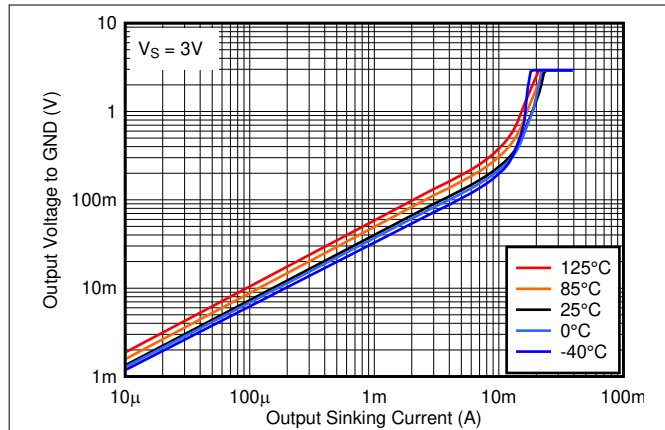

图 6-21. Output Low Voltage vs. Output Sinking Current at 12V

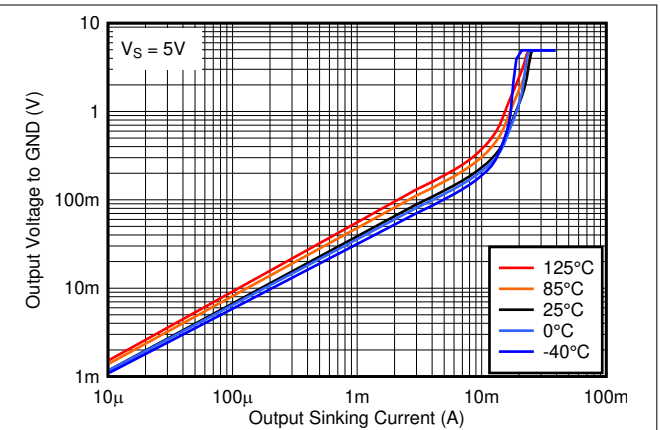

图 6-22. Output Low Voltage vs. Output Sinking Current at 36V

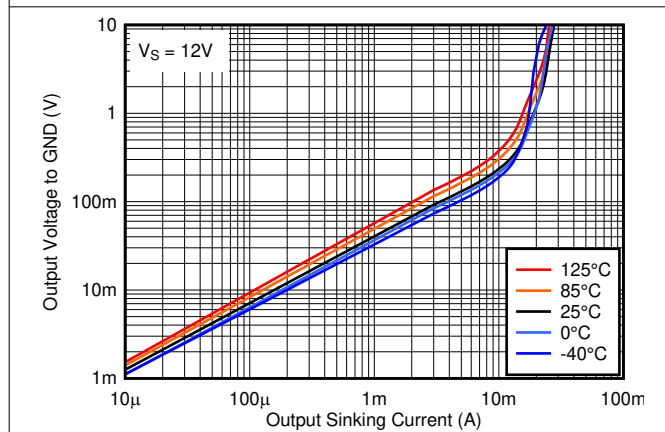

图 6-23. Output High Leakage Current vs. Temperature at 5V

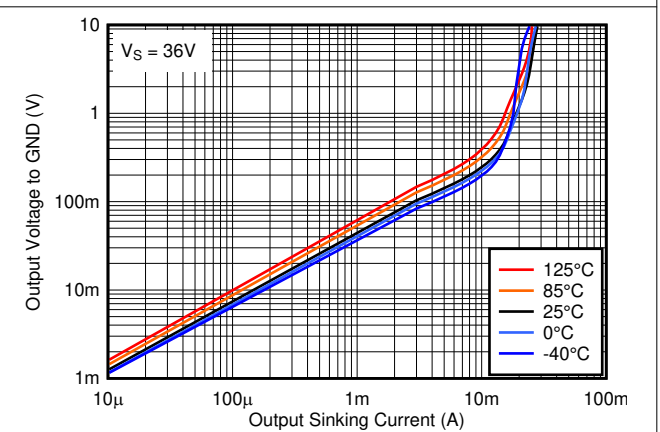

图 6-24. Output High Leakage Current vs. Temperature at 36V

6.16 Typical Characteristics (continued)

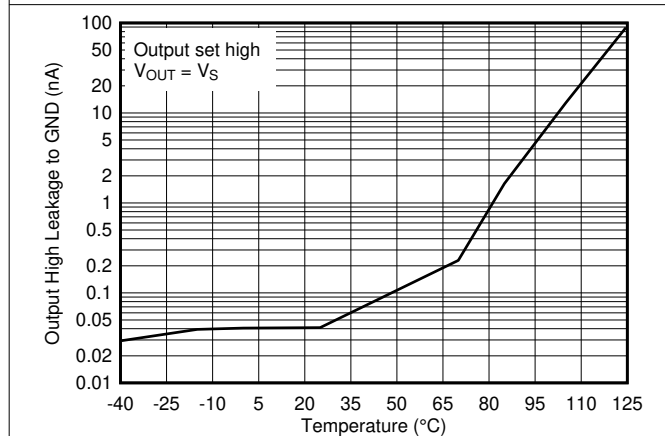
$T_A = 25^\circ\text{C}$, $V_S = 5\text{V}$, $R_{\text{PULLUP}} = 5.1\text{k}$, $C_L = 15\text{pF}$, $V_{\text{CM}} = 0\text{V}$, $V_{\text{UNDERDRIVE}} = 100\text{mV}$, $V_{\text{OVERDRIVE}} = 100\text{mV}$ unless otherwise noted.

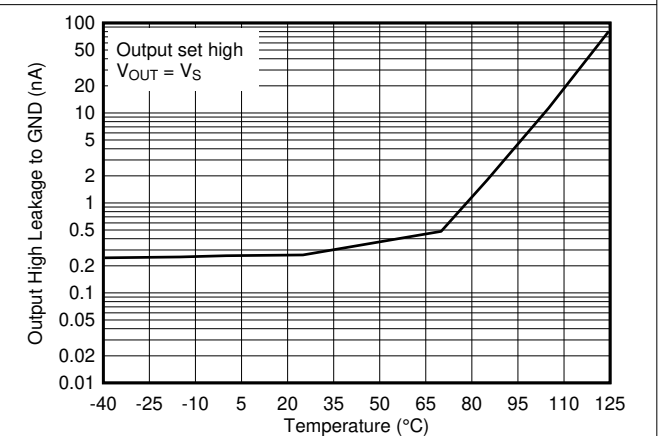

图 6-25. High to Low Propagation Delay vs. Input Overdrive Voltage, 5V



图 6-26. Low to High Propagation Delay vs. Input Overdrive Voltage, 5V

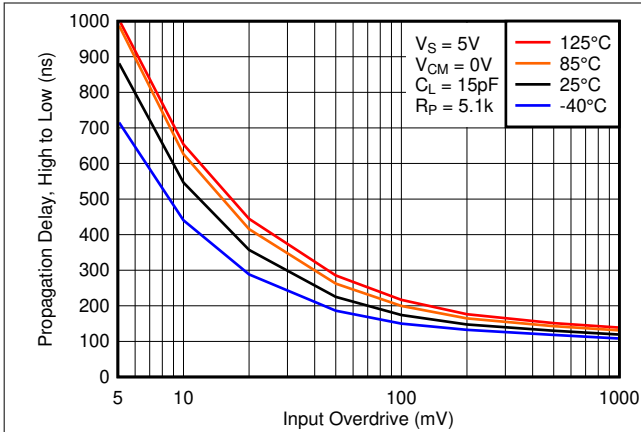

图 6-27. High to Low Propagation Delay vs. Input Overdrive Voltage, 12V

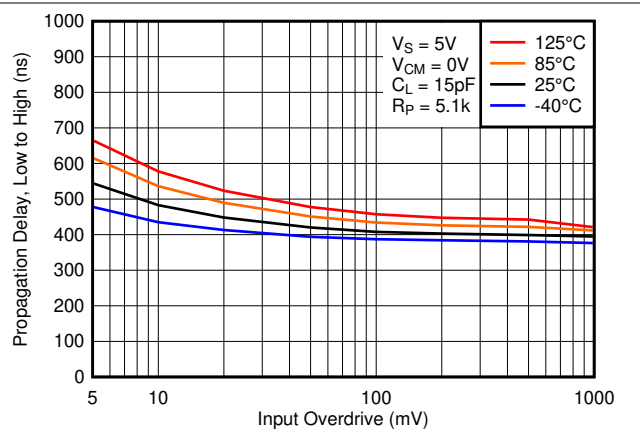

图 6-28. Low to High Propagation Delay vs. Input Overdrive Voltage, 12V

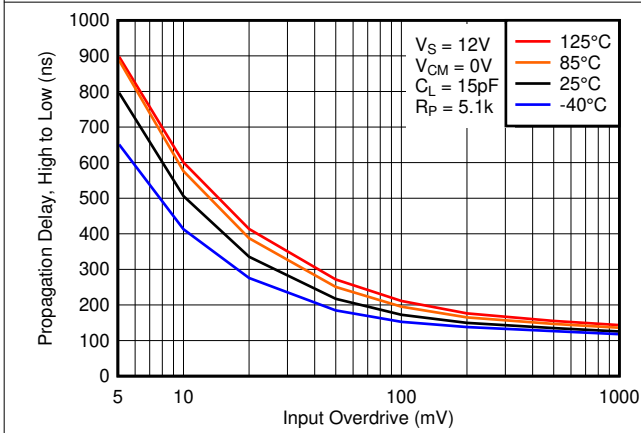

图 6-29. High to Low Propagation Delay vs. Input Overdrive Voltage, 36V

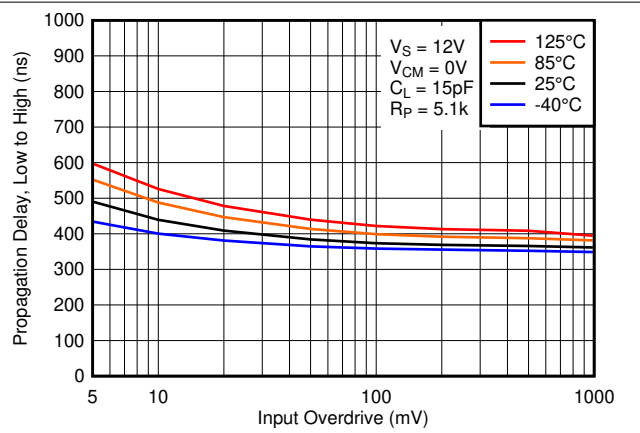

图 6-30. Low to High Propagation Delay vs. Input Overdrive Voltage, 36V

6.16 Typical Characteristics (continued)

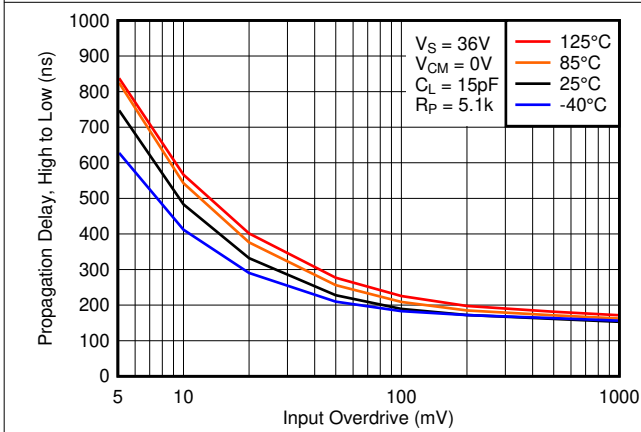
$T_A = 25^\circ\text{C}$, $V_S = 5\text{V}$, $R_{\text{PULLUP}} = 5.1\text{k}$, $C_L = 15\text{pF}$, $V_{\text{CM}} = 0\text{V}$, $V_{\text{UNDERDRIVE}} = 100\text{mV}$, $V_{\text{OVERDRIVE}} = 100\text{mV}$ unless otherwise noted.

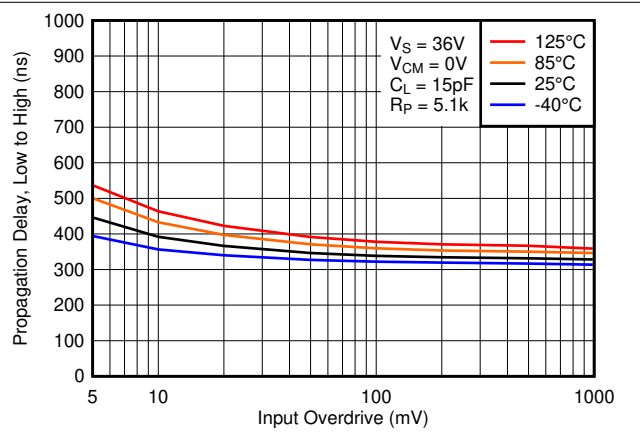

图 6-31. Response Time for Various Overdrives, High-to-Low Transition



图 6-32. Response Time for Various Overdrives, Low-to-High Transition

7 Detailed Description

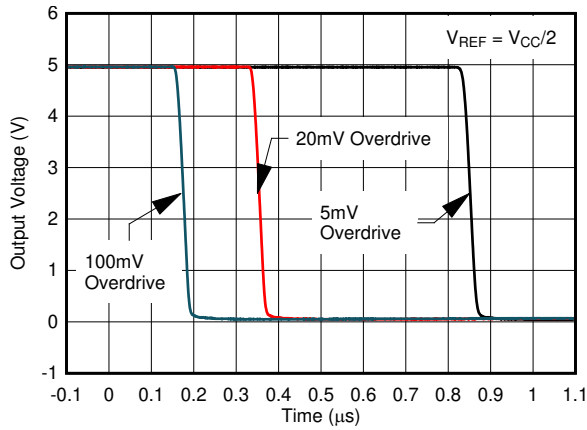
7.1 Overview

These dual comparators have the ability to operate up to absolute maximum of 36V (38V for the "B" version) on the supply pin. This device has proven ubiquity and versatility across a wide range of applications. This is due to very wide supply voltages range, low I_q and fast response of the devices.

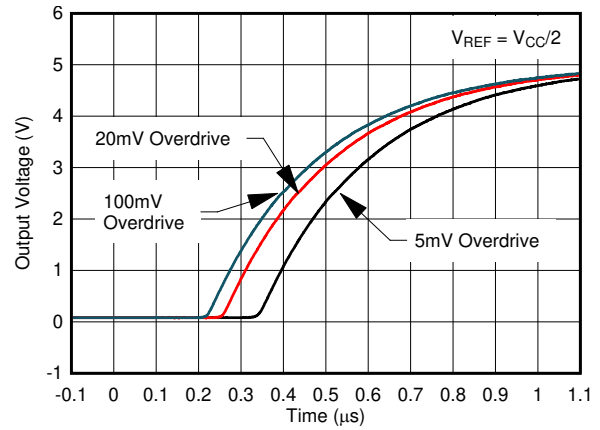
The open-collector outputs allow the user to level shift to the desired logic level independent of V_{CC} , while also enabling AND functionality when multiple outputs are connected together.

7.2 Functional Block Diagram



图 7-1. Schematic (Each Comparator)

7.3 Feature Description

The comparator consists of a PNP Darlington pair input, allowing the device to operate with very high gain and fast response with minimal input bias current. The input Darlington pair creates a limit on the input common mode voltage capability, allowing the comparator to accurately function from ground to $V_{CC} - 2V$ over temperature. A clamp is added around Q3 to mimic the both inputs above input voltage range behavior of the original classic silicon.

The output consists of an open drain NPN (pull-down or low side) transistor. The output NPN sinks current when the negative input voltage is higher than the positive input voltage and the offset voltage. The V_{OL} is resistive and scales with the output current. Please see the "Output Low Voltage vs. Output Sinking Current" graphs for V_{OL} values with respect to the output current.

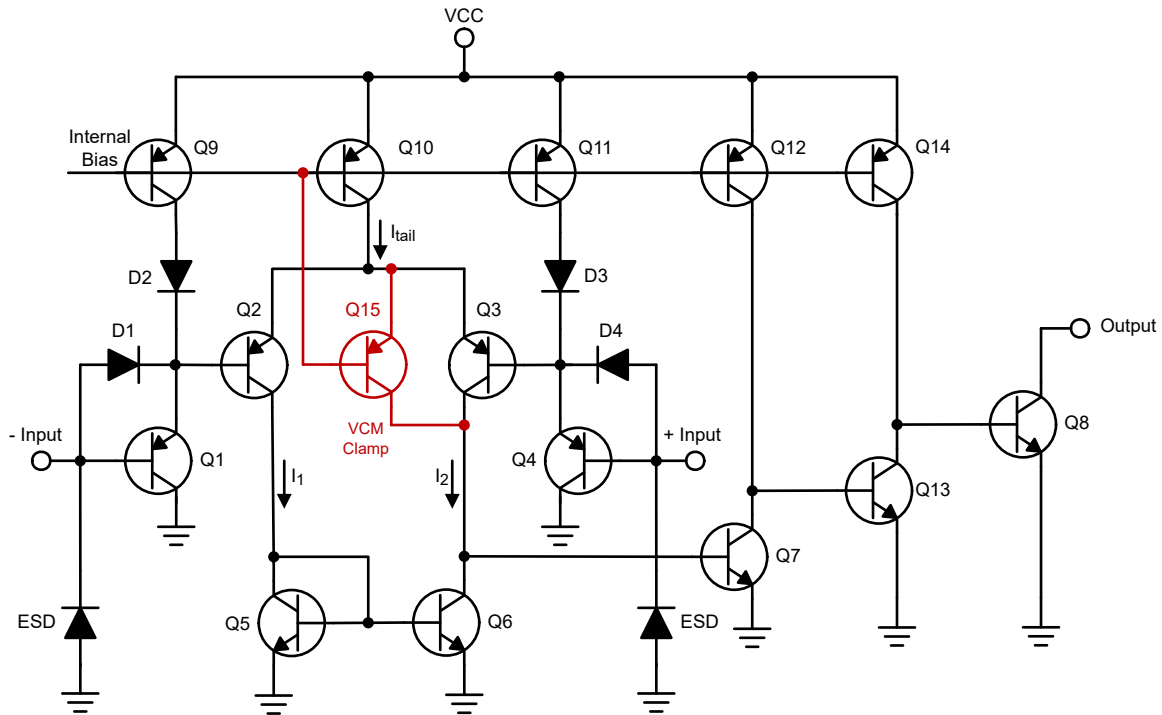
7.4 Device Functional Modes

7.4.1 Voltage Comparison

The comparator operates solely as a voltage comparator, comparing the differential voltage between the positive and negative pins and outputting a logic low or high impedance (logic high with pullup) based on the input differential polarity.

8 Application and Implementation

备注

以下应用部分中的信息不属于 TI 器件规格的范围，TI 不担保其准确性和完整性。TI 的客户应负责确定器件是否适用于其应用。客户应验证并测试其设计，以确保系统功能。

8.1 Application Information

Typically, a comparator compares either a single signal to a reference, or to two different signals. Many users take advantage of the open-drain output to drive the comparison logic output to a logic voltage level to an MCU or logic device. The wide supply range and high voltage capability makes LMx39 or LM2901x an excellent choice for level shifting to a higher or lower voltage.

8.2 Typical Application



图 8-1. Single-ended and Differential Comparator Configurations

8.2.1 Design Requirements

For this design example, use the parameters listed in 表 8-1 as the input parameters.

表 8-1. Design Parameters

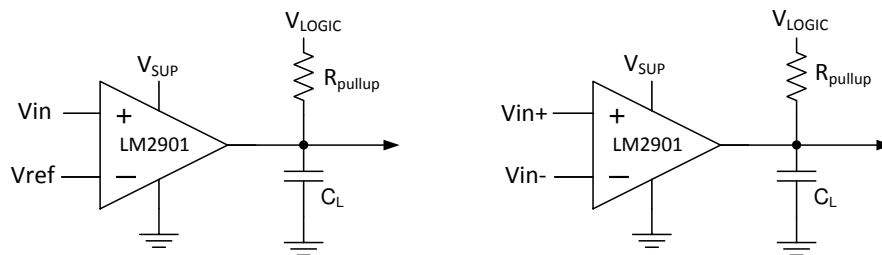
| DESIGN PARAMETER | EXAMPLE VALUE |
|---------------------------------|--------------------------|
| Input Voltage Range | 0V to $V_{sup}-2V$ |
| Supply Voltage | 4.5V to V_{CC} maximum |
| Logic Supply Voltage | 0V to V_{CC} maximum |
| Output Current (R_{PULLUP}) | 1 μ A to 4mA |
| Input Overdrive Voltage | 100mV |
| Reference Voltage | 2.5V |
| Load Capacitance (C_L) | 15pF |

8.2.2 Detailed Design Procedure

When using the LMx39 in a general comparator application, determine the following:

- Input voltage range
- Minimum overdrive voltage
- Output and drive current
- Response time

8.2.2.1 Input Voltage Range

When choosing the input voltage range, the input common mode voltage range (V_{ICR}) must be taken in to account. If temperature operation is below 25°C the V_{ICR} can range from 0V to $V_{CC} - 2.0V$. This limits the input voltage range to as high as $V_{CC} - 2.0V$ and as low as 0V. Operation outside of this range can yield incorrect comparisons.

The following is a list of input voltage situation and the outcomes:

1. When both IN- and IN+ are both within the common-mode range:
 - a. If IN- is higher than IN+ and the offset voltage, the output is low and the output transistor is sinking current
 - b. If IN- is lower than IN+ and the offset voltage, the output is high impedance and the output transistor is not conducting
2. When IN- is higher than common-mode and IN+ is within common-mode, the output is low and the output transistor is sinking current
3. When IN+ is higher than common-mode and IN- is within common-mode, the output is high impedance and the output transistor is not conducting
4. When IN- and IN+ are both higher than common-mode, see Section 2 of [Application Design Guidelines for LM339, LM393, TL331 Family Comparators Including the New B-versions](#).

8.2.2.2 Minimum Overdrive Voltage

Overdrive voltage is the differential voltage produced between the positive and negative inputs of the comparator over the offset voltage (V_{IO}). To make an accurate comparison, the overdrive voltage (V_{OD}) must be higher than the input offset voltage (V_{IO}). Overdrive voltage can also determine the response time of the comparator, with the response time decreasing with increasing overdrive. [图 8-2](#) and [图 8-3](#) show positive and negative response times with respect to overdrive voltage.

8.2.2.3 Output and Drive Current

Output current is determined by the load and pullup resistance and logic and pullup voltage. The output current produces a low-level output voltage (V_{OL}) from the comparator, where V_{OL} is proportional to the output current.

The output current can also effect the transient response.

8.2.2.4 Response Time

Response time is a function of input over-drive. See the [Typical Characteristics](#) graphs for typical response times. The rise and fall times can be determined by the load capacitance (C_L), load/pull-up resistance (R_{PULLUP}) and equivalent collector-emitter resistance (R_{CE}).

- The rise time (τ_R) is approximately $\tau_R = R_{PULLUP} \times C_L$
- The fall time (τ_F) is approximately $\tau_F = R_{CE} \times C_L$
 - R_{CE} can be determined by taking the slope of [图 6-31](#) in the linear region at the desired temperature, or by dividing the V_{OL} by I_{OUT}

8.2.3 Application Curves

图 8-2 和 图 8-3 were generated with scope probe parasitic capacitance of 50pF.

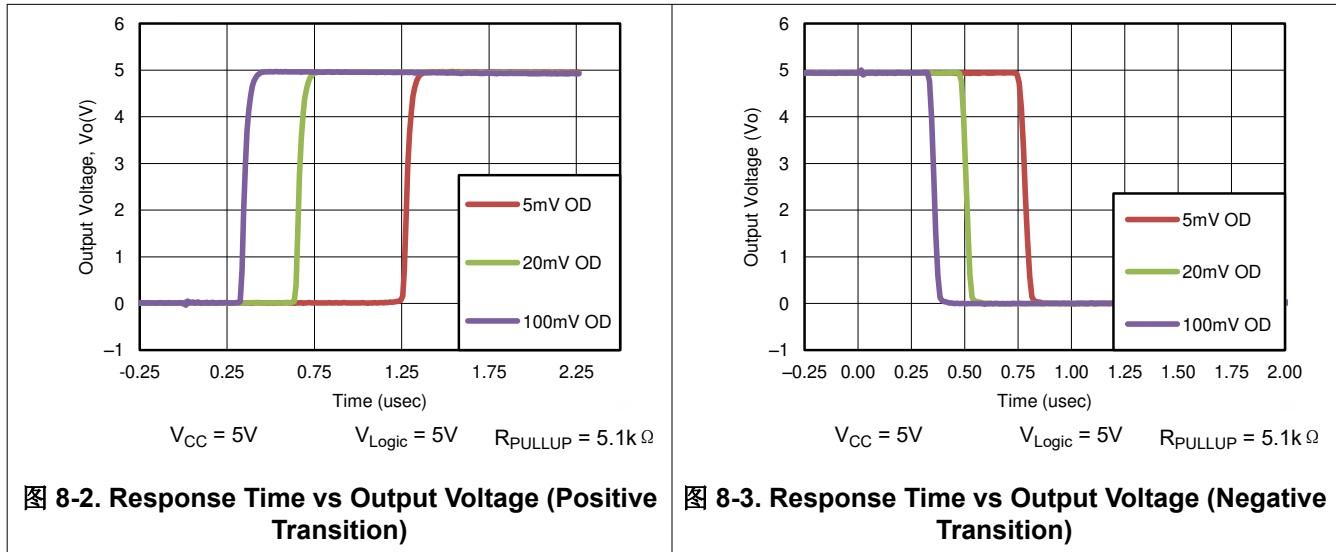

8.3 Power Supply Recommendations

For fast response and comparison applications with noisy or AC inputs, use a bypass capacitor on the supply pin to reject any variation on the supply voltage. This variation can affect the common-mode range of the comparator input and create an inaccurate comparison.

8.4 Layout

8.4.1 Layout Guidelines

For accurate comparator applications without hysteresis maintaining a stable power supply with minimized noise and glitches is critical. Best practice is to add a bypass capacitor between the supply voltage and ground. This can be implemented on the positive power supply and negative supply (if available). If a negative supply is not being used, do not put a capacitor between the GND pin and system ground.

Minimize coupling between outputs and inverting inputs to prevent output oscillations. Do not run output and inverting input traces in parallel unless there is a V_{CC} or GND trace between output and inverting input traces to reduce coupling. When series resistance is added to inputs, place resistor close to the device.

8.4.2 Layout Example



图 8-4. LMx39 Layout Example

9 Device and Documentation Support

9.1 Related Links

The table below lists quick access links. Categories include technical documents, support and community resources, tools and software, and quick access to sample or buy.

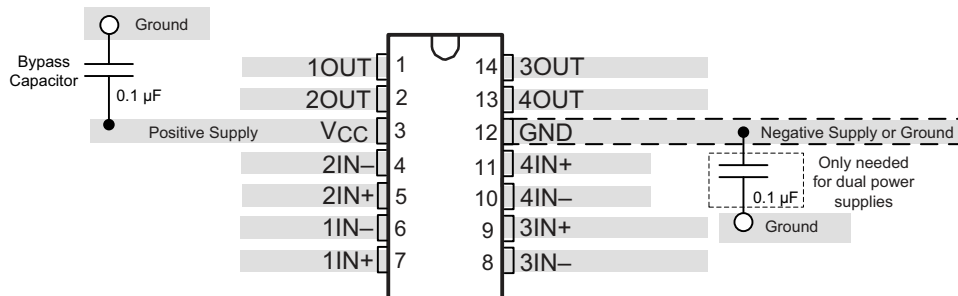
表 9-1. Related Links

| PARTS | PRODUCT FOLDER | SAMPLE & BUY | TECHNICAL DOCUMENTS | TOOLS & SOFTWARE | SUPPORT & COMMUNITY |
|----------|----------------------------|----------------------------|----------------------------|----------------------------|----------------------------|
| LM139 | Click here | Click here | Click here | Click here | Click here |
| LM239 | Click here | Click here | Click here | Click here | Click here |
| LM339 | Click here | Click here | Click here | Click here | Click here |
| LM339B | Click here | Click here | Click here | Click here | Click here |
| LM139A | Click here | Click here | Click here | Click here | Click here |
| LM239A | Click here | Click here | Click here | Click here | Click here |
| LM339A | Click here | Click here | Click here | Click here | Click here |
| LM2901 | Click here | Click here | Click here | Click here | Click here |
| LM2901B | Click here | Click here | Click here | Click here | Click here |
| LM2901AV | Click here | Click here | Click here | Click here | Click here |
| LM2901V | Click here | Click here | Click here | Click here | Click here |

9.2 Receiving Notification of Documentation Updates

To receive notification of documentation updates, navigate to the device product folder on ti.com. In the upper right corner, click on *Alert me* to register and receive a weekly digest of any product information that has changed. For change details, review the revision history included in any revised document.

9.3 支持资源

TI E2E™ 中文支持论坛是工程师的重要参考资料，可直接从专家处获得快速、经过验证的解答和设计帮助。搜索现有解答或提出自己的问题，获得所需的快速设计帮助。

链接的内容由各个贡献者“按原样”提供。这些内容并不构成 TI 技术规范，并且不一定反映 TI 的观点；请参阅 TI 的[使用条款](#)。

9.4 Trademarks

TI E2E™ is a trademark of Texas Instruments.

所有商标均为其各自所有者的财产。

9.5 静电放电警告



静电放电 (ESD) 会损坏这个集成电路。德州仪器 (TI) 建议通过适当的预防措施处理所有集成电路。如果不遵守正确的处理和安装程序，可能会损坏集成电路。

ESD 的损坏小至导致微小的性能降级，大至整个器件故障。精密的集成电路可能更容易受到损坏，这是因为非常细微的参数更改都可能会导致器件与其发布的规格不相符。

9.6 术语表

TI 术语表

本术语表列出并解释了术语、首字母缩略词和定义。

10 Revision History

注：以前版本的页码可能与当前版本的页码不同

| Changes from Revision Y (March 2025) to Revision Z (May 2025) | Page |
|--|------|
| • Added missing <i>Revision History</i> entry for "Updated Thermal Information" table in revision "Y"..... | 5 |
| • Fixed duplicated Fig 6-4 graph..... | 5 |

| Changes from Revision X (October 2023) to Revision Y (March 2025) | Page |
|---|------|
| • 从 <i>器件信息表</i> 中删除了旧器件。..... | 1 |
| • 更新了 <i>系列比较表</i> 中的首页 ESD 值..... | 1 |
| • Updated <i>Thermal Information</i> table..... | 5 |
| • Removed legacy device graphs..... | 13 |
| • Updated internal schematic..... | 19 |

| Changes from Revision W (October 2023) to Revision X (October 2023) | Page |
|---|------|
| • 向 SOT-23/QFN 的 <i>器件信息表</i> 中添加了 LM339B 和 LM2901B..... | 1 |

| Changes from Revision V (December 2022) to Revision W (October 2023) | Page |
|--|------|
| • Updated thermal tables for new package releases..... | 5 |
| • Changed Apps Input Voltage Range text to reference appnote..... | 20 |

| Changes from Revision U (November 2018) to Revision V (December 2022) | Page |
|---|------|
| • 更新了整个文档中的表格、图和交叉参考的编号格式..... | 1 |
| • 通篇添加了“B”版本。添加了“器件系列”表..... | 1 |

| Changes from Revision T (June 2015) to Revision U (November 2018) | Page |
|--|------|
| • 在 <i>描述</i> 部分中将 LM239x 温度范围从 125°C 更改为 85°C..... | 1 |
| • 更改了数据表标题..... | 1 |
| • Changed LM293AD to LM239AD in <i>Device Comparison Table</i> | 3 |
| • Added Input Current and related footnote in <i>Absolute Maximum Ratings</i> | 5 |
| • Changed layout of <i>Recommended Operating Conditions</i> temperatures to separate rows..... | 6 |
| • Added LM2901V and LMV2901AV to LM2901 Elect Char Table title to make more clear which devices are covered..... | 11 |
| • Changed "Dual" to "Quad" and removed "Absolute Maximum" wording and mention of Q100 in <i>Overview</i> section text..... | 19 |
| • Changed and corrected text in <i>Feature Description</i> section..... | 19 |
| • Changed Example Values in <i>Typical Application Design Parameters</i> table | 20 |
| • Added <i>Receiving Notification of Documentation Updates</i> section..... | 23 |

| Changes from Revision S (August 2012) to Revision T (June 2015) | Page |
|--|-------------|
| • 删除了订购信息表..... | 1 |
| • 向特性列表中添加了“军事应用免责声明”。..... | 1 |
| • 添加了应用、器件信息表、引脚配置和功能部分、ESD 等级表、热性能信息表、特性说明部分、器件功能模式、应用和实施部分、电源相关建议部分、布局部分、器件和文档支持部分以及机械、封装和可订购信息部分。无规格变化..... | 1 |

11 Mechanical, Packaging, and Orderable Information

The following pages include mechanical packaging and orderable information. This information is the most current data available for the designated devices. This data is subject to change without notice and revision of this document. For browser based versions of this data sheet, refer to the left hand navigation.

PACKAGING INFORMATION

| Orderable part number | Status (1) | Material type (2) | Package Pins | Package qty Carrier | RoHS (3) | Lead finish/ Ball material (4) | MSL rating/ Peak reflow (5) | Op temp (°C) | Part marking (6) |
|-----------------------|---------------|----------------------|-----------------|-----------------------|-------------|--------------------------------------|-----------------------------------|--------------|---------------------|
| LM139AD | Obsolete | Production | SOIC (D) 14 | - | - | Call TI | Call TI | -55 to 125 | LM139A |
| LM139ADG4 | Obsolete | Production | SOIC (D) 14 | - | - | Call TI | Call TI | -55 to 125 | LM139A |
| LM139ADR | Active | Production | SOIC (D) 14 | 2500 LARGE T&R | Yes | NIPDAU | Level-1-260C-UNLIM | -55 to 125 | LM139A |
| LM139ADR.A | Active | Production | SOIC (D) 14 | 2500 LARGE T&R | Yes | NIPDAU | Level-1-260C-UNLIM | -55 to 125 | LM139A |
| LM139ADRG4 | Active | Production | SOIC (D) 14 | 2500 LARGE T&R | Yes | NIPDAU | Level-1-260C-UNLIM | -55 to 125 | LM139A |
| LM139ADRG4.A | Active | Production | SOIC (D) 14 | 2500 LARGE T&R | Yes | NIPDAU | Level-1-260C-UNLIM | -55 to 125 | LM139A |
| LM139D | Obsolete | Production | SOIC (D) 14 | - | - | Call TI | Call TI | -55 to 125 | LM139 |
| LM139DG4 | Obsolete | Production | SOIC (D) 14 | - | - | Call TI | Call TI | -55 to 125 | LM139 |
| LM139DR | Active | Production | SOIC (D) 14 | 2500 LARGE T&R | Yes | NIPDAU | Level-1-260C-UNLIM | -55 to 125 | LM139 |
| LM139DR.A | Active | Production | SOIC (D) 14 | 2500 LARGE T&R | Yes | NIPDAU | Level-1-260C-UNLIM | -55 to 125 | LM139 |
| LM139DRG4 | Active | Production | SOIC (D) 14 | 2500 LARGE T&R | Yes | NIPDAU | Level-1-260C-UNLIM | -55 to 125 | LM139 |
| LM139DRG4.A | Active | Production | SOIC (D) 14 | 2500 LARGE T&R | Yes | NIPDAU | Level-1-260C-UNLIM | -55 to 125 | LM139 |
| LM239AD | Obsolete | Production | SOIC (D) 14 | - | - | Call TI | Call TI | -25 to 85 | LM239A |
| LM239ADR | Active | Production | SOIC (D) 14 | 2500 LARGE T&R | Yes | NIPDAU | Level-1-260C-UNLIM | -25 to 85 | LM239A |
| LM239ADR.A | Active | Production | SOIC (D) 14 | 2500 LARGE T&R | Yes | NIPDAU | Level-1-260C-UNLIM | -25 to 85 | LM239A |
| LM239ADRE4 | Active | Production | SOIC (D) 14 | 2500 LARGE T&R | - | Call TI | Call TI | -25 to 85 | |
| LM239ADRG4 | Active | Production | SOIC (D) 14 | 2500 LARGE T&R | - | Call TI | Call TI | -25 to 85 | |
| LM239D | Obsolete | Production | SOIC (D) 14 | - | - | Call TI | Call TI | -25 to 85 | LM239 |
| LM239DR | Active | Production | SOIC (D) 14 | 2500 LARGE T&R | Yes | NIPDAU | Level-1-260C-UNLIM | -25 to 85 | LM239 |
| LM239DR.A | Active | Production | SOIC (D) 14 | 2500 LARGE T&R | Yes | NIPDAU | Level-1-260C-UNLIM | -25 to 85 | LM239 |
| LM239DRG3 | Obsolete | Production | SOIC (D) 14 | - | - | Call TI | Call TI | -25 to 85 | LM239 |
| LM239DRG4 | Obsolete | Production | SOIC (D) 14 | - | - | Call TI | Call TI | -25 to 85 | LM239 |
| LM239N | Active | Production | PDIP (N) 14 | 25 TUBE | Yes | NIPDAU SN | N/A for Pkg Type | -25 to 85 | LM239N |
| LM239N.A | Active | Production | PDIP (N) 14 | 25 TUBE | Yes | NIPDAU | N/A for Pkg Type | -25 to 85 | LM239N |
| LM239NE4 | Active | Production | PDIP (N) 14 | 25 TUBE | - | Call TI | Call TI | -25 to 85 | |
| LM239PW | Obsolete | Production | TSSOP (PW) 14 | - | - | Call TI | Call TI | -25 to 85 | L239 |
| LM239PWR | Active | Production | TSSOP (PW) 14 | 2000 LARGE T&R | Yes | NIPDAU SN | Level-1-260C-UNLIM | -25 to 85 | L239 |
| LM239PWR.A | Active | Production | TSSOP (PW) 14 | 2000 LARGE T&R | Yes | NIPDAU | Level-1-260C-UNLIM | -25 to 85 | L239 |
| LM239PWRG4 | Obsolete | Production | TSSOP (PW) 14 | - | - | Call TI | Call TI | -25 to 85 | L239 |

| Orderable part number | Status (1) | Material type (2) | Package Pins | Package qty Carrier | RoHS (3) | Lead finish/ Ball material (4) | MSL rating/ Peak reflow (5) | Op temp (°C) | Part marking (6) |
|--------------------------------|---------------|----------------------|-----------------|-----------------------|-------------|--------------------------------------|-----------------------------------|--------------|---------------------|
| LM2901AVQDR | Active | Production | SOIC (D) 14 | 2500 LARGE T&R | Yes | NIPDAU | Level-1-260C-UNLIM | -40 to 125 | (2901AV, L2901AV) |
| LM2901AVQDR.A | Active | Production | SOIC (D) 14 | 2500 LARGE T&R | Yes | NIPDAU | Level-1-260C-UNLIM | -40 to 125 | (2901AV, L2901AV) |
| LM2901AVQDRG4 | Active | Production | SOIC (D) 14 | 2500 LARGE T&R | Yes | NIPDAU | Level-1-260C-UNLIM | -40 to 125 | (2901AV, L2901AV) |
| LM2901AVQDRG4.A | Active | Production | SOIC (D) 14 | 2500 LARGE T&R | Yes | NIPDAU | Level-1-260C-UNLIM | -40 to 125 | (2901AV, L2901AV) |
| LM2901AVQPWR | Active | Production | TSSOP (PW) 14 | 2000 LARGE T&R | Yes | NIPDAU | Level-1-260C-UNLIM | -40 to 125 | (2901AV, L2901AV) |
| LM2901AVQPWR.A | Active | Production | TSSOP (PW) 14 | 2000 LARGE T&R | Yes | NIPDAU | Level-1-260C-UNLIM | -40 to 125 | (2901AV, L2901AV) |
| LM2901AVQPWRG4 | Active | Production | TSSOP (PW) 14 | 2000 LARGE T&R | Yes | NIPDAU | Level-1-260C-UNLIM | -40 to 125 | (2901AV, L2901AV) |
| LM2901AVQPWRG4.A | Active | Production | TSSOP (PW) 14 | 2000 LARGE T&R | Yes | NIPDAU | Level-1-260C-UNLIM | -40 to 125 | (2901AV, L2901AV) |
| LM2901BIDR | Active | Production | SOIC (D) 14 | 3000 LARGE T&R | Yes | NIPDAU | Level-1-260C-UNLIM | -40 to 125 | LM2901B |
| LM2901BIDR.A | Active | Production | SOIC (D) 14 | 3000 LARGE T&R | Yes | NIPDAU | Level-1-260C-UNLIM | -40 to 125 | LM2901B |
| LM2901BIPWR | Active | Production | TSSOP (PW) 14 | 3000 LARGE T&R | Yes | NIPDAU | Level-1-260C-UNLIM | -40 to 125 | LM2901B |
| LM2901BIPWR.A | Active | Production | TSSOP (PW) 14 | 3000 LARGE T&R | Yes | NIPDAU | Level-1-260C-UNLIM | -40 to 125 | LM2901B |
| LM2901BIRTER | Active | Production | WQFN (RTE) 16 | 5000 LARGE T&R | Yes | SN | Level-1-260C-UNLIM | -40 to 125 | M2901B |
| LM2901BIRTER.A | Active | Production | WQFN (RTE) 16 | 5000 LARGE T&R | Yes | SN | Level-1-260C-UNLIM | -40 to 125 | M2901B |
| LM2901D | Obsolete | Production | SOIC (D) 14 | - | - | Call TI | Call TI | -40 to 125 | LM2901 |
| LM2901DR | Active | Production | SOIC (D) 14 | 2500 LARGE T&R | Yes | NIPDAU | Level-1-260C-UNLIM | -40 to 125 | LM2901 |
| LM2901DR.A | Active | Production | SOIC (D) 14 | 2500 LARGE T&R | Yes | NIPDAU | Level-1-260C-UNLIM | -40 to 125 | LM2901 |
| LM2901DRE4 | Active | Production | SOIC (D) 14 | 2500 LARGE T&R | Yes | NIPDAU | Level-1-260C-UNLIM | -40 to 125 | LM2901 |
| LM2901DRG3 | Active | Production | SOIC (D) 14 | 2500 LARGE T&R | Yes | SN | Level-1-260C-UNLIM | -40 to 125 | LM2901 |
| LM2901DRG3.A | Active | Production | SOIC (D) 14 | 2500 LARGE T&R | Yes | SN | Level-1-260C-UNLIM | -40 to 125 | LM2901 |
| LM2901DRG4 | Active | Production | SOIC (D) 14 | 2500 LARGE T&R | Yes | NIPDAU | Level-1-260C-UNLIM | -40 to 125 | LM2901 |
| LM2901DRG4.A | Active | Production | SOIC (D) 14 | 2500 LARGE T&R | Yes | NIPDAU | Level-1-260C-UNLIM | -40 to 125 | LM2901 |
| LM2901N | Active | Production | PDIP (N) 14 | 25 TUBE | Yes | NIPDAU | N/A for Pkg Type | -40 to 125 | LM2901N |
| LM2901N.A | Active | Production | PDIP (N) 14 | 25 TUBE | Yes | NIPDAU | N/A for Pkg Type | -40 to 125 | LM2901N |
| LM2901NSR | Active | Production | SOP (NS) 14 | 2000 LARGE T&R | Yes | NIPDAU | Level-1-260C-UNLIM | -40 to 125 | LM2901 |
| LM2901NSR.A | Active | Production | SOP (NS) 14 | 2000 LARGE T&R | Yes | NIPDAU | Level-1-260C-UNLIM | -40 to 125 | LM2901 |
| LM2901PW | Obsolete | Production | TSSOP (PW) 14 | - | - | Call TI | Call TI | -40 to 125 | L2901 |
| LM2901PWR | Active | Production | TSSOP (PW) 14 | 2000 LARGE T&R | Yes | NIPDAU SN | Level-1-260C-UNLIM | -40 to 125 | L2901 |
| LM2901PWR.A | Active | Production | TSSOP (PW) 14 | 2000 LARGE T&R | Yes | NIPDAU | Level-1-260C-UNLIM | -40 to 125 | L2901 |
| LM2901PWRG3 | Active | Production | TSSOP (PW) 14 | 2000 LARGE T&R | Yes | SN | Level-1-260C-UNLIM | -40 to 125 | L2901 |
| LM2901PWRG3.A | Active | Production | TSSOP (PW) 14 | 2000 LARGE T&R | Yes | SN | Level-1-260C-UNLIM | -40 to 125 | L2901 |

| Orderable part number | Status (1) | Material type (2) | Package Pins | Package qty Carrier | RoHS (3) | Lead finish/ Ball material (4) | MSL rating/ Peak reflow (5) | Op temp (°C) | Part marking (6) |
|-------------------------------|---------------|----------------------|-----------------|-----------------------|-------------|--------------------------------------|-----------------------------------|--------------|---------------------|
| LM2901PWRG4 | Active | Production | TSSOP (PW) 14 | 2000 LARGE T&R | Yes | NIPDAU | Level-1-260C-UNLIM | -40 to 125 | L2901 |
| LM2901PWRG4.A | Active | Production | TSSOP (PW) 14 | 2000 LARGE T&R | Yes | NIPDAU | Level-1-260C-UNLIM | -40 to 125 | L2901 |
| LM2901VQDR | Active | Production | SOIC (D) 14 | 2500 LARGE T&R | Yes | NIPDAU | Level-1-260C-UNLIM | -40 to 125 | L2901V |
| LM2901VQDR.A | Active | Production | SOIC (D) 14 | 2500 LARGE T&R | Yes | NIPDAU | Level-1-260C-UNLIM | -40 to 125 | L2901V |
| LM2901VQPWR | Active | Production | TSSOP (PW) 14 | 2000 LARGE T&R | Yes | NIPDAU | Level-1-260C-UNLIM | -40 to 125 | L2901V |
| LM2901VQPWR.A | Active | Production | TSSOP (PW) 14 | 2000 LARGE T&R | Yes | NIPDAU | Level-1-260C-UNLIM | -40 to 125 | L2901V |
| LM2901VQPWRG4 | Active | Production | TSSOP (PW) 14 | 2000 LARGE T&R | Yes | NIPDAU | Level-1-260C-UNLIM | -40 to 125 | L2901V |
| LM2901VQPWRG4.A | Active | Production | TSSOP (PW) 14 | 2000 LARGE T&R | Yes | NIPDAU | Level-1-260C-UNLIM | -40 to 125 | L2901V |
| LM339AD | Obsolete | Production | SOIC (D) 14 | - | - | Call TI | Call TI | 0 to 70 | LM339A |
| LM339ADBR | Active | Production | SSOP (DB) 14 | 2000 LARGE T&R | Yes | NIPDAU | Level-1-260C-UNLIM | 0 to 70 | L339A |
| LM339ADBR.A | Active | Production | SSOP (DB) 14 | 2000 LARGE T&R | Yes | NIPDAU | Level-1-260C-UNLIM | 0 to 70 | L339A |
| LM339ADR | Active | Production | SOIC (D) 14 | 2500 LARGE T&R | Yes | NIPDAU SN | Level-1-260C-UNLIM | 0 to 70 | LM339A |
| LM339ADR.A | Active | Production | SOIC (D) 14 | 2500 LARGE T&R | Yes | NIPDAU | Level-1-260C-UNLIM | 0 to 70 | LM339A |
| LM339ADRG4 | Obsolete | Production | SOIC (D) 14 | - | - | Call TI | Call TI | 0 to 70 | LM339A |
| LM339AN | Active | Production | PDIP (N) 14 | 25 TUBE | Yes | NIPDAU SN | N/A for Pkg Type | 0 to 70 | LM339AN |
| LM339AN.A | Active | Production | PDIP (N) 14 | 25 TUBE | Yes | NIPDAU | N/A for Pkg Type | 0 to 70 | LM339AN |
| LM339ANE4 | Active | Production | PDIP (N) 14 | 25 TUBE | - | Call TI | Call TI | 0 to 70 | |
| LM339ANSR | Active | Production | SOP (NS) 14 | 2000 LARGE T&R | Yes | NIPDAU | Level-1-260C-UNLIM | 0 to 70 | LM339A |
| LM339ANSR.A | Active | Production | SOP (NS) 14 | 2000 LARGE T&R | Yes | NIPDAU | Level-1-260C-UNLIM | 0 to 70 | LM339A |
| LM339APW | Obsolete | Production | TSSOP (PW) 14 | - | - | Call TI | Call TI | 0 to 70 | L339A |
| LM339APWR | Active | Production | TSSOP (PW) 14 | 2000 LARGE T&R | Yes | NIPDAU SN | Level-1-260C-UNLIM | 0 to 70 | L339A |
| LM339APWR.A | Active | Production | TSSOP (PW) 14 | 2000 LARGE T&R | Yes | NIPDAU | Level-1-260C-UNLIM | 0 to 70 | L339A |
| LM339APWRG4 | Active | Production | TSSOP (PW) 14 | 2000 LARGE T&R | Yes | NIPDAU | Level-1-260C-UNLIM | 0 to 70 | L339A |
| LM339APWRG4.A | Active | Production | TSSOP (PW) 14 | 2000 LARGE T&R | Yes | NIPDAU | Level-1-260C-UNLIM | 0 to 70 | L339A |
| LM339BIDR | Active | Production | SOIC (D) 14 | 3000 LARGE T&R | Yes | NIPDAU | Level-1-260C-UNLIM | -40 to 85 | LM339B |
| LM339BIDR.A | Active | Production | SOIC (D) 14 | 3000 LARGE T&R | Yes | NIPDAU | Level-1-260C-UNLIM | -40 to 85 | LM339B |
| LM339BIPWR | Active | Production | TSSOP (PW) 14 | 3000 LARGE T&R | Yes | NIPDAU | Level-1-260C-UNLIM | -40 to 85 | LM339B |
| LM339BIPWR.A | Active | Production | TSSOP (PW) 14 | 3000 LARGE T&R | Yes | NIPDAU | Level-1-260C-UNLIM | -40 to 85 | LM339B |
| LM339BIRTER | Active | Production | WQFN (RTE) 16 | 5000 LARGE T&R | Yes | SN | Level-1-260C-UNLIM | -40 to 85 | LM339B |
| LM339BIRTER.A | Active | Production | WQFN (RTE) 16 | 5000 LARGE T&R | Yes | SN | Level-1-260C-UNLIM | -40 to 85 | LM339B |
| LM339D | Obsolete | Production | SOIC (D) 14 | - | - | Call TI | Call TI | 0 to 70 | LM339 |

| Orderable part number | Status (1) | Material type (2) | Package Pins | Package qty Carrier | RoHS (3) | Lead finish/ Ball material (4) | MSL rating/ Peak reflow (5) | Op temp (°C) | Part marking (6) |
|----------------------------|---------------|----------------------|-----------------|-----------------------|-------------|--------------------------------------|-----------------------------------|--------------|---------------------|
| LM339DBR | Active | Production | SSOP (DB) 14 | 2000 LARGE T&R | Yes | NIPDAU | Level-1-260C-UNLIM | 0 to 70 | LM339 |
| LM339DBR.A | Active | Production | SSOP (DB) 14 | 2000 LARGE T&R | Yes | NIPDAU | Level-1-260C-UNLIM | 0 to 70 | LM339 |
| LM339DR | Active | Production | SOIC (D) 14 | 2500 LARGE T&R | Yes | NIPDAU SN | Level-1-260C-UNLIM | 0 to 70 | LM339 |
| LM339DR.A | Active | Production | SOIC (D) 14 | 2500 LARGE T&R | Yes | NIPDAU | Level-1-260C-UNLIM | 0 to 70 | LM339 |
| LM339DRE4 | Active | Production | SOIC (D) 14 | 2500 LARGE T&R | Yes | NIPDAU | Level-1-260C-UNLIM | 0 to 70 | LM339 |
| LM339DRG3 | Obsolete | Production | SOIC (D) 14 | - | - | Call TI | Call TI | 0 to 70 | LM339 |
| LM339DRG4 | Active | Production | SOIC (D) 14 | 2500 LARGE T&R | Yes | NIPDAU | Level-1-260C-UNLIM | 0 to 70 | LM339 |
| LM339DRG4.A | Active | Production | SOIC (D) 14 | 2500 LARGE T&R | Yes | NIPDAU | Level-1-260C-UNLIM | 0 to 70 | LM339 |
| LM339N | Active | Production | PDIP (N) 14 | 25 TUBE | Yes | NIPDAU SN | N/A for Pkg Type | 0 to 70 | LM339N |
| LM339N.A | Active | Production | PDIP (N) 14 | 25 TUBE | Yes | NIPDAU | N/A for Pkg Type | 0 to 70 | LM339N |
| LM339NE3 | Active | Production | PDIP (N) 14 | 25 TUBE | Yes | SN | N/A for Pkg Type | 0 to 70 | LM339N |
| LM339NE3.A | Active | Production | PDIP (N) 14 | 25 TUBE | Yes | SN | N/A for Pkg Type | 0 to 70 | LM339N |
| LM339NE4 | Active | Production | PDIP (N) 14 | 25 TUBE | Yes | NIPDAU | N/A for Pkg Type | 0 to 70 | LM339N |
| LM339NE4.A | Active | Production | PDIP (N) 14 | 25 TUBE | Yes | NIPDAU | N/A for Pkg Type | 0 to 70 | LM339N |
| LM339NSR | Active | Production | SOP (NS) 14 | 2000 LARGE T&R | Yes | NIPDAU | Level-1-260C-UNLIM | 0 to 70 | LM339 |
| LM339NSR.A | Active | Production | SOP (NS) 14 | 2000 LARGE T&R | Yes | NIPDAU | Level-1-260C-UNLIM | 0 to 70 | LM339 |
| LM339PW | Obsolete | Production | TSSOP (PW) 14 | - | - | Call TI | Call TI | 0 to 70 | L339 |
| LM339PWR | Active | Production | TSSOP (PW) 14 | 2000 LARGE T&R | Yes | NIPDAU SN | Level-1-260C-UNLIM | 0 to 70 | L339 |
| LM339PWR.A | Active | Production | TSSOP (PW) 14 | 2000 LARGE T&R | Yes | NIPDAU | Level-1-260C-UNLIM | 0 to 70 | L339 |
| LM339PWRE4 | Active | Production | TSSOP (PW) 14 | 2000 LARGE T&R | Yes | NIPDAU | Level-1-260C-UNLIM | 0 to 70 | L339 |
| LM339PWRG3 | Active | Production | TSSOP (PW) 14 | 2000 LARGE T&R | Yes | SN | Level-1-260C-UNLIM | 0 to 70 | L339 |
| LM339PWRG3.A | Active | Production | TSSOP (PW) 14 | 2000 LARGE T&R | Yes | SN | Level-1-260C-UNLIM | 0 to 70 | L339 |
| LM339PWRG4 | Active | Production | TSSOP (PW) 14 | 2000 LARGE T&R | Yes | NIPDAU | Level-1-260C-UNLIM | 0 to 70 | L339 |
| LM339PWRG4.A | Active | Production | TSSOP (PW) 14 | 2000 LARGE T&R | Yes | NIPDAU | Level-1-260C-UNLIM | 0 to 70 | L339 |

⁽¹⁾ **Status:** For more details on status, see our [product life cycle](#).

⁽²⁾ **Material type:** When designated, preproduction parts are prototypes/experimental devices, and are not yet approved or released for full production. Testing and final process, including without limitation quality assurance, reliability performance testing, and/or process qualification, may not yet be complete, and this item is subject to further changes or possible discontinuation. If available for ordering, purchases will be subject to an additional waiver at checkout, and are intended for early internal evaluation purposes only. These items are sold without warranties of any kind.

⁽³⁾ **RoHS values:** Yes, No, RoHS Exempt. See the [TI RoHS Statement](#) for additional information and value definition.

(4) **Lead finish/Ball material:** Parts may have multiple material finish options. Finish options are separated by a vertical ruled line. Lead finish/Ball material values may wrap to two lines if the finish value exceeds the maximum column width.

(5) **MSL rating/Peak reflow:** The moisture sensitivity level ratings and peak solder (reflow) temperatures. In the event that a part has multiple moisture sensitivity ratings, only the lowest level per JEDEC standards is shown. Refer to the shipping label for the actual reflow temperature that will be used to mount the part to the printed circuit board.

(6) **Part marking:** There may be an additional marking, which relates to the logo, the lot trace code information, or the environmental category of the part.

Multiple part markings will be inside parentheses. Only one part marking contained in parentheses and separated by a "~" will appear on a part. If a line is indented then it is a continuation of the previous line and the two combined represent the entire part marking for that device.

Important Information and Disclaimer: The information provided on this page represents TI's knowledge and belief as of the date that it is provided. TI bases its knowledge and belief on information provided by third parties, and makes no representation or warranty as to the accuracy of such information. Efforts are underway to better integrate information from third parties. TI has taken and continues to take reasonable steps to provide representative and accurate information but may not have conducted destructive testing or chemical analysis on incoming materials and chemicals. TI and TI suppliers consider certain information to be proprietary, and thus CAS numbers and other limited information may not be available for release.

In no event shall TI's liability arising out of such information exceed the total purchase price of the TI part(s) at issue in this document sold by TI to Customer on an annual basis.

OTHER QUALIFIED VERSIONS OF LM139, LM239A, LM2901, LM2901AV, LM2901B, LM2901V :

- Automotive : [LM239A-Q1](#), [LM2901-Q1](#), [LM2901AV-Q1](#), [LM2901B-Q1](#), [LM2901V-Q1](#)
- Enhanced Product : [LM239A-EP](#)
- Space : [LM139-SP](#)

NOTE: Qualified Version Definitions:

- Automotive - Q100 devices qualified for high-reliability automotive applications targeting zero defects
- Enhanced Product - Supports Defense, Aerospace and Medical Applications
- Space - Radiation tolerant, ceramic packaging and qualified for use in Space-based application

TAPE AND REEL INFORMATION

QUADRANT ASSIGNMENTS FOR PIN 1 ORIENTATION IN TAPE

*All dimensions are nominal

| Device | Package Type | Package Drawing | Pins | SPQ | Reel Diameter (mm) | Reel Width W1 (mm) | A0 (mm) | B0 (mm) | K0 (mm) | P1 (mm) | W (mm) | Pin1 Quadrant |
|----------------|--------------|-----------------|------|------|--------------------|--------------------|---------|---------|---------|---------|--------|---------------|
| LM139ADR | SOIC | D | 14 | 2500 | 330.0 | 16.4 | 6.5 | 9.0 | 2.1 | 8.0 | 16.0 | Q1 |
| LM139DRG4 | SOIC | D | 14 | 2500 | 330.0 | 16.4 | 6.5 | 9.0 | 2.1 | 8.0 | 16.0 | Q1 |
| LM139DR | SOIC | D | 14 | 2500 | 330.0 | 16.4 | 6.5 | 9.0 | 2.1 | 8.0 | 16.0 | Q1 |
| LM139DRG4 | SOIC | D | 14 | 2500 | 330.0 | 16.4 | 6.5 | 9.0 | 2.1 | 8.0 | 16.0 | Q1 |
| LM239ADR | SOIC | D | 14 | 2500 | 330.0 | 16.4 | 6.5 | 9.0 | 2.1 | 8.0 | 16.0 | Q1 |
| LM239DR | SOIC | D | 14 | 2500 | 330.0 | 16.4 | 6.5 | 9.0 | 2.1 | 8.0 | 16.0 | Q1 |
| LM239DR | SOIC | D | 14 | 2500 | 330.0 | 16.4 | 6.5 | 9.0 | 2.1 | 8.0 | 16.0 | Q1 |
| LM239DR | SOIC | D | 14 | 2500 | 330.0 | 16.4 | 6.5 | 9.0 | 2.1 | 8.0 | 16.0 | Q1 |
| LM239PWR | TSSOP | PW | 14 | 2000 | 330.0 | 12.4 | 6.9 | 5.6 | 1.6 | 8.0 | 12.0 | Q1 |
| LM239PWR | TSSOP | PW | 14 | 2000 | 330.0 | 12.4 | 6.9 | 5.6 | 1.6 | 8.0 | 12.0 | Q1 |
| LM239PWR | TSSOP | PW | 14 | 2000 | 330.0 | 12.4 | 6.9 | 5.6 | 1.6 | 8.0 | 12.0 | Q1 |
| LM2901AVQDR | SOIC | D | 14 | 2500 | 330.0 | 16.4 | 6.5 | 9.0 | 2.1 | 8.0 | 16.0 | Q1 |
| LM2901AVQDRG4 | SOIC | D | 14 | 2500 | 330.0 | 16.4 | 6.5 | 9.0 | 2.1 | 8.0 | 16.0 | Q1 |
| LM2901AVQPWR | TSSOP | PW | 14 | 2000 | 330.0 | 12.4 | 6.9 | 5.6 | 1.6 | 8.0 | 12.0 | Q1 |
| LM2901AVQPWR | TSSOP | PW | 14 | 2000 | 330.0 | 12.4 | 6.9 | 5.6 | 1.6 | 8.0 | 12.0 | Q1 |
| LM2901AVQPWRG4 | TSSOP | PW | 14 | 2000 | 330.0 | 12.4 | 6.9 | 5.6 | 1.6 | 8.0 | 12.0 | Q1 |

| Device | Package Type | Package Drawing | Pins | SPQ | Reel Diameter (mm) | Reel Width W1 (mm) | A0 (mm) | B0 (mm) | K0 (mm) | P1 (mm) | W (mm) | Pin1 Quadrant |
|----------------|--------------|-----------------|------|------|--------------------|--------------------|---------|---------|---------|---------|--------|---------------|
| LM2901AVQPWRG4 | TSSOP | PW | 14 | 2000 | 330.0 | 12.4 | 6.9 | 5.6 | 1.6 | 8.0 | 12.0 | Q1 |
| LM2901BIDR | SOIC | D | 14 | 3000 | 330.0 | 16.4 | 6.5 | 9.0 | 2.1 | 8.0 | 16.0 | Q1 |
| LM2901BIDR | SOIC | D | 14 | 3000 | 330.0 | 16.4 | 6.5 | 9.0 | 2.1 | 8.0 | 16.0 | Q1 |
| LM2901BIPWR | TSSOP | PW | 14 | 3000 | 330.0 | 12.4 | 6.9 | 5.6 | 1.6 | 8.0 | 12.0 | Q1 |
| LM2901BIRTER | WQFN | RTE | 16 | 5000 | 330.0 | 12.4 | 3.3 | 3.3 | 1.1 | 8.0 | 12.0 | Q2 |
| LM2901DR | SOIC | D | 14 | 2500 | 330.0 | 16.4 | 6.5 | 9.0 | 2.1 | 8.0 | 16.0 | Q1 |
| LM2901DR | SOIC | D | 14 | 2500 | 330.0 | 16.4 | 6.5 | 9.0 | 2.1 | 8.0 | 16.0 | Q1 |
| LM2901DRG3 | SOIC | D | 14 | 2500 | 330.0 | 16.8 | 6.5 | 9.5 | 2.1 | 8.0 | 16.0 | Q1 |
| LM2901DRG4 | SOIC | D | 14 | 2500 | 330.0 | 16.4 | 6.5 | 9.0 | 2.1 | 8.0 | 16.0 | Q1 |
| LM2901DRG4 | SOIC | D | 14 | 2500 | 330.0 | 16.4 | 6.5 | 9.0 | 2.1 | 8.0 | 16.0 | Q1 |
| LM2901NSR | SOP | NS | 14 | 2000 | 330.0 | 16.4 | 8.1 | 10.4 | 2.5 | 12.0 | 16.0 | Q1 |
| LM2901PWR | TSSOP | PW | 14 | 2000 | 330.0 | 12.4 | 6.9 | 5.6 | 1.6 | 8.0 | 12.0 | Q1 |
| LM2901PWR | TSSOP | PW | 14 | 2000 | 330.0 | 12.4 | 6.9 | 5.6 | 1.6 | 8.0 | 12.0 | Q1 |
| LM2901PWR | TSSOP | PW | 14 | 2000 | 330.0 | 12.4 | 6.9 | 5.6 | 1.6 | 8.0 | 12.0 | Q1 |
| LM2901PWRG3 | TSSOP | PW | 14 | 2000 | 330.0 | 12.4 | 6.9 | 5.6 | 1.6 | 8.0 | 12.0 | Q1 |
| LM2901PWRG4 | TSSOP | PW | 14 | 2000 | 330.0 | 12.4 | 6.9 | 5.6 | 1.6 | 8.0 | 12.0 | Q1 |
| LM2901PWRG4 | TSSOP | PW | 14 | 2000 | 330.0 | 12.4 | 6.9 | 5.6 | 1.6 | 8.0 | 12.0 | Q1 |
| LM2901VQDR | SOIC | D | 14 | 2500 | 330.0 | 16.4 | 6.5 | 9.0 | 2.1 | 8.0 | 16.0 | Q1 |
| LM2901VQPWR | TSSOP | PW | 14 | 2000 | 330.0 | 12.4 | 6.9 | 5.6 | 1.6 | 8.0 | 12.0 | Q1 |
| LM2901VQPWR | TSSOP | PW | 14 | 2000 | 330.0 | 12.4 | 6.9 | 5.6 | 1.6 | 8.0 | 12.0 | Q1 |
| LM2901VQPWRG4 | TSSOP | PW | 14 | 2000 | 330.0 | 12.4 | 6.9 | 5.6 | 1.6 | 8.0 | 12.0 | Q1 |
| LM2901VQPWRG4 | TSSOP | PW | 14 | 2000 | 330.0 | 12.4 | 6.9 | 5.6 | 1.6 | 8.0 | 12.0 | Q1 |
| LM339ADBR | SSOP | DB | 14 | 2000 | 330.0 | 16.4 | 8.35 | 6.6 | 2.4 | 12.0 | 16.0 | Q1 |
| LM339ADR | SOIC | D | 14 | 2500 | 330.0 | 16.4 | 6.5 | 9.0 | 2.1 | 8.0 | 16.0 | Q1 |
| LM339ANSR | SOP | NS | 14 | 2000 | 330.0 | 16.4 | 8.1 | 10.4 | 2.5 | 12.0 | 16.0 | Q1 |
| LM339APWR | TSSOP | PW | 14 | 2000 | 330.0 | 12.4 | 6.9 | 5.6 | 1.6 | 8.0 | 12.0 | Q1 |
| LM339APWR | TSSOP | PW | 14 | 2000 | 330.0 | 12.4 | 6.9 | 5.6 | 1.6 | 8.0 | 12.0 | Q1 |
| LM339APWR | TSSOP | PW | 14 | 2000 | 330.0 | 12.4 | 6.9 | 5.6 | 1.6 | 8.0 | 12.0 | Q1 |
| LM339APWRG4 | TSSOP | PW | 14 | 2000 | 330.0 | 12.4 | 6.9 | 5.6 | 1.6 | 8.0 | 12.0 | Q1 |
| LM339APWRG4 | TSSOP | PW | 14 | 2000 | 330.0 | 12.4 | 6.9 | 5.6 | 1.6 | 8.0 | 12.0 | Q1 |
| LM339BIDR | SOIC | D | 14 | 3000 | 330.0 | 16.4 | 6.5 | 9.0 | 2.1 | 8.0 | 16.0 | Q1 |
| LM339BIDR | SOIC | D | 14 | 3000 | 330.0 | 16.4 | 6.5 | 9.0 | 2.1 | 8.0 | 16.0 | Q1 |
| LM339BIPWR | TSSOP | PW | 14 | 3000 | 330.0 | 12.4 | 6.9 | 5.6 | 1.6 | 8.0 | 12.0 | Q1 |
| LM339BIRTER | WQFN | RTE | 16 | 5000 | 330.0 | 12.4 | 3.3 | 3.3 | 1.1 | 8.0 | 12.0 | Q2 |
| LM339DBR | SSOP | DB | 14 | 2000 | 330.0 | 16.4 | 8.35 | 6.6 | 2.4 | 12.0 | 16.0 | Q1 |
| LM339DR | SOIC | D | 14 | 2500 | 330.0 | 16.4 | 6.5 | 9.0 | 2.1 | 8.0 | 16.0 | Q1 |
| LM339DR | SOIC | D | 14 | 2500 | 330.0 | 16.4 | 6.5 | 9.0 | 2.1 | 8.0 | 16.0 | Q1 |
| LM339DRG4 | SOIC | D | 14 | 2500 | 330.0 | 16.4 | 6.5 | 9.0 | 2.1 | 8.0 | 16.0 | Q1 |
| LM339DRG4 | SOIC | D | 14 | 2500 | 330.0 | 16.4 | 6.5 | 9.0 | 2.1 | 8.0 | 16.0 | Q1 |
| LM339NSR | SOP | NS | 14 | 2000 | 330.0 | 16.4 | 8.1 | 10.4 | 2.5 | 12.0 | 16.0 | Q1 |
| LM339PWR | TSSOP | PW | 14 | 2000 | 330.0 | 12.4 | 6.9 | 5.6 | 1.6 | 8.0 | 12.0 | Q1 |

| Device | Package Type | Package Drawing | Pins | SPQ | Reel Diameter (mm) | Reel Width W1 (mm) | A0 (mm) | B0 (mm) | K0 (mm) | P1 (mm) | W (mm) | Pin1 Quadrant |
|------------|--------------|-----------------|------|------|--------------------|--------------------|---------|---------|---------|---------|--------|---------------|
| LM339PWR | TSSOP | PW | 14 | 2000 | 330.0 | 12.4 | 6.9 | 5.6 | 1.6 | 8.0 | 12.0 | Q1 |
| LM339PWR | TSSOP | PW | 14 | 2000 | 330.0 | 12.4 | 6.9 | 5.6 | 1.6 | 8.0 | 12.0 | Q1 |
| LM339PWRG3 | TSSOP | PW | 14 | 2000 | 330.0 | 12.4 | 6.9 | 5.6 | 1.6 | 8.0 | 12.0 | Q1 |
| LM339PWRG4 | TSSOP | PW | 14 | 2000 | 330.0 | 12.4 | 6.9 | 5.6 | 1.6 | 8.0 | 12.0 | Q1 |

TAPE AND REEL BOX DIMENSIONS

*All dimensions are nominal

| Device | Package Type | Package Drawing | Pins | SPQ | Length (mm) | Width (mm) | Height (mm) |
|----------------|--------------|-----------------|------|------|-------------|------------|-------------|
| LM139ADR | SOIC | D | 14 | 2500 | 353.0 | 353.0 | 32.0 |
| LM139ADRG4 | SOIC | D | 14 | 2500 | 353.0 | 353.0 | 32.0 |
| LM139DR | SOIC | D | 14 | 2500 | 353.0 | 353.0 | 32.0 |
| LM139DRG4 | SOIC | D | 14 | 2500 | 353.0 | 353.0 | 32.0 |
| LM239ADR | SOIC | D | 14 | 2500 | 353.0 | 353.0 | 32.0 |
| LM239DR | SOIC | D | 14 | 2500 | 353.0 | 353.0 | 32.0 |
| LM239DR | SOIC | D | 14 | 2500 | 353.0 | 353.0 | 32.0 |
| LM239DR | SOIC | D | 14 | 2500 | 353.0 | 353.0 | 32.0 |
| LM239PWR | TSSOP | PW | 14 | 2000 | 353.0 | 353.0 | 32.0 |
| LM239PWR | TSSOP | PW | 14 | 2000 | 356.0 | 356.0 | 35.0 |
| LM239PWR | TSSOP | PW | 14 | 2000 | 353.0 | 353.0 | 32.0 |
| LM2901AVQDR | SOIC | D | 14 | 2500 | 353.0 | 353.0 | 32.0 |
| LM2901AVQDRG4 | SOIC | D | 14 | 2500 | 353.0 | 353.0 | 32.0 |
| LM2901AVQPWR | TSSOP | PW | 14 | 2000 | 353.0 | 353.0 | 32.0 |
| LM2901AVQPWR | TSSOP | PW | 14 | 2000 | 353.0 | 353.0 | 32.0 |
| LM2901AVQPWRG4 | TSSOP | PW | 14 | 2000 | 353.0 | 353.0 | 32.0 |
| LM2901AVQPWRG4 | TSSOP | PW | 14 | 2000 | 353.0 | 353.0 | 32.0 |
| LM2901BIDR | SOIC | D | 14 | 3000 | 353.0 | 353.0 | 32.0 |

| Device | Package Type | Package Drawing | Pins | SPQ | Length (mm) | Width (mm) | Height (mm) |
|---------------|--------------|-----------------|------|------|-------------|------------|-------------|
| LM2901BIDR | SOIC | D | 14 | 3000 | 353.0 | 353.0 | 32.0 |
| LM2901BIPWR | TSSOP | PW | 14 | 3000 | 353.0 | 353.0 | 32.0 |
| LM2901BIRTER | WQFN | RTE | 16 | 5000 | 367.0 | 367.0 | 35.0 |
| LM2901DR | SOIC | D | 14 | 2500 | 353.0 | 353.0 | 32.0 |
| LM2901DR | SOIC | D | 14 | 2500 | 353.0 | 353.0 | 32.0 |
| LM2901DRG3 | SOIC | D | 14 | 2500 | 364.0 | 364.0 | 27.0 |
| LM2901DRG4 | SOIC | D | 14 | 2500 | 353.0 | 353.0 | 32.0 |
| LM2901DRG4 | SOIC | D | 14 | 2500 | 353.0 | 353.0 | 32.0 |
| LM2901NSR | SOP | NS | 14 | 2000 | 353.0 | 353.0 | 32.0 |
| LM2901PWR | TSSOP | PW | 14 | 2000 | 353.0 | 353.0 | 32.0 |
| LM2901PWR | TSSOP | PW | 14 | 2000 | 356.0 | 356.0 | 35.0 |
| LM2901PWR | TSSOP | PW | 14 | 2000 | 353.0 | 353.0 | 32.0 |
| LM2901PWRG3 | TSSOP | PW | 14 | 2000 | 364.0 | 364.0 | 27.0 |
| LM2901PWRG4 | TSSOP | PW | 14 | 2000 | 353.0 | 353.0 | 32.0 |
| LM2901PWRG4 | TSSOP | PW | 14 | 2000 | 353.0 | 353.0 | 32.0 |
| LM2901VQDR | SOIC | D | 14 | 2500 | 353.0 | 353.0 | 32.0 |
| LM2901VQPWR | TSSOP | PW | 14 | 2000 | 353.0 | 353.0 | 32.0 |
| LM2901VQPWR | TSSOP | PW | 14 | 2000 | 353.0 | 353.0 | 32.0 |
| LM2901VQPWRG4 | TSSOP | PW | 14 | 2000 | 353.0 | 353.0 | 32.0 |
| LM2901VQPWRG4 | TSSOP | PW | 14 | 2000 | 353.0 | 353.0 | 32.0 |
| LM339ADBR | SSOP | DB | 14 | 2000 | 353.0 | 353.0 | 32.0 |
| LM339ADR | SOIC | D | 14 | 2500 | 353.0 | 353.0 | 32.0 |
| LM339ANSR | SOP | NS | 14 | 2000 | 353.0 | 353.0 | 32.0 |
| LM339APWR | TSSOP | PW | 14 | 2000 | 353.0 | 353.0 | 32.0 |
| LM339APWR | TSSOP | PW | 14 | 2000 | 353.0 | 353.0 | 32.0 |
| LM339APWR | TSSOP | PW | 14 | 2000 | 356.0 | 356.0 | 35.0 |
| LM339APWRG4 | TSSOP | PW | 14 | 2000 | 353.0 | 353.0 | 32.0 |
| LM339APWRG4 | TSSOP | PW | 14 | 2000 | 353.0 | 353.0 | 32.0 |
| LM339BIDR | SOIC | D | 14 | 3000 | 353.0 | 353.0 | 32.0 |
| LM339BIDR | SOIC | D | 14 | 3000 | 353.0 | 353.0 | 32.0 |
| LM339BIPWR | TSSOP | PW | 14 | 3000 | 353.0 | 353.0 | 32.0 |
| LM339BIRTER | WQFN | RTE | 16 | 5000 | 367.0 | 367.0 | 35.0 |
| LM339DBR | SSOP | DB | 14 | 2000 | 353.0 | 353.0 | 32.0 |
| LM339DR | SOIC | D | 14 | 2500 | 353.0 | 353.0 | 32.0 |
| LM339DR | SOIC | D | 14 | 2500 | 353.0 | 353.0 | 32.0 |
| LM339DRG4 | SOIC | D | 14 | 2500 | 353.0 | 353.0 | 32.0 |
| LM339DRG4 | SOIC | D | 14 | 2500 | 353.0 | 353.0 | 32.0 |
| LM339NSR | SOP | NS | 14 | 2000 | 353.0 | 353.0 | 32.0 |
| LM339PWR | TSSOP | PW | 14 | 2000 | 353.0 | 353.0 | 32.0 |
| LM339PWR | TSSOP | PW | 14 | 2000 | 356.0 | 356.0 | 35.0 |
| LM339PWR | TSSOP | PW | 14 | 2000 | 353.0 | 353.0 | 32.0 |
| LM339PWRG3 | TSSOP | PW | 14 | 2000 | 364.0 | 364.0 | 27.0 |
| LM339PWRG4 | TSSOP | PW | 14 | 2000 | 353.0 | 353.0 | 32.0 |

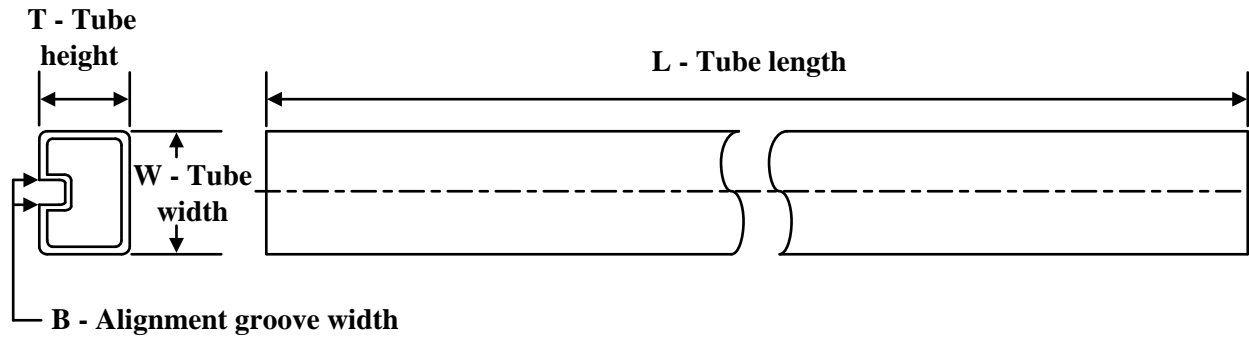
TUBE

*All dimensions are nominal

| Device | Package Name | Package Type | Pins | SPQ | L (mm) | W (mm) | T (µm) | B (mm) |
|------------|--------------|--------------|------|-----|--------|--------|--------|--------|
| LM239N | N | PDIP | 14 | 25 | 506 | 13.97 | 11230 | 4.32 |
| LM239N | N | PDIP | 14 | 25 | 506 | 13.97 | 11230 | 4.32 |
| LM239N | N | PDIP | 14 | 25 | 506.1 | 9 | 600 | 5.4 |
| LM239N.A | N | PDIP | 14 | 25 | 506 | 13.97 | 11230 | 4.32 |
| LM239N.A | N | PDIP | 14 | 25 | 506 | 13.97 | 11230 | 4.32 |
| LM239N.A | N | PDIP | 14 | 25 | 506.1 | 9 | 600 | 5.4 |
| LM2901N | N | PDIP | 14 | 25 | 506 | 13.97 | 11230 | 4.32 |
| LM2901N | N | PDIP | 14 | 25 | 506 | 13.97 | 11230 | 4.32 |
| LM2901N.A | N | PDIP | 14 | 25 | 506 | 13.97 | 11230 | 4.32 |
| LM2901N.A | N | PDIP | 14 | 25 | 506 | 13.97 | 11230 | 4.32 |
| LM2901N.A | N | PDIP | 14 | 25 | 506 | 13.97 | 11230 | 4.32 |
| LM339AN | N | PDIP | 14 | 25 | 506 | 13.97 | 11230 | 4.32 |
| LM339AN | N | PDIP | 14 | 25 | 506 | 13.97 | 11230 | 4.32 |
| LM339AN | N | PDIP | 14 | 25 | 506.1 | 9 | 600 | 5.4 |
| LM339AN.A | N | PDIP | 14 | 25 | 506 | 13.97 | 11230 | 4.32 |
| LM339AN.A | N | PDIP | 14 | 25 | 506.1 | 9 | 600 | 5.4 |
| LM339AN.A | N | PDIP | 14 | 25 | 506 | 13.97 | 11230 | 4.32 |
| LM339N | N | PDIP | 14 | 25 | 506 | 13.97 | 11230 | 4.32 |
| LM339N | N | PDIP | 14 | 25 | 506 | 13.97 | 11230 | 4.32 |
| LM339N | N | PDIP | 14 | 25 | 506 | 13.97 | 11230 | 4.32 |
| LM339N | N | PDIP | 14 | 25 | 506.1 | 9 | 600 | 5.4 |
| LM339N.A | N | PDIP | 14 | 25 | 506 | 13.97 | 11230 | 4.32 |
| LM339N.A | N | PDIP | 14 | 25 | 506 | 13.97 | 11230 | 4.32 |
| LM339N.A | N | PDIP | 14 | 25 | 506.1 | 9 | 600 | 5.4 |
| LM339N.A | N | PDIP | 14 | 25 | 506 | 13.97 | 11230 | 4.32 |
| LM339N.A | N | PDIP | 14 | 25 | 506 | 13.97 | 11230 | 4.32 |
| LM339N.A | N | PDIP | 14 | 25 | 506.1 | 9 | 600 | 5.4 |
| LM339N.A | N | PDIP | 14 | 25 | 506 | 13.97 | 11230 | 4.32 |
| LM339NE3 | N | PDIP | 14 | 25 | 506.1 | 9 | 600 | 5.4 |
| LM339NE3.A | N | PDIP | 14 | 25 | 506.1 | 9 | 600 | 5.4 |
| LM339NE4 | N | PDIP | 14 | 25 | 506 | 13.97 | 11230 | 4.32 |
| LM339NE4 | N | PDIP | 14 | 25 | 506 | 13.97 | 11230 | 4.32 |
| LM339NE4.A | N | PDIP | 14 | 25 | 506 | 13.97 | 11230 | 4.32 |

| Device | Package Name | Package Type | Pins | SPQ | L (mm) | W (mm) | T (μm) | B (mm) |
|------------|--------------|--------------|------|-----|--------|--------|--------|--------|
| LM339NE4.A | N | PDIP | 14 | 25 | 506 | 13.97 | 11230 | 4.32 |

GENERIC PACKAGE VIEW

RTE 16

WQFN - 0.8 mm max height

3 x 3, 0.5 mm pitch

PLASTIC QUAD FLATPACK - NO LEAD

This image is a representation of the package family, actual package may vary.
Refer to the product data sheet for package details.

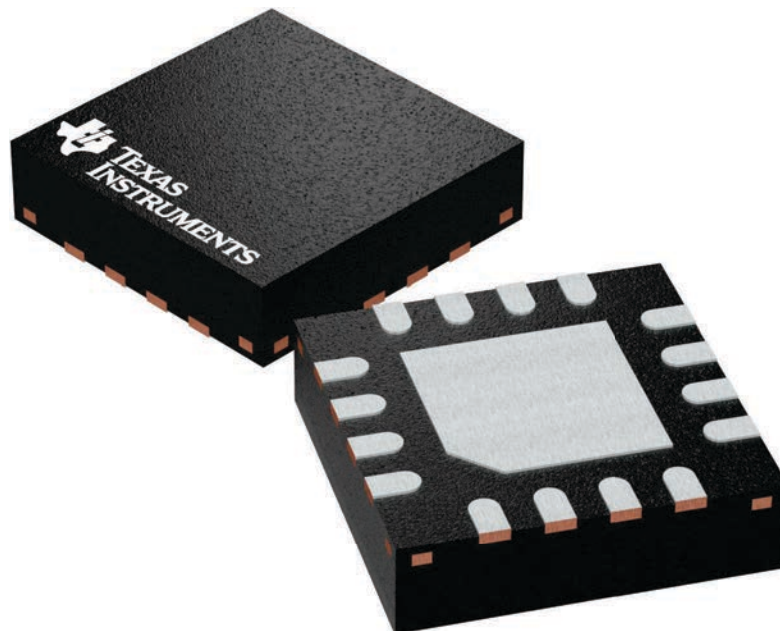

4225944/A

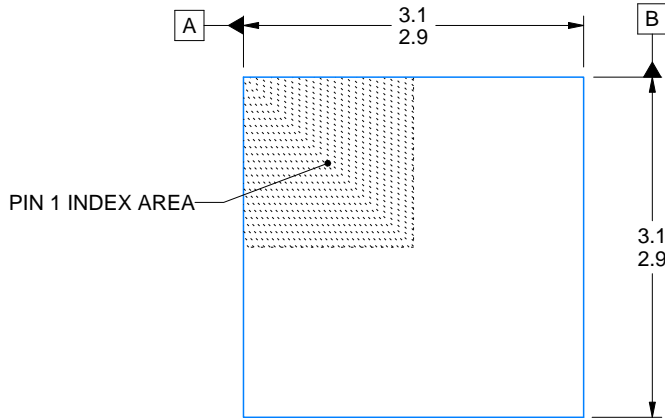

| SIDE WALL METAL THICKNESS DIM A | |
|---------------------------------|----------|
| OPTION 1 | OPTION 2 |
| 0.1 | 0.2 |

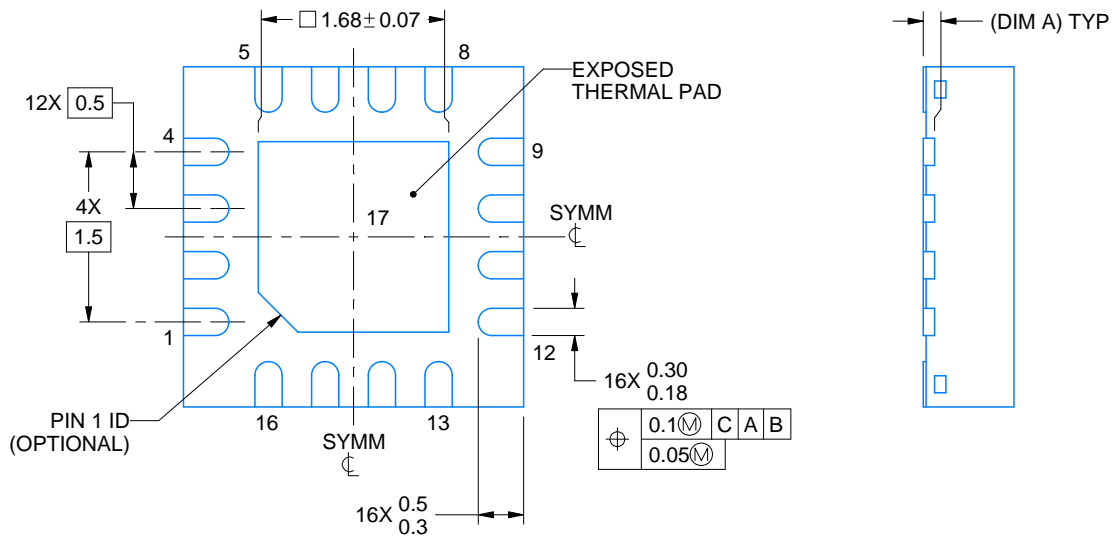
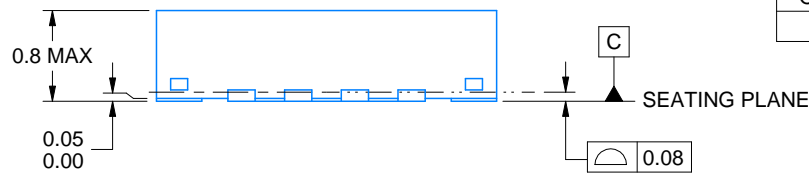

4219117/B 04/2022

NOTES:

1. All linear dimensions are in millimeters. Any dimensions in parenthesis are for reference only. Dimensioning and tolerancing per ASME Y14.5M.
2. This drawing is subject to change without notice.
3. The package thermal pad must be soldered to the printed circuit board for thermal and mechanical performance.

EXAMPLE STENCIL DESIGN

RTE0016C

WQFN - 0.8 mm max height

PLASTIC QUAD FLATPACK - NO LEAD

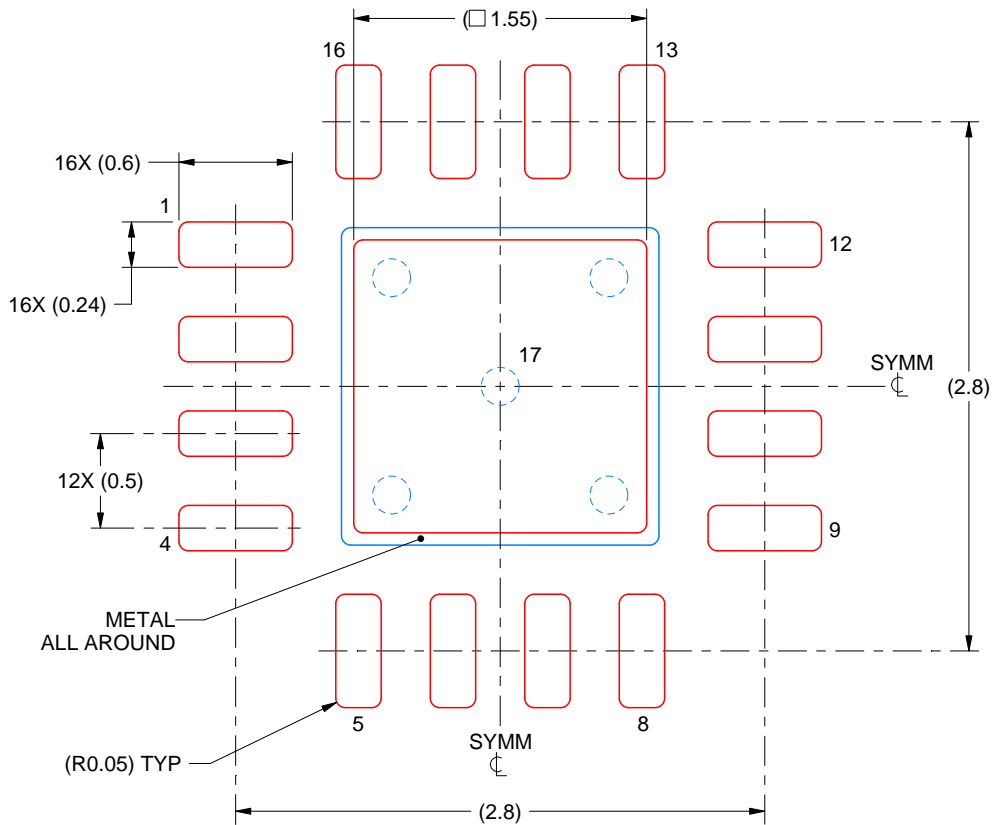

SOLDER PASTE EXAMPLE
BASED ON 0.125 mm THICK STENCIL

EXPOSED PAD 17:
85% PRINTED SOLDER COVERAGE BY AREA UNDER PACKAGE
SCALE:25X

4219117/B 04/2022

NOTES: (continued)

6. Laser cutting apertures with trapezoidal walls and rounded corners may offer better paste release. IPC-7525 may have alternate design recommendations.

EXAMPLE BOARD LAYOUT

DB0014A

SSOP - 2 mm max height

SMALL OUTLINE PACKAGE

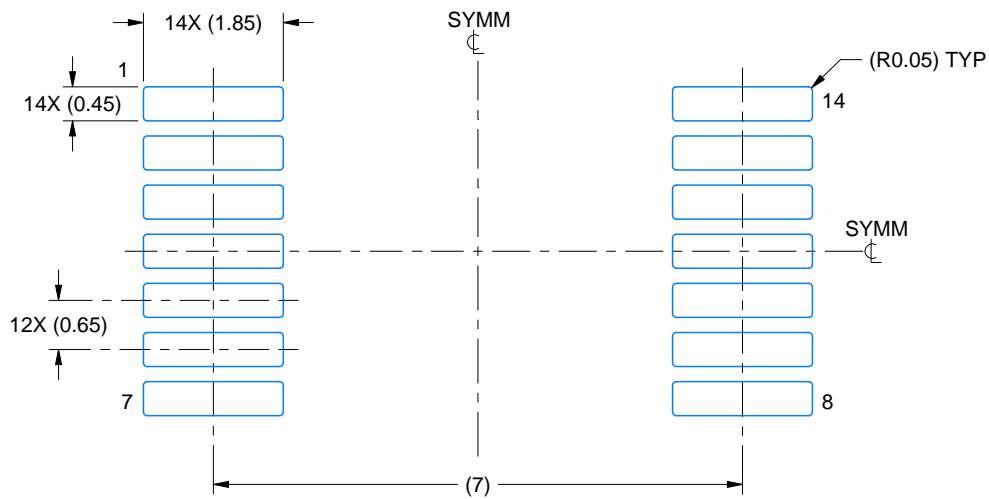

LAND PATTERN EXAMPLE
EXPOSED METAL SHOWN
SCALE: 10X

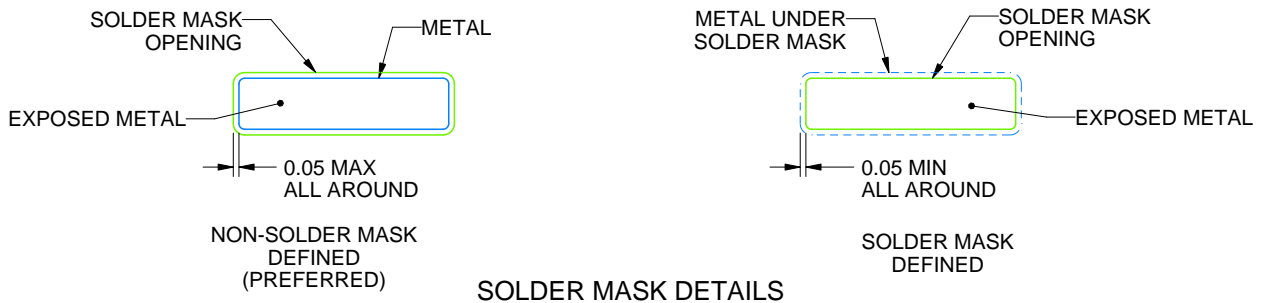

4220762/A 05/2024

NOTES: (continued)

- 5. Publication IPC-7351 may have alternate designs.
- 6. Solder mask tolerances between and around signal pads can vary based on board fabrication site.

EXAMPLE STENCIL DESIGN

DB0014A

SSOP - 2 mm max height

SMALL OUTLINE PACKAGE

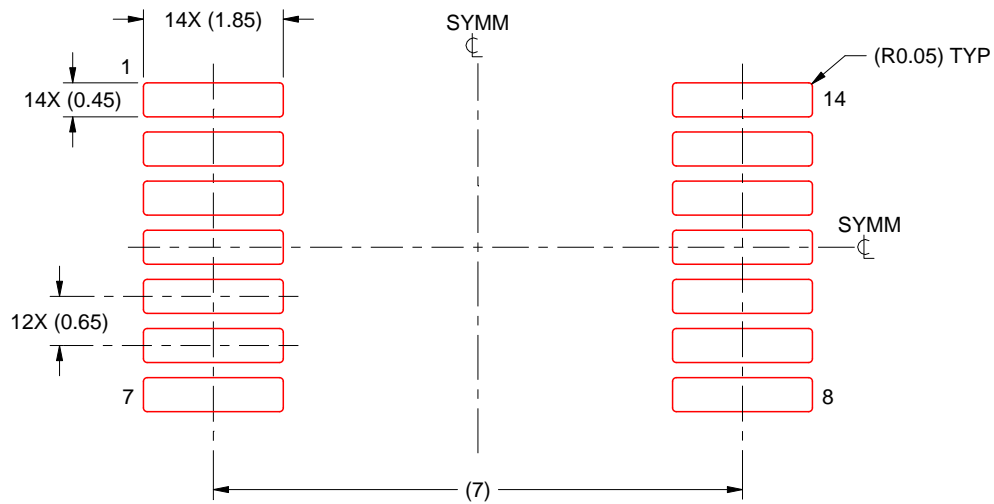

SOLDER PASTE EXAMPLE
BASED ON 0.125 mm THICK STENCIL
SCALE: 10X

4220762/A 05/2024

NOTES: (continued)

7. Laser cutting apertures with trapezoidal walls and rounded corners may offer better paste release. IPC-7525 may have alternate design recommendations.
8. Board assembly site may have different recommendations for stencil design.

N (R-PDIP-T**)

PLASTIC DUAL-IN-LINE PACKAGE

16 PINS SHOWN



- NOTES:
- A. All linear dimensions are in inches (millimeters).
 - B. This drawing is subject to change without notice.
 - Falls within JEDEC MS-001, except 18 and 20 pin minimum body length (Dim A).
 - The 20 pin end lead shoulder width is a vendor option, either half or full width.

PW0014A

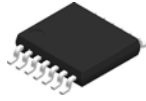

PACKAGE OUTLINE

TSSOP - 1.2 mm max height

SMALL OUTLINE PACKAGE

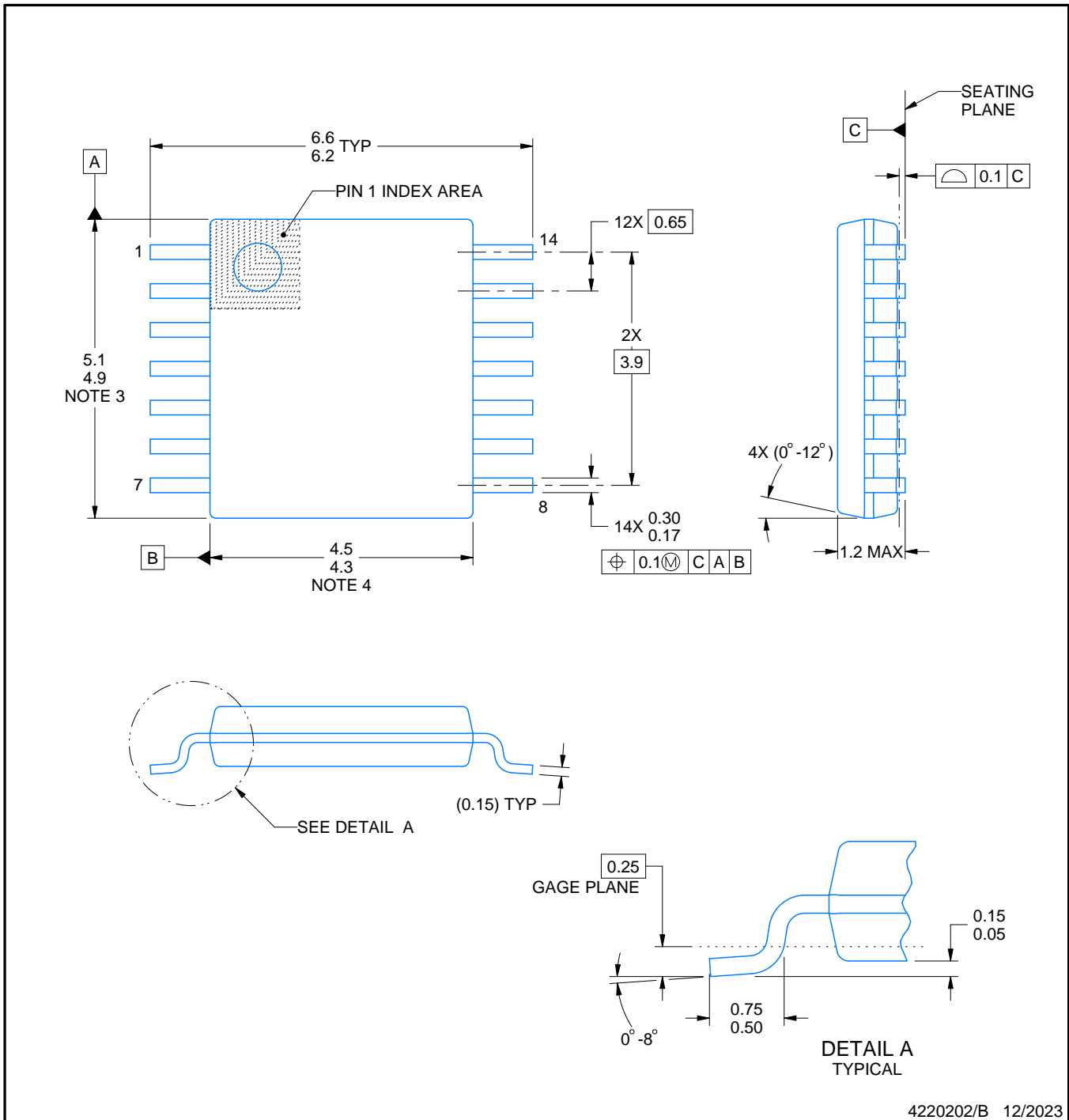

4220202/B 12/2023

NOTES:

1. All linear dimensions are in millimeters. Any dimensions in parenthesis are for reference only. Dimensioning and tolerancing per ASME Y14.5M.
2. This drawing is subject to change without notice.
3. This dimension does not include mold flash, protrusions, or gate burrs. Mold flash, protrusions, or gate burrs shall not exceed 0.15 mm per side.
4. This dimension does not include interlead flash. Interlead flash shall not exceed 0.25 mm per side.
5. Reference JEDEC registration MO-153.

EXAMPLE BOARD LAYOUT

PW0014A

TSSOP - 1.2 mm max height

SMALL OUTLINE PACKAGE

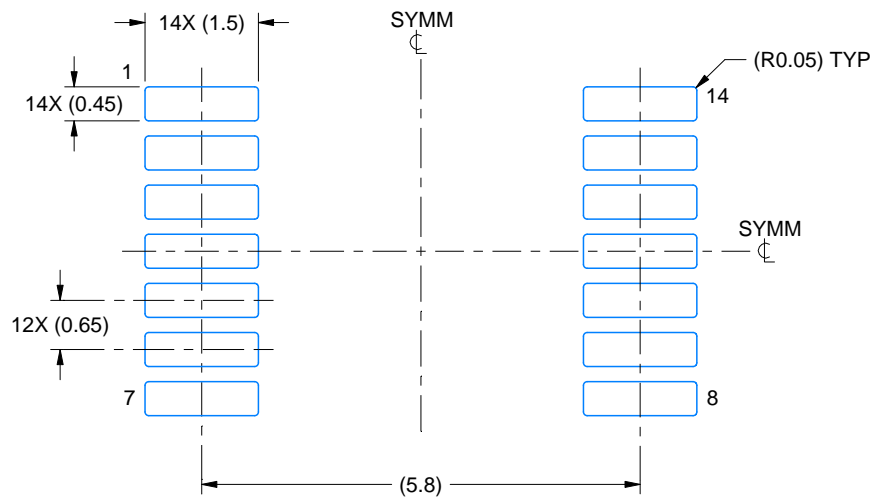

LAND PATTERN EXAMPLE
EXPOSED METAL SHOWN
SCALE: 10X

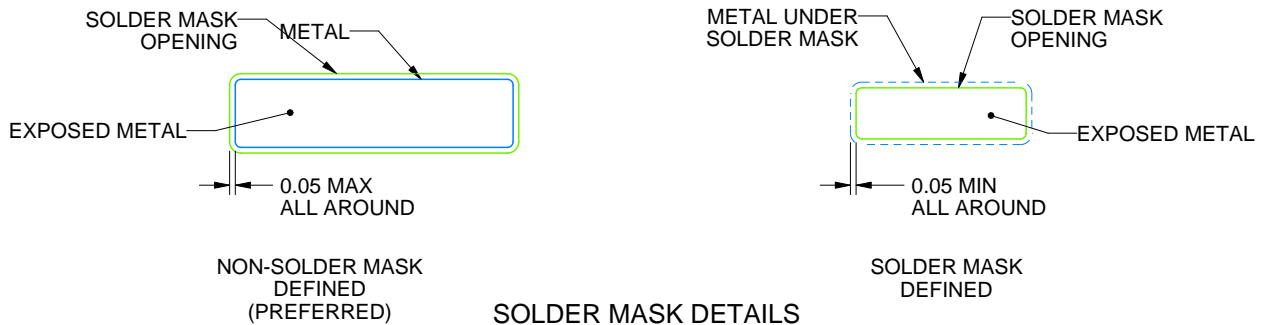

4220202/B 12/2023

NOTES: (continued)

- 6. Publication IPC-7351 may have alternate designs.
- 7. Solder mask tolerances between and around signal pads can vary based on board fabrication site.

EXAMPLE STENCIL DESIGN

PW0014A

TSSOP - 1.2 mm max height

SMALL OUTLINE PACKAGE



SOLDER PASTE EXAMPLE
BASED ON 0.125 mm THICK STENCIL
SCALE: 10X

4220202/B 12/2023

NOTES: (continued)

8. Laser cutting apertures with trapezoidal walls and rounded corners may offer better paste release. IPC-7525 may have alternate design recommendations.
9. Board assembly site may have different recommendations for stencil design.

D0014A

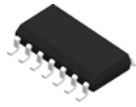

PACKAGE OUTLINE

SOIC - 1.75 mm max height

SMALL OUTLINE INTEGRATED CIRCUIT

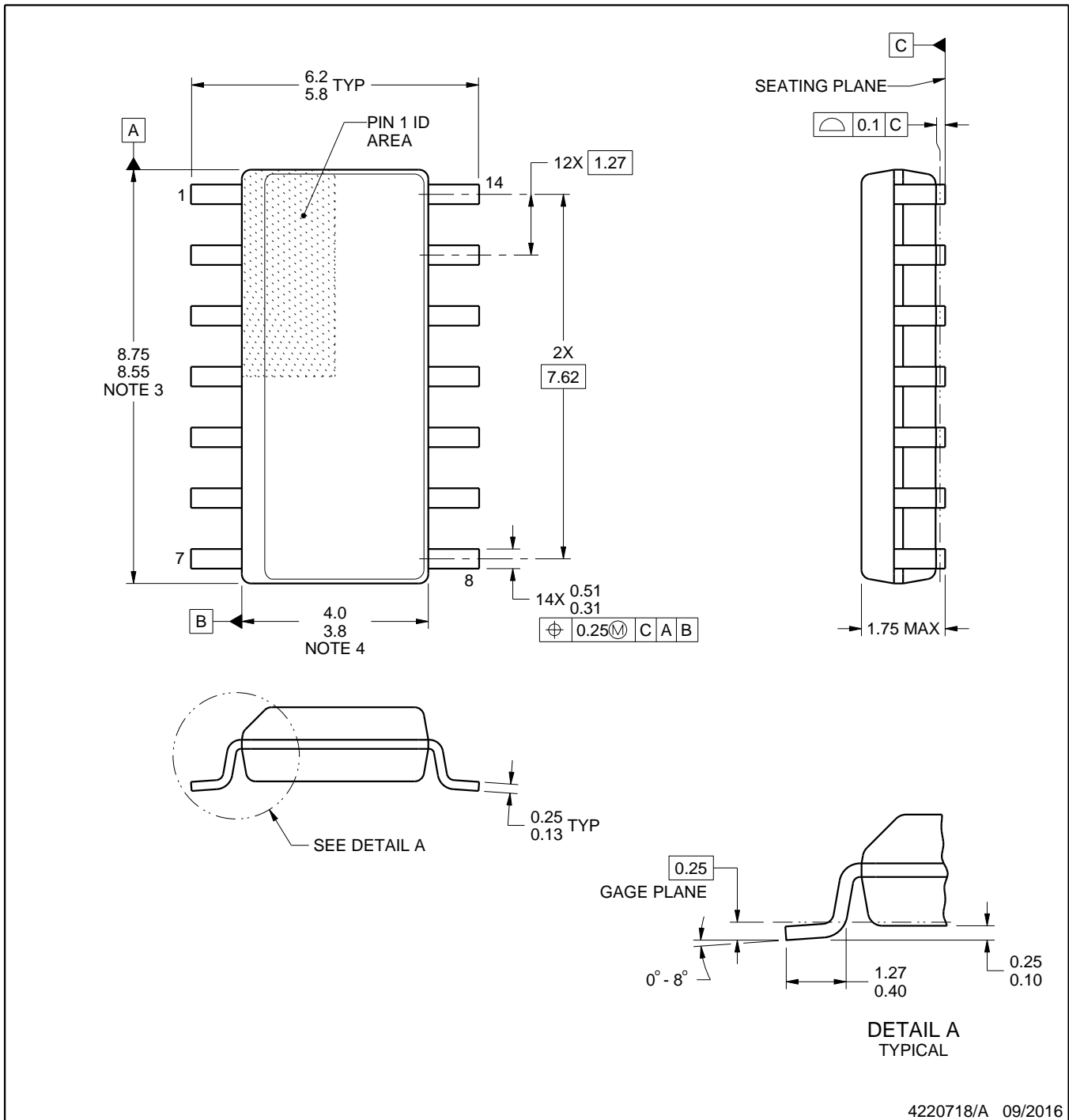

4220718/A 09/2016

NOTES:

1. All linear dimensions are in millimeters. Dimensions in parenthesis are for reference only. Dimensioning and tolerancing per ASME Y14.5M.
2. This drawing is subject to change without notice.
3. This dimension does not include mold flash, protrusions, or gate burrs. Mold flash, protrusions, or gate burrs shall not exceed 0.15 mm, per side.
4. This dimension does not include interlead flash. Interlead flash shall not exceed 0.43 mm, per side.
5. Reference JEDEC registration MS-012, variation AB.

EXAMPLE BOARD LAYOUT

D0014A

SOIC - 1.75 mm max height

SMALL OUTLINE INTEGRATED CIRCUIT



LAND PATTERN EXAMPLE
SCALE:8X



SOLDER MASK DETAILS

4220718/A 09/2016

NOTES: (continued)

- 6. Publication IPC-7351 may have alternate designs.
- 7. Solder mask tolerances between and around signal pads can vary based on board fabrication site.

EXAMPLE STENCIL DESIGN

D0014A

SOIC - 1.75 mm max height

SMALL OUTLINE INTEGRATED CIRCUIT



SOLDER PASTE EXAMPLE
BASED ON 0.125 mm THICK STENCIL
SCALE:8X

4220718/A 09/2016

NOTES: (continued)

8. Laser cutting apertures with trapezoidal walls and rounded corners may offer better paste release. IPC-7525 may have alternate design recommendations.
9. Board assembly site may have different recommendations for stencil design.

MECHANICAL DATA

NS (R-PDSO-G**)

PLASTIC SMALL-OUTLINE PACKAGE

14-PINS SHOWN

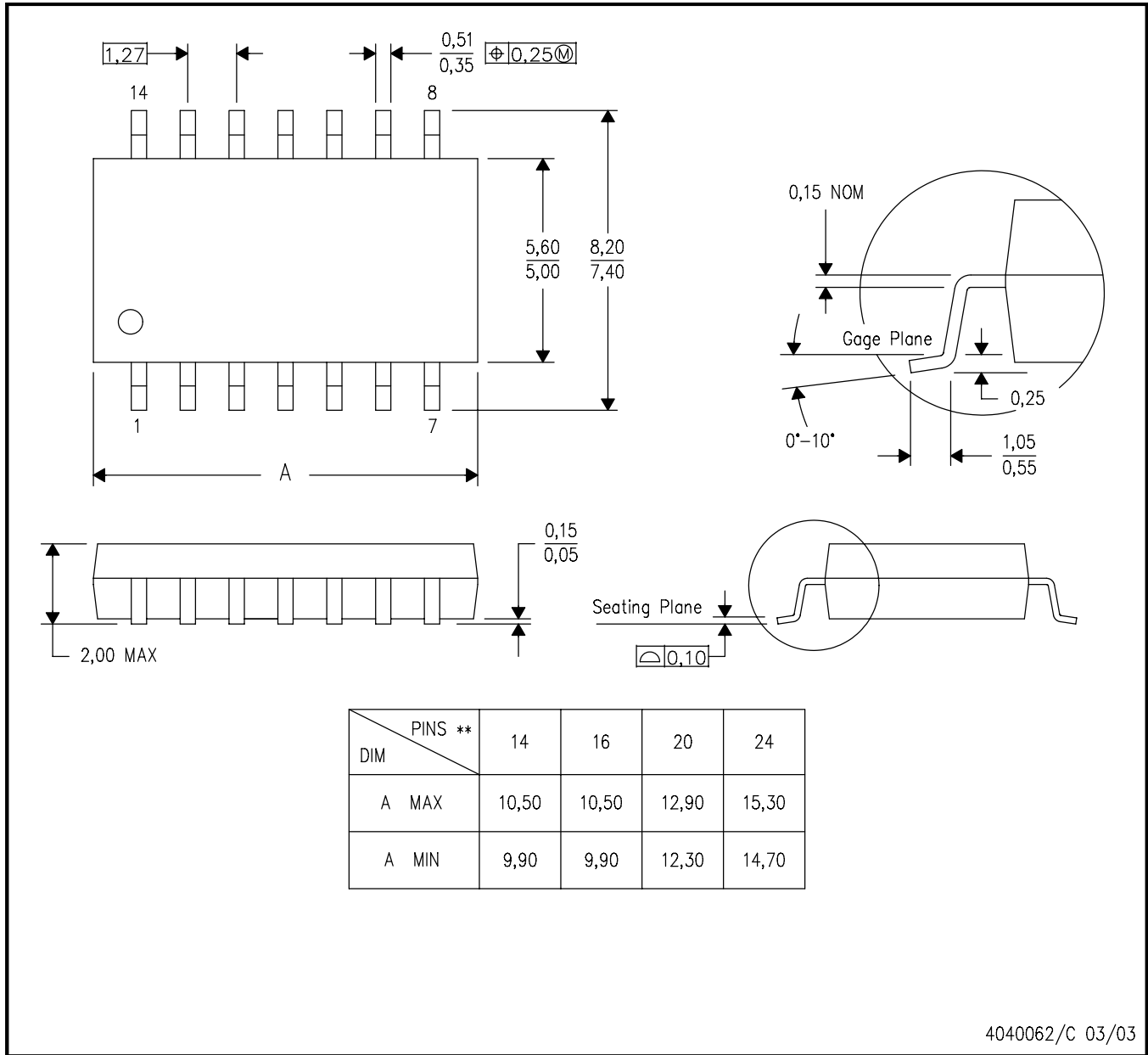

- NOTES:
- A. All linear dimensions are in millimeters.
 - B. This drawing is subject to change without notice.
 - C. Body dimensions do not include mold flash or protrusion, not to exceed 0,15.

重要通知和免责声明

TI“按原样”提供技术和可靠性数据（包括数据表）、设计资源（包括参考设计）、应用或其他设计建议、网络工具、安全信息和其他资源，不保证没有瑕疵且不做任何明示或暗示的担保，包括但不限于对适销性、与某特定用途的适用性或不侵犯任何第三方知识产权的暗示担保。

这些资源可供使用 TI 产品进行设计的熟练开发人员使用。您将自行承担以下全部责任：(1) 针对您的应用选择合适的 TI 产品，(2) 设计、验证并测试您的应用，(3) 确保您的应用满足相应标准以及任何其他安全、安保法规或其他要求。

这些资源如有变更，恕不另行通知。TI 授权您仅可将这些资源用于研发本资源所述的 TI 产品的相关应用。严禁以其他方式对这些资源进行复制或展示。您无权使用任何其他 TI 知识产权或任何第三方知识产权。对于因您对这些资源的使用而对 TI 及其代表造成的任何索赔、损害、成本、损失和债务，您将全额赔偿，TI 对此概不负责。

TI 提供的产品受 [TI 销售条款](#)、[TI 通用质量指南](#) 或 [ti.com](#) 上其他适用条款或 TI 产品随附的其他适用条款的约束。TI 提供这些资源并不会扩展或以其他方式更改 TI 针对 TI 产品发布的适用的担保或担保免责声明。除非德州仪器 (TI) 明确将某产品指定为定制产品或客户特定产品，否则其产品均为按确定价格收入目录的标准通用器件。

TI 反对并拒绝您可能提出的任何其他或不同的条款。

版权所有 © 2026，德州仪器 (TI) 公司

最后更新日期：2025 年 10 月