

ESD751 和 ESD761 24V 单通道 ESD 保护二极管

1 特性

- IEC 61000-4-2 4 级 ESD 保护：
 - $\pm 22\text{kV}$ 或 $\pm 15\text{kV}$ 接触放电
 - $\pm 22\text{kV}$ 或 $\pm 15\text{kV}$ 气隙放电
- 强大的浪涌保护：
 - IEC 61000-4-5 (8/20 μs) : 2.8A 或 1.8A
- 24V 工作电压
- 双向 ESD 保护
- 低钳位电压可保护下游元件
- 温度范围：-55°C 至 +150°C
- I/O 电容 = 1.6pF 或 1.1pF (典型值)
- 采用标准引线式封装和 0402 尺寸封装：SoD-523 (DYA) 和 X1SON (DPY)
- 引线式封装，用于自动光学检测 (AOI)

2 应用

- USB 电力传输 (USB-PD)
 - VBUS 保护
 - I/O 保护
- [工业控制网络](#)：
 - DeviceNet
 - 智能配电系统
 - 4/20mA 电路
 - PLC 浪涌保护
 - ADC 浪涌保护

3 说明

ESD751 和 ESD761 是适用于 USB 电力传输 (USB-PD) 的单通道低电容双向 ESD 保护器件。这些器件旨在耗散超过 IEC 61000-4-2 国际标准所规定最高水平 (分别为 $\pm 22\text{kV}$ 接触放电、 $\pm 22\text{kV}$ 气隙放电，以及 $\pm 15\text{kV}$ 接触放电、 $\pm 15\text{kV}$ 气隙放电) 的接触 ESD 冲击。低动态电阻和低钳位电压有助于保护系统免受瞬态事件的影响。这种保护至关重要，因为工业系统对鲁棒性和可靠性的要求很高。

封装信息⁽¹⁾

| 器件型号 | 封装 | 封装尺寸 (标称值) |
|--------|------------------|-----------------|
| ESD751 | DYA (SOD-523, 2) | 1.60mm × 0.80mm |
| ESD761 | DPY (X1SON, 2) | 1.00mm × 0.60mm |

(1) 要了解所有可用封装，请见数据表末尾的可订购产品附录。

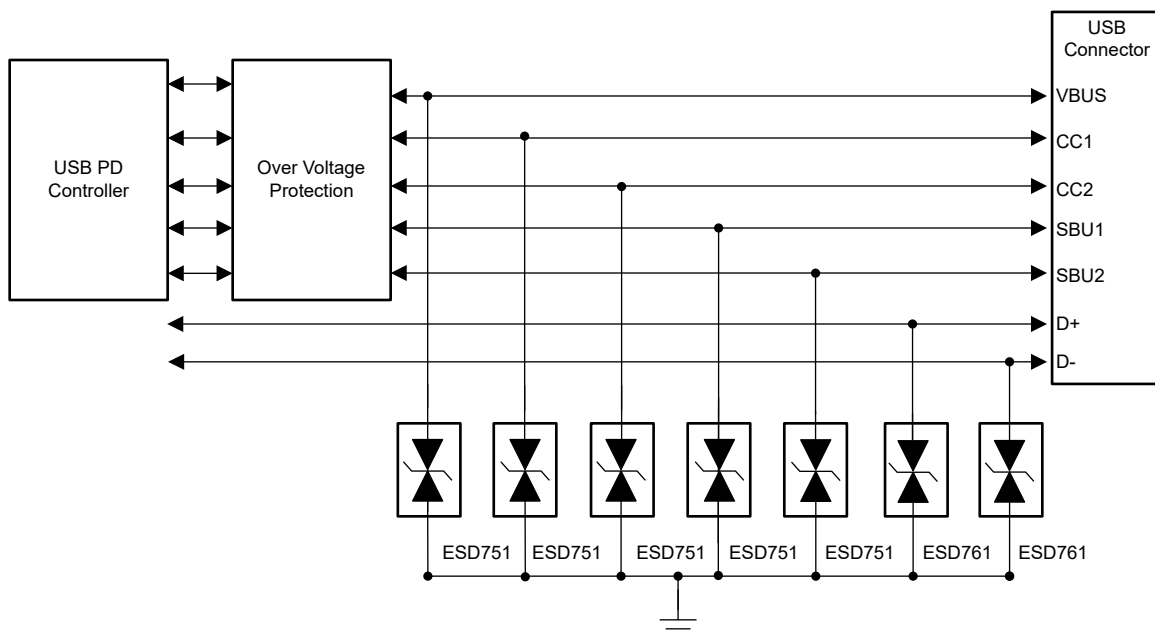

典型应用



Table of Contents

| | | | |
|--|---|--|----|
| 1 特性 | 1 | 7.4 Device Functional Modes..... | 8 |
| 2 应用 | 1 | 8 Application and Implementation | 9 |
| 3 说明 | 1 | 8.1 Application Information..... | 9 |
| 4 Revision History | 2 | 8.2 Typical Application..... | 9 |
| 5 Pin Configuration and Functions | 3 | 9 Power Supply Recommendations | 10 |
| 6 Specifications | 4 | 10 Layout | 11 |
| 6.1 Absolute Maximum Ratings..... | 4 | 10.1 Layout Guidelines..... | 11 |
| 6.2 ESD Ratings—JEDEC Specification..... | 4 | 10.2 Layout Example..... | 11 |
| 6.3 ESD Ratings—IEC Specification..... | 4 | 11 Device and Documentation Support | 12 |
| 6.4 Recommended Operating Conditions..... | 4 | 11.1 Documentation Support..... | 12 |
| 6.5 Thermal Information..... | 5 | 11.2 接收文档更新通知..... | 12 |
| 6.6 Electrical Characteristics..... | 5 | 11.3 支持资源..... | 12 |
| 6.7 Typical Characteristics - ESD751..... | 6 | 11.4 Trademarks..... | 12 |
| 6.8 Typical Characteristics - ESD761..... | 7 | 11.5 Electrostatic Discharge Caution..... | 12 |
| 7 Detailed Description | 8 | 11.6 术语表..... | 12 |
| 7.1 Overview..... | 8 | 12 Mechanical, Packaging, and Orderable Information | 12 |
| 7.2 Functional Block Diagram..... | 8 | | |
| 7.3 Feature Description..... | 8 | | |

4 Revision History

注：以前版本的页码可能与当前版本的页码不同

| Changes from Revision B (December 2022) to Revision C (December 2022) | Page |
|--|-------------|
| • Updated <i>Thermal Information</i> table..... | 5 |

| Changes from Revision A (November 2022) to Revision B (December 2022) | Page |
|--|-------------|
| • 将 ESD761 器件的状态从 <i>预告信息</i> 更改为 “ <i>量产数据</i> ” | 1 |

| Changes from Revision * (November 2022) to Revision A (November 2022) | Page |
|--|-------------|
| • 将 ESD751 器件的状态从 <i>预告信息</i> 更改为 “ <i>量产数据</i> ” | 1 |

5 Pin Configuration and Functions



图 5-1. DPY Package, 2-Pin X1SON (Top View)



图 5-2. DYA Package, 2-Pin SOD523 (Top View)

表 5-1. Pin Functions

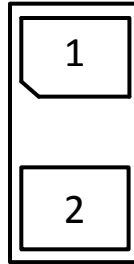
| PIN | | TYPE ⁽¹⁾ | DESCRIPTION |
|------|-----|---------------------|--------------------|
| NAME | NO. | | |
| IO | 1 | I/O | ESD protected IO |
| GND | 2 | G | Connect to ground. |

(1) I = Input, O = Output, I/O = Input or Output, G = Ground, P = Power.

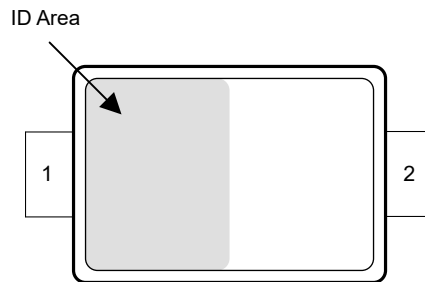
6 Specifications

6.1 Absolute Maximum Ratings

over operating free-air temperature range (unless otherwise noted)⁽¹⁾

| | | DEVICE | MIN | MAX | UNIT |
|------------------|--|--------|-----|-----|------|
| P _{PP} | IEC 61000-4-5 Power (t _p - 8/20 μs) at 25°C | ESD751 | | 102 | W |
| | | ESD761 | | 65 | |
| I _{PP} | IEC 61000-4-5 current (t _p - 8/20 μs) at 25°C | ESD751 | | 2.8 | A |
| | | ESD761 | | 1.8 | |
| T _A | Operating free-air temperature | | -55 | 150 | °C |
| T _J | Junction temperature | | -55 | 150 | |
| T _{stg} | Storage temperature | | -65 | 155 | |

- (1) Operation outside the Absolute Maximum Ratings may cause permanent device damage. Absolute Maximum Ratings do not imply functional operation of the device at these or any other conditions beyond those listed under Recommended Operating Conditions. If used outside the Recommended Operating Conditions but within the Absolute Maximum Ratings, the device may not be fully functional, and this may affect device reliability, functionality, performance, and shorten the device lifetime.

6.2 ESD Ratings—JEDEC Specification

| | | | VALUE | UNIT |
|--------------------|-------------------------|---|--------|------|
| V _(ESD) | Electrostatic discharge | Human body model (HBM), per ANSI/ESDA/ JEDEC JS-001 ⁽¹⁾ | ± 2500 | V |
| | | Charged device model (CDM), per JEDEC specification JS-002 ⁽²⁾ | ± 1000 | |

- (1) JEDEC document JEP155 states that 500-V HBM allows safe manufacturing with a standard ESD control process.
(2) JEDEC document JEP157 states that 250-V CDM allows safe manufacturing with a standard ESD control process.

6.3 ESD Ratings—IEC Specification

| | | | DEVICE | VALUE | UNIT |
|--------------------|-------------------------|---|--------|--------|------|
| V _(ESD) | Electrostatic discharge | IEC 61000-4-2 Contact Discharge, all pins | ESD751 | ±22000 | V |
| | | | ESD761 | ±15000 | |
| | | IEC 61000-4-2 Air-gap Discharge, all pins | ESD751 | ±22000 | |
| | | | ESD761 | ±15000 | |

6.4 Recommended Operating Conditions

over operating free-air temperature range (unless otherwise noted)

| | | MIN | NOM | MAX | UNIT |
|-----------------|--------------------------------|-----|-----|-----|------|
| V _{IN} | Input voltage | -24 | | 24 | V |
| T _A | Operating free-air temperature | -55 | | 150 | °C |

6.5 Thermal Information

| THERMAL METRIC ⁽¹⁾ | | ESD751 | ESD761 | UNIT |
|-------------------------------|--|---------------|-------------|------|
| | | DYA (SOD-523) | DPY (X1SON) | |
| | | 2 PINS | 2 PINS | |
| $R_{\theta JA}$ | Junction-to-ambient thermal resistance | 746.3 | 282.3 | °C/W |
| $R_{\theta JC(top)}$ | Junction-to-case (top) thermal resistance | 301.2 | 150.6 | °C/W |
| $R_{\theta JB}$ | Junction-to-board thermal resistance | 509.6 | 98.3 | °C/W |
| Ψ_{JT} | Junction-to-top characterization parameter | 81.8 | 9.6 | °C/W |
| Ψ_{JB} | Junction-to-board characterization parameter | 503.0 | 97.7 | °C/W |
| $R_{\theta JC(bot)}$ | Junction-to-case (bottom) thermal resistance | N/A | N/A | °C/W |

(1) For more information about traditional and new thermal metrics, see the [Semiconductor and IC Package Thermal Metrics](#) application report.

6.6 Electrical Characteristics

over $T_A = 25^\circ\text{C}$ (unless otherwise noted)

| PARAMETER | | TEST CONDITIONS | DEVICE | MIN | TYP | MAX | UNIT |
|-------------|-----------------------------------|--|------------------|-------|--------------|-------|----------|
| V_{RWM} | Reverse stand-off voltage | | | -24 | | 24 | V |
| V_{BRF} | Breakdown voltage ⁽¹⁾ | $I_{IO} = 10\text{ mA}$, IO to GND | | 25.5 | | 35.5 | V |
| V_{BRR} | | $I_{IO} = -10\text{ mA}$, IO to GND | | -35.5 | | -25.5 | |
| V_{CLAMP} | Clamping voltage ⁽²⁾ | $I_{PP} = 2.8\text{ A}$, $t_p = 8/20\ \mu\text{s}$, IO to GND and GND to IO | ESD751 | | 36.5 | | V |
| | | $I_{PP} = 1.8\text{ A}$, $t_p = 8/20\ \mu\text{s}$, IO to GND and GND to IO | ESD761 | | 36.3 | | |
| | Clamping voltage ⁽³⁾ | $I_{PP} = 16\text{ A}$, TLP, IO to GND and GND to IO | ESD751 ESD761 | | 41.5 42.5 | | V |
| I_{LEAK} | Leakage current | $V_{IO} = \pm 24\text{ V}$, IO to GND | | -50 | 1 | 50 | nA |
| R_{DYN} | Dynamic resistance ⁽³⁾ | | ESD751 | | 0.6 | | Ω |
| | | | ESD761 | | 0.53 | | |
| C_L | Line capacitance | $V_{IO} = 0\text{ V}$, $f = 1\text{ MHz}$, $V_{pp} = 30\text{ mV}$, IO to GND | ESD751 | | 1.6 | 2.7 | pF |
| | | | ESD761 | | 1.1 | 1.8 | |

(1) V_{BRF} and V_{BRR} are defined as the voltage when $\pm 10\text{ mA}$ is applied in the positive-going direction, before the device latches into the snapback state.

(2) Device stressed with 8/20 μs exponential decay waveform according to IEC 61000-4-5.

(3) Non-repetitive current pulse, Transmission Line Pulse (TLP); square pulse; ANSI / ESD STM5.5.1-2008

6.7 Typical Characteristics - ESD751

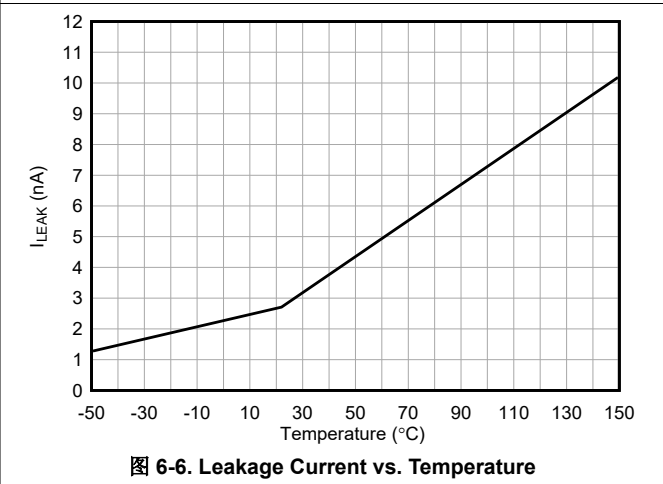
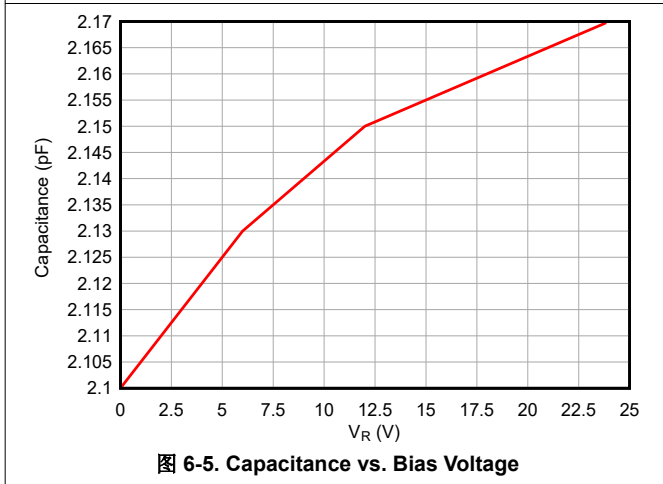
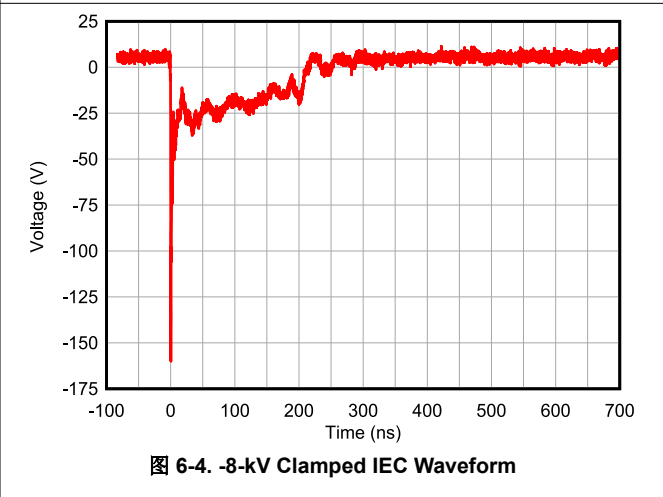
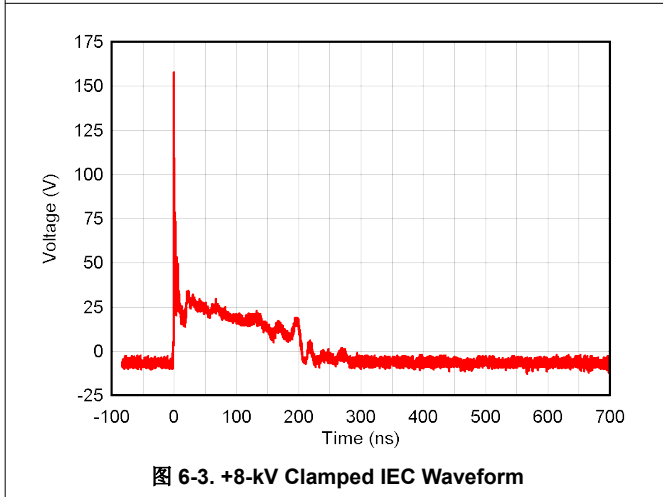
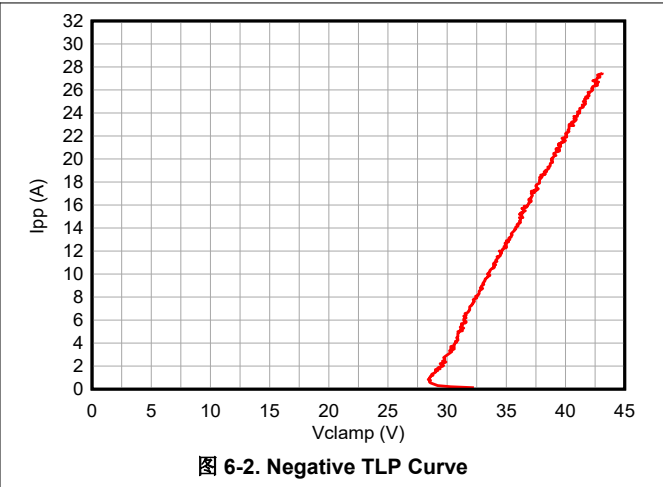
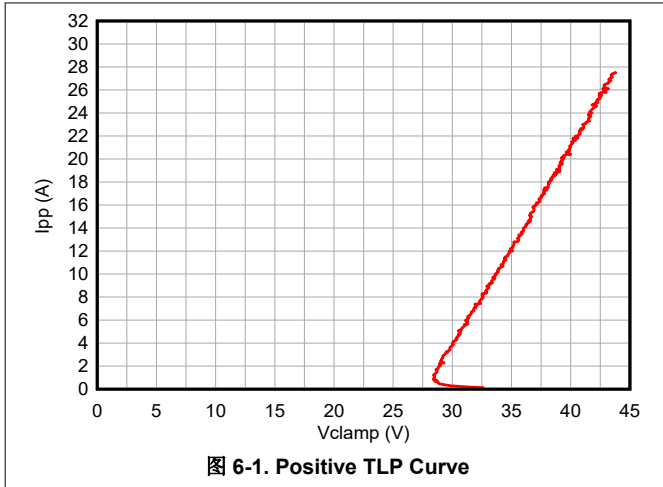

6.8 Typical Characteristics - ESD761



图 6-7. Positive TLP Curve



图 6-8. Negative TLP Curve

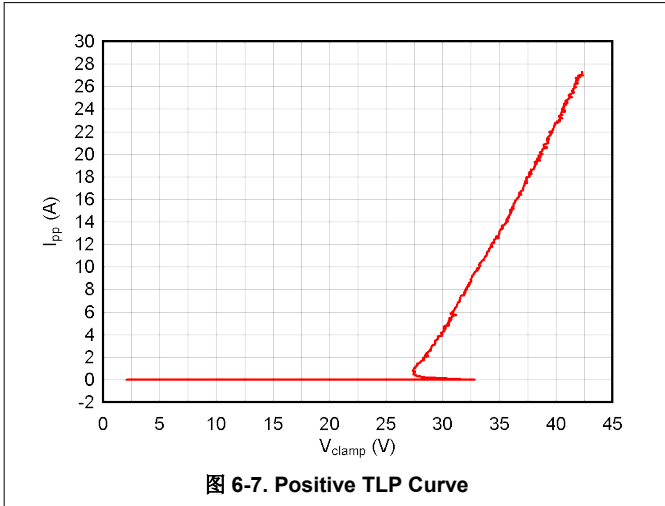

图 6-9. Capacitance vs. Bias Voltage

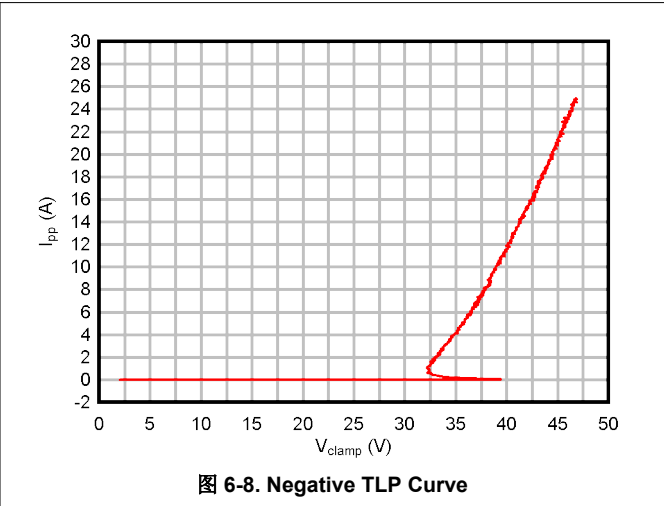

图 6-10. DC Voltage Sweep I-V Curve

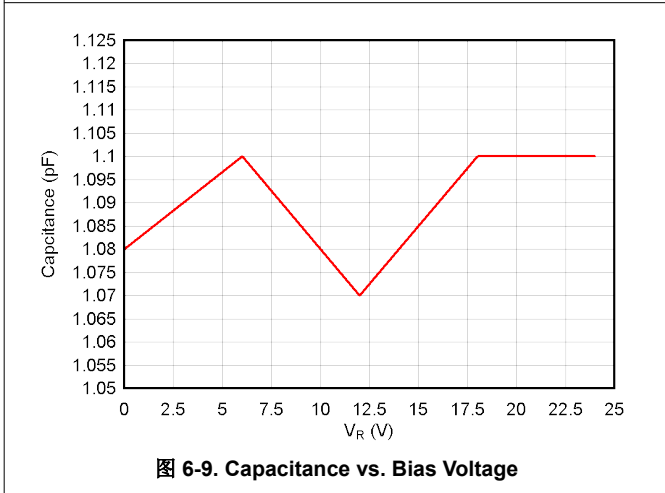

图 6-11. Insertion Loss

7 Detailed Description

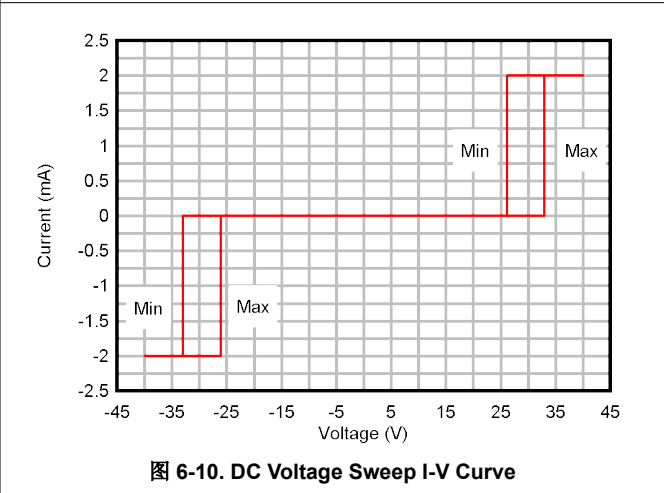
7.1 Overview

The ESD751 and ESD761 are single-channel bidirectional ESD diodes. These devices can dissipate ESD strikes above the maximum level specified by the IEC 61000-4-2 standard. The low capacitance between the I/O pins makes these devices suitable for slower speed signals such as USB-PD or industrial I/O applications. The surge current capability is suitable for VBUS protection or industrial I/Os requiring 2.8 A of surge current protection.

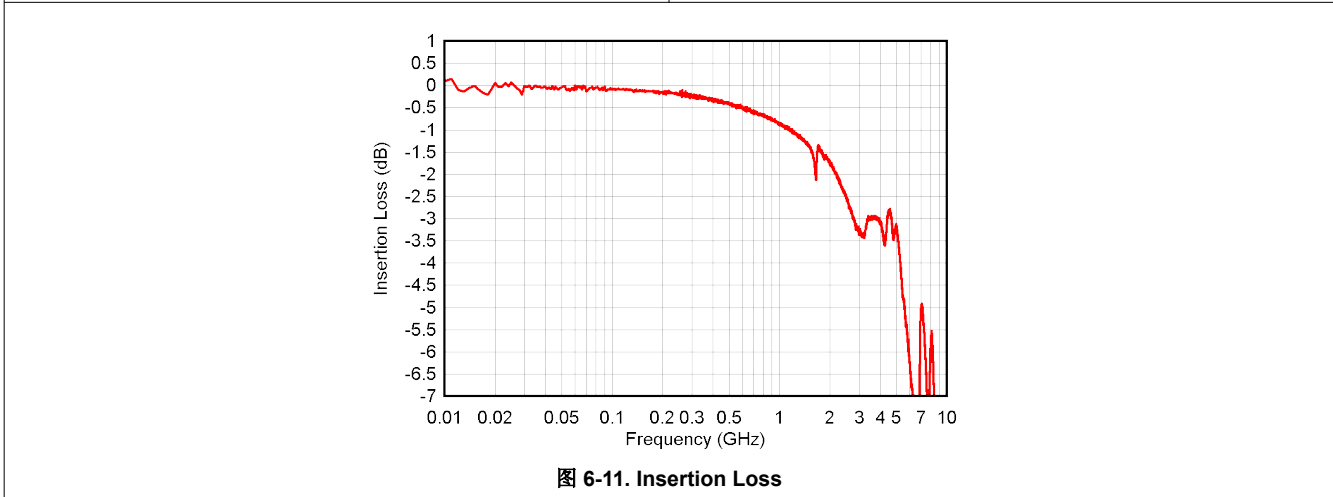
7.2 Functional Block Diagram

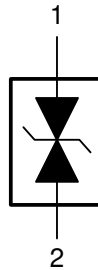

7.3 Feature Description

These clamping devices have a small dynamic resistance, which makes the clamping voltage low when the devices are actively protecting other circuits. The breakdown is bidirectional so these protection devices are a good fit for applications requiring positive and negative polarity protection. Low leakage allows the diode to conserve power when working below the V_{RWM} . The temperature range of -55°C to $+150^{\circ}\text{C}$ makes these ESD devices work at extensive temperatures in most environments. The leaded SOD-523 package is good for applications requiring automatic optical inspection (AOI).

7.3.1 IEC 61000-4-5 Surge Protection

The I/O pins can withstand surge events up to 2.8 A and 1.8 A (8/20 μs waveform) for the ESD751 and ESD761 respectively.

7.3.2 I/O Capacitance

The capacitance between the I/O pins is 1.6 pF and 1.1 pF for the ESD751 and ESD761 respectively. The capacitance of these devices support data rates up to 1 Gbps.

7.4 Device Functional Modes

The ESD751 and ESD761 are single channel passive clamps that have low leakage during normal operation when the voltage between I/O and GND is below V_{RWM} , and activate when the voltage between I/O and GND goes above V_{BR} . When the voltages on the protected lines fall below the V_{HOLD} , the device reverts back to the low leakage passive state

8 Application and Implementation

备注

Information in the following applications sections is not part of the TI component specification, and TI does not warrant its accuracy or completeness. TI's customers are responsible for determining suitability of components for their purposes, as well as validating and testing their design implementation to confirm system functionality.

8.1 Application Information

The ESD751 and ESD761 are single channel TVS diodes which are used to provide a path to ground for dissipating ESD events on USB-PD or industrial I/O lines. As the current from ESD passes through the TVS, only a small voltage drop is present across the diode. This is the voltage presented to the protected IC. The low R_{DYN} of the triggered TVS holds this voltage, V_{CLAMP} , to a safe level for the protected IC.

8.2 Typical Application



图 8-1. Typical Application

8.2.1 Design Requirements

For this design example, the ESD751 and ESD761 are used to provide ESD protection on a USB-PD connector. 表 8-1 lists the known design parameters for this application.

表 8-1. Design Parameters for Typical Applications

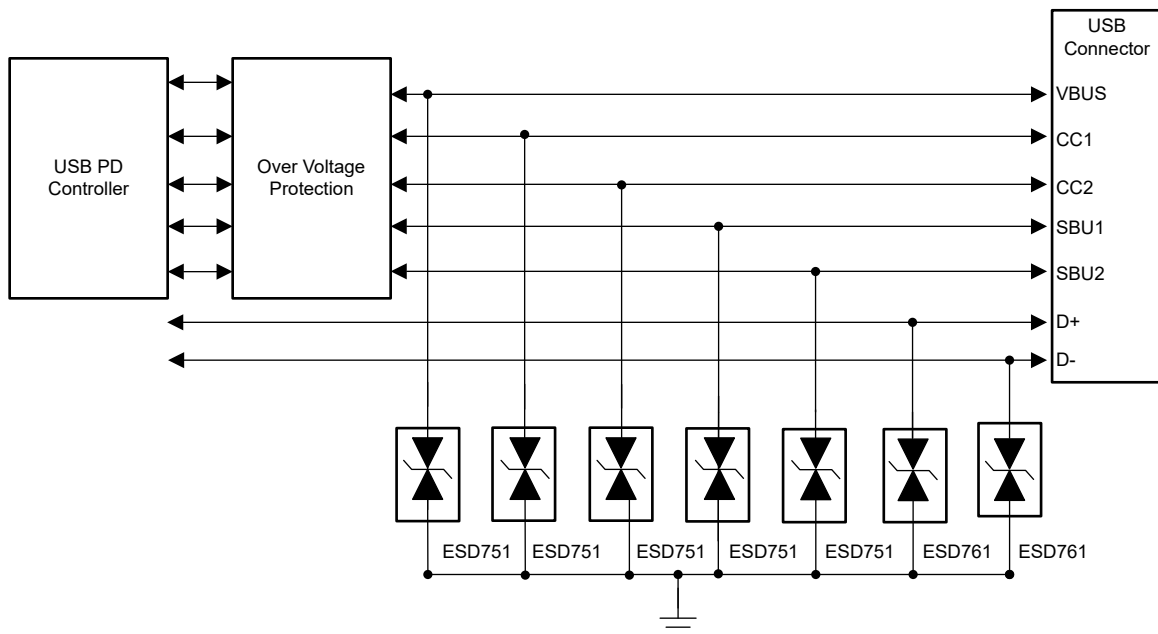
| Design Parameter | Value |
|------------------------------------|----------------|
| Diode configuration | Bidirectional |
| VBUS Voltage | + 20 V |
| V_{IO} differential signal range | ± 3.3 V |
| V_{RWM} | ± 24 V |
| Short to VBUS event on V_{IO} | ± 20 V |
| Data rate | Up to 480 Mbps |

8.2.2 Detailed Design Procedure

The ESD751 and ESD761 have a V_{RWM} of ± 24 V to protect the diode from being damaged during a short event that can occur when one of the USB-PD slower speed lines (CC1, CC2, SBU1, SBU2, D+, and D-) is shorted to VBUS. The bidirectional characteristic ensures both positive and negative polarity are protected. The low capacitance of 1.7 pF or less permits data rates up to 480 Mbps, which allows the designer to meet the requirements for the D+ and D- signals. These devices have an IPP = 2.8 A and 1.8 A (8/20 μ s), respectively. The surge current capability of these devices is suitable for protecting the VBUS power rail.

8.2.2.1 Application Curves



图 8-2. +8-kV Clamped IEC Waveform



图 8-3. -8-kV Clamped IEC Waveform

9 Power Supply Recommendations

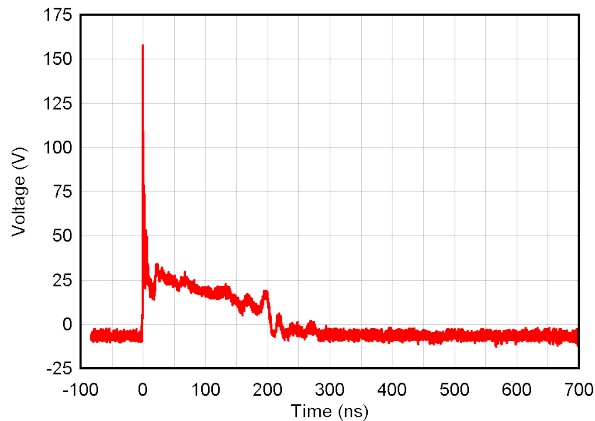
These devices are passive TVS diode-based ESD protection devices, therefore there is no requirement to power them. Ensure that the maximum voltage specifications for each pin is not violated.

10 Layout

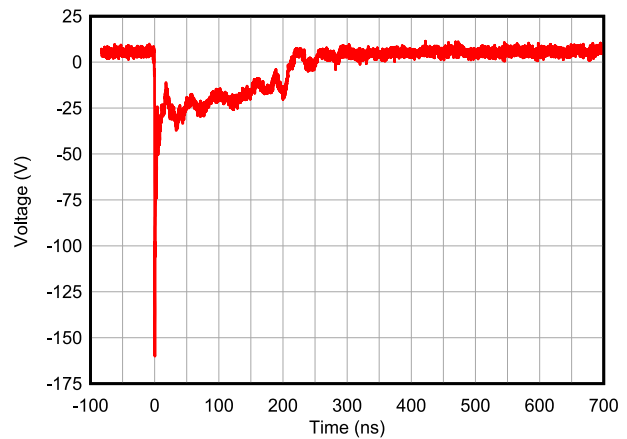
10.1 Layout Guidelines

- The optimum placement is as close to the connector as possible.
 - EMI during an ESD event can couple from the trace being struck to other nearby unprotected traces, resulting in early system failures.
 - The PCB designer must minimize the possibility of EMI coupling by keeping any unprotected traces away from the protected traces which are between the TVS and the connector.
- Route the protected traces as straight as possible.
- Eliminate any sharp corners on the protected traces between the TVS and the connector by using rounded corners with the largest radii possible.
 - Electric fields tend to build up on corners, increasing EMI coupling.
- If pin 1 or 2 is connected to ground, use a thick and short trace for this return path.

10.2 Layout Example



图 10-1. Layout Recommendation

11 Device and Documentation Support

TI offers an extensive line of development tools. Tools and software to evaluate the performance of the device, generate code, and develop solutions are listed below.

11.1 Documentation Support

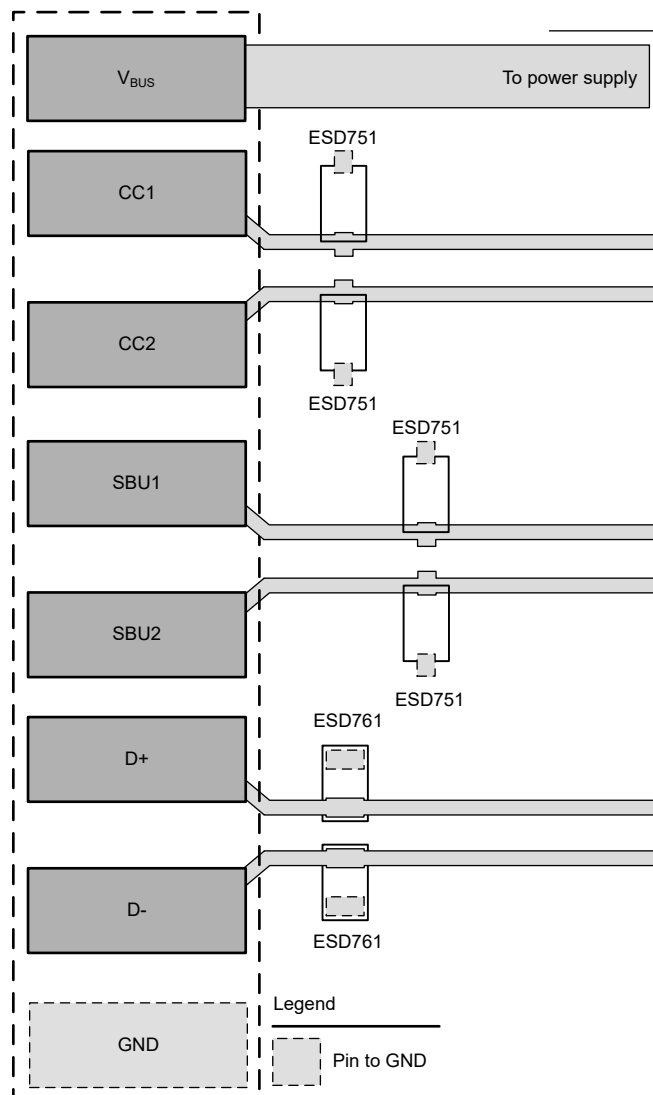
11.1.1 Related Documentation

For related documentation, see the following:

- Texas Instruments, [ESD Layout Guide application reports](#)
- Texas Instruments, [Generic ESD Evaluation Module user's guide](#)
- Texas Instruments, [Picking ESD Diodes for Ultra High-Speed Data Lines application reports](#)
- Texas Instruments, [Reading and Understanding an ESD Protection data sheet](#)

11.2 接收文档更新通知

要接收文档更新通知，请导航至 [ti.com](https://www.ti.com) 上的器件产品文件夹。点击 [订阅更新](#) 进行注册，即可每周接收产品信息更改摘要。有关更改的详细信息，请查看任何已修订文档中包含的修订历史记录。

11.3 支持资源

TI E2E™ [支持论坛](#) 是工程师的重要参考资料，可直接从专家获得快速、经过验证的解答和设计帮助。搜索现有解答或提出自己的问题可获得所需的快速设计帮助。

链接的内容由各个贡献者“按原样”提供。这些内容并不构成 TI 技术规范，并且不一定反映 TI 的观点；请参阅 TI 的 [《使用条款》](#)。

11.4 Trademarks

TI E2E™ is a trademark of Texas Instruments.

所有商标均为其各自所有者的财产。

11.5 Electrostatic Discharge Caution



This integrated circuit can be damaged by ESD. Texas Instruments recommends that all integrated circuits be handled with appropriate precautions. Failure to observe proper handling and installation procedures can cause damage.

ESD damage can range from subtle performance degradation to complete device failure. Precision integrated circuits may be more susceptible to damage because very small parametric changes could cause the device not to meet its published specifications.

11.6 术语表

[TI 术语表](#) 本术语表列出并解释了术语、首字母缩略词和定义。

12 Mechanical, Packaging, and Orderable Information

The following pages include mechanical, packaging, and orderable information. This information is the most current data available for the designated devices. This data is subject to change without notice and revision of this document. For browser-based versions of this data sheet, refer to the left-hand navigation.

PACKAGING INFORMATION

| Orderable Device | Status (1) | Package Type | Package Drawing | Pins | Package Qty | Eco Plan (2) | Lead finish/ Ball material (6) | MSL Peak Temp (3) | Op Temp (°C) | Device Marking (4/5) | Samples |
|------------------|---------------|--------------|-----------------|------|-------------|-----------------|--------------------------------------|----------------------|--------------|-------------------------|-------------------------|
| ESD751DYAR | ACTIVE | SOT-5X3 | DYA | 2 | 8000 | RoHS & Green | SN | Level-3-260C-168 HR | -55 to 150 | 1MN | Samples |
| ESD761DPYR | ACTIVE | X1SON | DPY | 2 | 10000 | RoHS & Green | NIPDAUAG | Level-1-260C-UNLIM | -55 to 150 | NE | Samples |

(1) The marketing status values are defined as follows:

ACTIVE: Product device recommended for new designs.

LIFEBUY: TI has announced that the device will be discontinued, and a lifetime-buy period is in effect.

NRND: Not recommended for new designs. Device is in production to support existing customers, but TI does not recommend using this part in a new design.

PREVIEW: Device has been announced but is not in production. Samples may or may not be available.

OBSOLETE: TI has discontinued the production of the device.

(2) **RoHS:** TI defines "RoHS" to mean semiconductor products that are compliant with the current EU RoHS requirements for all 10 RoHS substances, including the requirement that RoHS substance do not exceed 0.1% by weight in homogeneous materials. Where designed to be soldered at high temperatures, "RoHS" products are suitable for use in specified lead-free processes. TI may reference these types of products as "Pb-Free".

RoHS Exempt: TI defines "RoHS Exempt" to mean products that contain lead but are compliant with EU RoHS pursuant to a specific EU RoHS exemption.

Green: TI defines "Green" to mean the content of Chlorine (Cl) and Bromine (Br) based flame retardants meet JS709B low halogen requirements of <=1000ppm threshold. Antimony trioxide based flame retardants must also meet the <=1000ppm threshold requirement.

(3) MSL, Peak Temp. - The Moisture Sensitivity Level rating according to the JEDEC industry standard classifications, and peak solder temperature.

(4) There may be additional marking, which relates to the logo, the lot trace code information, or the environmental category on the device.

(5) Multiple Device Markings will be inside parentheses. Only one Device Marking contained in parentheses and separated by a "~" will appear on a device. If a line is indented then it is a continuation of the previous line and the two combined represent the entire Device Marking for that device.

(6) Lead finish/Ball material - Orderable Devices may have multiple material finish options. Finish options are separated by a vertical ruled line. Lead finish/Ball material values may wrap to two lines if the finish value exceeds the maximum column width.

Important Information and Disclaimer:The information provided on this page represents TI's knowledge and belief as of the date that it is provided. TI bases its knowledge and belief on information provided by third parties, and makes no representation or warranty as to the accuracy of such information. Efforts are underway to better integrate information from third parties. TI has taken and continues to take reasonable steps to provide representative and accurate information but may not have conducted destructive testing or chemical analysis on incoming materials and chemicals. TI and TI suppliers consider certain information to be proprietary, and thus CAS numbers and other limited information may not be available for release.

In no event shall TI's liability arising out of such information exceed the total purchase price of the TI part(s) at issue in this document sold by TI to Customer on an annual basis.

OTHER QUALIFIED VERSIONS OF ESD751, ESD761 :

- Automotive : [ESD751-Q1](#), [ESD761-Q1](#)

NOTE: Qualified Version Definitions:

- Automotive - Q100 devices qualified for high-reliability automotive applications targeting zero defects

TAPE AND REEL INFORMATION

QUADRANT ASSIGNMENTS FOR PIN 1 ORIENTATION IN TAPE

*All dimensions are nominal

| Device | Package Type | Package Drawing | Pins | SPQ | Reel Diameter (mm) | Reel Width W1 (mm) | A0 (mm) | B0 (mm) | K0 (mm) | P1 (mm) | W (mm) | Pin1 Quadrant |
|------------|--------------|-----------------|------|-------|--------------------|--------------------|---------|---------|---------|---------|--------|---------------|
| ESD751DYAR | SOT-5X3 | DYA | 2 | 8000 | 178.0 | 9.5 | 0.5 | 1.94 | 0.73 | 2.0 | 8.0 | Q1 |
| ESD761DPYR | X1SON | DPY | 2 | 10000 | 178.0 | 8.4 | 0.7 | 1.15 | 0.47 | 2.0 | 8.0 | Q1 |

TAPE AND REEL BOX DIMENSIONS

*All dimensions are nominal

| Device | Package Type | Package Drawing | Pins | SPQ | Length (mm) | Width (mm) | Height (mm) |
|------------|--------------|-----------------|------|-------|-------------|------------|-------------|
| ESD751DYAR | SOT-5X3 | DYA | 2 | 8000 | 210.0 | 200.0 | 42.0 |
| ESD761DPYR | X1SON | DPY | 2 | 10000 | 205.0 | 200.0 | 33.0 |

DYA0002A



PACKAGE OUTLINE

SOT (SOD-523) - 0.77 mm max height

PLASTIC SMALL OUTLINE

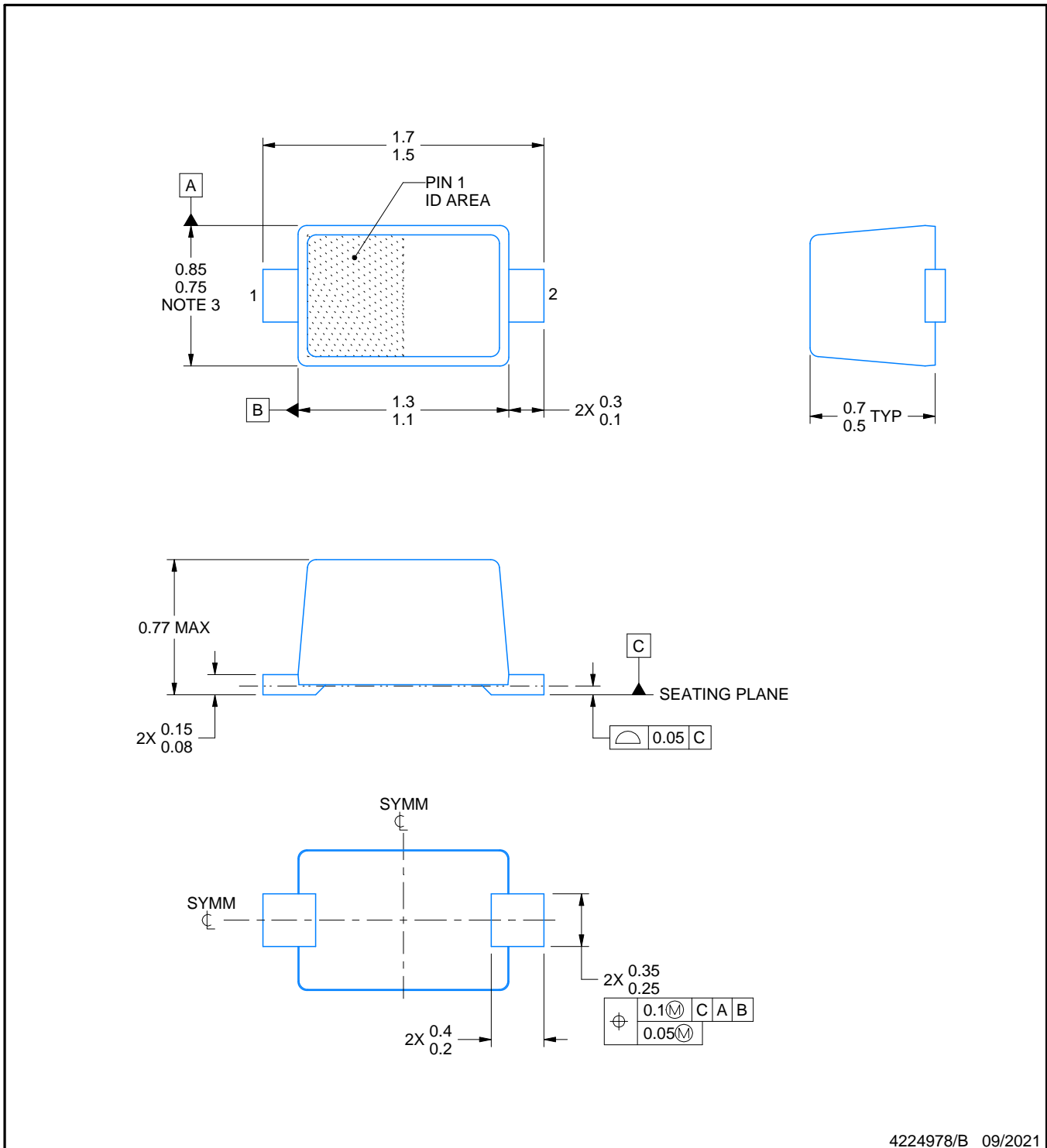

4224978/B 09/2021

NOTES:

1. All linear dimensions are in millimeters. Any dimensions in parenthesis are for reference only. Dimensioning and tolerancing per ASME Y14.5M.
2. This drawing is subject to change without notice.
3. This dimension does not include mold flash, protrusions, or gate burrs. Mold flash, protrusions, or gate burrs shall not exceed 0.15 mm per side.
4. Reference JEITA SC-79 registration except for package height

EXAMPLE BOARD LAYOUT

DYA0002A

SOT (SOD-523) - 0.77 mm max height

PLASTIC SMALL OUTLINE

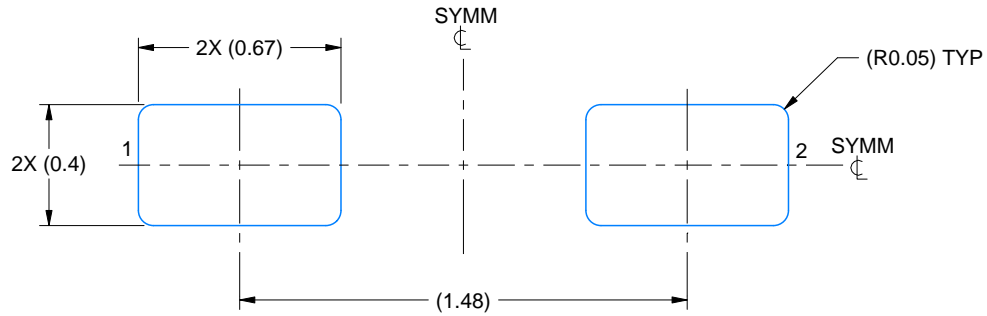

LAND PATTERN EXAMPLE
SCALE:40X

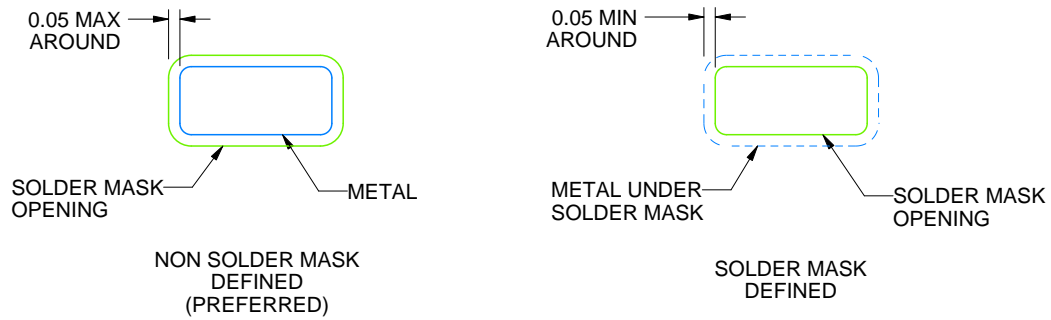

SOLDEMASK DETAILS

4224978/B 09/2021

NOTES: (continued)

- 5. Publication IPC-7351 may have alternate designs.
- 6. Solder mask tolerances between and around signal pads can vary based on board fabrication site.

EXAMPLE STENCIL DESIGN

DYA0002A

SOT (SOD-523) - 0.77 mm max height

PLASTIC SMALL OUTLINE

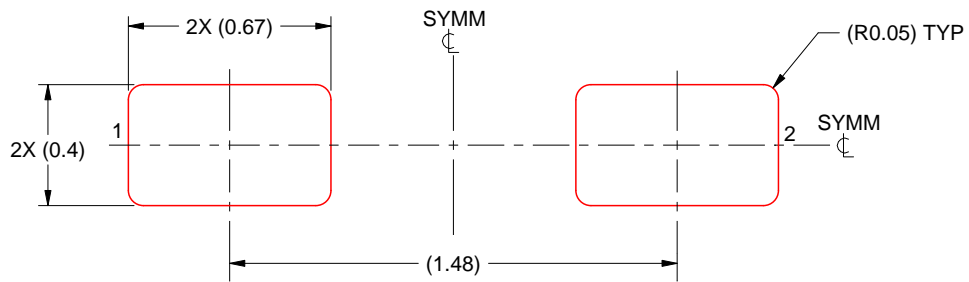

SOLDER PASTE EXAMPLE
BASED ON 0.1 mm THICK STENCIL
SCALE:40X

4224978/B 09/2021

NOTES: (continued)

7. Laser cutting apertures with trapezoidal walls and rounded corners may offer better paste release. IPC-7525 may have alternate design recommendations.
8. Board assembly site may have different recommendations for stencil design.

DPY0002A

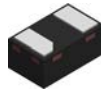

PACKAGE OUTLINE
X1SON - 0.45 mm max height

PLASTIC SMALL OUTLINE - NO LEAD

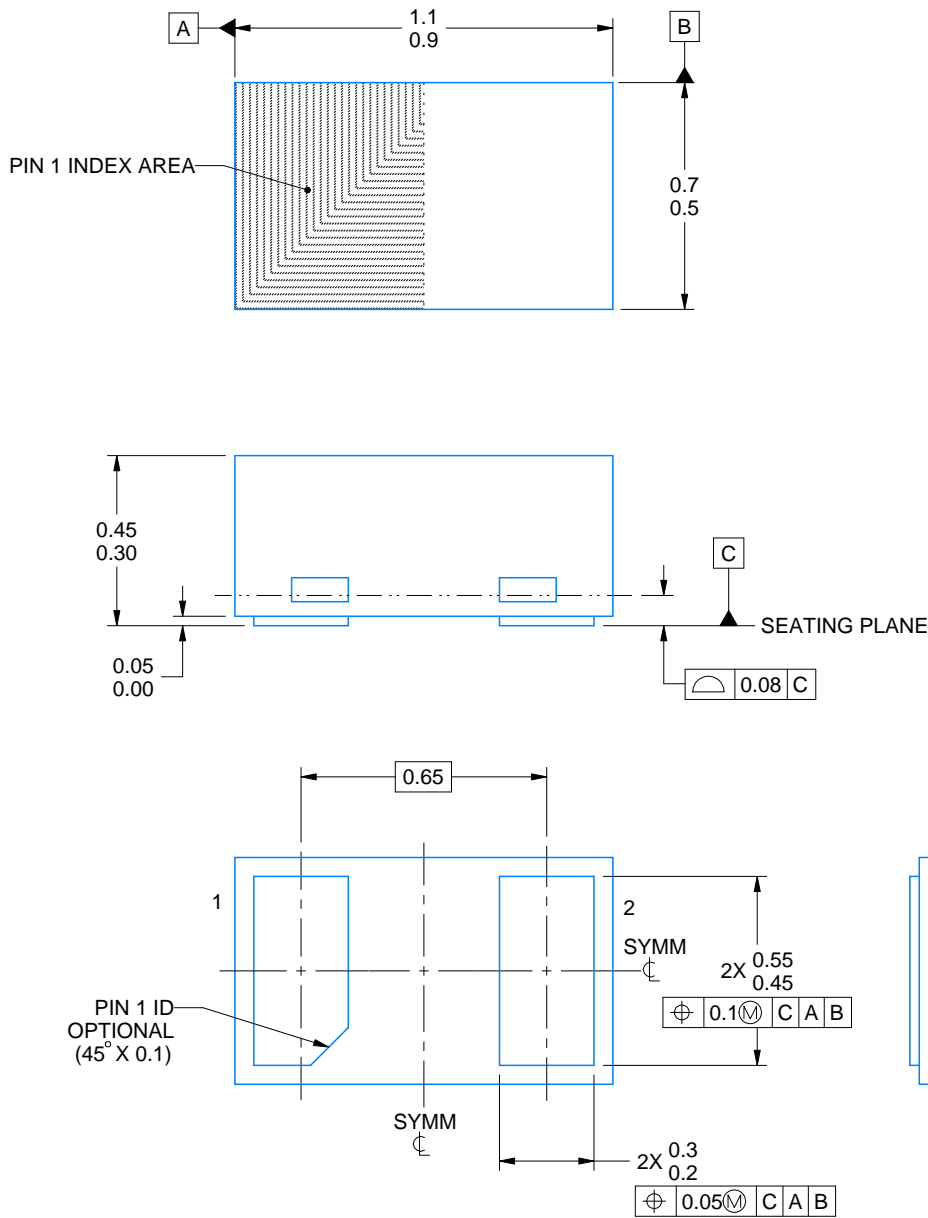

4224561/C 07/2024

NOTES:

1. All linear dimensions are in millimeters. Any dimensions in parenthesis are for reference only. Dimensioning and tolerancing per ASME Y14.5M
2. This drawing is subject to change without notice.

EXAMPLE BOARD LAYOUT

DPY0002A

X1SON - 0.45 mm max height

PLASTIC SMALL OUTLINE - NO LEAD

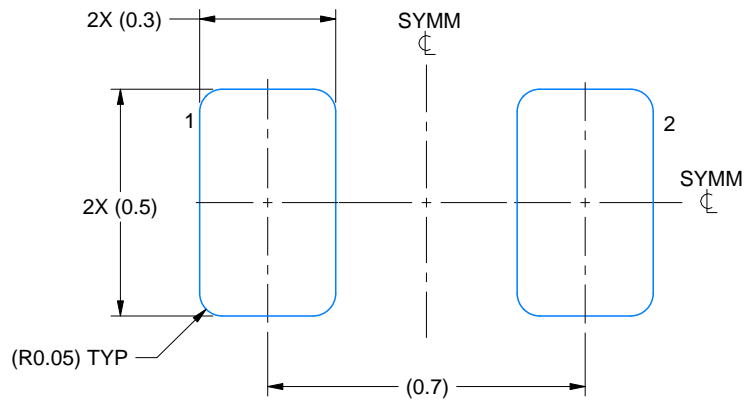

LAND PATTERN EXAMPLE
EXPOSED METAL SHOWN
SCALE:60X

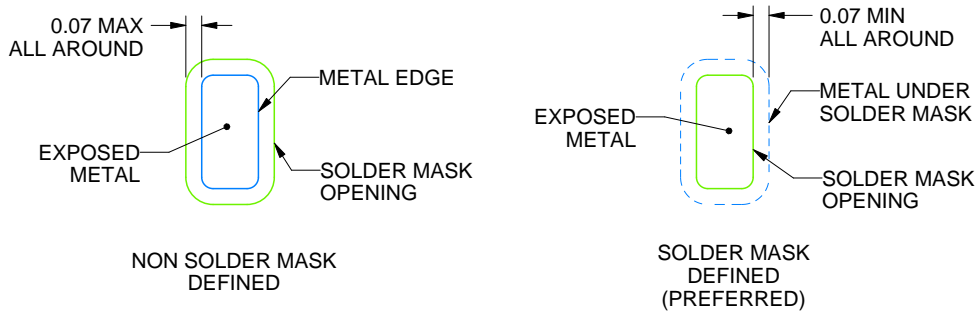

SOLDER MASK DETAILS

4224561/C 07/2024

NOTES: (continued)

3. For more information, see Texas Instruments literature number SLUA271 (www.ti.com/lit/sluea271).
4. Vias are optional depending on application, refer to device data sheet. If any vias are implemented, refer to their locations shown on this view. It is recommended that vias under paste be filled, plugged or tented.

EXAMPLE STENCIL DESIGN

DPY0002A

X1SON - 0.45 mm max height

PLASTIC SMALL OUTLINE - NO LEAD

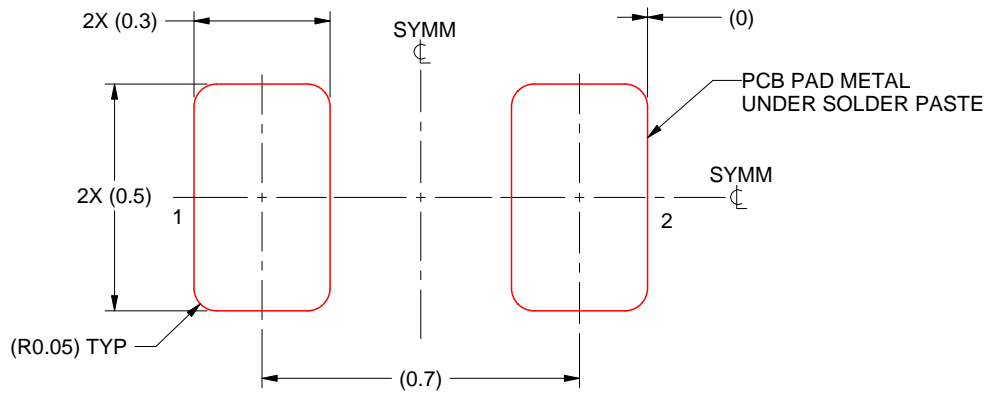

SOLDER PASTE EXAMPLE
BASED ON 0.1 mm THICK STENCIL
SCALE:60X

4224561/C 07/2024

NOTES: (continued)

5. Laser cutting apertures with trapezoidal walls and rounded corners may offer better paste release. IPC-7525 may have alternate design recommendations.

重要声明和免责声明

TI“按原样”提供技术和可靠性数据（包括数据表）、设计资源（包括参考设计）、应用或其他设计建议、网络工具、安全信息和其他资源，不保证没有瑕疵且不做任何明示或暗示的担保，包括但不限于对适销性、某特定用途方面的适用性或不侵犯任何第三方知识产权的暗示担保。

这些资源可供使用 TI 产品进行设计的熟练开发人员使用。您将自行承担以下全部责任：(1) 针对您的应用选择合适的 TI 产品，(2) 设计、验证并测试您的应用，(3) 确保您的应用满足相应标准以及任何其他功能安全、信息安全、监管或其他要求。

这些资源如有变更，恕不另行通知。TI 授权您仅可将这些资源用于研发本资源所述的 TI 产品的应用。严禁对这些资源进行其他复制或展示。您无权使用任何其他 TI 知识产权或任何第三方知识产权。您应全额赔偿因在这些资源的使用中对 TI 及其代表造成的任何索赔、损害、成本、损失和债务，TI 对此概不负责。

TI 提供的产品受 [TI 的销售条款](#) 或 [ti.com](#) 上其他适用条款/TI 产品随附的其他适用条款的约束。TI 提供这些资源并不会扩展或以其他方式更改 TI 针对 TI 产品发布的适用的担保或担保免责声明。

TI 反对并拒绝您可能提出的任何其他或不同的条款。

邮寄地址：Texas Instruments, Post Office Box 655303, Dallas, Texas 75265
Copyright © 2024，德州仪器 (TI) 公司