

CSD19531KCS 100V N 沟道 NexFET™ 功率 MOSFET

1 特性

- 超低 Q_g 和 Q_{gd}
- 低热阻
- 雪崩级
- 无铅端子镀层
- 符合 RoHS
- 无卤素
- TO-220 塑料封装

2 应用

- 次级侧同步整流器
- 热插拔电信应用
- 电机控制

3 说明

这款 100V、6.4mΩ、TO-220 NexFET™ 功率 MOSFET 旨在用于更最大限度地降低功率转换应用中的损耗。

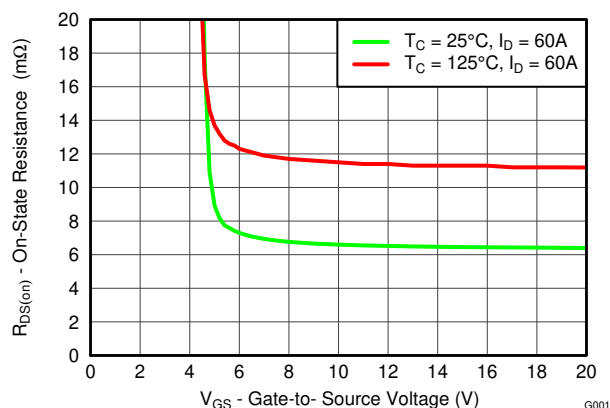
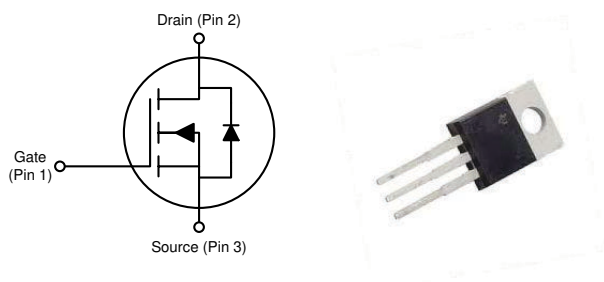

$R_{DS(on)}$ 与 V_{GS} 之间的关系

产品概要

$T_A = 25^\circ C$		典型值		单位
V_{DS}	漏源电压	100		V
Q_g	栅极电荷总量 (10V)	37		nC
Q_{gd}	栅极电荷 (栅极到漏极)	7.5		nC
$R_{DS(on)}$	漏源导通电阻	$V_{GS} = 6V$	7.3	mΩ
		$V_{GS} = 10V$	6.4	
$V_{GS(th)}$	阈值电压	2.7		V

器件信息(1)

器件	封装	介质	数量	运输
CSD19531KCS	TO-220 塑料封装	管装	50	管装

(1) 如需了解所有可用封装, 请参阅数据表末尾的可订购产品附录。

绝对最大额定值

$T_A = 25^\circ C$		值	单位
V_{DS}	漏源电压	100	V
V_{GS}	栅源电压	±20	V
I_D	持续漏极电流 (受封装限制)	100	A
	持续漏极电流 (受器件限制), $T_C = 25^\circ C$ 时测得	110	
	持续漏极电流 (受器件限制), $T_C = 100^\circ C$ 时测得	78	
I_{DM}	脉冲漏极电流(1)	285	A
P_D	功率耗散	214	W
T_J, T_{stg}	工作结温, 贮存温度	-55 至 175	°C
E_{AS}	雪崩能量, 单脉冲 $I_D = 60A, L = 0.1mH, R_G = 25\Omega$	180	mJ

(1) 最大 $R_{\theta JC} = 0.7^\circ C/W$, 脉冲持续时间 $\leq 100 \mu s$, 占空比 $\leq 1\%$ 。

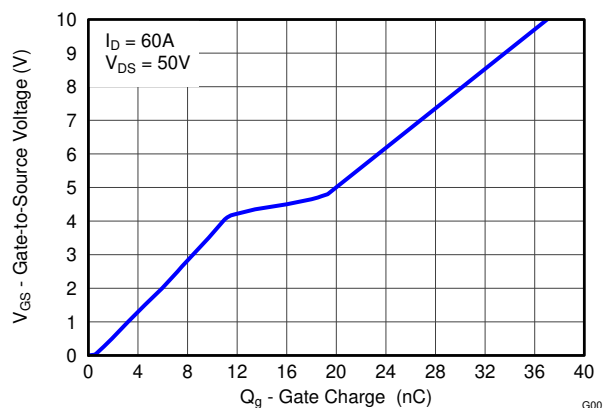

栅极电荷

Table of Contents

1 特性	1	5.2 Documentation Support	7
2 应用	1	5.3 接收文档更新通知	7
3 说明	1	5.4 支持资源	7
4 Specifications	3	5.5 Trademarks	7
4.1 Electrical Characteristics.....	3	5.6 静电放电警告	7
4.2 Thermal Information.....	3	5.7 术语表	7
4.3 Typical MOSFET Characteristics.....	4	6 Revision History	7
5 Device and Documentation Support	7	7 Mechanical, Packaging, and Orderable Information	9
5.1 第三方产品免责声明.....	7		

4 Specifications

4.1 Electrical Characteristics

$T_A = 25^\circ\text{C}$ (unless otherwise stated)

PARAMETER		TEST CONDITIONS	MIN	TYP	MAX	UNIT
STATIC CHARACTERISTICS						
BV_{DSS}	Drain-to-source voltage	$V_{GS} = 0V, I_D = 250 \mu A$	100			V
I_{DSS}	Drain-to-source leakage current	$V_{GS} = 0V, V_{DS} = 80V$			1	μA
I_{GSS}	Gate-to-source leakage current	$V_{DS} = 0V, V_{GS} = 20V$			100	nA
$V_{GS(th)}$	Gate-to-source threshold voltage	$V_{DS} = V_{GS}, I_D = 250 \mu A$	2.2	2.7	3.3	V
$R_{DS(on)}$	Drain-to-source on resistance	$V_{GS} = 6V, I_D = 60A$		7.3	8.8	m Ω
		$V_{GS} = 10V, I_D = 60A$		6.4	7.7	
g_{fs}	Transconductance	$V_{DS} = 10V, I_D = 60A$		137		S
DYNAMIC CHARACTERISTICS						
C_{iss}	Input capacitance	$V_{GS} = 0V, V_{DS} = 50V, f = 1MHz$		2980	3870	pF
C_{oss}	Output capacitance			560	728	pF
C_{riss}	Reverse transfer capacitance			13	17	pF
R_G	Series gate resistance			1.3	2.6	Ω
Q_g	Gate charge total (10V)	$V_{DS} = 50V, I_D = 60A$		38	49	nC
Q_{gd}	Gate charge gate-to-drain			7.5		nC
Q_{gs}	Gate charge gate-to-source			11.9		nC
$Q_{g(th)}$	Gate charge at V_{th}			7.3		nC
Q_{oss}	Output charge	$V_{DS} = 50V, V_{GS} = 0V$		98		nC
$t_{d(on)}$	Turnon delay time	$V_{DS} = 50V, V_{GS} = 10V,$ $I_{DS} = 60A, R_G = 0\Omega$		8.4		ns
t_r	Rise Time			7.2		ns
$t_{d(off)}$	Turnoff delay time			16		ns
t_f	Fall time			4.1		ns
DIODE CHARACTERISTICS						
V_{SD}	Diode forward voltage	$I_{SD} = 60A, V_{GS} = 0V$		0.9	1	V
Q_{rr}	Reverse recovery charge	$V_{DS} = 50V, I_F = 60A,$ $di/dt = 300A/\mu s$		270		nC
t_{rr}	Reverse recovery time			83		ns

4.2 Thermal Information

$T_A = 25^\circ\text{C}$ (unless otherwise stated)

THERMAL METRIC		MIN	TYP	MAX	UNIT
$R_{\theta JC}$	Junction-to-case thermal resistance			0.7	$^\circ\text{C/W}$
$R_{\theta JA}$	Junction-to-ambient thermal resistance			62	$^\circ\text{C/W}$

4.3 Typical MOSFET Characteristics

$T_A = 25^\circ\text{C}$ (unless otherwise stated)

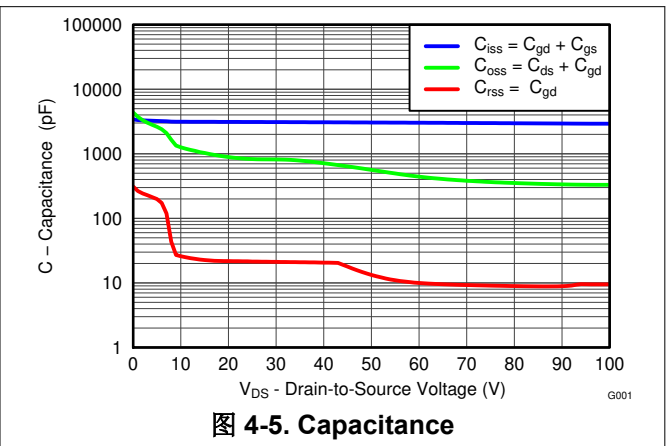
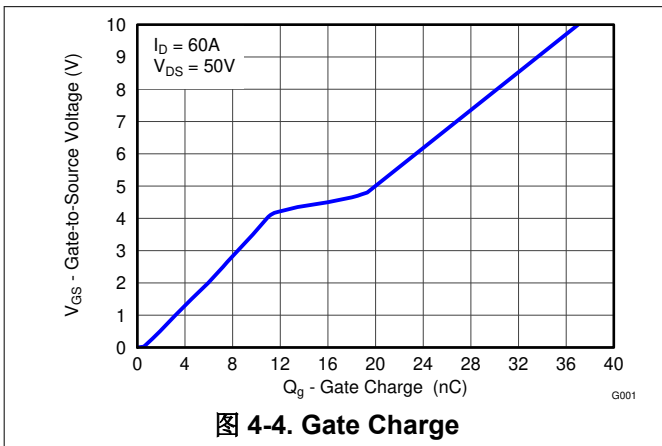
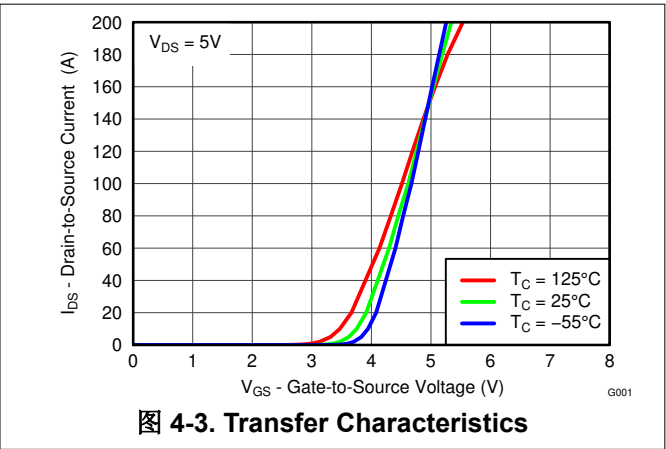
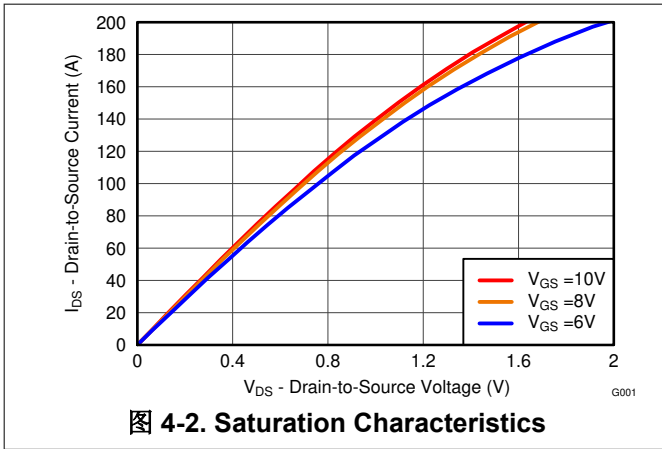
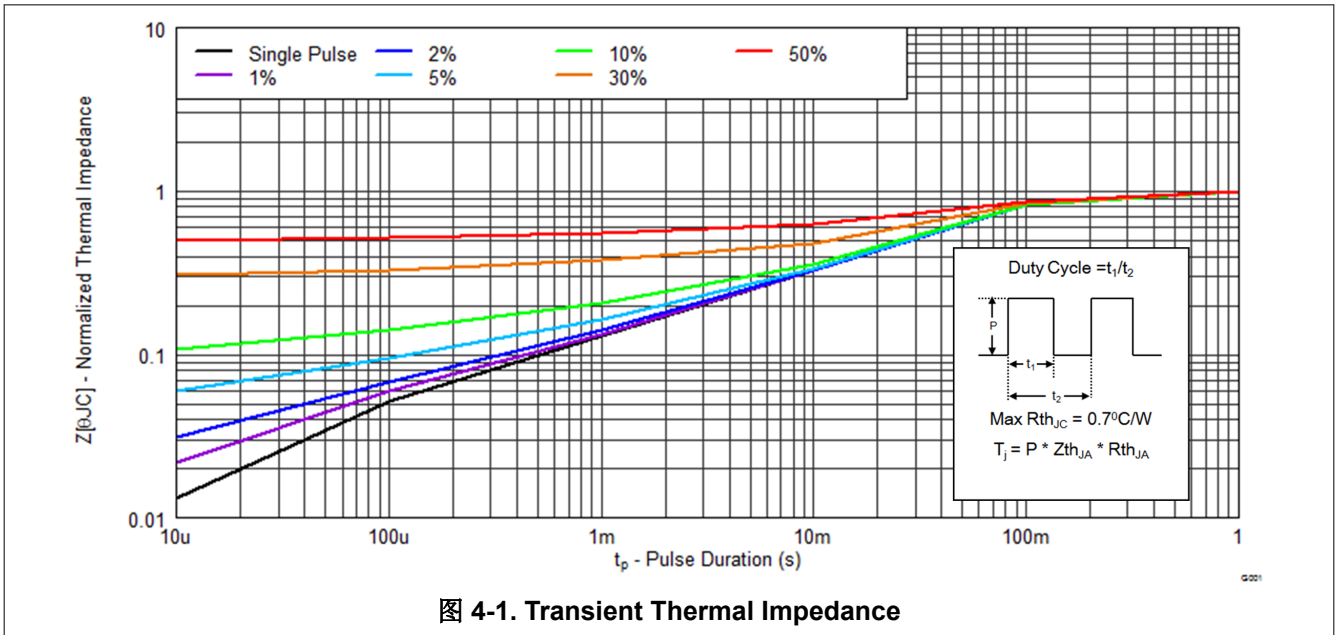



图 4-6. Threshold Voltage vs Temperature



图 4-7. On-State Resistance vs Gate-to-Source Voltage

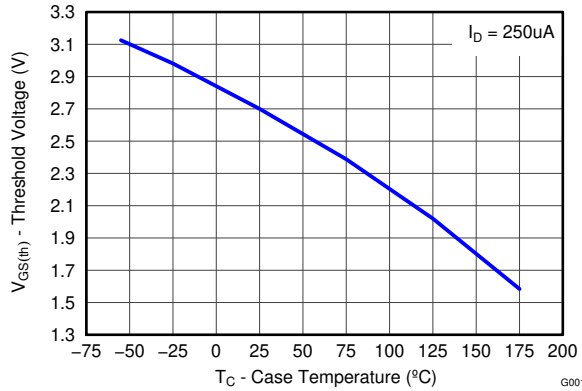

图 4-8. Normalized On-State Resistance vs Temperature

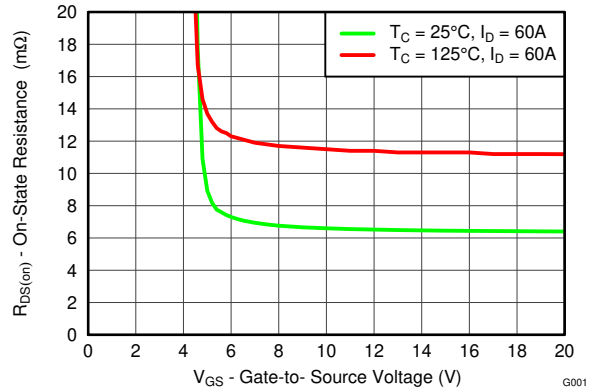

图 4-9. Typical Diode Forward Voltage

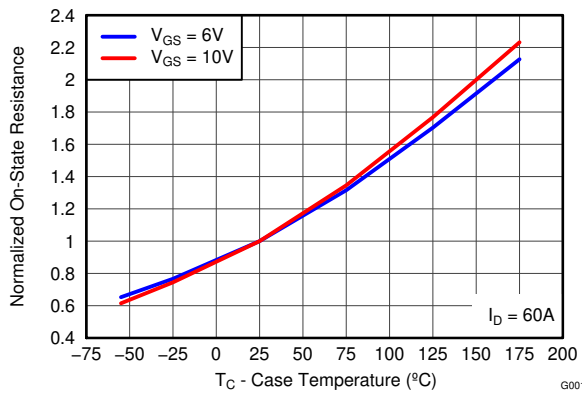

图 4-10. Maximum Safe Operating Area

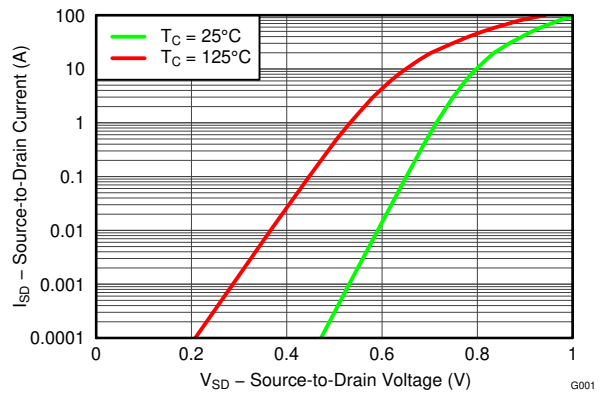

图 4-11. Single Pulse Unclamped Inductive Switching

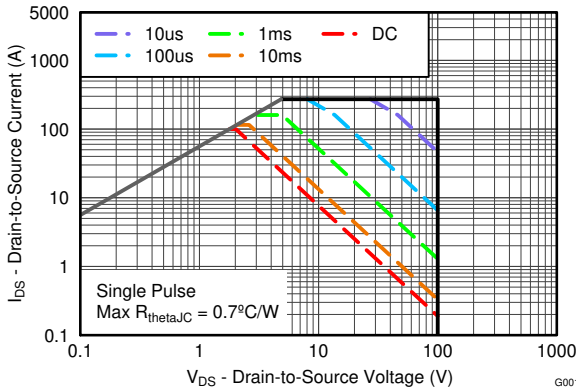

图 4-12. Maximum Drain Current vs Temperature

5 Device and Documentation Support

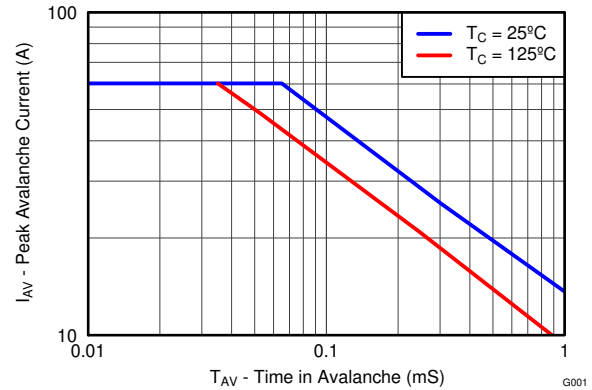
5.1 第三方产品免责声明

TI 发布的与第三方产品或服务有关的信息，不能构成与此类产品或服务或保修的适用性有关的认可，不能构成此类产品或服务单独或与任何 TI 产品或服务一起的表示或认可。

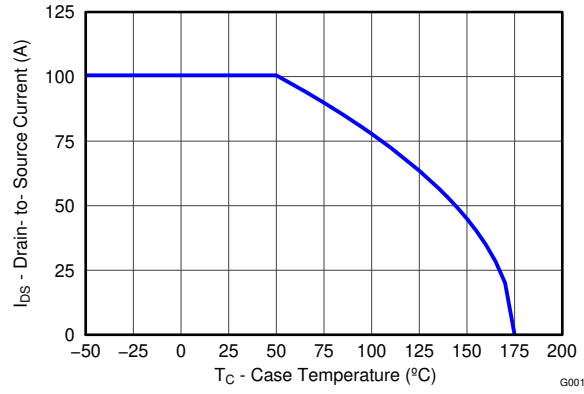
5.2 Documentation Support

5.2.1 Related Documentation

5.3 接收文档更新通知

要接收文档更新通知，请导航至 ti.com 上的器件产品文件夹。点击 [通知](#) 进行注册，即可每周接收产品信息更改摘要。有关更改的详细信息，请查看任何已修订文档中包含的修订历史记录。

5.4 支持资源

[TI E2E™ 中文支持论坛](#) 是工程师的重要参考资料，可直接从专家处获得快速、经过验证的解答和设计帮助。搜索现有解答或提出自己的问题，获得所需的快速设计帮助。

链接的内容由各个贡献者“按原样”提供。这些内容并不构成 TI 技术规范，并且不一定反映 TI 的观点；请参阅 TI 的 [使用条款](#)。

5.5 Trademarks

NexFET™ is a trademark of Texas Instruments.

TI E2E™ is a trademark of Texas Instruments.

所有商标均为其各自所有者的财产。

5.6 静电放电警告



静电放电 (ESD) 会损坏这个集成电路。德州仪器 (TI) 建议通过适当的预防措施处理所有集成电路。如果不遵守正确的处理和安装程序，可能会损坏集成电路。

ESD 的损坏小至导致微小的性能降级，大至整个器件故障。精密的集成电路可能更容易受到损坏，这是因为非常细微的参数更改都可能会导致器件与其发布的规格不相符。

5.7 术语表

[TI 术语表](#) 本术语表列出并解释了术语、首字母缩略词和定义。

6 Revision History

Changes from Revision C (March 2017) to Revision D (May 2024) Page

- 更新了整个文档中的表格、图和交叉参考的编号格式..... 1

Changes from Revision B (June 2014) to Revision C (March 2017) Page

Changes from Revision A (May 2014) to Revision B (June 2014) Page

- Added value for max Q_g 3

Changes from Revision * (September 2013) to Revision A (May 2014) Page

- 更新了受器件限制电流，以反映器件运行温度范围内的增加量..... 1

- 提高了脉冲电流来反映全新条件..... 1
- 提高了最大功率耗散来反映全新条件..... 1
- 将工作结温范围提高至 175°C..... 1
- 更新了脉冲漏极电流条件..... 1
- Changed 图 4-1 from a normalized $R_{\theta JA}$ curve to a normalized $R_{\theta JC}$ curve 4
- Updated 图 4-6 to reflect increase in device operating temperature range 4
- Updated 图 4-8 to reflect increase in device operating temperature range 4
- Updated 图 4-10 to reflect measured SOA data 4
- Updated 图 4-12 to reflect increase in device operating temperature range 4

7 Mechanical, Packaging, and Orderable Information

The following pages include mechanical, packaging, and orderable information. This information is the most current data available for the designated devices. This data is subject to change without notice and revision of this document. For browser-based versions of this data sheet, refer to the left-hand navigation.

PACKAGING INFORMATION

Orderable part number	Status (1)	Material type (2)	Package Pins	Package qty Carrier	RoHS (3)	Lead finish/ Ball material (4)	MSL rating/ Peak reflow (5)	Op temp (°C)	Part marking (6)
CSD19531KCS	Active	Production	TO-220 (KCS) 3	50 TUBE	ROHS Exempt	SN	N/A for Pkg Type	-55 to 175	CSD19531KCS
CSD19531KCS.B	Active	Production	TO-220 (KCS) 3	50 TUBE	ROHS Exempt	SN	N/A for Pkg Type	-55 to 175	CSD19531KCS

(1) **Status:** For more details on status, see our [product life cycle](#).

(2) **Material type:** When designated, preproduction parts are prototypes/experimental devices, and are not yet approved or released for full production. Testing and final process, including without limitation quality assurance, reliability performance testing, and/or process qualification, may not yet be complete, and this item is subject to further changes or possible discontinuation. If available for ordering, purchases will be subject to an additional waiver at checkout, and are intended for early internal evaluation purposes only. These items are sold without warranties of any kind.

(3) **RoHS values:** Yes, No, RoHS Exempt. See the [TI RoHS Statement](#) for additional information and value definition.

(4) **Lead finish/Ball material:** Parts may have multiple material finish options. Finish options are separated by a vertical ruled line. Lead finish/Ball material values may wrap to two lines if the finish value exceeds the maximum column width.

(5) **MSL rating/Peak reflow:** The moisture sensitivity level ratings and peak solder (reflow) temperatures. In the event that a part has multiple moisture sensitivity ratings, only the lowest level per JEDEC standards is shown. Refer to the shipping label for the actual reflow temperature that will be used to mount the part to the printed circuit board.

(6) **Part marking:** There may be an additional marking, which relates to the logo, the lot trace code information, or the environmental category of the part.

Multiple part markings will be inside parentheses. Only one part marking contained in parentheses and separated by a "~" will appear on a part. If a line is indented then it is a continuation of the previous line and the two combined represent the entire part marking for that device.

Important Information and Disclaimer: The information provided on this page represents TI's knowledge and belief as of the date that it is provided. TI bases its knowledge and belief on information provided by third parties, and makes no representation or warranty as to the accuracy of such information. Efforts are underway to better integrate information from third parties. TI has taken and continues to take reasonable steps to provide representative and accurate information but may not have conducted destructive testing or chemical analysis on incoming materials and chemicals. TI and TI suppliers consider certain information to be proprietary, and thus CAS numbers and other limited information may not be available for release.

In no event shall TI's liability arising out of such information exceed the total purchase price of the TI part(s) at issue in this document sold by TI to Customer on an annual basis.

TUBE

*All dimensions are nominal

Device	Package Name	Package Type	Pins	SPQ	L (mm)	W (mm)	T (μm)	B (mm)
CSD19531KCS	KCS	TO-220	3	50	532	34.1	700	9.6
CSD19531KCS.B	KCS	TO-220	3	50	532	34.1	700	9.6

KCS0003B

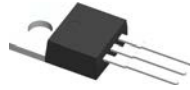

PACKAGE OUTLINE

TO-220 - 19.65 mm max height

TO-220

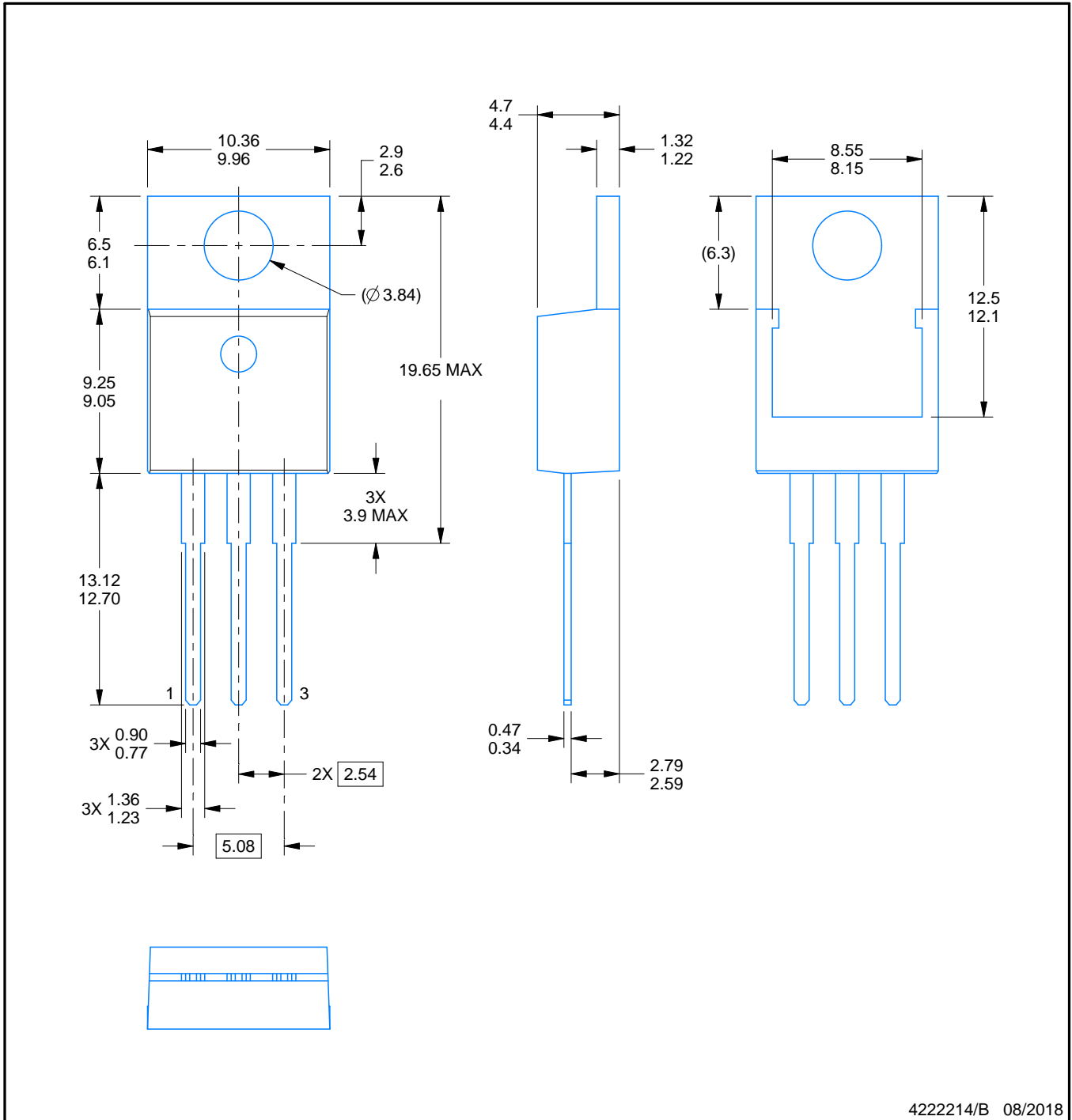

4222214/B 08/2018

NOTES:

- 1. Dimensions are in millimeters. Any dimension in brackets or parenthesis are for reference only. Dimensioning and tolerancing per ASME Y14.5M.
- 2. This drawing is subject to change without notice.
- 3. Reference JEDEC registration TO-220.

EXAMPLE BOARD LAYOUT

KCS0003B

TO-220 - 19.65 mm max height

TO-220

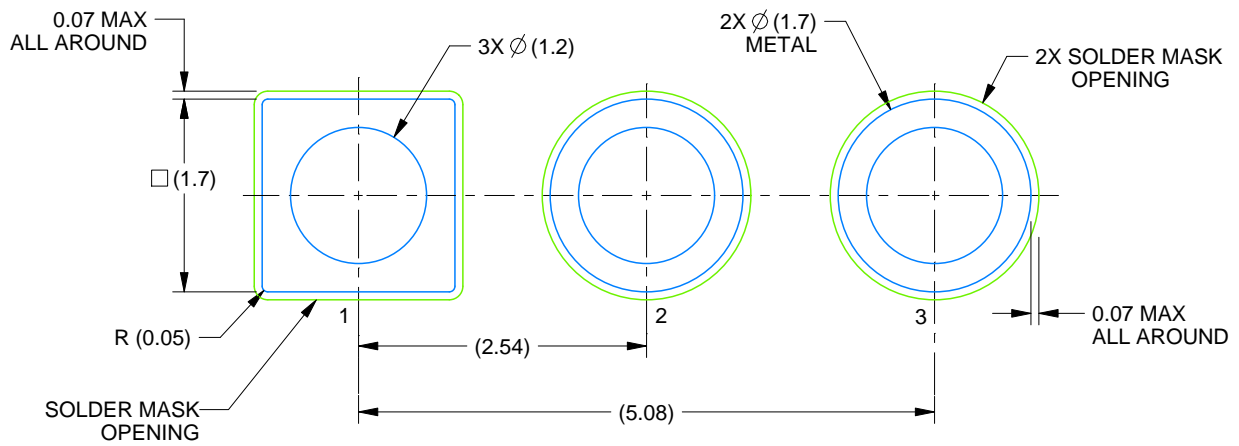

LAND PATTERN EXAMPLE
NON-SOLDER MASK DEFINED
SCALE:15X

4222214/B 08/2018

重要通知和免责声明

TI“按原样”提供技术和可靠性数据（包括数据表）、设计资源（包括参考设计）、应用或其他设计建议、网络工具、安全信息和其他资源，不保证没有瑕疵且不做任何明示或暗示的担保，包括但不限于对适销性、与某特定用途的适用性或不侵犯任何第三方知识产权的暗示担保。

这些资源可供使用 TI 产品进行设计的熟练开发人员使用。您将自行承担以下全部责任：(1) 针对您的应用选择合适的 TI 产品，(2) 设计、验证并测试您的应用，(3) 确保您的应用满足相应标准以及任何其他安全、安保法规或其他要求。

这些资源如有变更，恕不另行通知。TI 授权您仅可将这些资源用于研发本资源所述的 TI 产品的相关应用。严禁以其他方式对这些资源进行复制或展示。您无权使用任何其他 TI 知识产权或任何第三方知识产权。对于因您对这些资源的使用而对 TI 及其代表造成的任何索赔、损害、成本、损失和债务，您将全额赔偿，TI 对此概不负责。

TI 提供的产品受 [TI 销售条款](#)、[TI 通用质量指南](#) 或 [ti.com](#) 上其他适用条款或 TI 产品随附的其他适用条款的约束。TI 提供这些资源并不会扩展或以其他方式更改 TI 针对 TI 产品发布的适用的担保或担保免责声明。除非德州仪器 (TI) 明确将某产品指定为定制产品或客户特定产品，否则其产品均为按确定价格收入目录的标准通用器件。

TI 反对并拒绝您可能提出的任何其他或不同的条款。

版权所有 © 2025，德州仪器 (TI) 公司

最后更新日期：2025 年 10 月