

CSD17581Q5A 30V N 沟道 NexFET™ 功率 MOSFET

1 特性

- 低 Q_g 和 Q_{gd}
- 低 $R_{DS(on)}$
- 低热阻抗
- 雪崩级
- 无铅引脚镀层
- 符合 RoHS 环保标准
- 无卤素
- 小外形尺寸无引线 (SON) 5mm x 6mm 塑料封装

2 应用范围

- 用于网络互联、电信和计算系统的负载点同步降压转换器
- 针对控制场效应晶体管 (FET) 应用进行了优化

3 说明

这款采用 5mm x 6mm SON 封装的 30V、2.9mΩ、NexFET™ 功率 MOSFET 被设计成在功率转换应用中大大降低损耗。

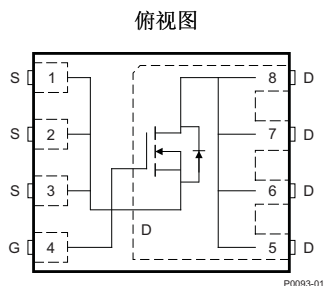

产品概要

$T_A = 25^\circ\text{C}$		典型值		单位
V_{DS}	漏源极电压	30		V
Q_g	栅极电荷总量 (4.5V)	20		nC
Q_{gd}	栅极电荷 栅极到漏极	4		nC
$R_{DS(on)}$	漏源导通电阻	$V_{GS} = 4.5\text{V}$	3.5	mΩ
		$V_{GS} = 10\text{V}$	2.9	mΩ
$V_{GS(th)}$	阈值电压	1.3		V

器件信息(1)

器件	包装介质	数量	封装	运输
CSD17581Q5A	13 英寸卷带	2500	SON 5.00mm x 6.00mm 塑料封装	卷带式
CSD17581Q5AT	7 英寸卷带	250		

(1) 要了解所有可用封装，请见数据表末尾的可订购产品附录。

绝对最大额定值

$T_A = 25^\circ\text{C}$		值	单位
V_{DS}	漏源极电压	30	V
V_{GS}	栅源电压	± 20	V
I_D	持续漏极电流 (受封装限制)	60	A
	持续漏极电流 (受芯片限制), $T_C = 25^\circ\text{C}$ 时测得	123	
	持续漏极电流(1)	24	
I_{DM}	脉冲漏极电流(2)	256	A
P_D	功率耗散(1)	3.1	W
	功率耗散, $T_C = 25^\circ\text{C}$	83	
T_J, T_{stg}	工作结温, 储存温度	-55 至 150	$^\circ\text{C}$
E_{AS}	雪崩能量, 单一脉冲 $I_D = 39\text{A}, L = 0.1\text{mH}, R_G = 25\Omega$	76	mJ

(1) $R_{\theta JA} = 40^\circ\text{C}/\text{W}$ ，这是在一块厚度为 0.06 英寸环氧树脂 (FR4) 印刷电路板 (PCB) 上的 1 英寸²，2 盎司铜焊盘上测得的典型值。

(2) 最大 $R_{\theta JC} = 1.5^\circ\text{C}/\text{W}$ ，脉冲持续时间 $\leq 100\mu\text{s}$ ，占空比 $\leq 1\%$

$R_{DS(on)}$ 与 V_{GS} 间的关系

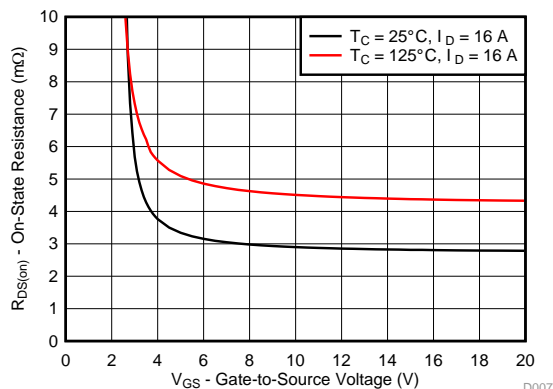

栅极电荷

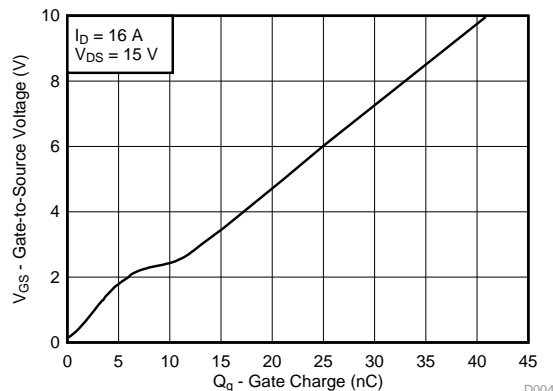

目录

1	特性	1	6.1	接收文档更新通知	7
2	应用范围	1	6.2	社区资源	7
3	说明	1	6.3	商标	7
4	修订历史记录	2	6.4	静电放电警告	7
5	Specifications	3	6.5	Glossary	7
	5.1 Electrical Characteristics	3	7	机械、封装和可订购信息	8
	5.2 Thermal Information	3	7.1	Q5A 封装尺寸	8
	5.3 Typical MOSFET Characteristics	4	7.2	建议印刷电路板 (PCB) 布局	9
6	器件和文档支持	7	7.3	建议模板开口	10
			7.4	Q5A 卷带信息	10

4 修订历史记录

日期	修订版本	注释
2016 年 9 月	*	最初发布。

5 Specifications

5.1 Electrical Characteristics

 $T_A = 25^\circ\text{C}$ (unless otherwise stated)

PARAMETER		TEST CONDITIONS	MIN	TYP	MAX	UNIT
STATIC CHARACTERISTICS						
V_{DSS}	Drain-to-source voltage	$V_{GS} = 0\text{ V}, I_D = 250\ \mu\text{A}$	30			V
I_{DSS}	Drain-to-source leakage current	$V_{GS} = 0\text{ V}, V_{DS} = 24\text{ V}$			1	μA
I_{GSS}	Gate-to-source leakage current	$V_{DS} = 0\text{ V}, V_{GS} = 20\text{ V}$			100	nA
$V_{GS(th)}$	Gate-to-source threshold voltage	$V_{DS} = V_{GS}, I_D = 250\ \mu\text{A}$	1.0	1.3	1.7	V
$R_{DS(on)}$	Drain-to-source on-resistance	$V_{GS} = 4.5\text{ V}, I_D = 16\text{ A}$		3.5	4.2	m Ω
		$V_{GS} = 10\text{ V}, I_D = 16\text{ A}$		2.9	3.4	m Ω
g_{fs}	Transconductance	$V_{DS} = 3\text{ V}, I_D = 16\text{ A}$		85		S
DYNAMIC CHARACTERISTICS						
C_{iss}	Input capacitance	$V_{GS} = 0\text{ V}, V_{DS} = 15\text{ V}, f = 1\text{ MHz}$		2800	3640	pF
C_{oss}	Output capacitance			342	445	pF
C_{rss}	Reverse transfer capacitance			150	195	pF
R_G	Series gate resistance			1.8	3.6	Ω
Q_g	Gate charge total (4.5 V)	$V_{DS} = 15\text{ V}, I_D = 16\text{ A}$		20	25	nC
Q_g	Gate charge total (10 V)			41	54	
Q_{gd}	Gate charge gate-to-drain			4.0		nC
Q_{gs}	Gate charge gate-to-source			6.9		nC
$Q_{g(th)}$	Gate charge at V_{th}			3.6		nC
Q_{oss}	Output charge		$V_{DS} = 15\text{ V}, V_{GS} = 0\text{ V}$		11.7	
$t_{d(on)}$	Turnon delay time	$V_{DS} = 15\text{ V}, V_{GS} = 10\text{ V}, I_{DS} = 16\text{ A}, R_G = 0\ \Omega$		12		ns
t_r	Rise time			21		ns
$t_{d(off)}$	Turnoff delay time			25		ns
t_f	Fall time			10		ns
DIODE CHARACTERISTICS						
V_{SD}	Diode forward voltage	$I_{SD} = 16\text{ A}, V_{GS} = 0\text{ V}$		0.8	1.0	V
Q_{rr}	Reverse recovery charge	$V_{DS} = 15\text{ V}, I_F = 16\text{ A}, di/dt = 300\text{ A}/\mu\text{s}$		13		nC
t_{rr}	Reverse recovery time			11		ns

5.2 Thermal Information

 $T_A = 25^\circ\text{C}$ (unless otherwise stated)

THERMAL METRIC		MIN	TYP	MAX	UNIT
$R_{\theta JC}$	Junction-to-case thermal resistance ⁽¹⁾			1.5	$^\circ\text{C}$
$R_{\theta JA}$	Junction-to-ambient thermal resistance ⁽¹⁾⁽²⁾			50	

- $R_{\theta JC}$ is determined with the device mounted on a 1-in² (6.45-cm²), 2-oz (0.071-mm) thick Cu pad on a 1.5-in × 1.5-in (3.81-cm × 3.81-cm), 0.06-in (1.52-mm) thick FR4 PCB. $R_{\theta JC}$ is specified by design, whereas $R_{\theta JA}$ is determined by the user's board design.
- Device mounted on FR4 material with 1-in² (6.45-cm²), 2-oz (0.071-mm) thick Cu.



Max $R_{\theta JA} = 50^{\circ}\text{C/W}$
when mounted on 1-in²
(6.45-cm²) of
2-oz (0.071-mm) thick
Cu.



Max $R_{\theta JA} = 125^{\circ}\text{C/W}$
when mounted on a
minimum pad area of
2-oz (0.071-mm) thick
Cu.

5.3 Typical MOSFET Characteristics

$T_A = 25^{\circ}\text{C}$ (unless otherwise stated)

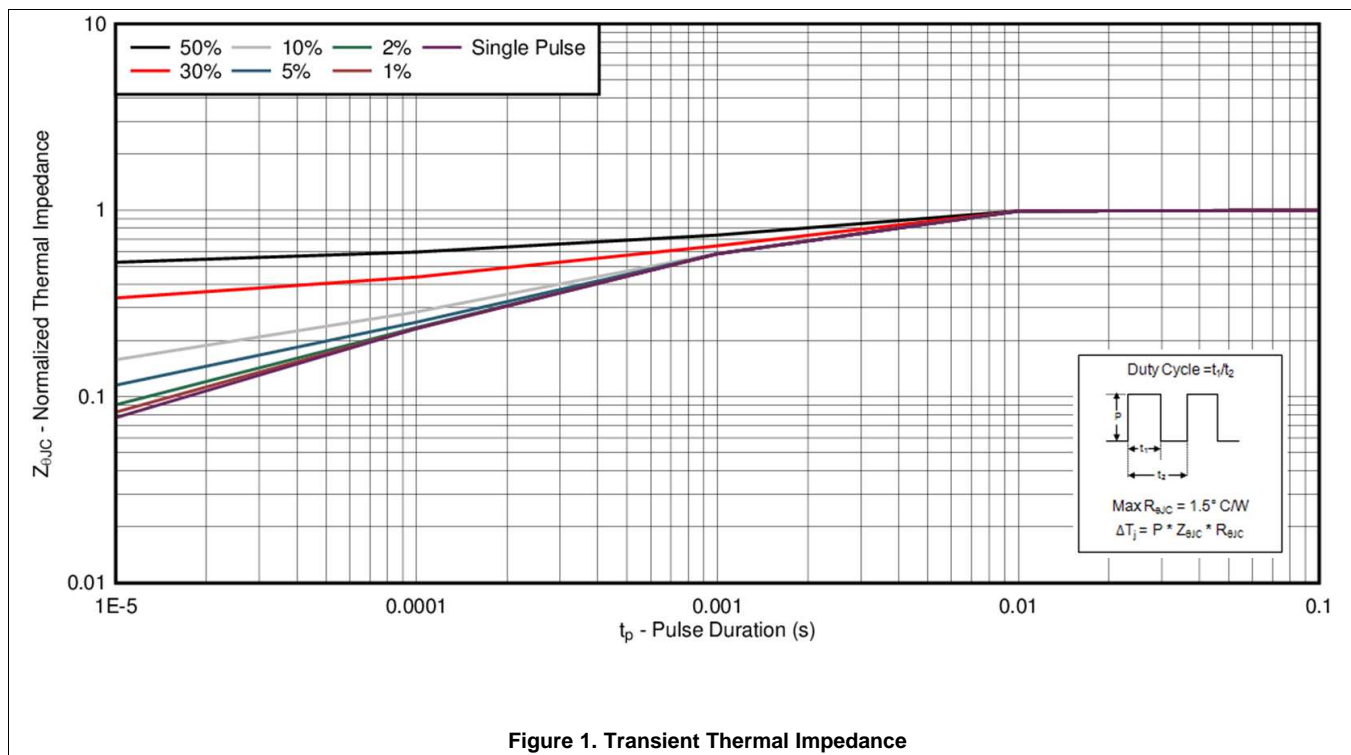

Typical MOSFET Characteristics (continued)

T_A = 25°C (unless otherwise stated)

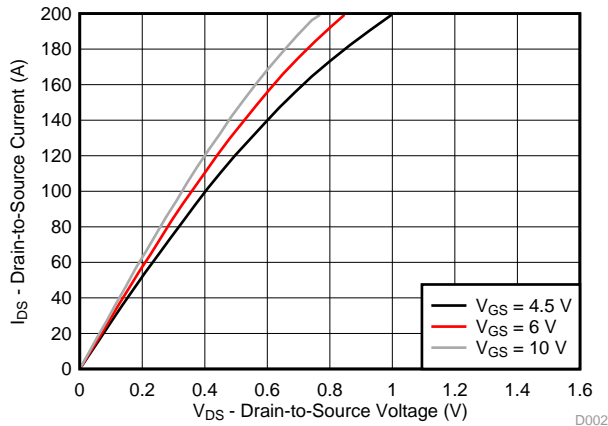

Figure 2. Saturation Characteristics

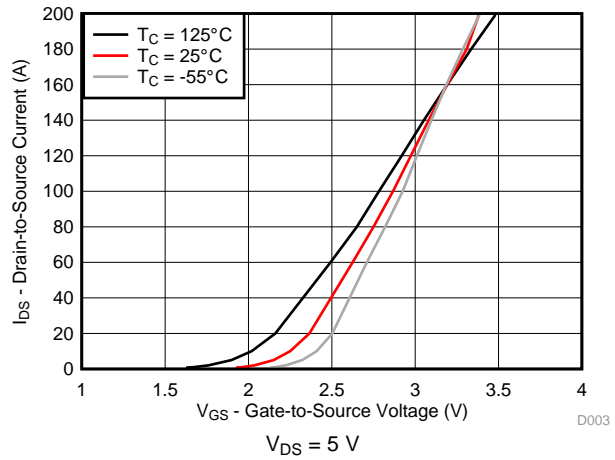

Figure 3. Transfer Characteristics

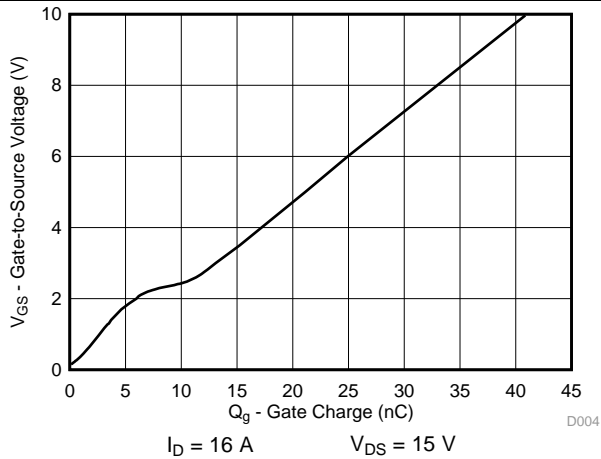

Figure 4. Gate Charge

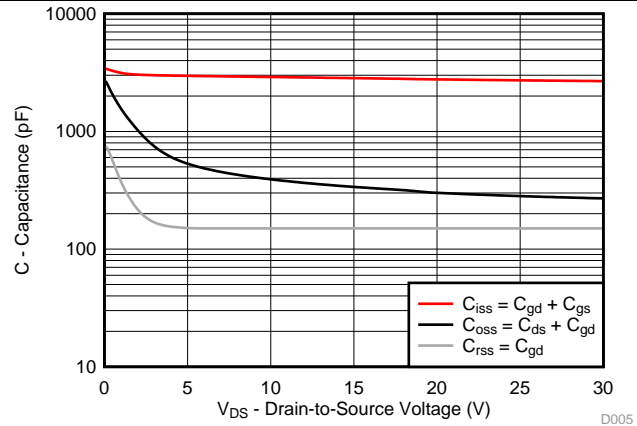

Figure 5. Capacitance

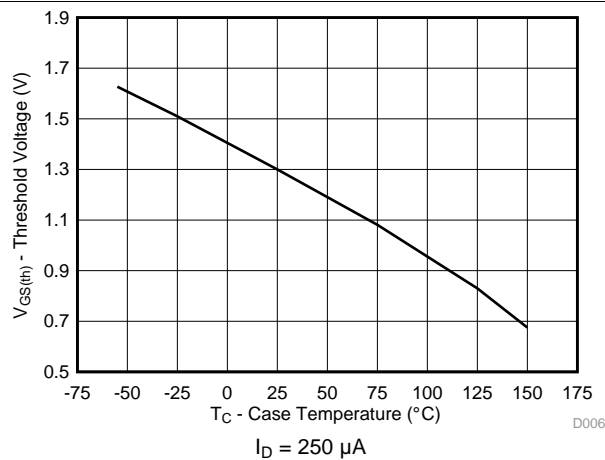

Figure 6. Threshold Voltage vs Temperature

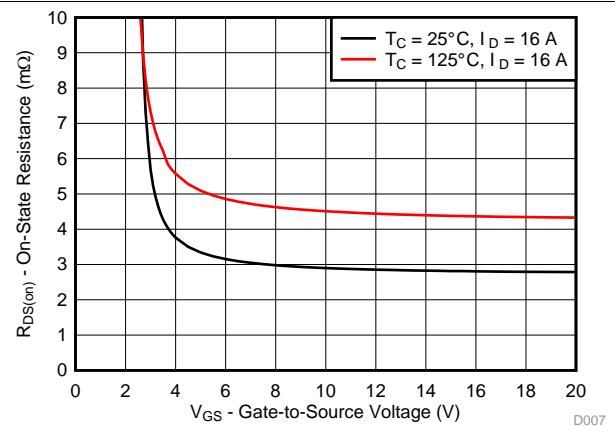

Figure 7. On-State Resistance vs Gate-to-Source Voltage

Typical MOSFET Characteristics (continued)

T_A = 25°C (unless otherwise stated)

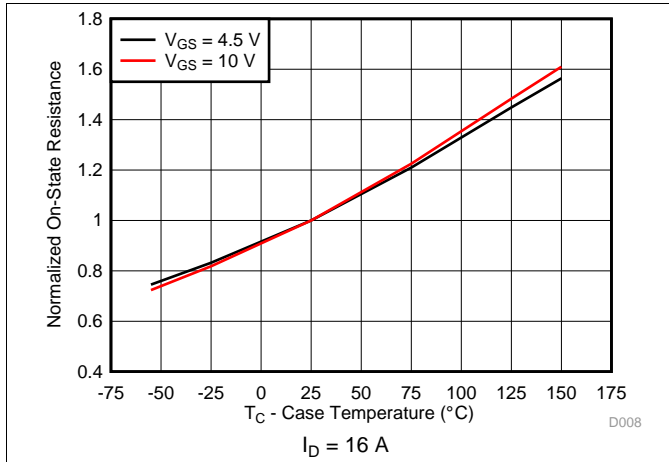

Figure 8. Normalized On-State Resistance vs Temperature

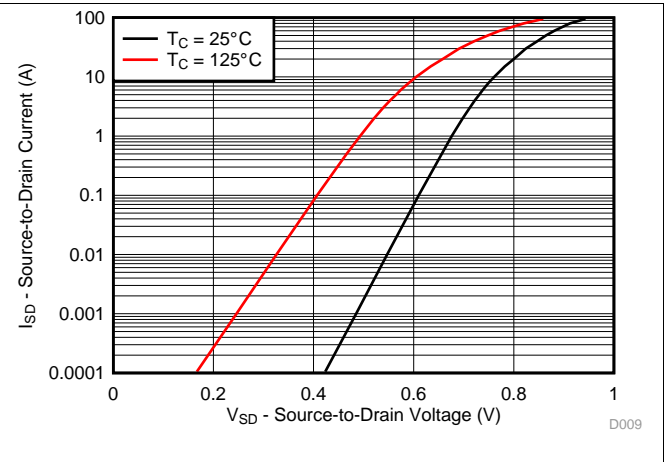

Figure 9. Typical Diode Forward Voltage

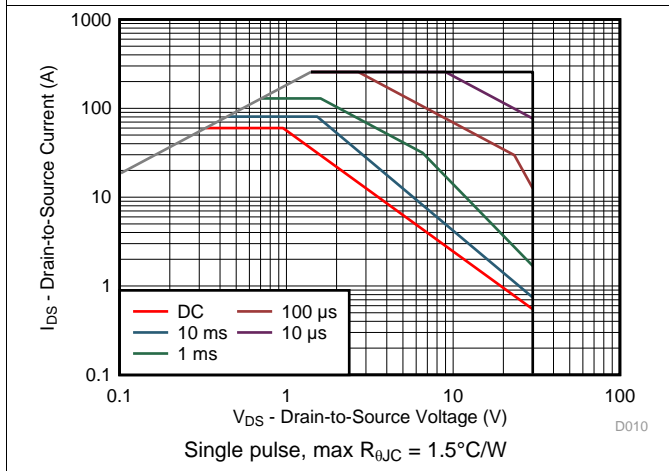

Figure 10. Maximum Safe Operating Area (SOA)

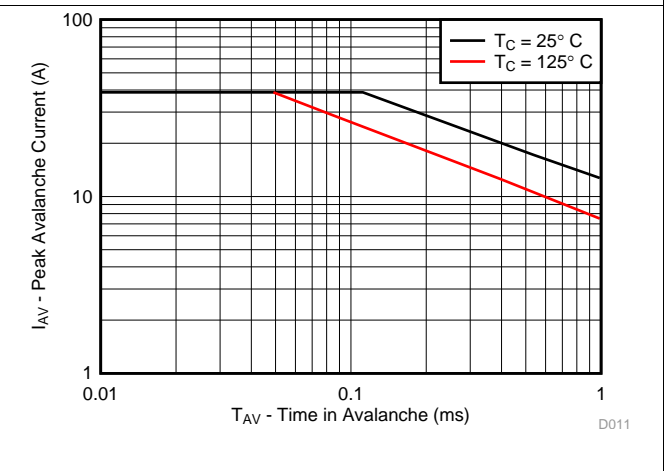

Figure 11. Single Pulse Unclamped Inductive Switching

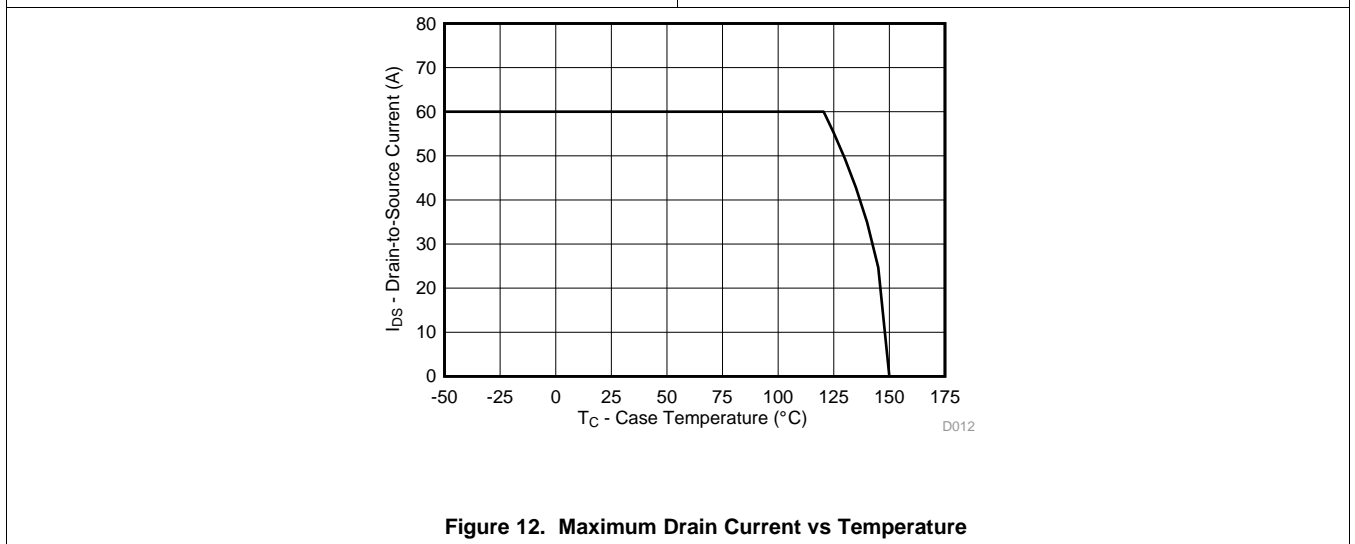

Figure 12. Maximum Drain Current vs Temperature

6 器件和文档支持

6.1 接收文档更新通知

如需接收文档更新通知，请访问 www.ti.com.cn 网站上的器件产品文件夹。点击右上角的提醒我 (Alert me) 注册后，即可每周定期收到已更改的产品信息。有关更改的详细信息，请查阅已修订文档中包含的修订历史记录。

6.2 社区资源

The following links connect to TI community resources. Linked contents are provided "AS IS" by the respective contributors. They do not constitute TI specifications and do not necessarily reflect TI's views; see TI's [Terms of Use](#).

TI E2E™ Online Community *TI's Engineer-to-Engineer (E2E) Community*. Created to foster collaboration among engineers. At e2e.ti.com, you can ask questions, share knowledge, explore ideas and help solve problems with fellow engineers.

Design Support *TI's Design Support* Quickly find helpful E2E forums along with design support tools and contact information for technical support.

6.3 商标

NexFET, E2E are trademarks of Texas Instruments.
All other trademarks are the property of their respective owners.

6.4 静电放电警告



这些装置包含有限的内置 ESD 保护。存储或装卸时，应将导线一起截短或将装置放置于导电泡棉中，以防止 MOS 门极遭受静电损伤。

6.5 Glossary

[SLYZ022](#) — *TI Glossary*.

This glossary lists and explains terms, acronyms, and definitions.

7 机械、封装和可订购信息

以下页中包括机械、封装和可订购信息。这些信息是针对指定器件可提供的最新数据。这些数据会在无通知且不对本文档进行修订的情况下发生改变。欲获得该数据表的浏览器版本，请查阅左侧的导航栏

7.1 Q5A 封装尺寸

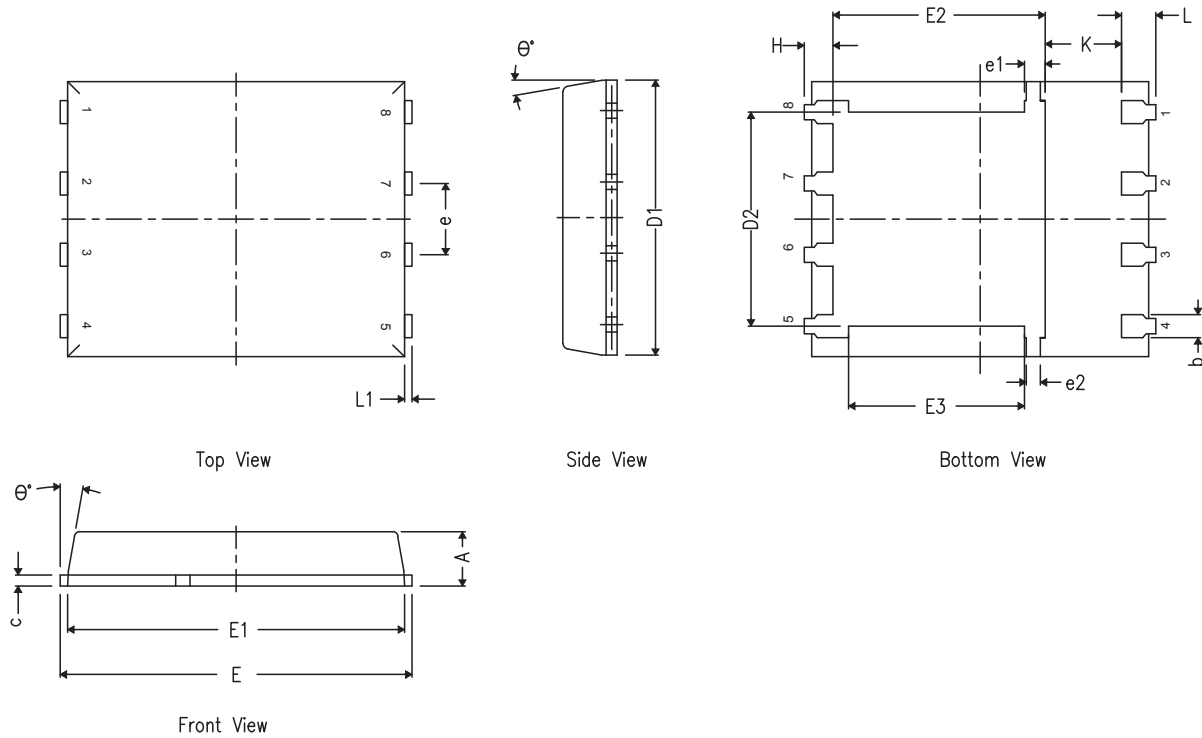

DIM	毫米		
	最小值	标称值	最大值
A	0.90	1.00	1.10
b	0.33	0.41	0.51
c	0.20	0.25	0.34
D1	4.80	4.90	5.00
D2	3.61	3.81	4.02
E	5.90	6.00	6.10
E1	5.70	5.75	5.80
E2	3.38	3.58	3.78
E3	3.03	3.13	3.23
e	1.17	1.27	1.37
e1	0.27	0.37	0.47
e2	0.15	0.25	0.35
H	0.41	0.56	0.71
K	1.10	—	—
L	0.51	0.61	0.71
L1	0.06	0.13	0.20
θ	0°	—	12°

7.2 建议印刷电路板 (PCB) 布局

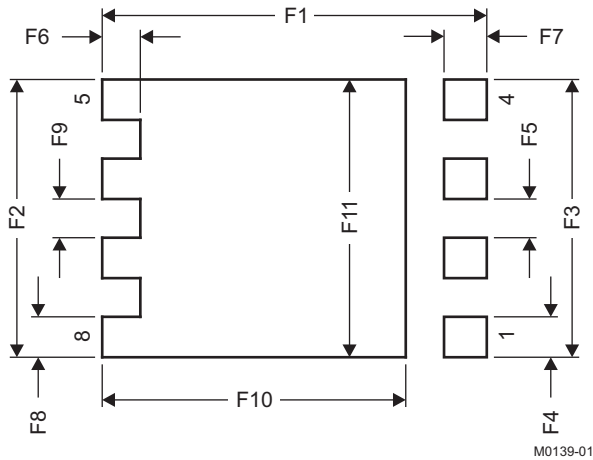

DIM	毫米		英寸	
	最小值	最大值	最小值	最大值
F1	6.205	6.305	0.244	0.248
F2	4.46	4.56	0.176	0.18
F3	4.46	4.56	0.176	0.18
F4	0.65	0.7	0.026	0.028
F5	0.62	0.67	0.024	0.026
F6	0.63	0.68	0.025	0.027
F7	0.7	0.8	0.028	0.031
F8	0.65	0.7	0.026	0.028
F9	0.62	0.67	0.024	0.026
F10	4.9	5	0.193	0.197
F11	4.46	4.56	0.176	0.18

要获得与印刷电路板 (PCB) 设计相关的建议电路布局布线, 请参见《应用说明》[SLPA005](#) - 通过 PCB 布局布线技巧来减少振铃。

7.3 建议模板开口

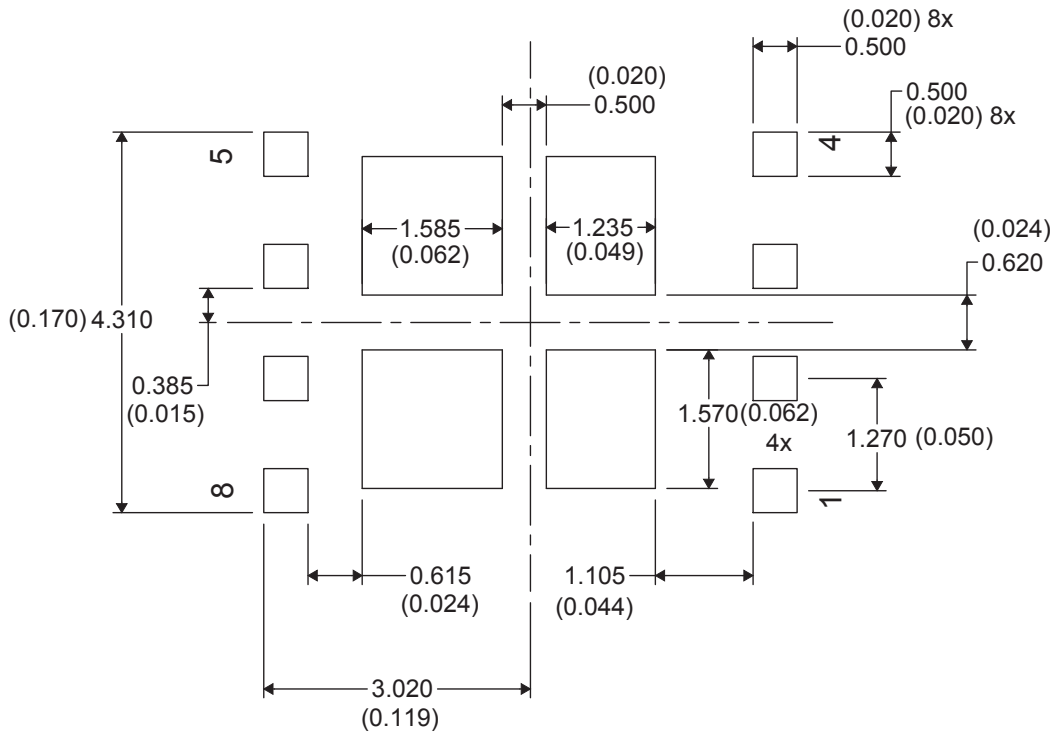

7.4 Q5A 卷带信息



M0138-01

注:

1. 10 链轮孔距累积容差 ± 0.2
2. 每 100mm 长度的翘曲不能超过 1mm, 在 250mm 长度上不累积 (Camber not to exceed 1 mm in 100 mm, noncumulative over 250 mm)
3. 材料: 黑色抗静电聚苯乙烯
4. 全部尺寸单位为 mm (除非另外注明)

Q5A 卷带信息 (接下页)

5. 高于孔眼底部 0.3mm 的平面上测量得到 A0 和 B0 值

PACKAGING INFORMATION

Orderable part number	Status (1)	Material type (2)	Package Pins	Package qty Carrier	RoHS (3)	Lead finish/ Ball material (4)	MSL rating/ Peak reflow (5)	Op temp (°C)	Part marking (6)
CSD17581Q5A	Active	Production	VSONP (DQJ) 8	2500 LARGE T&R	ROHS Exempt	SN	Level-1-260C-UNLIM	-55 to 150	CSD17581
CSD17581Q5A.B	Active	Production	VSONP (DQJ) 8	2500 LARGE T&R	ROHS Exempt	SN	Level-1-260C-UNLIM	-55 to 150	CSD17581
CSD17581Q5AT	Active	Production	VSONP (DQJ) 8	250 SMALL T&R	ROHS Exempt	SN	Level-1-260C-UNLIM	-55 to 150	CSD17581
CSD17581Q5AT.B	Active	Production	VSONP (DQJ) 8	250 SMALL T&R	ROHS Exempt	SN	Level-1-260C-UNLIM	-55 to 150	CSD17581

(1) **Status:** For more details on status, see our [product life cycle](#).

(2) **Material type:** When designated, preproduction parts are prototypes/experimental devices, and are not yet approved or released for full production. Testing and final process, including without limitation quality assurance, reliability performance testing, and/or process qualification, may not yet be complete, and this item is subject to further changes or possible discontinuation. If available for ordering, purchases will be subject to an additional waiver at checkout, and are intended for early internal evaluation purposes only. These items are sold without warranties of any kind.

(3) **RoHS values:** Yes, No, RoHS Exempt. See the [TI RoHS Statement](#) for additional information and value definition.

(4) **Lead finish/Ball material:** Parts may have multiple material finish options. Finish options are separated by a vertical ruled line. Lead finish/Ball material values may wrap to two lines if the finish value exceeds the maximum column width.

(5) **MSL rating/Peak reflow:** The moisture sensitivity level ratings and peak solder (reflow) temperatures. In the event that a part has multiple moisture sensitivity ratings, only the lowest level per JEDEC standards is shown. Refer to the shipping label for the actual reflow temperature that will be used to mount the part to the printed circuit board.

(6) **Part marking:** There may be an additional marking, which relates to the logo, the lot trace code information, or the environmental category of the part.

Multiple part markings will be inside parentheses. Only one part marking contained in parentheses and separated by a "~" will appear on a part. If a line is indented then it is a continuation of the previous line and the two combined represent the entire part marking for that device.

Important Information and Disclaimer: The information provided on this page represents TI's knowledge and belief as of the date that it is provided. TI bases its knowledge and belief on information provided by third parties, and makes no representation or warranty as to the accuracy of such information. Efforts are underway to better integrate information from third parties. TI has taken and continues to take reasonable steps to provide representative and accurate information but may not have conducted destructive testing or chemical analysis on incoming materials and chemicals. TI and TI suppliers consider certain information to be proprietary, and thus CAS numbers and other limited information may not be available for release.

In no event shall TI's liability arising out of such information exceed the total purchase price of the TI part(s) at issue in this document sold by TI to Customer on an annual basis.

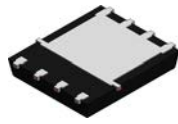

PACKAGE OUTLINE

DQJ0008A

VSONP - 1.1 mm max height

PLASTIC SMALL OUTLINE - NO LEAD

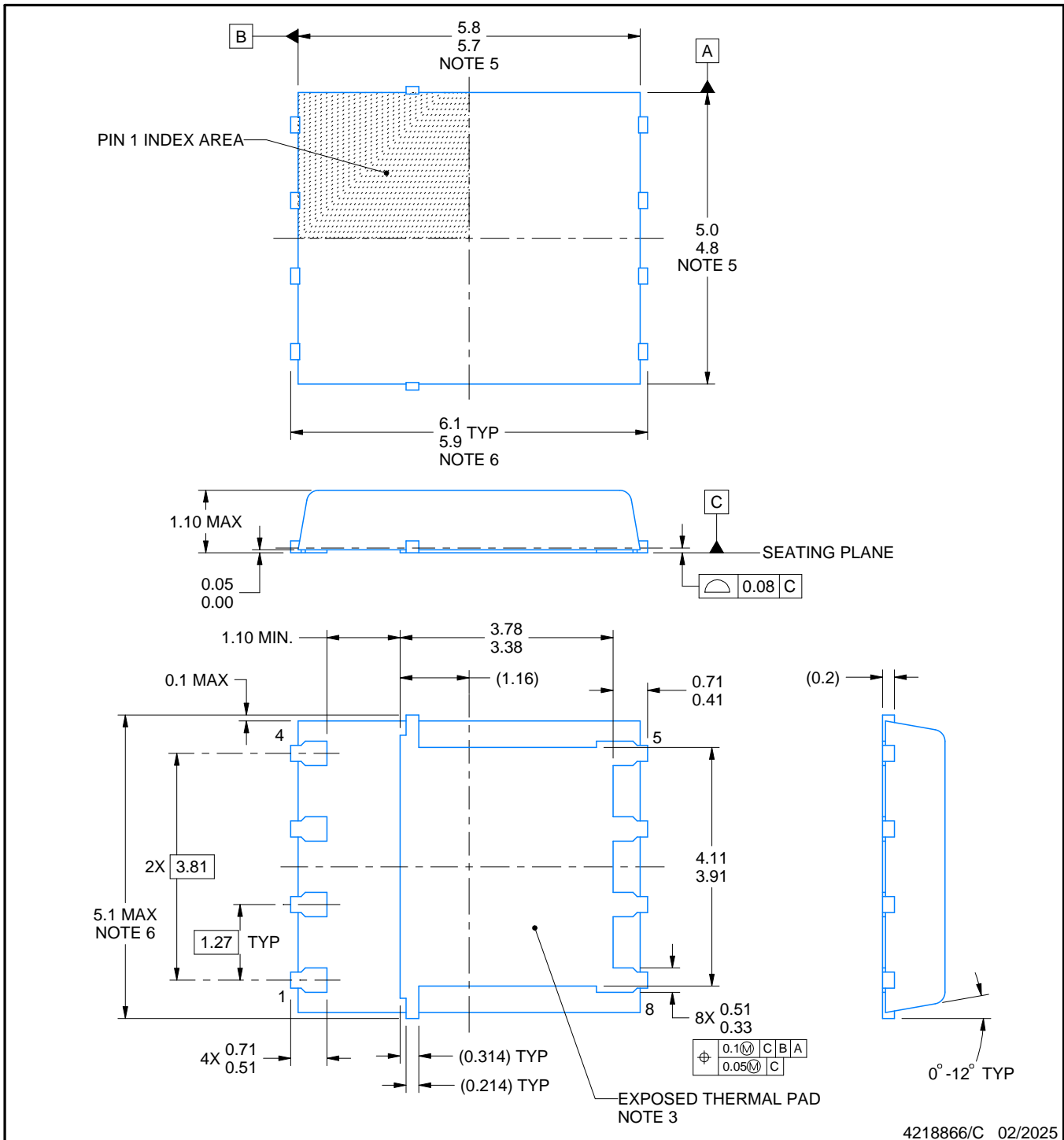

4218866/C 02/2025

NOTES:

1. All linear dimensions are in millimeters. Any dimensions in parenthesis are for reference only. Dimensioning and tolerancing per ASME Y14.5M.
2. This drawing is subject to change without notice.
3. The package thermal pad must be soldered to the printed circuit board for thermal and mechanical performance.
4. Metalized features are supplier options and may not be on the package.
5. These dimensions do not include mold flash protrusions or gate burrs.
6. These dimensions include interterminal flash or protrusion. Interterminal flash or protrusion shall not exceed 0.25 mm per side.

EXAMPLE BOARD LAYOUT

DQJ0008A

VSONP - 1.1 mm max height

PLASTIC SMALL OUTLINE - NO LEAD

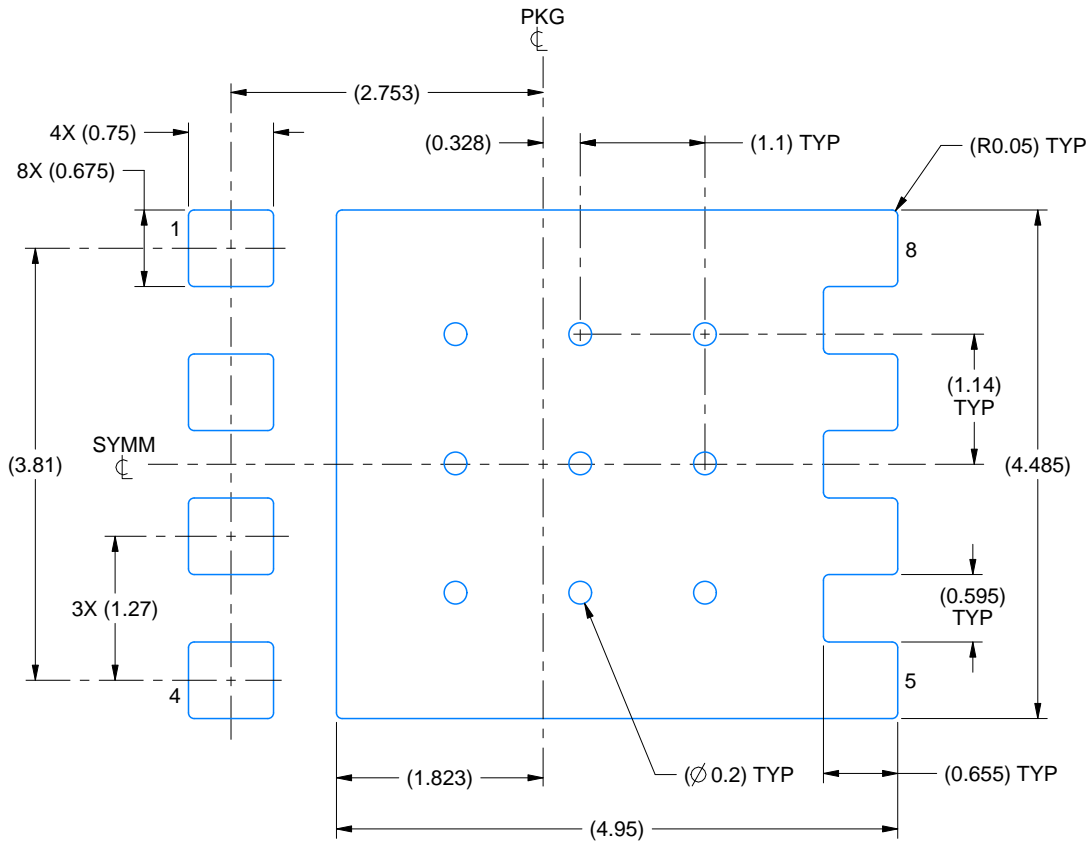

LAND PATTERN EXAMPLE
SOLDER MASK DEFINED
SCALE: 15X

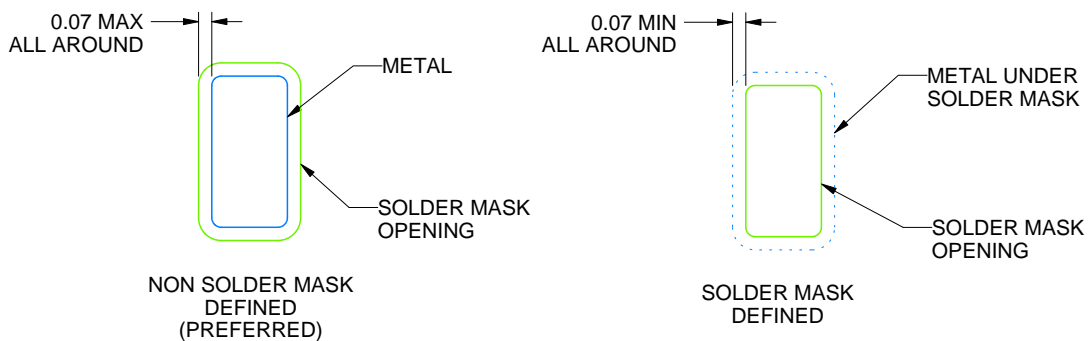

SOLDER MASK DETAILS

4218866/C 02/2025

NOTES: (continued)

7. This package is designed to be soldered to a thermal pad on the board. For more information, see Texas Instruments literature number SLUA271 (www.ti.com/lit/slua271).
8. Vias are optional depending on application, refer to device data sheet. If some or all are implemented, recommended via locations are shown.

EXAMPLE STENCIL DESIGN

DQJ0008A

VSONP - 1.1 mm max height

PLASTIC SMALL OUTLINE - NO LEAD

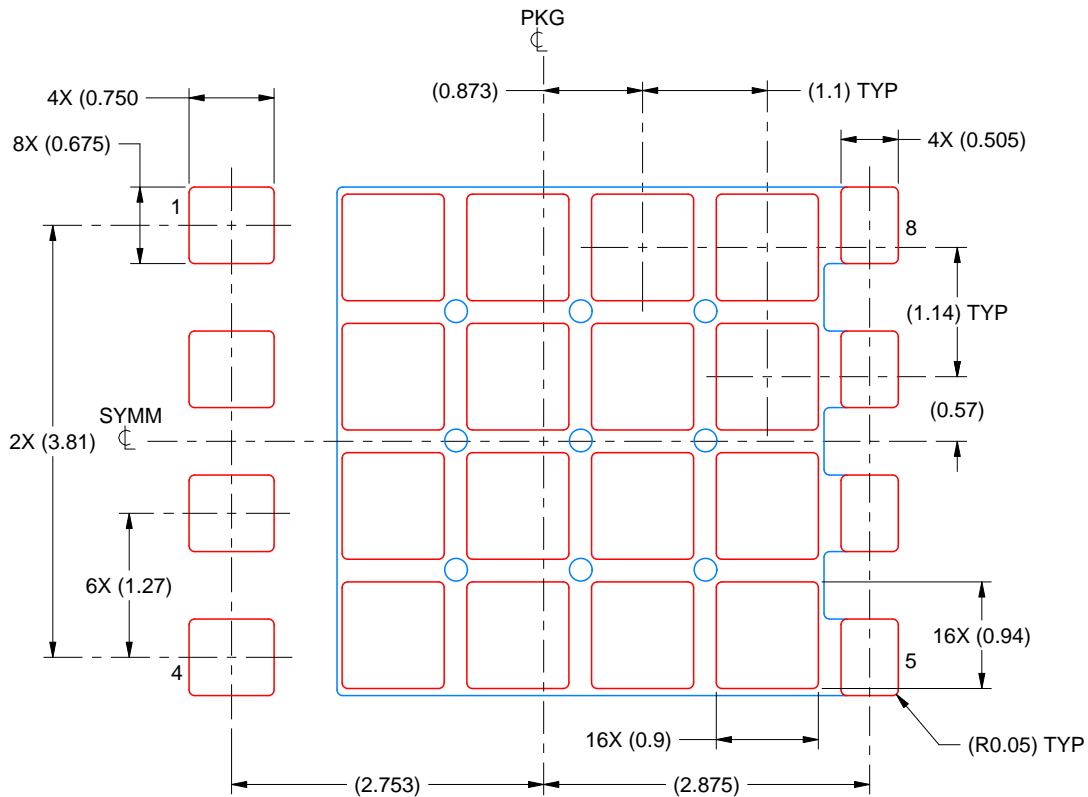

SOLDER PASTE EXAMPLE
BASED ON 0.125 mm THICK STENCIL

EXPOSED PAD:
70% PRINTED SOLDER COVERAGE BY AREA UNDER PACKAGE
SCALE: 15X

4218866/C 02/2025

NOTES: (continued)

9. Laser cutting apertures with trapezoidal walls and rounded corners may offer better paste release. IPC-7525 may have alternate design recommendations.

重要通知和免责声明

TI“按原样”提供技术和可靠性数据（包括数据表）、设计资源（包括参考设计）、应用或其他设计建议、网络工具、安全信息和其他资源，不保证没有瑕疵且不做任何明示或暗示的担保，包括但不限于对适销性、与某特定用途的适用性或不侵犯任何第三方知识产权的暗示担保。

这些资源可供使用 TI 产品进行设计的熟练开发人员使用。您将自行承担以下全部责任：(1) 针对您的应用选择合适的 TI 产品，(2) 设计、验证并测试您的应用，(3) 确保您的应用满足相应标准以及任何其他安全、安保法规或其他要求。

这些资源如有变更，恕不另行通知。TI 授权您仅可将这些资源用于研发本资源所述的 TI 产品的相关应用。严禁以其他方式对这些资源进行复制或展示。您无权使用任何其他 TI 知识产权或任何第三方知识产权。对于因您对这些资源的使用而对 TI 及其代表造成的任何索赔、损害、成本、损失和债务，您将全额赔偿，TI 对此概不负责。

TI 提供的产品受 [TI 销售条款](#)、[TI 通用质量指南](#) 或 [ti.com](#) 上其他适用条款或 TI 产品随附的其他适用条款的约束。TI 提供这些资源并不会扩展或以其他方式更改 TI 针对 TI 产品发布的适用的担保或担保免责声明。除非德州仪器 (TI) 明确将某产品指定为定制产品或客户特定产品，否则其产品均为按确定价格收入目录的标准通用器件。

TI 反对并拒绝您可能提出的任何其他或不同的条款。

版权所有 © 2025，德州仪器 (TI) 公司

最后更新日期：2025 年 10 月