

## CDx4AC24x、CDx4ACT24x 三态、八通道缓冲器/线路驱动器

### 1 特性

- 防 SCR 闩锁 CMOS 工艺和电路设计
- 具有双极 FAST /AS/S 的速度，同时功耗显著降低
- 平衡传播延迟
- 交流类型的工作电压范围为 1.5V 至 5.5V，并在电源电压的 30% 时具有平衡的抗噪性能
- $\pm 24\text{mA}$  输出驱动电流
  - 扇出到 15 个 FAST\* IC
  - 驱动  $50\ \Omega$  传输线

### 2 说明

RCA CD54/74AC240、CD54/74AC241 和 CD54/74AC244 以及 CD54/74ACT240、CD54/74ACT241 和 CD54/74ACT244 三态八通道缓冲器/线路驱动器采用 RCA 的高级 CMOS 技术。

#### 器件信息

器件型号	封装 <sup>(1)</sup>	封装尺寸 <sup>(2)</sup>	本体尺寸 <sup>(3)</sup>
CDx4AC/ACT24x	DW (SOIC, 20)	12.8mm x 10.3mm	12.8mm x 7.5mm
	N (PDIP, 20)	24.33mm x 9.4mm	24.33mm x 6.35mm

- (1) 有关更多信息，请参阅第 10 节。
- (2) 封装尺寸 (长 × 宽) 为标称值，并包括引脚 (如适用)。
- (3) 本体尺寸 (长 × 宽) 为标称值，不包括引脚。



简化版原理图

\*FAST 是 Fairchild Semiconductor Corp. 的注册商标。



本资源的原文使用英文撰写。为方便起见，TI 提供了译文；由于翻译过程中可能使用了自动化工具，TI 不保证译文的准确性。为确认准确性，请务必访问 [ti.com](http://ti.com) 参考最新的英文版本 (控制文档)。

## Table of Contents

<b>1 特性</b> .....	1	6.3 Device Functional Modes.....	12
<b>2 说明</b> .....	1	<b>7 Application and Implementation</b> .....	14
<b>3 Pin Configuration and Functions</b> .....	3	7.1 Power Supply Recommendations.....	14
<b>4 Specifications</b> .....	5	7.2 Layout.....	14
4.1 Absolute Maximum Ratings.....	5	<b>8 Device and Documentation Support</b> .....	15
4.2 Recommended Operating Conditions.....	5	8.1 Documentation Support (Analog).....	15
4.3 Thermal Information.....	5	8.2 接收文档更新通知.....	15
4.4 Static Electrical Characteristics: AC Series.....	6	8.3 支持资源.....	15
4.5 Electrical Characteristics: ACT Series.....	7	8.4 Trademarks.....	15
4.6 Switching Characteristics: AC Series.....	8	8.5 静电放电警告.....	15
4.7 Switching Characteristics: ACT Series.....	8	8.6 术语表.....	15
<b>5 Parameter Measurement Information</b> .....	10	<b>9 Revision History</b> .....	15
<b>6 Detailed Description</b> .....	12	<b>10 Mechanical, Packaging, and Orderable Information</b> .....	16
6.1 Overview.....	12		
6.2 Functional Block Diagram.....	12		

### 3 Pin Configuration and Functions



图 3-1. CD54/74AC, ACT240 Types Terminal Assignment



图 3-2. CD54/74AC, ACT241 Types Terminal Assignment

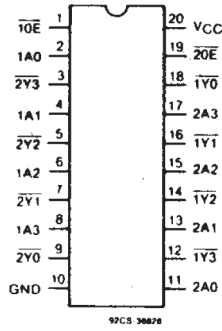

图 3-3. CD54/74AC, ACT244 Types Terminal Assignment

表 3-1. Pin Functions

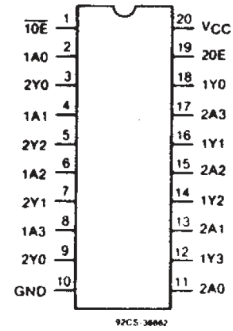
PIN		TYPE <sup>(1)</sup>	DESCRIPTION
NO.	NAME		
1OE	1	I	Bank 1, output enable, active low
1A0	2	I	Bank 1, channel 1 input
2Y3	3	O	Bank 2, channel 4 output
1A1	4	I	Bank 1, channel 2 input
2Y2	5	O	Bank 2, channel 3 output
1A2	6	I	Bank 1, channel 3 input
2Y1	7	O	Bank 2, channel 2 output
1A3	8	I	Bank 1, channel 4 input
2Y0	9	O	Bank 2, channel 1 output
GND	10	G	Ground
2A0	11	I	Bank 2, channel 1 input
1Y3	12	O	Bank 1, channel 4 output
2A1	13	I	Bank 2, channel 2 input
1Y2	14	O	Bank 1, channel 3 output
2A2	15	I	Bank 2, channel 3 input
1Y1	16	O	Bank 1, channel 2 output
2A3	17	I	Bank 2, channel 4 input
1Y0	18	O	Bank 1, channel 1 output
2OE	19	I	Bank 2, output enable, active low
V <sub>CC</sub>	20	P	Positive supply
Thermal pad <sup>(2)</sup>		—	The thermal pad can be connected to GND or left floating. Do not connect to any other signal or supply

(1) I = input, O = output, I/O = input or output, G = ground, P = power.

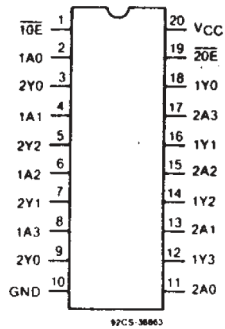
(2) RKS package only.

## 4 Specifications

### 4.1 Absolute Maximum Ratings

over operating free-air temperature range (unless otherwise noted)<sup>(1)</sup>

			MIN	MAX	UNIT
V <sub>CC</sub>	Supply voltage		-0.5	6	V
I <sub>IK</sub>	Input diode current	(V <sub>I</sub> < -0.5 V or V <sub>I</sub> > V <sub>CC</sub> + 0.5 V)		±20	mA
I <sub>OK</sub>	Output diode current	(V <sub>O</sub> < -0.5 V or V <sub>O</sub> > V <sub>CC</sub> + 0.5 V)		±50	mA
I <sub>O</sub>	Output source or sink current per output pin	(V <sub>O</sub> > -0.5 V or V <sub>O</sub> < V <sub>CC</sub> + 0.5 V)		±50	mA
	V <sub>CC</sub> or ground current, (I <sub>CC</sub> or I <sub>GND</sub> )			±100	mA <sup>(2)</sup>
T <sub>stg</sub>	Storage temperature		-65	+150	°C

- (1) Operation outside the Absolute Maximum Ratings may cause permanent device damage. Absolute Maximum Ratings do not imply functional operation of the device at these or any other conditions beyond those listed under Recommended Operating Conditions. If used outside the Recommended Operating Conditions but within the Absolute Maximum Ratings, the device may not be fully functional, and this may affect device reliability, functionality, performance, and shorten the device lifetime.
- (2) For up to 4 outputs per device: add ± 25 mA for each additional output.

### 4.2 Recommended Operating Conditions

For maximum reliability, normal operating conditions should be selected so that operation is always within the following ranges:

CHARACTERISTIC			MIN	MAX	UNIT
V <sub>CC</sub> <sup>(1)</sup>	Supply voltage				
	AC Types		1.5	5.5	V
	ACT Types		4.5	5.5	V
V <sub>I</sub> , V <sub>O</sub>	Input or Output Voltage		0	V <sub>CC</sub>	V
T <sub>A</sub>	Operating Temperature	CD54	-55	+125	°C
		CD74	-40	+85	
dt/dv	Input Rise and Fall Slew Rate				
		at 1.5 V to 3 V (AC Types)	0	50	ns/V
		at 3.6 v to 5.5 V (AC Types)	0	20	ns/V
		at 4.5 V to 5.5 V (ACT Types)	0	10	ns/V

- (1) Unless otherwise specified, all voltages are referenced to ground.

### 4.3 Thermal Information

THERMAL METRIC <sup>(1)</sup>		CDx4AC/ACT24x		UNIT
		DW (SOIC)	N (PDIP)	
		20 PINS		
R <sub>θJA</sub>	Junction-to-ambient thermal resistance	101.2	40	°C/W

- (1) For more information about traditional and new thermal metrics, see the *Semiconductor and IC Package Thermal Metrics* application report, [SPRA953](#).

### 4.4 Static Electrical Characteristics: AC Series

CHARACTERISTICS	TEST CONDITIONS		V <sub>CC</sub> (V)	AMBIENT TEMPERATURE (T <sub>A</sub> ) - °C						UNIT
				+25		-40 to +85		-55 to +125		
	V <sub>I</sub> (V)	I <sub>O</sub> (mA)		MIN	MAX	MIN	MAX	MIN	MAX	
V <sub>IH</sub> High-Level Input Voltage			1.5	1.2	—	1.2	—	1.2	—	V
			3	2.1	—	2.1	—	2.1	—	
			5.5	3.85	—	3.85	—	3.85	—	
V <sub>IL</sub> Low-Level Input Voltage			1.5	—	0.3	—	0.3	—	0.3	V
			3	—	0.9	—	0.9	—	0.9	
			5.5	—	1.65	—	1.65	—	1.65	
V <sub>OH</sub> High-Level Output Voltage	V <sub>IH</sub> or V <sub>IL</sub>	-0.05	1.5	1.4	—	1.4	—	1.4	—	V
		-0.05	3	2.9	—	2.9	—	2.9	—	
		-0.05	4.5	4.4	—	4.4	—	4.4	—	
		-4	3	2.58	—	2.48	—	2.4	—	
		-24	4.5	3.94	—	3.8	—	3.7	—	
	(1), (2)	-75	5.5	—	—	3.85	—	—	—	
		-50	5.5	—	—	—	—	3.85	—	
V <sub>OL</sub> Low-Level Output Voltage	V <sub>IH</sub> or V <sub>IL</sub>	0.05	1.5	—	0.1	—	0.1	—	0.1	V
		0.05	3	—	0.1	—	0.1	—	0.1	
		0.05	4.5	—	0.1	—	0.1	—	0.1	
		12	3	—	0.36	—	0.44	—	0.5	
		24	4.5	—	0.36	—	0.44	—	0.5	
	(1), (2)	75	5.5	—	—	—	1.65	—	—	
		50	5.5	—	—	—	—	—	1.65	
I <sub>I</sub> Input Leakage Current	V <sub>CC</sub> or GND		5.5	—	±0.1	—	±1	—	±1	μA
I <sub>oz</sub> 3-State Leakage Current	V <sub>IH</sub> or V <sub>IL</sub> V <sub>O</sub> = V <sub>CC</sub> or GND		5.5	—	±0.5	—	±5	—	±10	μA
I <sub>CC</sub> Quiescent Supply Current, MSI	V <sub>CC</sub> or GND	0	5.5	—	8	—	80	—	160	μA

- (1) Test one output at a time for a 1-second maximum duration. Measurement is made by forcing current and measuring voltage to minimize power dissipation.
- (2) Test verifies a minimum 50-ohm transmission-line-drive capability at +85°C, 75 ohms at +125°C.

### 4.5 Electrical Characteristics: ACT Series

CHARACTERISTICS	TEST CONDITIONS		V <sub>CC</sub> (V)	AMBIENT TEMPERATURE (T <sub>A</sub> ) - °C						UNIT	
				+25		-40 to +85		-55 to +125			
	V <sub>I</sub> (V)	I <sub>O</sub> (mA)		MIN	MAX	MIN	MAX	MIN	MAX		
V <sub>IH</sub>	High-Level Input Voltage		4.5 to 5.5	2	—	2	—	2	—	V	
V <sub>IL</sub>	Low-Level Input Voltage		4.5 to 5.5	—	0.8	—	0.8	—	0.8	V	
V <sub>OH</sub>	High-Level Output Voltage	V <sub>IH</sub> or V <sub>IL</sub>	-0.05	4.5	4.4	—	4.4	—	4.4	—	V
			-24	4.5	3.94	—	3.8	—	3.7	—	
		(1), (2)	-75	5.5	—	—	3.85	—	—	—	
			-50	5.5	—	—	—	—	3.85	—	
V <sub>OL</sub>	Low-Level Output Voltage	V <sub>IH</sub> or V <sub>IL</sub>	0.05	4.5	—	0.1	—	0.1	—	0.1	V
			24	4.5	—	0.36	—	0.44	—	0.5	
		(1), (2)	75	5.5	—	—	—	1.65	—	—	
			50	5.5	—	—	—	—	—	1.65	
I <sub>I</sub>	Input Leakage Current	V <sub>CC</sub> or GND		5.5	—	±0.1	—	±1	—	±1	μA
I <sub>OZ</sub>	3-State Leakage Current	V <sub>IH</sub> or V <sub>IL</sub> , V <sub>O</sub> = V <sub>CC</sub> or GND		5.5	—	±0.5	—	±5	—	±10	μA
I <sub>CC</sub>	Quiescent Supply Current, MSI	V <sub>CC</sub> or GND	0	5.5	—	8	—	80	—	160	μA
	Additional Quiescent Supply Current per Input Pin										
Δ I <sub>CC</sub>	TTL Inputs High	V <sub>CC</sub> -2.1	4.5 to 5.5	—	2.4	—	2.8	—	3	mA	
	1 Unit Load										

- (1) Test one output at a time for a 1-second maximum duration. Measurement is made by forcing current and measuring voltage to minimize power dissipation.  
 (2) Test verifies a minimum 50-ohm transmission-line-drive capability at +85°C. 75 ohms at +125°C.

**表 4-1. Act Input Loading Tables**

CD54/74ACT240	
INPUT	UNIT LOADS <sup>(1)</sup>
nA0 - A3	1.42
$\overline{10E}$	0.83
$\overline{20E}$	0.83

CD54/74ACT241	
INPUT	UNIT LOADS <sup>(1)</sup>
nA0 - A3	0.5
$\overline{10E}$	0.83
$\overline{20E}$	1.67

CD54/74ACT244	
INPUT	UNIT LOADS <sup>(1)</sup>
nA0 - A3	0.5
$\overline{10E}$	0.83
$\overline{20E}$	0.83

## 4.6 Switching Characteristics: AC Series

$t_r, t_f$  3 ns,  $C_L = 50$  pF

PARAMETER	CHARACTERISTICS	$V_{CC}$ (V)	AMBIENT TEMPERATURE ( $T_A$ ) - °C				UNIT
			-40 to +85		-55 to +125		
			MIN	MAX	MIN	MAX	
Propagation Delays: Data to Outputs							
$t_{PLH}$	AC 240	1.5	—	82	—	90	ns
		3.3 <sup>(1)</sup>	2.6	9.2	2.5	10.1	
$t_{PHL}$	AC 240	5	1.9	6.5	1.8	7.2	ns
		1.5	—	93	—	103	
$t_{PLH}$	AC 241, 244	3.3	3	10.5	2.9	11.5	ns
		5	2.2	7.5	2.1	8.2	
$t_{PZL}$	Output Enable Times	1.5	—	136	—	—	ns
		3.3	4.6	16.4	4.5	18	
$t_{PZH}$	Output Enable Times	5	3.1	10.9	3	12	ns
		1.5	—	136	—	150	
$t_{PLZ}$	Output Disable Times	3.3	3.9	13.6	3.8	15	ns
		5	3.1	10.9	3	12	
Power Dissipation Capacitance							
$C_{PD\text{\$}}$	AC240	—	65 Typ.		65 Typ.		pF
	AC241, 244	—	71 Typ.		71 Typ.		
Min. (Valley) $V_{oh}$							
$V_{OHV}$	During Switching of Other Outputs (Output Under Test Not Switching)	5	4 Typ @25°C				V
Max. (Peak) $V_{OL}$							
$V_{OLP}$	During Switching of Other Outputs (Output Under Test Not Switching)	5	1 Typ. @ 25°C				V
$C_I$	Input Capacitance	—	—	10	—	10	pF
$C_O$	3-State Output Capacitance	—	—	15	—	15	pF

## 4.7 Switching Characteristics: ACT Series

$t_r, t_f = 3$  ns,  $C_L = 50$  pF

PARAMETER	CHARACTERISTICS	$V_{CC}$ (V)	AMBIENT TEMPERATURE ( $T_A$ ) - °C				UNIT
			-40 to +85		-55 to +125		
			MIN	MAX	MIN	MAX	
Propagation Delays: Data to Outputs							
$t_{PLH}$	ACT240	5 <sup>(2)</sup>	2.3	7.8	2.2	8.6	ns
$t_{PHL}$							
$t_{PLH}$	ACT241, 244	5	2.5	8.7	2.4	9.6	ns
$t_{PHL}$							
$t_{PZL}$	Output Enable Times	5	3.5	12.2	3.4	13.4	ns
$t_{PZH}$							
$t_{PLZ}$	Output Disable Times	5	3.5	12.2	3.4	13.4	ns
$t_{PHZ}$							
Power Dissipation Capacitance							
$C_{PD\text{\$}}$ <sup>(3)</sup>	ACT240	—	65 Typ		65 Typ		pF
	ACT241, 244	—	71 Typ		71 Typ		pF

$t_r, t_f = 3 \text{ ns}, C_L = 50 \text{ pF}$

PARAMETER	CHARACTERISTICS	V <sub>CC</sub> (V)	AMBIENT TEMPERATURE (T <sub>A</sub> ) - °C				UNIT
			-40 to +85		-55 to +125		
			MIN	MAX	MIN	MAX	
Min. (Valley) V <sub>oh</sub> V <sub>OHV</sub> <sup>(1)</sup>	During Switching of Other Outputs (Output Under Test Not Switching)	5	4 Typ @25°C				V
Max. (Peak) V <sub>OL</sub> V <sub>OLP</sub> <sup>(1)</sup>	During Switching of Other Outputs (Output Under Test Not Switching)	5	1 Typ. @ 25°C				V
C <sub>I</sub>	Input Capacitance	—	—	10	—	10	pF
C <sub>O</sub>	3-State Output Capacitance	—	—	15	—	15	pF

(1) 3.3 V: min. is @ 3.6 V; max. is @ 3 V

(2) 5 V: min. is @ 5.5 V; max. is @ 4.5 V

(3) C<sub>PD</sub> is used to determine the dynamic power consumption, per package.

a. For AC series:  $P_D = V_{CC}^2 f_i (C_{PD} + C_L)$

b. For ACT series:  $P_D = V_{CC}^2 f_i (C_{PD} + C_L) + V_{CC} \Delta I_{CC}$  where  $f_i$  = input frequency

i. C<sub>L</sub> = output load capacitance

ii. V<sub>CC</sub> = supply voltage.

## 5 Parameter Measurement Information

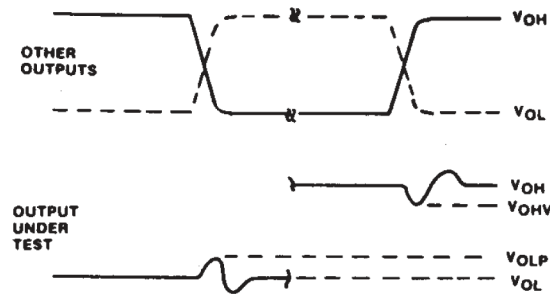

- A.  $V_{OHV}$  AND  $V_{OLP}$  ARE MEASURED WITH RESPECT TO A GROUND REFERENCE NEAR THE OUTPUT UNDER TEST.
- B. INPUT PULSES HAVE THE FOLLOWING CHARACTERISTICS:  $PRR \leq 1$  MHz,  $t_r = 3$  ns,  $t_f = 3$  ns, SKEW 1 ns.
- C. R.F. FIXTURE WITH 700-MHz DESIGN RULES REQUIRED. IC SHOULD BE SOLDERED INTO TEST BOARD AND BYPASSED WITH  $0.1 \mu\text{F}$  CAPACITOR. SCOPE AND PROBES REQUIRE 700-MHz BANDWIDTH.
- D. 92CS-42406

图 5-1. Simultaneous Switching Transient Waveforms.



图 5-2. Three-state Propagation Delay Times and Test Circuit.



**图 5-3. Propagation Delay Times and Test Circuit.**

	CDX4AC	CDX4ACT
Input Level	$V_{CC}$	3 V
Input Switching Voltage, $V_S$	$0.5 V_{CC}$	1.5 V
Output Switching Voltage, $V_S$	$0.5 V_{CC}$	$0.5 V_{CC}$

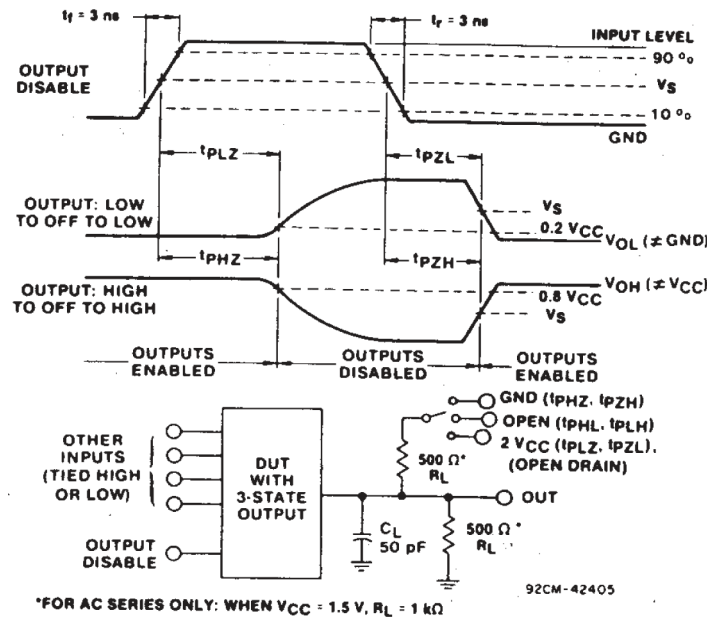
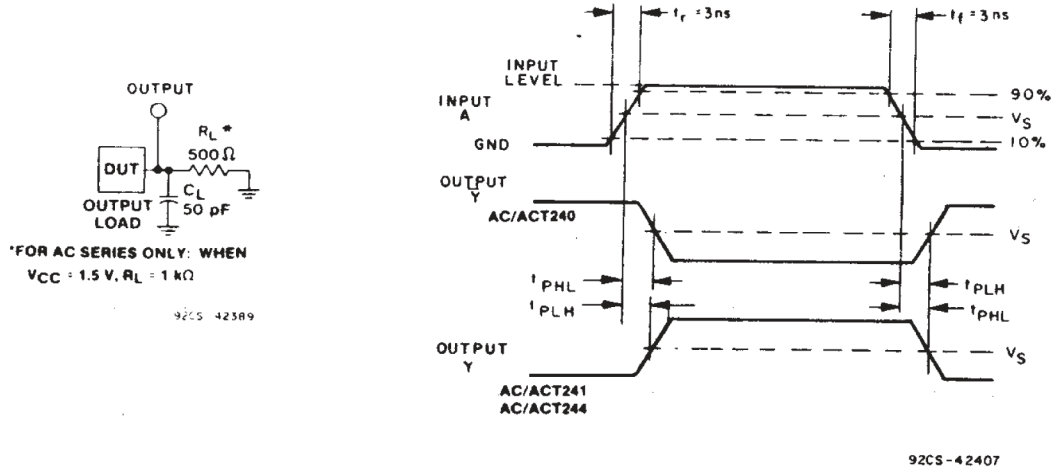
## 6 Detailed Description

### 6.1 Overview

The RCA CD54/74AC240, CD54/74AC241, and CD54/74AC244 and the CD54/74ACT240, CD54/74ACT241, and CD54/74ACT244 3-state octal buffer/line drivers use the RCA ADVANCED CMOS technology. The CD54/74AC/ACT240 and CD54/74AC/ACT244 have active-LOW output enables ( $\overline{1OE}$ ,  $\overline{2OE}$ ). The CD54/74AC/ACT241 has one active-LOW ( $\overline{1OE}$ ) and one active-HIGH (2OE) output enable.

The CD74AC240 and CD74ACT240 are supplied in 20-lead dual-in-line plastic packages (E suffix) and 20-lead small-outline packages (M and M96 suffixes). The CD74AC241 is supplied in 20-lead dual-in-line plastic packages (E suffix) and the CD74ACT241 is supplied in 20-lead dual-in-line plastic packages (E suffix) and 20-lead small-outline packages (M96 suffix). The CD74AC244 and CD74ACT244 are supplied in 20-lead dual-in-line plastic packages (E suffix), 20-lead small-outline packages (M and M96 suffixes), and 20-lead shrink small-outline packages (SM96 suffix). These package types are operable over the following temperature ranges: Commercial (0 to 70°C); Industrial (-40 to +85°C); and Extended Industrial/Military (-55 to +125°C).

The CD54AC240 and CD54AC244 and the CD54ACT240, CD54ACT241, and CD54ACT244 are supplied in 20-lead hermetic dual-in-line ceramic packages (F3A suffix) and are operable over the -55 to +125°C temperature range.

### 6.2 Functional Block Diagram

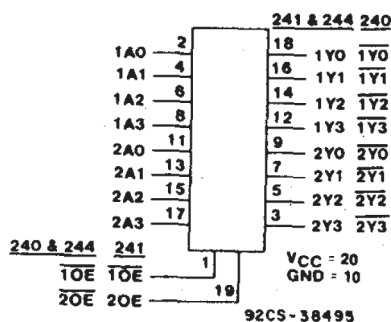

### 6.3 Device Functional Modes

表 6-1. Truth Tables

INPUTS		OUTPUT
$\overline{1OE}$ , $\overline{2OE}$	A	Y
L	L	H
L	H	L
H	X	Z
(AC/ACT240)		

INPUTS		OUTPUT
$\overline{1OE}$ , $\overline{2OE}$	A	Y
L	L	L
L	H	H
H	X	Z

INPUTS		OUT PUT
$\overline{10E}, 20E$	A	Y
(AC/ACT244)		

INPUTS		OUTPUT	INPUTS		OUTPUT
$\overline{10E}$	1A	1Y	20E	2A	2Y
L	L	L	L	X	Z
L	H	H	H	L	L
H	X	Z	H	H	H
(AC/ACT241)					

## 7 Application and Implementation

### 备注

以下应用部分中的信息不属于 TI 器件规格的范围，TI 不担保其准确性和完整性。TI 的客户应负责确定器件是否适用于其应用。客户应验证并测试其设计，以确保系统功能。

### 7.1 Power Supply Recommendations

The power supply can be any voltage between the min and max supply voltage rating located in [节 4.2](#).

Each  $V_{CC}$  terminal should have a good bypass capacitor to prevent power disturbance. For devices with a single supply, TI recommends 0.1  $\mu\text{F}$  and if there are multiple  $V_{CC}$  terminals, then TI recommends .01  $\mu\text{F}$  or .022  $\mu\text{F}$  for each power terminal. It is okay to parallel multiple bypass capacitors to reject different frequencies of noise. A 0.1  $\mu\text{F}$  and 1  $\mu\text{F}$  are commonly used in parallel. The bypass capacitor should be installed as close to the power terminal as possible for best results.

### 7.2 Layout

#### 7.2.1 Layout Guidelines

When using multiple bit logic devices inputs should not ever float.

In many cases, functions or parts of functions of digital logic devices are unused, for example, when only two inputs of a triple-input AND gate are used or only 3 of the 4 buffer gates are used. Such input pins should not be left unconnected because the undefined voltages at the outside connections result in undefined operational states. Specified below are the rules that must be observed under all circumstances. All unused inputs of digital logic devices must be connected to a high or low bias to prevent them from floating. The logic level that should be applied to any particular unused input depends on the function of the device. Generally they will be tied to GND or  $V_{CC}$  whichever make more sense or is more convenient. It is generally okay to float outputs unless the part is a transceiver. If the transceiver has an output enable pin it will disable the outputs section of the part when asserted. This does not disable the input section of the IOs so they cannot float when disabled.

## 8 Device and Documentation Support

### 8.1 Documentation Support (Analog)

#### 8.1.1 Related Documentation

The table below lists quick access links. Categories include technical documents, support and community resources, tools and software, and quick access to sample or buy.

表 8-1. Related Links

PARTS	PRODUCT FOLDER	SAMPLE & BUY	TECHNICAL DOCUMENTS	TOOLS & SOFTWARE	SUPPORT & COMMUNITY
CD74AC240	<a href="#">Click here</a>	<a href="#">Click here</a>	<a href="#">Click here</a>	<a href="#">Click here</a>	<a href="#">Click here</a>
CD74AC244	<a href="#">Click here</a>	<a href="#">Click here</a>	<a href="#">Click here</a>	<a href="#">Click here</a>	<a href="#">Click here</a>
CD74ACT240	<a href="#">Click here</a>	<a href="#">Click here</a>	<a href="#">Click here</a>	<a href="#">Click here</a>	<a href="#">Click here</a>
CD74ACT241	<a href="#">Click here</a>	<a href="#">Click here</a>	<a href="#">Click here</a>	<a href="#">Click here</a>	<a href="#">Click here</a>
CD74ACT244	<a href="#">Click here</a>	<a href="#">Click here</a>	<a href="#">Click here</a>	<a href="#">Click here</a>	<a href="#">Click here</a>

### 8.2 接收文档更新通知

要接收文档更新通知，请导航至 [ti.com](https://www.ti.com) 上的器件产品文件夹。点击 [通知](#) 进行注册，即可每周接收产品信息更改摘要。有关更改的详细信息，请查看任何已修订文档中包含的修订历史记录。

### 8.3 支持资源

[TI E2E™ 中文支持论坛](#) 是工程师的重要参考资料，可直接从专家处获得快速、经过验证的解答和设计帮助。搜索现有解答或提出自己的问题，获得所需的快速设计帮助。

链接的内容由各个贡献者“按原样”提供。这些内容并不构成 TI 技术规范，并且不一定反映 TI 的观点；请参阅 TI 的 [使用条款](#)。

### 8.4 Trademarks

TI E2E™ is a trademark of Texas Instruments.

所有商标均为其各自所有者的财产。

### 8.5 静电放电警告



静电放电 (ESD) 会损坏这个集成电路。德州仪器 (TI) 建议通过适当的预防措施处理所有集成电路。如果不遵守正确的处理和安装程序，可能会损坏集成电路。

ESD 的损坏小至导致微小的性能降级，大至整个器件故障。精密的集成电路可能更容易受到损坏，这是因为非常细微的参数更改都可能会导致器件与其发布的规格不相符。

### 8.6 术语表

[TI 术语表](#) 本术语表列出并解释了术语、首字母缩略词和定义。

## 9 Revision History

注：以前版本的页码可能与当前版本的页码不同

Changes from Revision B (January 2004) to Revision C (May 2024)	Page
• 添加了器件信息表、引脚功能表、热性能信息表、器件功能模式、应用和实施部分、器件和文档支持部分以及机械、封装和订购信息部分.....	1
• Updated R <sub>θ</sub> JA value: DW = 50 to 101.2, all values in °C/W .....	5

## 10 Mechanical, Packaging, and Orderable Information

The following pages include mechanical, packaging, and orderable information. This information is the most current data available for the designated devices. This data is subject to change without notice and revision of this document. For browser-based versions of this data sheet, refer to the left-hand navigation.

**PACKAGING INFORMATION**

Orderable part number	Status (1)	Material type (2)	Package   Pins	Package qty   Carrier	RoHS (3)	Lead finish/ Ball material (4)	MSL rating/ Peak reflow (5)	Op temp (°C)	Part marking (6)
<a href="#">CD54AC240F3A</a>	Active	Production	CDIP (J)   20	20   TUBE	No	SNPB	N/A for Pkg Type	-55 to 125	CD54AC240F3A
CD54AC240F3A.A	Active	Production	CDIP (J)   20	20   TUBE	No	SNPB	N/A for Pkg Type	-55 to 125	CD54AC240F3A
<a href="#">CD54AC244F3A</a>	Active	Production	CDIP (J)   20	20   TUBE	No	SNPB	N/A for Pkg Type	-55 to 125	CD54AC244F3A
CD54AC244F3A.A	Active	Production	CDIP (J)   20	20   TUBE	No	SNPB	N/A for Pkg Type	-55 to 125	CD54AC244F3A
<a href="#">CD54ACT240F3A</a>	Active	Production	CDIP (J)   20	20   TUBE	No	SNPB	N/A for Pkg Type	-55 to 125	CD54ACT240F3A
CD54ACT240F3A.A	Active	Production	CDIP (J)   20	20   TUBE	No	SNPB	N/A for Pkg Type	-55 to 125	CD54ACT240F3A
<a href="#">CD54ACT241F3A</a>	Active	Production	CDIP (J)   20	20   TUBE	No	SNPB	N/A for Pkg Type	-55 to 125	CD54ACT241F3A
CD54ACT241F3A.A	Active	Production	CDIP (J)   20	20   TUBE	No	SNPB	N/A for Pkg Type	-55 to 125	CD54ACT241F3A
<a href="#">CD54ACT244F3A</a>	Active	Production	CDIP (J)   20	20   TUBE	No	SNPB	N/A for Pkg Type	-55 to 125	CD54ACT244F3A
CD54ACT244F3A.A	Active	Production	CDIP (J)   20	20   TUBE	No	SNPB	N/A for Pkg Type	-55 to 125	CD54ACT244F3A
<a href="#">CD74AC240E</a>	Active	Production	PDIP (N)   20	20   TUBE	Yes	NIPDAU	N/A for Pkg Type	-55 to 125	CD74AC240E
CD74AC240E.A	Active	Production	PDIP (N)   20	20   TUBE	Yes	NIPDAU	N/A for Pkg Type	-55 to 125	CD74AC240E
CD74AC240EE4	Active	Production	PDIP (N)   20	20   TUBE	Yes	NIPDAU	N/A for Pkg Type	-55 to 125	CD74AC240E
<a href="#">CD74AC240M</a>	Obsolete	Production	SOIC (DW)   20	-	-	Call TI	Call TI	-55 to 125	AC240M
<a href="#">CD74AC240M96</a>	Active	Production	SOIC (DW)   20	2000   LARGE T&R	Yes	NIPDAU	Level-1-260C-UNLIM	-55 to 125	AC240M
CD74AC240M96.A	Active	Production	SOIC (DW)   20	2000   LARGE T&R	Yes	NIPDAU	Level-1-260C-UNLIM	-55 to 125	AC240M
<a href="#">CD74AC244E</a>	Active	Production	PDIP (N)   20	20   TUBE	Yes	NIPDAU	N/A for Pkg Type	-55 to 125	CD74AC244E
CD74AC244E.A	Active	Production	PDIP (N)   20	20   TUBE	Yes	NIPDAU	N/A for Pkg Type	-55 to 125	CD74AC244E
<a href="#">CD74AC244M</a>	Obsolete	Production	SOIC (DW)   20	-	-	Call TI	Call TI	-55 to 125	AC244M
<a href="#">CD74AC244M96</a>	Active	Production	SOIC (DW)   20	2000   LARGE T&R	Yes	NIPDAU	Level-1-260C-UNLIM	-55 to 125	(AC244, AC244M)
CD74AC244M96.A	Active	Production	SOIC (DW)   20	2000   LARGE T&R	Yes	NIPDAU	Level-1-260C-UNLIM	-55 to 125	(AC244, AC244M)
<a href="#">CD74ACT240E</a>	Active	Production	PDIP (N)   20	20   TUBE	Yes	NIPDAU	N/A for Pkg Type	-55 to 125	CD74ACT240E
CD74ACT240E.A	Active	Production	PDIP (N)   20	20   TUBE	Yes	NIPDAU	N/A for Pkg Type	-55 to 125	CD74ACT240E
<a href="#">CD74ACT240M</a>	Obsolete	Production	SOIC (DW)   20	-	-	Call TI	Call TI	-55 to 125	ACT240M
<a href="#">CD74ACT240M96</a>	Active	Production	SOIC (DW)   20	2000   LARGE T&R	Yes	NIPDAU	Level-1-260C-UNLIM	-55 to 125	ACT240M
CD74ACT240M96.A	Active	Production	SOIC (DW)   20	2000   LARGE T&R	Yes	NIPDAU	Level-1-260C-UNLIM	-55 to 125	ACT240M
CD74ACT240M96E4	Active	Production	SOIC (DW)   20	2000   LARGE T&R	Yes	NIPDAU	Level-1-260C-UNLIM	-55 to 125	ACT240M
<a href="#">CD74ACT241E</a>	Active	Production	PDIP (N)   20	20   TUBE	Yes	NIPDAU	N/A for Pkg Type	-55 to 125	CD74ACT241E
CD74ACT241E.A	Active	Production	PDIP (N)   20	20   TUBE	Yes	NIPDAU	N/A for Pkg Type	-55 to 125	CD74ACT241E

Orderable part number	Status (1)	Material type (2)	Package   Pins	Package qty   Carrier	RoHS (3)	Lead finish/ Ball material (4)	MSL rating/ Peak reflow (5)	Op temp (°C)	Part marking (6)
<a href="#">CD74ACT241M96</a>	Active	Production	SOIC (DW)   20	2000   LARGE T&R	Yes	NIPDAU	Level-1-260C-UNLIM	-55 to 125	ACT241M
CD74ACT241M96.A	Active	Production	SOIC (DW)   20	2000   LARGE T&R	Yes	NIPDAU	Level-1-260C-UNLIM	-55 to 125	ACT241M
<a href="#">CD74ACT244E</a>	Active	Production	PDIP (N)   20	20   TUBE	Yes	NIPDAU	N/A for Pkg Type	-55 to 125	CD74ACT244E
CD74ACT244E.A	Active	Production	PDIP (N)   20	20   TUBE	Yes	NIPDAU	N/A for Pkg Type	-55 to 125	CD74ACT244E
<a href="#">CD74ACT244M96</a>	Active	Production	SOIC (DW)   20	2000   LARGE T&R	Yes	NIPDAU	Level-1-260C-UNLIM	-55 to 125	(ACT244, ACT244M)
CD74ACT244M96.A	Active	Production	SOIC (DW)   20	2000   LARGE T&R	Yes	NIPDAU	Level-1-260C-UNLIM	-55 to 125	(ACT244, ACT244M)

(1) **Status:** For more details on status, see our [product life cycle](#).

(2) **Material type:** When designated, preproduction parts are prototypes/experimental devices, and are not yet approved or released for full production. Testing and final process, including without limitation quality assurance, reliability performance testing, and/or process qualification, may not yet be complete, and this item is subject to further changes or possible discontinuation. If available for ordering, purchases will be subject to an additional waiver at checkout, and are intended for early internal evaluation purposes only. These items are sold without warranties of any kind.

(3) **RoHS values:** Yes, No, RoHS Exempt. See the [TI RoHS Statement](#) for additional information and value definition.

(4) **Lead finish/Ball material:** Parts may have multiple material finish options. Finish options are separated by a vertical ruled line. Lead finish/Ball material values may wrap to two lines if the finish value exceeds the maximum column width.

(5) **MSL rating/Peak reflow:** The moisture sensitivity level ratings and peak solder (reflow) temperatures. In the event that a part has multiple moisture sensitivity ratings, only the lowest level per JEDEC standards is shown. Refer to the shipping label for the actual reflow temperature that will be used to mount the part to the printed circuit board.

(6) **Part marking:** There may be an additional marking, which relates to the logo, the lot trace code information, or the environmental category of the part.

Multiple part markings will be inside parentheses. Only one part marking contained in parentheses and separated by a "~" will appear on a part. If a line is indented then it is a continuation of the previous line and the two combined represent the entire part marking for that device.

**Important Information and Disclaimer:** The information provided on this page represents TI's knowledge and belief as of the date that it is provided. TI bases its knowledge and belief on information provided by third parties, and makes no representation or warranty as to the accuracy of such information. Efforts are underway to better integrate information from third parties. TI has taken and continues to take reasonable steps to provide representative and accurate information but may not have conducted destructive testing or chemical analysis on incoming materials and chemicals. TI and TI suppliers consider certain information to be proprietary, and thus CAS numbers and other limited information may not be available for release.

In no event shall TI's liability arising out of such information exceed the total purchase price of the TI part(s) at issue in this document sold by TI to Customer on an annual basis.

**OTHER QUALIFIED VERSIONS OF CD54AC240, CD54AC244, CD54ACT240, CD54ACT241, CD54ACT244, CD74AC240, CD74AC244, CD74ACT240, CD74ACT241, CD74ACT244 :**

- Catalog : [CD74AC240](#), [CD74AC244](#), [CD74ACT240](#), [CD74ACT241](#), [CD74ACT244](#)
- Military : [CD54AC240](#), [CD54AC244](#), [CD54ACT240](#), [CD54ACT241](#), [CD54ACT244](#)

NOTE: Qualified Version Definitions:

- Catalog - TI's standard catalog product
- Military - QML certified for Military and Defense Applications

**TAPE AND REEL INFORMATION**

**QUADRANT ASSIGNMENTS FOR PIN 1 ORIENTATION IN TAPE**

\*All dimensions are nominal

Device	Package Type	Package Drawing	Pins	SPQ	Reel Diameter (mm)	Reel Width W1 (mm)	A0 (mm)	B0 (mm)	K0 (mm)	P1 (mm)	W (mm)	Pin1 Quadrant
CD74AC240M96	SOIC	DW	20	2000	330.0	24.4	10.8	13.3	2.7	12.0	24.0	Q1
CD74AC244M96	SOIC	DW	20	2000	330.0	24.4	10.9	13.3	2.7	12.0	24.0	Q1
CD74AC244M96	SOIC	DW	20	2000	330.0	24.4	10.8	13.3	2.7	12.0	24.0	Q1
CD74ACT240M96	SOIC	DW	20	2000	330.0	24.4	10.8	13.3	2.7	12.0	24.0	Q1
CD74ACT241M96	SOIC	DW	20	2000	330.0	24.4	10.8	13.3	2.7	12.0	24.0	Q1
CD74ACT244M96	SOIC	DW	20	2000	330.0	24.4	10.8	13.3	2.7	12.0	24.0	Q1
CD74ACT244M96	SOIC	DW	20	2000	330.0	24.4	10.9	13.3	2.7	12.0	24.0	Q1

**TAPE AND REEL BOX DIMENSIONS**

\*All dimensions are nominal

Device	Package Type	Package Drawing	Pins	SPQ	Length (mm)	Width (mm)	Height (mm)
CD74AC240M96	SOIC	DW	20	2000	356.0	356.0	45.0
CD74AC244M96	SOIC	DW	20	2000	356.0	356.0	45.0
CD74AC244M96	SOIC	DW	20	2000	356.0	356.0	45.0
CD74ACT240M96	SOIC	DW	20	2000	356.0	356.0	45.0
CD74ACT241M96	SOIC	DW	20	2000	356.0	356.0	45.0
CD74ACT244M96	SOIC	DW	20	2000	356.0	356.0	45.0
CD74ACT244M96	SOIC	DW	20	2000	356.0	356.0	45.0

**TUBE**

\*All dimensions are nominal

Device	Package Name	Package Type	Pins	SPQ	L (mm)	W (mm)	T (μm)	B (mm)
CD74AC240E	N	PDIP	20	20	506	13.97	11230	4.32
CD74AC240E.A	N	PDIP	20	20	506	13.97	11230	4.32
CD74AC240EE4	N	PDIP	20	20	506	13.97	11230	4.32
CD74AC244E	N	PDIP	20	20	506	13.97	11230	4.32
CD74AC244E.A	N	PDIP	20	20	506	13.97	11230	4.32
CD74ACT240E	N	PDIP	20	20	506	13.97	11230	4.32
CD74ACT240E.A	N	PDIP	20	20	506	13.97	11230	4.32
CD74ACT241E	N	PDIP	20	20	506	13.97	11230	4.32
CD74ACT241E.A	N	PDIP	20	20	506	13.97	11230	4.32
CD74ACT244E	N	PDIP	20	20	506	13.97	11230	4.32
CD74ACT244E.A	N	PDIP	20	20	506	13.97	11230	4.32

J (R-GDIP-T\*\*)

14 LEADS SHOWN

CERAMIC DUAL IN-LINE PACKAGE



DIM \ PINS **	14	16	18	20
A	0.300 (7,62) BSC	0.300 (7,62) BSC	0.300 (7,62) BSC	0.300 (7,62) BSC
B MAX	0.785 (19,94)	.840 (21,34)	0.960 (24,38)	1.060 (26,92)
B MIN	—	—	—	—
C MAX	0.300 (7,62)	0.300 (7,62)	0.310 (7,87)	0.300 (7,62)
C MIN	0.245 (6,22)	0.245 (6,22)	0.220 (5,59)	0.245 (6,22)



4040083/F 03/03

- NOTES:
- All linear dimensions are in inches (millimeters).
  - This drawing is subject to change without notice.
  - This package is hermetically sealed with a ceramic lid using glass frit.
  - Index point is provided on cap for terminal identification only on press ceramic glass frit seal only.
  - Falls within MIL STD 1835 GDIP1-T14, GDIP1-T16, GDIP1-T18 and GDIP1-T20.

N (R-PDIP-T\*\*)

PLASTIC DUAL-IN-LINE PACKAGE

16 PINS SHOWN



- NOTES:
- A. All linear dimensions are in inches (millimeters).
  - B. This drawing is subject to change without notice.
  - Falls within JEDEC MS-001, except 18 and 20 pin minimum body length (Dim A).
  - The 20 pin end lead shoulder width is a vendor option, either half or full width.

# DW0020A



# PACKAGE OUTLINE

## SOIC - 2.65 mm max height

SOIC



4220724/A 05/2016

### NOTES:

- All linear dimensions are in millimeters. Dimensions in parenthesis are for reference only. Dimensioning and tolerancing per ASME Y14.5M.
- This drawing is subject to change without notice.
- This dimension does not include mold flash, protrusions, or gate burrs. Mold flash, protrusions, or gate burrs shall not exceed 0.15 mm per side.
- This dimension does not include interlead flash. Interlead flash shall not exceed 0.43 mm per side.
- Reference JEDEC registration MS-013.

# EXAMPLE BOARD LAYOUT

DW0020A

SOIC - 2.65 mm max height

SOIC



LAND PATTERN EXAMPLE  
SCALE:6X



SOLDER MASK DETAILS

4220724/A 05/2016

NOTES: (continued)

- 6. Publication IPC-7351 may have alternate designs.
- 7. Solder mask tolerances between and around signal pads can vary based on board fabrication site.

# EXAMPLE STENCIL DESIGN

DW0020A

SOIC - 2.65 mm max height

SOIC



SOLDER PASTE EXAMPLE  
BASED ON 0.125 mm THICK STENCIL  
SCALE:6X

4220724/A 05/2016

NOTES: (continued)

8. Laser cutting apertures with trapezoidal walls and rounded corners may offer better paste release. IPC-7525 may have alternate design recommendations.
9. Board assembly site may have different recommendations for stencil design.

## 重要通知和免责声明

TI“按原样”提供技术和可靠性数据（包括数据表）、设计资源（包括参考设计）、应用或其他设计建议、网络工具、安全信息和其他资源，不保证没有瑕疵且不做任何明示或暗示的担保，包括但不限于对适销性、与某特定用途的适用性或不侵犯任何第三方知识产权的暗示担保。

这些资源可供使用 TI 产品进行设计的熟练开发人员使用。您将自行承担以下全部责任：(1) 针对您的应用选择合适的 TI 产品，(2) 设计、验证并测试您的应用，(3) 确保您的应用满足相应标准以及任何其他安全、安保法规或其他要求。

这些资源如有变更，恕不另行通知。TI 授权您仅可将这些资源用于研发本资源所述的 TI 产品的相关应用。严禁以其他方式对这些资源进行复制或展示。您无权使用任何其他 TI 知识产权或任何第三方知识产权。对于因您对这些资源的使用而对 TI 及其代表造成的任何索赔、损害、成本、损失和债务，您将全额赔偿，TI 对此概不负责。

TI 提供的产品受 [TI 销售条款](#)、[TI 通用质量指南](#) 或 [ti.com](#) 上其他适用条款或 TI 产品随附的其他适用条款的约束。TI 提供这些资源并不会扩展或以其他方式更改 TI 针对 TI 产品发布的适用的担保或担保免责声明。除非德州仪器 (TI) 明确将某产品指定为定制产品或客户特定产品，否则其产品均为按确定价格收入目录的标准通用器件。

TI 反对并拒绝您可能提出的任何其他或不同的条款。

版权所有 © 2026，德州仪器 (TI) 公司

最后更新日期：2025 年 10 月