

# UCC12050 高密度、低 EMI、5kV<sub>RMS</sub> Reinforced 隔离式直流/直流模块

## 1 特性

- 采用优化的集成变压器技术的高密度直流/直流模块
- 输入电压范围：4.5V 至 5.5V
- 输出电压（可选）：5.4V、5.0V、3.7V、3.3V
- 输出功率：500mW
- 峰值效率：60%
- 线性调整率（典型值）：1%
- 负载调整率（典型值）：1.5%
- 符合 CISPR32 B 类 EMI 标准限制，双层 PCB 上无需使用铁氧体磁珠
- 展频调制 (SSM)
- 稳健可靠的隔离栅：
  - 隔离等级：5 kV<sub>RMS</sub>
  - 浪涌能力：10 kV<sub>PK</sub>
  - 工作电压：1.2 kV<sub>RMS</sub>
  - CMTI（典型值）：±100V/ns
- 短路恢复
- 热关断保护
- 16 引脚宽体 SOIC 封装，爬电距离和间隙大于 8mm
- 工作温度范围：-40°C 至 125°C
- 安全相关认证：
  - 符合 DIN V VDE V 0884-11:2017-01 标准的 7071V<sub>PK</sub> 增强型隔离
  - 符合 UL 1577 标准且长达 1 分钟的 5000V<sub>RMS</sub> 隔离
  - 获得 UL 认证，符合 IEC 60950-1、IEC 62368-1 和 IEC 60601-1 终端设备标准
  - 根据 GB4943.1-2011 标准进行的 CQC 认证

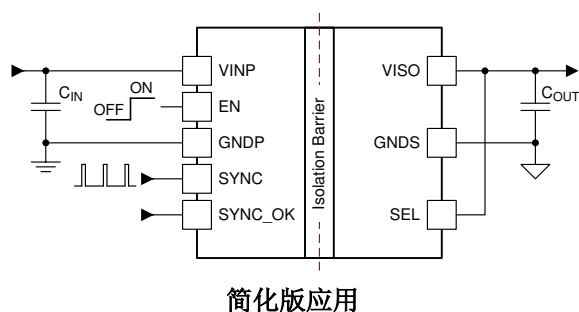

## 2 应用和用途

- 车载充电器
- 电池管理系统
- 牵引逆变器
- 用于 HEV/EV 的直流/直流转换器

## 3 说明

UCC12050 是一款具有 5kV<sub>RMS</sub> reinforced 隔离额定值的汽车级直流/直流电源模块，旨在为需要偏置电源及稳压输出电压的隔离电路提供有效的隔离电源。该器件集成了具有专有架构的变压器和直流/直流控制器，可提供 500mW（典型值）的隔离功率，并具有低 EMI。

UCC12050 集成了保护功能以增强系统稳健性。该器件还具有使能引脚、同步功能以及 5V 或 3.3V 稳压输出选项（带净空电压）。UCC12050 是一种薄型、小型化解决方案，采用高度为 2.65mm（典型值）的宽体 SOIC 封装。

### 器件信息(1)

器件型号	封装	封装尺寸（标称值）
UCC12050	DVE SOIC (16)	10.30mm × 7.50mm

- (1) 如需了解所有可用封装，请参阅数据表末尾的可订购产品附录。

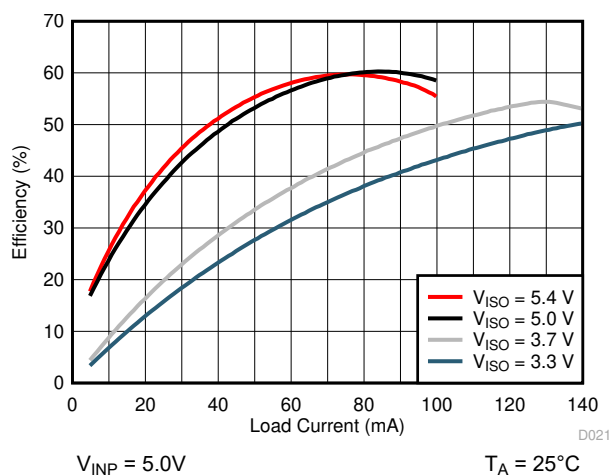

典型效率与负载间的关系



## Table of Contents

<b>1 特性</b> .....	1	7.2 Functional Block Diagram.....	14
<b>2 应用和用途</b> .....	1	7.3 Feature Description.....	14
<b>3 说明</b> .....	1	7.4 Device Functional Modes.....	16
<b>4 Revision History</b> .....	2	<b>8 Application and Implementation</b> .....	17
<b>5 Pin Configuration and Functions</b> .....	3	8.1 Application Information.....	17
<b>6 Specifications</b> .....	4	8.2 Typical Application.....	17
6.1 Absolute Maximum Ratings.....	4	<b>9 Power Supply Recommendations</b> .....	23
6.2 ESD Ratings.....	4	<b>10 Layout</b> .....	23
6.3 Recommended Operating Conditions.....	4	10.1 Layout Guidelines.....	23
6.4 Thermal Information.....	4	10.2 Layout Example.....	24
6.5 Power Ratings.....	5	<b>11 Device and Documentation Support</b> .....	25
6.6 Insulation Specifications.....	5	11.1 Device Support.....	25
6.7 Safety-Related Certifications.....	6	11.2 Documentation Support.....	25
6.8 Safety Limiting Values.....	6	11.3 接收文档更新通知.....	25
6.9 Electrical Characteristics.....	7	11.4 支持资源.....	25
6.10 Switching Characteristics.....	8	11.5 Trademarks.....	25
6.11 Insulation Characteristics Curves.....	9	11.6 静电放电警告.....	25
6.12 Typical Characteristics.....	10	11.7 术语表.....	25
<b>7 Detailed Description</b> .....	14	<b>12 Mechanical and Packaging Information</b> .....	25
7.1 Overview.....	14		

## 4 Revision History

注：以前版本的页码可能与当前版本的页码不同

<b>Changes from Revision C (April 2020) to Revision D (February 2021)</b>	<b>Page</b>
• 在整个文档中添加了更新文本.....	1
• Updated ESD values. ....	4
• Updated thermal footnote description.....	4
• Updated voltage isolation specs per DIN V VDE V 0884-11:2017-01.....	5
• Added certification numbers.....	6
• Updated Switching Characteristics (non-sync).....	8
• Added Section number included .....	16

<b>Changes from Revision B (December 2019) to Revision C (April 2020)</b>	<b>Page</b>
• 在整个文档中添加了更新文本.....	1
• Added footnote to Insulation Specifications table.....	5
• Removed Pout_max as a Loading parameter. Removed Pout_max from graph.....	15

<b>Changes from Revision A (September 2019) to Revision B (December 2019)</b>	<b>Page</b>
• 将销售状态从“预告信息”更改为“初始发行版” .....	1

## 5 Pin Configuration and Functions

### DVE Package 16-Pin SOIC Top View



表 5-1. Pin Functions

PIN		TYPE <sup>(1)</sup>	DESCRIPTION
NAME	NO.		
EN	1	I	Enable pin. Forcing EN low disables the device. Pull high to enable normal device functionality.
GNDP	2	P	Power ground return connection for VINP.
GNDS	9	P	Connect to GNDS plane on printed circuit board. Do not use as only ground connection for VISO. Ensure pin 15 is connected to circuit ground.
	16		
GNDS	15	P	Secondary side ground return connection for VISO. Connect bypass capacitor from VISO to this pin.
NC	6	—	Pins internally connected together. No other electrical connection. Pins belong to primary-side voltage domain. Connect to GNDP on printed circuit board.
	7		
	8		
	10	—	No internal connection. Pin belongs to isolated voltage domain. Connect to GNDS on printed circuit board.
	11		
	12		
SYNC	4	I	Synchronous clock input pin. Provide a clock signal to synchronize multiple devices or connect to GNDP for standalone operation using the internal oscillator. If the SYNC pin is left open make sure to it separate it from any switching noise to avoid false clock coupling.
SYNC_OK	5	O	Active-low, open-drain diagnostic output. Pin is asserted LOW if there is no external SYNC clock or one that is outside of the operating range is detected. In this state, the external clock is ignored and the DC/DC converter is clocked by the internal oscillator. The pin is in high-impedance if a clock is applied on SYNC.
SEL	13	I	V <sub>ISO</sub> selection pin. V <sub>ISO</sub> setpoint is 5.0 V when SEL is shorted to V <sub>ISO</sub> , 5.4 V when SEL is connected to V <sub>ISO</sub> through a 100-k $\Omega$ resistor, 3.3 V when SEL is shorted to GNDS, and 3.7 V when SEL is connected to GNDS through a 100-k $\Omega$ resistor. For more information see the <a href="#">§ 7.4</a> section.
VINP	3	P	Primary side input supply voltage pin. A 10- $\mu$ F ceramic capacitor to GNDP on pin 2, placed close to the device pins, is required.
VISO	14	P	Isolated supply voltage pin. A 10- $\mu$ F ceramic capacitor to GNDS on pin 15, placed close to the device pins, is required. See <a href="#">§ 8.2.2.1</a> section.

(1) P = Power, G = Ground, I = Input, O = Output

## 6 Specifications

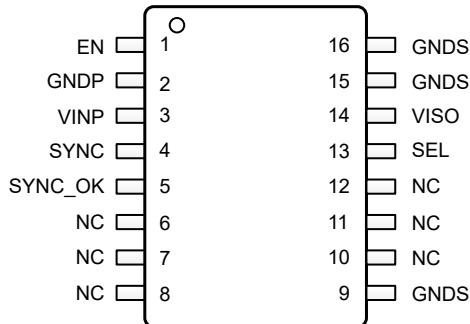
### 6.1 Absolute Maximum Ratings

over operating free-air temperature range (unless otherwise noted)<sup>(1)</sup>

	MIN	MAX	UNIT
V <sub>INP</sub> to GNDP	- 0.3	6.0	V
EN, SYNC, SYNC_OK, to GNDP	- 0.3	V <sub>INP</sub> + 0.3, ≤ 6.0	V
V <sub>ISO</sub> to GNDS	- 0.3	6.0	V
SEL to GNDS	- 0.3	V <sub>ISO</sub> + 0.3, ≤ 6.0	V
V <sub>ISO</sub> output power at T <sub>a</sub> = 25°C, P <sub>OUT_MAX</sub> <sup>(2)</sup>		675	mW
Operating junction temperature range, T <sub>J</sub>	- 40	150	°C
Storage temperature, T <sub>stg</sub>	- 65	150	°C

- (1) Stresses beyond those listed under *Absolute Maximum Ratings* may cause permanent damage to the device. These are stress ratings only, which do not imply functional operation of the device at these or any other conditions beyond those indicated under *Recommended Operating Conditions*. Exposure to absolute-maximum-rated conditions for extended periods may affect device reliability.
- (2) See the [§ 7.3.3](#) section for maximum rated values across temperature and V<sub>INP</sub> conditions for each different V<sub>ISO</sub> output mode.

### 6.2 ESD Ratings

			VALUE	UNIT
V <sub>(ESD)</sub>	Electrostatic discharge	Human-body model (HBM), per ANSI/ESDA/JEDEC JS-001 <sup>(1)</sup>	±3000	V
		Charged-device model (CDM), per JEDEC specification JESD22-C101 <sup>(2)</sup>	±1000	

- (1) JEDEC document JEP155 states that 500-V HBM allows safe manufacturing with a standard ESD control process.
- (2) JEDEC document JEP157 states that 250-V CDM allows safe manufacturing with a standard ESD control process.

### 6.3 Recommended Operating Conditions

over operating free-air temperature range (unless otherwise noted)

		MIN	NOM	MAX	UNIT
V <sub>INP</sub>	Primary side supply voltage	4.5	5.0	5.5	V
V <sub>EN</sub>	EN pin input voltage	0		5.5	V
V <sub>SYNC</sub>	SYNC pin input voltage	0		5.5	V
V <sub>SYNC-OK</sub>	SYNC_OK pin drain pin voltage	0		5.5	V
V <sub>ISO</sub>	Isolated power supply voltage	0		5.7	V
V <sub>SEL</sub>	Input voltage	0		5.7	V
f <sub>SYNC</sub>	External DC/DC converter synchronization signal frequency	14.4	16.0	17.6	MHz
P <sub>VISO</sub>	V <sub>ISO</sub> output power at T <sub>a</sub> = 25°C <sup>(1)</sup>			500	mW
T <sub>a</sub>	Ambient temperature	- 40		125	°C
T <sub>J</sub>	Junction temperature	- 40		150	°C

- (1) See the [§ 7.3.3](#) section for maximum rated values across temperature and V<sub>INP</sub> conditions for each different V<sub>ISO</sub> output mode.

### 6.4 Thermal Information

THERMAL METRIC <sup>(1)</sup>		UCC12050	UNIT
		DVE (SOIC)	
		16 PINS	
R <sub>θJA</sub>	Junction-to-ambient thermal resistance	63.8	°C/W
R <sub>θJC(top)</sub>	Junction-to-case (top) thermal resistance	21.4	°C/W
R <sub>θJB</sub>	Junction-to-board thermal resistance	38.5	°C/W
ψ <sub>JT</sub>	Junction-to-top characterization parameter	10.2	°C/W
ψ <sub>JB</sub>	Junction-to-board characterization parameter	37.2	°C/W

## 6.4 Thermal Information (continued)

THERMAL METRIC <sup>(1)</sup>		UCC12050	
		DVE (SOIC)	
		16 PINS	
		UNIT	
$R_{\theta JC(bot)}$	Junction-to-case (bottom) thermal resistance	—	°C/W

(1) The value of  $R_{\theta JA}$  given in this table is only valid for comparison with other packages and can not be used for design purposes. This value was calculated in accordance with JESD 51-7, and simulated on a 4-layer JEDEC board when  $P_{DP} = 129$  mW,  $P_{DS} = 142$  mW and  $P_{DT} = 129$  mW. The board temperature is taken from Pin 12. For more information about traditional and new thermal metrics, see the [Semiconductor and IC Package Thermal Metrics](#) application report.

## 6.5 Power Ratings

$V_{INP} = 5.0V$ ,  $C_{INP} = C_{OUT} = 10$  uF,  $T_J = 150^\circ C$ , Internal Clock mode

PARAMETER		TEST CONDITIONS	VALUE	UNIT
$P_D$	Power dissipation	SEL connected to GNDS (3.3-V $V_{ISO}$ output mode), $I_{ISO} = 135$ mA	460	mW
$P_{DP}$	Power dissipation by driver side (primary)		148	mW
$P_{DS}$	Power dissipation by rectifier side (secondary)		164	mW
$P_{DT}$	Power dissipation by transformer		148	mW

## 6.6 Insulation Specifications

PARAMETER		TEST CONDITIONS	VALUE	UNIT
<b>GENERAL</b>				
CLR	External clearance <sup>(1)</sup>	Shortest terminal-to-terminal distance through air	> 8	mm
CPG	External creepage <sup>(1)</sup>	Shortest terminal-to-terminal distance across the package surface	> 8	mm
DTI	Distance through the insulation	Minimum internal gap (internal clearance)	> 120	µm
CTI	Comparative tracking index	DIN EN 60112 (VDE 0303-11); IEC 60112	> 600	V
	Material group	According to IEC 60664-1	I	
	Overvoltage Category	Rated mains voltage $\leq 300 V_{RMS}$	I-IV	
		Rated mains voltage $\leq 600 V_{RMS}$	I-IV	
		Rated mains voltage $\leq 1000 V_{RMS}$	I-III	
<b>DIN V VDE V 0884-11:2017-01<sup>(2)</sup></b>				
$V_{IORM}$	Maximum repetitive peak isolation voltage	AC voltage (bipolar)	1697	$V_{PK}$
$V_{IOWM}$	Maximum working isolation voltage	AC voltage (sine wave) Time dependent dielectric breakdown (TDDB) test	1200	$V_{RMS}$
		DC voltage	1697	$V_{DC}$
$V_{IOTM}$	Maximum transient isolation voltage	$V_{TEST} = V_{IOTM}$ , $t = 60$ s (qualification); $V_{TEST} = 1.2 \times V_{IOTM}$ , $t = 1$ s (100% production)	7071	$V_{PK}$
$V_{IOSM}$	Maximum surge isolation voltage <sup>(3)</sup>	Test method per IEC 62368-1, 1.2/50 µs waveform, $V_{TEST} = 1.6 \times V_{IOSM} = 10000 V_{PK}$ (qualification)	6250	$V_{PK}$
$q_{pd}$	Apparent charge <sup>(4)</sup>	Method a: After I/O safety test subgroup 2/3, $V_{ini} = V_{IOTM}$ , $t_{ini} = 60$ s; $V_{pd(m)} = 1.2 \times V_{IORM} = 1696 V_{PK}$ , $t_m = 10$ s	$\leq 5$	pC
		Method a: After environmental tests subgroup 1, $V_{ini} = V_{IOTM}$ , $t_{ini} = 60$ s; $V_{pd(m)} = 1.6 \times V_{IORM} = 2262 V_{PK}$ , $t_m = 10$ s	$\leq 5$	
		Method b1: At routine test (100% production) and preconditioning (type test) $V_{ini} = 1.2 \times V_{IOTM}$ , $t_{ini} = 1$ s; $V_{pd(m)} = 1.875 \times V_{IORM} = 2651 V_{PK}$ , $t_m = 1$ s	$\leq 5$	
$C_{IO}$	Barrier capacitance, input to output <sup>(5)</sup>	$V_{IO} = 0.4 \sin(2\pi ft)$ , $f = 1$ MHz	~3.5	pF
$R_{IO}$	Isolation resistance, input to output <sup>(5)</sup>	$V_{IO} = 500$ V, $T_A = 25^\circ C$	$> 10^{12}$	$\Omega$
		$V_{IO} = 500$ V, $100^\circ C \leq T_A \leq 125^\circ C$	$> 10^{11}$	
		$V_{IO} = 500$ V at $T_S = 150^\circ C$	$> 10^9$	
	Pollution degree		2	
	Climatic category		40/125/21	

## 6.6 Insulation Specifications (continued)

PARAMETER		TEST CONDITIONS	VALUE	UNIT
<b>UL 1577</b>				
V <sub>ISO</sub>	Withstand isolation voltage	V <sub>TEST</sub> = V <sub>ISO</sub> = 5000 V <sub>RMS</sub> , t = 60 s (qualification); V <sub>TEST</sub> = 1.2 × V <sub>ISO</sub> = 6000 V <sub>RMS</sub> , t = 1 s (100% production)	5000	V <sub>RMS</sub>

- Creepage and clearance requirements should be applied according to the specific equipment isolation standards of an application. Care should be taken to maintain the creepage and clearance distance of a board design to ensure that the mounting pads of the isolator on the printed-circuit board do not reduce this distance. Creepage and clearance on a printed-circuit board become equal in certain cases. Techniques such as inserting grooves and/or ribs on a printed circuit board are used to help increase these specifications.
- This coupler is suitable for *safe electrical insulation* only within the maximum operating ratings. Compliance with the safety ratings shall be ensured by means of suitable protective circuits.
- Testing is carried out in air or oil to determine the intrinsic surge immunity of the isolation barrier.
- Apparent charge is electrical discharge caused by a partial discharge (pd).
- All pins on each side of the barrier tied together creating a two-terminal device

## 6.7 Safety-Related Certifications

VDE	UL		CQC
Certified according to DIN V VDE V 0884-11:2017- 01	Certified according to IEC 60601-1	Certified according to IEC 60950-1 and IEC 62368- 1	Recognized under UL 1577 Component Recognition Program  Certified according to GB4943.1-2011
Reinforced insulation Maximum transient isolation voltage, 7071 VPK; Maximum repetitive peak isolation voltage, 1697 VPK; Maximum surge isolation voltage, 6250 VPK	Reinforced insulation per AAMI ES 60601-1:2005/ (R)2012 and A1:2012, C1:2009/(R)2012 and A2:2010/(R)2012 CSA C22.2 No. 60601-1:2014 IEC 60601-1:2012, 2 MOPP (Means of Patient Protection), 250 VRMS maximum working voltage	Reinforced insulation per UL 60950-1-07+A1+A2, IEC 60950-1 2nd Ed.+A1+A2, UL 62368-1- 14 and IEC 62368-1 2nd Ed., 1200 VRMS maximum working voltage (pollution degree 1, material group I)	Single protection, 5000 VRMS  Reinforced insulation, Altitude ≤ 5000 m, Tropical Climate, 700 VRMS maximum working voltage
Certificate number: 40040142	Certificate number: US-36773-A1-UL	Certificate number: US-36706-UL, US-36707-UL	File number: E181974  Certificate number: CQC20001273822

## 6.8 Safety Limiting Values

Safety limiting intends to minimize potential damage to the isolation barrier upon failure of input or output circuitry.

PARAMETER		TEST CONDITIONS	MAX	UNIT
I <sub>S</sub>	Safety input current <sup>(1)</sup>	R <sub>θJA</sub> = 63.8°C/W, V <sub>I</sub> = 5.5 V, T <sub>J</sub> = 150°C, T <sub>A</sub> = 25°C	356	mA
		R <sub>θJA</sub> = 63.8°C/W, V <sub>I</sub> = 4.5 V, T <sub>J</sub> = 150°C, T <sub>A</sub> = 25°C	435	
P <sub>S</sub>	Safety input power	R <sub>θJA</sub> = 63.8°C/W, T <sub>J</sub> = 150°C, T <sub>A</sub> = 25°C	1960	mW
T <sub>S</sub>	Safety temperature <sup>(1)</sup>		150	°C

- The maximum safety temperature, T<sub>S</sub>, has the same value as the maximum junction temperature, T<sub>J</sub>, specified for the device. The I<sub>S</sub> and P<sub>S</sub> parameters represent the safety current and safety power respectively. The maximum limits of I<sub>S</sub> and P<sub>S</sub> should not be exceeded. These limits vary with the ambient temperature, T<sub>A</sub>. The junction-to-air thermal resistance, R<sub>θJA</sub>, in the [Thermal Information](#) table is that of a device installed on a high-K test board for leaded surface-mount packages. Use these equations to calculate the value for each parameter: T<sub>J</sub> = T<sub>A</sub> + R<sub>θJA</sub> × P, where P is the power dissipated in the device. T<sub>J(max)</sub> = T<sub>S</sub> = T<sub>A</sub> + R<sub>θJA</sub> × P<sub>S</sub>, where T<sub>J(max)</sub> is the maximum allowed junction temperature. P<sub>S</sub> = I<sub>S</sub> × V<sub>I</sub>, where V<sub>I</sub> is the maximum input voltage.

## 6.9 Electrical Characteristics

Over operating temperature range ( $T_J = -40^{\circ}\text{C}$  to  $150^{\circ}\text{C}$ ),  $V_{\text{INP}} = 4.5\text{V}$  to  $5.5\text{V}$ ,  $C_{\text{INP}} = C_{\text{OUT}} = 10\ \mu\text{F}$ , SEL connected to  $V_{\text{ISO}}$ , internal clock mode, unless otherwise noted. All typical values at  $T_J = 25^{\circ}\text{C}$  and  $V_{\text{INP}} = 5.0\text{V}$ .

	PARAMETER	TEST CONDITIONS	MIN	TYP	MAX	UNIT
<b>INPUT SUPPLY</b>						
$I_{\text{VINQ}}$	VINP quiescent current, disabled	EN=LOW			100	$\mu\text{A}$
$I_{\text{VINO}}$	VINP operating current, no load	EN=HI; SEL shorted to VISO (5.0V output)		50		mA
		EN=HI; SEL 100k $\Omega$ to VISO (5.4V output)		45		
		EN=HI; SEL shorted to GNDS (3.3V output)		90		
		EN=HI; SEL 100k $\Omega$ to GNDS (3.7V output)		80		
$I_{\text{VIN\_SC}}$	DC current from VINP supply under short circuit on VISO	VISO short to GNDS		245		mA
$V_{\text{UVPR}}$	VINP under-voltage lockout rising threshold			4.2		V
$V_{\text{UVPF}}$	VINP under-voltage lockout falling threshold			3.7		V
$V_{\text{UVPH}}$	VINP under-voltage lockout hysteresis			0.5		V
<b>EN, SYNC INPUT PINS</b>						
$V_{\text{IR}}$	Input voltage threshold, logic HIGH	Rising edge			2.2	V
$V_{\text{IF}}$	Input voltage threshold, logic LOW	Falling edge	0.8			V
$I_{\text{EN}}$	Enable Pin Input Current	$V_{\text{EN}} = 5.0\ \text{V}$		5	10	$\mu\text{A}$
$I_{\text{SYNC}}$	SYNC Pin Input Current	$V_{\text{SYNC}} = 5.0\ \text{V}$		0.02	1	$\mu\text{A}$
<b>SYNC_OK PIN</b>						
$V_{\text{OL}}$	SYNC_OK output low voltage	$I_{\text{SYNC\_OK}} = -2\ \text{mA}$		0.15		V
$I_{\text{LKG\_SYNC\_OK}}$	SYNC_OK pin leakage current	$V_{\text{SYNC\_OK}} = 5.0\ \text{V}$			1	$\mu\text{A}$
<b>DC/DC CONVERTER</b>						
$V_{\text{ISO}}$	Isolated supply output voltage	SEL shorted to VISO (5.0V output); $I_{\text{ISO}} = 55\ \text{mA}$ <sup>(2)</sup>	4.7	5	5.3	V
		SEL 100k $\Omega$ to VISO (5.4 V output); $I_{\text{ISO}} = 45\ \text{mA}$ <sup>(2)</sup>	5.1	5.4	5.7	V
		SEL shorted to GNDS (3.3V output); $I_{\text{ISO}} = 100\ \text{mA}$ <sup>(2)</sup>	3.1	3.3	3.5	V
		SEL 100k $\Omega$ to GNDS (3.7 V output); $I_{\text{ISO}} = 90\ \text{mA}$ <sup>(2)</sup>	3.5	3.7	3.9	V
$V_{\text{ISO(RIP)}}$	Voltage ripple on isolated supply output (pk-pk)	20-MHz bandwidth, CLOAD = 10 $\mu\text{F}$    0.1 $\mu\text{F}$ , SEL shorted to VISO (5.0V output); $I_{\text{ISO}} = 100\ \text{mA}$		50		mV
		20-MHz bandwidth, CLOAD = 10 $\mu\text{F}$    0.1 $\mu\text{F}$ , SEL 100k $\Omega$ to VISO (5.4V output); $I_{\text{ISO}} = 90\ \text{mA}$		50		mV
		20-MHz bandwidth, CLOAD = 10 $\mu\text{F}$    0.1 $\mu\text{F}$ , SEL shorted to GNDS (3.3V output); $I_{\text{ISO}} = 145\ \text{mA}$		50		mV
		20-MHz bandwidth, CLOAD = 10 $\mu\text{F}$    0.1 $\mu\text{F}$ , SEL shorted to GNDS (3.7V output); $I_{\text{ISO}} = 130\ \text{mA}$		50		mV
$V_{\text{ISO(LINE)}}$	$V_{\text{ISO}}$ DC line regulation	SEL shorted to VISO (5.0 V output); $I_{\text{ISO}} = 50\ \text{mA}$ , $V_{\text{INP}} = 4.5\ \text{V}$ to $5.5\ \text{V}$		1%		
		SEL shorted to GNDS (3.3 V output); $I_{\text{ISO}} = 75\ \text{mA}$ , $V_{\text{INP}} = 4.5\ \text{V}$ to $5.5\ \text{V}$		1%		

## 6.9 Electrical Characteristics (continued)

Over operating temperature range ( $T_J = -40^\circ\text{C}$  to  $150^\circ\text{C}$ ),  $V_{INP} = 4.5\text{V}$  to  $5.5\text{V}$ ,  $C_{INP} = C_{OUT} = 10\ \mu\text{F}$ , SEL connected to  $V_{ISO}$ , internal clock mode, unless otherwise noted. All typical values at  $T_J = 25^\circ\text{C}$  and  $V_{INP} = 5.0\text{V}$ .

	PARAMETER	TEST CONDITIONS	MIN	TYP	MAX	UNIT
$V_{ISO(\text{LOAD})}$	$V_{ISO}$ DC load regulation	SEL shorted to $V_{ISO}$ (5.0 V output); $I_{ISO} = 0$ to 100 mA		1.5%		
	$V_{ISO}$ DC load regulation	SEL shorted to GNDS (3.3 V output); $I_{ISO} = 0$ to 145 mA		1.5%		
EFF	Efficiency at maximum recommended load <sup>(1)</sup>	SEL shorted to $V_{ISO}$ (5.0 V output); $I_{ISO} = 100$ mA		60%		
		SEL 100k $\Omega$ to $V_{ISO}$ (5.4V output); $I_{ISO} = 90$ mA		60%		
		SEL shorted to GNDS (3.3V output); $I_{ISO} = 145$ mA		50%		
		SEL 100k $\Omega$ to GNDS (3.7V output); $I_{ISO} = 130$ mA		53%		
$t_{RISE}$	$V_{ISO}$ rise time, 10% - 90%	EN = change from LO to HI, SEL shorted to $V_{ISO}$ (5.0V output); $I_{ISO} = 1$ mA		750		$\mu\text{s}$
		EN = change from LO to HI, SEL 100k $\Omega$ to GNDS (3.3V output); $I_{ISO} = 1$ mA		300		$\mu\text{s}$
<b>THERMAL SHUTDOWN</b>						
$TSD_{THR}$	Thermal shutdown threshold	Junction Temperature, Rising		165		$^\circ\text{C}$
$TSD_{HYST}$	Thermal shutdown hysteresis	Junction Temperature, Falling		27		$^\circ\text{C}$

(1) Efficiency calculation:  $EFF = (V_{ISO} \times I_{ISO}) / (V_{INP} \times I_{INP})$

(2) See the [§ 7.3.3](#) section for discussion of  $V_{ISO}$  regulation across load and temperature conditions for all output voltage settings.

## 6.10 Switching Characteristics

Over operating temperature range ( $T_J = -40^\circ\text{C}$  to  $150^\circ\text{C}$ ),  $V_{INP} = 4.5\text{V}$  to  $5.5\text{V}$ ,  $C_{INP} = C_{OUT} = 10\ \mu\text{F}$ , SEL connected to  $V_{ISO}$ , internal clock mode, unless otherwise noted. All typical values at  $T_J = 25^\circ\text{C}$  and  $V_{INP} = 5.0\text{V}$ .

	PARAMETER	TEST CONDITIONS	MIN	TYP	MAX	UNIT
$f_{SW\_INT}$	DC/DC Converter Clock	Internal clock mode	7.2	8	8.8	MHz
CMTI	Static common-mode transient immunity	Slew Rate of GNPD versus GNDS, $V_{CM} = 1000\ \text{V}$		100		V/ns

### 6.11 Insulation Characteristics Curves

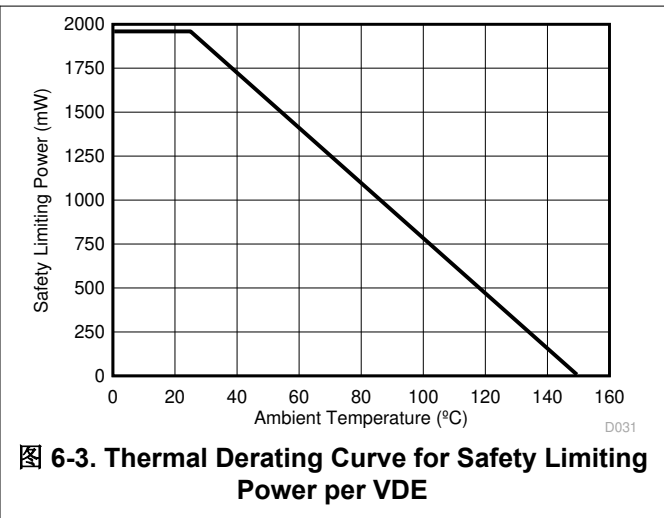
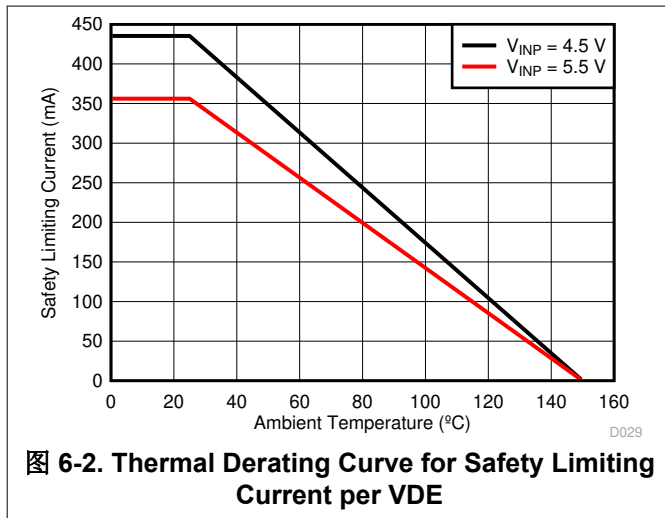
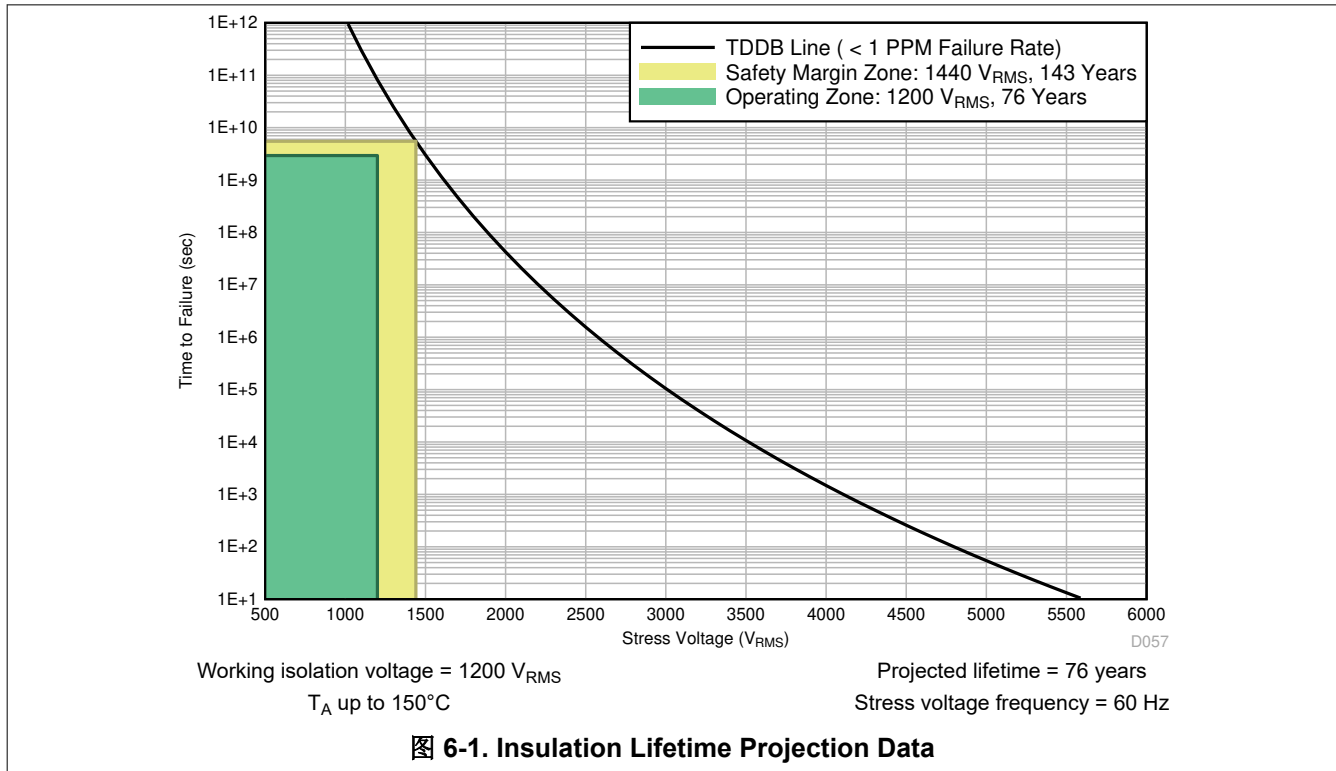

## 6.12 Typical Characteristics



图 6-4. Maximum  $V_{ISO}$  Output Power vs. Temperature



图 6-5. Maximum  $V_{ISO}$  Output Power vs. Temperature

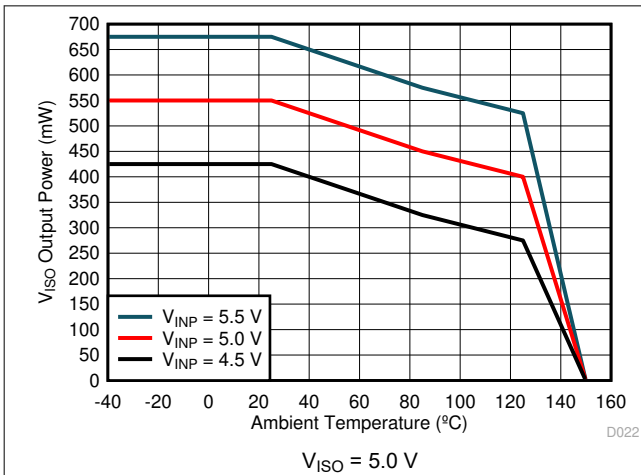

图 6-6. Maximum  $V_{ISO}$  Output Power vs. Temperature

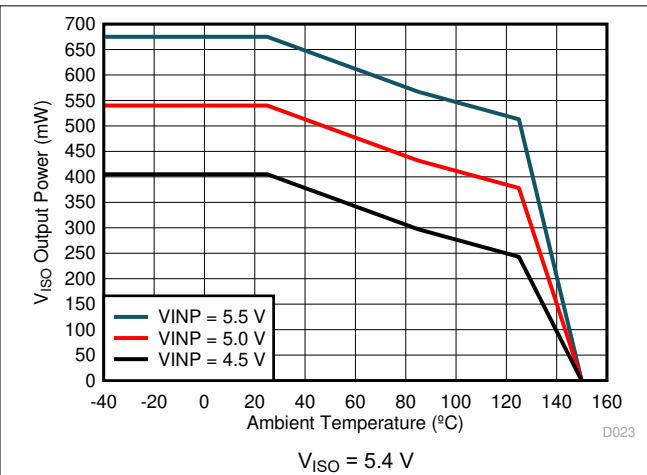

图 6-7. Maximum  $V_{ISO}$  Output Power vs. Temperature

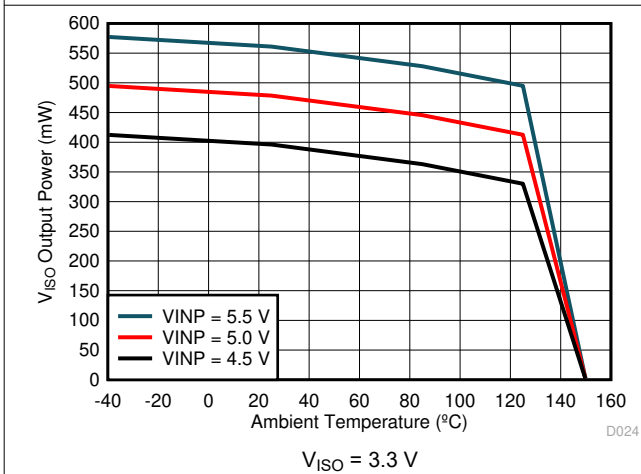

图 6-8. Maximum  $V_{ISO}$  Output Current vs. Temperature

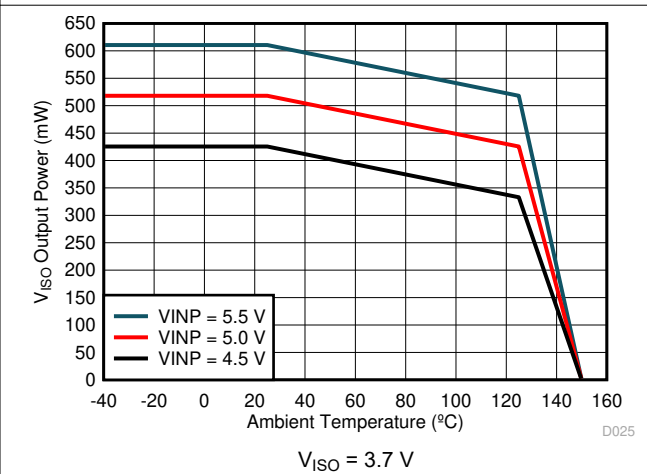

图 6-9. Maximum  $V_{ISO}$  Output Current vs. Temperature

### 6.12 Typical Characteristics (continued)

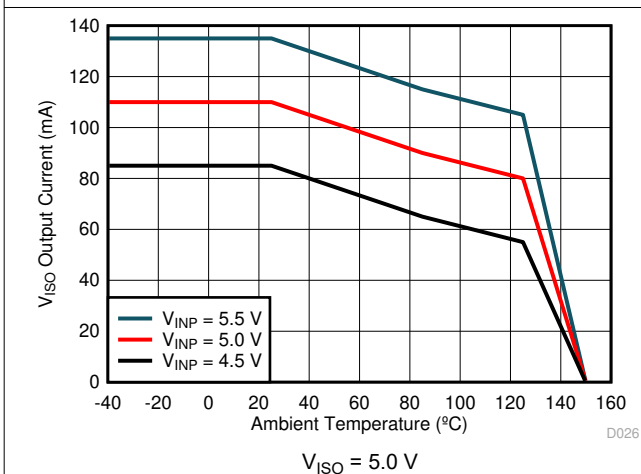

图 6-10. Maximum  $V_{ISO}$  Output Current vs. Temperature

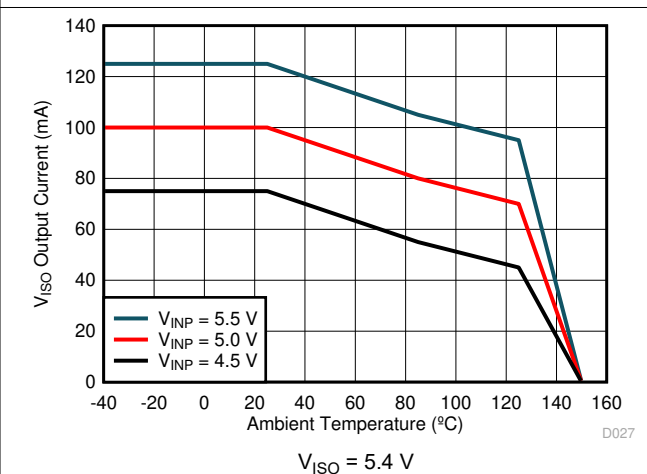

图 6-11. Maximum  $V_{ISO}$  Output Current vs. Temperature

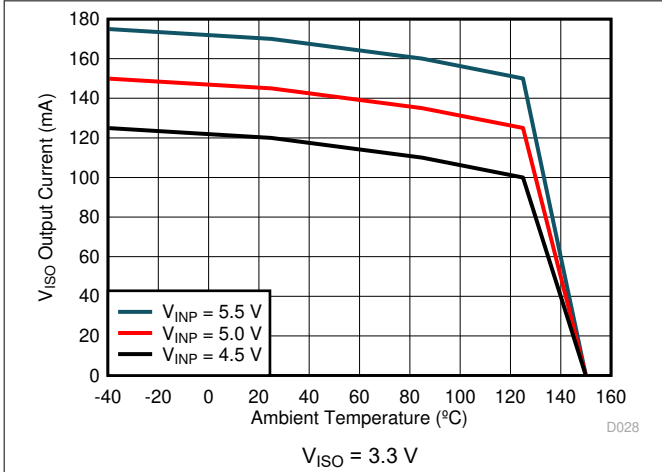

图 6-12. Power Supply Efficiency vs Load Current ( $I_{ISO}$ )

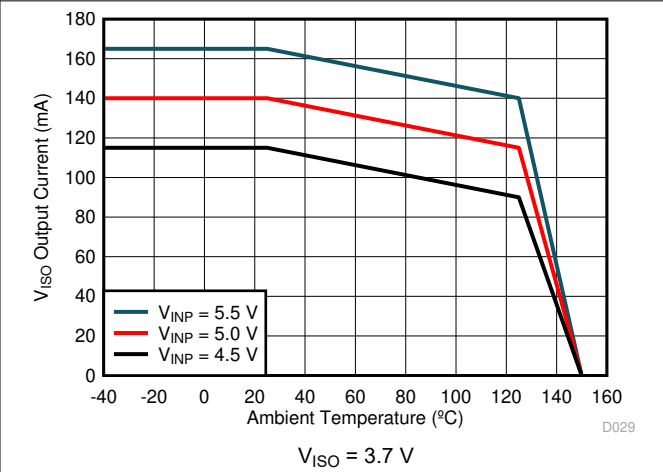

图 6-13. Power Supply Efficiency vs Load Current ( $I_{ISO}$ )

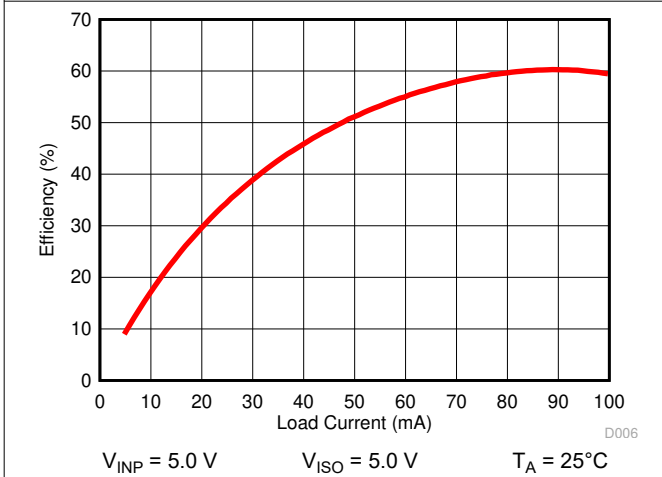

图 6-14. Power Supply Efficiency vs Load Current ( $I_{ISO}$ )

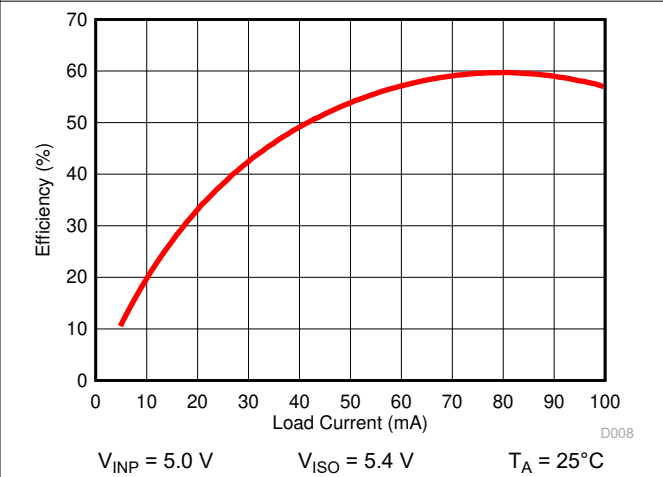

图 6-15. Power Supply Efficiency vs Load Current ( $I_{ISO}$ )

### 6.12 Typical Characteristics (continued)

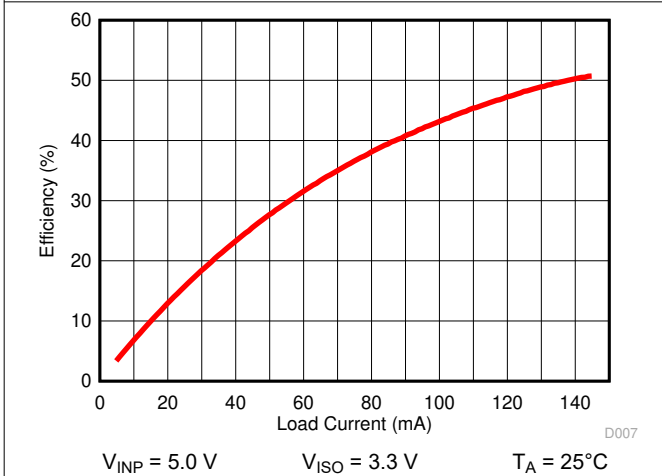

图 6-16. Isolated Supply Voltage ( $V_{ISO}$ ) vs Load Current ( $I_{ISO}$ )

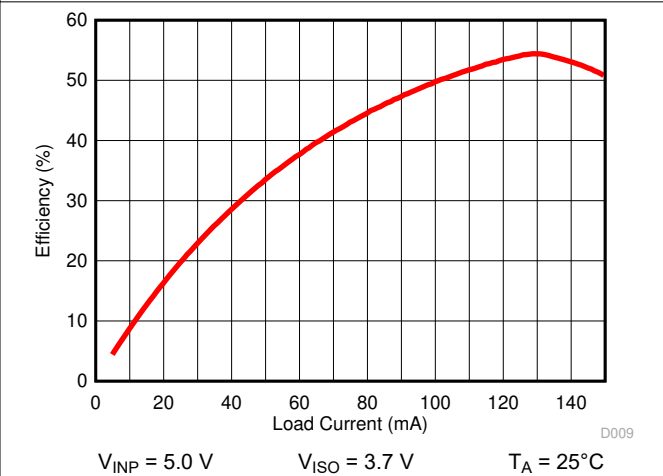

图 6-17. Isolated Supply Voltage ( $V_{ISO}$ ) vs Load Current ( $I_{ISO}$ )

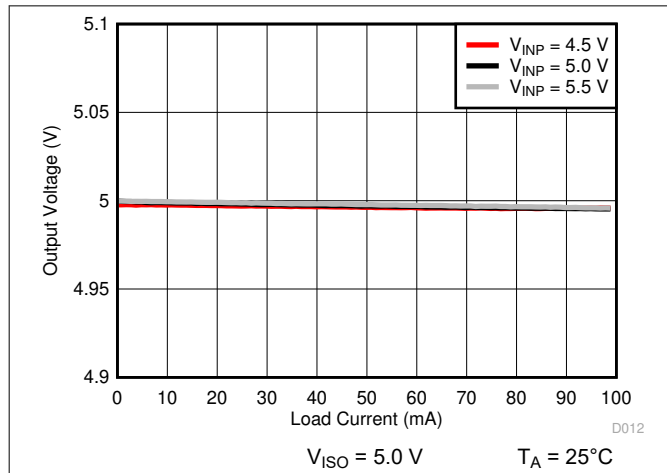

图 6-18. Isolated Supply Voltage ( $V_{ISO}$ ) vs Load Current ( $I_{ISO}$ )

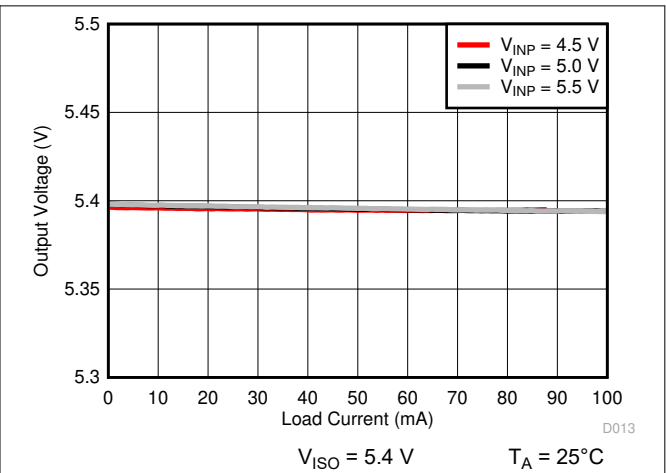

图 6-19. Isolated Supply Voltage ( $V_{ISO}$ ) vs Load Current ( $I_{ISO}$ )

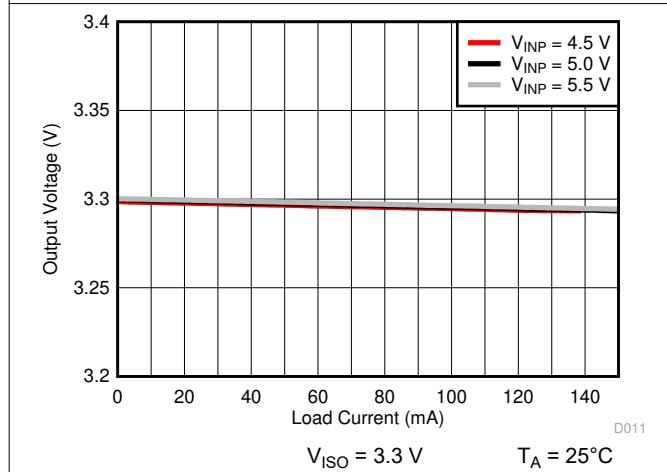

图 6-20. Isolated Supply Voltage ( $V_{ISO}$ ) vs Free-Air Temperature

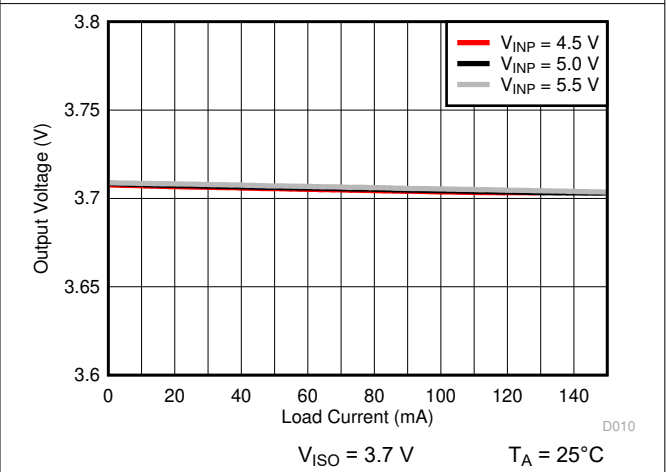

图 6-21. Isolated Supply Voltage ( $V_{ISO}$ ) vs Free-Air Temperature

### 6.12 Typical Characteristics (continued)

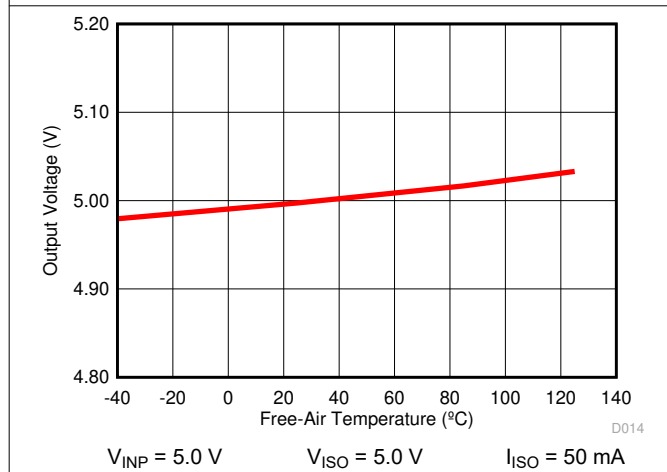

图 6-22. Isolated Supply Voltage ( $V_{ISO}$ ) vs Free-Air Temperature

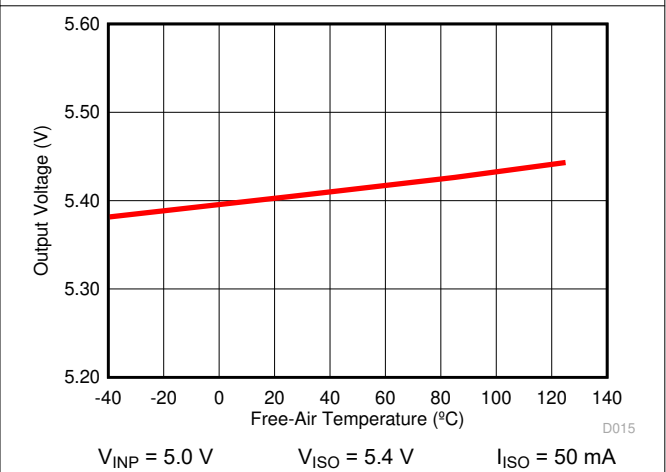

图 6-23. Isolated Supply Voltage ( $V_{ISO}$ ) vs Free-Air Temperature

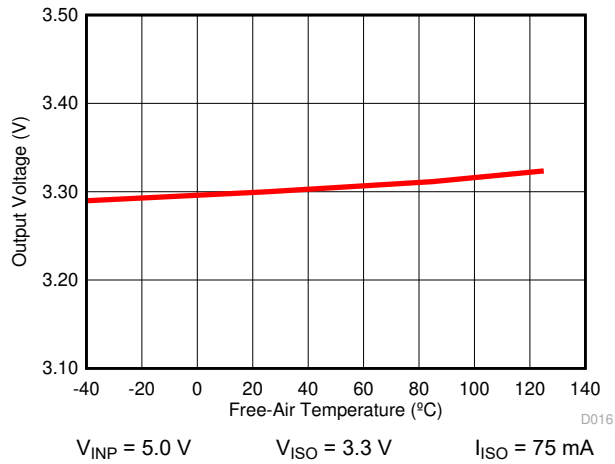

图 6-24. Short-Circuit Supply Current ( $I_{VIN\_SC}$ ) vs Supply Voltage ( $V_{INP}$ )

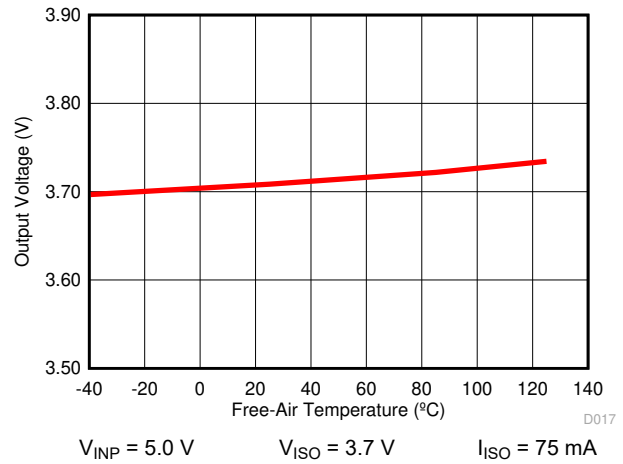

图 6-25. Input Supply Current ( $I_{VINP}$ ) vs Load Current ( $I_{ISO}$ )

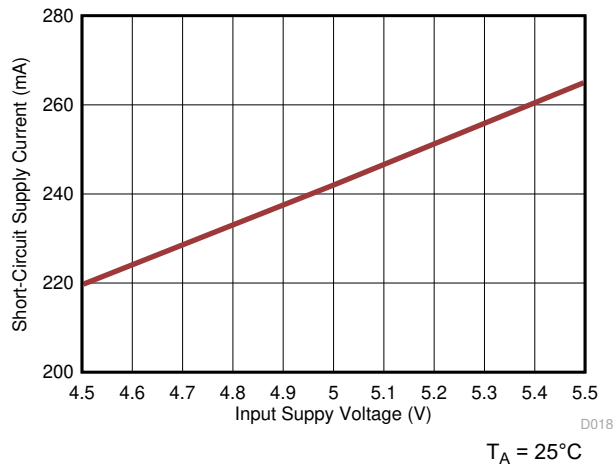

图 6-26. Typical  $V_{INP}$  UVLO Threshold vs Junction Temperature ( $T_J$ )

## 7 Detailed Description

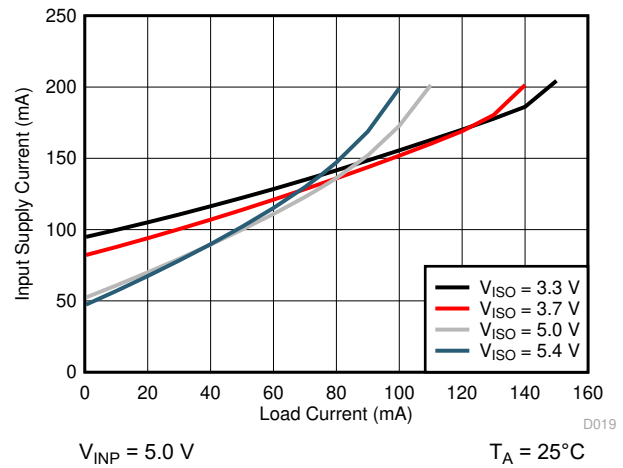
### 7.1 Overview

The UCC12050 device integrates a high-efficiency, low-emissions isolated DC/DC converter. This approach provides typically 500 mW of clean, steady power across a 5000  $V_{RMS}$  reinforced isolation barrier.

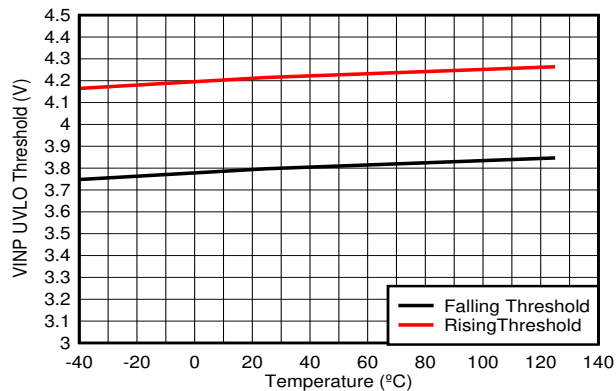
The integrated DC/DC converter uses switched mode operation and proprietary circuit techniques to reduce power losses and boost efficiency. Specialized control mechanisms, clocking schemes, and the use of an on-chip transformer provide high efficiency and low radiated emissions.

The VINP supply is provided to the primary power controller that switches the power stage connected to the integrated transformer. Power is transferred to the secondary side, rectified, and regulated to a level set by the SEL pin condition.

A fast feedback control loop monitors VISO and the output load, and ensures low overshoots and undershoots during load transients. Undervoltage lockout (UVLO) with hysteresis is integrated on the VINP supply, which ensures robust system performance under noisy conditions.

UCC12050 is suitable for applications that have limited board space and require more integration. These devices are also suitable for very-high voltage applications, where power transformers meeting the required isolation specifications are bulky and expensive.

### 7.2 Functional Block Diagram

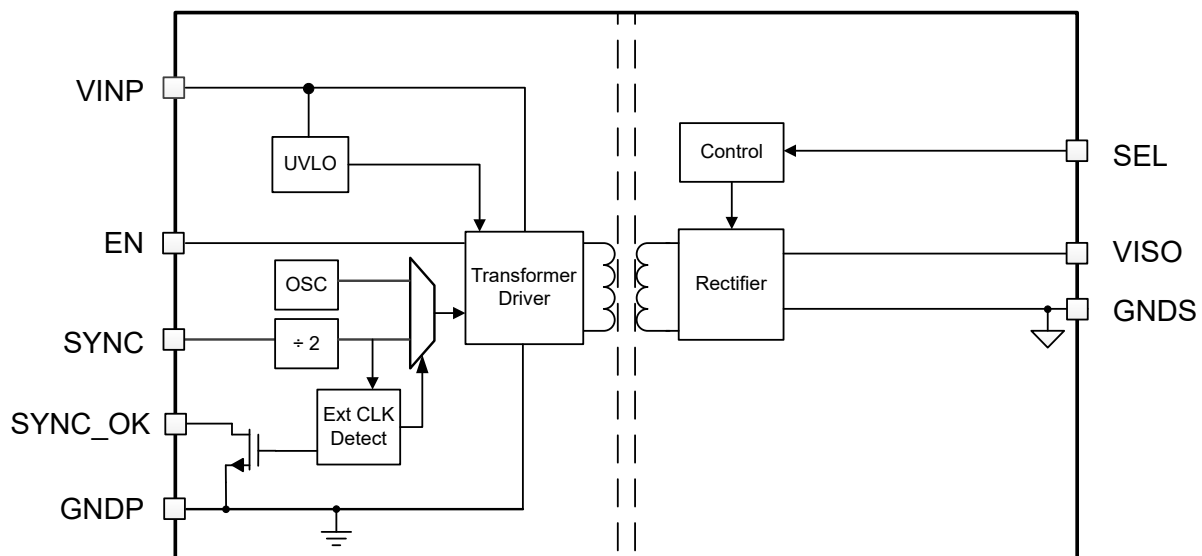

### 7.3 Feature Description

#### 7.3.1 Enable and Disable

Forcing EN low disables the device, which greatly reduces the VINP power consumption. Pull the EN pin high to enable normal device functionality. The EN pin has a weak internal pull-down resistor, so the device floats to the disable state if the pin is left open.

#### 7.3.2 UVLO, Power-Up, and Power-Down Behavior

The UCC12050 has an undervoltage lockout (UVLO) on the VINP power supply. Upon power-up, while the VINP voltage is below the threshold voltage  $V_{UVPR}$ , the primary side transformer driver is disabled, and VISO output is off. The output powers up once the threshold is met. Likewise, if VINP falls below  $V_{UVPF}$ , the converter is disabled and there is no output at VISO. Both UVLO threshold voltages have hysteresis to avoid chattering.

### 7.3.3 $V_{ISO}$ Load Recommended Operating Area

图 7-1 depicts the device  $V_{ISO}$  regulation behavior across the output load range, including when the output is overloaded. For proper device operation, ensure that the device  $V_{ISO}$  output load does not exceed the maximum output current ( $I_{OUT\_MAX}$ ). The value for  $I_{OUT\_MAX}$  over different temperature and  $V_{INP}$  conditions are shown from 图 6-8 to 图 6-11. The following protection mechanisms will be engaged if the UCC12050 is loaded beyond the recommended operating area:

1. The device limits the maximum output power. If a load exceeding  $I_{OUT\_MAX}$  is applied,  $V_{ISO}$  drops accordingly to meet the maximum power limit.
2. If  $V_{ISO}$  drops below nominal 3.8 V while operating in the constant power limit region, the over-power fold-back feature will switch the power converter from active rectification to passive rectification, and the built-in recovery hysteresis will ensure the UCC12050 recovers at a lower output power. The device returns to active rectification when load drops and  $V_{ISO}$  increases above nominal 4.3V.
3. The device triggers a soft-start reset if  $V_{ISO}$  drops below the nominal 1.8-V threshold. This reset is designed to protect the device during  $V_{ISO}$  short-circuit conditions.
4. Thermal shutdown protection disables the converter if the device is operated in any of the above regions long enough to raise the silicon junction temperature above the thermal shutdown threshold. See the 节 7.3.4 section for more details on this device feature.



图 7-1.  $V_{ISO}$  Load Recommended Operating Area Description

### 7.3.4 Thermal Shutdown

Thermal protection is also integrated to help prevent the device from getting damaged during overload and short-circuit conditions on the isolated output. Under these conditions, the device temperature starts to increase. When the silicon junction temperature  $T_j$  sensed at the primary side die goes above the threshold  $TSD_{THR}$  (typical  $165^{\circ}C$ ), thermal shutdown activates and the primary controller turns off which removes the energy supplied to the  $V_{ISO}$  load, which causes the device to cool off. When the junction temperature drops approximately  $27^{\circ}C$  ( $TSD_{HYST}$ ) from the shutdown point, the device starts to function normally. If an overload or output short-circuit condition prevails, this protection cycle is repeated. Make sure the design prevents the device junction temperatures from reaching such high values.

### 7.3.5 External Clocking and Synchronization

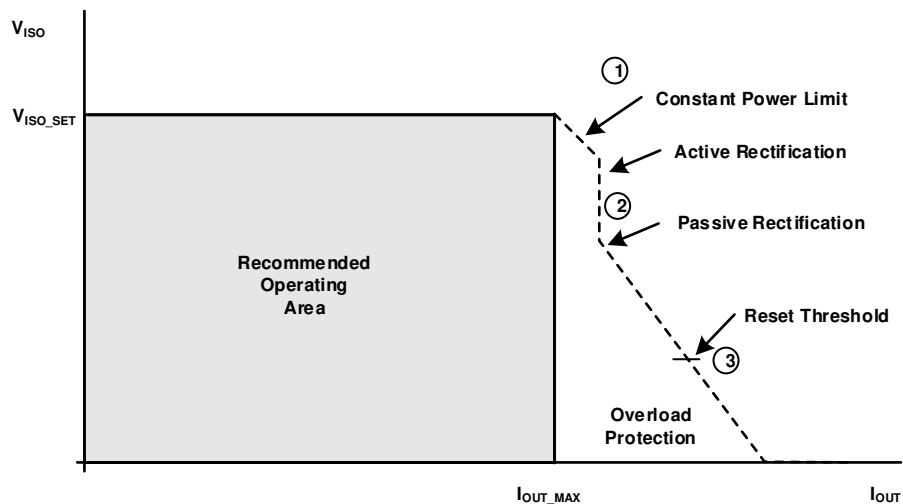
The UCC12050 has an internal oscillator trimmed to drive the transformer at 8.0 MHz. An external clock may be applied at the SYNC pin to override the internal oscillator. This external clock will be divided by 2, so the target range for the external clock signal at SYNC is  $16\text{ MHz} \pm 10\%$ . When a valid external clock signal is detected, the internal spread spectrum modulation (SSM) algorithm is disabled. This allows an external clock signal with a unique SSM to be applied. The depth and frequency of SSM is a tradeoff versus low frequency modulated  $V_{ISO}$  voltage ripple. The SYNC\_OK pin is asserted LOW if there is no external SYNC clock or one that is outside of

the operating range of the device is detected. In this state, the external clock is ignored and the DC/DC converter is clocked by the internal oscillator. The pin is in high impedance if a valid clock is applied on SYNC.

### 7.3.6 $V_{ISO}$ Output Voltage Selection

The SEL pin is monitored during power-up — within the first 1 ms after applying VINP above the UVLO rising threshold or enabling via the EN pin — to detect the desired regulation voltage for the VISO output. Note that after this initial monitoring, the SEL pin no longer affects the VISO output level. In order to change the output mode selection, either the EN pin must be toggled or the VINP power supply must be cycled off and back on. Section 6.4 provides more details on the SEL pin functionality.

### 7.3.7 Electromagnetic Compatibility (EMC) Considerations

UCC12050 devices use spread spectrum modulation for the internal oscillator and advanced internal layout scheme to minimize radiated emissions at the system level.

Many applications in harsh industrial environment are sensitive to disturbances such as electrostatic discharge (ESD), electrical fast transient (EFT), surge and electromagnetic emissions. These electromagnetic disturbances are regulated by international standards such as IEC 61000-4-x and CISPR 32. Although system-level performance and reliability depends, to a large extent, on the application board design and layout, the device incorporates many chip-level design improvements for overall system robustness.

## 7.4 Device Functional Modes

表 7-1 lists the supply functional modes for this device.

表 7-1. Device Functional Modes

INPUTS		Isolated Supply Output Voltage ( $V_{ISO}$ ) Setpoint
EN	SEL	
HIGH	Shorted to VISO	5.0 V
HIGH	100 k $\Omega$ to VISO	5.4 V
HIGH	Shorted to GNDS	3.3 V
HIGH	100 k $\Omega$ to GNDS	3.7 V
HIGH	OPEN <sup>(1)</sup>	UNSUPPORTED
LOW	X	0 V

(1) The SEL pin has an internal weak pull-down resistance to ground, but leaving this pin open is not recommended.

## 8 Application and Implementation

### 备注

以下应用部分中的信息不属于 TI 器件规格的范围，TI 不担保其准确性和完整性。TI 的客户应负责确定器件是否适用于其应用。客户应验证并测试其设计，以确保系统功能。

### 8.1 Application Information

The UCC12050 device is suitable for applications that have limited board space and desire more integration. This device is also suitable for very high voltage applications, where power transformers meeting the required isolation specifications are bulky and expensive.

### 8.2 Typical Application

图 8-1 shows the typical application schematic for the UCC12050 device supplying an isolated load.



图 8-1. Typical Application

## 8.2.1 Design Requirements

To design using UCC12050, a few simple design considerations must be evaluated. 表 8-1 shows some recommended values for a typical application. See 节 9 and 节 10 sections to review other key design considerations for the UCC12050.

表 8-1. Design Parameters

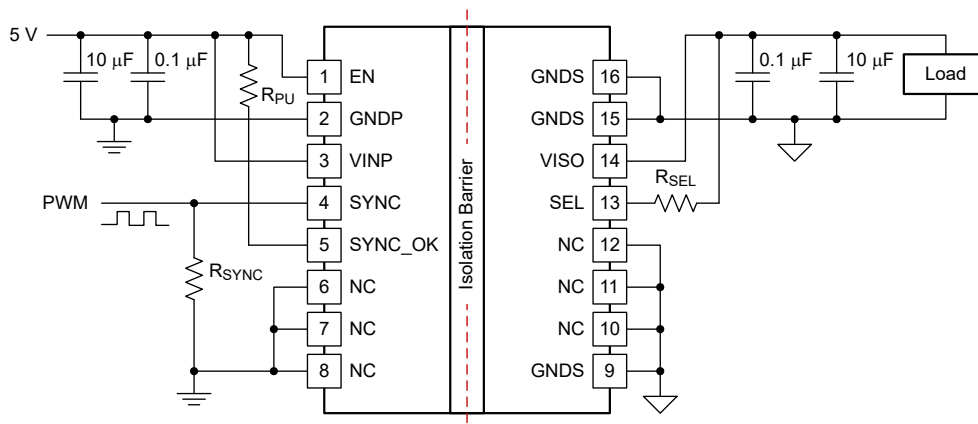
PARAMETER	RECOMMENDED VALUE
Input supply voltage, $V_{INP}$	4.5 V to 5.5 V
Decoupling capacitance between $V_{INP}$ and GNDP	10 $\mu$ F, 16 V, $\pm$ 10%, X7R
Decoupling capacitance between $V_{ISO}$ and GNDS <sup>(1)</sup>	10 $\mu$ F, 16 V, $\pm$ 10%, X7R
Optional additional capacitance on $V_{ISO}$ or $V_{INP}$ to reduce high-frequency ripple	0.1 $\mu$ F, 50 V, $\pm$ 10%, X7R
Pull-up resistor from SYNC_OK to $V_{INP}$ , $R_{PU}$	100 k $\Omega$
Pull-up resistor from SEL to $V_{ISO}$ for 5.0V output voltage mode, $R_{SEL}$	0 $\Omega$
Pull-up resistor from SEL to $V_{ISO}$ for 5.4V output voltage mode, $R_{SEL}$	100 k $\Omega$
Optional SYNC signal impedance-matching resistor, $R_{SYNC}$	Match source — typical values are 50 $\Omega$ , 75 $\Omega$ , 100 $\Omega$ , or 1 k $\Omega$
External clock signal applied on SYNC	16 MHz

(1) See 节 8.2.2.1 section.

## 8.2.2 Detailed Design Procedure

Place ceramic decoupling capacitors as close as possible to the device pins. For the input supply, place the capacitor(s) between pin 3 ( $V_{INP}$ ) and pin 2 (GNDP). For the isolated output supply, place the capacitor(s) between pin 14 ( $V_{ISO}$ ) and pin 15 (GNDS). This location is of particular importance to the input decoupling capacitor, because this capacitor supplies the transient current associated with the fast switching waveforms of the power drive circuits. The recommended capacitor value is 10  $\mu$ F. Ensure the capacitor dielectric material is compatible with the target application temperature.

### 8.2.2.1 $V_{ISO}$ Output Capacitor Selection

The UCC12050 is optimized to run with an effective output capacitance of 5  $\mu$ F to 20  $\mu$ F. A ceramic capacitor is recommended. Ceramic capacitors have DC-Bias and temperature derating effects, which both have influence the final effective capacitance. Choose the right capacitor carefully in combination with considering its package size, dielectric and voltage rating. It is good design practice to include one 0.1- $\mu$ F capacitor close to the device for high-frequency noise reduction.

### 8.2.3 Application Curves

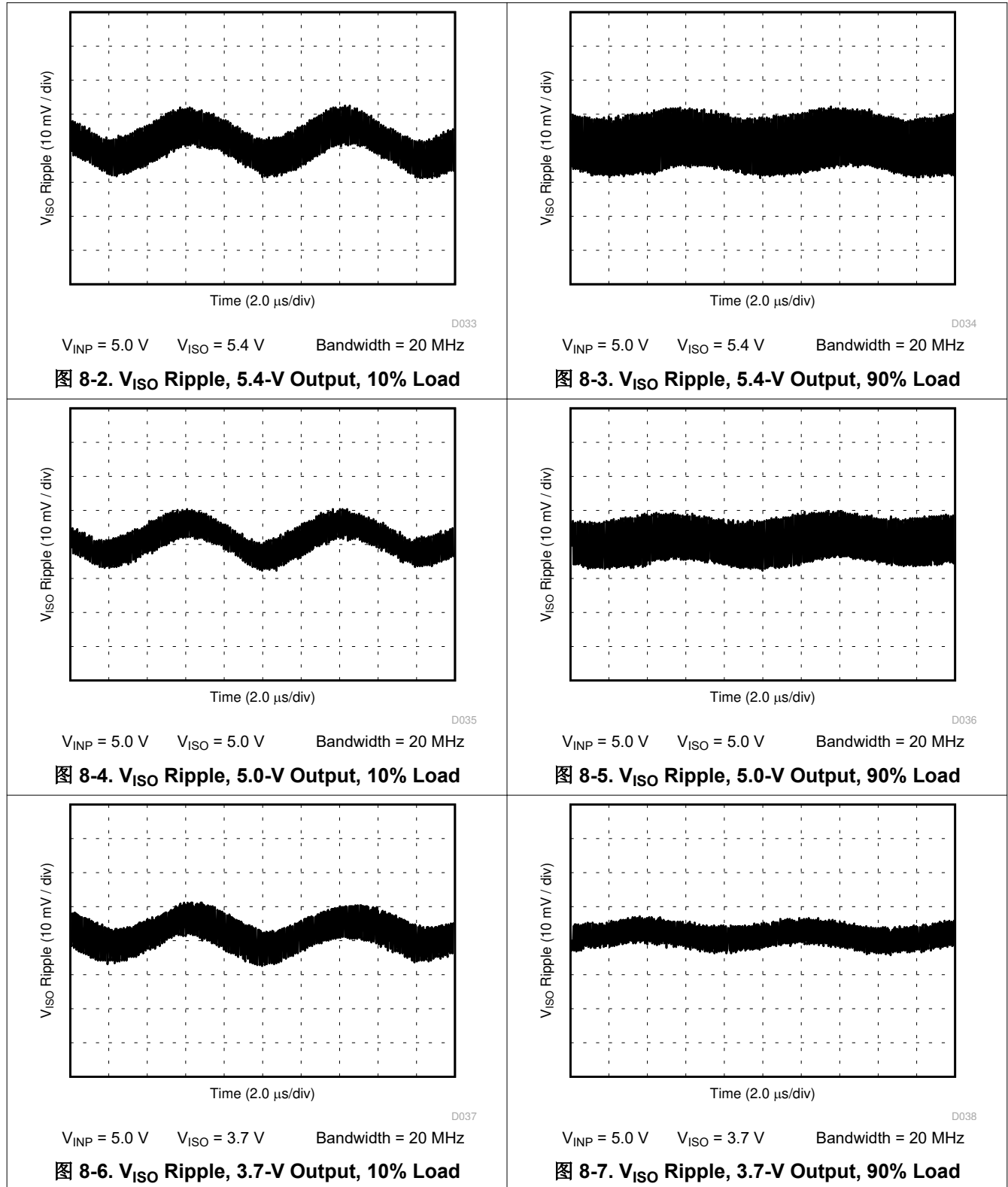

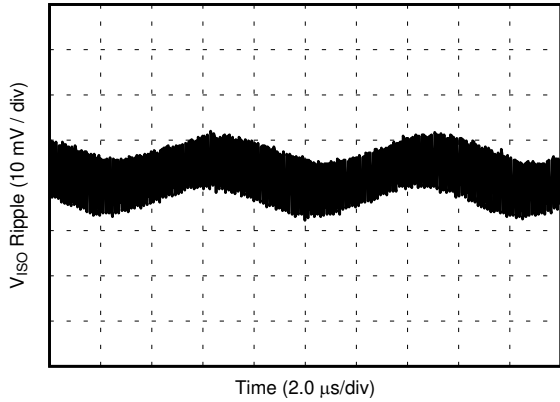

D039  
 $V_{INP} = 5.0\text{ V}$   $V_{ISO} = 3.3\text{ V}$  Bandwidth = 20 MHz

**图 8-8.  $V_{ISO}$  Ripple, 3.3-V Output, 10% Load**

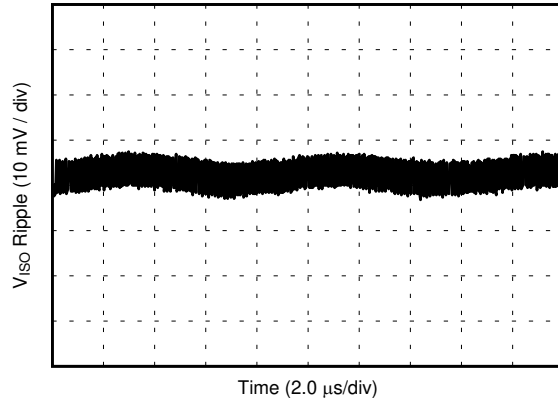

D040  
 $V_{INP} = 5.0\text{ V}$   $V_{ISO} = 3.3\text{ V}$  Bandwidth = 20 MHz

**图 8-9.  $V_{ISO}$  Ripple, 3.3-V Output, 90% Load**

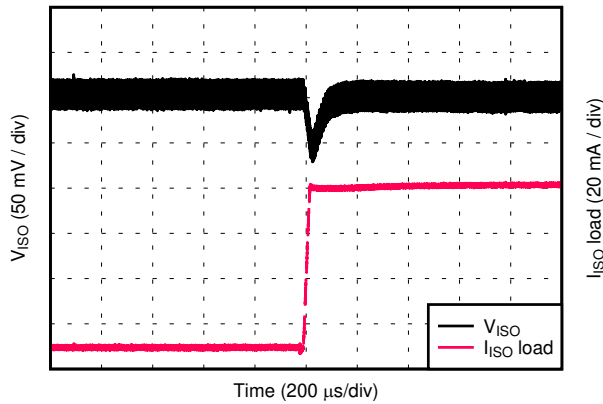

D041  
**图 8-10.  $V_{ISO}$  Load Transient Response, 10% to 90% Load Step, 5.0-V Input, 5.4-V Output**

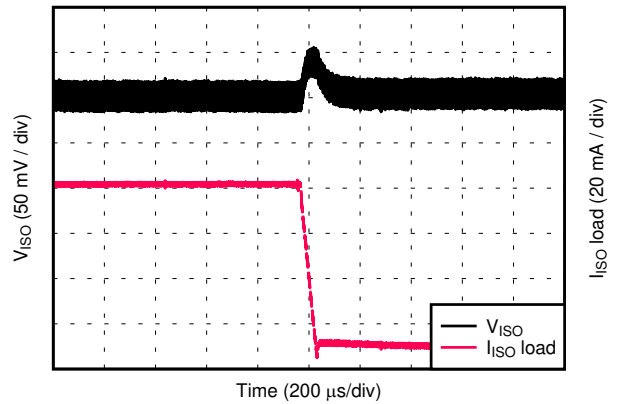

D042  
**图 8-11.  $V_{ISO}$  Load Transient Response, 90% to 10% Load Step, 5.0-V Input, 5.4-V Output**

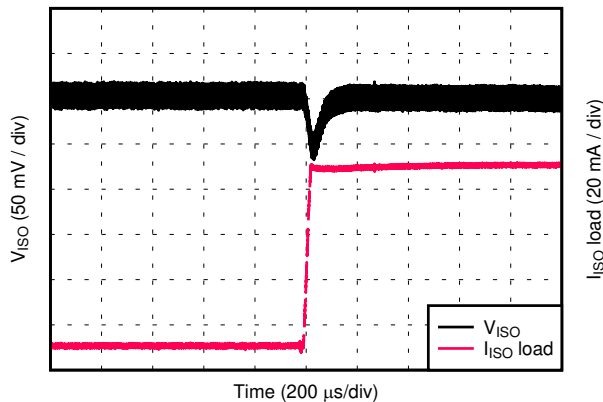

D043  
**图 8-12.  $V_{ISO}$  Load Transient Response, 10% to 90% Load Step, 5.0-V Input, 5.0-V Output**

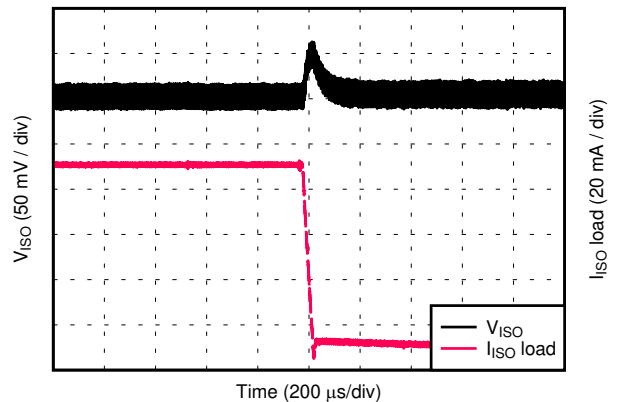

D044  
**图 8-13.  $V_{ISO}$  Load Transient Response, 90% to 10% Load Step, 5.0-V Input, 5.0-V Output**



图 8-14.  $V_{ISO}$  Load Transient Response, 10% to 90% Load Step, 5.0-V Input, 3.7-V Output

D045

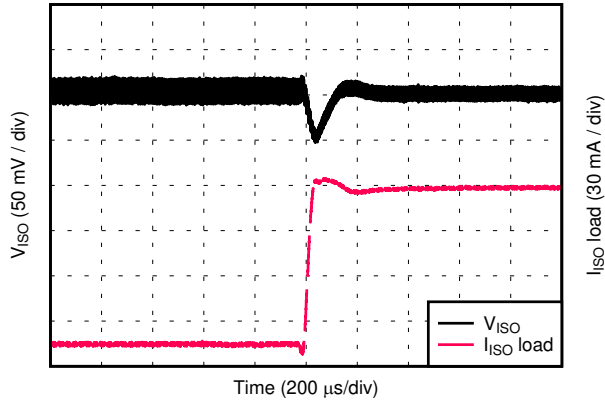

图 8-15.  $V_{ISO}$  Load Transient Response, 90% to 10% Load Step, 5.0-V Input, 3.7-V Output

D046

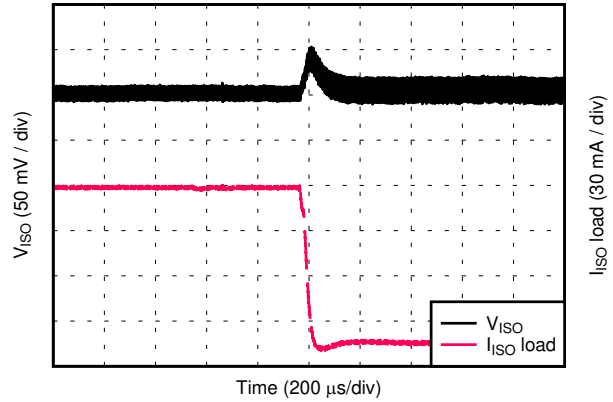

图 8-16.  $V_{ISO}$  Load Transient Response, 10% to 90% Load Step, 5.0-V Input, 3.3-V Output

D047

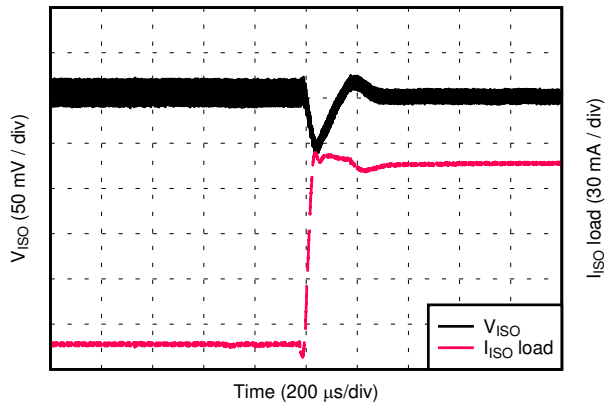

图 8-17.  $V_{ISO}$  Load Transient Response, 90% to 10% Load Step, 5.0-V Input, 3.3-V Output

D047

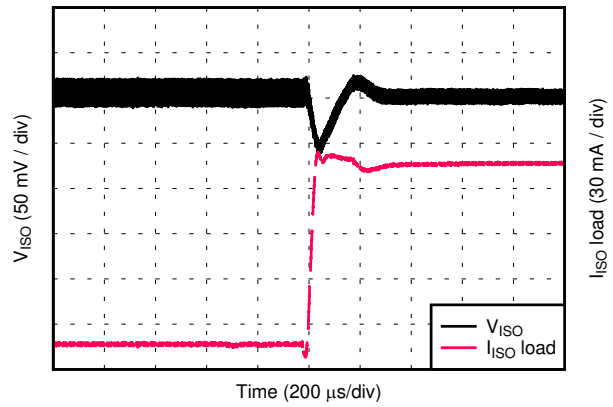

图 8-18.  $V_{ISO}$  Soft Start at 10% Rated Load, 5.0-V Input, 5.4-V Output

D049

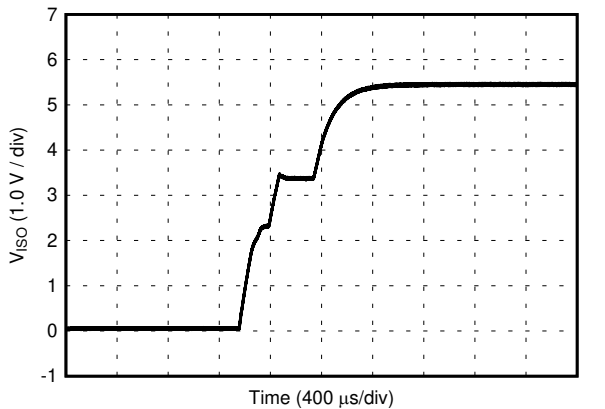

图 8-19.  $V_{ISO}$  Soft Start at 90% Rated Load, 5.0-V Input, 5.4-V Output

D050

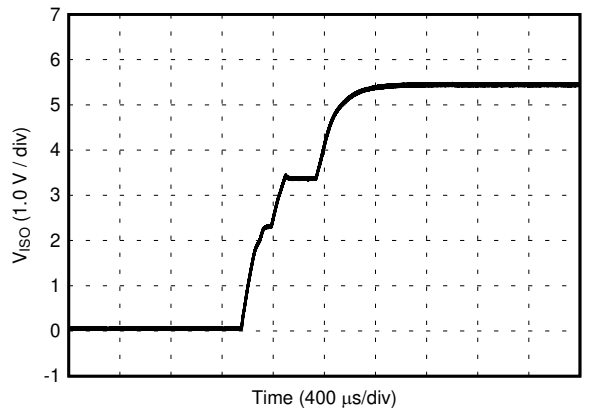
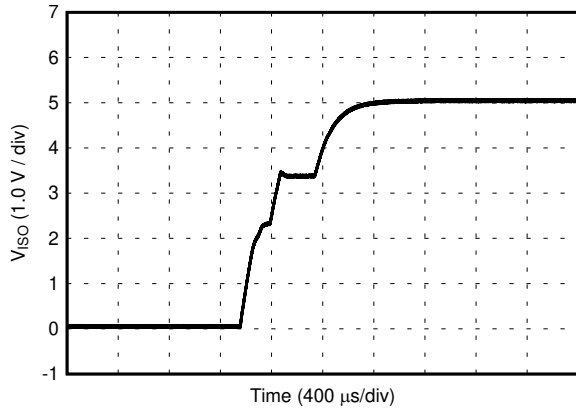

D051

**图 8-20.  $V_{ISO}$  Soft Start at 10% Rated Load, 5.0-V Input, 5.0-V Output**

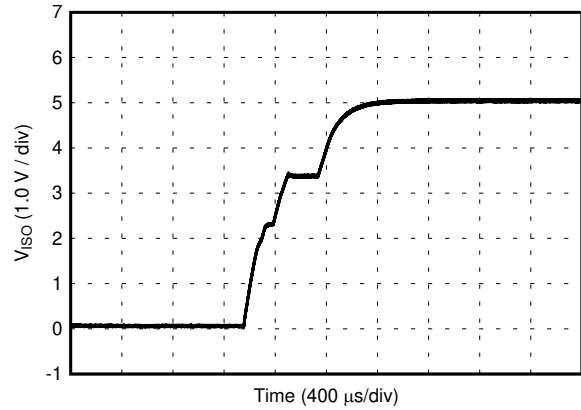

D052

**图 8-21.  $V_{ISO}$  Soft Start at 90% Rated Load, 5.0-V Input, 5.0-V Output**

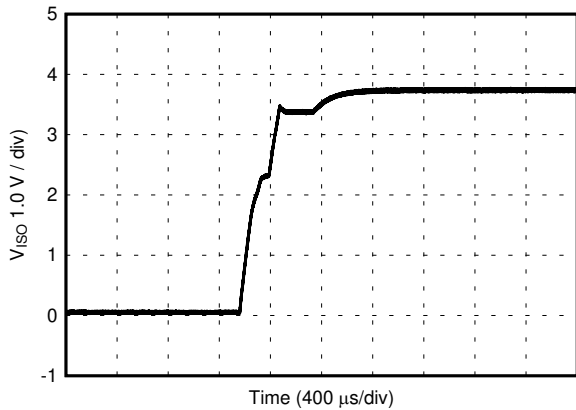

D053

**图 8-22.  $V_{ISO}$  Soft Start at 10% Rated Load, 5.0-V Input, 3.7-V Output**

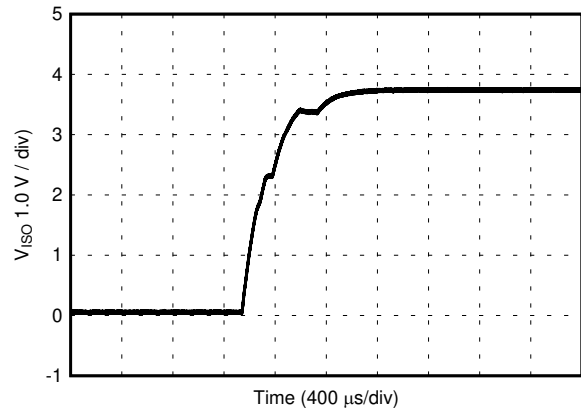

D054

**图 8-23.  $V_{ISO}$  Soft Start at 90% Rated Load, 5.0-V Input, 3.7-V Output**

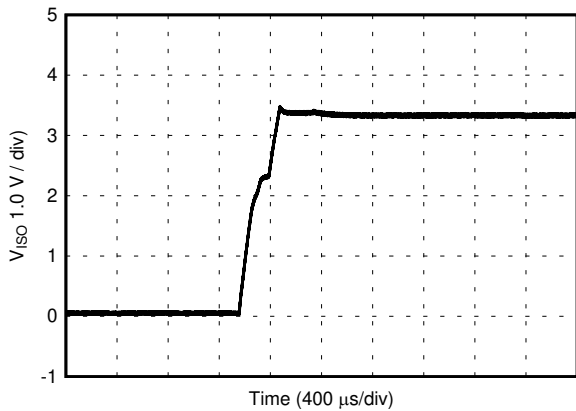

D055

**图 8-24.  $V_{ISO}$  Soft Start at 10% Rated Load, 5.0-V Input, 3.3-V Output**

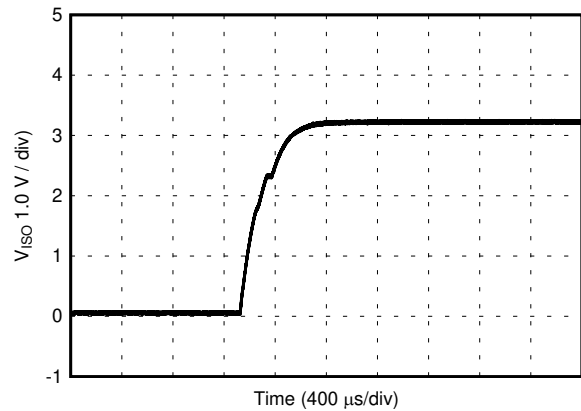

D056

**图 8-25.  $V_{ISO}$  Soft Start at 90% Rated Load, 5.0-V Input, 3.3-V Output**

## 9 Power Supply Recommendations

The recommended input supply voltage (VINP) for the UCC12050 is between 4.5 V and 5.5 V. To help ensure reliable operation, adequate decoupling capacitors must be located as close to supply pins as possible. Place local bypass capacitors between the VINP and GNDP pins at the input, and between VISO and GNDS at the isolated output supply. Low ESR, ceramic surface mount capacitors are recommended. It is further suggested that one place two such capacitors: one with a value of 10  $\mu$ F for supply bypassing, and an additional 100-nF capacitor in parallel for high frequency filtering. The input supply must have an appropriate current rating to support output load required by the end application.

## 10 Layout

### 10.1 Layout Guidelines

The UCC12050 integrated isolated power solution simplifies system design and reduces board area usage. Proper PCB layout is important in order to achieve optimum performance. Here is a list of recommendations:

1. Place decoupling capacitors as close as possible to the device pins. For the input supply, place the capacitor(s) between pin 3 (VINP) and pin 2 (GNDP). For the isolated output supply, place the capacitor(s) between pin 14 (VISO) and pin 15 (GNDS). This location is of particular importance to the input decoupling capacitor, because this capacitor supplies the transient current associated with the fast switching waveforms of the power drive circuits.
2. Because the device does not have a thermal pad for heat-sinking, the device dissipates heat through the respective GND pins. Ensure that enough copper (preferably a connection to the ground plane) is present on all GNDP and GNDS pins for best heat-sinking.
3. If space and layer count allow, it is also recommended to connect the VINP, GNDP, VISO and GNDS pins to internal ground or power planes through multiple vias of adequate size. Alternatively, make traces for these nets as wide as possible to minimize losses.
4. TI also recommends grounding the no-connect pins (NC) to their respective ground planes. For pins 6, 7, and 8, connect to GNDP. For pins 10, 11, and 12, connect to GNDS. This will allow more continuous ground planes and larger thermal mass for heat-sinking.
5. A minimum of four layers is recommended to accomplish a low-EMI PCB design. Inner layers can be spaced closer than outer layers and used to create a high-frequency bypass capacitor between GNDP and GNDS to reduce radiated emissions. Ensure proper spacing, both inter-layer and layer-to-layer, is implemented to avoid reducing isolation capabilities. These spacings will vary based on the printed circuit board construction parameters, such as dielectric material and thickness.
6. Pay close attention to the spacing between primary ground plane (GNDP) and secondary ground plane (GNDS) on the PCB outer layers. The effective creepage and or clearance of the system will be reduced if the two ground planes have a lower spacing than that of the device package.
7. To ensure isolation performance between the primary and secondary side, avoid placing any PCB traces or copper below the UCC12050 device on the outer copper layers.

### 10.2 Layout Example



图 10-1. Layout Example

## 11 Device and Documentation Support

### 11.1 Device Support

#### 11.1.1 Development Support

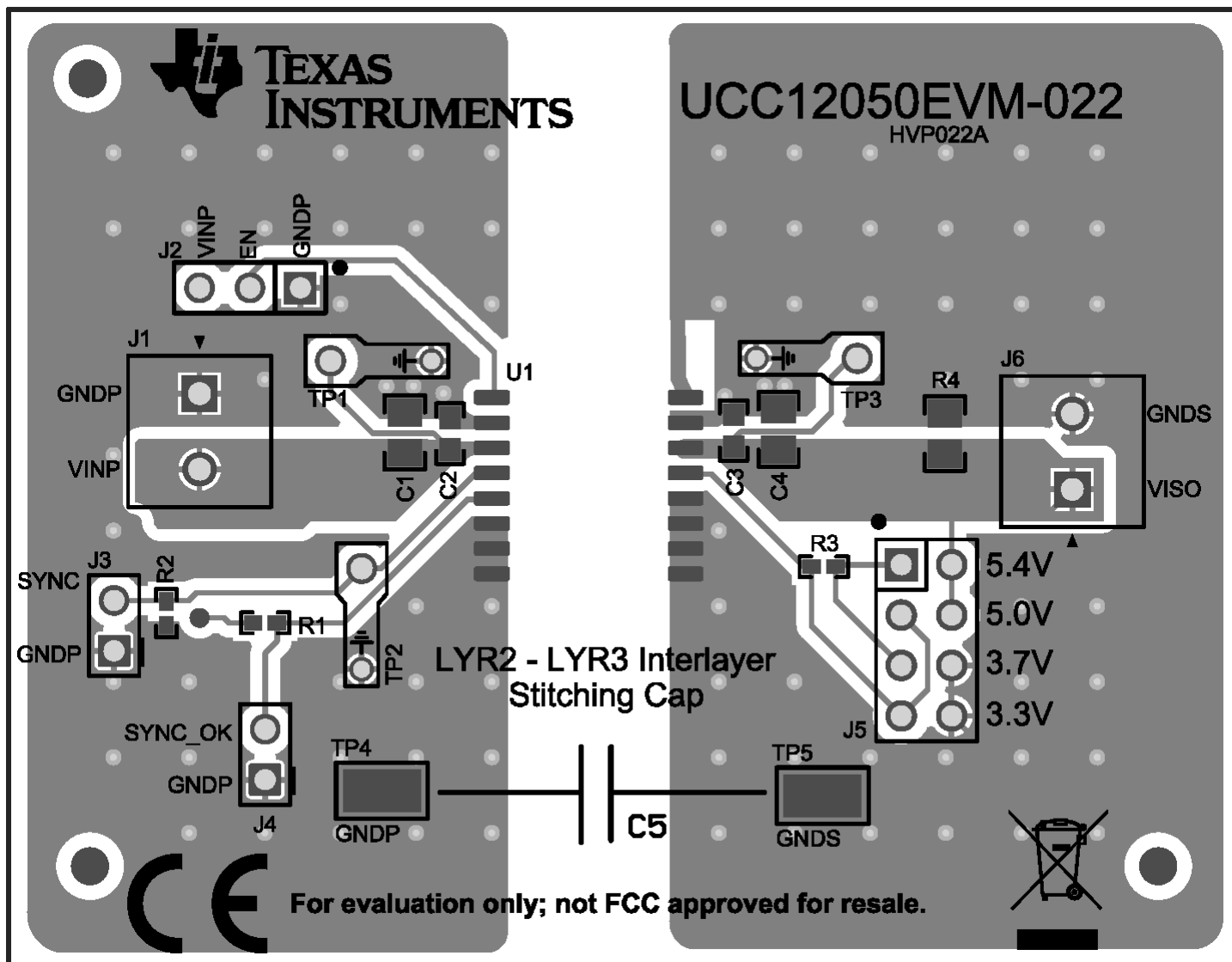
For development support, refer to:

- [High-efficiency, low-emission, isolated DC/DC converter-based analog input module reference design](#)
- [Isolated delta-sigma modulator based AC/DC voltage and current measurement module reference design](#)
- [Isolated power architecture reference design for communication and analog input/output modules](#)

### 11.2 Documentation Support

#### 11.2.1 Related Documentation

For related documentation see the following:

- [UCC12050 Evaluation Module User Guide](#)
- [Isolation Glossary](#)
- [A Reinforced-isolated Analog Input Chain for Space-constrained Applications](#)

### 11.3 接收文档更新通知

要接收文档更新通知，请导航至 [ti.com](https://www.ti.com) 上的器件产品文件夹。点击 [订阅更新](#) 进行注册，即可每周接收产品信息更改摘要。有关更改的详细信息，请查看任何已修订文档中包含的修订历史记录。

### 11.4 支持资源

[TI E2E™ 支持论坛](#) 是工程师的重要参考资料，可直接从专家获得快速、经过验证的解答和设计帮助。搜索现有解答或提出自己的问题可获得所需的快速设计帮助。

链接的内容由各个贡献者“按原样”提供。这些内容并不构成 TI 技术规范，并且不一定反映 TI 的观点；请参阅 TI 的 [《使用条款》](#)。

### 11.5 Trademarks

TI E2E™ is a trademark of Texas Instruments.

所有商标均为其各自所有者的财产。

### 11.6 静电放电警告



静电放电 (ESD) 会损坏这个集成电路。德州仪器 (TI) 建议通过适当的预防措施处理所有集成电路。如果不遵守正确的处理和安装程序，可能会损坏集成电路。

ESD 的损坏小至导致微小的性能降级，大至整个器件故障。精密的集成电路可能更容易受到损坏，这是因为非常细微的参数更改都可能会导致器件与其发布的规格不相符。

### 11.7 术语表

[TI 术语表](#) 本术语表列出并解释了术语、首字母缩略词和定义。

## 12 Mechanical and Packaging Information

The following pages include mechanical, packaging, and orderable information. This information is the most current data available for the designated devices. This data is subject to change without notice and revision of this document. For browser-based versions of this data sheet, refer to the left-hand navigation.

## 重要声明和免责声明

TI 提供技术和可靠性数据 (包括数据表)、设计资源 (包括参考设计)、应用或其他设计建议、网络工具、安全信息和其他资源, 不保证没有瑕疵且不做任何明示或暗示的担保, 包括但不限于对适销性、某特定用途方面的适用性或不侵犯任何第三方知识产权的暗示担保。

这些资源可供使用 TI 产品进行设计的熟练开发人员使用。您将自行承担以下全部责任: (1) 针对您的应用选择合适的 TI 产品, (2) 设计、验证并测试您的应用, (3) 确保您的应用满足相应标准以及任何其他安全、安保或其他要求。这些资源如有变更, 恕不另行通知。TI 授权您仅可将这些资源用于研发本资源所述的 TI 产品的应用。严禁对这些资源进行其他复制或展示。您无权使用任何其他 TI 知识产权或任何第三方知识产权。您应全额赔偿因在这些资源的使用中对 TI 及其代表造成的任何索赔、损害、成本、损失和债务, TI 对此概不负责。

TI 提供的产品受 TI 的销售条款 (<https://www.ti.com/legal/termsofsale.html>) 或 [ti.com](https://www.ti.com) 上其他适用条款/TI 产品随附的其他适用条款的约束。TI 提供这些资源并不会扩展或以其他方式更改 TI 针对 TI 产品发布的适用的担保或担保免责声明。

邮寄地址: Texas Instruments, Post Office Box 655303, Dallas, Texas 75265

Copyright © 2021, 德州仪器 (TI) 公司

**PACKAGING INFORMATION**

Orderable part number	Status (1)	Material type (2)	Package   Pins	Package qty   Carrier	RoHS (3)	Lead finish/ Ball material (4)	MSL rating/ Peak reflow (5)	Op temp (°C)	Part marking (6)
<a href="#">UCC12050DVE</a>	Active	Production	SO-MOD (DVE)   16	40   TUBE	Yes	NIPDAU	Level-3-260C-168 HR	-40 to 125	UCC12050
UCC12050DVE.A	Active	Production	SO-MOD (DVE)   16	40   TUBE	Yes	NIPDAU	Level-3-260C-168 HR	-40 to 125	UCC12050
<a href="#">UCC12050DVER</a>	Active	Production	SO-MOD (DVE)   16	2000   LARGE T&R	In-Work	NIPDAU	Level-3-260C-168 HR	-40 to 125	UCC12050
UCC12050DVER.A	Active	Production	SO-MOD (DVE)   16	2000   LARGE T&R	In-Work	NIPDAU	Level-3-260C-168 HR	-40 to 125	UCC12050
UCC12050DVERG4	Active	Production	SO-MOD (DVE)   16	2000   LARGE T&R	Yes	NIPDAU	Level-3-260C-168 HR	-40 to 125	UCC12050
UCC12050DVERG4.A	Active	Production	SO-MOD (DVE)   16	2000   LARGE T&R	Yes	NIPDAU	Level-3-260C-168 HR	-40 to 125	UCC12050

(1) **Status:** For more details on status, see our [product life cycle](#).

(2) **Material type:** When designated, preproduction parts are prototypes/experimental devices, and are not yet approved or released for full production. Testing and final process, including without limitation quality assurance, reliability performance testing, and/or process qualification, may not yet be complete, and this item is subject to further changes or possible discontinuation. If available for ordering, purchases will be subject to an additional waiver at checkout, and are intended for early internal evaluation purposes only. These items are sold without warranties of any kind.

(3) **RoHS values:** Yes, No, RoHS Exempt. See the [TI RoHS Statement](#) for additional information and value definition.

(4) **Lead finish/Ball material:** Parts may have multiple material finish options. Finish options are separated by a vertical ruled line. Lead finish/Ball material values may wrap to two lines if the finish value exceeds the maximum column width.

(5) **MSL rating/Peak reflow:** The moisture sensitivity level ratings and peak solder (reflow) temperatures. In the event that a part has multiple moisture sensitivity ratings, only the lowest level per JEDEC standards is shown. Refer to the shipping label for the actual reflow temperature that will be used to mount the part to the printed circuit board.

(6) **Part marking:** There may be an additional marking, which relates to the logo, the lot trace code information, or the environmental category of the part.

Multiple part markings will be inside parentheses. Only one part marking contained in parentheses and separated by a "~" will appear on a part. If a line is indented then it is a continuation of the previous line and the two combined represent the entire part marking for that device.

**Important Information and Disclaimer:**The information provided on this page represents TI's knowledge and belief as of the date that it is provided. TI bases its knowledge and belief on information provided by third parties, and makes no representation or warranty as to the accuracy of such information. Efforts are underway to better integrate information from third parties. TI has taken and continues to take reasonable steps to provide representative and accurate information but may not have conducted destructive testing or chemical analysis on incoming materials and chemicals. TI and TI suppliers consider certain information to be proprietary, and thus CAS numbers and other limited information may not be available for release.

In no event shall TI's liability arising out of such information exceed the total purchase price of the TI part(s) at issue in this document sold by TI to Customer on an annual basis.



**TAPE AND REEL INFORMATION**

**QUADRANT ASSIGNMENTS FOR PIN 1 ORIENTATION IN TAPE**



\*All dimensions are nominal

Device	Package Type	Package Drawing	Pins	SPQ	Reel Diameter (mm)	Reel Width W1 (mm)	A0 (mm)	B0 (mm)	K0 (mm)	P1 (mm)	W (mm)	Pin1 Quadrant
UCC12050DVER	SO-MOD	DVE	16	2000	330.0	16.4	10.75	10.7	2.7	12.0	16.0	Q1
UCC12050DVERG4	SO-MOD	DVE	16	2000	330.0	16.4	10.75	10.7	2.7	12.0	16.0	Q1

**TAPE AND REEL BOX DIMENSIONS**

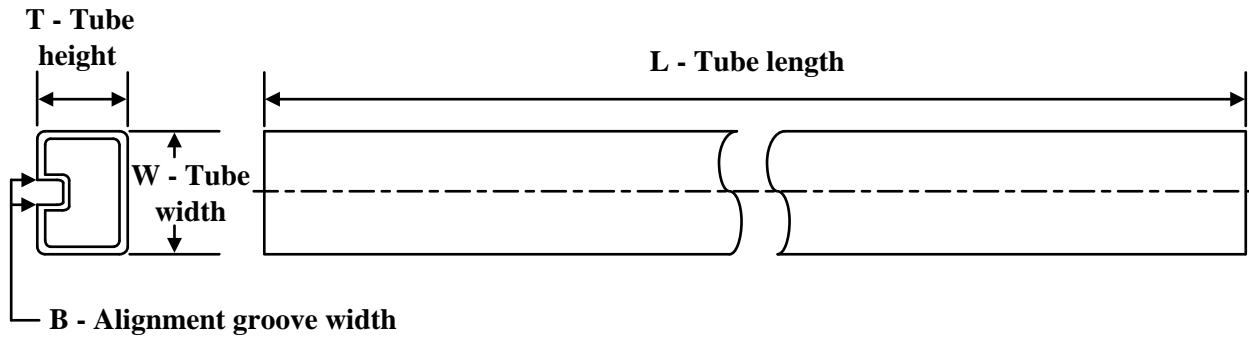

\*All dimensions are nominal

Device	Package Type	Package Drawing	Pins	SPQ	Length (mm)	Width (mm)	Height (mm)
UCC12050DVER	SO-MOD	DVE	16	2000	350.0	350.0	43.0
UCC12050DVERG4	SO-MOD	DVE	16	2000	350.0	350.0	43.0

**TUBE**

\*All dimensions are nominal

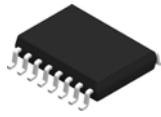
Device	Package Name	Package Type	Pins	SPQ	L (mm)	W (mm)	T (μm)	B (mm)
UCC12050DVE	DVE	SO-MOD	16	40	506.98	12.7	4826	6.6
UCC12050DVE.A	DVE	SO-MOD	16	40	506.98	12.7	4826	6.6



# PACKAGE OUTLINE

## DVE0016A

### SO-MOD - 2.65 mm max height

SMALL OUTLINE INTEGRATED CIRCUIT

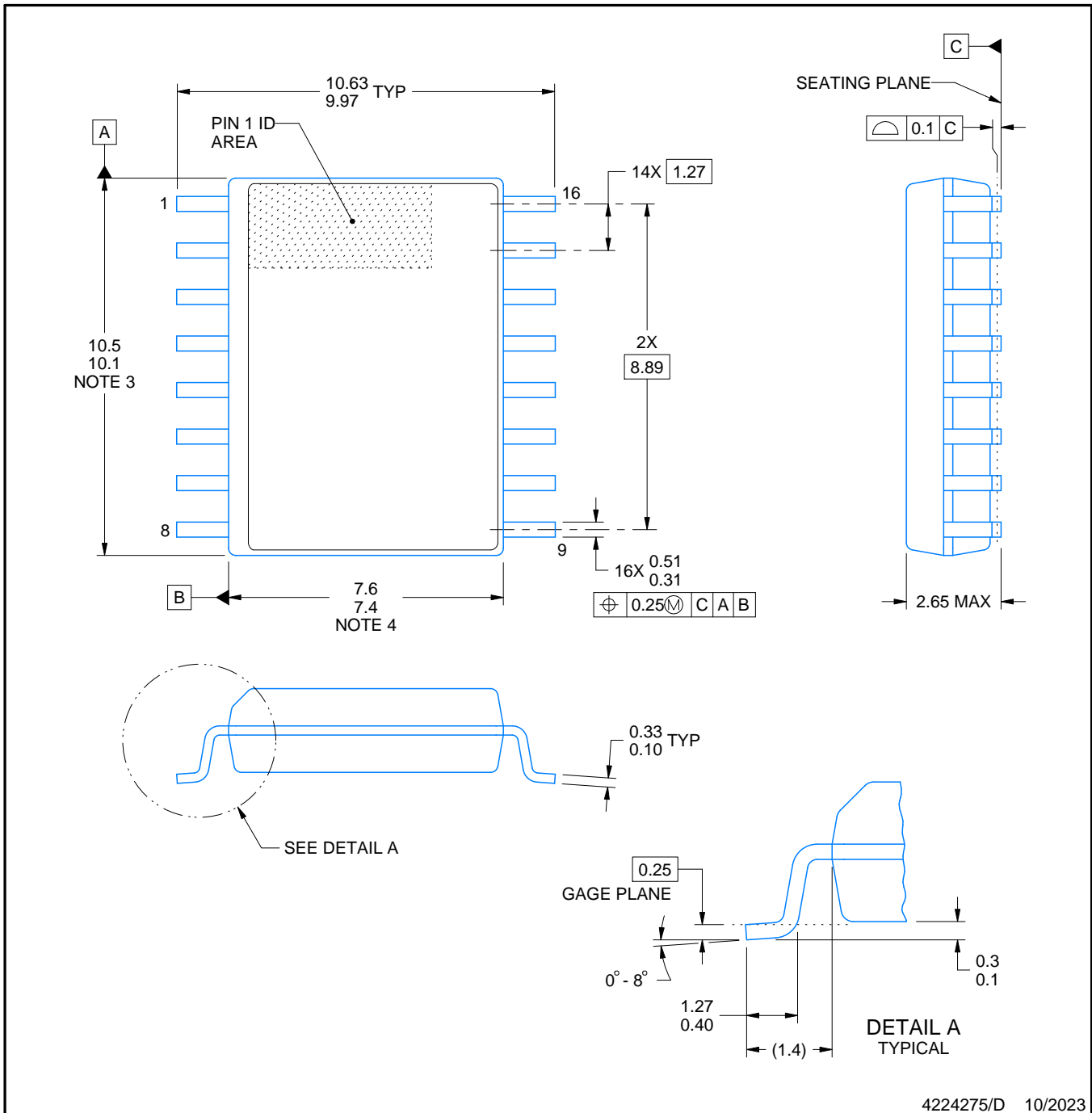

#### NOTES:

1. All linear dimensions are in millimeters. Any dimensions in parenthesis are for reference only. Dimensioning and tolerancing per ASME Y14.5M.
2. This drawing is subject to change without notice.
3. This dimension does not include mold flash, protrusions, or gate burrs. Mold flash, protrusions, or gate burrs shall not exceed 0.15 mm, per side.
4. This dimension does not include interlead flash. Interlead flash shall not exceed 0.25 mm, per side.
5. Reference JEDEC registration MS-013.

# EXAMPLE BOARD LAYOUT

DVE0016A

SO-MOD - 2.65 mm max height

SMALL OUTLINE INTEGRATED CIRCUIT

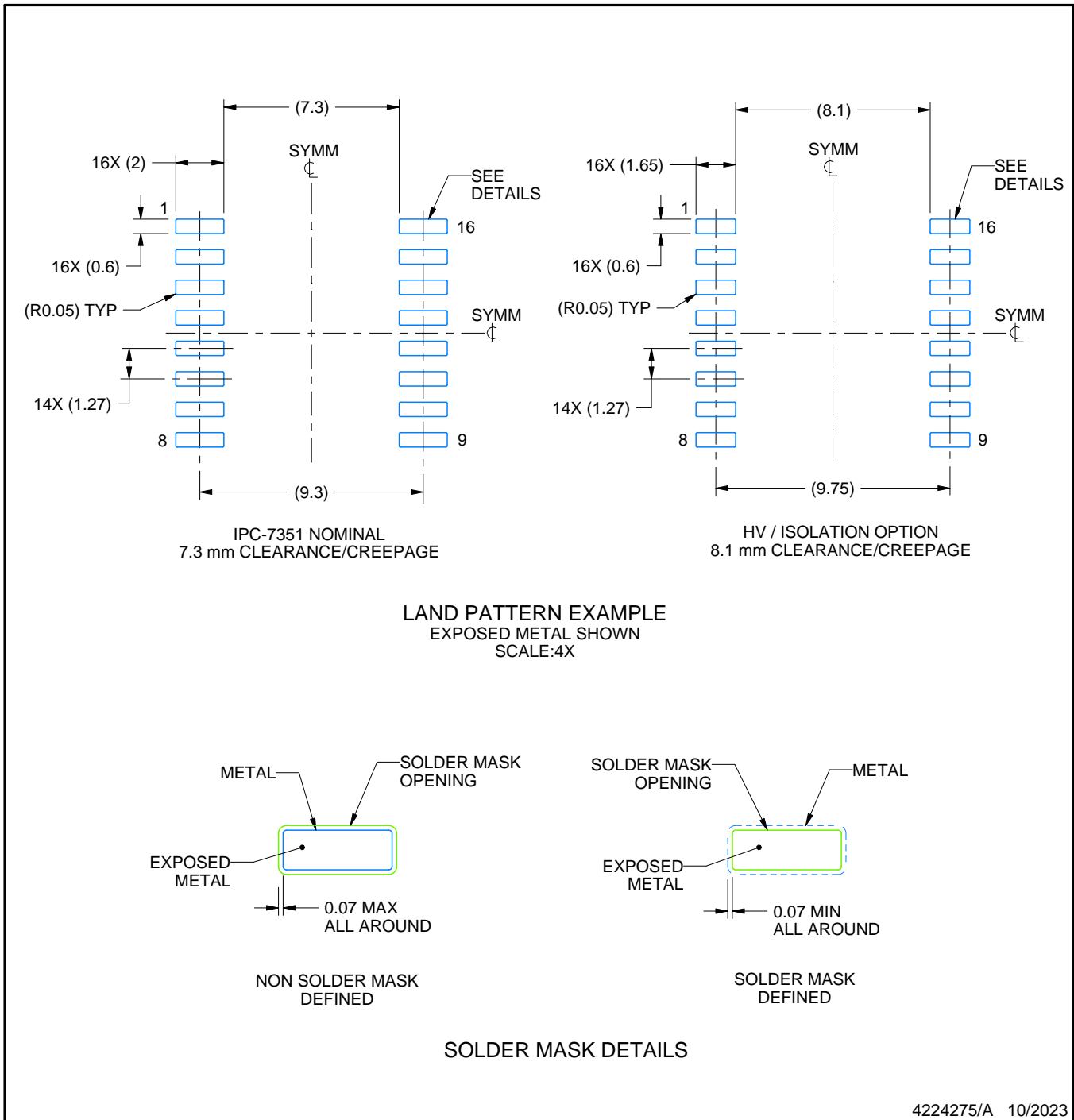

NOTES: (continued)

- 6. Publication IPC-7351 may have alternate designs.
- 7. Solder mask tolerances between and around signal pads can vary based on board fabrication site.

# EXAMPLE STENCIL DESIGN

DVE0016A

SO-MOD - 2.65 mm max height

SMALL OUTLINE INTEGRATED CIRCUIT

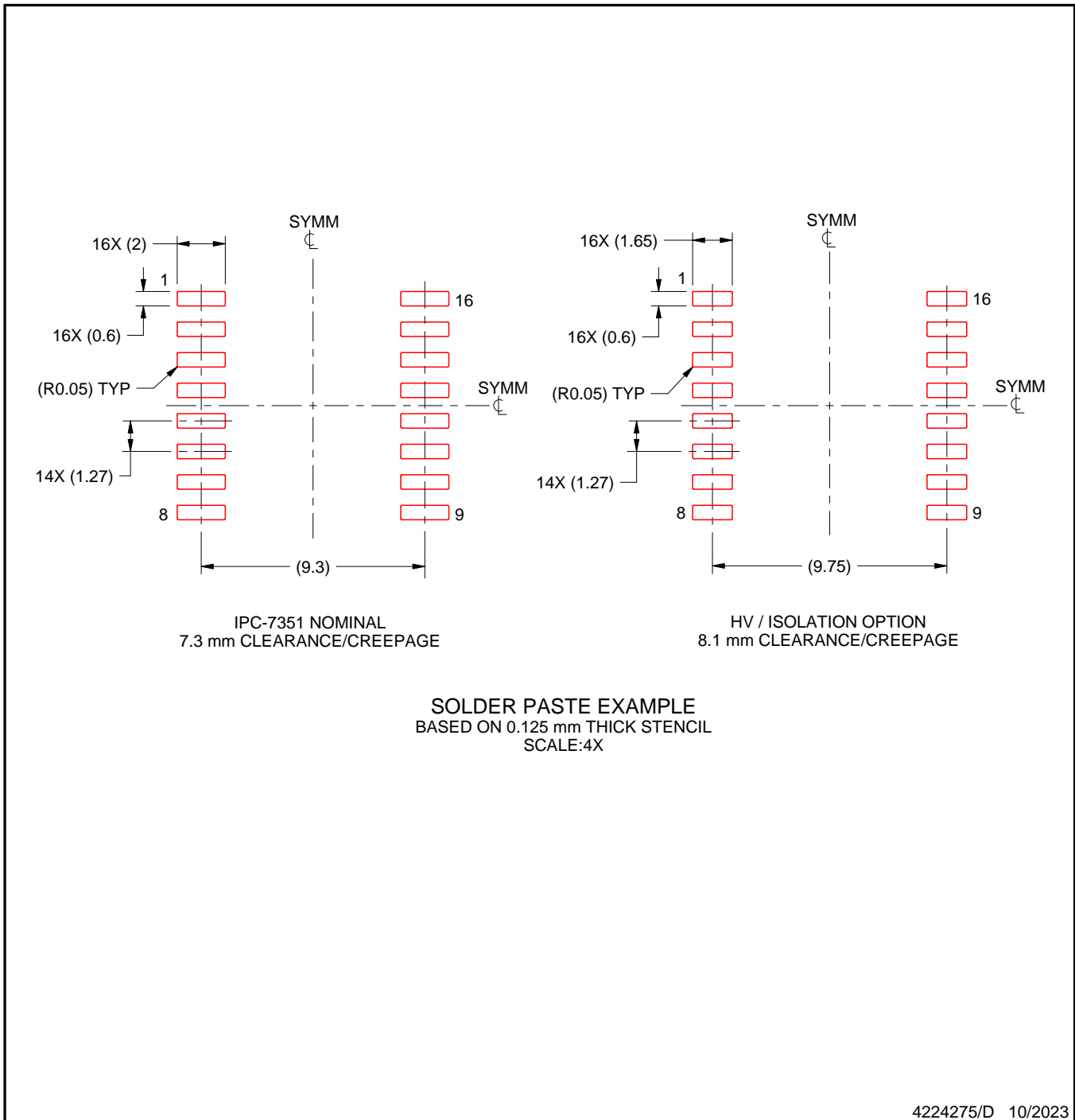

NOTES: (continued)

8. Laser cutting apertures with trapezoidal walls and rounded corners may offer better paste release. IPC-7525 may have alternate design recommendations.
9. Board assembly site may have different recommendations for stencil design.

## 重要通知和免责声明

TI“按原样”提供技术和可靠性数据（包括数据表）、设计资源（包括参考设计）、应用或其他设计建议、网络工具、安全信息和其他资源，不保证没有瑕疵且不做任何明示或暗示的担保，包括但不限于对适销性、与某特定用途的适用性或不侵犯任何第三方知识产权的暗示担保。

这些资源可供使用 TI 产品进行设计的熟练开发人员使用。您将自行承担以下全部责任：(1) 针对您的应用选择合适的 TI 产品，(2) 设计、验证并测试您的应用，(3) 确保您的应用满足相应标准以及任何其他安全、安保法规或其他要求。

这些资源如有变更，恕不另行通知。TI 授权您仅可将这些资源用于研发本资源所述的 TI 产品的相关应用。严禁以其他方式对这些资源进行复制或展示。您无权使用任何其他 TI 知识产权或任何第三方知识产权。对于因您对这些资源的使用而对 TI 及其代表造成的任何索赔、损害、成本、损失和债务，您将全额赔偿，TI 对此概不负责。

TI 提供的产品受 [TI 销售条款](#)、[TI 通用质量指南](#) 或 [ti.com](#) 上其他适用条款或 TI 产品随附的其他适用条款的约束。TI 提供这些资源并不会扩展或以其他方式更改 TI 针对 TI 产品发布的适用的担保或担保免责声明。除非德州仪器 (TI) 明确将某产品指定为定制产品或客户特定产品，否则其产品均为按确定价格收入目录的标准通用器件。

TI 反对并拒绝您可能提出的任何其他或不同的条款。

版权所有 © 2026，德州仪器 (TI) 公司

最后更新日期：2025 年 10 月