

## UA78M 500mA 正电压线性稳压器

### 1 特性

- 输入电压范围 ( $V_{IN}$ ) : 5.3V 至 30V
- 绝对最大输入电压 :
  - 旧芯片 : 35V
  - 新芯片 : 45V
- 固定输出电压范围 ( $V_{OUT}$ ) : 3.3V 至 12V
- 输出电流 ( $I_{OUT}$ ) : 高达 500mA
- 静态电流  $I_Q$  : 4.5mA
- 内置短路电流限制和热保护
- 无需任何外部元件即可保持稳定
- 工作结温范围 :
  - 旧芯片 C 版本 :  $0^{\circ}\text{C}$  至  $+125^{\circ}\text{C}$
  - 旧芯片 I 版本 :  $-40^{\circ}\text{C}$  至  $+125^{\circ}\text{C}$
  - 新芯片 :  $-40^{\circ}\text{C}$  至  $+125^{\circ}\text{C}$

### 2 应用

- 板载充电
- 洗衣机和烘干机
- 住宅照明
- 电池备份单元 (BBU)
- 空调室外机

### 3 说明

UA78M 固定电压集成电路稳压器适用于各种应用。UA78M 可用于板级稳压, 以减弱与单点稳压相关的后稳压噪声和分布问题。UA78M 能够提供高达 500mA 的输出电流。此外, UA78M 无需外部元件即可在整个负载电流范围内稳定运行。该稳压器的内部电流限制和热关断功能可避免器件发生过载。

UA78M 的额定结温范围为  $-40^{\circ}\text{C}$  至  $+125^{\circ}\text{C}$ 。本文将通篇说明新芯片和旧芯片的器件性能。有关更多详细信息, 请参阅 [器件命名规则](#) 表。

#### 封装信息

器件型号	封装 <sup>(1)</sup>	封装尺寸 <sup>(2)</sup>
UA78M	DCY ( SOT-223 , 3 )	6.5mm × 7mm
	KVU ( TO-252 , 3 )	6.6mm × 10.11mm

- (1) 如需更多信息, 请参阅 [机械、封装和可订购信息](#)。  
 (2) 封装尺寸 (长 × 宽) 为标称值, 并包括引脚 (如适用)。

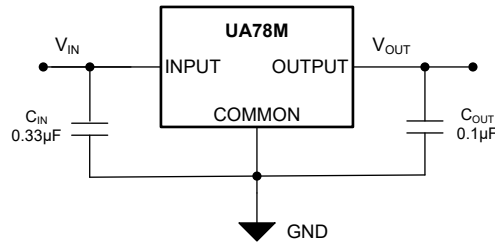

简化版原理图



## Table of Contents

<b>1 特性</b> .....	1	5.12 Typical Characteristics.....	11
<b>2 应用</b> .....	1	<b>6 Detailed Description</b> .....	13
<b>3 说明</b> .....	1	6.1 Overview.....	13
<b>4 Pin Configuration and Functions</b> .....	3	6.2 Functional Block Diagram.....	13
<b>5 Specifications</b> .....	4	6.3 Feature Description.....	13
5.1 Absolute Maximum Ratings.....	4	6.4 Device Functional Modes.....	15
5.2 ESD Ratings.....	4	<b>7 Application and Implementation</b> .....	16
5.3 Recommended Operating Conditions.....	4	7.1 Application Information.....	16
5.4 Thermal Information.....	5	7.2 Typical Application.....	16
5.5 Electrical Characteristics: UA78M33 (Both Legacy and New Chip).....	5	7.3 System Examples.....	21
5.6 Electrical Characteristics: UA78M05 (Both Legacy and New Chip).....	6	7.4 Power Supply Recommendations.....	21
5.7 Electrical Characteristics: UA78M06C (Legacy Chip Only).....	6	7.5 Layout.....	21
5.8 Electrical Characteristics: UA78M08C (Legacy Chip Only).....	7	<b>8 Device and Documentation Support</b> .....	23
5.9 Electrical Characteristics: UA78M09 (Both Legacy and New Chip).....	7	8.1 Device Support.....	23
5.10 Electrical Characteristics: UA78M10 (Both Legacy and New Chip).....	8	8.2 接收文档更新通知.....	23
5.11 Electrical Characteristics: UA78M12 (Both Legacy and New Chip).....	9	8.3 支持资源.....	23
		8.4 Trademarks.....	23
		8.5 静电放电警告.....	23
		8.6 术语表.....	23
		<b>9 Revision History</b> .....	24
		<b>10 Mechanical, Packaging, and Orderable Information</b> .....	24

## 4 Pin Configuration and Functions



图 4-1. DCY Package, 3-Pin SOT-223 (Top View)



图 4-2. KVU Package, 3-Pin TO-252 (Top View)

表 4-1. Pin Functions

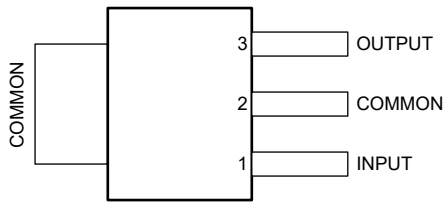
PIN		TYPE	DESCRIPTION
NAME	NO.		
COMMON	2	—	Ground
INPUT	1	I	Input pin. Use the recommended capacitor value as listed in the <a href="#">Recommended Operating Conditions</a> table. Place the input capacitor as close to the INPUT and COMMON pins of the device as possible.
OUTPUT	3	O	Output pin. Use the recommended capacitor value as listed in the <a href="#">Recommended Operating Conditions</a> table. Place the output capacitor as close to the OUTPUT and COMMON pins of the device as possible.

## 5 Specifications

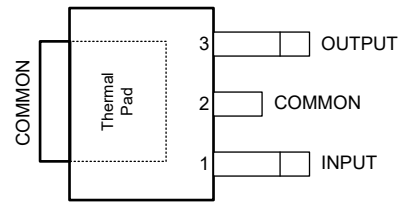
### 5.1 Absolute Maximum Ratings

over operating temperature range (unless otherwise noted)<sup>(1)</sup>

		MIN	MAX	UNIT
Input voltage, $V_I$ (for Legacy Chip)	UA78M33C, UA78M33I, UA78M05C, UA78M05I, UA78M06C, UA78M08C, UA78M09C, UA78M10C, UA78M12C		35	V
Input voltage, $V_I$ (for New Chip)	UA78M33C, UA78M33I, UA78M05C, UA78M05I, UA78M09C, UA78M10C, UA78M12C		45	V
Output voltage, $V_O$ (for New Chip)		-0.3	12	V
Junction temperature, $T_J$			150	°C
Storage temperature, $T_{stg}$		- 65	150	°C

(1) Stresses beyond those listed under *Absolute Maximum Ratings* may cause permanent damage to the device. These are stress ratings only, and functional operation of the device at these or any other conditions beyond those indicated under *Recommended Operating Conditions* is not implied. Exposure to absolute-maximum-rated conditions for extended periods may affect device reliability.

### 5.2 ESD Ratings

		VALUE	UNIT
$V_{(ESD)}$	Electrostatic discharge	Human body model (HBM), per ANSI/ESDA/JEDEC JS-001, all pins <sup>(1)</sup>	2500
		Charged device model (CDM), per JEDEC specification JESD22-C101, all pins <sup>(2)</sup>	2000

(1) JEDEC document JEP155 states that 500-V HBM allows safe manufacturing with a standard ESD control process.

(2) JEDEC document JEP157 states that 250-V CDM allows safe manufacturing with a standard ESD control process.

### 5.3 Recommended Operating Conditions

over operating free-air temperature range (unless otherwise noted)<sup>(1)</sup>

		MIN	TYP	MAX	UNIT
VIN	Input voltage	UA78M33C, UA78M33I (Legacy chip)	5.3		25
		UA78M33C, UA78M33I (New chip)	5.3		30
		UA78M05C, UA78M05I (Legacy chip)	7		25
		UA78M05C, UA78M05I (New chip)	7		30
		UA78M06 (Legacy chip)	8		25
		UA78M08 (Legacy chip)	10.5		25
		UA78M09 (Legacy chip)	11.5		26
		UA78M09 (New chip)	11.5		30
		UA78M10 (Legacy chip)	12.5		28
		UA78M10 (New chip)	12.5		30
		UA78M12 (Legacy chip)	14.5		30
		UA78M12 (New chip)	14.5		30
$C_{IN}$ <sup>(2)</sup>	Input capacitor <sup>(3)</sup>		0.33		μF
$C_{OUT}$ <sup>(2)</sup>	Output capacitor <sup>(4)</sup>		0.1	470	μF
$I_O$	Output current			500	mA
$T_J$	Operating junction temperature	UA78MxxC (Legacy chip)	0		125
		UA78MxxI (Legacy chip)	- 40		125
		UA78MxxC, UA78MxxI (New chip)	- 40		125

(1) All voltages are with respect to GND.

(2) UA78M regulator does not need any external capacitors for LDO stability.

(3) An input capacitor with value of 0.33 μF is recommended to counteract the effect of source resistance and inductance, which can in some cases cause symptoms of system level instability such as ringing or oscillation, especially in the presence of load transients.

(4) An output capacitor with value of 0.1 μF is recommended to improve the load and line transient performance of the UA78M regulator. The maximum output capacitor is guaranteed by design

## 5.4 Thermal Information

THERMAL METRIC <sup>(1)</sup>		UA78Mxx	UA78Mxx	UA78Mxx	UA78Mxx	UA78Mxx	UNIT
		DCY (Legacy Chip)	DCY (New Chip)	KCS (Legacy Chip only)	KVU (Legacy chip)	KVU (New chip)	
		3 PINS	3 PINS	3 PINS	3 PINS	3 PINS	
R <sub>θJA</sub>	Junction-to-ambient thermal resistance	53	77.7	19	30.2	32.1	°C/W
R <sub>θJC(top)</sub>	Junction-to-case (top) thermal resistance	30.6	44.6	17	-	40	°C/W
R <sub>θJC(bot)</sub>	Junction-to-case (bottom) thermal resistance	-	-	3	-	3.3	°C/W

(1) For more information about traditional and new thermal metrics, see the [Semiconductor and IC Package Thermal Metrics](#) application note.

## 5.5 Electrical Characteristics: UA78M33 (Both Legacy and New Chip)

specified at T<sub>J</sub> = 25°C, V<sub>I</sub> = 8 V, C<sub>IN</sub> = 0.33 μF, C<sub>OUT</sub> = 0.1 μF, and I<sub>O</sub> = 350 mA (unless otherwise noted)

PARAMETER	TEST CONDITIONS <sup>(1)</sup>		MIN	TYP	MAX	UNIT
Output voltage	V <sub>I</sub> = 8V to 20V, and I <sub>O</sub> = 5mA to 350mA	Legacy chip and new chip	3.2	3.3	3.4	V
		T <sub>J</sub> = full range Legacy chip	3.1	3.3	3.5	
		T <sub>J</sub> = -40°C to 125°C New chip	3.1	3.3	3.5	
Output voltage line regulation	I <sub>O</sub> = 200mA, V <sub>IN</sub> = 5.3V to 25V	Legacy chip		9	100	mV
		New chip		28	50	
	I <sub>O</sub> = 200mA, V <sub>IN</sub> = 8V to 25V	Legacy chip		3	50	
		New chip		9	20	
Ripple rejection	V <sub>I</sub> = 8V to 18V, f = 120Hz	I <sub>O</sub> = 100mA, T <sub>J</sub> = full range Legacy chip		62		dB
		I <sub>O</sub> = 100mA, T <sub>J</sub> = -40°C to 125°C New chip		57		
		I <sub>O</sub> = 300mA	Legacy chip	62	80	
			New chip	56	62	
Output voltage load regulation	V <sub>I</sub> = 8V and I <sub>O</sub> = 5mA to 500mA	Legacy chip		20	100	mV
		New chip		20	40	
Temperature coefficient of output voltage	I <sub>O</sub> = 5mA	T <sub>J</sub> = full range Legacy chip		-1		mV/°C
		T <sub>J</sub> = -40°C to 125°C New chip		-1		
Output noise voltage	f = 10 Hz to 100 KHz	Legacy chip		40	200	μV <sub>rms</sub>
		New chip		80	200	
Dropout voltage		Legacy chip and new chip		2.0		V
Bias current		Legacy chip		4.5	6	mA
		New chip		3.5	4.5	
Bias current change	V <sub>I</sub> = 8V to 25V, I <sub>O</sub> = 200mA	T <sub>J</sub> = full range Legacy chip			0.8	mA
		T <sub>J</sub> = -40°C to 125°C New chip			0.8	
	I <sub>O</sub> = 5 mA to 350mA	T <sub>J</sub> = full range Legacy chip			0.5	
		T <sub>J</sub> = -40°C to 125°C New chip			0.5	
Short-circuit output current	V <sub>I</sub> = 35V	Legacy chip		300		mA
	V <sub>I</sub> = 30V	New chip		400		
Peak output current		Legacy chip		700		mA
		New chip		735		

(1) Pulse-testing techniques maintain T<sub>J</sub> as close to T<sub>A</sub> as possible. Thermal effects must be taken into account separately.

### 5.6 Electrical Characteristics: UA78M05 (Both Legacy and New Chip)

specified at  $T_J = 25^\circ\text{C}$ ,  $V_I = 10\text{V}$ ,  $C_{IN} = 0.33\ \mu\text{F}$ ,  $C_{OUT} = 0.1\ \mu\text{F}$ , and  $I_O = 350\text{mA}$  (unless otherwise noted)

PARAMETER	TEST CONDITIONS <sup>(1)</sup>		MIN	TYP	MAX	UNIT	
Output voltage	$V_I = 7\text{V to } 20\text{V}$ , and $I_O = 5\text{mA to } 350\text{mA}$	Legacy chip and new chip	4.8	5	5.2	V	
		$T_J = \text{full range}$ Legacy chip	4.75		5.25		
	$V_I = 7.2\text{V to } 20\text{V}$ , and $I_O = 5\text{mA to } 350\text{mA}$	$T_J = -40^\circ\text{C to } 125^\circ\text{C}$ New chip	4.75		5.25		
Output voltage line regulation	$I_O = 200\text{mA}$ , $V_{IN} = 7\text{V to } 25\text{V}$	Legacy chip		3	100	mV	
		New chip		13	30		
	$I_O = 200\text{mA}$ , $V_{IN} = 8\text{V to } 25\text{V}$	Legacy chip		1	50		
		New chip		13	30		
Ripple rejection	$V_I = 8\text{V to } 18\text{V}$ , $f = 120\text{Hz}$	$I_O = 100\text{mA}$ , $T_J = \text{full range}$ Legacy chip	62			dB	
		$I_O = 100\text{mA}$ , $T_J = -40^\circ\text{C to } 125^\circ\text{C}$ New chip	56				
		$I_O = 300\text{mA}$	Legacy chip	62	80		
			New chip	52	58		
Output voltage load regulation	$I_O = 5\text{mA to } 500\text{mA}$	Legacy chip		20	100	mV	
		New chip		25	60		
	$I_O = 5\text{mA to } 200\text{mA}$	Legacy chip		10	50		
		New chip		5	20		
Temperature coefficient of output voltage	$I_O = 5\text{mA}$	$T_J = \text{full range}$ Legacy chip	-1			mV/ $^\circ\text{C}$	
		$T_J = -40^\circ\text{C to } 125^\circ\text{C}$ New chip	-1				
Output noise voltage	$f = 10\ \text{Hz to } 100\ \text{kHz}$	Legacy chip		40	200	$\mu\text{V}_{\text{rms}}$	
		New chip		120	200		
Dropout voltage		Legacy chip and new chip		2.0		V	
Bias current		Legacy chip		4.5	6	mA	
		New chip	3.5	4.5	6		
Bias current change	$V_I = 8\text{V to } 25\text{V}$ , $I_O = 200\text{mA}$	$T_J = \text{full range}$ Legacy chip			0.8	mA	
		$T_J = -40^\circ\text{C to } 125^\circ\text{C}$ New chip			0.8		
	$I_O = 5\ \text{mA to } 350\text{mA}$	$T_J = \text{full range}$ Legacy chip			0.5		
		$T_J = -40^\circ\text{C to } 125^\circ\text{C}$ New chip			0.5		
Short-circuit output current	$V_I = 35\text{V}$	Legacy chip		300		mA	
	$V_I = 30\text{V}$	New chip		400			
Peak output current		Legacy chip		700		mA	
		New chip		760			

(1) Pulse-testing techniques maintain  $T_J$  as close to  $T_A$  as possible. Thermal effects must be taken into account separately.

### 5.7 Electrical Characteristics: UA78M06C (Legacy Chip Only)

specified at  $T_J = 25^\circ\text{C}$ ,  $V_I = 11\text{V}$ ,  $C_{IN} = 0.33\ \mu\text{F}$ ,  $C_{OUT} = 0.1\ \mu\text{F}$ , and  $I_O = 350\text{mA}$  (unless otherwise noted)

PARAMETER	TEST CONDITIONS <sup>(1)</sup>		MIN	TYP	MAX	UNIT
Output voltage	$V_I = 8\text{V to } 21\text{V}$ , and $I_O = 5\text{mA to } 350\text{mA}$		5.75	6	6.25	V
		$T_J = 0^\circ\text{C to } 125^\circ\text{C}$	5.7		6.3	
Output voltage line regulation	$I_O = 200\text{mA}$ , $V_{IN} = 8\text{V to } 25\text{V}$			5	100	mV
	$I_O = 200\text{mA}$ , $V_{IN} = 9\text{V to } 25\text{V}$			1.5	50	
Ripple rejection	$V_I = 8\text{V to } 18\text{V}$ , $f = 120\text{Hz}$	$I_O = 100\text{mA}$ , $T_J = 0^\circ\text{C to } 125^\circ\text{C}$	59			dB
		$I_O = 300\text{mA}$	59	80		

### 5.7 Electrical Characteristics: UA78M06C (Legacy Chip Only) (续)

specified at  $T_J = 25^\circ\text{C}$ ,  $V_I = 11\text{V}$ ,  $C_{IN} = 0.33\ \mu\text{F}$ ,  $C_{OUT} = 0.1\ \mu\text{F}$ , and  $I_O = 350\text{mA}$  (unless otherwise noted)

PARAMETER	TEST CONDITIONS <sup>(1)</sup>		MIN	TYP	MAX	UNIT
Output voltage load regulation	$I_O = 5\text{mA to } 500\text{mA}$			20	120	mV
	$I_O = 5\text{mA to } 200\text{mA}$			10	60	
Temperature coefficient of output voltage	$I_O = 5\text{mA}$	$T_J = 0^\circ\text{C to } 125^\circ\text{C}$		- 1		mV/ $^\circ\text{C}$
Output noise voltage	$f = 10\ \text{Hz to } 100\ \text{kHz}$ ,			45		$\mu\text{V}_{\text{rms}}$
Dropout voltage				2.0		V
Bias current			3.5	4.5	6	mA
Bias current change	$V_I = 9\text{V to } 25\text{V}$ , $I_O = 200\text{mA}$	$T_J = 0^\circ\text{C to } 125^\circ\text{C}$			0.8	mA
	$I_O = 5\ \text{mA to } 350\text{mA}$	$T_J = 0^\circ\text{C to } 125^\circ\text{C}$			0.5	
Short-circuit output current	$V_I = 35\text{V}$	$V_I = 35\text{V}$		270		mA
Peak output current				700		mA

(1) Pulse-testing techniques maintain  $T_J$  as close to  $T_A$  as possible. Thermal effects must be taken into account separately.

### 5.8 Electrical Characteristics: UA78M08C (Legacy Chip Only)

specified at  $T_J = 25^\circ\text{C}$ ,  $V_I = 14\text{V}$ ,  $C_{IN} = 0.33\ \mu\text{F}$ ,  $C_{OUT} = 0.1\ \mu\text{F}$ , and  $I_O = 350\text{mA}$  (unless otherwise noted)

PARAMETER	TEST CONDITIONS <sup>(1)</sup>		MIN	TYP	MAX	UNIT
Output voltage	$V_I = 10.5\text{V to } 23\text{V}$ , and $I_O = 5\text{mA to } 350\text{mA}$		7.7	8	8.3	V
	$T_J = 0^\circ\text{C to } 125^\circ\text{C}$		7.6		8.4	
Output voltage line regulation	$I_O = 200\text{mA}$ , $V_{IN} = 10.5\text{V to } 25\text{V}$			6	100	mV
	$I_O = 200\text{mA}$ , $V_{IN} = 11\text{V to } 25\text{V}$			2	50	
Ripple rejection	$V_I = 11\text{V to } 21.5\text{V}$ , $f = 120\text{Hz}$	$I_O = 100\text{mA}$ , $T_J = 0^\circ\text{C to } 125^\circ\text{C}$	56			dB
		$I_O = 300\text{mA}$	56	80		
Output voltage load regulation	$I_O = 5\text{mA to } 500\text{mA}$			25	160	mV
	$I_O = 5\text{mA to } 200\text{mA}$			10	80	
Temperature coefficient of output voltage	$I_O = 5\text{mA}$	$T_J = 0^\circ\text{C to } 125^\circ\text{C}$		- 1		mV/ $^\circ\text{C}$
Output noise voltage	$f = 10\ \text{Hz to } 100\ \text{kHz}$ ,			52		$\mu\text{V}_{\text{rms}}$
Dropout voltage				2.0		V
Bias current				4.5	6	mA
Bias current change	$V_I = 9\text{V to } 25\text{V}$ , $I_O = 200\text{mA}$	$T_J = 0^\circ\text{C to } 125^\circ\text{C}$			0.8	mA
	$I_O = 5\ \text{mA to } 350\text{mA}$	$T_J = 0^\circ\text{C to } 125^\circ\text{C}$			0.5	
Short-circuit output current	$V_I = 35\text{V}$			250		mA
Peak output current				700		mA

(1) Pulse-testing techniques maintain  $T_J$  as close to  $T_A$  as possible. Thermal effects must be taken into account separately.

### 5.9 Electrical Characteristics: UA78M09 (Both Legacy and New Chip)

at specified junction temperature,  $V_I = 16\ \text{V}$ ,  $C_{IN} = 0.33\ \mu\text{F}$ ,  $C_{OUT} = 0.1\ \mu\text{F}$ , and  $I_O = 350\ \text{mA}$  (unless otherwise noted)

PARAMETER	TEST CONDITIONS <sup>(1)</sup>		MIN	TYP	MAX	UNIT
Output voltage	$V_I = 11.5\text{V to } 24\text{V}$ , and $I_O = 5\text{mA to } 350\text{mA}$		8.6	9	9.4	V
		$T_J = 0^\circ\text{C to } 125^\circ\text{C}$			9.5	
Output voltage line regulation	$I_O = 200\text{mA}$ , $V_{IN} = 11.5\text{V to } 26\text{V}$	Legacy chip		6	100	mV
		New chip		6	30	
	$I_O = 200\text{mA}$ , $V_{IN} = 12\text{V to } 26\text{V}$	Legacy chip		2	50	
		New chip		2	25	

### 5.9 Electrical Characteristics: UA78M09 (Both Legacy and New Chip) (续)

at specified junction temperature,  $V_I = 16\text{ V}$ ,  $C_{IN} = 0.33\ \mu\text{F}$ ,  $C_{OUT} = 0.1\ \mu\text{F}$ , and  $I_O = 350\text{ mA}$  (unless otherwise noted)

PARAMETER	TEST CONDITIONS <sup>(1)</sup>		MIN	TYP	MAX	UNIT	
Ripple rejection	$V_I = 13\text{V to }23\text{V}$ , $f = 120\text{Hz}$	$I_O = 100\text{mA}$ , $T_J = 0^\circ\text{C to }125^\circ\text{C}$	Legacy chip	56		dB	
			New chip	48			
		$I_O = 300\text{mA}$	Legacy chip	56	80		
			New chip	48	80		
Output voltage load regulation	$I_O = 5\text{mA to }500\text{mA}$	Legacy chip	25		180	mV	
		New chip	25		90		
	$I_O = 5\text{mA to }200\text{mA}$	Legacy chip	10		90		
		New chip	10		45		
Output noise voltage	$f = 10\text{ Hz to }100\text{ kHz}$	Legacy chip	58		$\mu\text{V}_{\text{rms}}$		
		New chip	230				
Temperature coefficient of output voltage	$I_O = 5\text{mA}$	$T_J = 0^\circ\text{C to }125^\circ\text{C}$	Legacy chip and new chip		-1	$\text{mV}/^\circ\text{C}$	
Dropout voltage			Legacy chip and new chip		2.0	V	
Bias current			Legacy chip and new chip		4.6	6	mA
Bias current change	$V_I = 11.5\text{V to }26\text{V}$ , $I_O = 200\text{mA}$	$T_J = 0^\circ\text{C to }125^\circ\text{C}$	Legacy chip and new chip		0.8		mA
	$I_O = 5\text{ mA to }350\text{mA}$	$T_J = 0^\circ\text{C to }125^\circ\text{C}$	Legacy chip and new chip		0.5		
Short-circuit output current	$V_I = 35\text{V}$		Legacy chip		250		mA
	$V_I = 30\text{V}$		New chip		400		
Peak output current			Legacy chip		700		mA
			New chip		760		

(1) Pulse-testing techniques maintain  $T_J$  as close to  $T_A$  as possible. Thermal effects must be taken into account separately.

### 5.10 Electrical Characteristics: UA78M10 (Both Legacy and New Chip)

at specified junction temperature,  $V_I = 17\text{ V}$ ,  $C_{IN} = 0.33\ \mu\text{F}$ ,  $C_{OUT} = 0.1\ \mu\text{F}$ , and  $I_O = 350\text{ mA}$  (unless otherwise noted)

PARAMETER	TEST CONDITIONS <sup>(1)</sup>		MIN	TYP	MAX	UNIT
Output voltage	$V_I = 12.5\text{V to }25\text{V}$ , and $I_O = 5\text{mA to }350\text{mA}$		9.6	10	10.4	V
		$T_J = 0^\circ\text{C to }125^\circ\text{C}$	9.5		10.5	
Output voltage line regulation	$I_O = 200\text{mA}$ , $V_{IN} = 12.5\text{V to }28\text{V}$	Legacy chip	7		100	mV
		New chip	7		35	
	$I_O = 200\text{mA}$ , $V_{IN} = 14\text{V to }28\text{V}$	Legacy chip	2		50	
		New chip	2		30	
Ripple rejection	$V_I = 15\text{V to }25\text{V}$ , $f = 120\text{Hz}$	$I_O = 100\text{mA}$ , $T_J = 0^\circ\text{C to }125^\circ\text{C}$	Legacy chip	59		dB
			New chip	45		
		$I_O = 300\text{mA}$	Legacy chip	55	80	
			New chip	45	80	
Output voltage load regulation	$I_O = 5\text{mA to }500\text{mA}$	Legacy chip	25		200	mV
		New chip	25		120	
	$I_O = 5\text{mA to }200\text{mA}$	Legacy chip	10		100	
		New chip	10		50	
Output noise voltage	$f = 10\text{ Hz to }100\text{ kHz}$	Legacy chip	64		$\mu\text{V}_{\text{rms}}$	
		New chip	255			

### 5.10 Electrical Characteristics: UA78M10 (Both Legacy and New Chip) (续)

at specified junction temperature,  $V_I = 17\text{ V}$ ,  $C_{IN} = 0.33\ \mu\text{F}$ ,  $C_{OUT} = 0.1\ \mu\text{F}$ , and  $I_O = 350\text{ mA}$  (unless otherwise noted)

PARAMETER	TEST CONDITIONS <sup>(1)</sup>			MIN	TYP	MAX	UNIT
Temperature coefficient of output voltage	$I_O = 5\text{ mA}$	$T_J = 0^\circ\text{C to } 125^\circ\text{C}$	Legacy chip and new chip		-1		mV/°C
Dropout voltage			Legacy chip and new chip		2.0		V
Bias current			Legacy chip and new chip		4.7	6	mA
Bias current change	$V_I = 12.5\text{ V to } 28\text{ V}$ , $I_O = 200\text{ mA}$	$T_J = 0^\circ\text{C to } 125^\circ\text{C}$	Legacy chip and new chip			0.8	mA
	$I_O = 5\text{ mA to } 350\text{ mA}$	$T_J = 0^\circ\text{C to } 125^\circ\text{C}$	Legacy chip and new chip			0.5	
Short-circuit output current	$V_I = 35\text{ V}$		Legacy chip		245		mA
	$V_I = 30\text{ V}$		New chip		400		
Peak output current			Legacy chip		700		mA
			New chip		760		

(1) Pulse-testing techniques maintain  $T_J$  as close to  $T_A$  as possible. Thermal effects must be taken into account separately.

### 5.11 Electrical Characteristics: UA78M12 (Both Legacy and New Chip)

at specified at  $T_J = 25^\circ\text{C}$ ,  $V_I = 19\text{ V}$ ,  $C_{IN} = 0.33\ \mu\text{F}$ ,  $C_{OUT} = 0.1\ \mu\text{F}$  and  $I_O = 350\text{ mA}$  (unless otherwise noted)

PARAMETER	TEST CONDITIONS <sup>(1)</sup>			MIN	TYP	MAX	UNIT
Output voltage	$V_I = 14.5\text{ V to } 27\text{ V}$ , and $I_O = 5\text{ mA to } 350\text{ mA}$		Legacy chip and new chip	11.5	12	12.5	V
		$T_J = 0^\circ\text{C to } 125^\circ\text{C}$			11.4		
Output voltage line regulation	$I_O = 200\text{ mA}$ , $V_{IN} = 14.5\text{ V to } 30\text{ V}$		Legacy chip		8	100	mV
			New chip		8	40	
	$I_O = 200\text{ mA}$ , $V_{IN} = 16\text{ V to } 30\text{ V}$		Legacy chip		2	50	
			New chip		2	35	
Ripple rejection	$V_I = 15\text{ V to } 25\text{ V}$ , $f = 120\text{ Hz}$	$I_O = 100\text{ mA}$ , $T_J = 0^\circ\text{C to } 125^\circ\text{C}$	Legacy chip		55		dB
			New chip		42		
		$I_O = 300\text{ mA}$	Legacy chip		55	80	
			New chip		42	80	
Output voltage load regulation	$I_O = 5\text{ mA to } 500\text{ mA}$		Legacy chip		25	240	mV
			New chip		25	120	
	$I_O = 5\text{ mA to } 200\text{ mA}$		Legacy chip		10	120	
			New chip		10	60	
Temperature coefficient of output voltage	$I_O = 5\text{ mA}$	$T_J = 0^\circ\text{C to } 125^\circ\text{C}$	Legacy chip and new chip		-1		mV/°C
Output noise voltage	$f = 10\text{ Hz to } 100\text{ kHz}$		Legacy chip		75		$\mu\text{V}_{\text{rms}}$
			New chip		300		
Dropout voltage			Legacy chip and new chip		2.0		V
Bias current			Legacy chip and new chip		4.8	6	mA
Bias current change	$V_I = 14.5\text{ V to } 30\text{ V}$ , $I_O = 200\text{ mA}$	$T_J = 0^\circ\text{C to } 125^\circ\text{C}$	Legacy chip and new chip			0.8	mA
	$I_O = 5\text{ mA to } 350\text{ mA}$		Legacy chip and new chip			0.5	
Short-circuit output current	$V_I = 35\text{ V}$		Legacy chip		240		mA
	$V_I = 30\text{ V}$		New chip		400		

### 5.11 Electrical Characteristics: UA78M12 (Both Legacy and New Chip) (续)

at specified at  $T_J = 25^\circ\text{C}$ ,  $V_I = 19\text{V}$ ,  $C_{IN} = 0.33\mu\text{F}$ ,  $C_{OUT} = 0.1\mu\text{F}$  and  $I_O = 350\text{mA}$  (unless otherwise noted)

PARAMETER	TEST CONDITIONS <sup>(1)</sup>		MIN	TYP	MAX	UNIT
Peak output current		Legacy chip		700		mA
Peak output current		New chip		760		

(1) Pulse-testing techniques maintain  $T_J$  as close to  $T_A$  as possible. Thermal effects must be taken into account separately.

### 5.12 Typical Characteristics

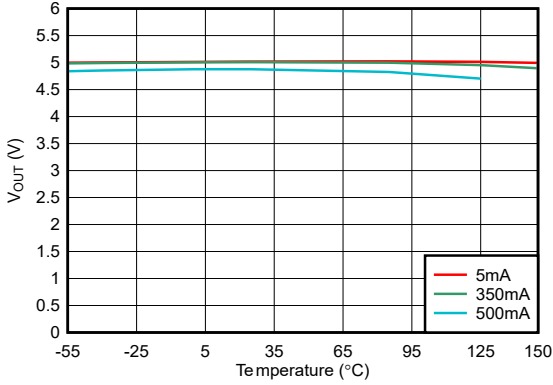

$V_{OUT} = 5V, V_{IN} = 8V$

图 5-1. Output Voltage vs Temperature (New Chip)

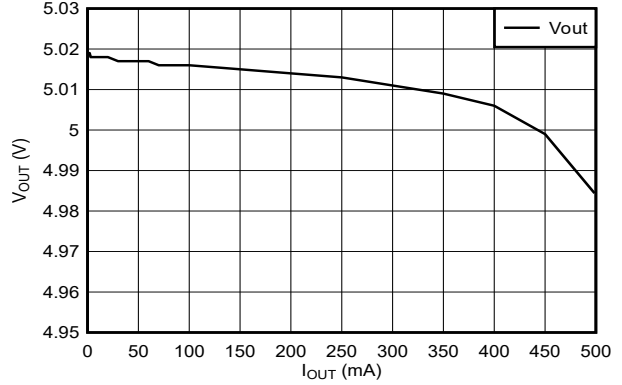

$V_{OUT} = 5V, V_{IN} = 8V$

图 5-2. Load Regulation at  $T_J = 25^\circ\text{C}$  (New Chip)

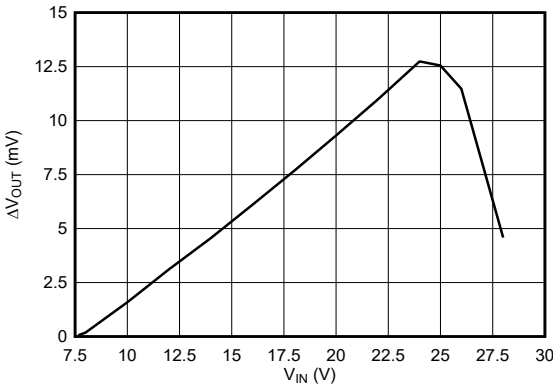

$V_{OUT} = 5V, I_{OUT} = 350\text{mA}$

图 5-3. Line Regulation at  $T_J = 25^\circ\text{C}$  (New Chip)



图 5-4. Bias Current vs Input Voltage at  $T_J = 25^\circ\text{C}$  (New Chip)



$V_{OUT} = 5V, V_{IN} = 10V$

图 5-5. Bias Current vs Temperature (New Chip)

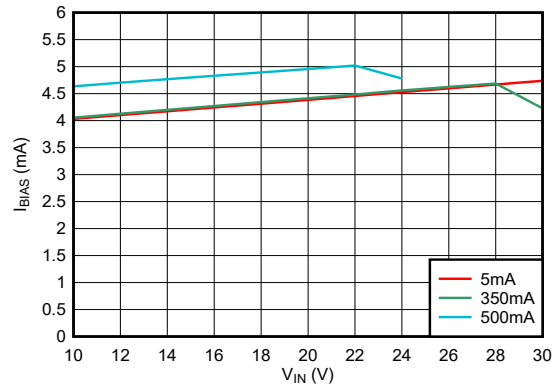
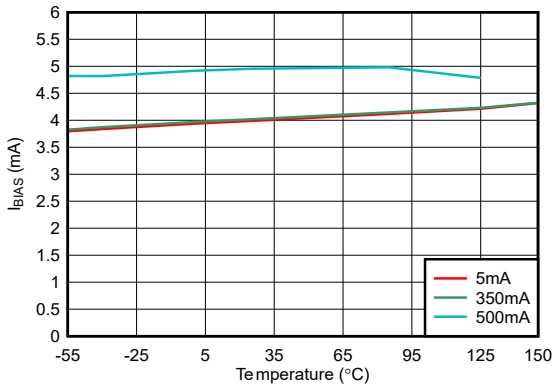
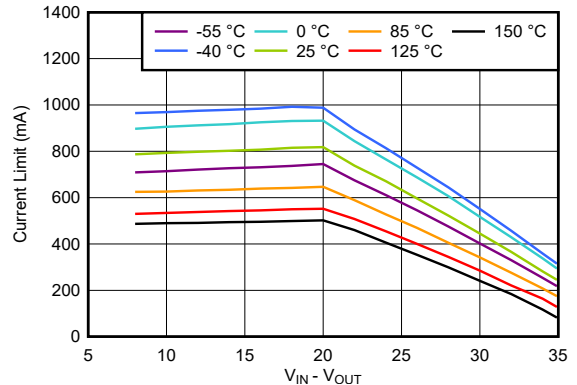

$V_O = 0V$

图 5-6.  $I_{CL}$  vs Input Voltage (New Chip)

### 5.12 Typical Characteristics (continued)



图 5-7. Output Voltage vs I<sub>CL</sub> (New Chip)



图 5-8. Output Voltage vs I<sub>CL</sub> (New Chip)

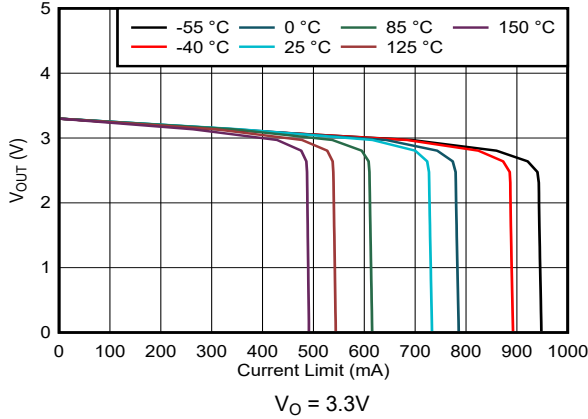

图 5-9. PSRR vs Frequency and I<sub>O</sub> (Legacy Chip)

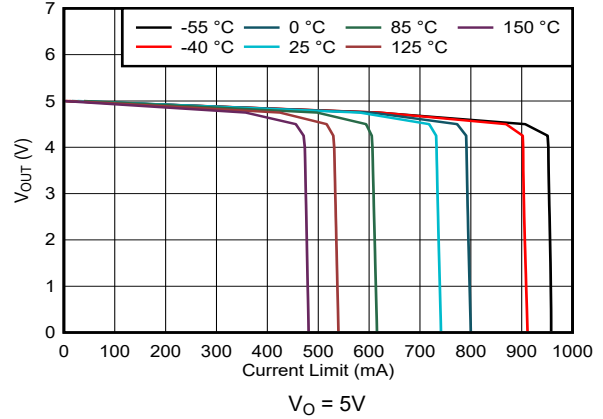

图 5-10. PSRR vs Frequency and I<sub>O</sub> (New Chip)

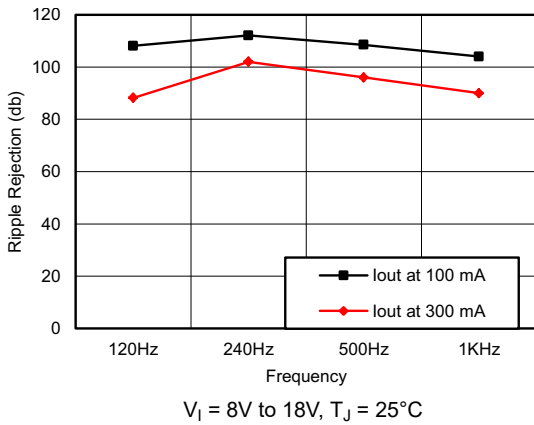

V<sub>IN</sub> = 10V, V<sub>OUT</sub> = 5V, I<sub>OUT</sub> = 100mA, C<sub>OUT</sub> = 0.1 µF

图 5-11. Noise vs Frequency (New Chip)

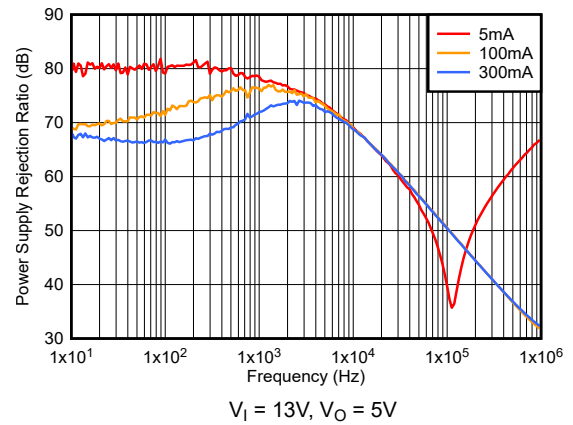
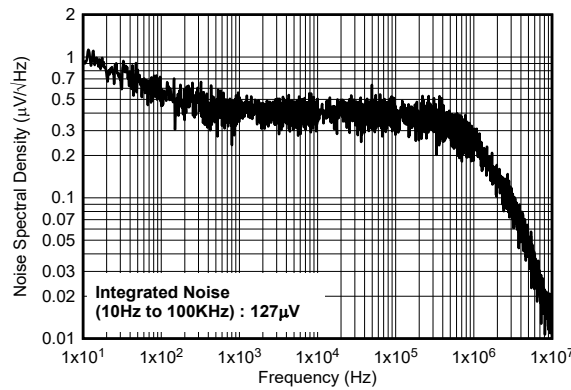
## 6 Detailed Description

### 6.1 Overview

The UA78M fixed-voltage, integrated-circuit voltage regulator is designed for a wide range of applications. The UA78M supports a wide range of input voltages and delivers 500mA of load current.

This device features internal current-limiting and thermal shutdown mechanisms. To provide reliable operation across wide  $V_I$  ranges, the current-limiting mechanism modulates the load current capacity both by monitoring the  $V_O$  level and the difference between the  $V_I$  and  $V_O$  voltage levels. The operating ambient temperature range of the device is  $-40^{\circ}\text{C}$  to  $+125^{\circ}\text{C}$  for all variants.

### 6.2 Functional Block Diagram

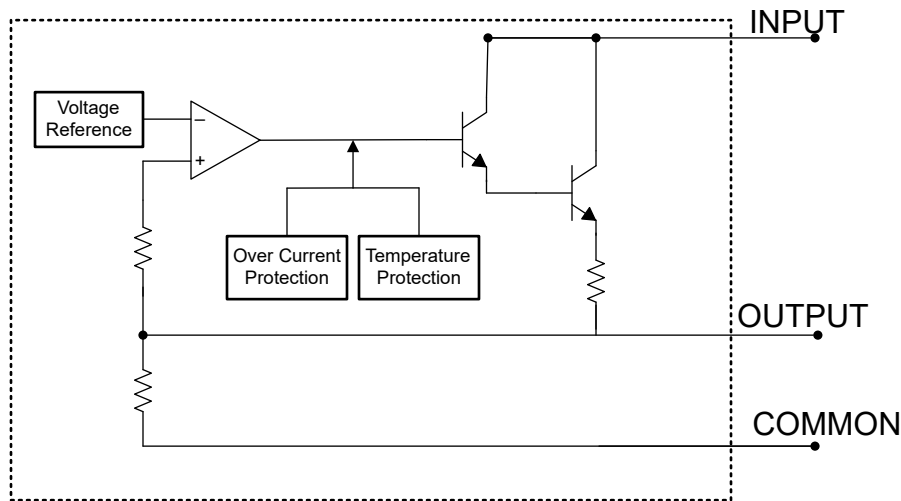

### 6.3 Feature Description

#### 6.3.1 Current Limit

The device has an internal current-limit circuit that protects the regulator during transient high-load current faults or shorting events. In a high-load current fault, the current limit scheme limits the output current to the current limit ( $I_{CL}$ ).  $I_{CL}$  is listed in the *Electrical Characteristics* table.

The output voltage is not regulated when the device is in current limit. When a current-limit event occurs, the device begins to heat up because of the increase in power dissipation. When the device is in current limit, the pass transistor dissipates power  $[(V_I - V_O) \times I_{CL}]$ . For more information on current limits, see the [Know Your Limits application note](#).

To achieve a safe operation across a wide range of Input voltage, the UA78M also has a built-in protection mechanism with current limit. The protection mechanism decreases the current limit as input-to-output voltage increases and keeps the power transistor inside a safe operating region for all values of input-to-output voltage. This protection is designed to provide some output current at all values of input-to-output voltage limits defined in the [Recommended Operating Conditions](#) table. 图 6-1 shows the behavior of the current limit variation.



图 6-1. Current-Limit vs  $V_{\text{Head-room}}$  Behavior (New Chip)

### 6.3.2 Dropout Voltage ( $V_{DO}$ )

Dropout voltage ( $V_{DO}$ ) is defined as the input voltage minus the output voltage ( $V_I - V_O$ ) at the rated output current ( $I_{RATED}$ ), where the pass transistor is fully on.  $I_{RATED}$  is the maximum  $I_O$  listed in the [Recommended Operating Conditions](#) table. In dropout operation, the pass transistor is in the ohmic or triode region of operation, and acts as a switch. The dropout voltage indirectly specifies a minimum input voltage greater than the nominal programmed output voltage at which the output voltage is expected to stay in regulation. If the input voltage falls to less than the value required to maintain output regulation, then the output voltage falls as well.

### 6.3.3 Thermal Shutdown

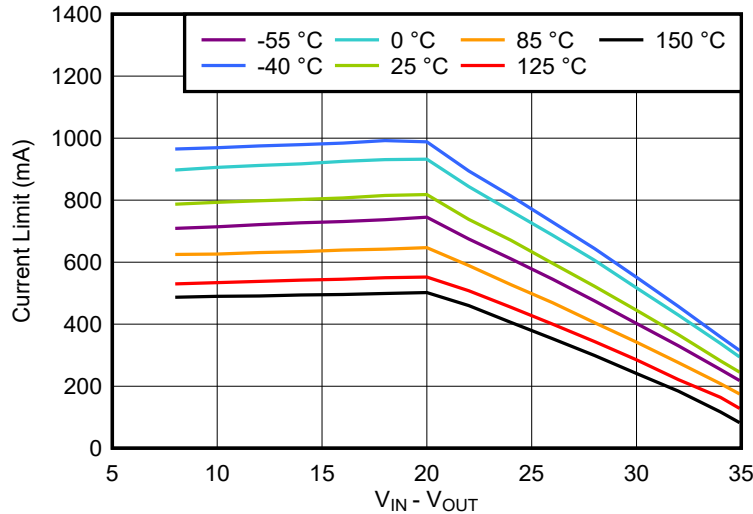
The device contains a thermal shutdown protection circuit to disable the device when the junction temperature ( $T_J$ ) of the pass transistor rises to  $T_{SD(\text{shutdown})}$  (typical). Thermal shutdown hysteresis makes sure that the device resets (turns on) when the temperature falls to  $T_{SD(\text{reset})}$  (typical).

The thermal time-constant of the semiconductor die is fairly short, thus the device can cycle on and off when thermal shutdown is reached until power dissipation is reduced. Power dissipation during start-up can be high from large  $V_I - V_O$  voltage drops across the device or from high inrush currents charging large output capacitors. Under some conditions, the thermal shutdown protection disables the device before start-up completes.

For reliable operation, limit the junction temperature to the maximum listed in the [Recommended Operating Conditions](#) table. Operation above this maximum temperature causes the device to exceed operational specifications. Although the internal protection circuitry of the device is designed to protect against thermal overall conditions, this circuitry is not intended to replace proper heat sinking. Continuously running the device into thermal shutdown or above the maximum recommended junction temperature reduces long-term reliability.

## 6.4 Device Functional Modes

表 6-1 provides a quick comparison between the normal and dropout modes of operation.

表 6-1. Device Functional Mode Comparison

OPERATING MODE	PARAMETER	
	$V_I$	$I_O$
Normal	$V_I > V_{OUT(nom)} + V_{DO}$	$I_O < I_{CL}$
Dropout	$V_I < V_{OUT(nom)} + V_{DO}$	$I_O < I_{CL}$

### 6.4.1 Normal Operation

The device regulates to the nominal output voltage under the following conditions:

- The input voltage is greater than the nominal output voltage plus the dropout voltage ( $V_{OUT(nom)} + V_{DO}$ )
- The output current is less than the current limit ( $I_O < I_{CL}$ )
- The device junction temperature is greater than  $-40^{\circ}\text{C}$  and less than  $+125^{\circ}\text{C}$

### 6.4.2 Dropout Operation

If the input voltage is lower than the nominal output voltage plus the specified dropout voltage, but all other conditions are met for normal operation, the device operates in dropout mode. In this mode, the output voltage tracks the input voltage. During this mode, the transient performance of the device becomes significantly degraded because the pass transistor is in the ohmic or triode region, and acts as a switch. Line or load transients in dropout can result in large output voltage deviations.

When the device is in a steady dropout state (defined as when the device is in dropout,  $V_I < V_{OUT(NOM)} + V_{DO}$ , directly after being in a normal regulation state, but *not* during start up), the pass transistor is driven into the ohmic or triode region. When the input voltage returns to a value greater than or equal to the nominal output voltage plus the dropout voltage ( $V_{OUT(NOM)} + V_{DO}$ ), the output voltage can overshoot for a short period of time while the device pulls the pass transistor back into the linear region.

## 7 Application and Implementation

### 备注

以下应用部分中的信息不属于 TI 器件规格的范围，TI 不担保其准确性和完整性。TI 的客户应负责确定器件是否适用于其应用。客户应验证并测试其设计，以确保系统功能。

### 7.1 Application Information

The UA78M is designed for use as a linear regulator with only a few external components needed. Use the UA78M to clean power-supply noise by attenuating ripple on the input signal.

### 7.2 Typical Application

The UA78M is typically used as a fixed-output linear regulator, sourcing current up to 500mA into a load.



图 7-1. Fixed-Output Regulator

#### 7.2.1 Design Requirements

Tie the COMMON pin to ground to set the OUTPUT pin to the desired fixed output voltage.

Although not required, a 0.33µF bypass capacitor is recommended on the input, and a 0.1µF bypass capacitor is recommended on the output.

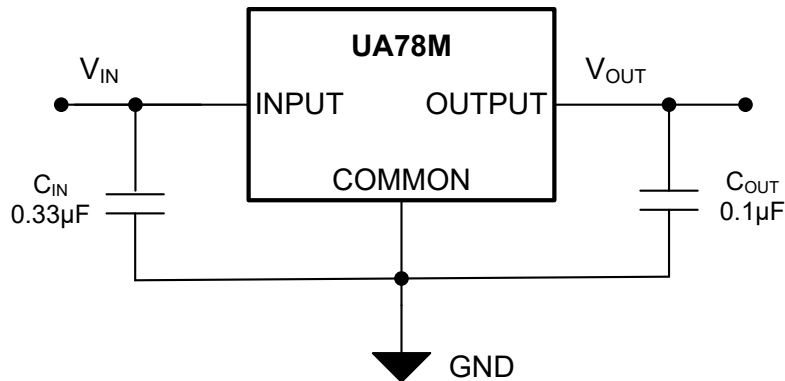
#### 7.2.2 Detailed Design Procedure

##### 7.2.2.1 Input and Output Capacitor Requirements

Although the input and output capacitors are not required for stability, good analog design practice is to connect a capacitor from INPUT to COMMON and from OUTPUT to COMMON. The input capacitor counteracts reactive input sources and improves transient response, input ripple, and PSRR. Use an input capacitor if the source impedance is more than 0.5Ω. A higher value capacitor can be necessary if large, fast rise-time load or line transients are anticipated or if the device is located several inches from the input power source.

Dynamic performance of the device is improved by using a large output capacitor. Use an output capacitor within the range specified in the [Recommended Operating Conditions](#) table for stability.

##### 7.2.2.2 Power Dissipation (P<sub>D</sub>)

Circuit reliability requires consideration of the device power dissipation, location of the circuit on the printed circuit board (PCB), and correct sizing of the thermal plane. Make sure the PCB area around the regulator has few or no other heat-generating devices that cause added thermal stress.

To first-order approximation, power dissipation in the regulator depends on the input-to-output voltage difference and load conditions. The following equation calculates power dissipation (P<sub>D</sub>).

$$P_D = (V_I - V_O) \times I_O \quad (1)$$

**备注**

Power dissipation is minimized, and therefore greater efficiency be achieved, by correct selection of the system voltage rails. For the lowest power dissipation, use the minimum input voltage required for correct output regulation.

For devices with a thermal pad, the primary heat conduction path for the device package is through the thermal pad to the PCB. Solder the thermal pad to a copper pad area under the device. This pad area contains an array of plated vias that conduct heat to additional copper planes for increased heat dissipation.

The maximum power dissipation determines the maximum allowable ambient temperature ( $T_A$ ) for the device. According to the following equation, power dissipation and junction temperature are most often related by the junction-to-ambient thermal resistance ( $R_{\theta JA}$ ) of the combined PCB and device package and the temperature of the ambient air ( $T_A$ ).

$$T_J = T_A + (R_{\theta JA} \times P_D) \tag{2}$$

Thermal resistance ( $R_{\theta JA}$ ) is highly dependent on the heat-spreading capability built into the particular PCB design, and therefore varies according to the total copper area, copper weight, and location of the planes. The junction-to-ambient thermal resistance listed in the [Thermal Information](#) table is determined by the JEDEC standard PCB and copper-spreading area, and is used as a relative measure of package thermal performance. As mentioned in the [An empirical analysis of the impact of board layout on LDO thermal performance application note](#),  $R_{\theta JA}$  is improved by 35% to 55% compared to the [Thermal Information](#) table value with the PCB board layout optimization.

**7.2.2.3 Estimating Junction Temperature**

The JEDEC standard now recommends the use of psi ( $\Psi$ ) thermal metrics to estimate the junction temperatures of the linear regulator when in circuit on a typical PCB board application. These metrics are not thermal resistance parameters and instead offer a practical and relative way to estimate junction temperature. These psi metrics are determined to be significantly independent of the copper area available for heat-spreading. The [Thermal Information](#) table lists the primary thermal metrics, which are the junction-to-top characterization parameter ( $\Psi_{JT}$ ) and junction-to-board characterization parameter ( $\Psi_{JB}$ ). These parameters provide two methods for calculating the junction temperature ( $T_J$ ), as described in the following equations. Use the junction-to-top characterization parameter ( $\Psi_{JT}$ ) with the temperature at the center-top of device package ( $T_T$ ) to calculate the junction temperature. Use the junction-to-board characterization parameter ( $\Psi_{JB}$ ) with the PCB surface temperature 1mm from the device package ( $T_B$ ) to calculate the junction temperature.

$$T_J = T_T + \Psi_{JT} \times P_D \tag{3}$$

where:

- $P_D$  is the dissipated power
- $T_T$  is the temperature at the center-top of the device package

$$T_J = T_B + \Psi_{JB} \times P_D \tag{4}$$

where:

- $T_B$  is the PCB surface temperature measured 1mm from the device package and centered on the package edge

For detailed information on the thermal metrics and how to use them, see the [Semiconductor and IC Package Thermal Metrics application note](#).

**7.2.2.4 External Capacitor Requirements**

The UA78M is designed to be stable without any external component. Multilayer ceramic capacitors have become the industry standard for these types of applications and are recommended, but use good judgment.

Ceramic capacitors that employ X7R-, X5R-, and C0G-rated dielectric materials provide relatively good capacitive stability across temperature, whereas the use of Y5V-rated capacitors is discouraged because of large variations in capacitance.

Regardless of the ceramic capacitor type selected, the effective capacitance varies with operating voltage and temperature. Generally, expect the effective capacitance to decrease by as much as 50%. The input and output capacitors recommended in the [Recommended Operating Conditions](#) table account for an effective capacitance of approximately 50% of the nominal value.

#### 7.2.2.5 Overload Recovery

As the input voltage rises when power is first turned on, the output follows the input, allowing the regulator to start up into very heavy loads. The input-to-output voltage differential is small during start up when the input voltage is rising, allowing the regulator to supply large output currents. With a high input voltage, a problem occurs where removing an output short does not allow the output voltage to recover. Other regulators also exhibit this phenomenon, so the behavior is not unique to the UA78M.

The problem occurs with a heavy output load when the input voltage is high and the output voltage is low. Common situations occur immediately when removing a short circuit after the input voltage is already turned on. The load line for such a load has the possibility to intersect the output current curve at two points. If this condition happens, there are two stable output operating points for the regulator. With this double intersection, the input power supply is potentially cycled down to zero and brought up again to make the output recover to the desired voltage operating point.

#### 7.2.2.6 Reverse Current

Excessive reverse current can damage this device. Reverse current flows through the emitter-base junction of the pass transistor instead of the normal conducting channel. At high magnitudes, this current flow degrades the long-term reliability of the device.

Conditions where reverse current can occur are outlined in this section, all of which can exceed the absolute maximum rating of  $V_O \leq V_I + 7V$ . These conditions are:

- If the device has a large  $C_{OUT}$  and the input supply collapses with little or no load current
- The output is biased when the input supply is not established
- The output is biased above the input supply

If reverse current flow is expected in the application, use external protection to protect the device. Reverse current is not limited in the device, so external limiting is required if extended reverse voltage operation is anticipated. Limit reverse current to 5% or less of the rated output current of the device in the event this current cannot be avoided.

图 7-2 shows one approach for protecting the device.



图 7-2. Example Circuit for Reverse Current Protection Using a Schottky Diode

### 7.2.2.7 Polarity Reversal Protection

In many applications, a voltage regulator powers a load that is not connected to ground, but instead, is connected to a voltage source of the opposite polarity (for example, operational amplifiers, level-shifting circuits, and so on). During start-up and short-circuit events, this connection can lead to polarity reversal of the regulator output and can damage the internal components of the regulator.

To avoid polarity reversal on the regulator output, use external protection to protect the device.

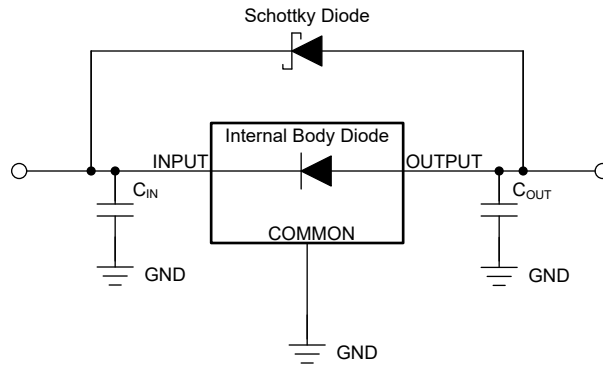
图 7-3 shows one approach for protecting the device.



图 7-3. Example Circuit for Polarity Reversal Protection Using a Schottky Diode

### 7.2.3 Application Curves



图 7-4.  $V_{IN}$  vs  $V_{OUT}$  at  $T_J = 25^\circ\text{C}$  (Legacy Chip)

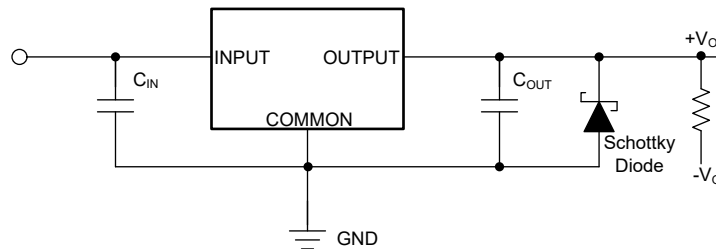

图 7-5.  $V_{IN}$  vs  $V_{OUT}$  at  $T_J = 25^\circ\text{C}$  (New Chip)

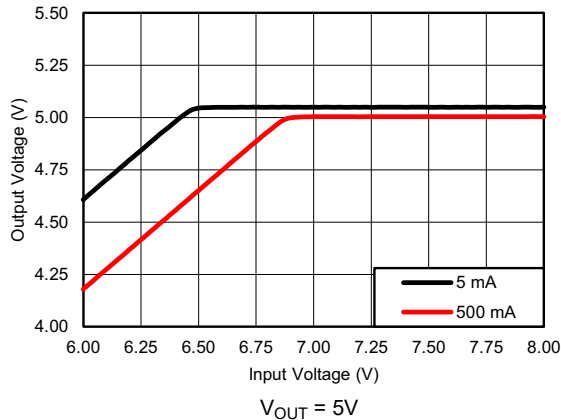

图 7-6.  $V_{IN}$  vs  $V_{OUT}$  at  $T_J = 25^\circ\text{C}$  (New Chip)

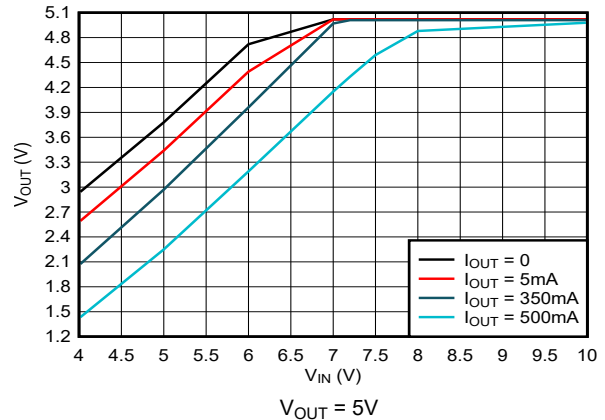

$V_O = 5\text{V}$ ,  $dV_{IN}/dt = 1\text{V}/\mu\text{s}$ ,  $I_{OUT} = 350\text{mA}$ ,  $C_{OUT} = 0.1\ \mu\text{F}$

图 7-7. Line Transient Behavior (New Chip)

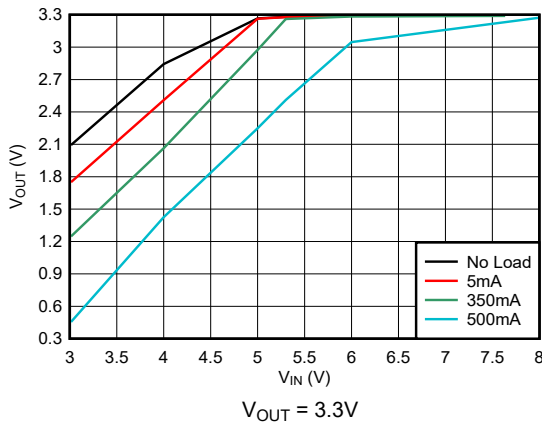
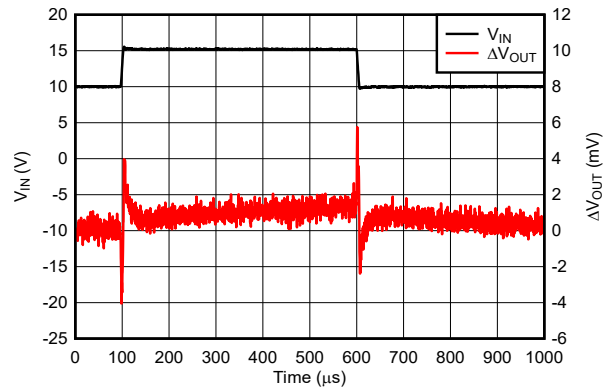
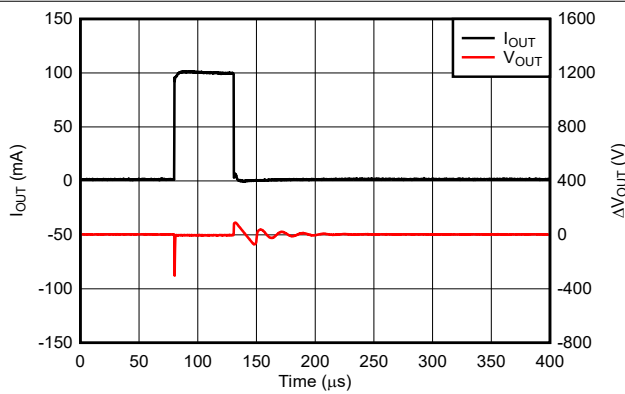

$V_{IN} = 10\text{V}$ ,  $V_{OUT} = 5\text{V}$ ,  $I_{OUT} = 1\text{mA}$  to  $100\text{mA}$ ,  $dI/dt = 1\text{A}/\mu\text{s}$ ,  
 $C_{OUT} = 0.1\ \mu\text{F}$

图 7-8. Load Transient Behavior (New Chip)

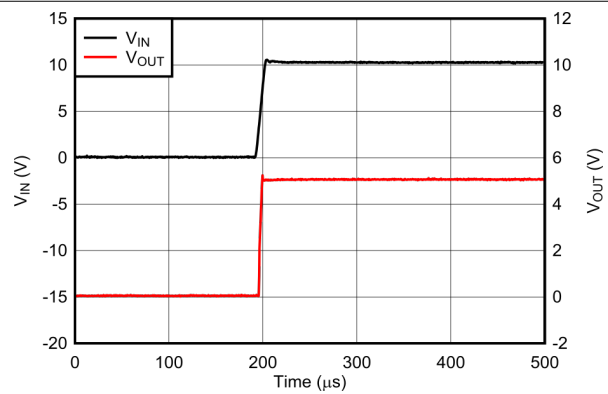

$V_{IN} = 0\text{V}$  to  $10\text{V}$ ,  $V_{OUT} = 5\text{V}$ ,  $I_{OUT} = 100\text{mA}$ ,  $dV_{IN}/dt = 1\text{V}/\mu\text{s}$ ,  
 $C_{OUT} = 0.1\ \mu\text{F}$

图 7-9. Start-Up (New Chip)

## 7.3 System Examples

### 7.3.1 Positive Regulator in Negative Configuration

图 7-10 shows the UA78M as a positive regulator used in a negative configuration. Make sure  $V_I$  floats in this configuration.



图 7-10. Positive Regulator in Negative Configuration

### 7.3.2 Current Limiter Circuit

图 7-11 shows an example of using the UA78M as a current limiter. The output current limit is set by 方程式 5,

$$I_O = \left( \frac{V_O}{R1} \right) + I_O \text{ Bias Current} \quad (5)$$

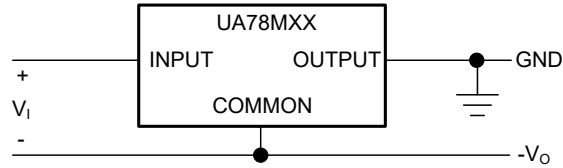

图 7-11. Current Limiter Example

## 7.4 Power Supply Recommendations

See the [Recommended Operating Conditions](#) for the recommended power supply voltages for each variation of the UA78M. Different orderable part numbers are able to tolerate different levels of voltage. Also, place a decoupling capacitor on the output to limit noise on the input.

## 7.5 Layout

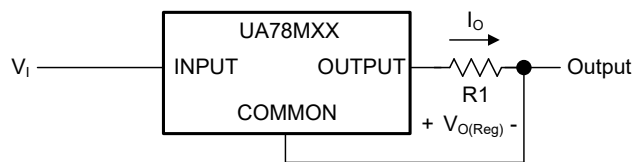
### 7.5.1 Layout Guidelines

Keep trace widths large enough to eliminate problematic  $I \times R$  voltage drops at the input and output pins. Place bypass capacitors as close to the UA78M as possible. Additional copper and vias connected to ground facilitate additional thermal dissipation, preventing the device from reaching thermal overload.

### 7.5.2 Layout Example



图 7-12. Layout Diagram

## 8 Device and Documentation Support

### 8.1 Device Support

#### 8.1.1 Development Support

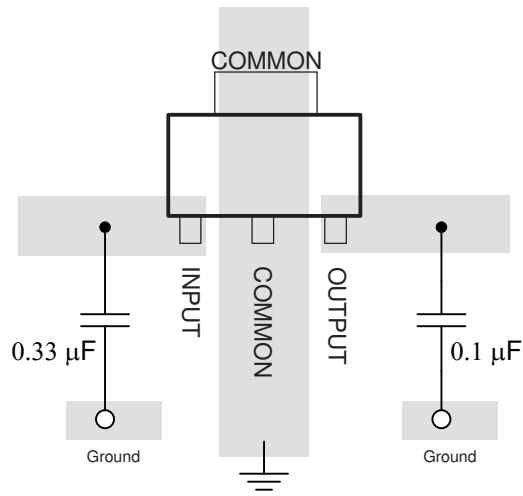
##### 8.1.1.1 Evaluation Module

An evaluation module (EVM) is available to assist in the initial circuit performance evaluation using the UA78L. The [UA78MEVM](#) (and [related user guide](#)) can be requested at the Texas Instruments website through the product folders or purchased directly from the [TI eStore](#).

#### 8.1.2 Device Nomenclature

**表 8-1. Device Nomenclature**

PRODUCT <sup>(1)</sup>	V <sub>OUT</sub>
UA78Mxxyyyz	<p><b>xx</b> is the nominal output voltage (for example, 05 = 5.0V, 15 = 15.0V).</p> <p><b>yyy</b> is the package designator.</p> <p><b>z</b> is the package quantity.</p> <p>Devices can ship with the legacy chip (CSO: SFB) or the new chip (CSO: RFB). The reel packaging label provides CSO information to distinguish which chip is being used. Device performance for new and legacy chips is denoted throughout the data sheet.</p>

(1) For the most current package and ordering information see the Package Option Addendum at the end of this document, or see the TI website at [www.ti.com](http://www.ti.com).

### 8.2 接收文档更新通知

要接收文档更新通知，请导航至 [ti.com](http://ti.com) 上的器件产品文件夹。点击 [通知](#) 进行注册，即可每周接收产品信息更改摘要。有关更改的详细信息，请查看任何已修订文档中包含的修订历史记录。

### 8.3 支持资源

[TI E2E™ 中文支持论坛](#) 是工程师的重要参考资料，可直接从专家处获得快速、经过验证的解答和设计帮助。搜索现有解答或提出自己的问题，获得所需的快速设计帮助。

链接的内容由各个贡献者“按原样”提供。这些内容并不构成 TI 技术规范，并且不一定反映 TI 的观点；请参阅 TI 的 [使用条款](#)。

### 8.4 Trademarks

TI E2E™ is a trademark of Texas Instruments.

所有商标均为其各自所有者的财产。

### 8.5 静电放电警告



静电放电 (ESD) 会损坏这个集成电路。德州仪器 (TI) 建议通过适当的预防措施处理所有集成电路。如果不遵守正确的处理和安装程序，可能会损坏集成电路。

ESD 的损坏小至导致微小的性能降级，大至整个器件故障。精密的集成电路可能更容易受到损坏，这是因为非常细微的参数更改都可能会导致器件与其发布的规格不相符。

### 8.6 术语表

#### TI 术语表

本术语表列出并解释了术语、首字母缩略词和定义。

## 9 Revision History

注：以前版本的页码可能与当前版本的页码不同

Changes from Revision U (May 2024) to Revision V (February 2025)	Page
• 从文档标题中删除了 35V .....	1
• 更改了特性部分：已将输入电压范围要点中的 35V 更改为 30V、添加了绝对最大输入电压要点，并删除了封装要点 .....	1
• 更改了说明部分 .....	1
• Added information of new chip for 9V voltage option .....	7
• Added information of new chip for 10V voltage option .....	8
• Added information of new chip for 12V voltage option .....	9

Changes from Revision T (January 2015) to Revision U (May 2024)	Page
• 更新了整个文档中的表格、图和交叉参考的编号格式 .....	1
• 更改了整个文档以与当前系列格式保持一致 .....	1
• 向文档添加了 M3 器件 .....	1
• 为了保持一致性，通篇将引脚名称从 IN、GND 和 OUT 更改为 INPUT、COMMON 和 OUTPUT .....	1

## 10 Mechanical, Packaging, and Orderable Information

The following pages include mechanical, packaging, and orderable information. This information is the most current data available for the designated devices. This data is subject to change without notice and revision of this document. For browser-based versions of this data sheet, refer to the left-hand navigation.

**PACKAGING INFORMATION**

Orderable part number	Status (1)	Material type (2)	Package   Pins	Package qty   Carrier	RoHS (3)	Lead finish/ Ball material (4)	MSL rating/ Peak reflow (5)	Op temp (°C)	Part marking (6)
SN78MCD CYR	Active	Production	SOT-223 (DCY)   4	2500   LARGE T&R	Yes	SN	Level-2-260C-1 YEAR	0 to 125	C5
<a href="#">UA78M05CDCY</a>	Active	Production	SOT-223 (DCY)   4	80   TUBE	Yes	SN	Level-2-260C-1 YEAR	0 to 125	C5
UA78M05CDCY.A	Active	Production	SOT-223 (DCY)   4	80   TUBE	Yes	SN	Level-2-260C-1 YEAR	0 to 125	C5
UA78M05CDCY G3	Active	Production	SOT-223 (DCY)   4	80   TUBE	Yes	SN	Level-2-260C-1 YEAR	0 to 125	C5
<a href="#">UA78M05CDCYR</a>	Active	Production	SOT-223 (DCY)   4	2500   LARGE T&R	Yes	SN	Level-2-260C-1 YEAR	0 to 125	C5
UA78M05CDCYR.A	Active	Production	SOT-223 (DCY)   4	2500   LARGE T&R	Yes	SN	Level-2-260C-1 YEAR	0 to 125	C5
UA78M05CDCYR G3	Active	Production	SOT-223 (DCY)   4	2500   LARGE T&R	Yes	SN	Level-2-260C-1 YEAR	0 to 125	C5
<a href="#">UA78M05CKCS</a>	NRND	Production	TO-220 (KCS)   3	50   TUBE	Yes	SN	N/A for Pkg Type	0 to 125	UA78M05C
UA78M05CKCS.A	NRND	Production	TO-220 (KCS)   3	50   TUBE	Yes	SN	N/A for Pkg Type	0 to 125	UA78M05C
UA78M05CKCSE3	NRND	Production	TO-220 (KCS)   3	50   TUBE	Yes	SN	N/A for Pkg Type	0 to 125	UA78M05C
<a href="#">UA78M05CKVURG3</a>	Active	Production	TO-252 (KVU)   3	2500   LARGE T&R	Yes	SN	Level-3-260C-168 HR	0 to 125	78M05C
UA78M05CKVURG3.A	Active	Production	TO-252 (KVU)   3	2500   LARGE T&R	Yes	SN	Level-3-260C-168 HR	0 to 125	78M05C
<a href="#">UA78M05IDCY</a>	Active	Production	SOT-223 (DCY)   4	80   TUBE	Yes	SN	Level-2-260C-1 YEAR	-40 to 125	(C5, J5)
UA78M05IDCY.A	Active	Production	SOT-223 (DCY)   4	80   TUBE	Yes	SN	Level-2-260C-1 YEAR	-40 to 125	(C5, J5)
UA78M05IDCY G3	Active	Production	SOT-223 (DCY)   4	80   TUBE	Yes	SN	Level-2-260C-1 YEAR	-40 to 125	(C5, J5)
<a href="#">UA78M05IDCYR</a>	Active	Production	SOT-223 (DCY)   4	2500   LARGE T&R	Yes	SN	Level-2-260C-1 YEAR	-40 to 125	(C5, J5)
UA78M05IDCYR.A	Active	Production	SOT-223 (DCY)   4	2500   LARGE T&R	Yes	SN	Level-2-260C-1 YEAR	-40 to 125	(C5, J5)
UA78M05IDCYR G3	Active	Production	SOT-223 (DCY)   4	2500   LARGE T&R	Yes	SN	Level-2-260C-1 YEAR	-40 to 125	(C5, J5)
<a href="#">UA78M05IKCS</a>	Active	Production	TO-220 (KCS)   3	50   TUBE	Yes	SN	N/A for Pkg Type	-40 to 125	UA78M05I
UA78M05IKCS.A	Active	Production	TO-220 (KCS)   3	50   TUBE	Yes	SN	N/A for Pkg Type	-40 to 125	UA78M05I
UA78M05IKCSE3	Active	Production	TO-220 (KCS)   3	50   TUBE	Yes	SN	N/A for Pkg Type	-40 to 125	UA78M05I
<a href="#">UA78M05IKVURG3</a>	Active	Production	TO-252 (KVU)   3	2500   LARGE T&R	Yes	SN	Level-3-260C-168 HR	-40 to 125	78M05I
UA78M05IKVURG3.A	Active	Production	TO-252 (KVU)   3	2500   LARGE T&R	Yes	SN	Level-3-260C-168 HR	-40 to 125	78M05I
<a href="#">UA78M06CKVURG3</a>	Active	Production	TO-252 (KVU)   3	2500   LARGE T&R	Yes	SN	Level-3-260C-168 HR	0 to 125	78M06C
UA78M06CKVURG3.A	Active	Production	TO-252 (KVU)   3	2500   LARGE T&R	Yes	SN	Level-3-260C-168 HR	0 to 125	78M06C
<a href="#">UA78M08CDCY</a>	Active	Production	SOT-223 (DCY)   4	80   TUBE	Yes	SN	Level-2-260C-1 YEAR	0 to 125	C8
UA78M08CDCY.A	Active	Production	SOT-223 (DCY)   4	80   TUBE	Yes	SN	Level-2-260C-1 YEAR	0 to 125	C8
UA78M08CDCY G3	Active	Production	SOT-223 (DCY)   4	80   TUBE	Yes	SN	Level-2-260C-1 YEAR	0 to 125	C8
<a href="#">UA78M08CDCYR</a>	Active	Production	SOT-223 (DCY)   4	2500   LARGE T&R	Yes	SN	Level-2-260C-1 YEAR	0 to 125	C8

Orderable part number	Status (1)	Material type (2)	Package   Pins	Package qty   Carrier	RoHS (3)	Lead finish/ Ball material (4)	MSL rating/ Peak reflow (5)	Op temp (°C)	Part marking (6)
UA78M08CDCYR.A	Active	Production	SOT-223 (DCY)   4	2500   LARGE T&R	Yes	SN	Level-2-260C-1 YEAR	0 to 125	C8
<a href="#">UA78M08CKCS</a>	Active	Production	TO-220 (KCS)   3	50   TUBE	Yes	SN	N/A for Pkg Type	0 to 125	UA78M08C
UA78M08CKCS.A	Active	Production	TO-220 (KCS)   3	50   TUBE	Yes	SN	N/A for Pkg Type	0 to 125	UA78M08C
UA78M08CKCSE3	Active	Production	TO-220 (KCS)   3	50   TUBE	Yes	SN	N/A for Pkg Type	0 to 125	UA78M08C
<a href="#">UA78M08CKVURG3</a>	Active	Production	TO-252 (KVU)   3	2500   LARGE T&R	Yes	SN	Level-3-260C-168 HR	0 to 125	78M08C
UA78M08CKVURG3.A	Active	Production	TO-252 (KVU)   3	2500   LARGE T&R	Yes	SN	Level-3-260C-168 HR	0 to 125	78M08C
<a href="#">UA78M09CKVURG3</a>	Active	Production	TO-252 (KVU)   3	2500   LARGE T&R	Yes	SN	Level-3-260C-168 HR	0 to 125	78M09C
UA78M09CKVURG3.A	Active	Production	TO-252 (KVU)   3	2500   LARGE T&R	Yes	SN	Level-3-260C-168 HR	0 to 125	78M09C
<a href="#">UA78M10CKVURG3</a>	Active	Production	TO-252 (KVU)   3	2500   LARGE T&R	Yes	SN	Level-3-260C-168 HR	0 to 125	78M10C
UA78M10CKVURG3.A	Active	Production	TO-252 (KVU)   3	2500   LARGE T&R	Yes	SN	Level-3-260C-168 HR	0 to 125	78M10C
<a href="#">UA78M12CKCS</a>	Active	Production	TO-220 (KCS)   3	50   TUBE	Yes	SN	N/A for Pkg Type	0 to 125	UA78M12C
UA78M12CKCS.A	Active	Production	TO-220 (KCS)   3	50   TUBE	Yes	SN	N/A for Pkg Type	0 to 125	UA78M12C
UA78M12CKCSE3	Active	Production	TO-220 (KCS)   3	50   TUBE	Yes	SN	N/A for Pkg Type	0 to 125	UA78M12C
<a href="#">UA78M12CKVURG3</a>	Active	Production	TO-252 (KVU)   3	2500   LARGE T&R	Yes	SN	Level-3-260C-168 HR	0 to 125	78M12C
UA78M12CKVURG3.A	Active	Production	TO-252 (KVU)   3	2500   LARGE T&R	Yes	SN	Level-3-260C-168 HR	0 to 125	78M12C
<a href="#">UA78M33CDCY</a>	Active	Production	SOT-223 (DCY)   4	80   TUBE	Yes	SN	Level-2-260C-1 YEAR	0 to 125	C3
UA78M33CDCY.A	Active	Production	SOT-223 (DCY)   4	80   TUBE	Yes	SN	Level-2-260C-1 YEAR	0 to 125	C3
UA78M33CDCYG3	Active	Production	SOT-223 (DCY)   4	80   TUBE	Yes	SN	Level-2-260C-1 YEAR	0 to 125	C3
<a href="#">UA78M33CDCYR</a>	Active	Production	SOT-223 (DCY)   4	2500   LARGE T&R	Yes	SN	Level-2-260C-1 YEAR	0 to 125	C3
UA78M33CDCYR.A	Active	Production	SOT-223 (DCY)   4	2500   LARGE T&R	Yes	SN	Level-2-260C-1 YEAR	0 to 125	C3
UA78M33CDCYRG3	Active	Production	SOT-223 (DCY)   4	2500   LARGE T&R	Yes	SN	Level-2-260C-1 YEAR	0 to 125	C3
<a href="#">UA78M33CKCS</a>	Active	Production	TO-220 (KCS)   3	50   TUBE	Yes	SN	N/A for Pkg Type	0 to 125	UA78M33C
UA78M33CKCS.A	Active	Production	TO-220 (KCS)   3	50   TUBE	Yes	SN	N/A for Pkg Type	0 to 125	UA78M33C
UA78M33CKCSE3	Active	Production	TO-220 (KCS)   3	50   TUBE	Yes	SN	N/A for Pkg Type	0 to 125	UA78M33C
<a href="#">UA78M33CKVURG3</a>	Active	Production	TO-252 (KVU)   3	2500   LARGE T&R	Yes	SN	Level-3-260C-168 HR	0 to 125	78M33C
UA78M33CKVURG3.A	Active	Production	TO-252 (KVU)   3	2500   LARGE T&R	Yes	SN	Level-3-260C-168 HR	0 to 125	78M33C
<a href="#">UA78M33IKVURG3</a>	Active	Production	TO-252 (KVU)   3	2500   LARGE T&R	Yes	SN	Level-3-260C-168 HR	-40 to 125	78M33I
UA78M33IKVURG3.A	Active	Production	TO-252 (KVU)   3	2500   LARGE T&R	Yes	SN	Level-3-260C-168 HR	-40 to 125	78M33I

<sup>(1)</sup> **Status:** For more details on status, see our [product life cycle](#).

- (2) **Material type:** When designated, preproduction parts are prototypes/experimental devices, and are not yet approved or released for full production. Testing and final process, including without limitation quality assurance, reliability performance testing, and/or process qualification, may not yet be complete, and this item is subject to further changes or possible discontinuation. If available for ordering, purchases will be subject to an additional waiver at checkout, and are intended for early internal evaluation purposes only. These items are sold without warranties of any kind.
- (3) **RoHS values:** Yes, No, RoHS Exempt. See the [TI RoHS Statement](#) for additional information and value definition.
- (4) **Lead finish/Ball material:** Parts may have multiple material finish options. Finish options are separated by a vertical ruled line. Lead finish/Ball material values may wrap to two lines if the finish value exceeds the maximum column width.
- (5) **MSL rating/Peak reflow:** The moisture sensitivity level ratings and peak solder (reflow) temperatures. In the event that a part has multiple moisture sensitivity ratings, only the lowest level per JEDEC standards is shown. Refer to the shipping label for the actual reflow temperature that will be used to mount the part to the printed circuit board.
- (6) **Part marking:** There may be an additional marking, which relates to the logo, the lot trace code information, or the environmental category of the part.

Multiple part markings will be inside parentheses. Only one part marking contained in parentheses and separated by a "~" will appear on a part. If a line is indented then it is a continuation of the previous line and the two combined represent the entire part marking for that device.

**Important Information and Disclaimer:** The information provided on this page represents TI's knowledge and belief as of the date that it is provided. TI bases its knowledge and belief on information provided by third parties, and makes no representation or warranty as to the accuracy of such information. Efforts are underway to better integrate information from third parties. TI has taken and continues to take reasonable steps to provide representative and accurate information but may not have conducted destructive testing or chemical analysis on incoming materials and chemicals. TI and TI suppliers consider certain information to be proprietary, and thus CAS numbers and other limited information may not be available for release.

In no event shall TI's liability arising out of such information exceed the total purchase price of the TI part(s) at issue in this document sold by TI to Customer on an annual basis.

**OTHER QUALIFIED VERSIONS OF UA78M :**

- Automotive : [UA78M-Q1](#)

NOTE: Qualified Version Definitions:

- Automotive - Q100 devices qualified for high-reliability automotive applications targeting zero defects

**TAPE AND REEL INFORMATION**

**QUADRANT ASSIGNMENTS FOR PIN 1 ORIENTATION IN TAPE**



\*All dimensions are nominal

Device	Package Type	Package Drawing	Pins	SPQ	Reel Diameter (mm)	Reel Width W1 (mm)	A0 (mm)	B0 (mm)	K0 (mm)	P1 (mm)	W (mm)	Pin1 Quadrant
UA78M05CDCYR	SOT-223	DCY	4	2500	330.0	12.4	7.05	7.4	1.9	8.0	12.0	Q3
UA78M05CKVURG3	TO-252	KVU	3	2500	330.0	16.4	6.9	10.5	2.7	8.0	16.0	Q2
UA78M05IDCYR	SOT-223	DCY	4	2500	330.0	12.4	7.05	7.4	1.9	8.0	12.0	Q3
UA78M05IKVURG3	TO-252	KVU	3	2500	330.0	16.4	6.9	10.5	2.7	8.0	16.0	Q2
UA78M06CKVURG3	TO-252	KVU	3	2500	330.0	16.4	6.9	10.5	2.7	8.0	16.0	Q2
UA78M08CDCYR	SOT-223	DCY	4	2500	330.0	12.4	7.05	7.4	1.9	8.0	12.0	Q3
UA78M08CKVURG3	TO-252	KVU	3	2500	330.0	16.4	6.9	10.5	2.7	8.0	16.0	Q2
UA78M09CKVURG3	TO-252	KVU	3	2500	330.0	16.4	6.9	10.5	2.7	8.0	16.0	Q2
UA78M10CKVURG3	TO-252	KVU	3	2500	330.0	16.4	6.9	10.5	2.7	8.0	16.0	Q2
UA78M12CKVURG3	TO-252	KVU	3	2500	330.0	16.4	6.9	10.5	2.7	8.0	16.0	Q2
UA78M33CDCYR	SOT-223	DCY	4	2500	330.0	12.4	7.05	7.4	1.9	8.0	12.0	Q3
UA78M33CKVURG3	TO-252	KVU	3	2500	330.0	16.4	6.9	10.5	2.7	8.0	16.0	Q2
UA78M33IKVURG3	TO-252	KVU	3	2500	330.0	16.4	6.9	10.5	2.7	8.0	16.0	Q2

**TAPE AND REEL BOX DIMENSIONS**

\*All dimensions are nominal

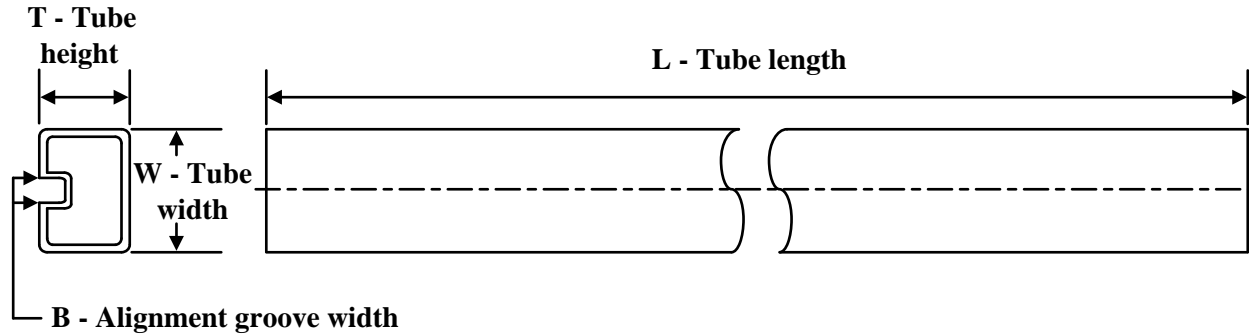
Device	Package Type	Package Drawing	Pins	SPQ	Length (mm)	Width (mm)	Height (mm)
UA78M05CDCYR	SOT-223	DCY	4	2500	340.0	340.0	38.0
UA78M05CKVURG3	TO-252	KVU	3	2500	340.0	340.0	38.0
UA78M05IDCYR	SOT-223	DCY	4	2500	340.0	340.0	38.0
UA78M05IKVURG3	TO-252	KVU	3	2500	340.0	340.0	38.0
UA78M06CKVURG3	TO-252	KVU	3	2500	340.0	340.0	38.0
UA78M08CDCYR	SOT-223	DCY	4	2500	340.0	340.0	38.0
UA78M08CKVURG3	TO-252	KVU	3	2500	340.0	340.0	38.0
UA78M09CKVURG3	TO-252	KVU	3	2500	340.0	340.0	38.0
UA78M10CKVURG3	TO-252	KVU	3	2500	340.0	340.0	38.0
UA78M12CKVURG3	TO-252	KVU	3	2500	340.0	340.0	38.0
UA78M33CDCYR	SOT-223	DCY	4	2500	340.0	340.0	38.0
UA78M33CKVURG3	TO-252	KVU	3	2500	340.0	340.0	38.0
UA78M33IKVURG3	TO-252	KVU	3	2500	340.0	340.0	38.0

**TUBE**

\*All dimensions are nominal

Device	Package Name	Package Type	Pins	SPQ	L (mm)	W (mm)	T (µm)	B (mm)
UA78M05CDCY	DCY	SOT-223	4	80	559	8.6	500	3.6
UA78M05CDCY.A	DCY	SOT-223	4	80	559	8.6	500	3.6
UA78M05CDCYG3	DCY	SOT-223	4	80	559	8.6	500	3.6
UA78M05CKCS	KCS	TO-220	3	50	532	34.1	700	9.6
UA78M05CKCS.A	KCS	TO-220	3	50	532	34.1	700	9.6
UA78M05CKCSE3	KCS	TO-220	3	50	532	34.1	700	9.6
UA78M05IDCY	DCY	SOT-223	4	80	559	8.6	500	3.6
UA78M05IDCY.A	DCY	SOT-223	4	80	559	8.6	500	3.6
UA78M05IDCYG3	DCY	SOT-223	4	80	559	8.6	500	3.6
UA78M05IKCS	KCS	TO-220	3	50	532	34.1	700	9.6
UA78M05IKCS.A	KCS	TO-220	3	50	532	34.1	700	9.6
UA78M05IKCSE3	KCS	TO-220	3	50	532	34.1	700	9.6
UA78M08CDCY	DCY	SOT-223	4	80	559	8.6	500	3.6
UA78M08CDCY.A	DCY	SOT-223	4	80	559	8.6	500	3.6
UA78M08CDCYG3	DCY	SOT-223	4	80	559	8.6	500	3.6
UA78M08CKCS	KCS	TO-220	3	50	532	34.1	700	9.6
UA78M08CKCS.A	KCS	TO-220	3	50	532	34.1	700	9.6
UA78M08CKCSE3	KCS	TO-220	3	50	532	34.1	700	9.6
UA78M12CKCS	KCS	TO-220	3	50	532	34.1	700	9.6
UA78M12CKCS.A	KCS	TO-220	3	50	532	34.1	700	9.6
UA78M12CKCSE3	KCS	TO-220	3	50	532	34.1	700	9.6
UA78M33CDCY	DCY	SOT-223	4	80	559	8.6	500	3.6
UA78M33CDCY.A	DCY	SOT-223	4	80	559	8.6	500	3.6
UA78M33CDCYG3	DCY	SOT-223	4	80	559	8.6	500	3.6
UA78M33CDCYR	DCY	SOT-223	4	2500	559	8.6	500	3.6
UA78M33CDCYR.A	DCY	SOT-223	4	2500	559	8.6	500	3.6
UA78M33CDCYRG3	DCY	SOT-223	4	2500	559	8.6	500	3.6
UA78M33CKCS	KCS	TO-220	3	50	532	34.1	700	9.6
UA78M33CKCS.A	KCS	TO-220	3	50	532	34.1	700	9.6

---

Device	Package Name	Package Type	Pins	SPQ	L (mm)	W (mm)	T (μm)	B (mm)
UA78M33CKCSE3	KCS	TO-220	3	50	532	34.1	700	9.6

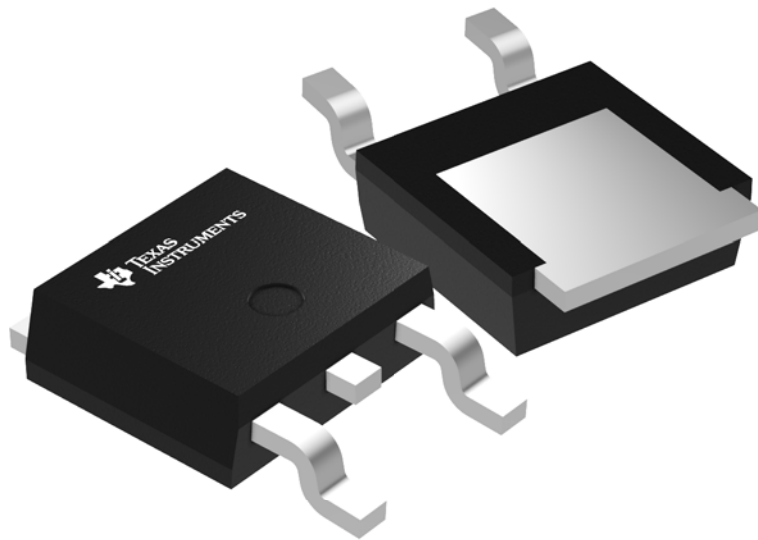

Images above are just a representation of the package family, actual package may vary.  
Refer to the product data sheet for package details.



# PACKAGE OUTLINE

## KVVU0003A

### TO-252 - 2.52 mm max height

TO-252

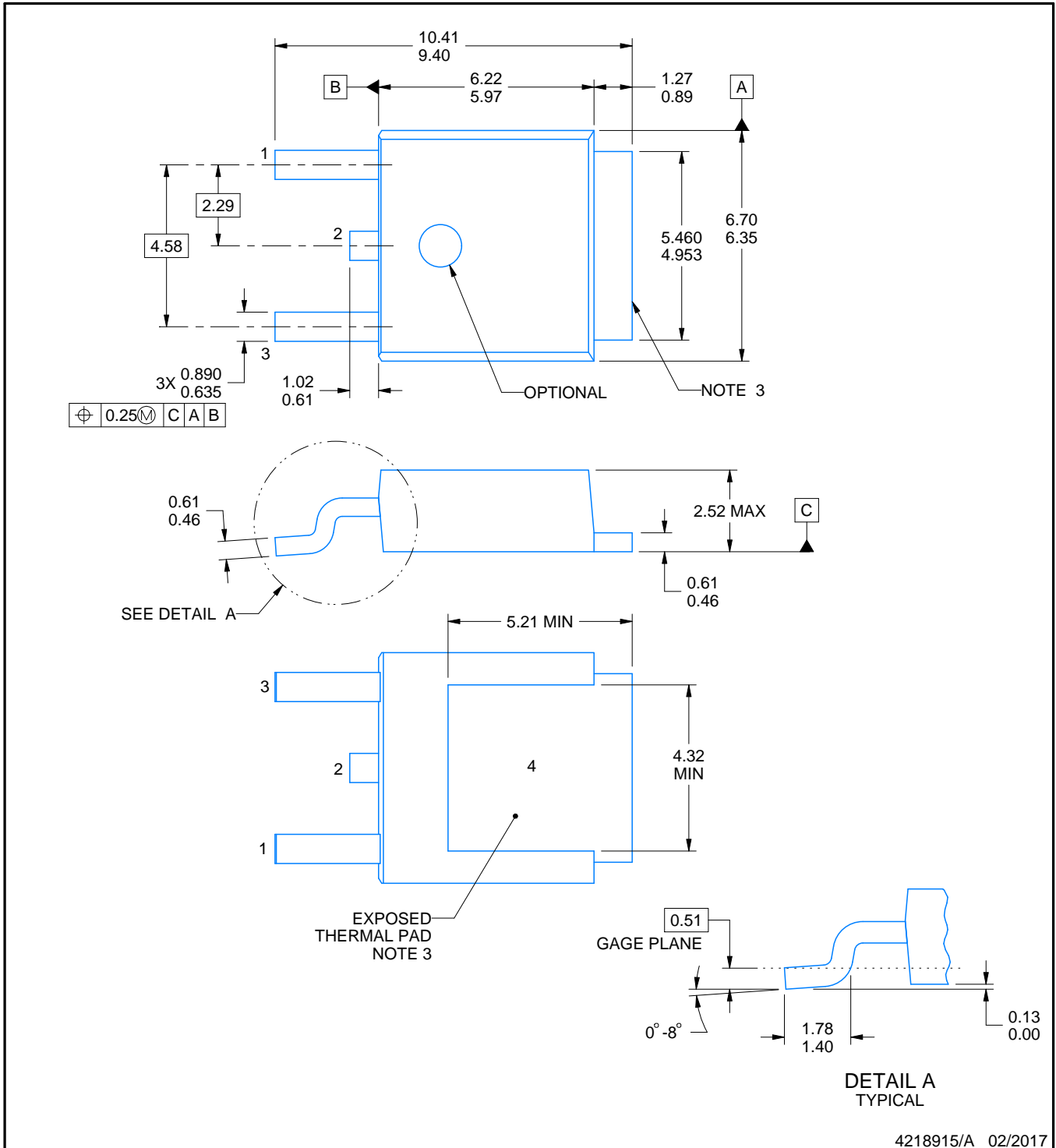

4218915/A 02/2017

#### NOTES:

1. All linear dimensions are in millimeters. Any dimensions in parenthesis are for reference only. Dimensioning and tolerancing per ASME Y14.5M.
2. This drawing is subject to change without notice.
3. Shape may vary per different assembly sites.
4. Reference JEDEC registration TO-252.



# EXAMPLE STENCIL DESIGN

KVU0003A

TO-252 - 2.52 mm max height

TO-252

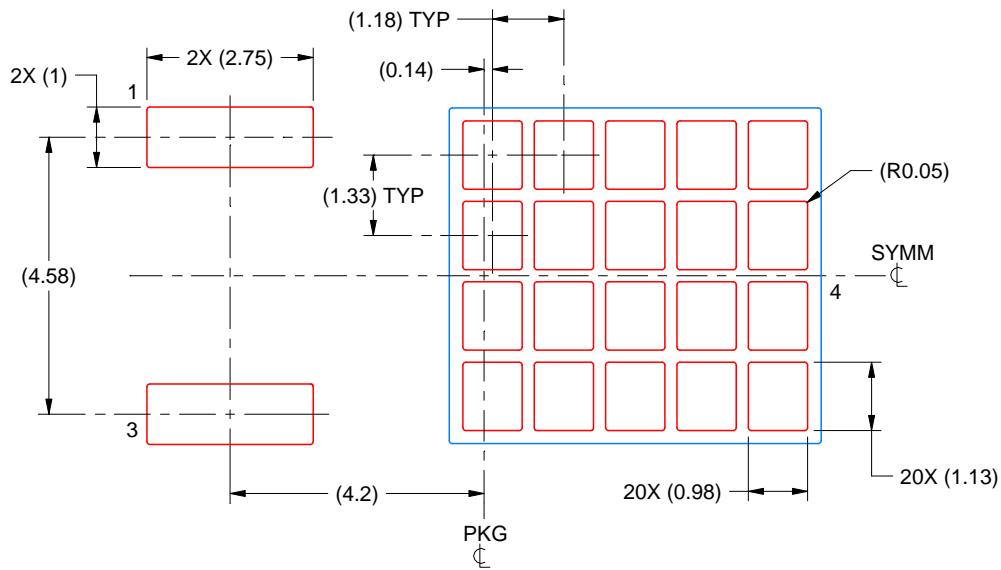

SOLDER PASTE EXAMPLE  
BASED ON 0.125 mm THICK STENCIL

EXPOSED PAD  
65% PRINTED SOLDER COVERAGE BY AREA  
SCALE:8X

4218915/A 02/2017

NOTES: (continued)

7. Laser cutting apertures with trapezoidal walls and rounded corners may offer better paste release. IPC-7525 may have alternate design recommendations.
8. Board assembly site may have different recommendations for stencil design.

DCY (R-PDSO-G4)

PLASTIC SMALL-OUTLINE

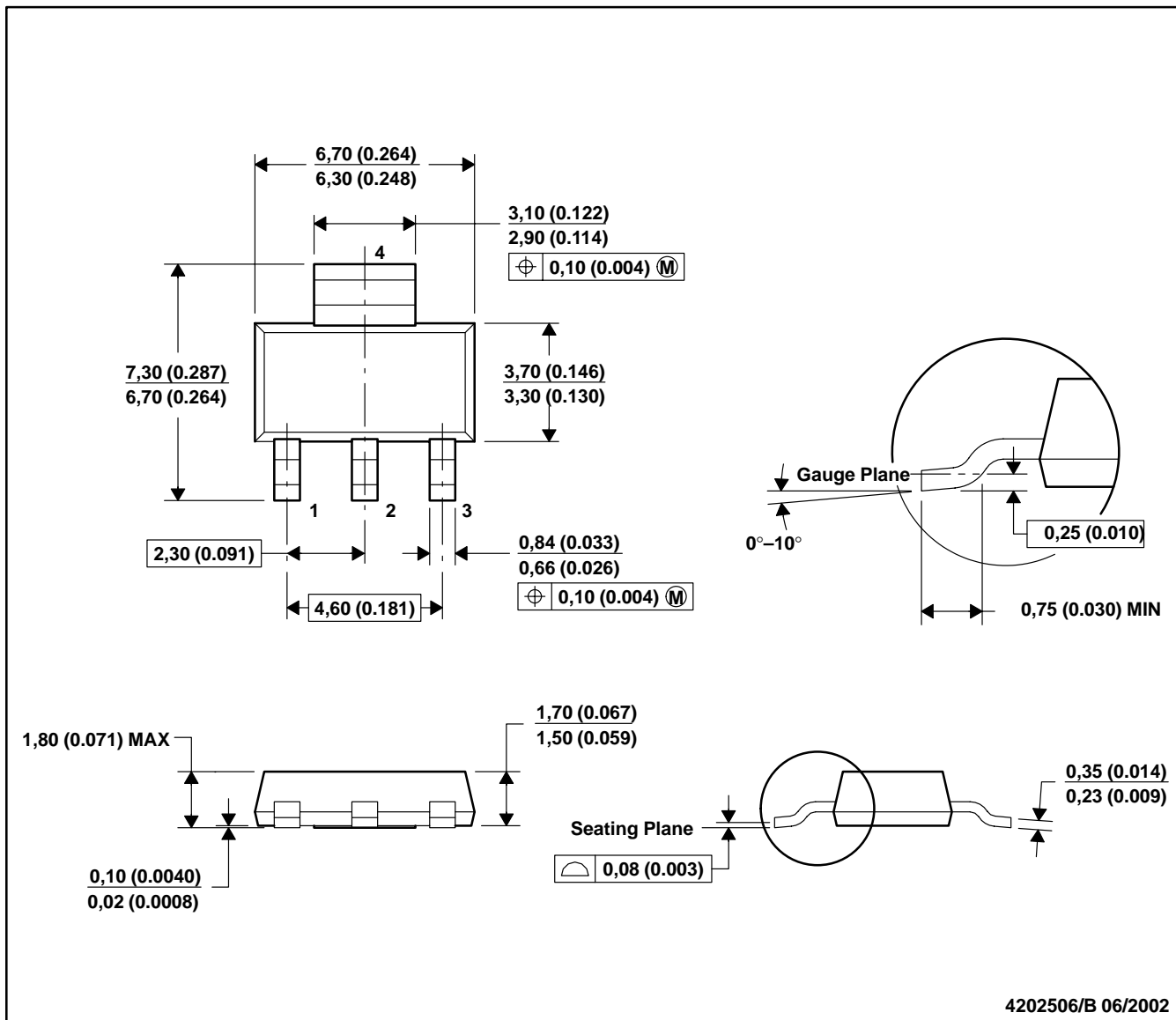

- NOTES: A. All linear dimensions are in millimeters (inches).  
 B. This drawing is subject to change without notice.  
 C. Body dimensions do not include mold flash or protrusion.  
 D. Falls within JEDEC TO-261 Variation AA.

DCY (R-PDSO-G4)

PLASTIC SMALL OUTLINE

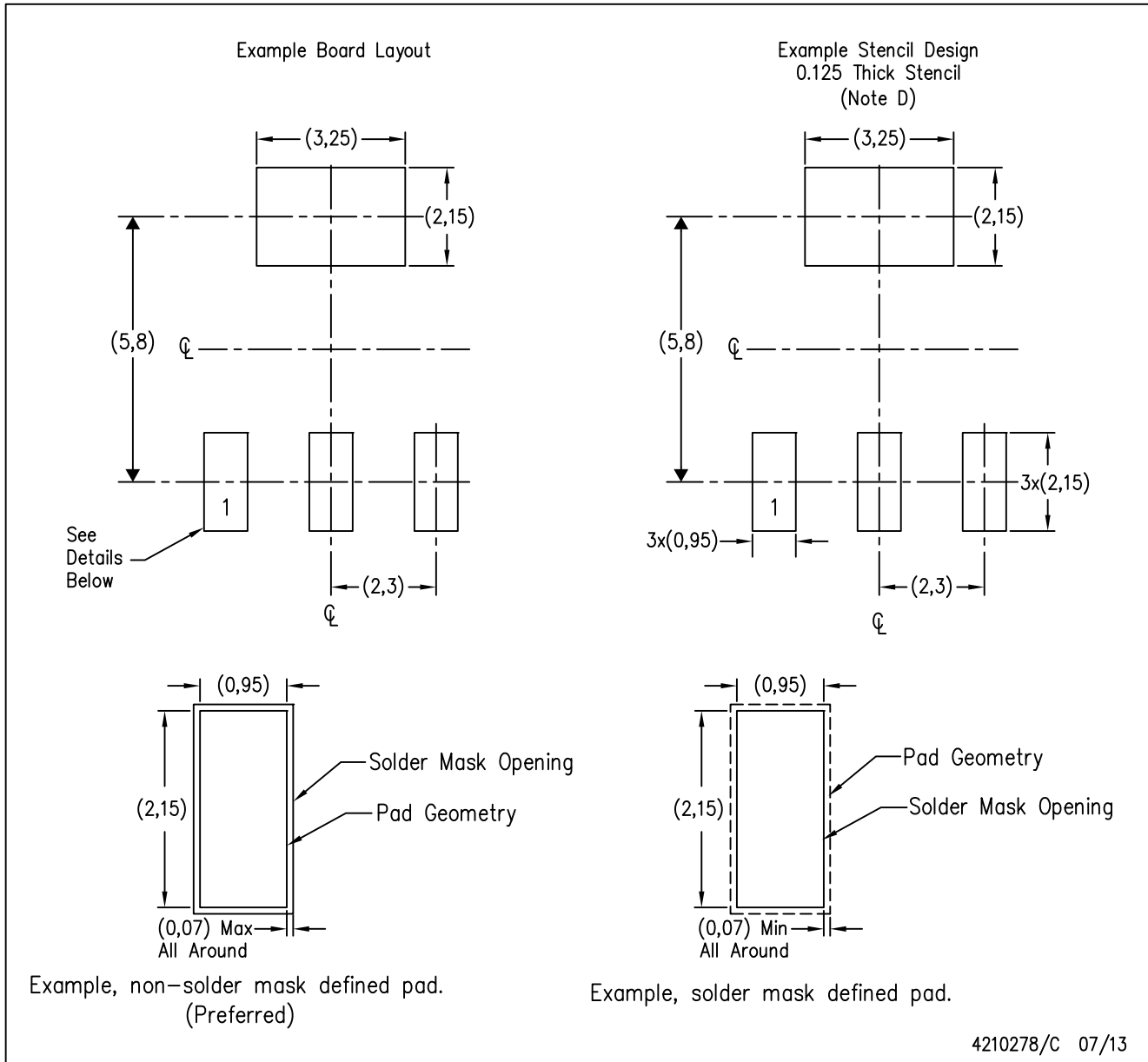

- NOTES:
- A. All linear dimensions are in millimeters.
  - B. This drawing is subject to change without notice.
  - C. Publication IPC-7351 is recommended for alternate designs.
  - D. Laser cutting apertures with trapezoidal walls and also rounding corners will offer better paste release. Customers should contact their board assembly site for stencil recommendations. Refer to IPC 7525 for stencil design considerations.

# KCS0003B

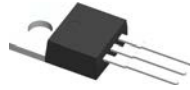

# PACKAGE OUTLINE

TO-220 - 19.65 mm max height

TO-220

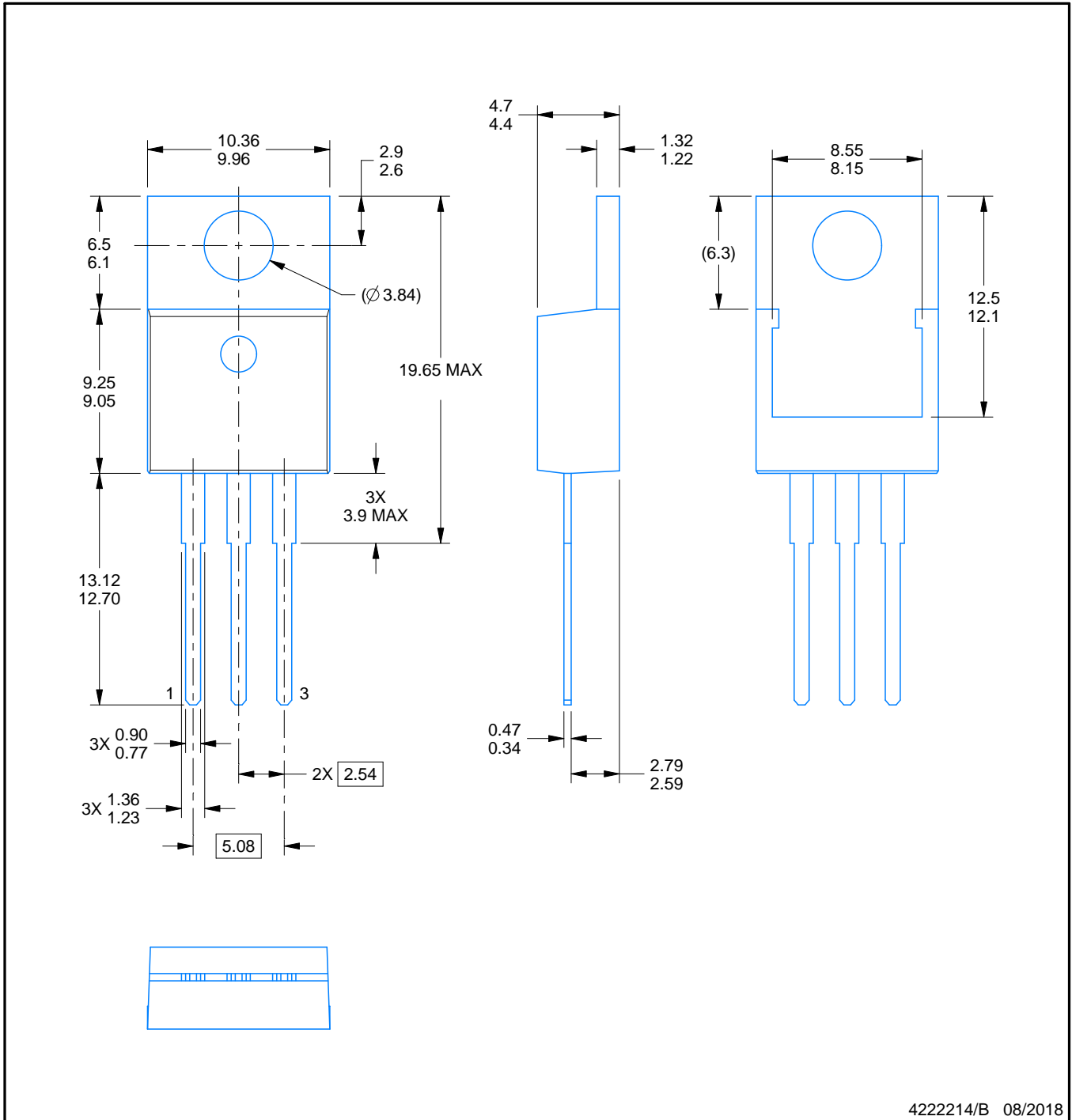

4222214/B 08/2018

**NOTES:**

- 1. Dimensions are in millimeters. Any dimension in brackets or parenthesis are for reference only. Dimensioning and tolerancing per ASME Y14.5M.
- 2. This drawing is subject to change without notice.
- 3. Reference JEDEC registration TO-220.

# EXAMPLE BOARD LAYOUT

KCS0003B

TO-220 - 19.65 mm max height

TO-220

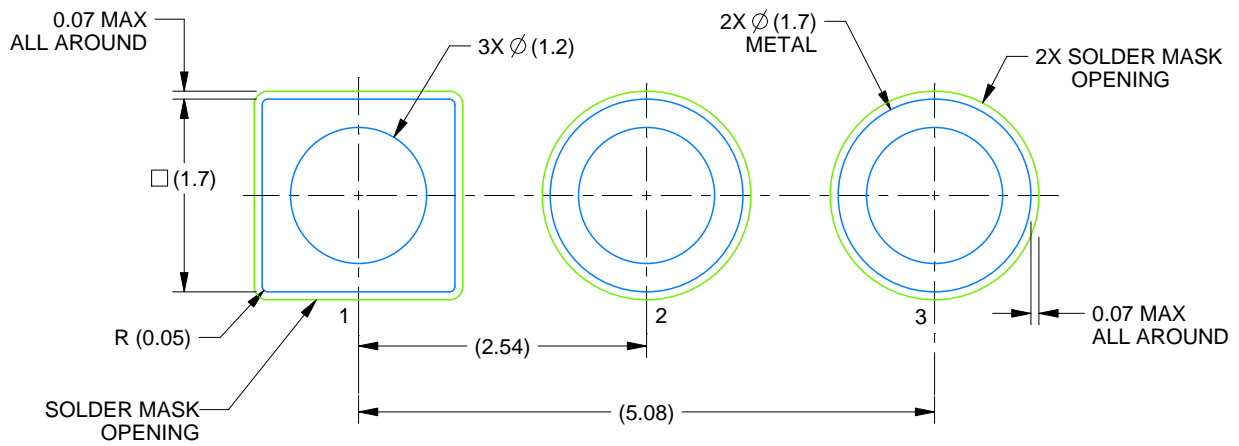

LAND PATTERN EXAMPLE  
NON-SOLDER MASK DEFINED  
SCALE:15X

4222214/B 08/2018

## 重要通知和免责声明

TI“按原样”提供技术和可靠性数据（包括数据表）、设计资源（包括参考设计）、应用或其他设计建议、网络工具、安全信息和其他资源，不保证没有瑕疵且不做任何明示或暗示的担保，包括但不限于对适销性、与某特定用途的适用性或不侵犯任何第三方知识产权的暗示担保。

这些资源可供使用 TI 产品进行设计的熟练开发人员使用。您将自行承担以下全部责任：(1) 针对您的应用选择合适的 TI 产品，(2) 设计、验证并测试您的应用，(3) 确保您的应用满足相应标准以及任何其他安全、安保法规或其他要求。

这些资源如有变更，恕不另行通知。TI 授权您仅可将这些资源用于研发本资源所述的 TI 产品的相关应用。严禁以其他方式对这些资源进行复制或展示。您无权使用任何其他 TI 知识产权或任何第三方知识产权。对于因您对这些资源的使用而对 TI 及其代表造成的任何索赔、损害、成本、损失和债务，您将全额赔偿，TI 对此概不负责。

TI 提供的产品受 [TI 销售条款](#)、[TI 通用质量指南](#) 或 [ti.com](#) 上其他适用条款或 TI 产品随附的其他适用条款的约束。TI 提供这些资源并不会扩展或以其他方式更改 TI 针对 TI 产品发布的适用的担保或担保免责声明。除非德州仪器 (TI) 明确将某产品指定为定制产品或客户特定产品，否则其产品均为按确定价格收入目录的标准通用器件。

TI 反对并拒绝您可能提出的任何其他或不同的条款。

版权所有 © 2026，德州仪器 (TI) 公司

最后更新日期：2025 年 10 月