

TLV703x-Q1 和 TLV704x-Q1 轨至轨低功耗比较器

1 特性

- 符合汽车应用要求
- 具有符合 AEC-Q100 标准的下列特性：
 - 器件温度等级 1：-40°C 至 125°C 环境温度范围
 - 器件 HBM ESD 分类等级 2
 - 器件 CDM ESD 分类等级 C5
- 1.6V 至 6.5V 的宽电源电压范围
- 315nA 静态电源电流
- 3μs 低传播延迟
- 6.5mV 的内部迟滞
- 轨到轨共模输入电压
- 内部上电复位提供已知启动条件
- 过驱动输入无相位反转
- 推挽输出 (TLV703x-Q1)
- 开漏输出 (TLV704x-Q1)
- 40°C 至 125°C 工作温度
- 提供功能安全
 - 可帮助进行功能安全系统设计的文档 (TLV70x1-Q1)
 - 可帮助进行功能安全系统设计的文档 (TLV70x2-Q1)

2 应用

- 远程信息处理 eCall
- 汽车音响主机
- 仪表组
- 音频放大器
- 车载充电器 (OBC) 和无线充电器

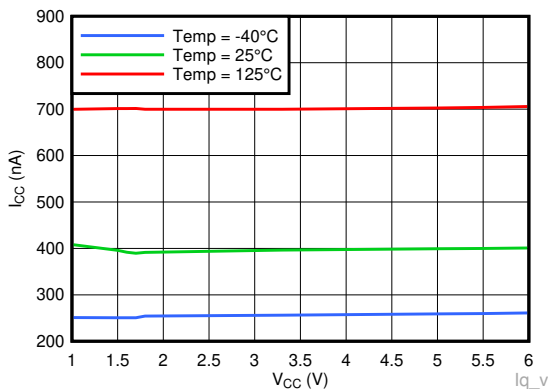

I_{CC} 与 V_{CC} 间的关系

3 说明

TLV703x-Q1/TLV704x-Q1 是具有轨至轨输入的低电压毫微功耗比较器。这两款比较器适用于空间关键型和功耗敏感型设计，如信息娱乐系统、远程信息处理和音响主机应用。

TLV703x-Q1 和 TLV704x-Q1 集出色的低功耗和高速度于一体。得益于毫微功耗下的快速响应优势，功耗敏感型系统能够监测故障状况并快速做出响应。这两款比较器的工作电压范围为 1.6V 至 6.5V，因此可与 1.8V、3V 和 5V 系统兼容。

TLV703x-Q1 和 TLV704x-Q1 还凭借过驱输入和内部迟滞来确保不会出现输出相位反转，因此工程师可以将此系列的比较器用在必须将慢速输入信号转换为纯净数字输出的严苛、嘈杂环境中进行精密电压监测。

TLV703x-Q1 具有推挽式输出级，能够灌/拉毫安级电流。TLV704x-Q1 具有可上拉到 V_{CC} 之上的漏极开路输出级。

器件信息

器件型号	封装 (引脚) ⁽¹⁾	封装尺寸 (标称值)
TLV7031-Q1、 TLV7041-Q1	SC70 (5)	2.00mm × 1.25mm
	SOT-23 (5)	2.90mm × 1.60mm
TLV7032-Q1、 TLV7042-Q1	VSSOP (8)	3.00mm × 3.00mm
	SOT-23 (8)	2.90mm × 1.60mm
TLV7034-Q1、 TLV7044-Q1	TSSOP (14)	4.40mm × 5.00mm

(1) 要了解所有可用封装，请见数据表末尾的可订购产品附录。

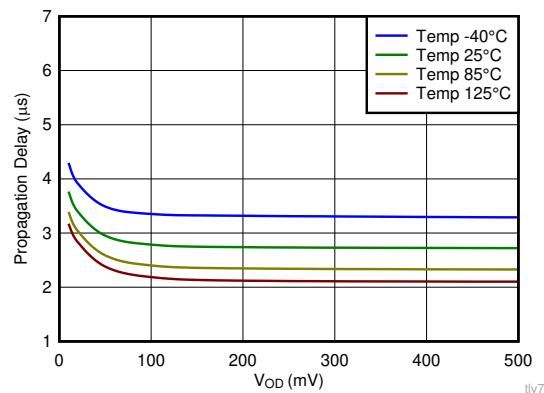

传播延迟与输入过驱之间的关系



Table of Contents

1 特性	1	7 Detailed Description	16
2 应用	1	7.1 Overview.....	16
3 说明	1	7.2 Functional Block Diagram.....	16
4 Revision History	2	7.3 Feature Description.....	16
5 Pin Configuration and Functions	3	7.4 Device Functional Modes.....	16
Pin Functions: TLV7032/42.....	4	8 Application and Implementation	18
5.1 Pin Functions: TLV7034/44.....	5	8.1 Application Information.....	18
6 Specifications	6	8.2 Typical Applications.....	21
6.1 Absolute Maximum Ratings.....	6	9 Power Supply Recommendations	26
6.2 ESD Ratings.....	6	10 Layout	27
6.3 Recommended Operating Conditions.....	6	10.1 Layout Guidelines.....	27
6.4 Thermal Information (Single).....	6	10.2 Layout Example.....	27
6.5 Thermal Information (Dual).....	7	11 Device and Documentation Support	28
6.6 Thermal Information (Quad).....	7	11.1 Device Support.....	28
6.7 Electrical Characteristics.....	8	11.2 接收文档更新通知.....	28
6.8 Switching Characteristics.....	8	11.3 支持资源.....	28
6.9 Electrical Characteristics (Dual).....	9	11.4 Trademarks.....	28
6.10 Switching Characteristics (Dual).....	9	11.5 静电放电警告.....	28
6.11 Electrical Characteristics (Quad).....	10	11.6 术语表.....	28
6.12 Switching Characteristics (Quad).....	10	12 Mechanical, Packaging, and Orderable Information	28
6.13 Timing Diagrams.....	11		
6.14 Typical Characteristics.....	12		

4 Revision History

注：以前版本的页码可能与当前版本的页码不同

Changes from Revision C (October 2021) to Revision D (February 2023)	Page
• 删除 TLV7032-Q1 和 TLV7042-Q1 的 SOT-23 (8) 封装选项中的预发布说明.....	1
Changes from Revision B (February 2021) to Revision C (October 2021)	Page
• 在“特性”部分添加了新的“时基故障率报告”链接.....	1
Changes from Revision A (October 2020) to Revision B (February 2021)	Page
• 在整个文档中添加了双列封装和方形封装选项.....	1
Changes from Revision * (May 2020) to Revision A (October 2020)	Page
• 更新了整个文档中的表格、图和交叉参考的编号格式.....	1
• APL 到 RTM 发布.....	1

5 Pin Configuration and Functions



图 5-1. DBV, DCK Packages
 5-Pin SOT-23, SC70
 Top View

表 5-1. Pin Functions

PIN		I/O (1)	DESCRIPTION
SOT-23, SC70	NAME		
1	OUT	O	Output
5	V _{CC}	P	Positive (highest) power supply
2	V _{EE}	P	Negative (lowest) power supply
4	IN -	I	Inverting input
3	IN+	I	Noninverting input

(1) I = Input, O = Output, P = Power

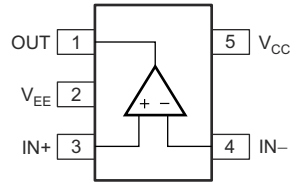
Pin Functions: TLV7032/42

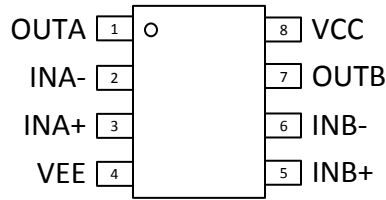

**图 5-2. TLV7032/42 DGK, DDF Packages
8-Pin VSSOP, SOT-23
Top View**

表 5-2. Pin Functions: TLV7032/42

PIN		I/O	DESCRIPTION
NAME	NO.		
INA -	2	I	Inverting input, channel A
INA+	3	I	Noninverting input, channel A
INB -	6	I	Inverting input, channel B
INB+	5	I	Noninverting input, channel B
OUTA	1	O	Output, channel A
OUTB	7	O	Output, channel B
VEE	4	—	Negative (lowest) supply or ground (for single-supply operation)
VCC	8	—	Positive (highest) supply

5.1 Pin Functions: TLV7034/44

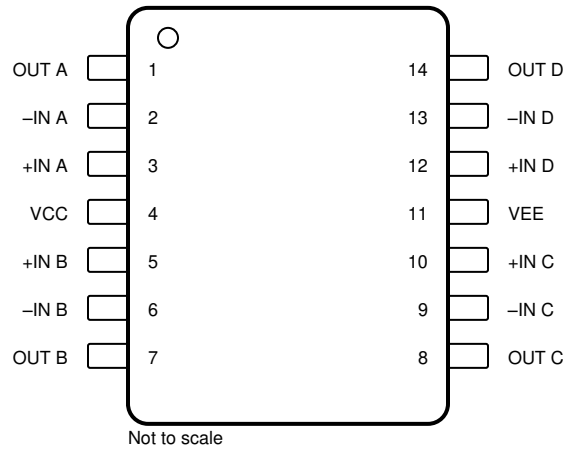

**图 5-3. TLV7034/44 PW Packages
14-Pin TSSOP
Top View**

表 5-3. Pin Functions: TLV7034/44

PIN		I/O	DESCRIPTION
NAME	TSSOP		
- IN1 A	2	I	Inverting input, channel A
+IN A	3	I	Noninverting input, channel A
- IN B	6	I	Inverting input, channel B
+IN B	5	I	Noninverting input, channel B
- IN C	9	I	Inverting input, channel C
+IN C	10	I	Noninverting input, channel C
- IN D	13	I	Inverting input, channel D
+IN D	12	I	Noninverting input, channel D
NC	—	—	No internal connection
OUT A	1	O	Output, channel A
OUT B	7	O	Output, channel B
OUT C	8	O	Output, channel C
OUT D	14	O	Output, channel D
VEE	11	—	Negative (lowest) supply or ground (for single-supply operation)
VCC	4	—	Positive (highest) supply

6 Specifications

6.1 Absolute Maximum Ratings

over operating free-air temperature range (unless otherwise noted)⁽¹⁾

	MIN	MAX	UNIT
Supply voltage $V_S = V_{CC} - V_{EE}$	- 0.3	7	V
Input pins (IN+, IN -) ⁽²⁾	$V_{EE} - 0.3$	7	V
Output (OUT) (push-pull) ⁽³⁾	$V_{EE} - 0.3$	$V_{CC} + 0.3$	V
Output (OUT) (open-drain)	$V_{EE} - 0.3$	7	V
Output short-circuit duration ⁽⁴⁾		10	s
Junction temperature, T_J		150	°C
Storage temperature, T_{stg}	- 65	150	°C

- (1) Stresses beyond those listed under *Absolute Maximum Ratings* may cause permanent damage to the device. These are stress ratings only, which do not imply functional operation of the device at these or any other conditions beyond those indicated under *Recommended Operating Conditions*. Exposure to absolute-maximum-rated conditions for extended periods may affect device reliability.
- (2) Input terminals are diode-clamped to V_{EE} . Input signals that can swing 0.3V below V_{EE} must be current-limited to 10mA or less
- (3) Output maximum is ($V_{CC} + 0.3$ V) or 7 V, whichever is less.
- (4) Short-circuit to ground, one comparator per package.

6.2 ESD Ratings

			VALUE	UNIT
$V_{(ESD)}$	Electrostatic discharge	Human-body model (HBM), per AEC Q100-002 ⁽¹⁾	±2000	V
		Charged-device model (CDM), per AEC Q100-011	±1000	

- (1) AEC Q100-002 indicates that HBM stressing shall be in accordance with the ANSI/ESDA/JEDEC JS-001 specification.

6.3 Recommended Operating Conditions

over operating free-air temperature range (unless otherwise noted)

	MIN	MAX	UNIT
Supply voltage $V_S = V_{CC} - V_{EE}$	1.6	6.5	V
Input voltage range	$V_{EE} - 0.1$	$V_{CC} + 0.1$	V
Ambient temperature, T_A	- 40	125	°C

6.4 Thermal Information (Single)

THERMAL METRIC ⁽¹⁾		TLV7031/TLV7041		UNIT
		DBV (SOT-23)	DCK (SC70)	
		5 PINS	5 PINS	
$R_{\theta JA}$	Junction-to-ambient thermal resistance	297.2	278.8	°C/W
$R_{\theta JC(top)}$	Junction-to-case (top) thermal resistance	224.7	186.6	°C/W
$R_{\theta JB}$	Junction-to-board thermal resistance	200.1	113.2	°C/W
Ψ_{JT}	Junction-to-top characterization parameter	141.2	82.3	°C/W
Ψ_{JB}	Junction-to-board characterization parameter	198.9	112.4	°C/W
$R_{\theta JC(bot)}$	Junction-to-case (bottom) thermal resistance	N/A	N/A	°C/W

- (1) For more information about traditional and new thermal metrics, see the [Semiconductor and IC Package Thermal Metrics](#) application report.

6.5 Thermal Information (Dual)

THERMAL METRIC ⁽¹⁾		TLV7032/TLV7042		UNIT
		DGK (VSSOP)	DDF (SOT-23)	
		8 PINS	8 PINS	
$R_{\theta JA}$	Junction-to-ambient thermal resistance	211.7	212.5	°C/W
$R_{\theta JC(top)}$	Junction-to-case (top) thermal resistance	96.1	127.3	°C/W
$R_{\theta JB}$	Junction-to-board thermal resistance	133.5	129.2	°C/W
Ψ_{JT}	Junction-to-top characterization parameter	28.3	25.8	°C/W
Ψ_{JB}	Junction-to-board characterization parameter	131.7	129.0	°C/W
$R_{\theta JC(bot)}$	Junction-to-case (bottom) thermal resistance	N/A	N/A	°C/W

(1) For more information about traditional and new thermal metrics, see the [Semiconductor and IC Package Thermal Metrics](#) application report.

6.6 Thermal Information (Quad)

THERMAL METRIC ⁽¹⁾		TLV7034/44		UNIT
		RTE (QFN)	PW (TSSOP)	
		16 PINS	14 PINS	
$R_{\theta JA}$	Junction-to-ambient thermal resistance	65.4	131.0	°C/W
$R_{\theta JC(top)}$	Junction-to-case (top) thermal resistance	70.2	60.5	°C/W
$R_{\theta JB}$	Junction-to-board thermal resistance	40.5	74.1	°C/W
Ψ_{JT}	Junction-to-top characterization parameter	5.6	12.6	°C/W
Ψ_{JB}	Junction-to-board characterization parameter	40.5	73.5	°C/W
$R_{\theta JC(bot)}$	Junction-to-case (bottom) thermal resistance	24.1	n/a	°C/W

(1) For more information about traditional and new thermal metrics, see the [Semiconductor and IC Package Thermal Metrics](#) application report.

6.7 Electrical Characteristics

$V_S = 1.8\text{ V to }5\text{ V}$, $V_{CM} = V_S / 2$; minimum and maximum values are at $T_A = -40^\circ\text{C to }+125^\circ\text{C}$ (unless otherwise noted).
 Typical values are at $T_A = 25^\circ\text{C}$.

PARAMETER		TEST CONDITIONS	MIN	TYP	MAX	UNIT
V_{IO}	Input Offset Voltage	$V_S = 1.8\text{ V and }5\text{ V}$, $V_{CM} = V_S / 2$		± 0.1	± 8	mV
V_{HYS}	Hysteresis	$V_S = 1.8\text{ V and }5\text{ V}$, $V_{CM} = V_S / 2$, $T_A = 25^\circ\text{C}$	2	6.5	17	mV
V_{CM}	Common-mode voltage range		V_{EE}		$V_{CC} + 0.1$	V
I_B	Input bias current			2		pA
I_{OS}	Input offset current			1		pA
V_{OH}	Output voltage high (push-pull only)	$V_S = 5\text{ V}$, $V_{EE} = 0\text{ V}$, $I_O = 3\text{ mA}$	4.65	4.8		V
V_{OL}	Output voltage low	$V_S = 5\text{ V}$, $V_{EE} = 0\text{ V}$, $I_O = 3\text{ mA}$		250	350	mV
I_{LKG}	Output leakage current (open-drain only)	$V_S = 5\text{ V}$, $V_{ID} = +0.1\text{ V}$ (Output High), $V_{PULLUP} = V_{CC}$		100		pA
CMRR	Common-mode rejection ratio	$V_{EE} < V_{CM} < V_{CC}$, $V_S = 5\text{ V}$		73		dB
PSRR	Power supply rejection ratio	$V_S = 1.8\text{ V to }5\text{ V}$, $V_{CM} = V_S / 2$		77		dB
I_{SC}	Short-circuit current	$V_S = 5\text{ V}$, sourcing (push-pull only)		35		mA
		$V_S = 5\text{ V}$, sinking		40		
I_{CC}	Supply current / Channel	$V_S = 1.8\text{ V}$, no load, $V_{ID} = -0.1\text{ V}$ (Output Low)		390	900	nA

6.8 Switching Characteristics

Typical values are at $T_A = 25^\circ\text{C}$, $V_S = 5\text{ V}$, $V_{CM} = V_S / 2$; $C_L = 15\text{ pF}$, input overdrive = 100 mV (unless otherwise noted).

PARAMETER		TEST CONDITIONS	MIN	TYP	MAX	UNIT
t_{PHL}	Propagation delay time, high to-low (RP = 4.99 k Ω open-drain only)	Midpoint of input to midpoint of output, $V_{OD} = 100\text{ mV}$		3		μs
t_{PLH}	Propagation delay time, low-to high (RP = 4.99 k Ω open-drain only)	Midpoint of input to midpoint of output, $V_{OD} = 100\text{ mV}$		3		μs
t_R	Rise time (push-pull only)	Measured from 20% to 80%		4.5		ns
t_F	Fall time	Measured from 20% to 80%		4.5		ns
t_{ON}	Power-up time	During power on, V_{CC} must exceed 1.6V for 200 μs before the output will reflect the input..		200		μs

6.9 Electrical Characteristics (Dual)

$V_S = 1.8\text{ V to }5\text{ V}$, $V_{CM} = V_S / 2$; minimum and maximum values are at $T_A = -40^\circ\text{C to }+125^\circ\text{C}$ (unless otherwise noted). Typical values are at $T_A = 25^\circ\text{C}$.

PARAMETER		TEST CONDITIONS	MIN	TYP	MAX	UNIT
V_{IO}	Input Offset Voltage	$V_S = 1.8\text{ V and }5\text{ V}$, $V_{CM} = V_S / 2$		± 0.1	± 8	mV
V_{HYS}	Hysteresis	$V_S = 1.8\text{ V and }5\text{ V}$, $V_{CM} = V_S / 2$	3	10	25	mV
V_{CM}	Common-mode voltage range		V_{EE}		$V_{CC} + 0.1$	V
I_B	Input bias current			2		pA
I_{OS}	Input offset current			1		pA
V_{OH}	Output voltage high (push-pull only)	$V_S = 5\text{ V}$, $V_{EE} = 0\text{ V}$, $I_O = 3\text{ mA}$	4.65	4.8		V
V_{OL}	Output voltage low	$V_S = 5\text{ V}$, $V_{EE} = 0\text{ V}$, $I_O = 3\text{ mA}$		250	350	mV
I_{LKG}	Output leakage current (open-drain only)	$V_S = 5\text{ V}$, $V_{ID} = +0.1\text{ V}$ (output high), $V_{PULLUP} = V_{CC}$		100		pA
CMRR	Common-mode rejection ratio	$V_{EE} < V_{CM} < V_{CC}$, $V_S = 5\text{ V}$		73		dB
PSRR	Power supply rejection ratio	$V_S = 1.8\text{ V to }5\text{ V}$, $V_{CM} = V_S / 2$		77		dB
I_{SC}	Short-circuit current	$V_S = 5\text{ V}$, sourcing (push-pull only)		29		mA
		$V_S = 5\text{ V}$, sinking		33		
I_{CC}	Supply current / Channel	$V_S = 1.8\text{ V}$, no load, $V_{ID} = -0.1\text{ V}$ (Output Low)		315	750	nA

6.10 Switching Characteristics (Dual)

Typical values are at $T_A = 25^\circ\text{C}$, $V_S = 5\text{ V}$, $V_{CM} = V_S / 2$; $CL = 15\text{ pF}$, input overdrive = 100 mV (unless otherwise noted).

PARAMETER		TEST CONDITIONS	MIN	TYP	MAX	UNIT
t_{PHL}	Propagation delay time, high to-low (RP = 4.99 k Ω open-drain only) ⁽¹⁾	Midpoint of input to midpoint of output, $V_{OD} = 100\text{ mV}$		3		μs
t_{PLH}	Propagation delay time, low-to high (RP = 4.99 k Ω open-drain only) ⁽¹⁾	Midpoint of input to midpoint of output, $V_{OD} = 100\text{ mV}$		3		μs
t_R	Rise time (push-pull only)	Measured from 20% to 80%		4.5		ns
t_F	Fall time	Measured from 20% to 80%		4.5		ns
t_{ON}	Power-up time	During power on, V_{CC} must exceed 1.6V for 200 μs before the output will reflect the input..		200		μs

(1) The lower limit for RP is 650 Ω

6.11 Electrical Characteristics (Quad)

$V_S = 1.8\text{ V to }5\text{ V}$, $V_{CM} = V_S / 2$; minimum and maximum values are at $T_A = -40^\circ\text{C to }+125^\circ\text{C}$ (unless otherwise noted).
 Typical values are at $T_A = 25^\circ\text{C}$.

PARAMETER		TEST CONDITIONS	MIN	TYP	MAX	UNIT
V_{IO}	Input Offset Voltage	$V_S = 1.8\text{ V and }5\text{ V}$, $V_{CM} = V_S / 2$		± 0.1	± 8	mV
V_{HYS}	Hysteresis	$V_S = 1.8\text{ V and }5\text{ V}$, $V_{CM} = V_S / 2$	3	10	25	mV
V_{CM}	Common-mode voltage range		V_{EE}		$V_{CC} + 0.1$	V
I_B	Input bias current			2		pA
I_{OS}	Input offset current			1		pA
V_{OH}	Output voltage high (push-pull only)	$V_S = 5\text{ V}$, $V_{EE} = 0\text{ V}$, $I_O = 3\text{ mA}$	4.65	4.8		V
V_{OL}	Output voltage low	$V_S = 5\text{ V}$, $V_{EE} = 0\text{ V}$, $I_O = 3\text{ mA}$		250	350	mV
I_{LKG}	Output leakage current (open-drain only)	$V_S = 5\text{ V}$, $V_{ID} = +0.1\text{ V}$ (output high), $V_{PULLUP} = V_{CC}$		100		pA
CMRR	Common-mode rejection ratio	$V_{EE} < V_{CM} < V_{CC}$, $V_S = 5\text{ V}$		73		dB
PSRR	Power supply rejection ratio	$V_S = 1.8\text{ V to }5\text{ V}$, $V_{CM} = V_S / 2$		77		dB
I_{SC}	Short-circuit current	$V_S = 5\text{ V}$, sourcing (push-pull only)		29		mA
		$V_S = 5\text{ V}$, sinking		33		
I_{CC}	Supply current / Channel	$V_S = 1.8\text{ V}$, no load, $V_{ID} = -0.1\text{ V}$ (Output Low)		315	750	nA

6.12 Switching Characteristics (Quad)

Typical values are at $T_A = 25^\circ\text{C}$, $V_S = 5\text{ V}$, $V_{CM} = V_S / 2$; $CL = 15\text{ pF}$, input overdrive = 100 mV (unless otherwise noted).

PARAMETER		TEST CONDITIONS	MIN	TYP	MAX	UNIT
t_{PHL}	Propagation delay time, high to low (RP = 4.99 k Ω open-drain only) ⁽¹⁾	Midpoint of input to midpoint of output, $V_{OD} = 100\text{ mV}$		3		μs
t_{PLH}	Propagation delay time, low to high (RP = 4.99 k Ω open-drain only) ⁽¹⁾	Midpoint of input to midpoint of output, $V_{OD} = 100\text{ mV}$		3		μs
t_R	Rise time (push-pull only)	Measured from 20% to 80%		4.5		ns
t_F	Fall time	Measured from 20% to 80%		4.5		ns
t_{ON}	Power-up time	During power on, V_{CC} must exceed 1.6V for t_{ON} before the output will reflect the input..		400		μs

(1) The lower limit for RP is 650 Ω

6.13 Timing Diagrams



图 6-1. Start-Up Time Timing Diagram (IN+ > IN-)



图 6-2. Propagation Delay Timing Diagram

备注

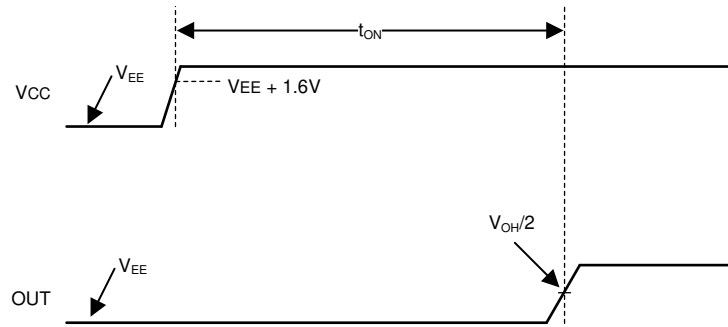
The propagation delays t_{pLH} and t_{pHL} include the contribution of input offset and hysteresis.

6.14 Typical Characteristics

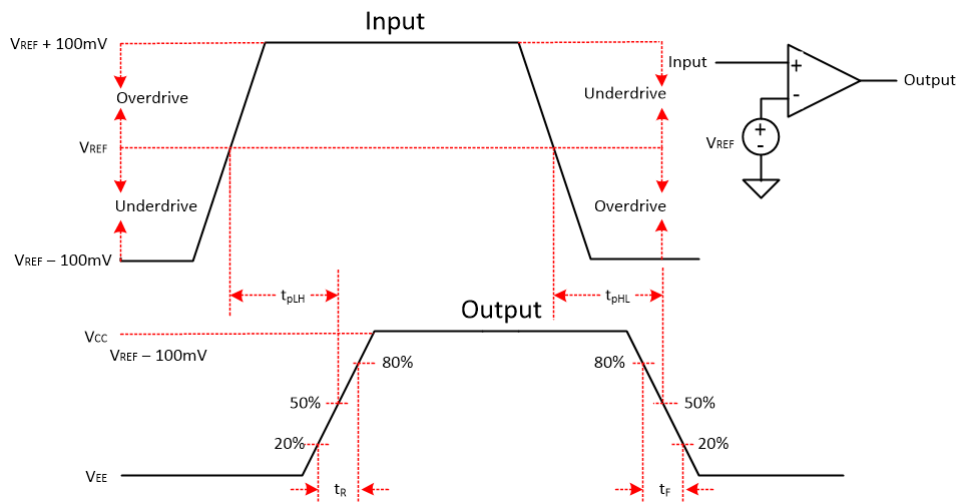
$T_A = 25^\circ\text{C}$, $V_{CC} = 5\text{ V}$, $V_{EE} = 0\text{ V}$, $V_{CM} = V_{CC}/2$, $C_L = 15\text{ pF}$



图 6-3. Input Offset vs Temperature



图 6-4. Input Offset vs Temperature

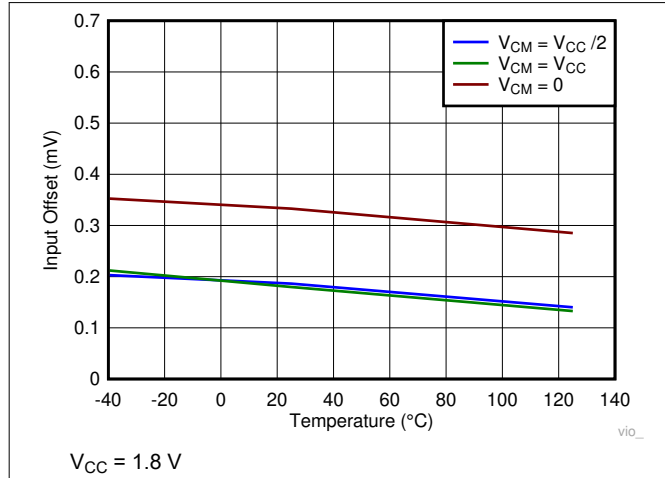

图 6-5. Input Offset vs Temperature

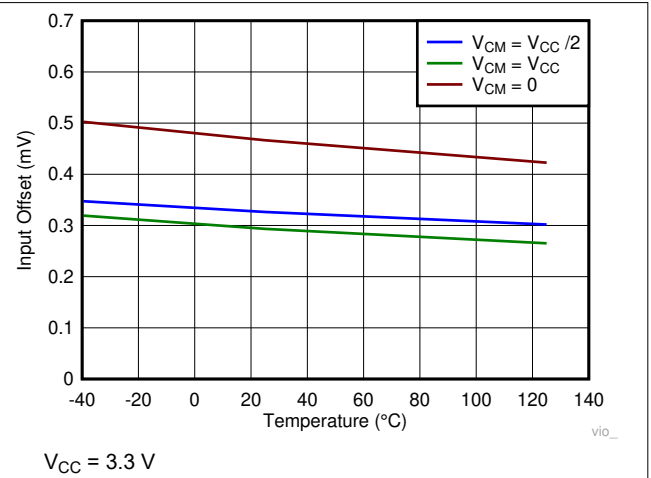

图 6-6. Input Offset Voltage vs V_{CM}

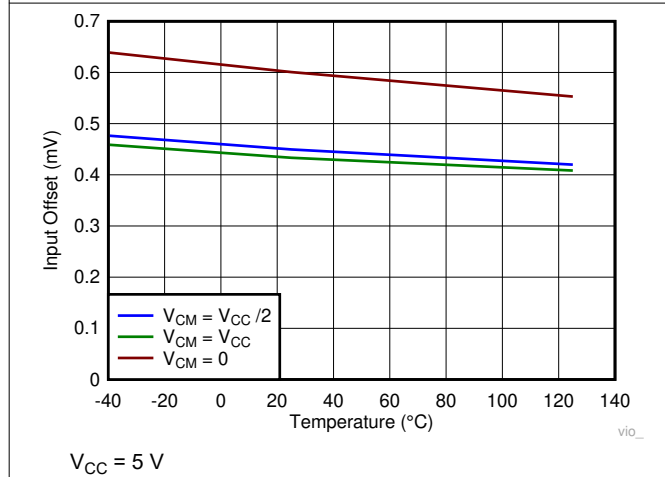

图 6-7. Input Offset Voltage vs V_{CM}

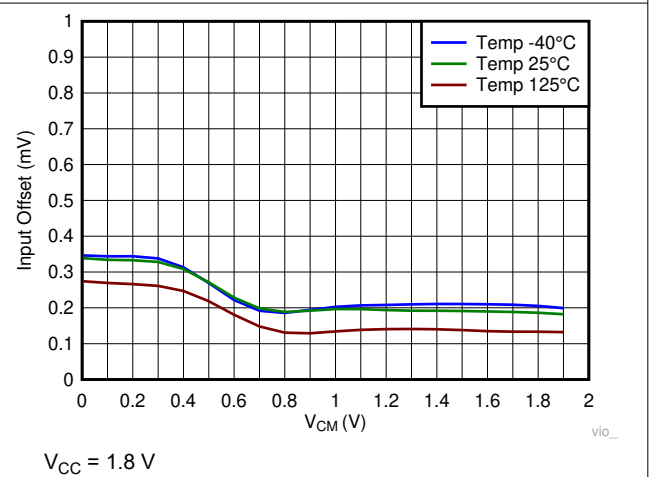

图 6-8. Input Offset Voltage vs V_{CM}

6.14 Typical Characteristics (continued)

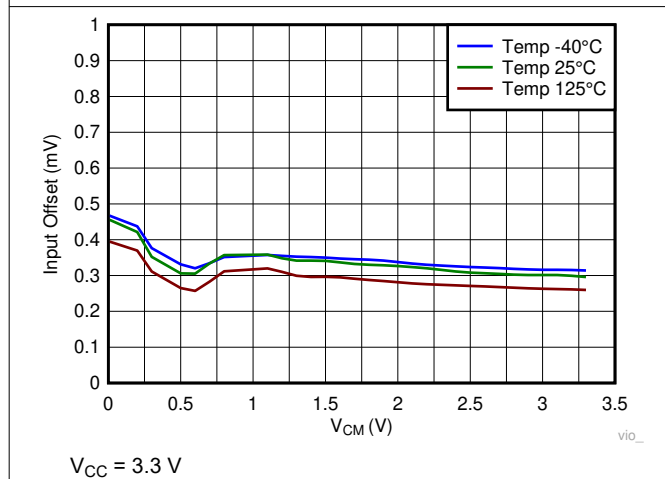
$T_A = 25^\circ\text{C}$, $V_{CC} = 5\text{ V}$, $V_{EE} = 0\text{ V}$, $V_{CM} = V_{CC}/2$, $C_L = 15\text{ pF}$

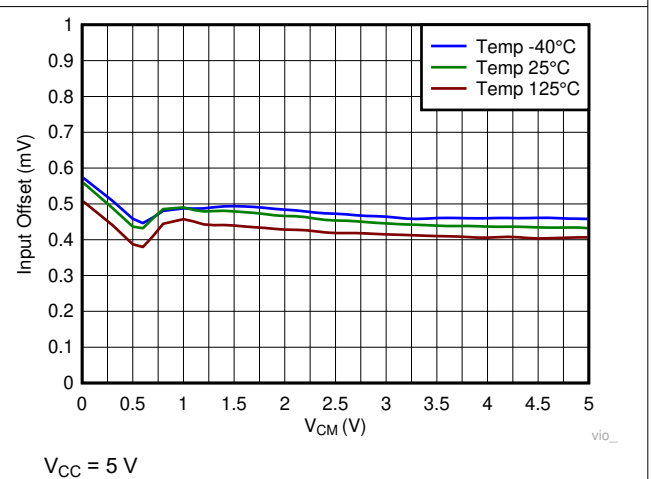

图 6-9. Hysteresis vs Temperature



图 6-10. Hysteresis vs V_{CM}

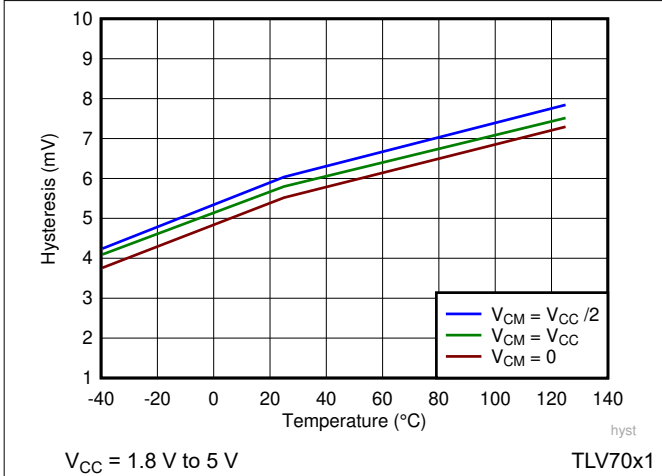

图 6-11. Hysteresis vs V_{CM}

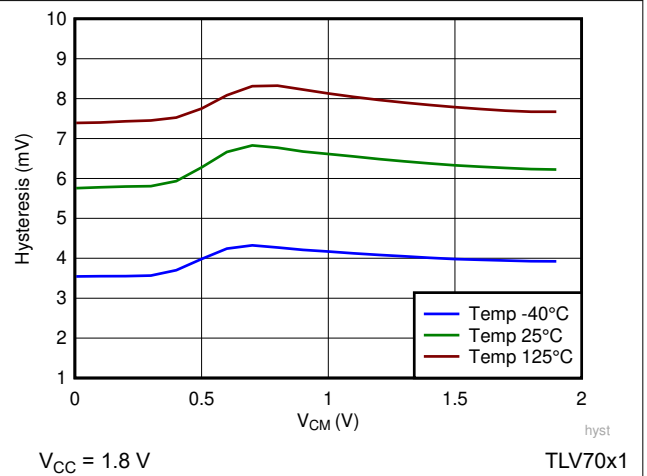

图 6-12. Hysteresis vs V_{CM}

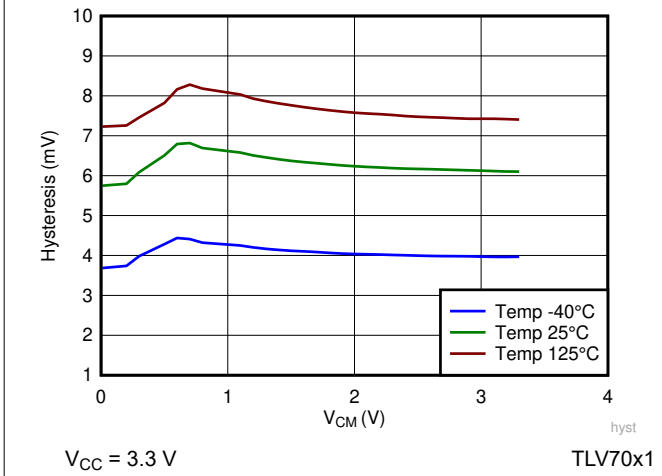

图 6-13. Input Bias Current vs Temperature

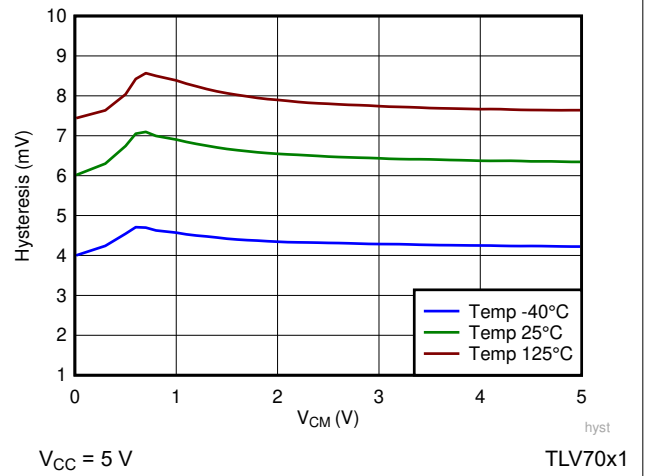

图 6-14. Output Voltage High vs Output Source Current

6.14 Typical Characteristics (continued)

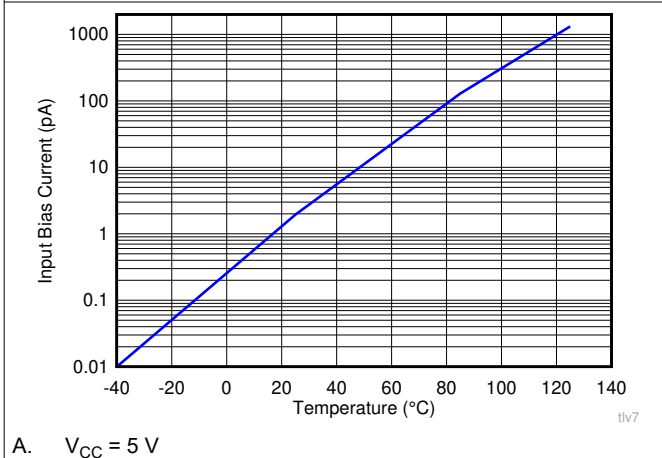
$T_A = 25^\circ\text{C}$, $V_{CC} = 5\text{ V}$, $V_{EE} = 0\text{ V}$, $V_{CM} = V_{CC}/2$, $C_L = 15\text{ pF}$

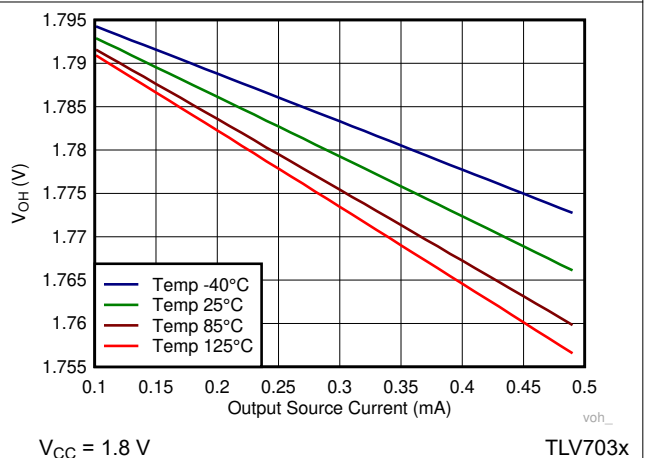

图 6-15. Output Voltage High vs Output Source Current



图 6-16. Output Voltage Low vs Output Sink Current

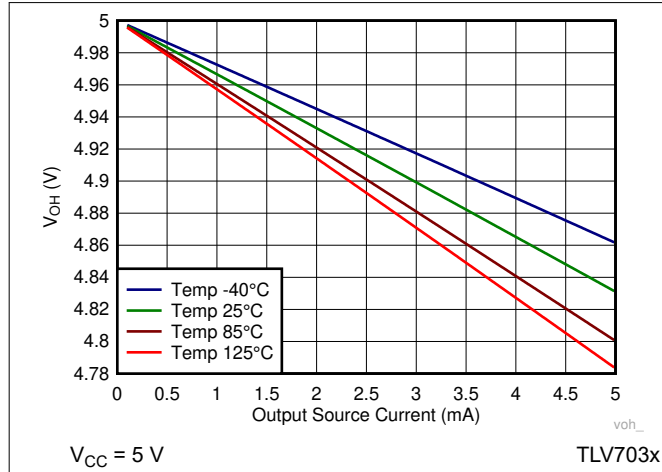

图 6-17. Output Voltage Low vs Output Sink Current

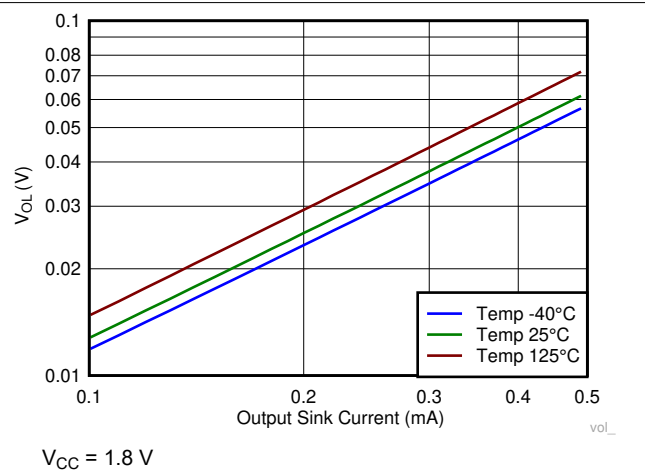

图 6-18. Output Short-Circuit (Sink) Current vs Temperature

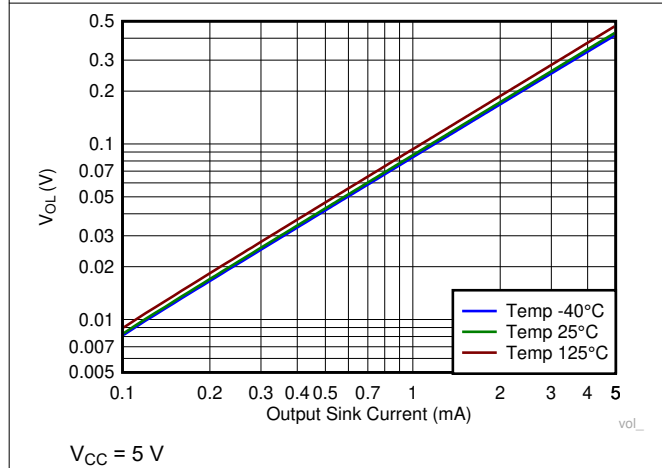

图 6-19. Output Short-Circuit (Source) Current vs Temperature

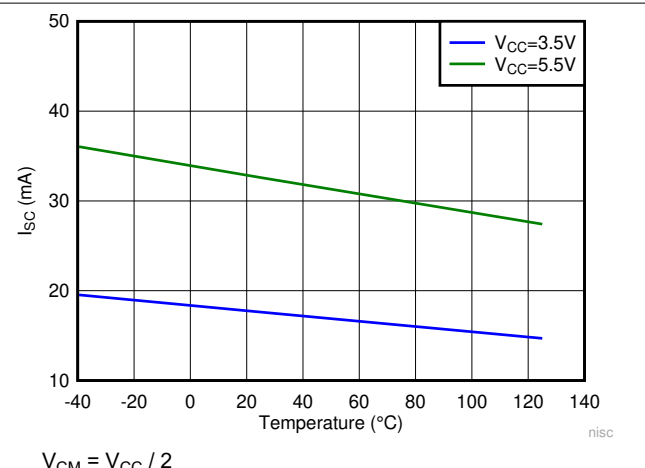

图 6-20. Output Short Circuit (Sink) vs V_{CC}

6.14 Typical Characteristics (continued)

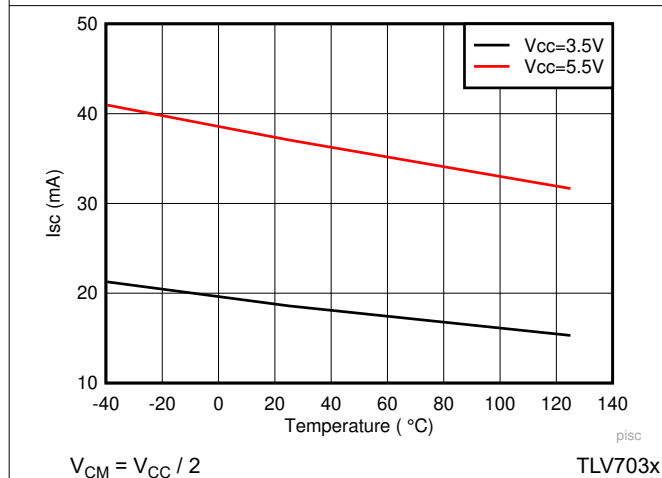
$T_A = 25^\circ\text{C}$, $V_{CC} = 5\text{ V}$, $V_{EE} = 0\text{ V}$, $V_{CM} = V_{CC}/2$, $C_L = 15\text{ pF}$

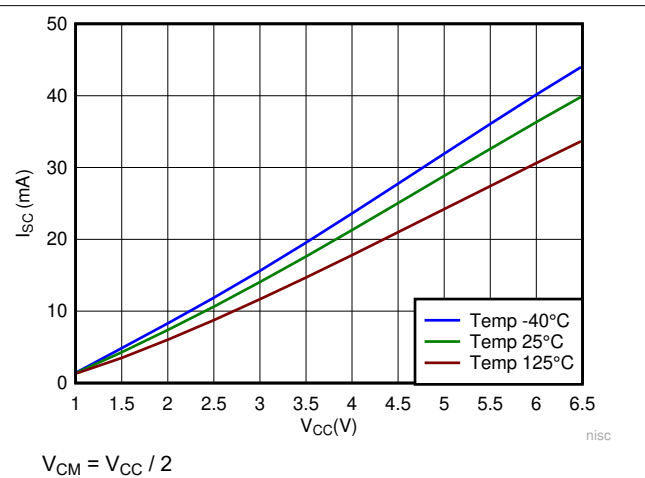

图 6-21. Output Short Circuit (Source) vs V_{CC}



图 6-22. I_{CC} vs Temperature

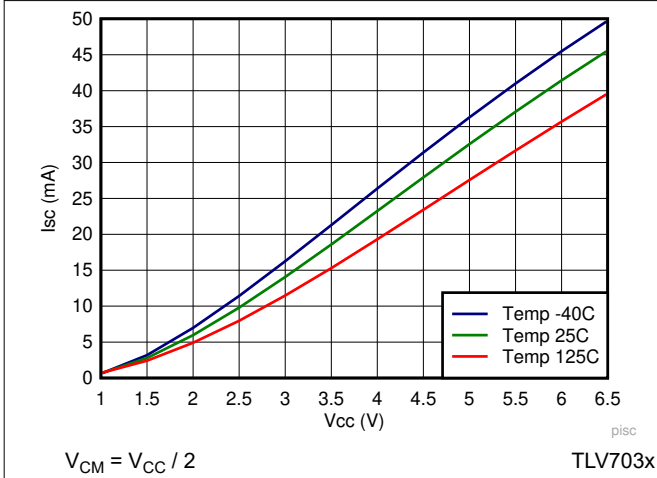

图 6-23. I_{CC} vs V_{CC}

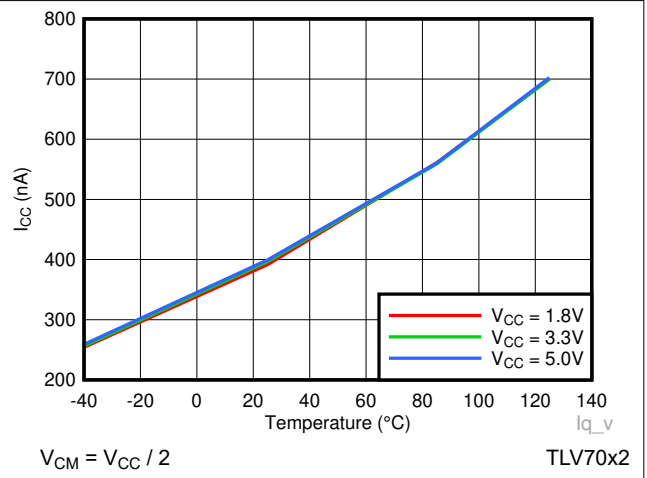

图 6-24. Rise/Fall Time vs Load Capacitance

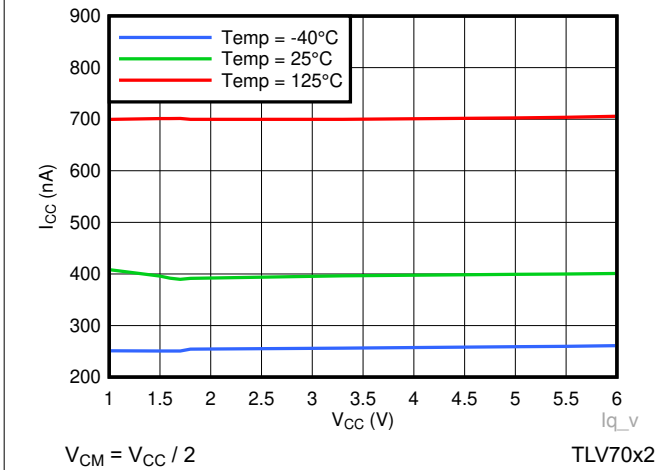

图 6-25. Propagation Delay (L-H) vs Input Overdrive

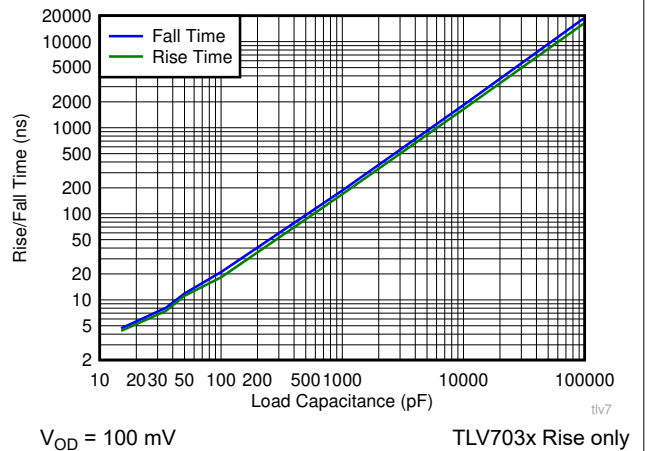

图 6-26. Propagation Delay (H-L) vs Input Overdrive

7 Detailed Description

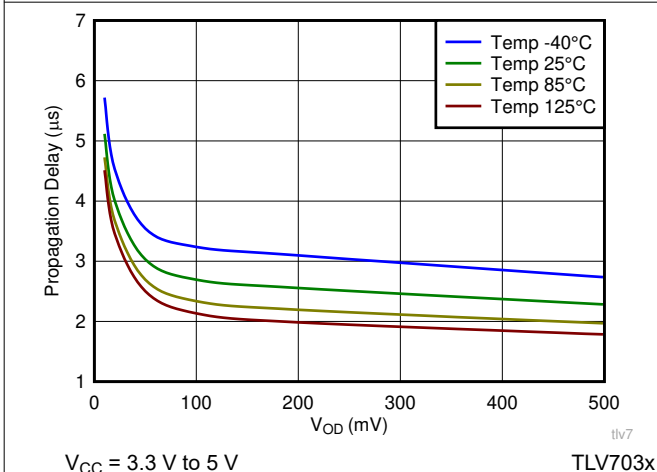
7.1 Overview

The TLV703x-Q1 and TLV704x-Q1 devices are single-channel, nano-power comparators with push-pull and open-drain outputs. Operating from 1.6 V to 6.5 V and consuming only 315 nA, the TLV703x-Q1 and TLV704x-Q1 are designed for portable and industrial applications.

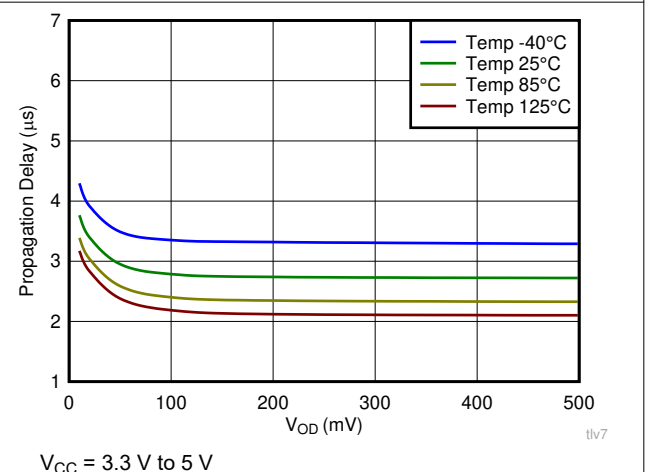
7.2 Functional Block Diagram

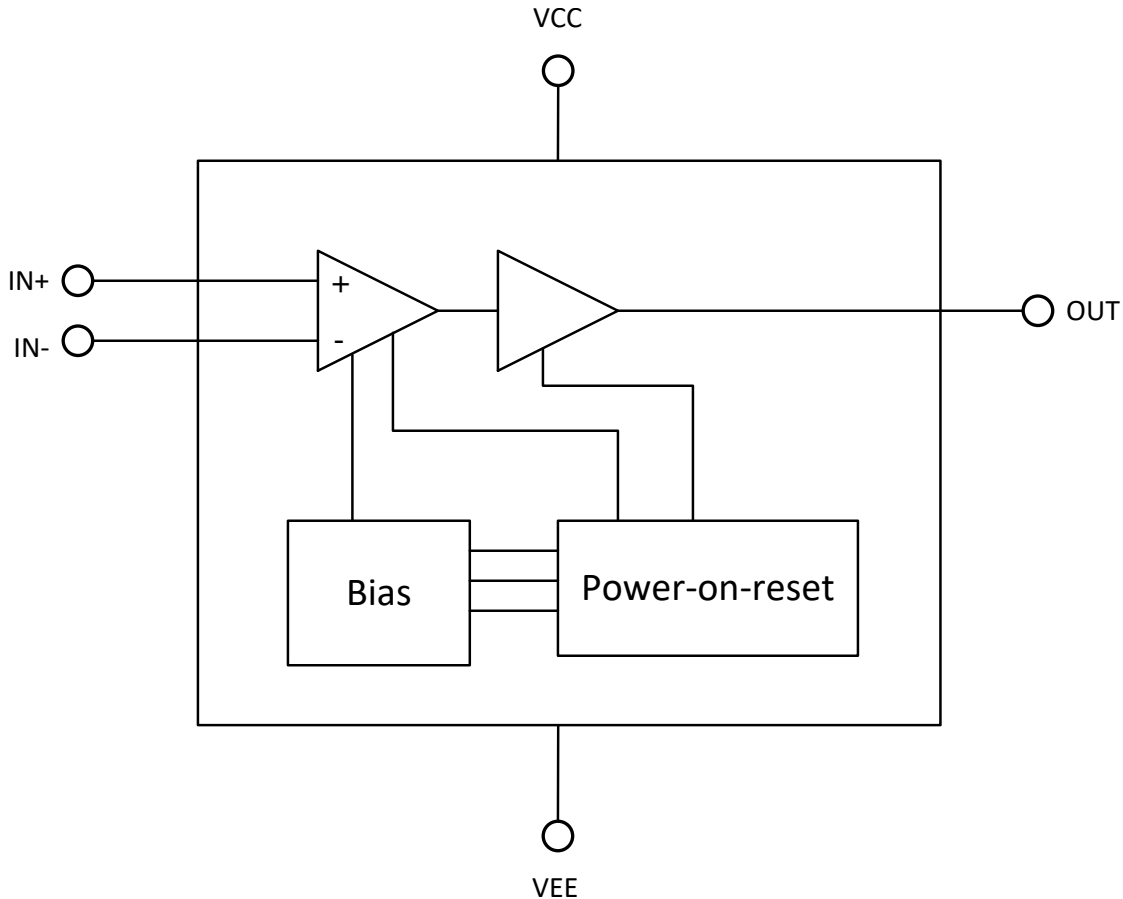

7.3 Feature Description

The TLV703x-Q1 and TLV704x-Q1 comparators are nanopower comparators that are capable of operating at low voltages. The TLV703x-Q1 and TLV704x-Q1 feature a rail-to-rail input stage capable of operating up to 100 mV beyond the V_{CC} power supply rail. The TLV703x-Q1 (push-pull) and TLV704x-Q1 (open-drain) also feature internal hysteresis.

7.4 Device Functional Modes

The TLV703x-Q1 and TLV704x-Q1 have a power-on-reset (POR) circuit. While the power supply (V_S) is less than the minimum supply voltage, either upon ramp-up or ramp-down, the POR circuitry is activated.

For the TLV703x-Q1, the POR circuit holds the output low (at V_{EE}) while activated.

For the TLV704x-Q1, the POR circuit keeps the output high impedance (logical high) while activated.

When the supply voltage is greater than, or equal to, the minimum supply voltage, the comparator output reflects the state of the differential input (V_{ID}).

7.4.1 Inputs

The TLV703x-Q1 and TLV704x-Q1 input common-mode extends from V_{EE} to 100 mV above V_{CC} . The differential input voltage (V_{ID}) can be any voltage within these limits. No phase inversion of the comparator output occurs when the input pins exceed V_{CC} and V_{EE} .

The input of TLV703x-Q1 and TLV704x-Q1 is fault tolerant. It maintains the same high input impedance when V_{CC} is unpowered or ramping up. The input can be safely driven up to the specified maximum voltage (7 V) with $V_{CC} = 0$ V or any value up to the maximum specified. The V_{CC} is isolated from the input such that it maintains its value even when a higher voltage is applied to the input.

The input bias current is typically 1 pA for input voltages between V_{CC} and V_{EE} . The comparator inputs are protected from voltages below V_{EE} by internal diodes connected to V_{EE} . As the input voltage goes under V_{EE} , the protection diodes become forward biased and begin to conduct causing the input bias current to increase exponentially. Input bias current typically doubles every 10°C temperature increases.

7.4.2 Internal Hysteresis

The device hysteresis transfer curve is shown in [图 7-1](#). This curve is a function of three components: V_{TH} , V_{OS} , and V_{HYST} :

- V_{TH} is the actual set voltage or threshold trip voltage.
- V_{OS} is the internal offset voltage between V_{IN+} and V_{IN-} . This voltage is added to V_{TH} to form the actual trip point at which the comparator must respond to change output states.
- V_{HYST} is the internal hysteresis (or trip window) that is designed to reduce comparator sensitivity to noise (7 mV for both TLV703x-Q1 and TLV704x-Q1).



图 7-1. Hysteresis Transfer Curve

7.4.3 Output

The TLV703x-Q1 features a push-pull output stage eliminating the need for an external pullup resistor. On the other hand, the TLV704x-Q1 features an open-drain output stage enabling the output logic levels to be pulled up to an external source up to 6.5 V independent of the supply voltage.

8 Application and Implementation

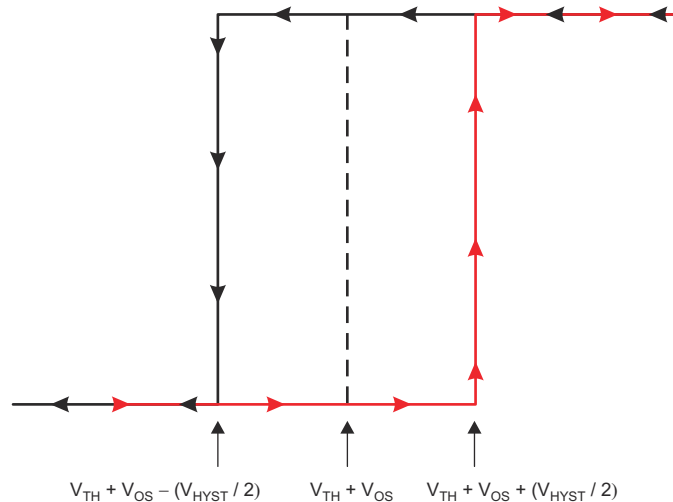
备注

以下应用部分中的信息不属于 TI 器件规格的范围，TI 不担保其准确性和完整性。TI 的客户应负责确定器件是否适用于其应用。客户应验证并测试其设计，以确保系统功能。

8.1 Application Information

The TLV703x-Q1 and TLV704x-Q1 are nano-power comparators with reasonable response time. The comparators have a rail-to-rail input stage that can monitor signals beyond the positive supply rail with integrated hysteresis. When higher levels of hysteresis are required, positive feedback can be externally added. The push-pull output stage of the TLV703x-Q1 is optimal for reduced power budget applications and features no shoot-through current. When level shifting or wire-ORing of the comparator outputs is needed, the TLV704x-Q1 with its open-drain output stage is well suited to meet the system needs. In either case, the wide operating voltage range, low quiescent current, and small size of the TLV703x-Q1 and TLV704x-Q1 make these comparators excellent candidates for battery-operated and portable, handheld designs.

8.1.1 Inverting Comparator With Hysteresis for TLV703x-Q1

The inverting comparator with hysteresis requires a three-resistor network that is referenced to the comparator supply voltage (V_{CC}), as shown in [图 8-1](#). When V_{IN} at the inverting input is less than V_A , the output voltage is high (for simplicity, assume V_O switches as high as V_{CC}). The three network resistors can be represented as $R1 \parallel R3$ in series with $R2$. [方程式 1](#) defines the high-to-low trip voltage (V_{A1}).

$$V_{A1} = V_{CC} \times \frac{R2}{(R1 \parallel R3) + R2} \quad (1)$$

When V_{IN} is greater than V_A , the output voltage is low, very close to ground. In this case, the three network resistors can be presented as $R2 \parallel R3$ in series with $R1$. Use [方程式 2](#) to define the low to high trip voltage (V_{A2}).

$$V_{A2} = V_{CC} \times \frac{R2 \parallel R3}{R1 + (R2 \parallel R3)} \quad (2)$$

[方程式 3](#) defines the total hysteresis provided by the network.

$$\Delta V_A = V_{A1} - V_{A2} \quad (3)$$



图 8-1. TLV703x-Q1 in an Inverting Configuration With Hysteresis

8.1.2 Noninverting Comparator With Hysteresis for TLV703x-Q1

A noninverting comparator with hysteresis requires a two-resistor network, as shown in 图 8-2, and a voltage reference (V_{REF}) at the inverting input. When V_{IN} is low, the output is also low. For the output to switch from low to high, V_{IN} must rise to V_{IN1}. Use 方程式 4 to calculate V_{IN1}.

$$V_{IN1} = R1 \times \frac{V_{REF}}{R2} + V_{REF} \quad (4)$$

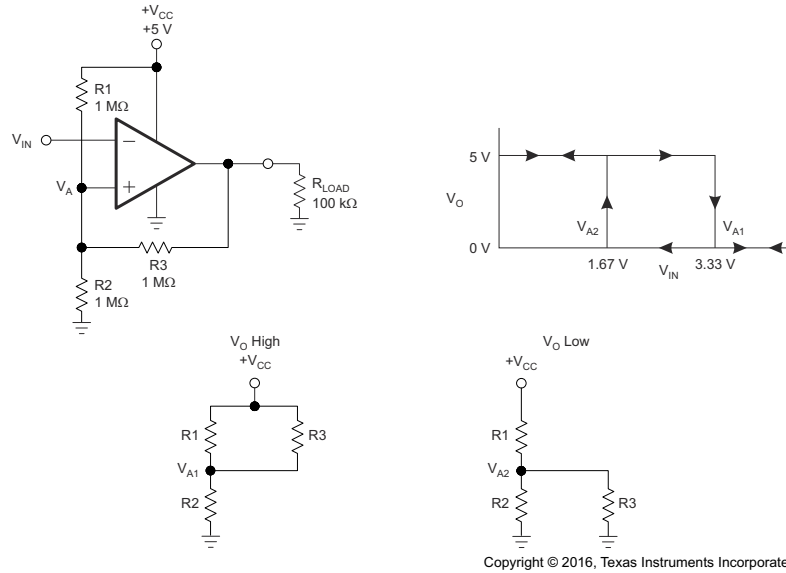
When V_{IN} is high, the output is also high. For the comparator to switch back to a low state, V_{IN} must drop to V_{IN2} such that V_A is equal to V_{REF}. Use 方程式 5 to calculate V_{IN2}.

$$V_{IN2} = \frac{V_{REF} (R1 + R2) - V_{CC} \times R1}{R2} \quad (5)$$

The hysteresis of this circuit is the difference between V_{IN1} and V_{IN2}, as shown in 方程式 6.

$$\Delta V_{IN} = V_{CC} \times \frac{R1}{R2} \quad (6)$$

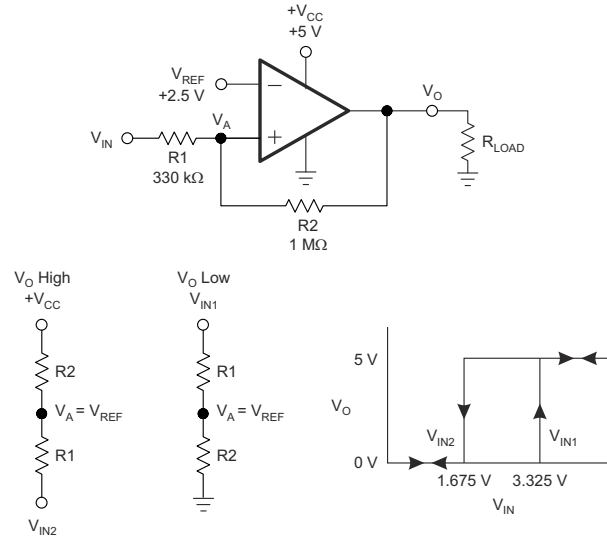

Copyright © 2016, Texas Instruments Incorporated

图 8-2. TLV703x-Q1 in a Noninverting Configuration With Hysteresis

8.2 Typical Applications

8.2.1 Window Comparator

Window comparators are commonly used to detect undervoltage and overvoltage conditions. [图 8-3](#) shows a simple window comparator circuit.



图 8-3. TLV704x-Q1-Based Window Comparator

8.2.1.1 Design Requirements

For this design, follow these design requirements:

- Alert (logic low output) when an input signal is less than 1.1 V
- Alert (logic low output) when an input signal is greater than 2.2 V
- Alert signal is active low
- Operate from a 3.3-V power supply

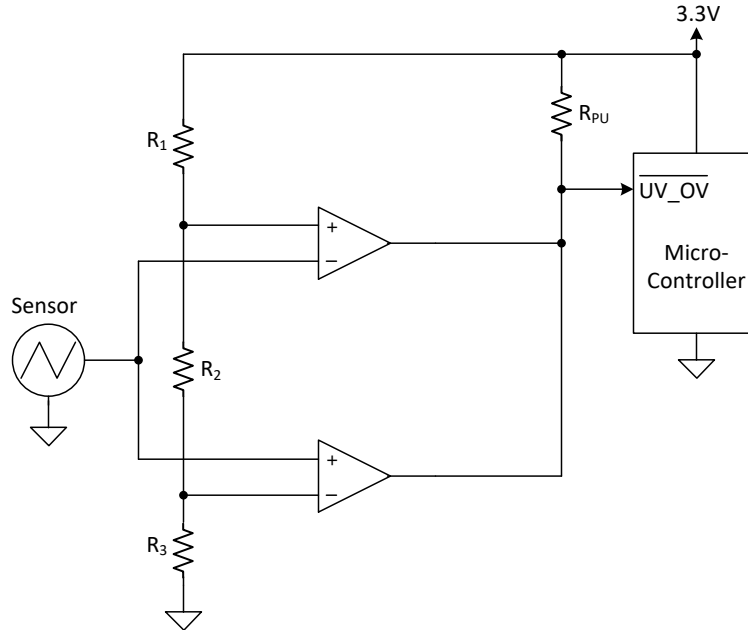
8.2.1.2 Detailed Design Procedure

Configure the circuit as shown in [图 8-3](#). Connect V_{CC} to a 3.3-V power supply and V_{EE} to ground. Make R_1 , R_2 , and R_3 each $10\text{-M}\Omega$ resistors. These three resistors are used to create the positive and negative thresholds for the window comparator (V_{TH+} and V_{TH-}). With each resistor being equal, V_{TH+} is 2.2 V and V_{TH-} is 1.1 V. Large resistor values such as $10\text{ M}\Omega$ are used to minimize power consumption. The sensor output voltage is applied to the inverting and noninverting inputs of the two TLV704x-Q1 devices. The TLV704x-Q1 is used for its open-drain output configuration. Using the TLV704x-Q1 allows the two comparator outputs to be wire-ored together. The respective comparator outputs are low when the sensor is less than 1.1 V or greater than 2.2 V. V_{OUT} is high when the sensor is in the range of 1.1 V to 2.2 V.

8.2.1.3 Application Curve



图 8-4. Window Comparator Results

8.2.2 IR Receiver Analog Front End

A single TLV703x-Q1 device can be used to build a complete IR receiver analog front end (AFE). The nanoamp quiescent current and low input bias current make it possible to be powered with a coin cell battery, which could last for years.

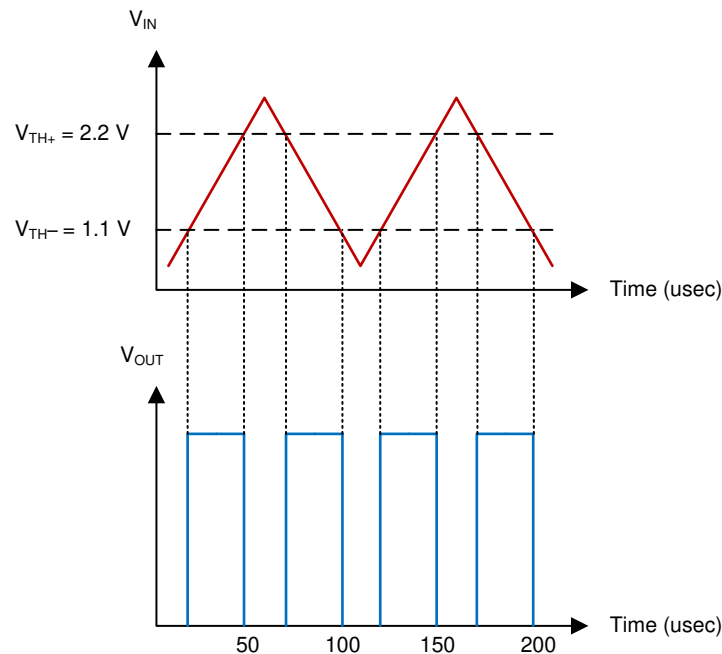
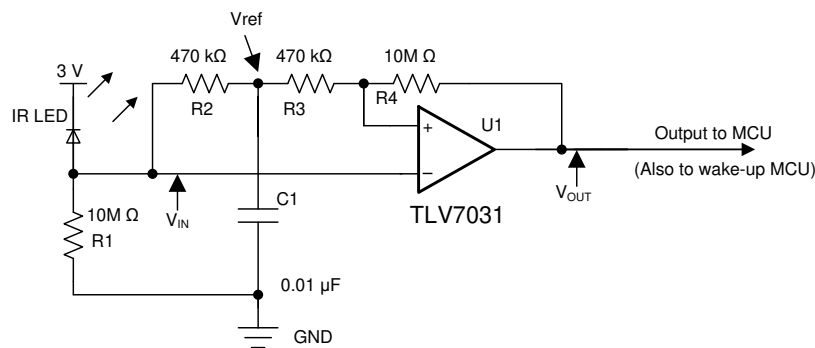

Copyright © 2017, Texas Instruments Incorporated

图 8-5. IR Receiver Analog Front End Using TLV703x-Q1

8.2.2.1 Design Requirements

For this design, follow these design requirements:

- Use a proper resistor (R_1) value to generate an adequate signal amplitude applied to the inverting input of the comparator.
- The low input bias current I_B (2 pA typical) ensures that a greater value of R_1 to be used.
- The RC constant value (R_2 and C_1) must support the targeted data rate (that is, 9,600 bauds) in order to maintain a valid tripping threshold.
- The hysteresis introduced with R_3 and R_4 helps to avoid spurious output toggles.

8.2.2.2 Detailed Design Procedure

The IR receiver AFE design is highly streamlined and optimized. R_1 converts the IR light energy induced current into voltage and applies to the inverting input of the comparator. The RC network of R_2 and C_1 establishes a reference voltage V_{ref} , which tracks the mean amplitude of the IR signal. The noninverting input is directly connected to V_{ref} through R_3 . R_3 and R_4 are used to produce a hysteresis to keep transitions free of spurious toggles. To reduce the current drain from the coin cell battery, data transmission must be short and infrequent.

More technical details are provided in the TI TechNote [Low Power Comparator for Signal Processing and Wake-Up Circuit in Smart Meters](#) (SNVA808).

8.2.2.3 Application Curve



图 8-6. IR Receiver AFE Waveforms

8.2.3 Square-Wave Oscillator

A square-wave oscillator can be used as low-cost timing reference or system supervisory clock source.

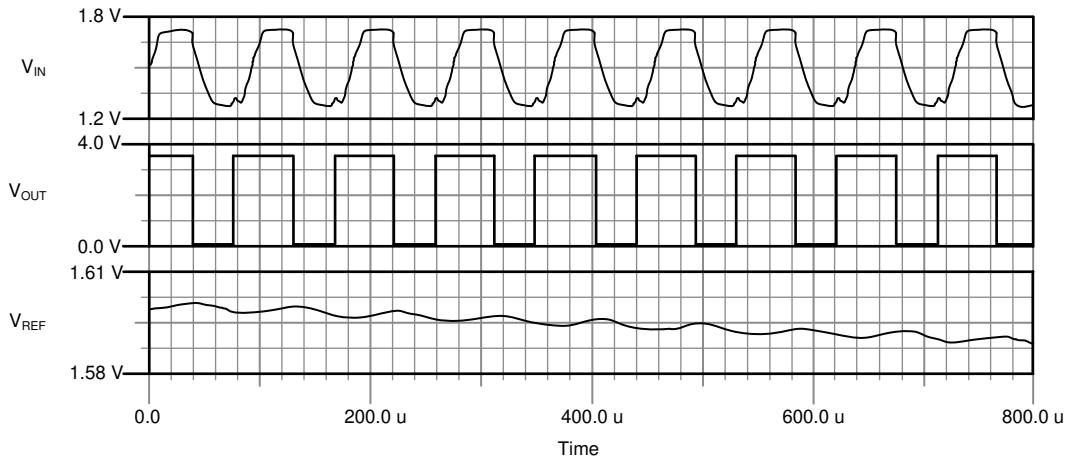

图 8-7. Square-Wave Oscillator

8.2.3.1 Design Requirements

The square-wave period is determined by the RC time constant of the capacitor and resistor. The maximum frequency is limited by the propagation delay of the device and the capacitance load at the output. The low input bias current allows a lower capacitor value and larger resistor value combination for a given oscillator frequency, which may help reduce BOM cost and board space.

8.2.3.2 Detailed Design Procedure

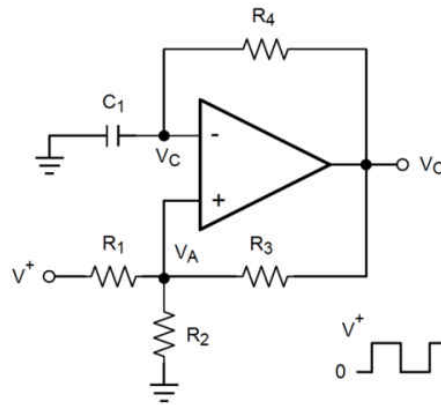
The oscillation frequency is determined by the resistor and capacitor values. The following section provides details to calculate these component values.



图 8-8. Square-Wave Oscillator Timing Thresholds

First consider the output of figure 图 8-7 is high, which indicates the inverted input V_C is lower than the noninverting input (V_A). This causes the C_1 to be charged through R_4 , and the voltage V_C increases until it is equal to the noninverting input. The value of V_A at the point is calculated by 方程式 7.

$$V_{A1} = \frac{V_{CC} \times R_2}{R_2 + R_1 + R_3} \quad (7)$$

If $R_1 = R_2 = R_3$, then $V_{A1} = 2 V_{CC} / 3$

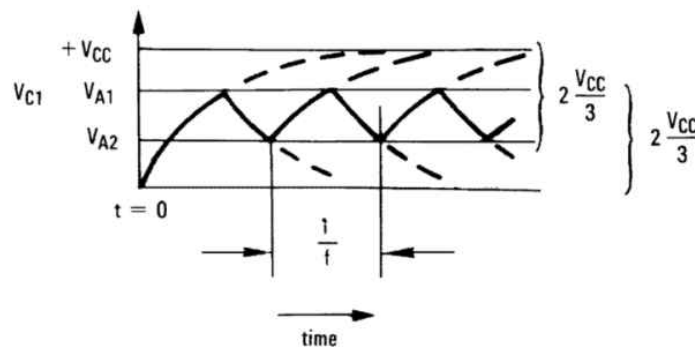
At this time the comparator output trips pulling down the output to the negative rail. The value of V_A at this point is calculated by 方程式 8.

$$V_{A2} = \frac{V_{CC}(R_2 \parallel R_3)}{R_1 + R_2 \parallel R_3} \quad (8)$$

If $R_1 = R_2 = R_3$, then $V_{A2} = V_{CC}/3$

The C_1 now discharges through the R_4 , and the voltage V_{CC} decreases until it reaches V_{A2} . At this point, the output switches back to the starting state. The oscillation period equals the time duration from $2 V_{CC} / 3$ to $V_{CC} / 3$ then back to $2 V_{CC} / 3$, which is given by $R_4 C_1 \times \ln 2$ for each trip. Therefore, the total time duration is calculated as $2 R_4 C_1 \times \ln 2$. The oscillation frequency can be obtained by 方程式 9:

$$f = 1 / (2 R_4 \times C_1 \times \ln 2) \quad (9)$$

8.2.3.3 Application Curve

图 8-9 shows the simulated results of an oscillator using the following component values:

- $R_1 = R_2 = R_3 = R_4 = 100 \text{ k}\Omega$
- $C_1 = 100 \text{ pF}$, $C_L = 20 \text{ pF}$
- $V_+ = 5 \text{ V}$, $V_- = \text{GND}$
- C_{stray} (not shown) from V_A to GND = 10 pF



图 8-9. Square-Wave Oscillator Output Waveform

9 Power Supply Recommendations

The TLV703x-Q1 and TLV704x-Q1 have a recommended operating voltage range (V_S) of 1.6 V to 6.5 V. V_S is defined as $V_{CC} - V_{EE}$. Therefore, the supply voltages used to create V_S can be single-ended or bipolar. For example, single-ended supply voltages of 5 V and 0 V and bipolar supply voltages of +2.5 V and -2.5 V create comparable operating voltages for V_S . However, when bipolar supply voltages are used, it is important to realize that the logic low level of the comparator output is referenced to V_{EE} .

Output capacitive loading and output toggle rate will cause the average supply current to rise over the quiescent current.

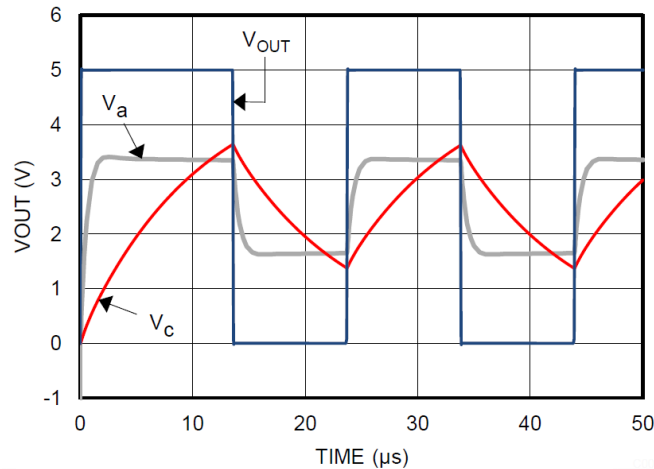
10 Layout

10.1 Layout Guidelines

图 10-1 shows the typical connections for the TLV7031-Q1. To minimize supply noise, power supplies must be capacitively decoupled by a 0.1- μ F ceramic capacitor in parallel with a 10- μ F electrolytic capacitor. Comparators are very sensitive to input noise. Proper grounding (the use of a ground plane) helps to maintain the specified performance of the TLV70x1-Q1 family.

For best results, maintain the following layout guidelines:

1. Use a printed-circuit board (PCB) with a good, unbroken low-inductance ground plane.
2. Place a decoupling capacitor (0.1- μ F ceramic, surface-mount capacitor) as close as possible to V_{CC} .
3. On the inputs and the output, keep lead lengths as short as possible to avoid unwanted parasitic feedback around the comparator. Keep inputs away from the output.
4. Solder the device directly to the PCB rather than using a socket.
5. For slow-moving input signals, take care to prevent parasitic feedback. A small capacitor (1000 pF or less) placed between the inputs can help eliminate oscillations in the transition region. This capacitor causes some degradation to propagation delay when the impedance is low. The top-side ground plane runs between the output and inputs.
6. The ground pin ground trace runs under the device up to the bypass capacitor, shielding the inputs from the outputs.

10.2 Layout Example



图 10-1. TLV7031-Q1 Layout Example

11 Device and Documentation Support

11.1 Device Support

11.1.1 Development Support

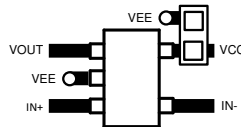
11.1.1.1 Evaluation Module

An evaluation module (EVM) is available to assist in the initial circuit performance evaluation using the TLV703x-Q1, TLV704x-Q1 device family. The [DIP Adapter EVM](#) can be requested at the Texas Instruments website through the product folder or purchased directly from the TI eStore.

11.2 接收文档更新通知

要接收文档更新通知，请导航至 [ti.com](https://www.ti.com) 上的器件产品文件夹。点击 [订阅更新](#) 进行注册，即可每周接收产品信息更改摘要。有关更改的详细信息，请查看任何已修订文档中包含的修订历史记录。

11.3 支持资源

[TI E2E™ 支持论坛](#) 是工程师的重要参考资料，可直接从专家获得快速、经过验证的解答和设计帮助。搜索现有解答或提出自己的问题可获得所需的快速设计帮助。

链接的内容由各个贡献者“按原样”提供。这些内容并不构成 TI 技术规范，并且不一定反映 TI 的观点；请参阅 TI 的 [《使用条款》](#)。

11.4 Trademarks

TI E2E™ is a trademark of Texas Instruments.

所有商标均为其各自所有者的财产。

11.5 静电放电警告



静电放电 (ESD) 会损坏这个集成电路。德州仪器 (TI) 建议通过适当的预防措施处理所有集成电路。如果不遵守正确的处理和安装程序，可能会损坏集成电路。

ESD 的损坏小至导致微小的性能降级，大至整个器件故障。精密的集成电路可能更容易受到损坏，这是因为非常细微的参数更改都可能会导致器件与其发布的规格不相符。

11.6 术语表

[TI 术语表](#) 本术语表列出并解释了术语、首字母缩略词和定义。

12 Mechanical, Packaging, and Orderable Information

The following pages include mechanical, packaging, and orderable information. This information is the most current data available for the designated devices. This data is subject to change without notice and revision of this document. For browser-based versions of this data sheet, refer to the left-hand navigation.

PACKAGING INFORMATION

Orderable part number	Status (1)	Material type (2)	Package Pins	Package qty Carrier	RoHS (3)	Lead finish/ Ball material (4)	MSL rating/ Peak reflow (5)	Op temp (°C)	Part marking (6)
TLV7031QDBVRQ1	Active	Production	SOT-23 (DBV) 5	3000 LARGE T&R	Yes	NIPDAU	Level-1-260C-UNLIM	-40 to 125	7031
TLV7031QDBVRQ1.A	Active	Production	SOT-23 (DBV) 5	3000 LARGE T&R	Yes	NIPDAU	Level-1-260C-UNLIM	-40 to 125	7031
TLV7031QDBVRQ1G4	Active	Production	SOT-23 (DBV) 5	3000 LARGE T&R	Yes	NIPDAU	Level-1-260C-UNLIM	-40 to 125	7031
TLV7031QDBVRQ1G4.A	Active	Production	SOT-23 (DBV) 5	3000 LARGE T&R	Yes	NIPDAU	Level-1-260C-UNLIM	-40 to 125	7031
TLV7031QDCKRQ1	Active	Production	SC70 (DCK) 5	3000 LARGE T&R	Yes	NIPDAU	Level-1-260C-UNLIM	-40 to 125	1GP
TLV7031QDCKRQ1.A	Active	Production	SC70 (DCK) 5	3000 LARGE T&R	Yes	NIPDAU	Level-1-260C-UNLIM	-40 to 125	1GP
TLV7032QDDFRQ1	Active	Production	SOT-23-THIN (DDF) 8	3000 LARGE T&R	Yes	NIPDAU	Level-1-260C-UNLIM	-40 to 125	2R4F
TLV7032QDDFRQ1.A	Active	Production	SOT-23-THIN (DDF) 8	3000 LARGE T&R	Yes	NIPDAU	Level-1-260C-UNLIM	-40 to 125	2R4F
TLV7032QDGRQ1	Active	Production	VSSOP (DGK) 8	2500 LARGE T&R	Yes	NIPDAU	Level-1-260C-UNLIM	-40 to 125	7032
TLV7032QDGRQ1.A	Active	Production	VSSOP (DGK) 8	2500 LARGE T&R	Yes	NIPDAU	Level-1-260C-UNLIM	-40 to 125	7032
TLV7034QPWRQ1	Active	Production	TSSOP (PW) 14	2000 LARGE T&R	Yes	NIPDAU	Level-1-260C-UNLIM	-40 to 125	7034Q
TLV7034QPWRQ1.A	Active	Production	TSSOP (PW) 14	2000 LARGE T&R	Yes	NIPDAU	Level-1-260C-UNLIM	-40 to 125	7034Q
TLV7041QDBVRQ1	Active	Production	SOT-23 (DBV) 5	3000 LARGE T&R	Yes	NIPDAU	Level-1-260C-UNLIM	-40 to 125	7041
TLV7041QDBVRQ1.A	Active	Production	SOT-23 (DBV) 5	3000 LARGE T&R	Yes	NIPDAU	Level-1-260C-UNLIM	-40 to 125	7041
TLV7041QDCKRQ1	Active	Production	SC70 (DCK) 5	3000 LARGE T&R	Yes	NIPDAU	Level-1-260C-UNLIM	-40 to 125	1GQ
TLV7041QDCKRQ1.A	Active	Production	SC70 (DCK) 5	3000 LARGE T&R	Yes	NIPDAU	Level-1-260C-UNLIM	-40 to 125	1GQ
TLV7042QDDFRQ1	Active	Production	SOT-23-THIN (DDF) 8	3000 LARGE T&R	Yes	NIPDAU	Level-1-260C-UNLIM	-40 to 125	2R5F
TLV7042QDDFRQ1.A	Active	Production	SOT-23-THIN (DDF) 8	3000 LARGE T&R	Yes	NIPDAU	Level-1-260C-UNLIM	-40 to 125	2R5F
TLV7042QDGRQ1	Active	Production	VSSOP (DGK) 8	2500 LARGE T&R	Yes	NIPDAU	Level-1-260C-UNLIM	-40 to 125	7042
TLV7042QDGRQ1.A	Active	Production	VSSOP (DGK) 8	2500 LARGE T&R	Yes	NIPDAU	Level-1-260C-UNLIM	-40 to 125	7042
TLV7044QPWRQ1	Active	Production	TSSOP (PW) 14	2000 LARGE T&R	Yes	NIPDAU	Level-1-260C-UNLIM	-40 to 125	7044Q
TLV7044QPWRQ1.A	Active	Production	TSSOP (PW) 14	2000 LARGE T&R	Yes	NIPDAU	Level-1-260C-UNLIM	-40 to 125	7044Q

(1) **Status:** For more details on status, see our [product life cycle](#).

(2) **Material type:** When designated, preproduction parts are prototypes/experimental devices, and are not yet approved or released for full production. Testing and final process, including without limitation quality assurance, reliability performance testing, and/or process qualification, may not yet be complete, and this item is subject to further changes or possible discontinuation. If available for ordering, purchases will be subject to an additional waiver at checkout, and are intended for early internal evaluation purposes only. These items are sold without warranties of any kind.

(3) **RoHS values:** Yes, No, RoHS Exempt. See the [TI RoHS Statement](#) for additional information and value definition.

(4) **Lead finish/Ball material:** Parts may have multiple material finish options. Finish options are separated by a vertical ruled line. Lead finish/Ball material values may wrap to two lines if the finish value exceeds the maximum column width.

(5) **MSL rating/Peak reflow:** The moisture sensitivity level ratings and peak solder (reflow) temperatures. In the event that a part has multiple moisture sensitivity ratings, only the lowest level per JEDEC standards is shown. Refer to the shipping label for the actual reflow temperature that will be used to mount the part to the printed circuit board.

(6) **Part marking:** There may be an additional marking, which relates to the logo, the lot trace code information, or the environmental category of the part.

Multiple part markings will be inside parentheses. Only one part marking contained in parentheses and separated by a "~" will appear on a part. If a line is indented then it is a continuation of the previous line and the two combined represent the entire part marking for that device.

Important Information and Disclaimer: The information provided on this page represents TI's knowledge and belief as of the date that it is provided. TI bases its knowledge and belief on information provided by third parties, and makes no representation or warranty as to the accuracy of such information. Efforts are underway to better integrate information from third parties. TI has taken and continues to take reasonable steps to provide representative and accurate information but may not have conducted destructive testing or chemical analysis on incoming materials and chemicals. TI and TI suppliers consider certain information to be proprietary, and thus CAS numbers and other limited information may not be available for release.

In no event shall TI's liability arising out of such information exceed the total purchase price of the TI part(s) at issue in this document sold by TI to Customer on an annual basis.

OTHER QUALIFIED VERSIONS OF TLV7031-Q1, TLV7032-Q1, TLV7034-Q1, TLV7041-Q1, TLV7042-Q1, TLV7044-Q1 :

- Catalog : [TLV7031](#), [TLV7032](#), [TLV7034](#), [TLV7041](#), [TLV7042](#), [TLV7044](#)

NOTE: Qualified Version Definitions:

- Catalog - TI's standard catalog product

TAPE AND REEL INFORMATION

QUADRANT ASSIGNMENTS FOR PIN 1 ORIENTATION IN TAPE

*All dimensions are nominal

Device	Package Type	Package Drawing	Pins	SPQ	Reel Diameter (mm)	Reel Width W1 (mm)	A0 (mm)	B0 (mm)	K0 (mm)	P1 (mm)	W (mm)	Pin1 Quadrant
TLV7031QDBVRQ1	SOT-23	DBV	5	3000	180.0	8.4	3.2	3.2	1.4	4.0	8.0	Q3
TLV7031QDBVRQ1	SOT-23	DBV	5	3000	178.0	9.0	3.3	3.2	1.4	4.0	8.0	Q3
TLV7031QDBVRQ1G4	SOT-23	DBV	5	3000	178.0	9.0	3.3	3.2	1.4	4.0	8.0	Q3
TLV7031QDCKRQ1	SC70	DCK	5	3000	178.0	9.0	2.4	2.5	1.2	4.0	8.0	Q3
TLV7032QDDFRQ1	SOT-23-THIN	DDF	8	3000	180.0	8.4	3.2	3.2	1.4	4.0	8.0	Q3
TLV7032QDGRQ1	VSSOP	DGK	8	2500	330.0	12.4	5.3	3.4	1.4	8.0	12.0	Q1
TLV7032QDGRQ1	VSSOP	DGK	8	2500	330.0	12.4	5.25	3.35	1.25	8.0	12.0	Q1
TLV7034QPWRQ1	TSSOP	PW	14	2000	330.0	12.4	6.9	5.6	1.6	8.0	12.0	Q1
TLV7041QDBVRQ1	SOT-23	DBV	5	3000	178.0	9.0	3.3	3.2	1.4	4.0	8.0	Q3
TLV7041QDBVRQ1	SOT-23	DBV	5	3000	180.0	8.4	3.2	3.2	1.4	4.0	8.0	Q3
TLV7041QDCKRQ1	SC70	DCK	5	3000	178.0	9.0	2.4	2.5	1.2	4.0	8.0	Q3
TLV7042QDDFRQ1	SOT-23-THIN	DDF	8	3000	180.0	8.4	3.2	3.2	1.4	4.0	8.0	Q3
TLV7042QDGRQ1	VSSOP	DGK	8	2500	330.0	12.4	5.25	3.35	1.25	8.0	12.0	Q1
TLV7042QDGRQ1	VSSOP	DGK	8	2500	330.0	12.4	5.3	3.4	1.4	8.0	12.0	Q1
TLV7044QPWRQ1	TSSOP	PW	14	2000	330.0	12.4	6.9	5.6	1.6	8.0	12.0	Q1

TAPE AND REEL BOX DIMENSIONS

*All dimensions are nominal

Device	Package Type	Package Drawing	Pins	SPQ	Length (mm)	Width (mm)	Height (mm)
TLV7031QDBVRQ1	SOT-23	DBV	5	3000	210.0	185.0	35.0
TLV7031QDBVRQ1	SOT-23	DBV	5	3000	180.0	180.0	18.0
TLV7031QDBVRQ1G4	SOT-23	DBV	5	3000	180.0	180.0	18.0
TLV7031QDCKRQ1	SC70	DCK	5	3000	190.0	190.0	30.0
TLV7032QDDFRQ1	SOT-23-THIN	DDF	8	3000	210.0	185.0	35.0
TLV7032QDGKRQ1	VSSOP	DGK	8	2500	353.0	353.0	32.0
TLV7032QDGKRQ1	VSSOP	DGK	8	2500	366.0	364.0	50.0
TLV7034QPWRQ1	TSSOP	PW	14	2000	353.0	353.0	32.0
TLV7041QDBVRQ1	SOT-23	DBV	5	3000	180.0	180.0	18.0
TLV7041QDBVRQ1	SOT-23	DBV	5	3000	210.0	185.0	35.0
TLV7041QDCKRQ1	SC70	DCK	5	3000	190.0	190.0	30.0
TLV7042QDDFRQ1	SOT-23-THIN	DDF	8	3000	210.0	185.0	35.0
TLV7042QDGKRQ1	VSSOP	DGK	8	2500	366.0	364.0	50.0
TLV7042QDGKRQ1	VSSOP	DGK	8	2500	353.0	353.0	32.0
TLV7044QPWRQ1	TSSOP	PW	14	2000	353.0	353.0	32.0

EXAMPLE BOARD LAYOUT

DCK0005A

SOT - 1.1 max height

SMALL OUTLINE TRANSISTOR



LAND PATTERN EXAMPLE
EXPOSED METAL SHOWN
SCALE:18X



SOLDER MASK DETAILS

4214834/G 11/2024

NOTES: (continued)

- 7. Publication IPC-7351 may have alternate designs.
- 8. Solder mask tolerances between and around signal pads can vary based on board fabrication site.

EXAMPLE STENCIL DESIGN

DCK0005A

SOT - 1.1 max height

SMALL OUTLINE TRANSISTOR



SOLDER PASTE EXAMPLE
BASED ON 0.125 THICK STENCIL
SCALE: 18X

4214834/G 11/2024

NOTES: (continued)

9. Laser cutting apertures with trapezoidal walls and rounded corners may offer better paste release. IPC-7525 may have alternate design recommendations.
10. Board assembly site may have different recommendations for stencil design.

EXAMPLE BOARD LAYOUT

DDF0008A

SOT-23-THIN - 1.1 mm max height

PLASTIC SMALL OUTLINE

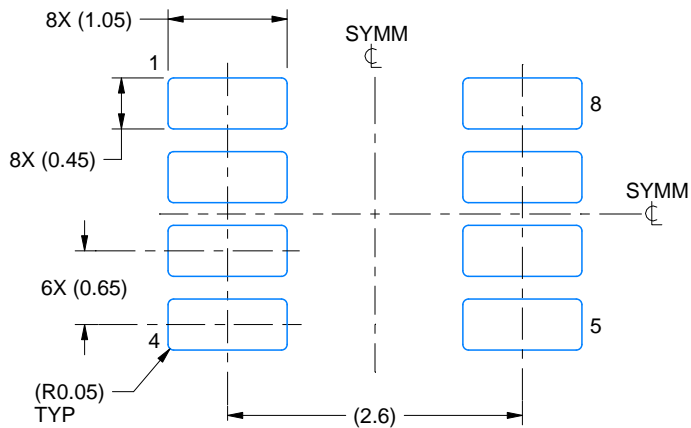

LAND PATTERN EXAMPLE
EXPOSED METAL SHOWN
SCALE:15X

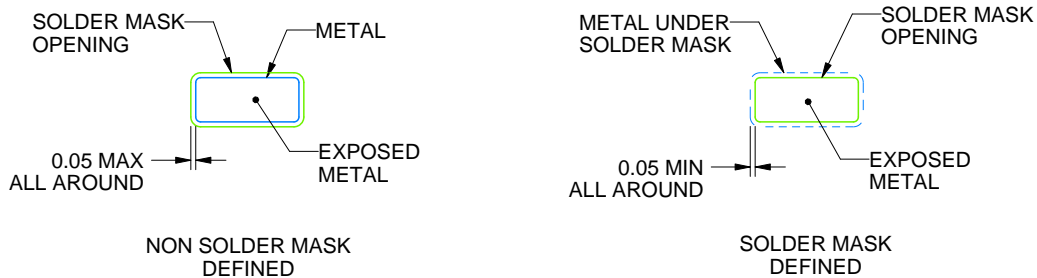

SOLDER MASK DETAILS

4222047/E 07/2024

NOTES: (continued)

- 4. Publication IPC-7351 may have alternate designs.
- 5. Solder mask tolerances between and around signal pads can vary based on board fabrication site.

EXAMPLE STENCIL DESIGN

DDF0008A

SOT-23-THIN - 1.1 mm max height

PLASTIC SMALL OUTLINE



SOLDER PASTE EXAMPLE
BASED ON 0.125 mm THICK STENCIL
SCALE:15X

4222047/E 07/2024

NOTES: (continued)

6. Laser cutting apertures with trapezoidal walls and rounded corners may offer better paste release. IPC-7525 may have alternate design recommendations.
7. Board assembly site may have different recommendations for stencil design.



NOTES:

1. All linear dimensions are in millimeters. Any dimensions in parenthesis are for reference only. Dimensioning and tolerancing per ASME Y14.5M.
2. This drawing is subject to change without notice.
3. This dimension does not include mold flash, protrusions, or gate burrs. Mold flash, protrusions, or gate burrs shall not exceed 0.15 mm per side.
4. This dimension does not include interlead flash. Interlead flash shall not exceed 0.25 mm per side.
5. Reference JEDEC registration MO-153.

EXAMPLE BOARD LAYOUT

PW0014A

TSSOP - 1.2 mm max height

SMALL OUTLINE PACKAGE



LAND PATTERN EXAMPLE
EXPOSED METAL SHOWN
SCALE: 10X



4220202/B 12/2023

NOTES: (continued)

- 6. Publication IPC-7351 may have alternate designs.
- 7. Solder mask tolerances between and around signal pads can vary based on board fabrication site.

EXAMPLE STENCIL DESIGN

PW0014A

TSSOP - 1.2 mm max height

SMALL OUTLINE PACKAGE



SOLDER PASTE EXAMPLE
BASED ON 0.125 mm THICK STENCIL
SCALE: 10X

4220202/B 12/2023

NOTES: (continued)

8. Laser cutting apertures with trapezoidal walls and rounded corners may offer better paste release. IPC-7525 may have alternate design recommendations.
9. Board assembly site may have different recommendations for stencil design.

EXAMPLE BOARD LAYOUT

DBV0005A

SOT-23 - 1.45 mm max height

SMALL OUTLINE TRANSISTOR



LAND PATTERN EXAMPLE
EXPOSED METAL SHOWN
SCALE:15X

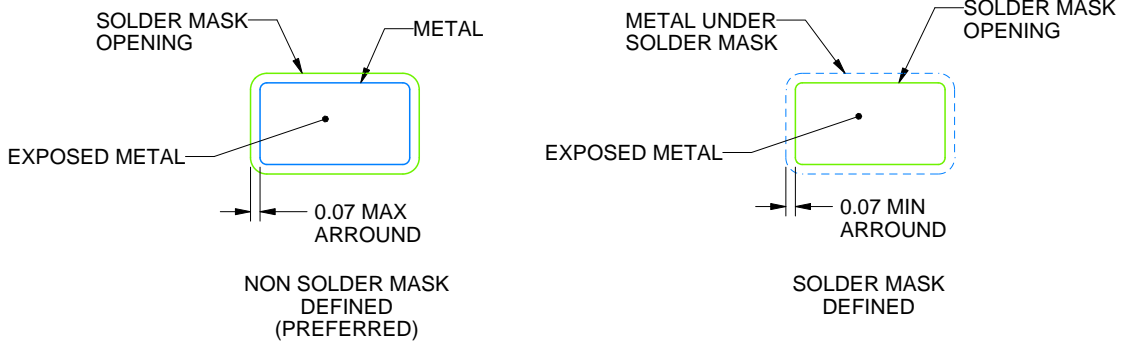

SOLDER MASK DETAILS

4214839/K 08/2024

NOTES: (continued)

- 6. Publication IPC-7351 may have alternate designs.
- 7. Solder mask tolerances between and around signal pads can vary based on board fabrication site.

EXAMPLE STENCIL DESIGN

DBV0005A

SOT-23 - 1.45 mm max height

SMALL OUTLINE TRANSISTOR



SOLDER PASTE EXAMPLE
BASED ON 0.125 mm THICK STENCIL
SCALE:15X

4214839/K 08/2024

NOTES: (continued)

8. Laser cutting apertures with trapezoidal walls and rounded corners may offer better paste release. IPC-7525 may have alternate design recommendations.
9. Board assembly site may have different recommendations for stencil design.

DGK0008A



PACKAGE OUTLINE

VSSOP - 1.1 mm max height

SMALL OUTLINE PACKAGE



NOTES:

PowerPAD is a trademark of Texas Instruments.

1. All linear dimensions are in millimeters. Any dimensions in parenthesis are for reference only. Dimensioning and tolerancing per ASME Y14.5M.
2. This drawing is subject to change without notice.
3. This dimension does not include mold flash, protrusions, or gate burrs. Mold flash, protrusions, or gate burrs shall not exceed 0.15 mm per side.
4. This dimension does not include interlead flash. Interlead flash shall not exceed 0.25 mm per side.
5. Reference JEDEC registration MO-187.

EXAMPLE BOARD LAYOUT

DGK0008A

™ VSSOP - 1.1 mm max height

SMALL OUTLINE PACKAGE



LAND PATTERN EXAMPLE
EXPOSED METAL SHOWN
SCALE: 15X



SOLDER MASK DETAILS

4214862/A 04/2023

NOTES: (continued)

6. Publication IPC-7351 may have alternate designs.
7. Solder mask tolerances between and around signal pads can vary based on board fabrication site.
8. Vias are optional depending on application, refer to device data sheet. If any vias are implemented, refer to their locations shown on this view. It is recommended that vias under paste be filled, plugged or tented.
9. Size of metal pad may vary due to creepage requirement.

EXAMPLE STENCIL DESIGN

DGK0008A

TM VSSOP - 1.1 mm max height

SMALL OUTLINE PACKAGE



SOLDER PASTE EXAMPLE
SCALE: 15X

4214862/A 04/2023

NOTES: (continued)

11. Laser cutting apertures with trapezoidal walls and rounded corners may offer better paste release. IPC-7525 may have alternate design recommendations.
12. Board assembly site may have different recommendations for stencil design.

重要通知和免责声明

TI“按原样”提供技术和可靠性数据（包括数据表）、设计资源（包括参考设计）、应用或其他设计建议、网络工具、安全信息和其他资源，不保证没有瑕疵且不做任何明示或暗示的担保，包括但不限于对适销性、与某特定用途的适用性或不侵犯任何第三方知识产权的暗示担保。

这些资源可供使用 TI 产品进行设计的熟练开发人员使用。您将自行承担以下全部责任：(1) 针对您的应用选择合适的 TI 产品，(2) 设计、验证并测试您的应用，(3) 确保您的应用满足相应标准以及任何其他安全、安保法规或其他要求。

这些资源如有变更，恕不另行通知。TI 授权您仅可将这些资源用于研发本资源所述的 TI 产品的相关应用。严禁以其他方式对这些资源进行复制或展示。您无权使用任何其他 TI 知识产权或任何第三方知识产权。对于因您对这些资源的使用而对 TI 及其代表造成的任何索赔、损害、成本、损失和债务，您将全额赔偿，TI 对此概不负责。

TI 提供的产品受 [TI 销售条款](#)、[TI 通用质量指南](#) 或 [ti.com](#) 上其他适用条款或 TI 产品随附的其他适用条款的约束。TI 提供这些资源并不会扩展或以其他方式更改 TI 针对 TI 产品发布的适用的担保或担保免责声明。除非德州仪器 (TI) 明确将某产品指定为定制产品或客户特定产品，否则其产品均为按确定价格收入目录的标准通用器件。

TI 反对并拒绝您可能提出的任何其他或不同的条款。

版权所有 © 2026，德州仪器 (TI) 公司

最后更新日期：2025 年 10 月