

ONET1130EP 具有的 11.7Gbps 收发器

1 特性

- 集成限幅放大器和调制器驱动器
- 两线制数字接口搭配集成的数模转换器 (DAC) 和模数转换器 (ADC) 进行控制和诊断管理
- TX 和 RX 输出极性选择
- 电气和光学环回
- 集成调制器驱动器，输出幅值最高可达 $2 V_{PP}$ （单端），偏置电流最高可达 $150mA$ （拉电流）。
- 具有可选监视器光电二极管 (PD) 范围的自动功率控制 (APC) 回路
- 可编程的 TX 输入均衡器
- TX 交叉点调节和去加重功能
- 包括激光安全特性
- 具有可编程信号损耗 (LOS) 阈值的集成限幅放大器
- 可调节的 RX 均衡和输入阈值
- 可编程的 RX 输出电压和去加重功能
- 电源监视器和温度传感器
- 2.5V 单电源
- 工作温度范围：-40°C 至 100°C
- 表面贴装 4mm x 4mm 32 引脚四方扁平无引线 (QFN) 封装（间距为 0.4mm）

2 应用

- SFP+ 10Gbps SONET OC-192 光学收发器
- SFP+ 10 GBASE-ER/ZR 光学收发器

3 说明

ONET1130EP 是一款集成调制器驱动器和限幅放大器，设计为以 1Gbps 至 11.7Gbps 范围内的速率运行。该器件包含光学和电气环回，并且可利用两线制串行接口进行数字控制。

发送路径包含 1 个可调节输入均衡器（用于均衡长达 300mm

（12 英寸）的 FR4 印刷电路板的微带传输线或带状传输线）、和 1 个输出调制器驱动器。该器件以交叉点调节和去加重的形式提供输出波形控制，从而增加光学眼图波罩余量。该器件提供激光二极管偏置电流，并且包含集成自动功率控制 (APC) 回路，用于对平均光学功率随电压、温度和时间的变化进行补偿。

接收路径包含 1 个具有可编程均衡和阈值调节功能的限幅放大器、和输出去加重功能（用于对器件输出端所连接连接器、微带传输线或带状传输线上与频率相关的损耗进行补偿）。接收器输出幅值和信号损失有效电平都是可以调节的。

器件信息

订货编号	封装（引脚）	封装尺寸
ONET1130EP	VQFN (32)	4.00mm x 4.00mm

简化电路原理图

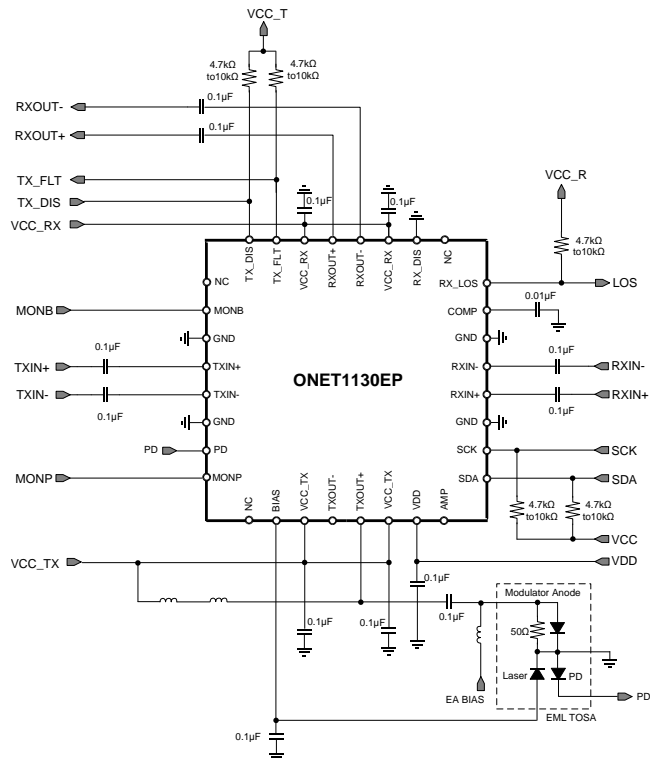

目录

<p>1 特性 1</p> <p>2 应用 1</p> <p>3 说明 1</p> <p>4 修订历史记录 2</p> <p>5 说明（续） 3</p> <p>6 Pin Configuration and Function 3</p> <p>7 Specifications 5</p> <p style="padding-left: 20px;">7.1 Absolute Maximum Ratings 5</p> <p style="padding-left: 20px;">7.2 ESD Ratings 5</p> <p style="padding-left: 20px;">7.3 Recommended Operating Conditions 5</p> <p style="padding-left: 20px;">7.4 Thermal Information 6</p> <p style="padding-left: 20px;">7.5 DC Electrical Characteristics 6</p> <p style="padding-left: 20px;">7.6 Transmitter AC Electrical Characteristics 8</p> <p style="padding-left: 20px;">7.7 Receiver AC Electrical Characteristics 9</p> <p style="padding-left: 20px;">7.8 Timing Requirements 10</p> <p style="padding-left: 20px;">7.9 Typical Characteristics 12</p> <p>8 Detailed Description 18</p> <p style="padding-left: 20px;">8.1 Overview 18</p>	<p style="padding-left: 20px;">8.2 Functional Block Diagram 19</p> <p style="padding-left: 20px;">8.3 Feature Description 20</p> <p style="padding-left: 20px;">8.4 Device Functional Modes 29</p> <p style="padding-left: 20px;">8.5 Programming 29</p> <p style="padding-left: 20px;">8.6 Register Mapping 30</p> <p>9 Application Information and Implementations 44</p> <p style="padding-left: 20px;">9.1 Application Information 44</p> <p style="padding-left: 20px;">9.2 Typical Application, Transmitter Differential Mode .. 44</p> <p>10 Power Supply Recommendations 48</p> <p>11 Layout 49</p> <p style="padding-left: 20px;">11.1 Layout Guidelines 49</p> <p style="padding-left: 20px;">11.2 Layout Example 49</p> <p>12 器件和文档支持 50</p> <p style="padding-left: 20px;">12.1 社区资源 50</p> <p style="padding-left: 20px;">12.2 商标 50</p> <p style="padding-left: 20px;">12.3 静电放电警告 50</p> <p style="padding-left: 20px;">12.4 Glossary 50</p> <p>13 机械、封装和可订购信息 50</p>
---	--

4 修订历史记录

NOTE: Page numbers for previous revisions may differ from page numbers in the current version.

Changes from Original (June 2015) to Revision A	Page
• 已从“产品预览”更改为“量产数据”	1

5 说明 (续)

ONET1130EP 内置模数转换器和数模转换器，可对收发器进行管理并且消除了对专用微控制器的需求。

收发器的额定工作温度范围为 -40°C 至 100°C (外壳温度)，并且采用符合 RoHS 标准的小型 $4\text{mm} \times 4\text{mm}$ 32 引脚超薄型四方扁平无引线 (VQFN) 封装。

6 Pin Configuration and Function

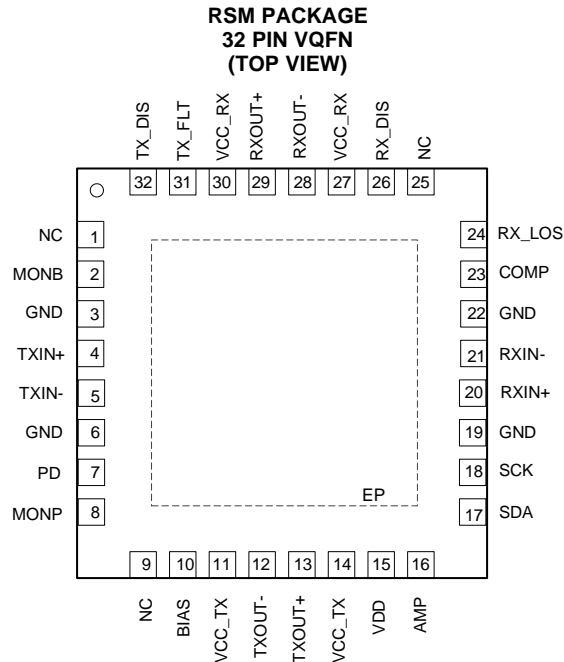

Pin Functions

NUMBER	NAME	Type	DESCRIPTION
AMP	16	Analog-in	Output amplitude control. Output amplitude can be adjusted by applying a voltage of 0 to 2 V to this pin. Leave open when not used.
BIAS	10	Analog	Sinks or sources the bias current for the laser in both APC and open loop modes.
COMP	23	Analog	Compensation pin used to control the bandwidth of the APC loop. Connect a $0.01\text{-}\mu\text{F}$ capacitor to ground.
GND	3, 6, 19, 22	Supply	Circuit ground.
MONB	2	Analog-out	Bias current monitor.
MONP	8	Analog-out	Photodiode current monitor.
NC	1, 9, 25		Do not connect.
PD	7	Analog	Photodiode input. Pin can source or sink current dependent on register setting.
RX_DIS	26	Digital-in	Disables the receiver output buffer when set to a high level. Includes a $250\text{-k}\Omega$ pull-up resistor to VCC. Ground the pin to enable the output. This is an ORed function with the RXOUT_DIS bit (bit 6 in register 4). This pin is 3.3-V tolerant.
RX_LOS	24	Digital-out	Receiver loss of signal. High level indicates that the receiver input signal amplitude is below the programmed threshold level. Open drain output. Requires an external $4.7\text{-k}\Omega$ to $10\text{-k}\Omega$ pull-up resistor to VCC for proper operation. This pin is 3.3-V tolerant.
RXIN+	20	Analog-in	Non-inverted receiver data input. On-chip differentially $100\ \Omega$ terminated to RXIN-. Must be AC coupled.
RXIN-	21	Analog-in	Inverted receiver data input. On-chip differentially $100\ \Omega$ terminated to RXIN+. Must be AC coupled.
RXOUT-	28	CML-out	Inverted receiver data output. $45\ \Omega$ back-terminated to VCC.
RXOUT+	29	CML-out	Non-inverted data output. $45\ \Omega$ back-terminated to VCC.

Pin Functions (continued)

NUMBER	NAME	Type	DESCRIPTION
SDA	17	Digital-in/out	2-wire interface serial data input. Requires an external 4.7-k Ω to 10-k Ω pull-up resistor to VCC. This pin is 3.3-V tolerant.
SCK	18	Digital-in	2-wire interface serial clock input. Requires an external 4.7-k Ω to 10-k Ω pull-up resistor to VCC. This pin is 3.3-V tolerant.
TX_DIS	32	Digital-in	Disables both bias and modulation currents when set to high state. Includes a 250-k Ω pull-up resistor to VCC. Requires an external 4.7 k Ω to 10 k Ω pull-up resistor to VCC for proper operation Toggle to reset a fault condition. This is an ORed function with the TXBIASEN bit (bit 2 in register 1). This pin is 3.3-V tolerant.
TXIN+	4	Analog-in	Non-inverted transmitter data input. On-chip differentially 100 Ω terminated to TXIN-. Must be AC coupled.
TXIN-	5	Analog-in	Inverted transmitter data input. On-chip differentially 100 Ω terminated to TXIN+. Must be AC coupled.
TX_FLT	31	Digital-out	Transmitter fault detection flag. High level indicates that a fault has occurred. Open drain output. Requires an external 4.7 k Ω to 10 k Ω pull-up resistor to VCC for proper operation. This pin is 3.3-V tolerant.
TXOUT-	12	CML-out	Inverted transmitter data output. Internally terminated in single-ended operation mode.
TXOUT+	13	CML-out	Non-Inverted transmitter data output.
VCC_RX	27, 30	Supply	2.5 V \pm 5% supply for the receiver.
VCC_TX	11, 14	Supply	2.5 V \pm 5% supply for the transmitter.
VDD	15	Supply	2.5 V \pm 5% supply for the digital circuitry.
Exposed Pad	EP		Exposed die pad. Solder to the PCB.

7 Specifications

7.1 Absolute Maximum Ratings ⁽¹⁾⁽²⁾

over operating free-air temperature range (unless otherwise noted)

		MIN	MAX	UNIT
Supply voltage	at VCC_TX, VCC_RX, VDD	-0.5	3	V
Voltage	at 3.3-V tolerant pins SDA, SCK, RX_LOS, RX_DIS, TX_FLT, TX_DIS	-0.5	3.6	V
	at all other pins MONB, TXIN+, TXIN-, PD, MONP, BIAS, TXOUT-, TXOUT+, AMP, RXIN+, RXIN-, COMP, RX_LF, RXOUT-, RXOUT+,	-0.5	3	V
Maximum current at transmitter input pins	TXIN+, TXIN-		10	mA
Maximum current at transmitter output pins	TXOUT+, TXOUT-		125	mA
Maximum current at receiver input pins	RXIN+, RXIN-		10	mA
Maximum current at receiver output pins	RXOUT+, RXOUT-		30	mA
Maximum junction temperature, T _J			125	°C
Storage temperature, T _{stg}		-65	150	°C

- (1) Stresses beyond those listed under “absolute maximum ratings” may cause permanent damage to the device. These are stress ratings only and functional operation of the device at these or any other conditions beyond those indicated under “recommended operating conditions” is not implied. Exposure to absolute-maximum-rated conditions for extended periods may affect device reliability.
- (2) All voltage values are with respect to network ground terminal.

7.2 ESD Ratings

		VALUE	UNIT
V _(ESD)	Electrostatic discharge	Human-body model (HBM), per ANSI/ESDA/JEDEC JS-001 ⁽¹⁾	±2000
		Charged-device model (CDM), per JEDEC specification JESD22-C101 ⁽²⁾	±750

- (1) JEDEC document JEP155 states that 500-V HBM allows safe manufacturing with a standard ESD control process.
- (2) JEDEC document JEP157 states that 250-V CDM allows safe manufacturing with a standard ESD control process.

7.3 Recommended Operating Conditions

over operating free-air temperature range (unless otherwise noted)

		MIN	TYP	MAX	UNIT
V _{CC}	Supply Voltage	2.37	2.5	2.63	V
V _{IH}	Digital input high voltage	2			V
V _{IL}	Digital input low voltage			0.8	V
	Photodiode current range	Control bit TXPDRNG = 1x, step size = 3 μA		3080	μA
		Control bit TXPDRNG = 01, step size = 1.5 μA		1540	
		Control bit TXPDRNG = 00, step size = 0.75 μA		770	
	Serial Data rate			11.7	Gbps
V _{AMP}	Amplitude control input voltage range	0		2	V
t _{R-IN}	Input rise time	20%–80%		30	ps
t _{F-IN}	Input fall time	20%–80%		30	ps
T _C	Temperature at thermal pad	-40		100	°C

7.4 Thermal Information

THERMAL METRIC ⁽¹⁾		RSM (VQFN)	UNIT
		32 PINS	
R _{θJA}	Junction-to-ambient thermal resistance	37.2	°C/W
R _{θJctop}	Junction-to-case (top) thermal resistance	30.1	°C/W
R _{θJB}	Junction-to-board thermal resistance	7.8	°C/W
Ψ _{JT}	Junction-to-top characterization parameter	0.4	°C/W
Ψ _{JB}	Junction-to-board characterization parameter	7.6	°C/W
R _{θJcbot}	Junction-to-case (bottom) thermal resistance	2.4	°C/W

(1) For more information about traditional and new thermal metrics, see the *Semiconductor and IC Package Thermal Metrics* application report, [SPRA953](#).

7.5 DC Electrical Characteristics

Over recommended operating conditions, open loop operation, V_{OUT} = 2 V_{PP} single-ended, I_(BIAS) = 80 mA, unless otherwise noted. Typical operating condition is at V_{CC} = 2.5 V and T_A = 25°C

PARAMETER		TEST CONDITIONS	MIN	TYP	MAX	UNIT
V _{CC}	Supply voltage		2.37	2.5	2.63	V
I _{VCC}	Supply current in single-ended TX mode	TXMODE = 1, TX V _{OUT} = 2 V _{PP} single-ended, I _(BIAS) = 0 mA; 600 mV _{PP} differential RX output		161	185	mA
	Power dissipation in single-ended TX mode			403	487	mW
	Supply current in differential TX mode	TXMODE = 0, TX V _{OUT} = 1.8 V _{PP} single-ended, I _(BIAS) = 0 mA; 600 mV _{PP} differential RX output		206	242	mA
	Power dissipation in differential TX mode			515	636	mW
R _(TXIN)	Transmitter data input resistance	Differential between TXIN+ / TXIN–		100		Ω
	Transmitter data input termination mismatch				5%	
R _(RXIN)	Receiver data input resistance	Differential between RXIN+ / RXIN–		100		Ω
R _(OUT)	Transmitter output resistance	Single-ended at TXOUT+ or TXOUT–		60		Ω
R _(RXOUT)	Receiver data output resistance	Differential between RXOUT+ or RXOUT–		90		Ω
	Receiver data output termination mismatch				5%	
	Digital input current	TX_DIS, RX_DIS pull up to V _{CC}	–20		20	μA
V _{OH}	Digital output high voltage	TX_FLT, RX_LOS, pull-up to V _{CC} , I _{SOURCE} = 37.5 μA	2.1			V
V _{OL}	Digital output low voltage	TX_FLT, RX_LOS, pull-up to V _{CC} , I _{SINK} = 350 μA			0.4	V
I _(BIAS-MIN)	Minimum bias current	See ⁽¹⁾			5	mA
I _(BIAS-MAX)	Maximum bias current	Source. BIASPOL = 0, DAC set to maximum, open and closed loop	145	150		mA
		Sink. BIASPOL = 1, DAC set to maximum, open and closed loop	95	100		
I _(BIAS-DIS)	Bias current during disable				100	μA
	Average power stability	APC loop enabled		±0.5		dB
	Bias pin compliance voltage	Source. TXBIASPOL = 0			V _{CC} -0.45	V
		Sink. TXBIASPOL = 1	0.45			
	Temperature sensor accuracy	With 1-point external mid-scale calibration		±3		°C
V _(PD)	Photodiode reverse bias voltage	APC active, I _(PD) = 1500 μA	1.3	2.3		V
	Photodiode fault current level	Percent of target I _(PD) ⁽²⁾		150%		
	Photodiode current monitor ratio	I _(MONP) / I _(PD) with control bit PDRNG = 1X	10%	12.5%	15%	
		I _(MONP) / I _(PD) with control bit PDRNG = 01	20%	25%	30%	
I _(MONP) / I _(PD) with control bit TXPDRNG = 00		40%	50%	60%		

(1) The bias current can be set below the specified minimum according to the corresponding register setting; however, in closed loop operation settings below the specified value may trigger a fault.

(2) Assured by design over process, supply and temperature variation

DC Electrical Characteristics (continued)

Over recommended operating conditions, open loop operation, $V_{OUT} = 2 V_{PP}$ single-ended, $I_{(BIAS)} = 80 \text{ mA}$, unless otherwise noted. Typical operating condition is at $V_{CC} = 2.5 \text{ V}$ and $T_A = 25^\circ\text{C}$

PARAMETER		TEST CONDITIONS	MIN	TYP	MAX	UNIT
	Monitor diode DMI accuracy	With external mid-scale calibration		±10%		
	Bias current monitor ratio	$I_{(MONB)} / I_{(BIAS)}$ (nominal 1/100 = 1%), $V_{(MONB)} < 1.5\text{V}$	0.9%	1%	1.1%	
	Bias current DMI accuracy	$I_{(BIAS)} \geq 20 \text{ mA}$	-15%		15%	
	Power supply monitor accuracy	With external mid-scale calibration	-2%		2%	
$V_{(CC-RST)}$	V_{CC} reset threshold voltage	V_{CC} voltage level which triggers power-on reset		1.8	2.1	V
$V_{(CC-RSTHYS)}$	V_{CC} reset threshold voltage hysteresis			100		mV
$V_{(MONB-FLT)}$	Fault voltage at MONB	TXFLTEN = 1, TXDMONB = 0, Fault occurs if voltage at MONB exceeds this value	1.15	1.2	1.25	V
$V_{(MONP-FLT)}$	Fault voltage at MONP	TXFLTEN = 1, TXMONPFLT = 1, TXDMONP = 0, Fault occurs if voltage at MONP exceeds this value	1.15	1.2	1.25	V

7.6 Transmitter AC Electrical Characteristics

Over recommended operating conditions, open loop operation, $V_{OUT} = 2 V_{PP}$ single-ended, $I_{(BIAS)} = 80$ mA unless otherwise noted. Typical operating condition is at $V_{CC} = 2.5$ V and $T_A = 25^\circ\text{C}$

PARAMETER	TEST CONDITIONS	MIN	TYP	MAX	UNIT
TX INPUT SPECIFICATIONS					
Data rate	CPRI, Ethernet, SONET, Fibre Channel	1		11.7	Gbps
Differential input return loss	0.05 GHz < f ≤ 0.1 GHz	20			dB
	0.1 GHz < f ≤ 5.5 GHz	12	15		
	5.5 GHz < f < 12 GHz	8			
Differential to common mode conversion	0.1 GHz < f < 12 GHz	10	15		dB
Common mode input return loss	0.1 GHz < f < 12 GHz	3			dB
Input AC common mode voltage tolerance		15			mV
V_{IN} Differential input voltage swing		100		1000	mV _{PP}
EQ _(boost) EQ high freq boost	Maximum setting; 7 GHz	6	9		dB
TX OUTPUT SPECIFICATIONS					
Differential output return loss	0.01 GHz < f < 12 GHz		12		dB
$V_{O(MIN)}$ Minimum output amplitude	AC Coupled Outputs, 50-Ω single-ended load			0.5	V_{PP}
TX OUTPUT SPECIFICATIONS in SINGLE-ENDED MODE of OPERATION (TXMODE = 1)					
$V_{O(MAX)}$ Maximum output amplitude	AC Coupled Outputs, 50-Ω load, single-ended	2			V_{PP}
Output amplitude stability	AC Coupled Outputs, 50-Ω load, single-ended		230		mV _{PP}
High Cross Point Control Range	50-Ω load, single-ended	70%	75%		
Low Cross Point Control Range	50-Ω load, single-ended		35%	40%	
Cross Point Stability	50-Ω load, single-ended	-5		5	pp
Output de-emphasis	TXDEADJ[0..3] = 1111, TXPKSEL = 0		5		dB
	TXDEADJ[0..3] = 1111, TXPKSEL = 1		6		
TX OUTPUT SPECIFICATIONS in DIFFERENTIAL MODE of OPERATION (TXMODE = 0)					
$V_{O(MAX)}$ Maximum output amplitude	AC Coupled Outputs, 100-Ω differential load	3.6			V_{PP}
Output amplitude stability	AC Coupled Outputs, 100-Ω differential load		230		mV _{PP}
High Cross Point Control Range	100-Ω differential load	65%	75%		
Low Cross Point Control Range	100-Ω differential load		35%	40%	
Cross Point Stability	100-Ω differential load	-5		5	pp
Output de-emphasis	TXDEADJ[0..3] = 1111, TXPKSEL = 0		5		dB
	TXDEADJ[0..3] = 1111, TXPKSEL = 1		6		

7.7 Receiver AC Electrical Characteristics

Over recommended operating conditions, outputs connected to a 50-Ω load, $V_{OD} = 600$ mVpp differential unless otherwise noted. Typical operating condition is at $V_{CC} = 2.5$ V and $T_A = 25^\circ\text{C}$

PARAMETER		TEST CONDITIONS	MIN	TYP	MAX	UNIT
RX INPUT SPECIFICATIONS						
	Data rate	CPRI, Ethernet, SONET, Fibre Channel	1		11.7	Gbps
	Differential input return loss	0.01 GHz < f ≤ 5 GHz		15		dB
		5 GHz < f < 12 GHz		8		
	Differential to common mode conversion	0.1 GHz < f < 12 GHz		15		dB
$V_{I(RX,MIN)}$	Data input sensitivity	TXOUT_DIS = 1, PRBS31 pattern at 11.7Gbps, BER < 10^{-12}		6	9	mV _{PP}
$V_{I(RX,MAX)}$	Data input overload		800			mV _{PP}
$J_{(T,RX)}$	Sinusoidal jitter tolerance	9.95 Gbps, BER = 10^{-12} , f = 400kHz	1.5			UI _{PP}
		9.95 Gbps, BER = 10^{-12} , f = 4MHz	0.4			
		9.95 Gbps, BER = 10^{-12} , f = 80MHz	0.4			
RX OUTPUT SPECIFICATIONS						
	Differential output return loss	0.05 GHz < f ≤ 0.1 GHz	20			dB
		0.1 GHz < f < 5.5 GHz	8	15		
		5.5 GHz < f < 12 GHz	8			
	Common mode input return loss	0.1 GHz < f < 12 GHz	3			dB
$CMOV_{(RX)}$	Output AC common mode voltage	PRBS31 pattern, RXAMP[0..3] = 0001			7	mV _{rms}
f_{3dB-L}	Low frequency –3dB bandwidth			20	50	kHz
$D_{(J,RX)}$	Deterministic output jitter				0.1	UI _{PP}
$T_{(J,RX)}$	Total output jitter				0.2	UI _{PP}
V_{OD}	Differential data output voltage	$V_{IN} > 25$ mV _{PP} , RX_DIS = 0, RXAMP[0..3] = 0000		300		mV _{PP}
		$V_{IN} > 25$ mV _{PP} , RX_DIS = 0, RXAMP[0..3] = 1111		900		mV _{PP}
		RX_DIS = 1			5	mV _{rms}
	Output De-emphasis	RXDADJ[0..1] = 11		1		dB
RX LOS SPECIFICATIONS						
V_{TH}	LOW LOS assert threshold range min	PRBS7 pattern at 11.3Gbps, RXLOS RNG = 1		10		mV _{PP}
	LOW LOS assert threshold range max	PRBS7 pattern at 11.3Gbps, RXLOS RNG = 1		50		
V_{TH}	HIGH LOS assert threshold range min	PRBS7 pattern at 11.3Gbps, RXLOS RNG = 0		40		mV _{PP}
	HIGH LOS assert threshold range max	PRBS7 pattern at 11.3Gbps, RXLOS RNG = 0		130		
	LOS hysteresis (electrical)		2	4	6	dB
	LOS threshold variation	Versus temperature		1.5		dB
		Versus supply voltage		1		
		Versus data rate		1.5		

7.8 Timing Requirements

Over recommended operating conditions, open loop operation, TXOUT+ = 2 V_{PP} singled-ended, I_(BIAS) = 80 mA, V_{OD} = 600 mV_{PP} differential (unless otherwise noted). Typical operating condition is at V_{CC} = 2.5 V and T_A = 25°C

			MIN	TYP	MAX	UNIT
t _(APC)	APC time constant	C _{APC} 0.01 μF, I _{PD} = 500 μA, PD coupling ratio CR = 150, PDRNG = 01		50		μs
t _(INIT1)	Power-on to initialize	Power-on to registers ready to be loaded		0.2	1	ms
t _(INIT2)	Initialize to transmit	Register load STOP command to part ready to transmit valid data			2	ms
t _(OFF)	Transmitter disable time	Rising edge of TX_DIS to I _(BIAS) ≤ 0.1 × I _(BIAS-NOMINAL)		1	5	μs
t _(ON)	Disable negate time	Falling edge of TX_DIS to I _(BIAS) ≥ 0.9 × I _(BIAS-NOMINAL)			1	ms
t _(RESET)	TX_DIS pulse width	Time TX_DIS must held high to reset part	100			ns
t _(FAULT)	Fault assert time	Time from fault condition to FLT high			50	μs
TX OUTPUT SPECIFICATIONS in SINGLE-ENDED MODE of OPERATION (TXMODE = 1)						
t _{R(OUTTX)}	Output rise time	20% - 80%, AC Coupled Outputs, 50-Ω load, single-ended		30	42	ps
t _{F(OUTTX)}	Output fall time	20% - 80%, AC Coupled Outputs, 50-Ω load, single-ended		30	42	ps
ISI _(TX)	Intersymbol interference	TXEQ_DIS = 1, 11.3 Gbps, PRBS9 pattern, 150-mVpp, 600-mVpp, 1200-mVpp differential input voltage		4	12	ps
		TXEQ_DIS = 0, 11.3 Gbps, PRBS9 pattern, 150-mVpp, 600-mVpp, 1200-mVpp differential input voltage, maximum equalization with 18-inch transmission line at the input.		7		
R _(J-TX)	Serial data output random jitter			0.4	1	ps _{RMS}
	Output de-emphasis width	TXPKSEL = 0		28		ps
		TXPKSEL = 1		35		
TX OUTPUT SPECIFICATIONS in DIFFERENTIAL MODE of OPERATION (TXMODE = 0)						
t _{R(OUTTX)}	Output rise time	20%–80%, AC Coupled Outputs, 100-Ω differential load		30	42	ps
t _{F(OUTTX)}	Output fall time	20%–80%, AC Coupled Outputs, 100-Ω differential load		30	42	ps
ISI _(TX)	Intersymbol interference	TXEQ_DIS = 1, 11.3 Gbps, PRBS9 pattern, 150-mVpp, 600-mVpp, 1200-mVpp differential input voltage		4	10	ps
		TXEQ_DIS = 0, 11.3 Gbps, PRBS9 pattern, 150-mVpp, 600-mVpp, 1200-mVpp differential input voltage, maximum equalization with 18-inch transmission line at the input.		7		
R _(J-TX)	Serial data output random jitter			0.4	1	ps _{RMS}
	Output Peaking Width	TXPKSEL = 0		28		ps
		TXPKSEL = 1		35		
RX OUTPUT SPECIFICATIONS						
t _{R(OUTRX)}	Output rise time	20%–80%, 100-Ω differential load, adjustable		30	40	ps
t _{F(OUTRX)}	Output fall time	20%–80%, 100-Ω differential load, adjustable		30	40	ps
	Serial data output deterministic jitter	PRBS9 pattern 11.3 Gbps, V _{IN} = 15 mVpp to 900 mVpp		3	10	ps
RX LOS SPECIFICATIONS						
t _(LOS_AST)	LOS assert time		2.5	10	50	μs
t _(LOS_DEA)	LOS deassert time		2.5	10	50	μs



图 1. 2-Wire Interface Diagram

表 1. Timing Diagram Definitions

Symbol	Description	Min	Max	Unit
f_{SCK}	SCK clock frequency		400	kHz
t_{BUF}	Bus free time between START and STOP conditions	1.3		μ s
t_{HDSTA}	Hold time after repeated START condition. After this period, the first clock pulse is generated	0.6		μ s
t_{LOW}	Low period of the SCK clock	1.3		μ s
t_{HIGH}	High period of the SCK clock	0.6		μ s
t_{SUSTA}	Setup time for a repeated START condition	0.6		μ s
t_{HDDAT}	Data HOLD time	0		μ s
t_{SUDAT}	Data setup time	100		ns
t_R	Rise time of both SDA and SCK signals		300	ns
t_F	Fall time of both SDA and SCK signals		300	ns
t_{SUSTO}	Setup time for STOP condition	0.6		μ s

7.9 Typical Characteristics

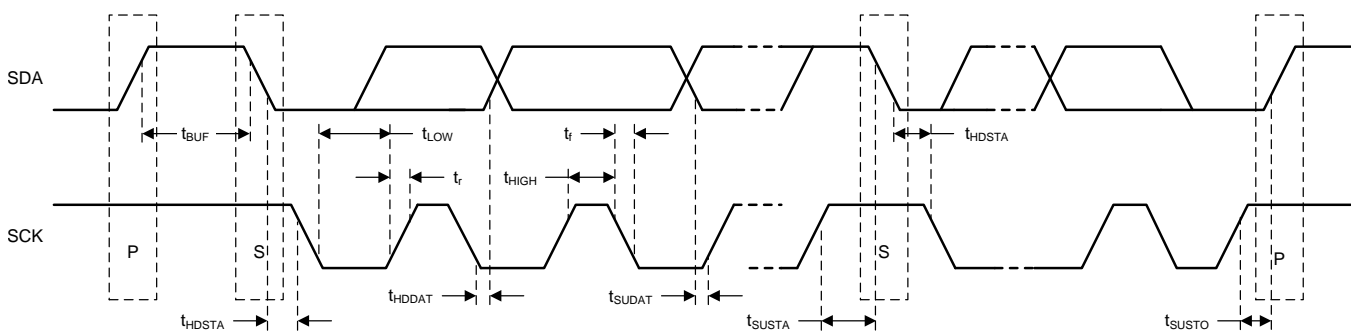
Typical operating condition is at $V_{CC} = 2.5\text{ V}$, $T_A = 25^\circ\text{C}$, $\text{TXOUT+} = 2\text{ V}_{PP}$ Single-ended, $\text{RXOUT} = 600\text{ mV}_{PP}$ differential, $\text{TXIN} = 600\text{ mV}_{PP}$ differential (unless otherwise noted).

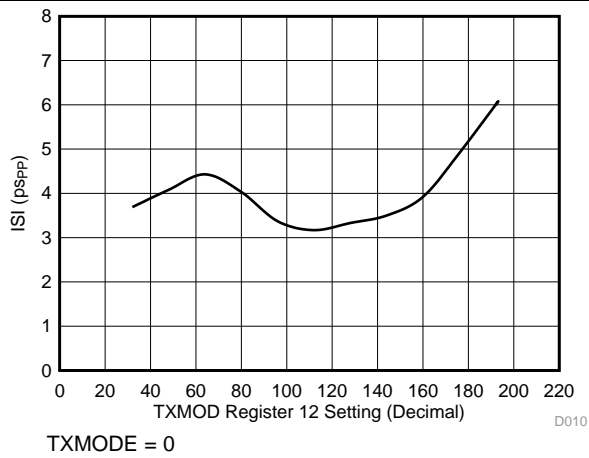

Figure 2. TX Deterministic Jitter vs Modulation Current

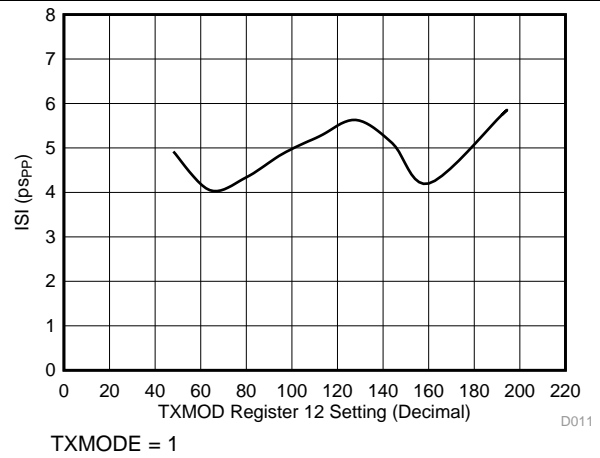

Figure 3. TX Deterministic Jitter vs Modulation Current

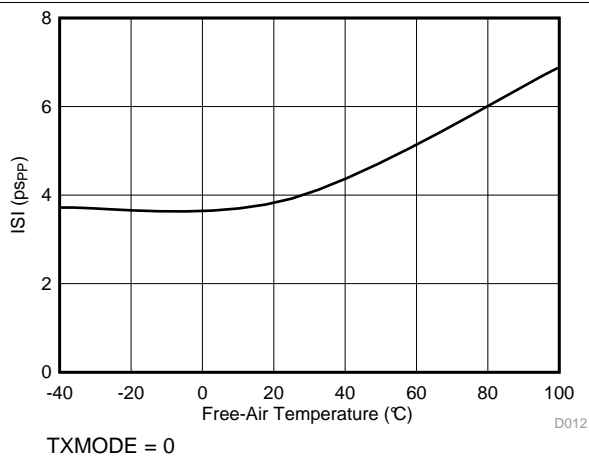

Figure 4. TX Deterministic Jitter vs Temperature

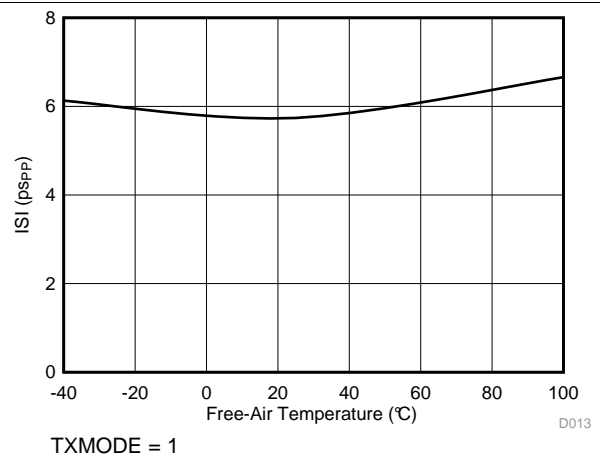

Figure 5. TX Deterministic Jitter vs Temperature

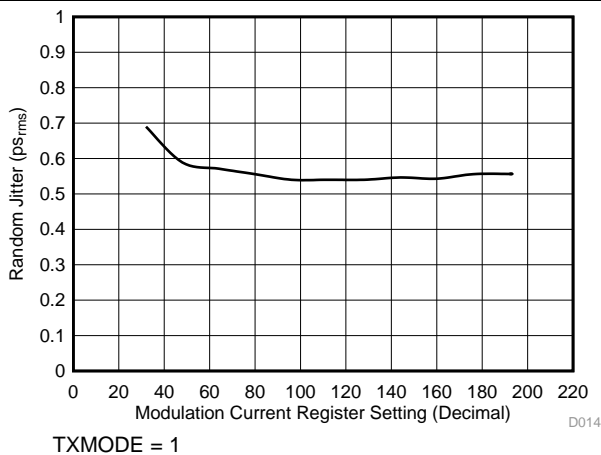

Figure 6. TX Random Jitter vs Modulation Current

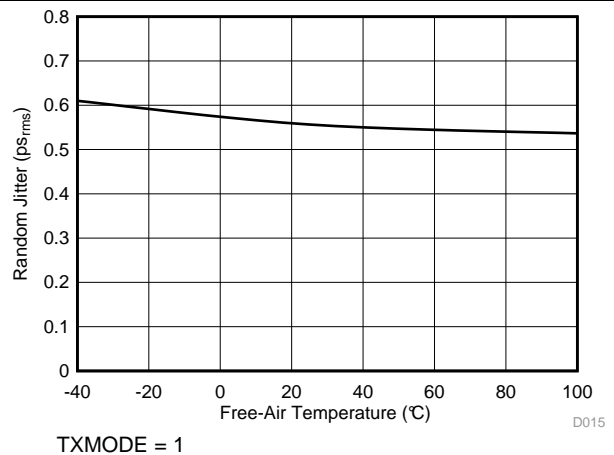

Figure 7. TX Random Jitter vs Temperature

Typical Characteristics (continued)

Typical operating condition is at $V_{CC} = 2.5\text{ V}$, $T_A = 25^\circ\text{C}$, $\text{TXOUT+} = 2\text{ V}_{PP}$ Single-ended, $\text{RXOUT} = 600\text{ mV}_{PP}$ differential, $\text{TXIN} = 600\text{ mV}_{PP}$ differential (unless otherwise noted).

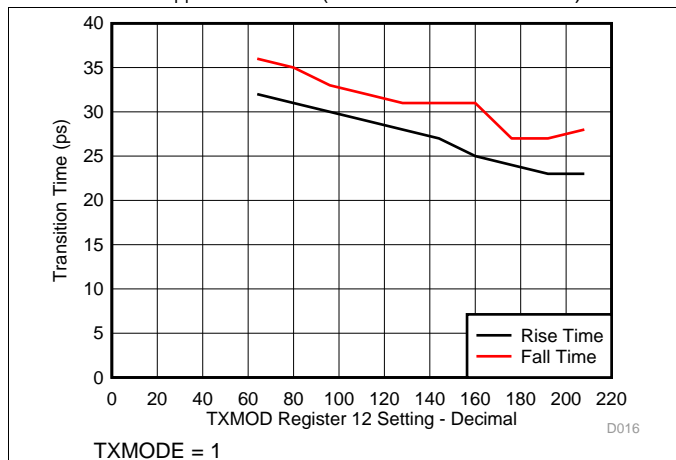

Figure 8. TX Rise-Time and Fall-Time vs Modulation Current

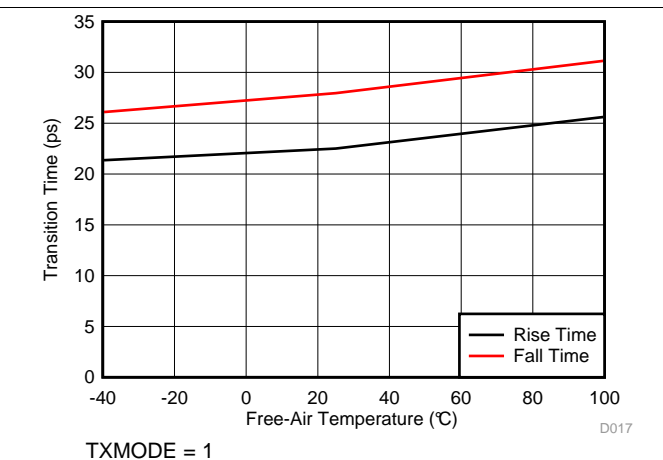

Figure 9. TX Rise-Time and Fall-Time vs Temperature

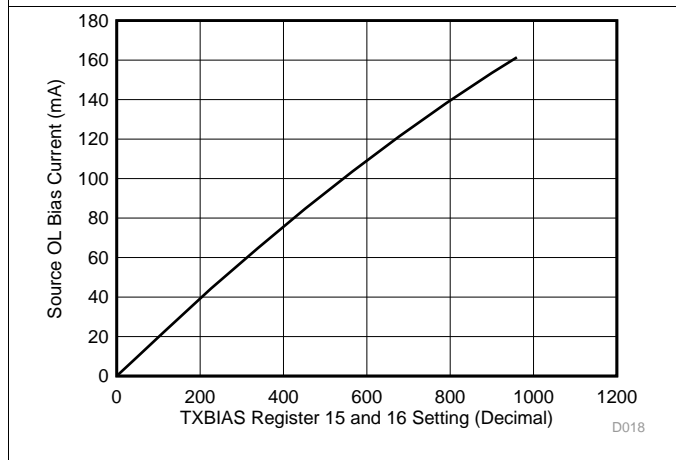

Figure 10. Source Bias Current in Open Loop Mode vs Bias Register Setting

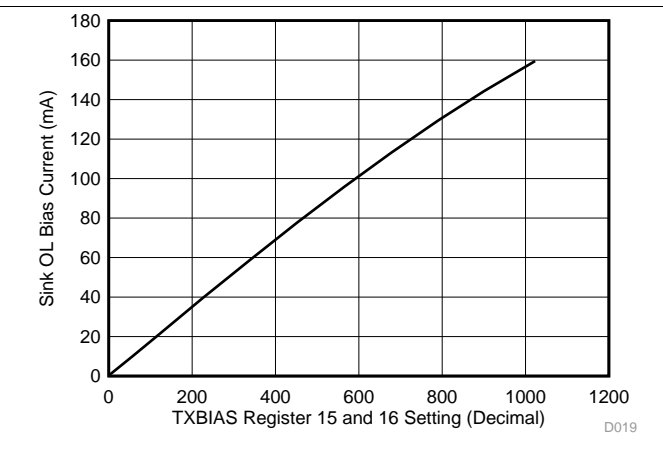

Figure 11. Sink Bias Current in Open Loop Mode vs Bias Register Setting

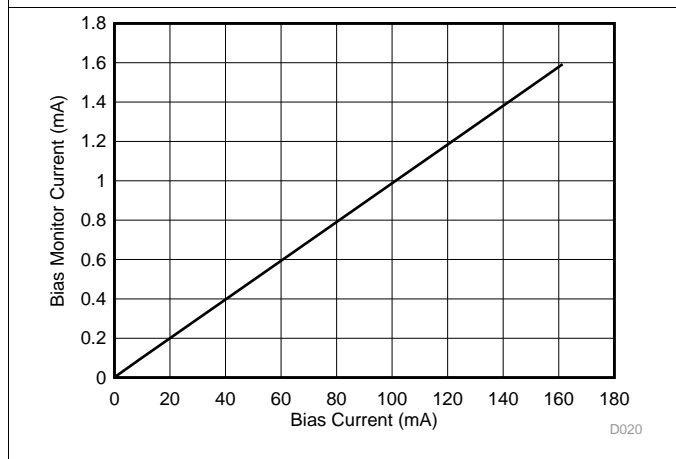

Figure 12. Bias-Monitor Current $I_{(MONB)}$ vs Bias Current

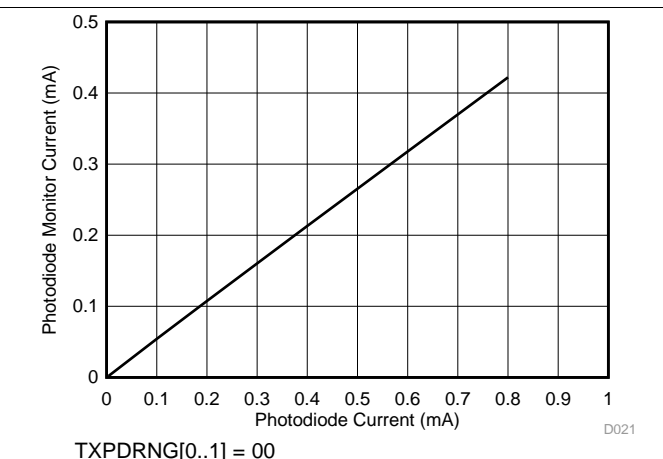

Figure 13. Photodiode-Monitor Current $I_{(MONP)}$ vs PD Current

Typical Characteristics (continued)

Typical operating condition is at $V_{CC} = 2.5\text{ V}$, $T_A = 25^\circ\text{C}$, $\text{TXOUT+} = 2\text{ V}_{PP}$ Single-ended, $\text{RXOUT} = 600\text{ mV}_{PP}$ differential, $\text{TXIN} = 600\text{ mV}_{PP}$ differential (unless otherwise noted).

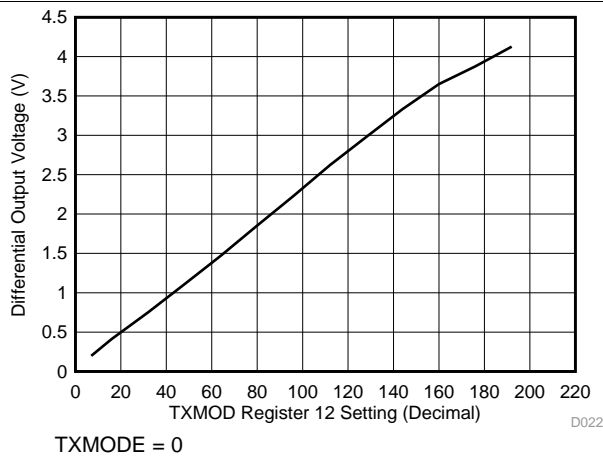

Figure 14. Output Voltage vs Modulation Current

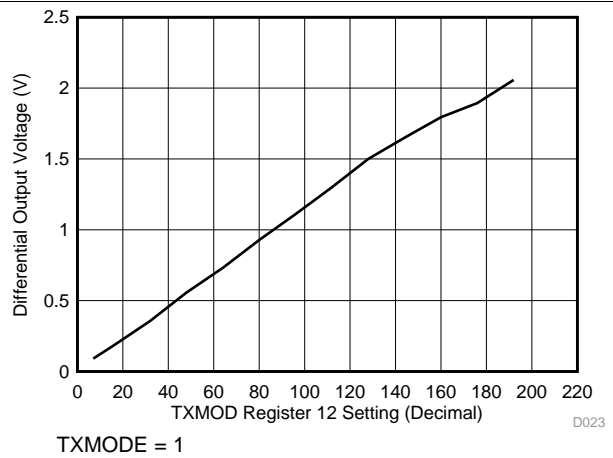

Figure 15. Output Voltage vs Modulation Current

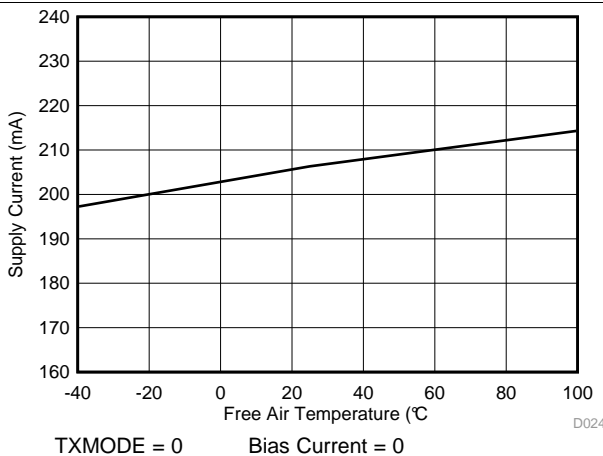

Figure 16. Supply Current vs Temperature

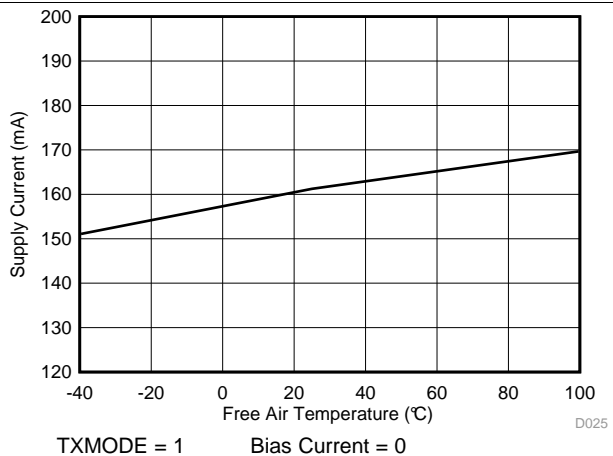

Figure 17. Supply Current vs Temperature

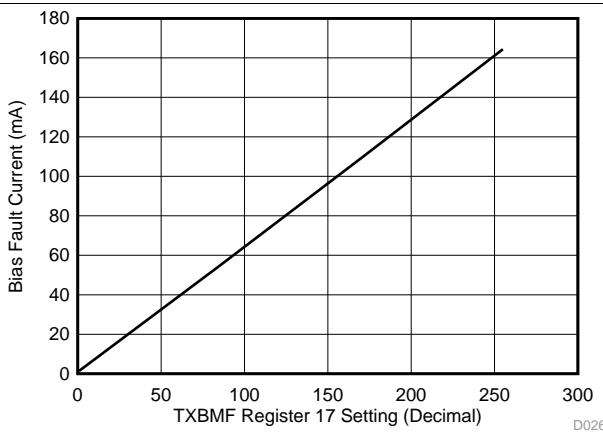

Figure 18. Bias Current Monitor Fault vs TXBMF Register Setting

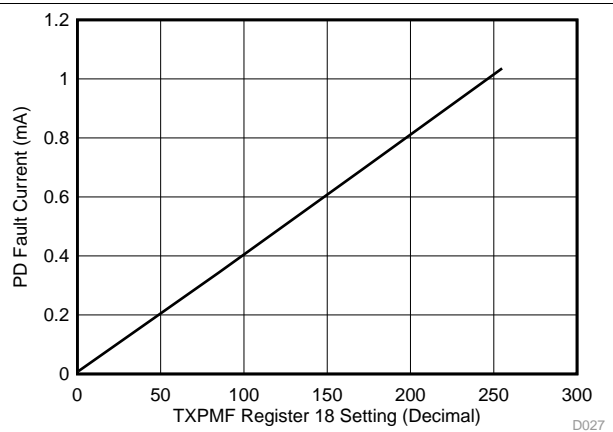

Figure 19. Photodiode Current Monitor Fault vs TXPMF Register Setting

Typical Characteristics (continued)

Typical operating condition is at $V_{CC} = 2.5\text{ V}$, $T_A = 25^\circ\text{C}$, TXOUT+ = 2 V_{pp} Single-ended, RXOUT = 600 mV_{pp} differential, TXIN = 600 mV_{pp} differential (unless otherwise noted).

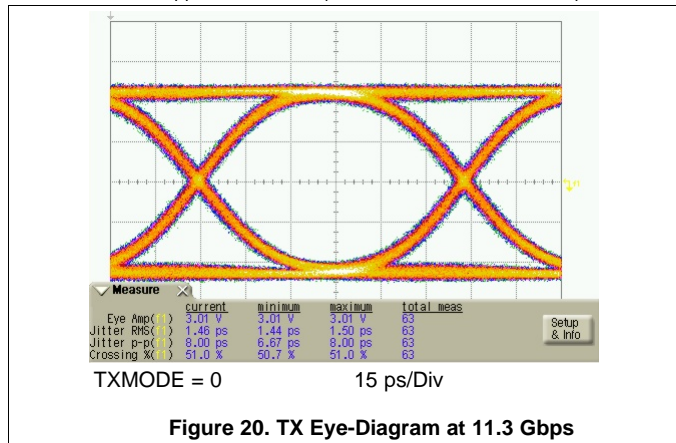

Figure 20. TX Eye-Diagram at 11.3 Gbps

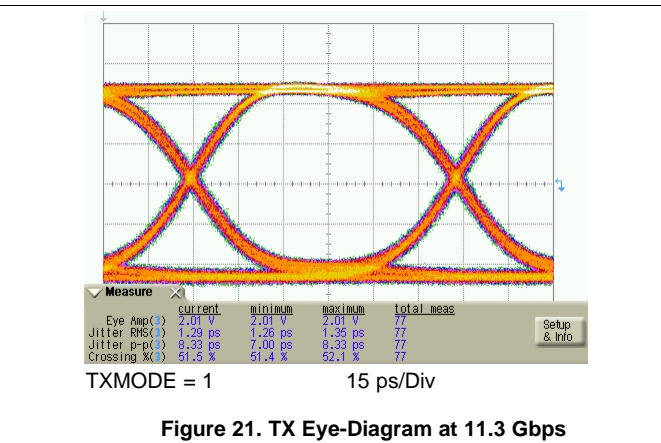

Figure 21. TX Eye-Diagram at 11.3 Gbps

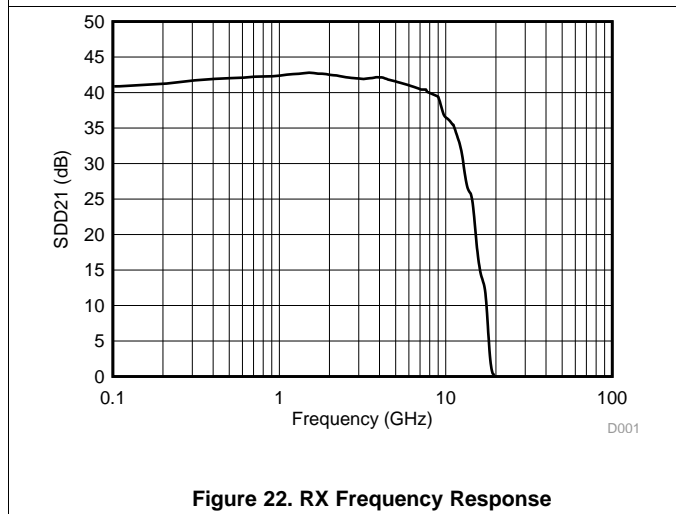

Figure 22. RX Frequency Response

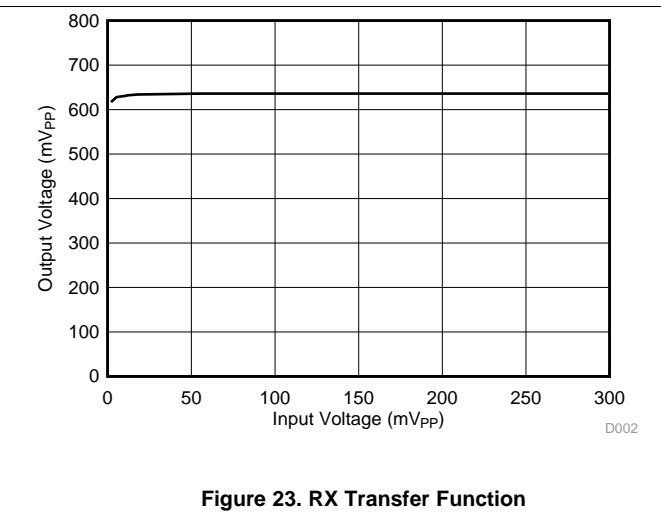

Figure 23. RX Transfer Function

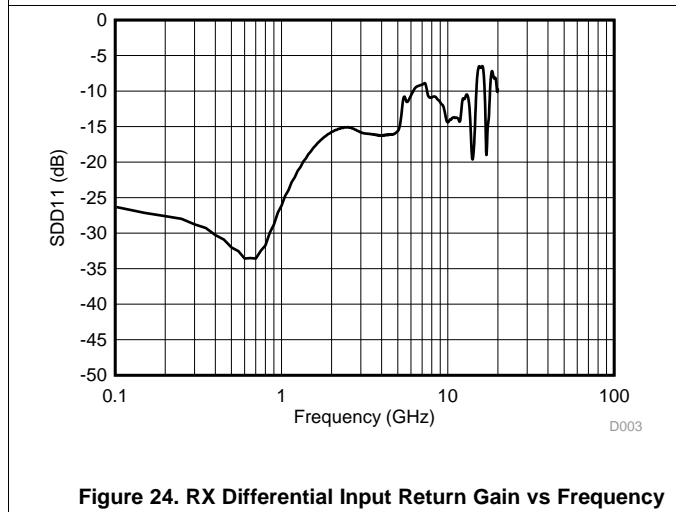

Figure 24. RX Differential Input Return Gain vs Frequency

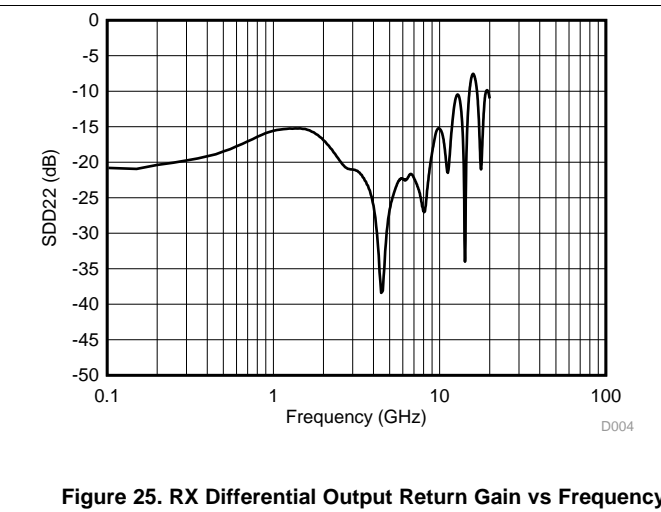
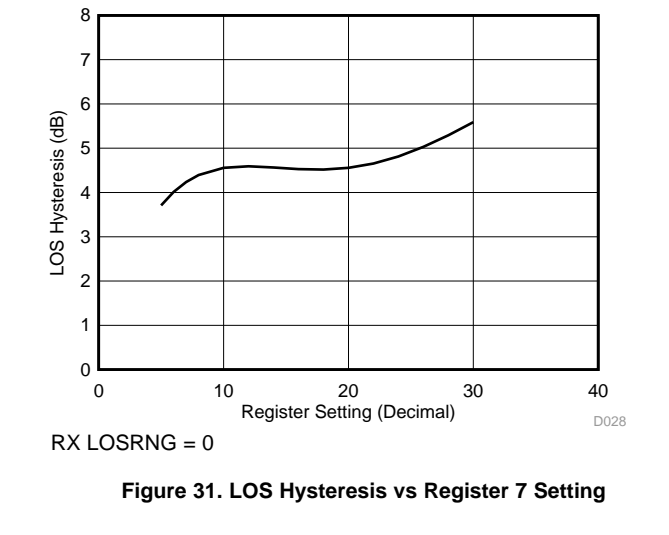
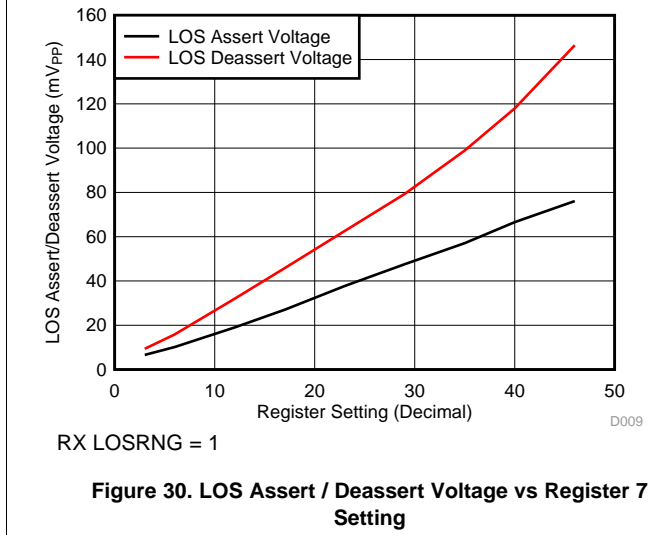
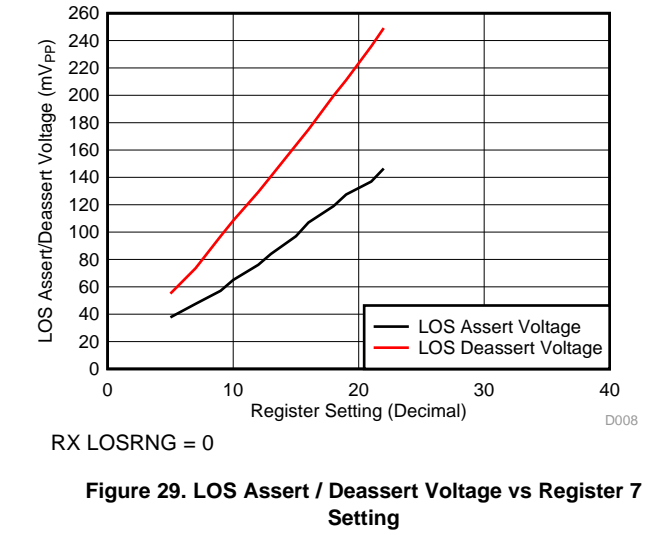
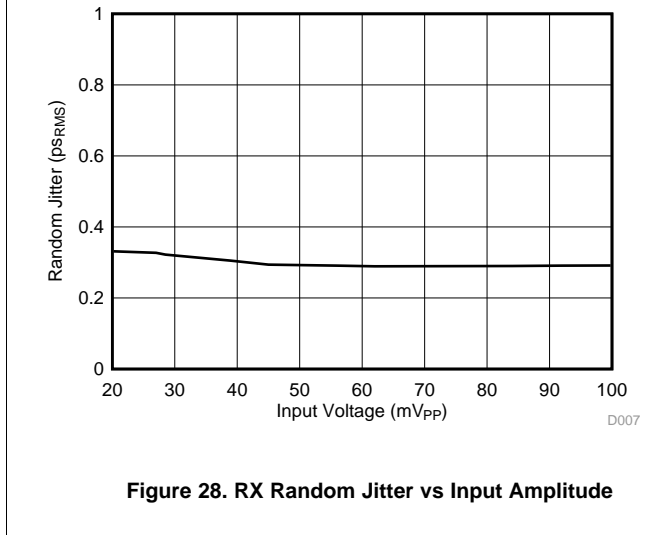
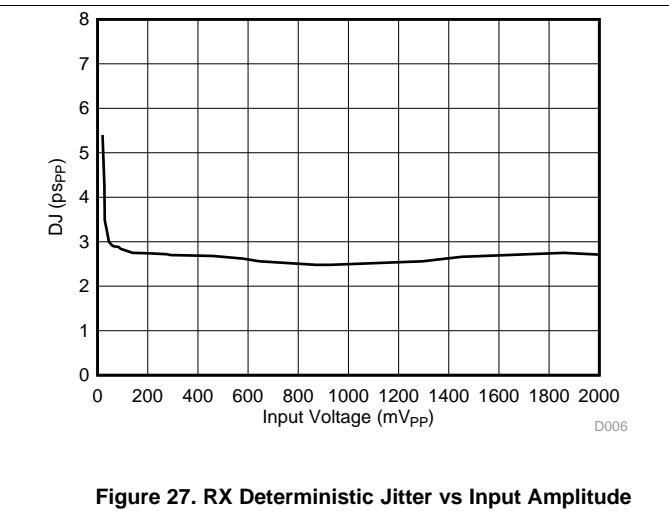
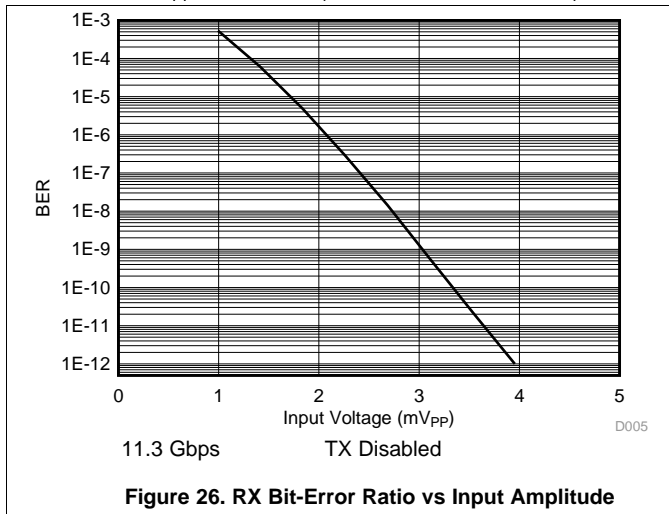

Figure 25. RX Differential Output Return Gain vs Frequency

Typical Characteristics (continued)

Typical operating condition is at $V_{CC} = 2.5\text{ V}$, $T_A = 25^\circ\text{C}$, $\text{TXOUT+} = 2\text{ V}_{PP}$ Single-ended, $\text{RXOUT} = 600\text{ mV}_{PP}$ differential, $\text{TXIN} = 600\text{ mV}_{PP}$ differential (unless otherwise noted).



Typical Characteristics (continued)

Typical operating condition is at $V_{CC} = 2.5\text{ V}$, $T_A = 25^\circ\text{C}$, $\text{TXOUT+} = 2\text{ V}_{PP}$ Single-ended, $\text{RXOUT} = 600\text{ mV}_{PP}$ differential, $\text{TXIN} = 600\text{ mV}_{PP}$ differential (unless otherwise noted).

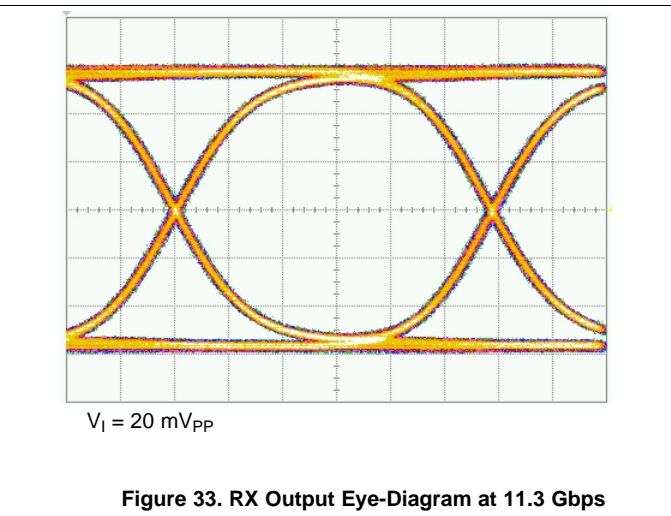
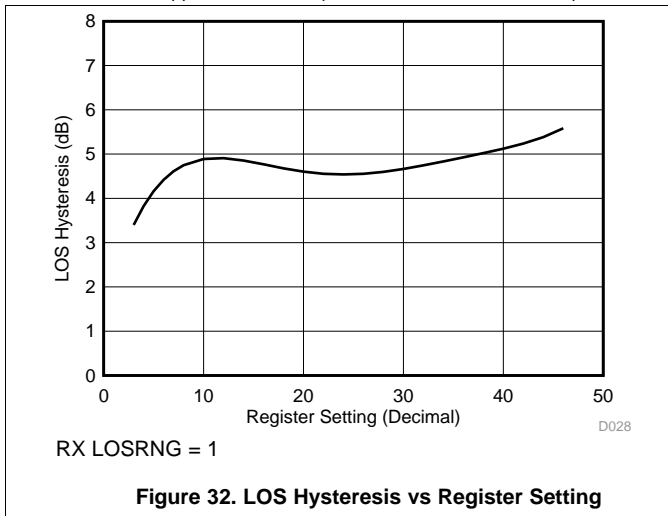

8 Detailed Description

8.1 Overview

A simplified block diagram of the ONET1130EP is shown in [Functional Block Diagram](#).

The ONET1130EP consists of a transmitter path, a receiver path, an analog reference block, an analog to digital converter and a 2-wire serial interface and control logic block with power-on reset.

The transmit path consists of an adjustable input equalizer, and an output modulator driver. The output driver provides a differential output voltage but can be operated in a single-ended mode to reduce the power consumption. Output waveform control, in the form of cross-point adjustment and de-emphasis are available to improve the optical eye mask margin. Bias current for the laser is provided and an integrated automatic power control (APC) loop to compensate for variations in average optical power over voltage, temperature and time is included.

The receive path consists of a limiting amplifier with programmable equalization and threshold adjustment, and an output driver with de-emphasis to compensate for frequency dependent loss of connectors and transmission lines. The receiver output amplitude, de-emphasis and loss of signal assert level can be adjusted.

The ONET1130EP contains an analog to digital converter to support transceiver digital diagnostics and can report the supply voltage, laser bias current, laser photodiode current and internal temperature.

The 2-wire serial interface is used to control the operation of the device and read the status of the control registers.

The device contains internal EEPROM for trimming purposes only.

8.2 Functional Block Diagram

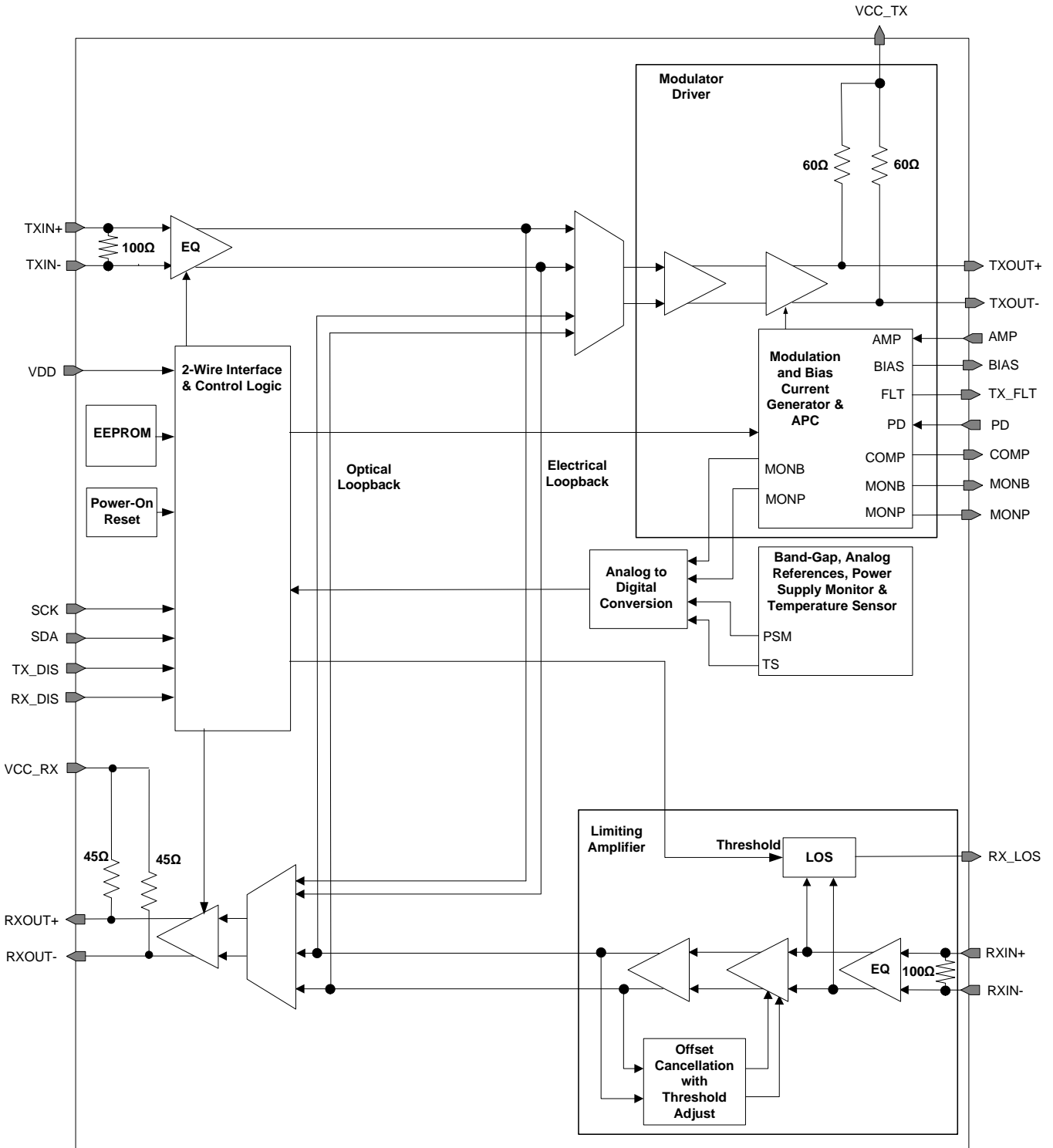

8.3 Feature Description

8.3.1 Transmitter

8.3.1.1 Equalizer

The data signal is applied to an input equalizer by means of the input signal pins TXIN+ / TXIN–, which provide on-chip differential 100-Ω line termination. The equalizer is enabled by default and can be disabled by setting the transmitter equalizer disable bit TXEQ_DIS = 1 (bit 1 of [register 10](#)). Equalization of up to 300 mm (12 inches) of microstrip or stripline transmission line on FR4 printed circuit boards can be achieved. The amount of equalization is set through register settings TXCTLE [0..3] ([register 11](#)). The device can accept input amplitude levels from 100 mVpp up to 1000 mVpp.

8.3.1.2 Modulator Driver

The modulation current is sunk from the common emitter node of the limiting output driver differential pair by means of a modulation current generator, which is digitally controlled by the 2-wire serial interface.

The collector nodes of the output stages are connected to the transmitter output pins TXOUT+ and TXOUT–. The collectors have internal 50Ω back termination resistors to VCC_TX. The outputs are optimized to drive a 50 Ω single-ended load and to obtain the maximum single-ended output voltage of 2.0Vpp, AC coupling and inductive pull-ups to VCC are required. For reduced power consumption the DC resistance of the inductive pull-ups should be minimized to provide sufficient headroom on the TXOUT+ and TXOUT– pins.

The polarity of the output pins can be inverted by setting the transmitter output polarity switch bit, TXOUTPOL (bit 5 of [register 10](#)) to 1. In addition, the output driver can be disabled by setting the transmitter output driver disable bit TXOUT_DIS = 1 (bit 6 of [register 10](#)).

The output driver is set to differential output by default. In order to reduce the power consumption for single-ended applications driving an electroabsorptive modulated laser (EML) the output drive [register 13](#) should be set to single-ended mode. The single-ended output signal is enabled by setting the transmitter mode select bit TXMODE = 1 (bit 6 of [register 13](#)). The positive output is active by default. To enable the negative output and disable the positive output set TXOUTSEL = 1 (bit 7 of [register 13](#)).

Output de-emphasis can be applied to the signal by adjusting the transmitter de-emphasis bits TXDEADJ[0..3] (bits 0 to 3 of [register 13](#)). In addition, the width of the applied de-emphasis can be increased by setting the transmitter output peaking width TXPKSEL = 1 (bit 6 of [register 11](#)). The wide peaking width would typically be useful for a more capacitive transmitter load. How de-emphasis is applied is controlled through the TXSTEP bit (bit 5 of [register 13](#)). Setting TXSTEP = 1 delays the time of the applied de-emphasis and has more of an impact on the falling edge. A graphical representation of the two de-emphasis modes is shown in [Figure 34](#). Using de-emphasis can help to optimize the transmitted output signal; however, it will add to the power consumption.

The output edge speed can be set to slow mode of operation through the TXSLOW bit (bit 4 of [register 13](#)). For transmitter modulation output settings (TXMOD - [register 12](#)) below 0xC0 it is recommended to set TXSLOW = 1 to reduce the output jitter.

Feature Description (接下页)



图 34. Transmitter De-Emphasis Modes

8.3.1.3 Modulation Current Generator

The modulation current generator provides the current for the high speed output driver described above. The circuit can be digitally controlled through the 2-wire interface block or controlled by applying an analog voltage in the range of 0 to 2V to the AMP pin. The default method of control is through the 2-wire interface. To use the AMP pin set the transmitter amplitude control bit TXAMPCTRL = 1 (bit 0 of [register 10](#)).

An 8-bit wide control bus, TXMOD[0..7] ([register 12](#)), is used to set the desired modulation current and the output voltage.

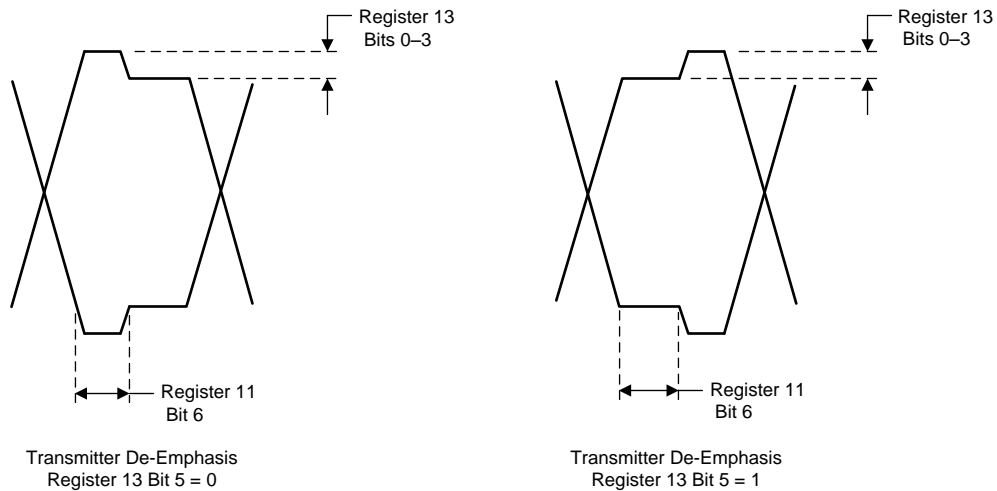
The entire transmitter signal path,, can be disabled and powered down by setting TX_DIS = 1 (bit 7 of [register 10](#)).

Feature Description (接下页)

8.3.1.4 DC Offset Cancellation and Cross Point Control

The ONET1130EP transmitter has DC offset cancellation to compensate for internal offset voltages. The offset cancellation can be disabled by setting TXOC_DIS = 1 (bit 2 of [register 10](#)).

The crossing point can be moved toward the one level by setting TXCPSGN = 1 (bit 7 of [register 14](#)) and it can be moved toward the zero level by setting TXCPSGN = 0. The percentage of shift depends upon the register settings of the transmitter cross-point adjustment bits TXCPADJ[0..6] ([register 14](#)).

8.3.1.5 Transmitter Loopback (Electrical Loopback)

The signal input to the TXIN+ and TXIN– pins can be looped back to the receiver output as shown in [图 35](#) by setting TX_LBMUX = 1 (bit 0 of [register 2](#)). Loopback from the receiver input to the transmitter output (optical loopback) can be enabled at the same time.

Feature Description (接下页)



图 35. Electrical Loopback

Feature Description (接下页)

8.3.1.6 Bias Current Generation and APC Loop

The bias current for the laser is turned off by default and has to be enabled by setting the laser bias current enable bit TXBIASEN = 1 (bit 2 of [register 1](#)). In open loop operation, selected by setting TXOLENA = 1 (bit 4 of [register 1](#)), the bias current is set directly by the 10-bit wide control word TXBIAS[0..9] ([register 15](#) and [register 16](#)). In Automatic Power Control (APC) mode, selected by setting TXOLENA = 0, the bias current depends on the register settings TXBIAS[0..9] and the coupling ratio (CR) between the laser bias current and the photodiode current. $CR = I_{BIAS}/I_{PD}$. If the photodiode cathode is connected to VCC and the anode is connected to the PD pin (PD pin is sinking current) set TXPDPOL = 1 (bit 0 of [register 1](#)). If the photodiode anode is connected to ground and the cathode is connected to the PD pin (PD pin is sourcing current), set TXPDPOL = 0.

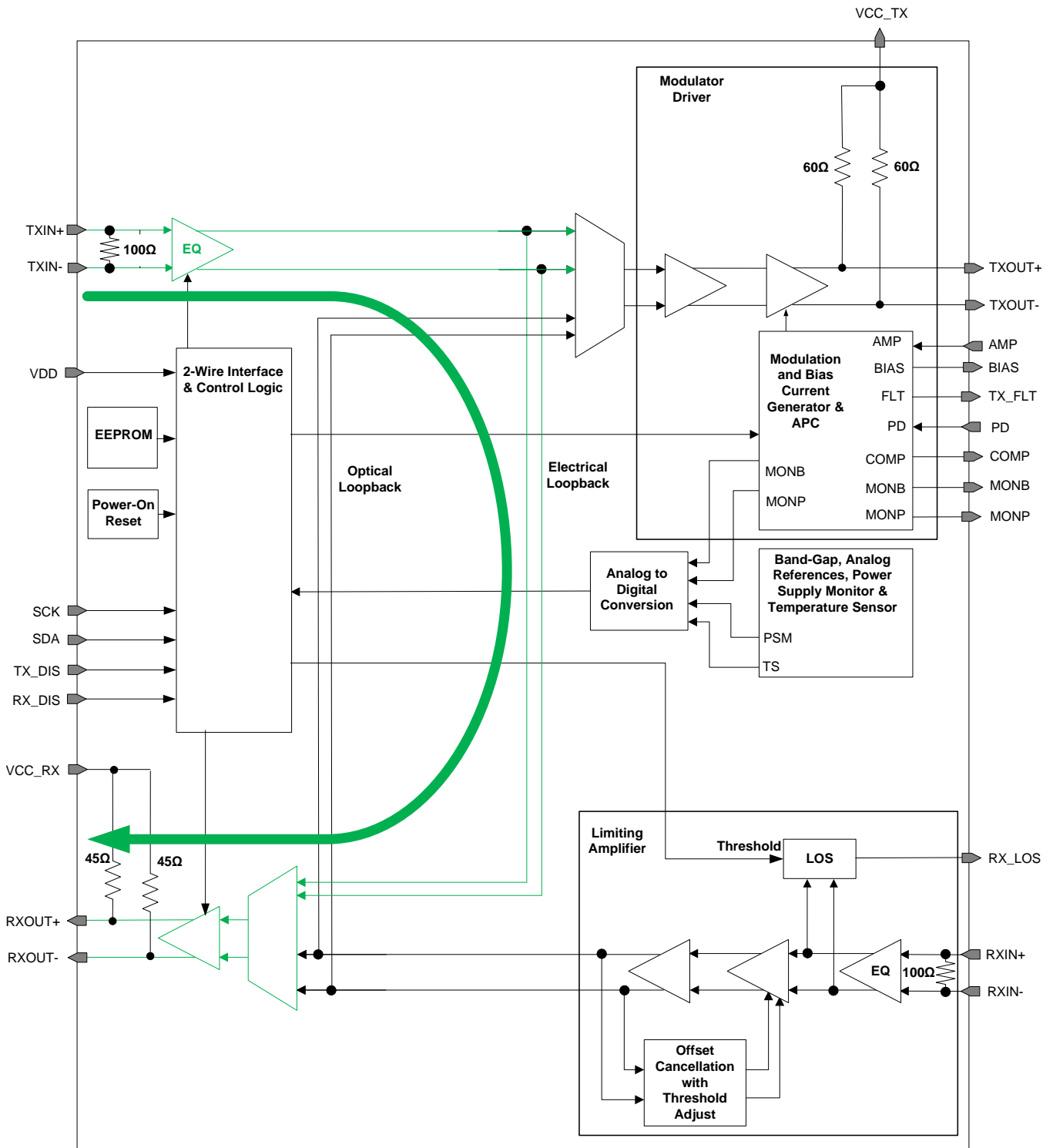
Three photodiode current ranges can be selected by means of the photodiode current range bits TXPDRNG[0..1] (bits 5 and 6 of [register 1](#)). The photodiode range should be chosen to keep the laser bias control DAC, TXBIAS[0..9], close to the center of its range. This keeps the laser bias current set point resolution high. For details regarding the bias current setting in open-loop mode as well as in closed-loop mode, see the [Register Mapping](#) table.

The ONET1130EP has the ability to source or sink the bias current. The default condition is for the BIAS pin to source the current (TXBIASPOL = 0). To act as a sink, set TXBIASPOL = 1 (bit 1 of [register 1](#)).

The bias current is monitored using a current mirror with a gain equal to 1/100. By connecting a resistor between MONB and GND, the bias current can be monitored as a voltage across the resistor. A low temperature coefficient precision resistor should be used. The bias current can also be monitored as a 10 bit unsigned digital word by setting the transmitter bias current digital monitor selection bit TXDMONB = 1 (bit 5 of [register 16](#)) and removing the resistor from MONB to ground.

The photodiode current is monitored using a current mirror with various gains that are dependent upon the photodiode current range being used. By connecting a resistor between MONP and GND, the photodiode current can be monitored as a voltage across the resistor. A low temperature coefficient precision resistor should be used. The photodiode current can also be monitored as a 10 bit unsigned digital word by setting the transmitter photodiode current digital monitor selection bit TXDMONP = 1 (bit 6 of [register 16](#)) and removing the resistor from MONP to ground.

8.3.1.7 Laser Safety Features and Fault Recovery Procedure

The ONET1130EP provides built in laser safety features. The following fault conditions are detected if the transmitter fault detection enable bit TXFLTEN = 1 (bit 3 of [register 1](#)):

1. Voltage at MONB exceeds the bandgap voltage (1.2 V) or, alternately, if TXDMONB = 1 and the bias current exceeds the bias current monitor fault threshold set by TXBMF[0..7] ([register 17](#)). When using the digital monitor, the resistor from the MONB pin to ground must be removed.
2. Voltage at MONP exceeds the bandgap voltage (1.2 V) and the analog photodiode current monitor fault trigger bit, TXMONPFLT (bit 7 of [register 1](#)), is set to 1. Alternately, a fault can be triggered if TXDMONP = 1 and the photodiode current exceeds the photodiode current monitor fault threshold set by TXPMF[0..7] ([register 18](#)). When using the digital monitor, the resistor from the MONP pin to ground must be removed.
3. Photodiode current exceeds 150% of its set value,
4. Bias control DAC drops in value by more than 50% in one step.

If the fault detection is being used then to avoid a fault from occurring at start-up it is recommended to set up the required bias current and APC loop conditions first and enable the laser bias current (TXBIASEN = 1) as the last step in the sequence of commands.

If one or more fault conditions occur and the transmitter fault enable bit TXFLTEN is set to 1, the ONET1130EP responds by:

1. Setting the bias current to zero.
2. Asserting and latching the TX_FLT pin.
3. Setting the TX_FLT bit (bit 5 of [register 43](#)) to 1.

Fault recovery is performed by the following procedure:

1. The transmitter disable pin TX_DIS and/or the transmitter bias current enable bit TXBIASEN are toggled for at least the fault latch reset time.

Feature Description (接下页)

2. The TX_FLT pin de-asserts while the transmitter disable pin TX_DIS is asserted or the transmitter bias current enable bit TXBIASEN is de-asserted.
3. If the fault condition is no longer present, the part will return to normal operation with its prior output settings after the disable negate time.
4. If the fault condition is still present, TX_FLT re-asserts once TX_DIS is set to a low level and/or TXBIASEN is set to 0 and the part will not return to normal operation.

8.3.2 Receiver

8.3.2.1 Equalizer

The data signal is applied to an input equalizer by means of the input signal pins RXIN+ / RXIN–, which provide on-chip differential 100 Ω line-termination. The equalizer is enabled by default and can be disabled by setting the receiver equalizer disable bit RXEQ_DIS = 1 (bit 1 of [register 4](#)). Equalization is provided for bandwidth compensation of the optical receiver. The amount of equalization is set through the register settings RXCTLE [0..2] ([register 5](#)). The device can accept input amplitude levels from 6 mVpp up to 800 mVpp.

8.3.2.2 DC Offset Cancellation and Cross Point Control

Receiver offset cancellation compensates for internal offset voltages and thus ensures proper operation even for very small input data signals. The offset cancellation is enabled by default and the input threshold voltage can be adjusted using register settings RXTHADJ[0..3] ([register 6](#)) to optimize the bit error rate or change the eye crossing point to compensate for input signal pulse width distortion. The offset cancellation can be disabled by setting RXOC_DIS = 1 (bit 2 of [register 4](#)) and this also disables the cross point adjustment.

8.3.2.3 Output Driver

The output amplitude of the driver can be varied from 300 mVpp to 900 mVpp using the register settings RXAMP[0..3] ([register 8](#)). The default amplitude setting is 300 mVpp. To compensate for frequency dependent losses of transmission lines connected to the output, adjustable de-emphasis is provided. The de-emphasis can be adjusted using RXDADJ[0..2] ([register 8](#)). The polarity of the output pins can be inverted by setting the receiver output polarity switch bit RXOUTPOL = 1 (bit 5 of [register 4](#)).

In addition, the output driver can be disabled by setting the receiver output driver disable bit RXOUT_DIS = 1 (bit 6 of [register 4](#)) or the receiver signal path can be disabled and powered down by setting RX_DIS = 1 (bit 7 of [register 4](#)).

8.3.2.4 Receiver Loopback (Optical Loopback)

The signal input to the RXIN+ and RXIN– pins can be looped back to the transmitter output as shown in [图 36](#) by setting RX_LBMUX = 1 (bit 1 of [register 2](#)). Loopback from the transmitter input to the receiver output (electrical loopback) can be enabled at the same time.

Feature Description (接下页)



图 36. Optical Loopback

Feature Description (接下页)

8.3.2.5 Loss of Signal Detection

The loss of signal (LOS) detection is done by 2 separate level detectors to cover a wide dynamic range. The peak values of the input signal are monitored by a peak detector and compared to a pre-defined loss of signal threshold voltage inside the loss of signal detection block. As a result of the comparison, the LOS signal, which indicates that the input signal amplitude is below the defined threshold level, is generated. There are 2 LOS ranges settable with the RXLOS RNG bit (bit 0 of [register 4](#)). With RXLOS RNG = 0 the high range of the LOS assert values are used (40 mV_{PP} to 130 mV_{PP}) and by setting RXLOS RNG = 1 the low range of the LOS assert values are used (10 mV_{PP} to 50 mV_{PP}). There are 64 possible internal LOS settings set with RXLOSA[0..5] ([register 7](#)) for each LOS range to adjust the LOS assert level.

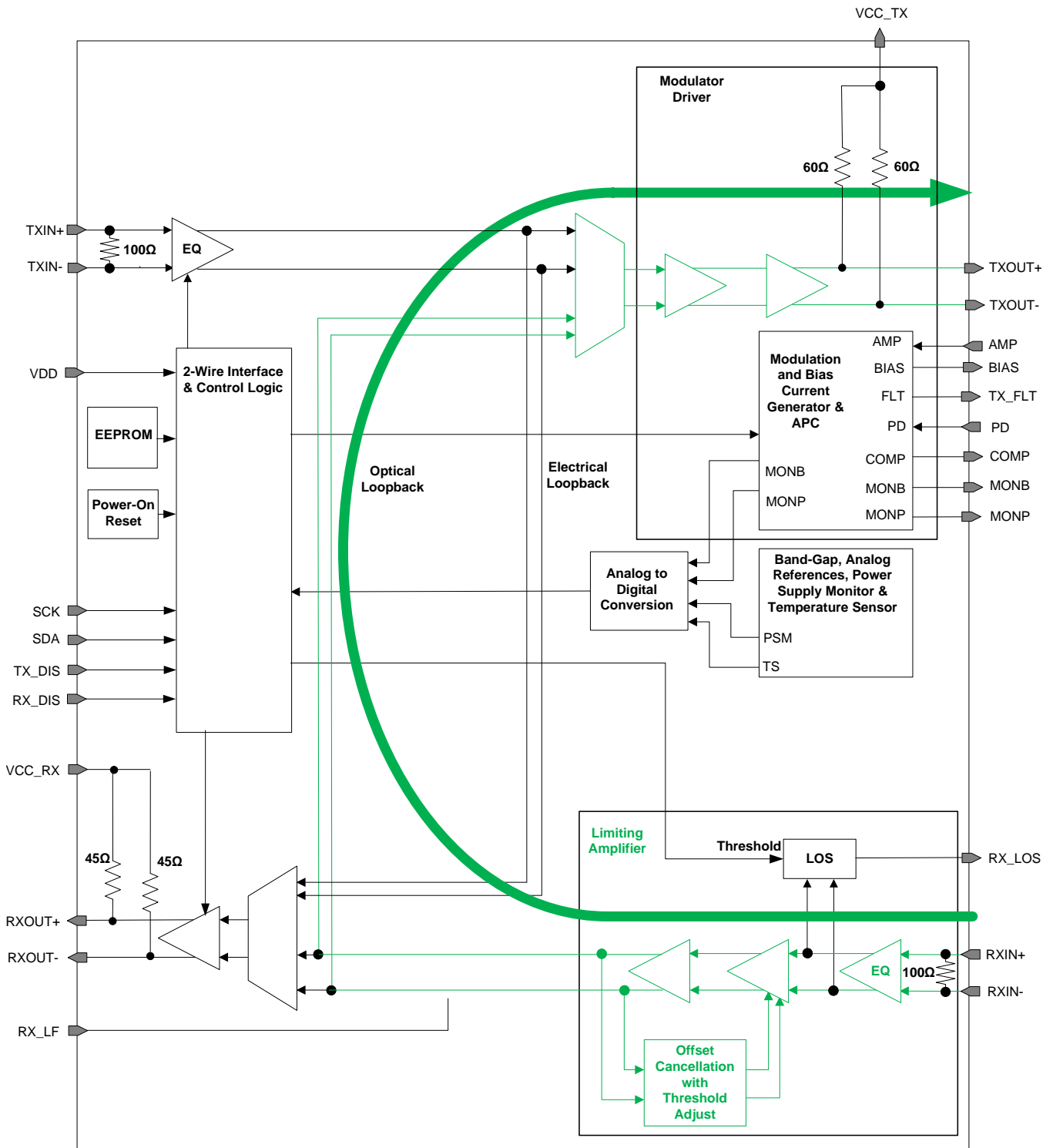
The typical LOS hysteresis, as defined by $20\log(\text{LOS de-assert voltage}/\text{LOS assert voltage})$ is 4 dB. This can be reduced by approximately 2 dB by setting receiver hysteresis RXHYS = 1 (bit 7 of [register 6](#)). In addition, the LOS detection time can be reduced by setting the receiver fast LOS bit RXFLOS = 1 (bit 3 of [register 5](#)); however, this may result in chatter (LOS bounce).

8.3.3 Analog Block

8.3.3.1 Analog Reference and Temperature Sensor

The ONET1130EP is supplied by a single 2.5 V $\pm 5\%$ supply voltage connected to the VCC_TX, VCC_RX and VDD pins. This voltage is referred to ground (GND) and can be monitored as a 10 bit unsigned digital word through the 2-wire interface.

On-chip bandgap voltage circuitry generates a reference voltage, independent of the supply voltage, from which all other internally required voltages and bias currents are derived.

In order to minimize the module component count, the ONET1130EP provides an on-chip temperature sensor. The temperature can be monitored as a 10 bit unsigned digital word through the 2-wire interface.

8.3.3.2 Power-On Reset

The ONET1130EP has power on reset circuitry which ensures that all registers are reset to default values during startup. After the power-on to initialize time (t_{INIT1}), the internal registers are ready to be loaded. The part is ready to transmit data after the initialize to transmit time (t_{INIT2}), assuming that the enable chip bit EN_CHIP = 1 (bit 0 of [register 0](#)). In addition, the transmitter disable pin TX_DIS and receiver disable pin RX_DIS must be set to zero.

The ONET1130EP bias current can be disabled by setting the TX_DIS pin high. The internal registers are not reset. After the transmitter disable pin TX_DIS is set low the part returns to its prior output settings.

8.3.3.3 Analog to Digital Converter

The ONET1130EP has an internal 10 bit analog to digital converter (ADC) that converts the analog monitors for temperature, power supply voltage, bias current and photodiode current into a 10 bit unsigned digital word. The first 8 most significant bits (MSBs) are available in [register 40](#) and the 2 least significant bits (LSBs) are available in [register 41](#). Depending on the accuracy required, 8 bits or 10 bits can be read. However, due to the architecture of the 2-wire interface, in order to read the 2 registers, 2 separate read commands have to be sent.

The ADC is enabled by default so to monitor a particular parameter, select the parameter with ADCSEL[0..2] (bits 0 to 2 of [register 3](#)). [表 2](#) shows the ADCSEL bits and the parameter that is monitored.

表 2. ADC Selection Bits and the Monitored Parameter

ADCSEL2	ADCSEL1	ADCSEL0	MONITORED PARAMETER
0	0	0	Temperature
0	0	1	Supply voltage
0	1	0	Bias current
0	1	1	Photodiode current

To digitally monitor the photodiode current, ensure that TXDMONP = 1 (bit 6 of [register 16](#)) and that a resistor is not connected to the MONP pin. To digitally monitor the bias current, ensure that TXDMONB = 1 (bit 5 of [register 16](#)) and that a resistor is not connected to the MONB pin. The ADC is disabled by default. To enable the ADC, set the ADC oscillator enable bit OSCEN = 1 (bit 6 of [register 3](#)) and set the ADC enable bit ADCEN = 1 (bit 7 of [register 3](#)).

The digital word read from the ADC can be converted to its analog equivalent through the following formulas.

$$\text{Temperature (}^\circ\text{C)} = (0.5475 \times \text{ADCx}) - 273 \quad (1)$$

$$\text{Power supply voltage (V)} = (1.36\text{m} \times \text{ADCx}) + 1.76 \quad (2)$$

$$\text{IPD}(\mu\text{A}) = 2 \times [(0.62 \times \text{ADCx}) - 16] \text{ for TXPDRNG00} \quad (3)$$

$$\text{IPD}(\mu\text{A}) = 4 \times [(0.62 \times \text{ADCx}) - 16] \text{ for TXPDRNG01} \quad (4)$$

$$\text{IPD}(\mu\text{A}) = 8 \times [(0.62 \times \text{ADCx}) - 16] \text{ for TXPDRNG1x} \quad (5)$$

$$\text{IBIAS (mA)} = (0.2 \times \text{ADCx}) - 4.5 \quad (6)$$

Where: ADCx = the decimal value read from the ADC

8.3.3.4 2-Wire Interface and Control Logic

The ONET1130EP uses a 2-wire serial interface for digital control. The two circuit inputs, SDA and SCK, are driven, respectively, by the serial data and serial clock from a microprocessor, for example. The SDA and SCK pins require external 4.7-k Ω to 10-k Ω pull-up resistor to VCC for proper operation.

The 2-wire interface allows write access to the internal memory map to modify control registers and read access to read out the control signals. The ONET1130EP is a slave device only which means that it cannot initiate a transmission itself; it always relies on the availability of the SCK signal for the duration of the transmission. The master device provides the clock signal as well as the START and STOP commands. The protocol for a data transmission is as follows:

1. START command
2. Seven (7) bit slave address (0001000) followed by an eighth bit which is the data direction bit (R/W). A zero indicates a WRITE and a 1 indicates a READ.
3. 8 bit register address
4. 8 bit register data word
5. STOP command

Regarding timing, the ONET1130EP is I²C compatible. The typical timing is shown in [图 1](#) and a complete data transfer is shown in [图 37](#). Parameters for [图 1](#) are defined in [表 1](#).

8.3.3.5 Bus Idle

Both SDA and SCK lines remain HIGH

8.3.3.6 Start Data Transfer

A change in the state of the SDA line, from HIGH to LOW, while the SCK line is HIGH, defines a START condition (S). Each data transfer is initiated with a START condition.

8.3.3.7 Stop Data Transfer

A change in the state of the SDA line from LOW to HIGH while the SCK line is HIGH defines a STOP condition (P). Each data transfer is terminated with a STOP condition; however, if the master still wishes to communicate on the bus, it can generate a repeated START condition and address another slave without first generating a STOP condition.

8.3.3.8 Data Transfer

Only one data byte can be transferred between a START and a STOP condition. The receiver acknowledges the transfer of data.

8.3.4 Acknowledge

Each receiving device, when addressed, is obliged to generate an acknowledge bit. The transmitter releases the SDA line and a device that acknowledges must pull down the SDA line during the acknowledge clock pulse in such a way that the SDA line is stable LOW during the HIGH period of the acknowledge clock pulse. Setup and hold times must be taken into account. When a slave-receiver doesn't acknowledge the slave address, the data line must be left HIGH by the slave. The master can then generate a STOP condition to abort the transfer. If the slave-receiver does acknowledge the slave address but some time later in the transfer cannot receive any more data bytes, the master must abort the transfer. This is indicated by the slave generating the not acknowledge on the first byte to follow. The slave leaves the data line HIGH and the master generates the STOP condition, see 图 1.

8.4 Device Functional Modes

The ONET1130EP has two main functional modes of operation: differential transmitter output and single-ended transmitter output.

8.4.1 Differential Transmitter Output

Operation with differential output is the default mode of operation. This mode is intended for externally modulated lasers requiring differential drive such as Mach Zehnder modulators.

8.4.2 Single-Ended Transmitter Output

In order to reduce the power consumption for single-ended EML applications the output driver should be set to single-ended mode. The single-ended output signal can be enabled by setting the transmitter mode select bit TXMODE = 1 (bit 6 of [register 13](#)). The positive output is active by default. To enable the negative output and disable the positive output set TXOUTSEL = 1 (bit 7 of [register 13](#)).

8.5 Programming

Write Sequence

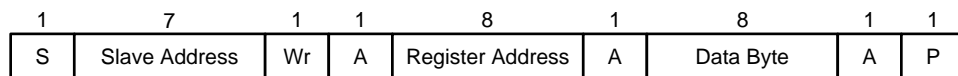

Read Sequence

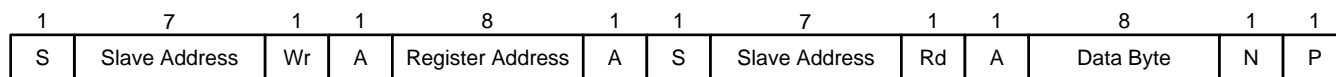

Legend

S	Start Condition
Wr	Write Bit (Bit Value = 0)
Rd	Read Bit (Bit Value = 1)
A	Acknowledge
N	Not Acknowledge
P	Stop Condition

图 37. Programming Sequence

8.6 Register Mapping

8.6.1 R/W Control Registers

8.6.1.1 Core Level Register 0 (offset = 0100 0001 [reset = 41h])

图 38. Core Level Register 0

7	6	5	4	3	2	1	0
0	Reserved					0	1
RWSC	RW	–	–	–	RWSC	RWSC	RW

LEGEND: R/W = Read/Write; R = Read only; -n = value after reset. RWSC = Read/Write self clearing (always reads back to zero)

表 3. Core Level Register 0 Field Descriptions

Bit	Field	Type	Reset	Description
7	GLOBAL SW_PIN RESET	RWSC	0h	Global Reset SW 1 = reset, resets all I2C and EEPROM modules to default 0 = normal operation (self-clearing, always reads back '0')
6:2	–	R/W	4h	Reserved
1	I2C RESET	RWSC	0h	Chip reset bit 1 = resets all I2C registers to default 0 = normal operation (self-clearing, always reads back '0')
0	EN_CHIP	R/W	1h	Enable chip bit 1 = Chip enabled

8.6.1.2 Core Level Register 1 (offset = 0000 0000) [reset = 0h]

图 39. Core Level Register 1

7	6	5	4	3	2	1	0
0	0	0	0	0	0	0	0
R/W	R/W	R/W	R/W	R/W	R/W	R/W	R/W

LEGEND: R/W = Read/Write; R = Read only; -n = value after reset

表 4. Core Level Register 1 Field Descriptions

Bit	Field	Type	Reset	Description
7	TXMONPFLT	R/W	0	Analog photodiode current monitor fault trigger bit 1 = Fault trigger on MONP pin is enabled 0 = Fault trigger on MONP pin is disabled
6 5	TXPDRNG1 TXPDRNG0	R/W	0	Photodiode current range bits 1X: up to 3080µA / 3µA resolution 01: up to 1540µA / 1.5µA resolution 00: up to 770µA / 0.75µA resolution
4	TXOLENA	R/W	0	Open loop enable bit 1 = Open loop bias current control 0 = Closed loop bias current control
3	TXFLTEN	R/W	0	Fault detection enable bit 1 = Fault detection on 0 = Fault detection off
2	TXBIASEN	R/W	0	Laser Bias current enable bit 1 = Bias current enabled. Toggle to 0 to reset a fault condition. 0 = Bias current disabled
1	TXBIASPOL	R/W	0	Laser Bias current polarity bit 1 = Bias pin sinks current 0 = Bias pin sources current

表 4. Core Level Register 1 Field Descriptions (接下页)

Bit	Field	Type	Reset	Description
0	TXPDPOL	R/W	0	Photodiode polarity bit 1 = Photodiode cathode connected to VCC 0 = Photodiode anode connected to GND

8.6.1.3 Core Level Register 2 (offset = 0000 0000) [reset = 0h]
图 40. Core Level Register 2

7	6	5	4	3	2	1	0
Reserved						0	0
R/W	R/W	R/W	R/W	R/W	R/W	R/W	R/W

LEGEND: R/W = Read/Write; R = Read only; -n = value after reset

表 5. Core Level Register 2 Field Descriptions

Bit	Field	Type	Reset	Description
7:4	–	R/W	0h	Reserved
3	–	R/W	0h	Reserved
2	–	R/W	0h	Reserved
1	RX_LBMUX	R/W	0h	RX-Loopback MUX Setting (optical LB) 1 = Loopback from TX output selected. 0 = Normal operation: RX output selected
0	TX_LBMUX	R/W	0h	TX-Loopback MUX Setting (electrical LB) 1 = Loopback from RX output selected. 0 = Normal operation: TX output selected

8.6.1.4 Core Level Register 3 (offset = 0000 0000) [reset = 0h]
图 41. Core Level Register 3

7	6	5	4	3	2	1	0
0	0	–	0	–	0	0	0
R/W	R/W	R/W	R/W	R/W	R/W	R/W	R/W

LEGEND: R/W = Read/Write; R = Read only; -n = value after reset

表 6. Core Level Register 3 Field Descriptions

Bit	Field	Type	Reset	Description
7	ADCEN	R/W	0h	ADC enabled bit 1 = ADC enabled 0 = ADC disabled
6	OSCEN	R/W	0h	ADC oscillator bit 1 = Oscillator enabled 0 = Oscillator disabled
5	–	R/W	0h	Reserved
4	ADCRST	R/W	0h	ADC reset 1 = ADC reset 0 = ADC no reset
3	–	R/W	0h	Reserved
2	ADCSEL2	R/W	0h	ADC input selection bits <2:0> 000 selects the temperature sensor 001 selects the power supply monitor 010 selects IMONB 011 selects IMONP 1XX are reserved
1	ADCSEL1	R/W	0h	
0	ADCSELO	R/W	0h	

8.6.2 RX Registers

8.6.2.1 RX Register 4 (offset = 0000 0000) [reset = 0h]

图 42. RX Register 4

7	6	5	4	3	2	1	0
0	0	0	–	–	0	0	0
R/W	R/W	R/W	R/W	R/W	R/W	R/W	R/W

LEGEND: R/W = Read/Write; R = Read only; -n = value after reset

表 7. RX Register 4 Field Descriptions

Bit	Field	Type	Reset	Description
7	RX_DIS	R/W	0h	RX disable bit 1 = RX disabled (power-down) 0 = RX enabled
6	RXOUT_DIS	R/W	0h	RX Output Driver disable bit 1 = output driver is disabled 0 = output driver is enabled
5	RXOUTPOL	R/W	0h	RX Output polarity switch bit 1 = inverted polarity 0 = normal polarity
4:3	–	R/W	0h	Reserved
2	RXOC_DIS	R/W	0h	RX Offset cancellation disable bit 1 = offset cancellation and threshold adjust is disabled 0 = offset cancellation and threshold adjust is enabled
1	RXEQ_DIS	R/W	0h	RX Equalizer disable bit 1 = RX Equalizer is disabled and bypassed 0 = RX Equalizer is enabled
0	RXLOSRNG	R/W	0h	LOS range bit 1 = low LOS assert voltage range 0 = high LOS assert voltage range

8.6.2.2 RX Register 5 (offset = 0000 0000) [reset = 0h]
图 43. RX Register 5

7	6	5	4	3	2	1	0
Reserved				0	0	0	0
R/W	R/W	R/W	R/W	R/W	R/W	R/W	R/W

LEGEND: R/W = Read/Write; R = Read only; -n = value after reset

表 8. RX Register 5 Field Descriptions

Bit	Field	Type	Reset	Description
7:4	–	R/W	0h	Reserved
3	RXFLOS	R/W	0h	Receiver fast LOS bit 1 = Fast LOS 0 = normal operation
2	RXCTLE2	R/W	0h	RX input CTLE setting 000 = minimum 111 = maximum
1	RXCTLE1	R/W	0h	
0	RXCTLE0	R/W	0h	

8.6.2.3 RX Register 6 (offset = 0000 0000) [reset = 0h]
图 44. RX Register 6

7	6	5	4	3	2	1	0
0	Reserved		0	0	0	0	0
R/W	R/W	R/W	R/W	R/W	R/W	R/W	R/W

LEGEND: R/W = Read/Write; R = Read only; -n = value after reset

表 9. RX Register 6 Field Descriptions

Bit	Field	Type	Reset	Description
7	RXHYS	R/W	0h	Receiver Hysteresis 1 = Reduce hysteresis level by approximately 2dB 0 = default level of hysteresis (approximately 4dB)
6:5	–	R/W	0h	Reserved
4	RXTHSGN	R/W	0h	RX Eye cross-point adjustment setting RXTHSGN = 1 (positive shift) Maximum shift for 1111 Minimum shift for 0000 RXTHSGN = 0 (negative shift) Maximum shift for 1111 Minimum shift for 0000
3	RXTHADJ3	R/W	0h	
2	RXTHADJ2	R/W	0h	
1	RXTHADJ1	R/W	0h	
0	RXTHADJ0	R/W	0h	

8.6.2.4 RX Register 7 (offset = 0000 0000) [reset = 0h]
图 45. RX Register 7

7	6	5	4	3	2	1	0
Reserved	0	0	0	0	0	0	0
R/W	R/W	R/W	R/W	R/W	R/W	R/W	R/W

LEGEND: R/W = Read/Write; R = Read only; -n = value after reset

表 10. RX Register 7 Field Descriptions

Bit	Field	Type	Reset	Description
7:6	–	R/W	0h	Reserved
5	RXLOSA5	R/W	0h	LOS assert level Minimum LOS assert level for 000000 Maximum LOS assert level for 111111
4	RXLOSA4	R/W	0h	
3	RXLOSA3	R/W	0h	
2	RXLOSA2	R/W	0h	
1	RXLOSA1	R/W	0h	
0	RXLOSA0	R/W	0h	

8.6.2.5 RX Register 8 (offset = 0000 0000) [reset = 0h]
图 46. RX Register 8

7	6	5	4	3	2	1	0
Reserved	0	0	0	0	0	0	0
R/W	R/W	R/W	R/W	R/W	R/W	R/W	R/W

LEGEND: R/W = Read/Write; R = Read only; -n = value after reset

表 11. RX Register 8 Field Descriptions

Bit	Field	Type	Reset	Description
7	–	R/W	0h	Reserved
6	RXDADJ1	R/W	0h	RX output de-emphasis setting 00 = minimum de-emphasis 11 = maximum de-emphasis
5	RXDADJ0	R/W	0h	
4	RXDRVSC	R/W	0h	RX driver short circuit protection 1 = short circuit protection enabled 0 = normal operation
3	RXAMP3	R/W	0h	RX output amplitude adjustment 0000 = minimum amplitude 1111 = maximum amplitude
2	RXAMP2	R/W	0h	
1	RXAMP1	R/W	0h	
0	RXAMP0	R/W	0h	

8.6.2.6 RX Register 9 (offset = 0000 0000) [reset = 0h]
图 47. RX Register 9

7	6	5	4	3	2	1	0
Reserved							
R/W	R/W	R/W	R/W	R/W	R/W	R/W	R/W

LEGEND: R/W = Read/Write; R = Read only; -n = value after reset

表 12. RX Register 9 Field Descriptions

Bit	Field	Type	Reset	Description
7:1	–	R/W	0h	Reserved

8.6.3 TX Registers

8.6.3.1 TX Register 10 (offset = 0000 0000) [reset = 0h]

图 48. TX Register 10

7	6	5	4	3	2	1	0
0	0	0	–	–	0	0	0
R/W	R/W	R/W	R/W	R/W	R/W	R/W	R/W

LEGEND: R/W = Read/Write; R = Read only; -n = value after reset

表 13. TX Register 10 Field Descriptions

Bit	Field	Type	Reset	Description
7	TX_DIS	R/W	0h	TX disable bit 1 = TX disabled (power-down) 0 = TX enabled
6	TXOUT_DIS	R/W	0h	TX Output Driver disable bit 1 = output disabled 0 = output enabled
5	TXOUTPOL	R/W	0h	TX Output polarity switch bit 1 = inverted polarity 0 = normal polarity
4:3	–	R/W	0h	Reserved
2	TXOC_DIS	R/W	0h	TX OC disable bit 1 = TX Offset Cancellation disabled 0 = TX Offset Cancellation enabled
1	TXEQ_DIS	R/W	0h	TX Equalizer disable bit 1 = TX Equalizer is disabled and bypassed 0 = TX Equalizer is enabled
0	TXAMPCTRL	R/W	0h	TX AMP Ctrl 1 = TX AMP Control is enabled (analog amplitude control) 0 = TX AMP Control is disabled (digital amplitude control)

8.6.3.2 TX Register 11 (offset = 0000 0000) [reset = 0h]
图 49. TX Register 11

7	6	5	4	3	2	1	0
0	0	0	0	0	0	0	0
R/W	R/W	R/W	R/W	R/W	R/W	R/W	R/W

LEGEND: R/W = Read/Write; R = Read only; -n = value after reset

表 14. TX Register 11 Field Descriptions

Bit	Field	Type	Reset	Description
7	TXAMPRNG	R/W	0h	TX output AMP range 1 = Half TX output amplitude range 0 = Full TX output amplitude range
6	TXPKSEL	R/W	0h	TX output peaking width 1 = wide peaking width 0 = narrow peaking width
5	TXTCSEL1	R/W	0h	TXOUT temperature compensation select bit 1
4	TXTCSEL0	R/W	0h	TXOUT temperature compensation select bit 0
3	TXCTLE3	R/W	0h	TX input CTLE setting 0000 = minimum 1111 = maximum
2	TXCTLE2	R/W	0h	
1	TXCTLE1	R/W	0h	
0	TXCTLE0	R/W	0h	

8.6.3.3 TX Register 12 (offset = 0000 0000) [reset = 0h]
图 50. TX Register 12

7	6	5	4	3	2	1	0
0	0	0	0	0	0	0	0
R/W	R/W	R/W	R/W	R/W	R/W	R/W	R/W

LEGEND: R/W = Read/Write; R = Read only; -n = value after reset

表 15. TX Register 12 Field Descriptions

Bit	Field	Type	Reset	Description
7	TXMOD7	R/W	0h	TX Modulation current setting: sets the output voltage Output Voltage: 2.4 Vpp / 9.5 mVpp steps
6	TXMOD6	R/W	0h	
5	TXMOD5	R/W	0h	
4	TXMOD4	R/W	0h	
3	TXMOD3	R/W	0h	
2	TXMOD2	R/W	0h	
1	TXMOD1	R/W	0h	
0	TXMOD0	R/W	0h	

8.6.3.4 TX Register 13 (offset = 0h) [reset = 0]
图 51. TX Register 13

7	6	5	4	3	2	1	0
0	0	0	0	0	0	0	0
R/W	R/W	R/W	R/W	R/W	R/W	R/W	R/W

LEGEND: R/W = Read/Write; R = Read only; -n = value after reset

表 16. TX Register 13 Field Descriptions

Bit	Field	Type	Reset	Description
7	TXOUTSEL	R/W	0h	TX output selection bit 1 = The negative output TXOUT– is active if TXMODE = 1 0 = The positive output TXOUT+ is active if TXMODE = 1
6	TXMODE	R/W	0h	TX output mode selection bit 1 = Single-ended mode 0 = Differential mode
5	TXSTEP	R/W	0h	TX output de-emphasis mode selection bit 1 = Delayed de-emphasis 0 = Normal de-emphasis
4	TXSLOW	R/W	0h	TX edge speed selection bit 1 = Slow edge speed 0 = Normal operation
3	TXDEADJ3	R/W	0h	TX de-emphasis setting 0000 = minimum 1111 = maximum
2	TXDEADJ2	R/W	0h	
1	TXDEADJ1	R/W	0h	
0	TXDEADJ0	R/W	0h	

8.6.3.5 TX Register 14 (offset = 0000 0000) [reset = 0h]
图 52. TX Register 14

7	6	5	4	3	2	1	0
0	0	0	0	0	0	0	0
R/W	R/W	R/W	R/W	R/W	R/W	R/W	R/W

LEGEND: R/W = Read/Write; R = Read only; -n = value after reset

表 17. TX Register 14 Field Descriptions

Bit	Field	Type	Reset	Description
7	TXCPSGN	R/W	0h	TX Eye cross-point adjustment setting TXCPSGN = 1 (positive shift) Maximum shift for 1111111 Minimum shift for 0000000 TXCPSGN = 0 (negative shift) Maximum shift for 1111111 Minimum shift for 0000000
6	TXCPADJ6	R/W	0h	
5	TXCPADJ5	R/W	0h	
4	TXCPADJ4	R/W	0h	
3	TXCPADJ3	R/W	0h	
2	TXCPADJ2	R/W	0h	
1	TXCPADJ1	R/W	0h	
0	TXCPADJ0	R/W	0h	

8.6.3.6 TX Register 15 (offset = 0000 0000) [reset = 0h]
图 53. TX Register 15

7	6	5	4	3	2	1	0
0	0	0	0	0	0	0	0
R/W	R/W	R/W	R/W	R/W	R/W	R/W	R/W

LEGEND: R/W = Read/Write; R = Read only; -n = value after reset

表 18. TX Register 15 Field Descriptions

Bit	Field	Type	Reset	Description
7	TXBIAS9	R/W	0h	Bias current settings (8MSB; 2LSBs are in register 16) Closed loop (APC): Coupling ratio $CR = I_{BIAS} / I_{PD}$, $TXBIAS = 0..1023$, $I_{BIAS} \leq 150mA$: $TXPDRNG = 00$; $I_{BIAS} = 0.75\mu A \times CR \times TXBIAS$ $TXPDRNG = 01$; $I_{BIAS} = 1.5\mu A \times CR \times TXBIAS$ $TXPDRNG = 1X$; $I_{BIAS} = 3\mu A \times CR \times TXBIAS$ Open Loop: $I_{BIAS} \sim 156\mu A \times TXBIAS$ in source mode $I_{BIAS} \sim 156\mu A \times TXBIAS$ in sink mode
6	TXBIAS8	R/W	0h	
5	TXBIAS7	R/W	0 h	
4	TXBIAS6	R/W	0h	
3	TXBIAS5	R/W	0h	
2	TXBIAS4	R/W	0h	
1	TXBIAS3	R/W	0h	
0	TXBIAS2	R/W	0h	

8.6.3.7 TX Register 16 (offset = 0000 0000) [reset = 0h]
图 54. TX Register 16

7	6	5	4	3	2	1	0
Reserved	0	0	Reserved			0	0
R/W	R/W	R/W	R/W	R/W	R/W	R/W	R/W

LEGEND: R/W = Read/Write; R = Read only; -n = value after reset

表 19. TX Register 16 Field Descriptions

Bit	Field	Type	Reset	Description
7	–	R/W	0h	Reserved
6	TXDMONP	R/W	0h	Digital photodiode current monitor selection bit (MONP) 1 = Digital photodiode monitor is active (no external resistor is needed) 0 = Analog photodiode monitor is active (external resistor is required)
5	TXDMONB	R/W	0h	Digital bias current monitor selection bit (MONB) 1 = Digital bias current monitor is active (no external resistor is needed) 0 = Analog bias current monitor is active (external resistor is required)
4:2	–	R/W	0h	Reserved
1	TXBIAS1	R/W	0h	Bias current setting (2 LSBs)
0	TXBIAS0	R/W	0h	

8.6.3.8 TX Register 17 (offset = 0000 0000) [reset = 0h]
图 55. TX Register 17

7	6	5	4	3	2	1	0
0	0	0	0	0	0	0	0
R/W	R/W	R/W	R/W	R/W	R/W	R/W	R/W

LEGEND: R/W = Read/Write; R = Read only; -n = value after reset

表 20. TX Register 17 Field Descriptions

Bit	Field	Type	Reset	Description
7	TXBMF7	R/W	0h	Bias current monitor fault threshold With TXDMONB = 1 Register sets the value of the bias current that will trigger a fault. The external resistor on the MONB pin must be removed to use this feature.
6	TXBMF6	R/W	0h	
5	TXBMF5	R/W	0h	
4	TXBMF4	R/W	0h	
3	TXBMF3	R/W	0h	
2	TXBMF2	R/W	0h	
1	TXBMF1	R/W	0h	
0	TXBMF0	R/W	0h	

8.6.3.9 TX Register 18 (offset = 0000 0000) [reset = 0h]
图 56. TX Register 18

7	6	5	4	3	2	1	0
0	0	0	0	0	0	0	0
R/W	R/W	R/W	R/W	R/W	R/W	R/W	R/W

LEGEND: R/W = Read/Write; R = Read only; -n = value after reset

表 21. TX Register 18 Field Descriptions

Bit	Field	Type	Reset	Description
7	TXPMF7	R/W	0h	Power monitor fault threshold With TXDMONP = 1 Register sets the value of the photodiode current that will trigger a fault. The external resistor on the MONP pin must be removed to use this feature.
6	TXPMF6	R/W	0h	
5	TXPMF5	R/W	0h	
4	TXPMF4	R/W	0h	
3	TXPMF3	R/W	0h	
2	TXPMF2	R/W	0h	
1	TXPMF1	R/W	0h	
0	TXPMF0	R/W	0h	

8.6.4 Reserved Registers

8.6.4.1 Reserved Registers19-39

图 57. Reserved Registers19-39

7	6	5	4	3	2	1	0
Reserved							
R/W	R/W	R/W	R/W	R/W	R/W	R/W	R/W

LEGEND: R/W = Read/Write; R = Read only; -n = value after reset

表 22. Reserved Registers19-39 Field Descriptions

Bit	Field	Type	Reset	Description
7:0	–	–	–	Reserved

8.6.5 Read Only Registers

8.6.5.1 Core Level Register 40 (offset = 0000 0000) [reset = 0h]

图 58. Core Level Register 40

7	6	5	4	3	2	1	0
0	0	0	0	0	0	0	0
R	R	R	R	R	R	R	R

LEGEND: R/W = Read/Write; R = Read only; -n = value after reset

表 23. Core Level Register 40 Field Descriptions

Bit	Field	Type	Reset	Description
7	ADC9 (MSB)	R	0h	Digital representation of the ADC input source (read only)
6	ADC8	R	0h	
5	ADC7	R	0h	
4	ADC6	R	0h	
3	ADC5	R	0h	
2	ADC4	R	0h	
1	ADC3	R	0h	
0	ADC2	R	0h	

8.6.5.2 Core Level Register 41 (offset = 0000 0000) [reset = 0h]

图 59. Core Level Register 41

7	6	5	4	3	2	1	0
Reserved						0	0
R	R	R	R	R	R	R	R

LEGEND: R/W = Read/Write; R = Read only; -n = value after reset

表 24. Core Level Register 41 Field Descriptions

Bit	Field	Type	Reset	Description
7:2	–	R	0h	Reserved
1	ADC1	R	0h	Digital representation of the ADC input source (read only)
0	ADC0 (LSB)	R	0h	

8.6.5.3 RX Registers 42 (offset = 0000 0000) [reset = 0h]
图 60. RX Registers 42

7	6	5	4	3	2	1	0
Reserved		0	0	Reserved			
R	R	R	R	R	R	R	R

LEGEND: R/W = Read/Write; R = Read only; -n = value after reset; RCLR = Read clear

表 25. RX Registers 42 Field Descriptions

Bit	Field	Type	Reset	Description
7	–	R	0	Reserved
6	–	RCLR	0	Reserved
5	RXLOS	R	0	RX LOS status bit 1 = RX LOS asserted 0 = RX LOS de-asserted
4	RX_LOS (latched high)	RCLR	0	Latched high status of RXLOS(bit5). Cleared when read. Latched high status set to 1 when raw status goes high and keep it high even if raw status goes low.
3:0	–	R	0	Reserved

8.6.5.4 TX Register 43 (offset = 0000 0000) [reset = 0h]
图 61. Core Level Register 43

7	6	5	4	3	2	1	0
0	0	0	0	0	0	0	0
R	R	R	R	R	R	R	R

LEGEND: R/W = Read/Write; R = Read only; -n = value after reset; RCLR = Read clear

表 26. TX Register 43 Field Descriptions

Bit	Field	Type	Reset	Description
7	–	R	0	Reserved
6	–	RCLR	0	Reserved
5	TX_FLT	R	0	TX fault status bit 1 = TX fault detected 0 = TX fault not detected
4	TX_DRVDIS	R	0	TX driver disable status bit 1 = TX fault logic disables the driver 0 = TX fault logic does not disable the driver
3:0	–	R	0	Reserved

8.6.6 Adjustment Registers

8.6.6.1 Adjustment Registers 44-55

图 62. Adjustment Registers 44-55

7	6	5	4	3	2	1	0
Reserved							
R	R	R	R	R	R	R	R

LEGEND: R/W = Read/Write; R = Read only; -n = value after reset

表 27. Adjustment Registers 44-55 Field Descriptions

Bit	Field	Type	Reset	Description
7:0	–	–	–	Reserved

8.6.6.2 Adjustment Registers 52-55

图 63. Adjustment Registers 52-55

7	6	5	4	3	2	1	0
Reserved							
R	R	R	R	R	R	R	R

LEGEND: R/W = Read/Write; R = Read only; -n = value after reset

表 28. Adjustment Registers 52-55 Field Descriptions

Bit	Field	Type	Reset	Description
7:0	–			Reserved

9 Application Information and Implementations

注

Information in the following applications sections is not part of the TI component specification, and TI does not warrant its accuracy or completeness. TI's customers are responsible for determining suitability of components for their purposes. Customers should validate and test their design implementation to confirm system functionality.

9.1 Application Information

The ONET1130EP is designed to be used in conjunction with a Transmitter Optical Sub-Assembly (TOSA) and a Receiver Optical Sub-Assembly (ROSA). The ONET1130EP, TOSA, ROSA, microcontroller and power management circuitry will typically be used in an XFP or SFP+ 10 Gbps optical transceiver. 图 64 shows the ONET1130EP in differential mode of operation modulating a differentially driven Mach Zehnder (MZ) modulator TOSA and 图 66 and 图 67 show the device in single-ended output mode with an Electroabsorptive Modulated Laser (EML) TOSA. 图 66 has the photodiode cathode available and 图 67 has the photodiode anode available.

9.2 Typical Application, Transmitter Differential Mode



图 64. Typical Application Circuit in Differential Mode

Typical Application, Transmitter Differential Mode (接下页)

9.2.1 Design Requirements

表 29. Design Parameters

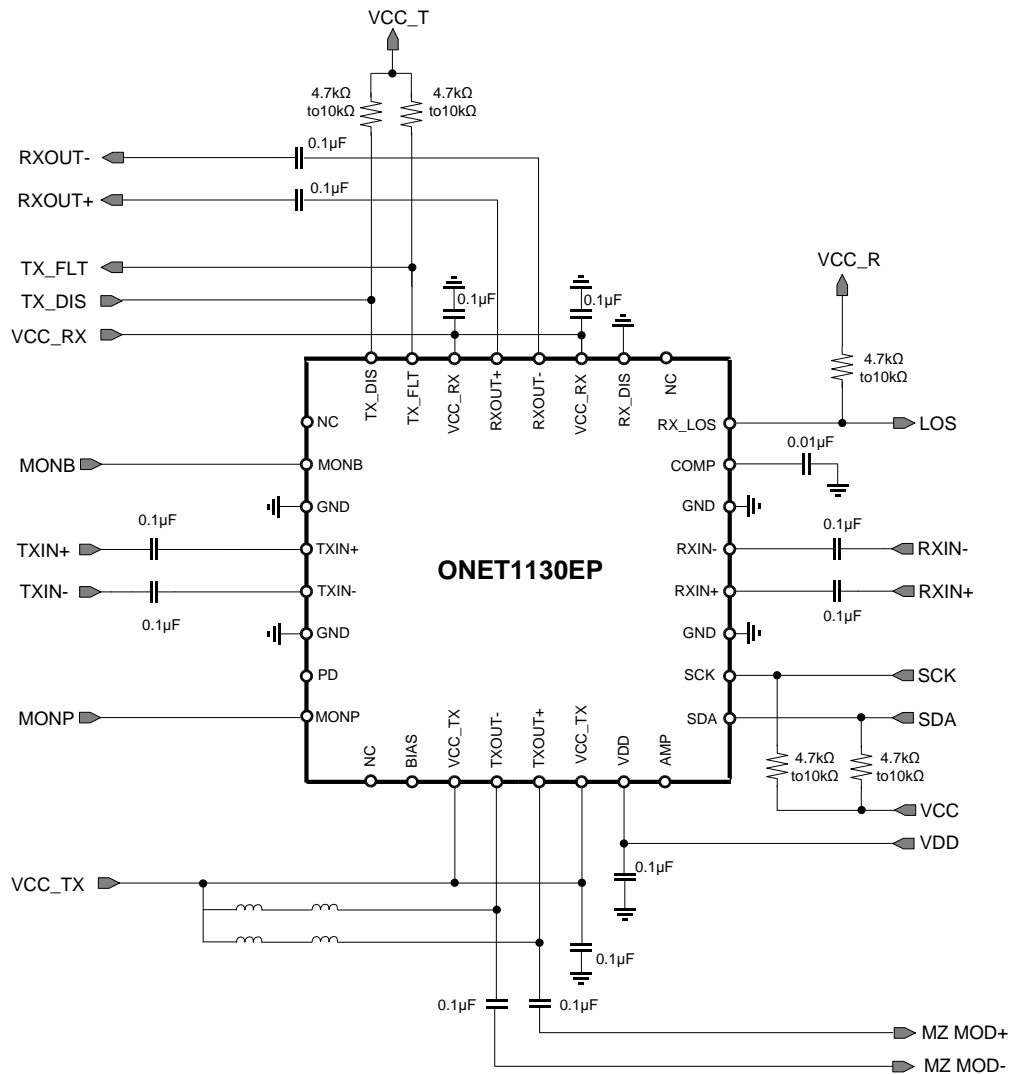
PARAMETER	VALUE
Supply voltage	2.5 V
Transmitter input voltage	100 mVpp to 1000 mVpp differential
Transmitter output voltage	1 Vpp to 3.6 Vpp differential
Receiver input voltage	6 mVpp to 800 mVpp differential
Receiver output voltage	300 mVpp to 900 mVpp differential

9.2.2 Detailed Design Procedure

In the transmitter differential mode of operation, the output driver is intended to be used with a differentially driven Mach Zehnder (MZ) modulator TOSA. On the input side, the TXIN+ and TXIN- pins are required to be AC coupled to the signal from the host system and the input voltage should be between 100 mVpp and 1000 mVpp differential. On the output side, the TXOUT+ pin is AC coupled to the modulator positive input and the TXOUT- pin is AC coupled to the modulator negative input. A bias-T from VCC to both the TXOUT+ and TXOUT- pins is required to supply sufficient headroom voltage for the output driver transistors. It is recommended that the inductance in the bias-T have low DC resistance to limit the DC voltage drop and maximize the voltage supplied to the TXOUT+ and TXOUT- pins. If the voltage on these pins drops below approximately 2.1V then the output rise and fall times can be adversely affected.

The receiver inputs, RXIN+ and RXIN-, are AC coupled to the output of ROSA and the input voltage should be between 6 mVpp and 800 mVpp differential. The receiver outputs, RXOUT+ and RXOUT-, are AC coupled to the receiver input of the host system.

9.2.3 Application Curve



图 65. Differential Mode Transmitter Output Eye Diagram

9.2.4 Typical Application, Transmitter Single-Ended Mode



图 66. Typical Application Circuit in Single-Ended Mode with an EML and the PD Monitor Cathode Available

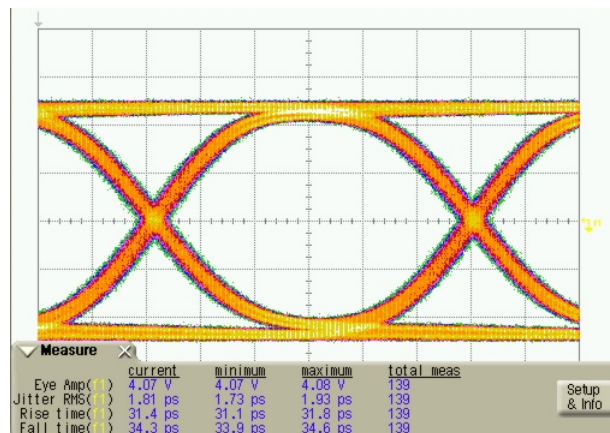

图 67. Typical Application Circuit in Single-Ended Mode with an EML and the PD Monitor Anode Available

9.2.4.1 Design Requirements

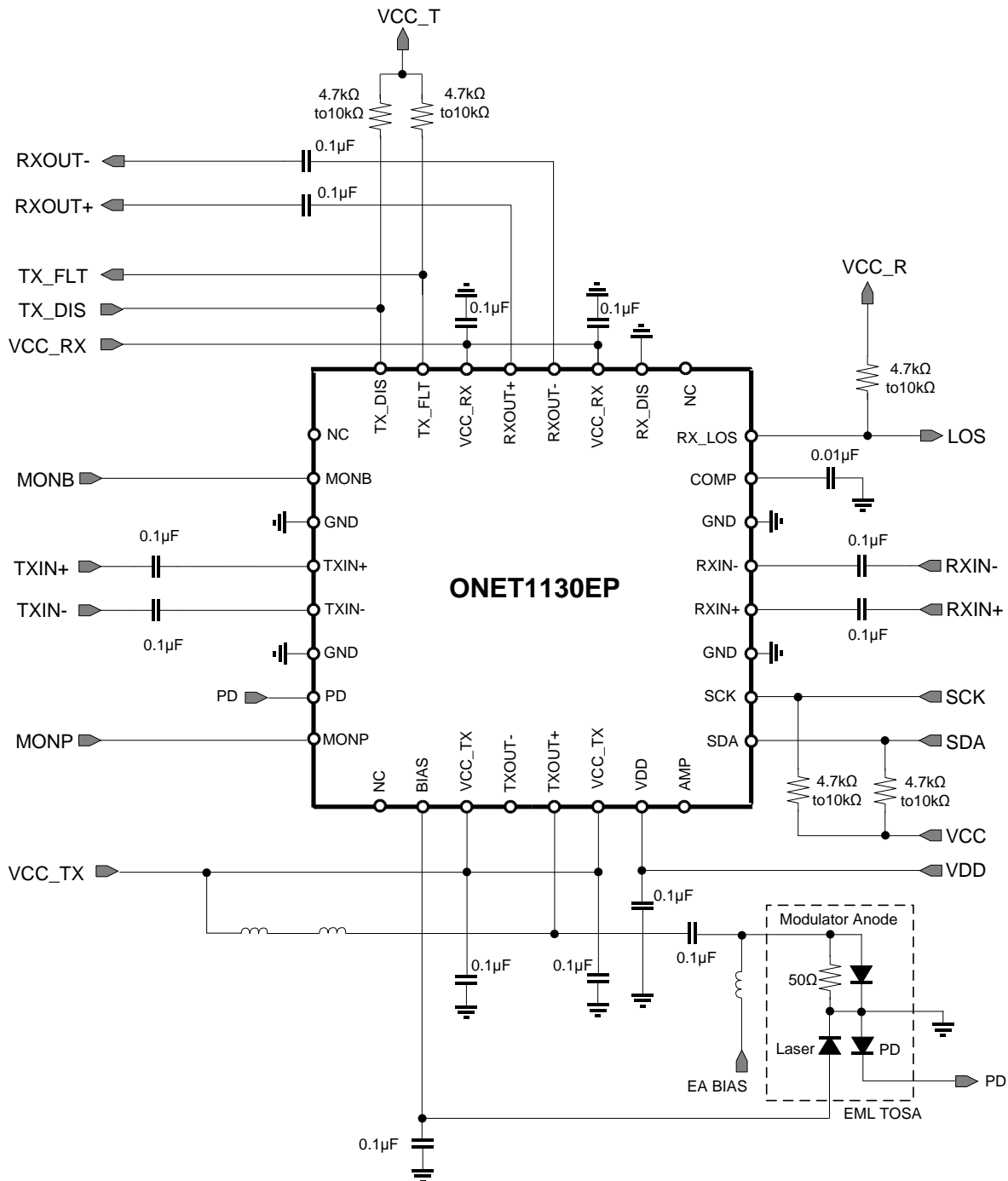
表 30. Design Parameters

PARAMETER	VALUE
Supply voltage	2.5 V
Transmitter input voltage	100 mVpp to 1000 mVpp differential
Transmitter output voltage	0.5 Vpp to 2 Vpp single-ended
Receiver input voltage	6 mVpp to 800 mVpp differential
Receiver output voltage	300 mVpp to 900 mVpp differential

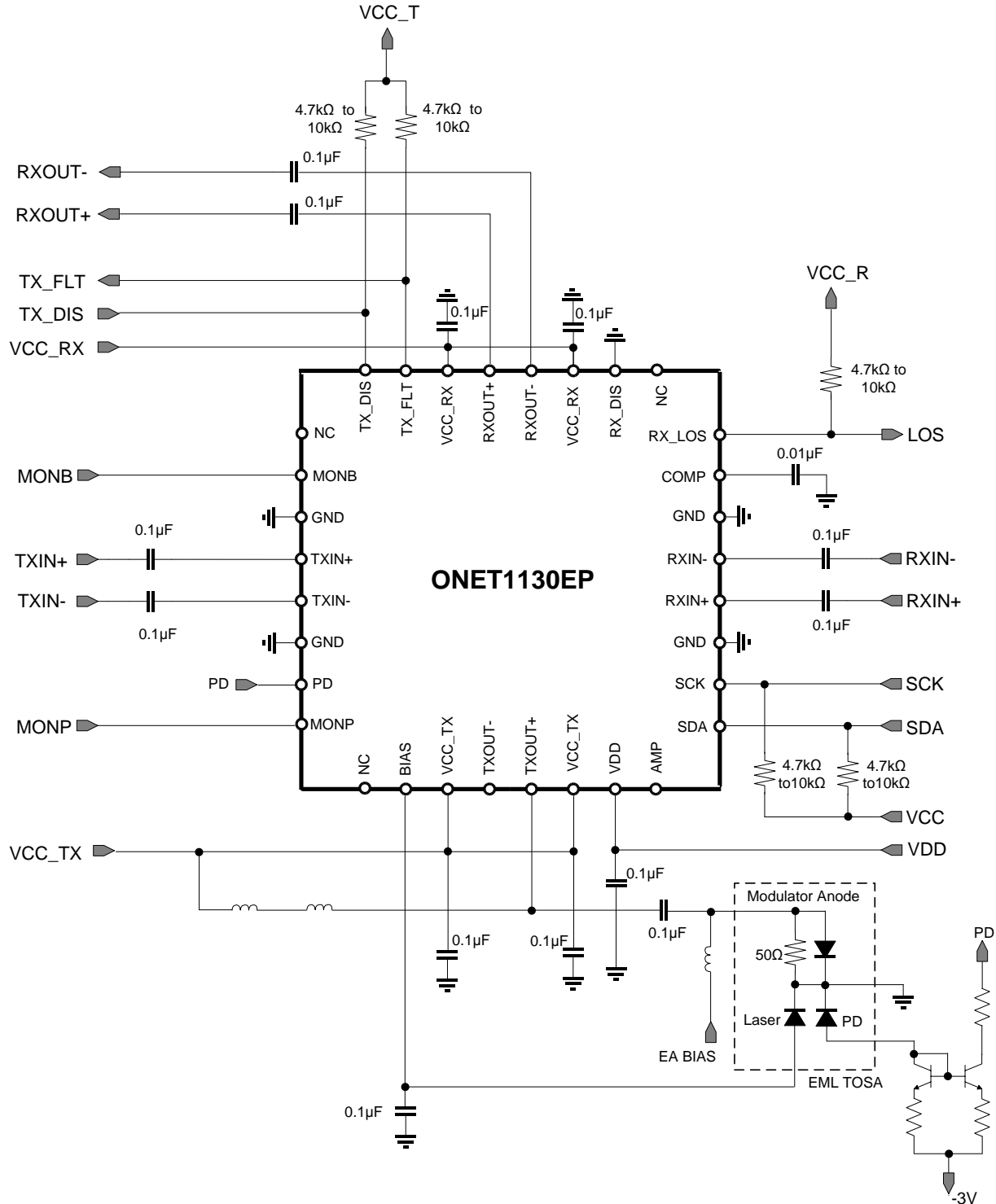
9.2.4.2 Detailed Design Procedure

In the transmitter single-ended mode of operation, the output driver is intended to be used with a single-ended driven Electroabsorptive Modulated Laser (EML) TOSA. On the input side, the TXIN+ and TXIN– pins are required to be AC coupled to the signal from the host system and the input voltage should be between 100mVpp and 1000mVpp differential. On the output side, it is recommended that the TXOUT+ pin is AC coupled to the modulator input and the TXOUT– pin can be left unterminated or terminated to VCC through a 50Ω resistor. A bias-T from VCC to the TXOUT+ pin is required to supply sufficient headroom voltage for the output driver transistors. It is recommended that the inductance in the bias-T have low DC resistance to limit the DC voltage drop and maximize the voltage supplied to the TXOUT+ pin. If the voltage on this pins drops below approximately 2.1V then the output rise and fall times can be adversely affected.

The receiver inputs, RXIN+ and RXIN–, are AC coupled to the output of ROSA and the input voltage should be between 6mVpp and 800mVpp differential. The receiver outputs, RXOUT+ and RXOUT–, are AC coupled to the receiver input of the host system.

9.2.4.3 Application Curves

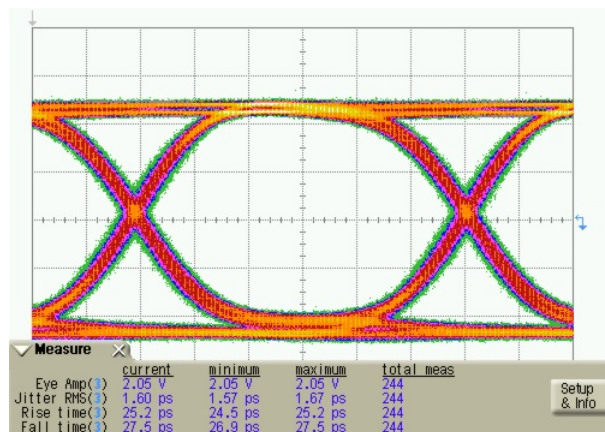
图 68. Single-Ended Mode Transmitter Output Eye Diagram

10 Power Supply Recommendations

The ONET1130EP is designed to operate from an input supply voltage range between 2.37 V and 2.63 V. To reduce transmitter and receiver power supply coupling, as well as digital coupling into the analog circuitry, there are separate supplies for the transmitter, receiver and digital circuitry. VCC_TX is used to supply power to the transmitter, VCC_RX is used to supply power to the receiver and VDD is used to supply power to the digital block. Power supply decoupling capacitors should be placed as close as possible to the respective power supply pins.

11 Layout

11.1 Layout Guidelines

For optimum performance, use 50-Ω transmission lines (100-Ω differential) for connecting the high speed inputs and outputs. The length of transmission lines should be kept as short as possible to reduce loss and pattern-dependent jitter. It is recommended to maximize the separation of the TXOUT+ and TXOUT- transmission lines from the RXIN+ and RXIN- transmission lines to minimize transmitter to receiver crosstalk.

If the single-ended mode of operation is being used (TXMODE = 1) then it is recommended to terminate the unused output with a 50-Ω resistor to VCC. 图 69 shows a typical layout for the high speed inputs and outputs.

11.2 Layout Example



图 69. Board Layout

12 器件和文档支持

12.1 社区资源

The following links connect to TI community resources. Linked contents are provided "AS IS" by the respective contributors. They do not constitute TI specifications and do not necessarily reflect TI's views; see TI's [Terms of Use](#).

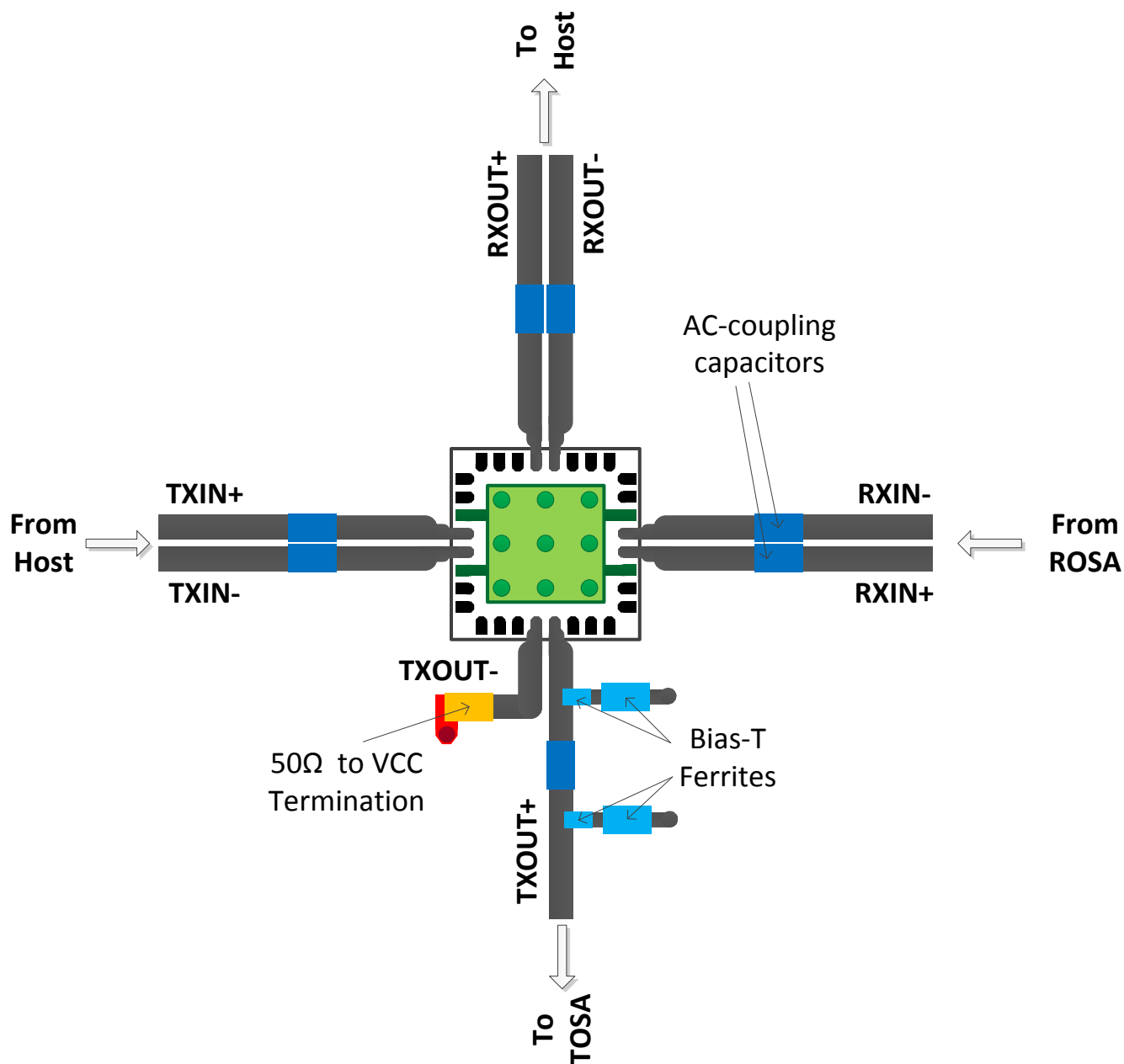
TI E2E™ Online Community *TI's Engineer-to-Engineer (E2E) Community*. Created to foster collaboration among engineers. At e2e.ti.com, you can ask questions, share knowledge, explore ideas and help solve problems with fellow engineers.

Design Support *TI's Design Support* Quickly find helpful E2E forums along with design support tools and contact information for technical support.

12.2 商标

E2E is a trademark of Texas Instruments.
All other trademarks are the property of their respective owners.

12.3 静电放电警告



这些装置包含有限的内置 ESD 保护。存储或装卸时，应将导线一起截短或将装置放置于导电泡棉中，以防止 MOS 门极遭受静电损伤。

12.4 Glossary

[SLYZ022](#) — *TI Glossary*.

This glossary lists and explains terms, acronyms, and definitions.

13 机械、封装和可订购信息

以下页中包括机械、封装和可订购信息。 这些信息是针对指定器件可提供的最新数据。 这些数据会在无通知且不
对本文档进行修订的情况下发生改变。 欲获得该数据表的浏览器版本，请查阅左侧的导航栏。

PACKAGING INFORMATION

Orderable part number	Status (1)	Material type (2)	Package Pins	Package qty Carrier	RoHS (3)	Lead finish/ Ball material (4)	MSL rating/ Peak reflow (5)	Op temp (°C)	Part marking (6)
ONET1130EPRSMR	Active	Production	VQFN (RSM) 32	3000 LARGE T&R	Yes	NIPDAU	Level-2-260C-1 YEAR	-40 to 100	ONET 1130EP
ONET1130EPRSMR.A	Active	Production	VQFN (RSM) 32	3000 LARGE T&R	Yes	NIPDAU	Level-2-260C-1 YEAR	-40 to 100	ONET 1130EP
ONET1130EPRSMT	Active	Production	VQFN (RSM) 32	250 SMALL T&R	Yes	NIPDAU	Level-2-260C-1 YEAR	-40 to 100	ONET 1130EP
ONET1130EPRSMT.A	Active	Production	VQFN (RSM) 32	250 SMALL T&R	Yes	NIPDAU	Level-2-260C-1 YEAR	-40 to 100	ONET 1130EP

(1) **Status:** For more details on status, see our [product life cycle](#).

(2) **Material type:** When designated, preproduction parts are prototypes/experimental devices, and are not yet approved or released for full production. Testing and final process, including without limitation quality assurance, reliability performance testing, and/or process qualification, may not yet be complete, and this item is subject to further changes or possible discontinuation. If available for ordering, purchases will be subject to an additional waiver at checkout, and are intended for early internal evaluation purposes only. These items are sold without warranties of any kind.

(3) **RoHS values:** Yes, No, RoHS Exempt. See the [TI RoHS Statement](#) for additional information and value definition.

(4) **Lead finish/Ball material:** Parts may have multiple material finish options. Finish options are separated by a vertical ruled line. Lead finish/Ball material values may wrap to two lines if the finish value exceeds the maximum column width.

(5) **MSL rating/Peak reflow:** The moisture sensitivity level ratings and peak solder (reflow) temperatures. In the event that a part has multiple moisture sensitivity ratings, only the lowest level per JEDEC standards is shown. Refer to the shipping label for the actual reflow temperature that will be used to mount the part to the printed circuit board.

(6) **Part marking:** There may be an additional marking, which relates to the logo, the lot trace code information, or the environmental category of the part.

Multiple part markings will be inside parentheses. Only one part marking contained in parentheses and separated by a "~" will appear on a part. If a line is indented then it is a continuation of the previous line and the two combined represent the entire part marking for that device.

Important Information and Disclaimer: The information provided on this page represents TI's knowledge and belief as of the date that it is provided. TI bases its knowledge and belief on information provided by third parties, and makes no representation or warranty as to the accuracy of such information. Efforts are underway to better integrate information from third parties. TI has taken and continues to take reasonable steps to provide representative and accurate information but may not have conducted destructive testing or chemical analysis on incoming materials and chemicals. TI and TI suppliers consider certain information to be proprietary, and thus CAS numbers and other limited information may not be available for release.

In no event shall TI's liability arising out of such information exceed the total purchase price of the TI part(s) at issue in this document sold by TI to Customer on an annual basis.

TAPE AND REEL INFORMATION

QUADRANT ASSIGNMENTS FOR PIN 1 ORIENTATION IN TAPE

*All dimensions are nominal

Device	Package Type	Package Drawing	Pins	SPQ	Reel Diameter (mm)	Reel Width W1 (mm)	A0 (mm)	B0 (mm)	K0 (mm)	P1 (mm)	W (mm)	Pin1 Quadrant
ONET1130EPRSMR	VQFN	RSM	32	3000	330.0	12.4	4.25	4.25	1.15	8.0	12.0	Q2
ONET1130EPRSMT	VQFN	RSM	32	250	180.0	12.4	4.25	4.25	1.15	8.0	12.0	Q2

TAPE AND REEL BOX DIMENSIONS

*All dimensions are nominal

Device	Package Type	Package Drawing	Pins	SPQ	Length (mm)	Width (mm)	Height (mm)
ONET1130EPRSMR	VQFN	RSM	32	3000	346.0	346.0	33.0
ONET1130EPRSMT	VQFN	RSM	32	250	210.0	185.0	35.0

GENERIC PACKAGE VIEW

RSM 32

VQFN - 1 mm max height

4 x 4, 0.4 mm pitch

PLASTIC QUAD FLATPACK - NO LEAD

This image is a representation of the package family, actual package may vary.
Refer to the product data sheet for package details.

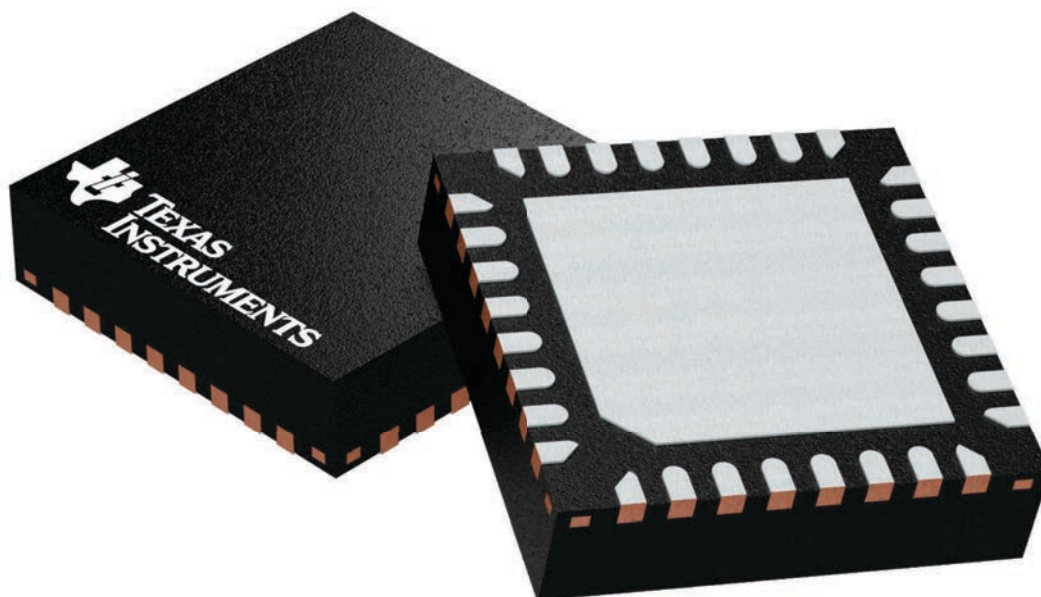

4224982/A

RSM0032B

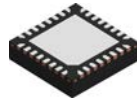

PACKAGE OUTLINE

VQFN - 1 mm max height

PLASTIC QUAD FLATPACK - NO LEAD

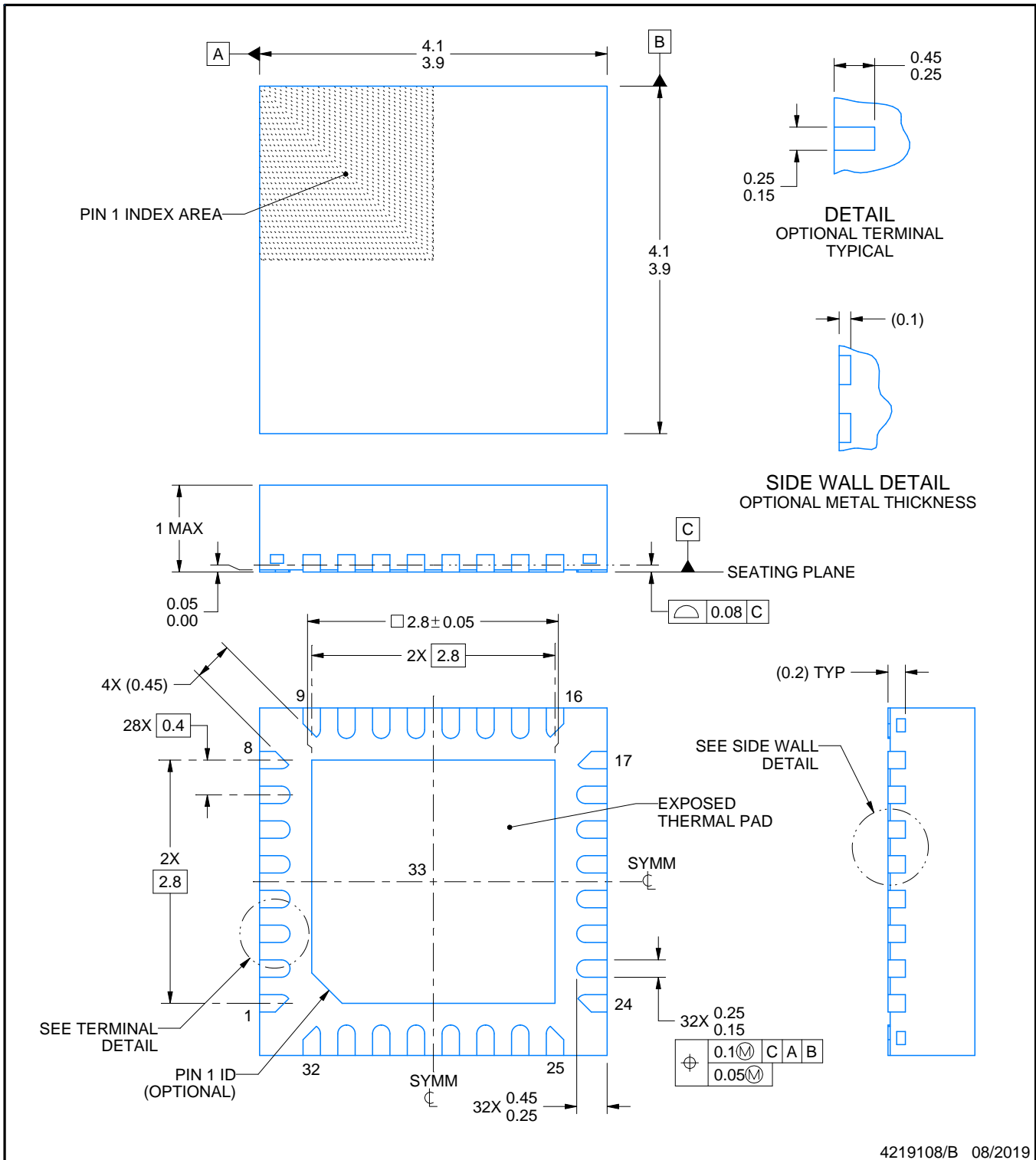

NOTES:

1. All linear dimensions are in millimeters. Any dimensions in parenthesis are for reference only. Dimensioning and tolerancing per ASME Y14.5M.
2. This drawing is subject to change without notice.
3. The package thermal pad must be soldered to the printed circuit board for thermal and mechanical performance.

EXAMPLE BOARD LAYOUT

RSM0032B

VQFN - 1 mm max height

PLASTIC QUAD FLATPACK - NO LEAD

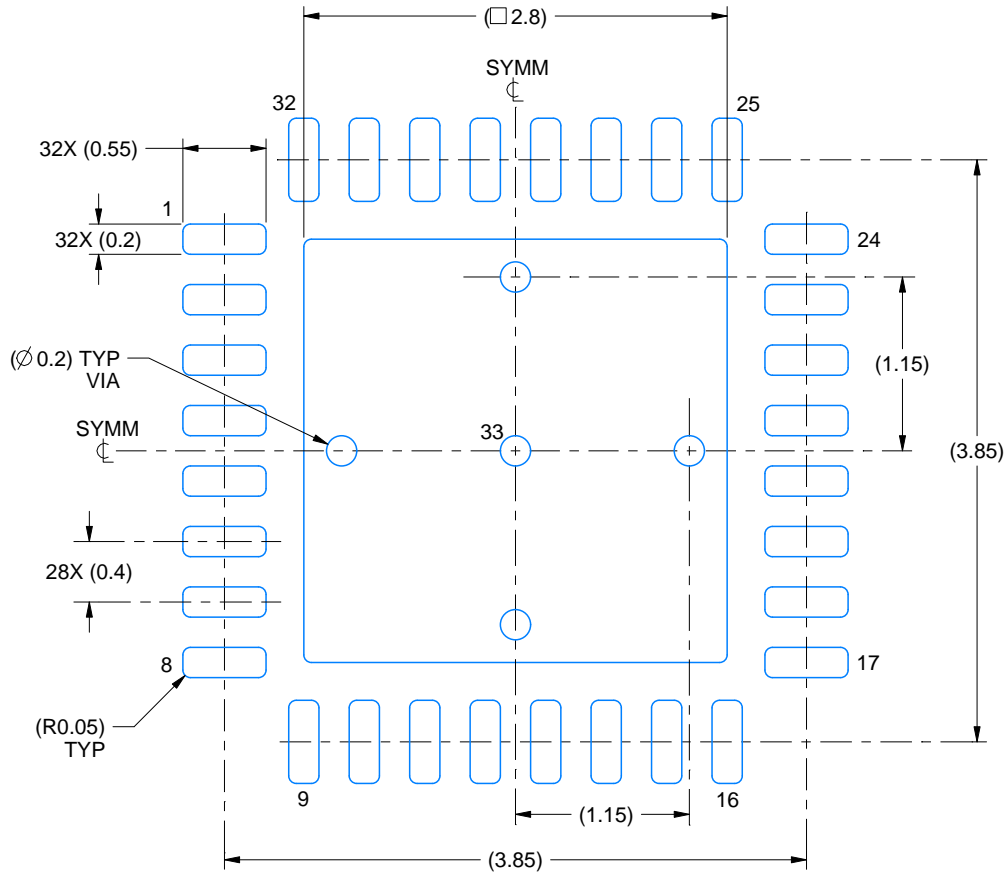

LAND PATTERN EXAMPLE
EXPOSED METAL SHOWN
SCALE:20X

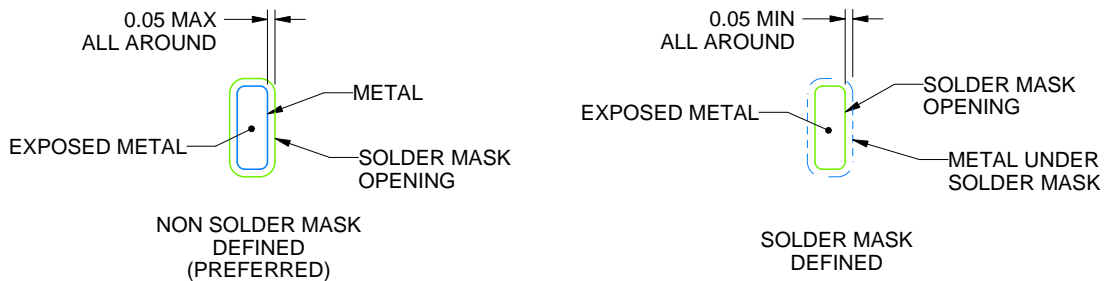

SOLDER MASK DETAILS

4219108/B 08/2019

NOTES: (continued)

- This package is designed to be soldered to a thermal pad on the board. For more information, see Texas Instruments literature number SLUA271 (www.ti.com/lit/slue271).
- Vias are optional depending on application, refer to device data sheet. If any vias are implemented, refer to their locations shown on this view. It is recommended that vias under paste be filled, plugged or tented.

EXAMPLE STENCIL DESIGN

RSM0032B

VQFN - 1 mm max height

PLASTIC QUAD FLATPACK - NO LEAD

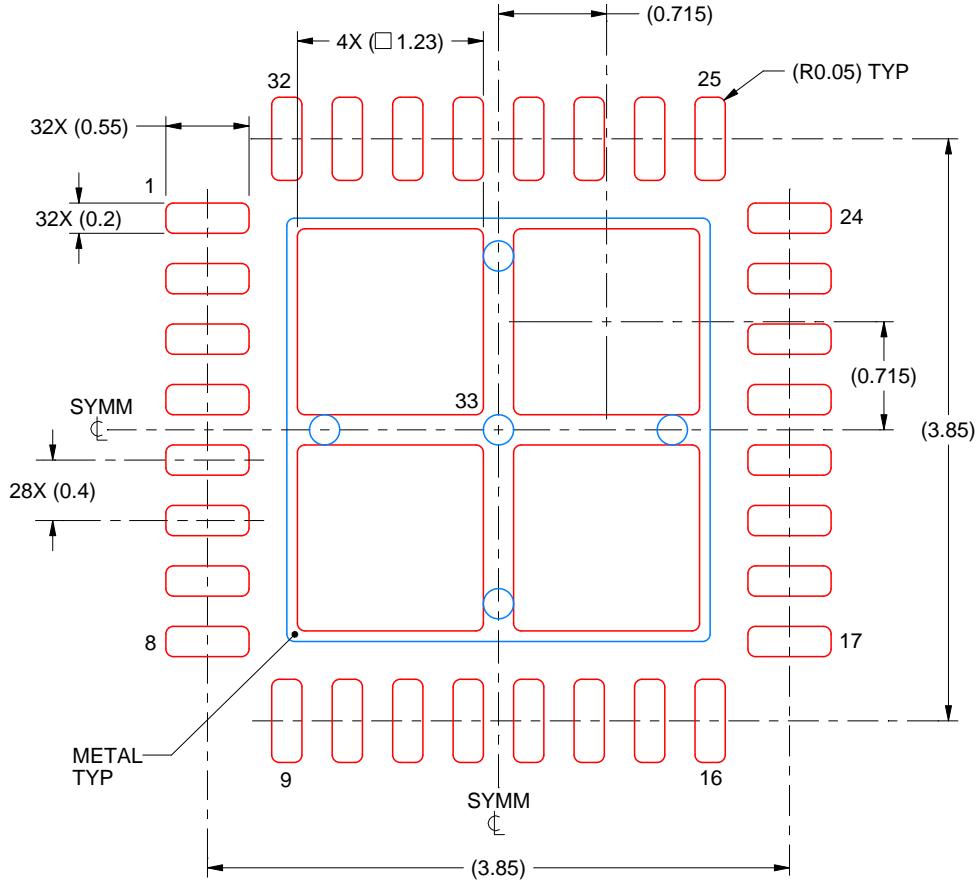

SOLDER PASTE EXAMPLE
 BASED ON 0.1 mm THICK STENCIL

EXPOSED PAD 33:
 77% PRINTED SOLDER COVERAGE BY AREA UNDER PACKAGE
 SCALE:20X

4219108/B 08/2019

NOTES: (continued)

6. Laser cutting apertures with trapezoidal walls and rounded corners may offer better paste release. IPC-7525 may have alternate design recommendations.

重要通知和免责声明

TI“按原样”提供技术和可靠性数据（包括数据表）、设计资源（包括参考设计）、应用或其他设计建议、网络工具、安全信息和其他资源，不保证没有瑕疵且不做任何明示或暗示的担保，包括但不限于对适销性、与某特定用途的适用性或不侵犯任何第三方知识产权的暗示担保。

这些资源可供使用 TI 产品进行设计的熟练开发人员使用。您将自行承担以下全部责任：(1) 针对您的应用选择合适的 TI 产品，(2) 设计、验证并测试您的应用，(3) 确保您的应用满足相应标准以及任何其他安全、安保法规或其他要求。

这些资源如有变更，恕不另行通知。TI 授权您仅可将这些资源用于研发本资源所述的 TI 产品的相关应用。严禁以其他方式对这些资源进行复制或展示。您无权使用任何其他 TI 知识产权或任何第三方知识产权。对于因您对这些资源的使用而对 TI 及其代表造成的任何索赔、损害、成本、损失和债务，您将全额赔偿，TI 对此概不负责。

TI 提供的产品受 [TI 销售条款](#)、[TI 通用质量指南](#) 或 [ti.com](#) 上其他适用条款或 TI 产品随附的其他适用条款的约束。TI 提供这些资源并不会扩展或以其他方式更改 TI 针对 TI 产品发布的适用的担保或担保免责声明。除非德州仪器 (TI) 明确将某产品指定为定制产品或客户特定产品，否则其产品均为按确定价格收入目录的标准通用器件。

TI 反对并拒绝您可能提出的任何其他或不同的条款。

版权所有 © 2025，德州仪器 (TI) 公司

最后更新日期：2025 年 10 月