

LMH664x 2.7 V, 650 μ A, 55 MHz, Rail-to-Rail Input and Output Amplifiers with Shutdown Option

1 Features

- ($V_S = 2.7V$, $T_A = 25^\circ C$, $R_L = 1k\Omega$ to $V^+/2$, $A_V = +1$. Typical Values Unless Specified.
- -3dB BW 55 MHz
- Supply Voltage Range 2.5 V to 12 V
- Slew Rate 22 V/ μ s
- Supply Current 650 μ A/channel
- Output Short Circuit Current 42 mA
- Linear Output Current ± 20 mA
- Input Common Mode Voltage 0.3 V Beyond Rails
- Output Voltage Swing 20 mV from Rails
- Input Voltage Noise 17 nV/ \sqrt{Hz}
- Input Current Noise 0.75 pA/ \sqrt{Hz}

2 Applications

- Active Filters
- High Speed Portable Devices
- Multiplexing Applications (LMH6647)
- Current Sense Buffer
- High Speed Transducer Amp

3 Description

The LMH6645 (single) and LMH6646 (dual), rail-to-rail input and output voltage feedback amplifiers, offer high speed (55 MHz), and low voltage operation (2.7 V) in addition to micro-power shutdown capability (LMH6647, single).

Input common mode voltage range exceeds either supply by 0.3 V, enhancing ease of use in multitude of applications where previously only inferior devices could be used. Output voltage range extends to within 20 mV of either supply rails, allowing wide dynamic range especially in low voltage applications. Even with low supply current of 650 μ A/amplifier, output current capability is kept at a respectable ± 20 mA for driving heavier loads. Important device parameters such as BW, Slew Rate and output current are kept relatively independent of the operating supply voltage by a combination of process enhancements and design architecture.

Device Information⁽¹⁾

PART NUMBER	PACKAGE	BODY SIZE (NOM)
LMH6645	SOT-23 (5)	2.90 mm x 1.60 mm
	SOIC (8)	4.90 mm x 3.91 mm
LMH6646	SOIC (8)	4.90 mm x 3.91 mm
	VSSOP (8)	3.00 mm x 3.00 mm
LMH6647	SOT-23 (6)	2.92 mm x 1.60 mm
	SOIC (8)	4.90 mm x 3.91 mm

(1) For all available packages, see the orderable addendum at the end of the datasheet.

Frequency Response for Various A_V

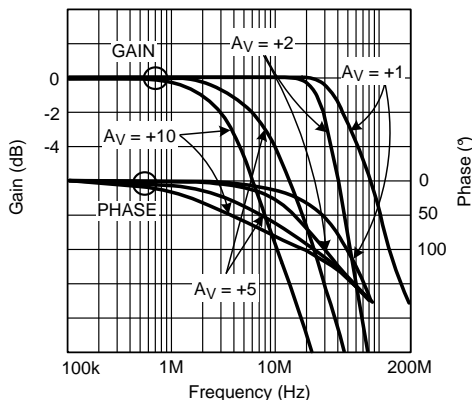

Closed Loop Frequency Response for Various Temperature

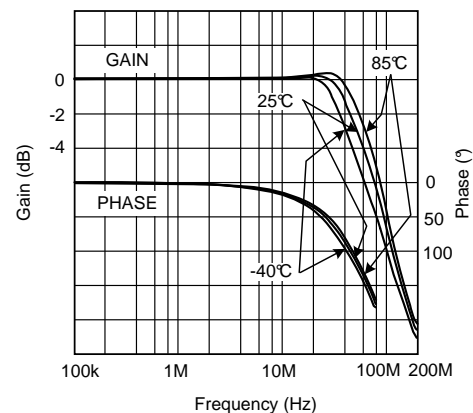

Table of Contents

1 Features	1	8.2 Functional Block Diagram	18
2 Applications	1	8.3 Feature Description	19
3 Description	1	8.4 Device Functional Modes	20
4 Revision History	2	9 Application and Implementation	22
5 Description (continued)	3	9.1 Application Information	22
6 Pin Configuration and Functions	3	9.2 Typical Application	22
7 Specifications	4	10 Power Supply Recommendations	23
7.1 Absolute Maximum Ratings	4	11 Layout	24
7.2 Handling Ratings	4	11.1 Layout Guidelines	24
7.3 Recommended Operating Conditions	4	11.2 Layout Example	24
7.4 Thermal Information	4	12 Device and Documentation Support	25
7.5 Electrical Characteristics 2.7 V	5	12.1 Documentation Support	25
7.6 Electrical Characteristics 5V	7	12.2 Related Links	25
7.7 Electrical Characteristics ±5V	9	12.3 Trademarks	25
7.8 Typical Performance Characteristics	11	12.4 Electrostatic Discharge Caution	25
8 Detailed Description	18	12.5 Glossary	25
8.1 Overview	18	13 Mechanical, Packaging, and Orderable Information	25

4 Revision History

NOTE: Page numbers for previous revisions may differ from page numbers in the current version.

Changes from Revision C (April 2013) to Revision D

Page

- Added, updated, or renamed the following sections: Device Information Table, *Pin Configuration and Functions*, *Application and Implementation*; *Power Supply Recommendations*; *Layout*, *Device and Documentation Support*; *Mechanical, Packaging, and Ordering Information*..... **1**

Changes from Revision B (April 2013) to Revision C

Page

- Changed layout of National Data Sheet to TI format

5 Description (continued)

In portable applications, the LMH6647 provides shutdown capability while keeping the turn-off current to less than 50 μ A. Both turn-on and turn-off characteristics are well behaved with minimal output fluctuations during transitions. This allows the part to be used in power saving mode, as well as multiplexing applications. Miniature packages (SOT-23, VSSOP-8, and SOIC-8) are further means to ease the adoption of these low power high speed devices in applications where board area is at a premium.

6 Pin Configuration and Functions

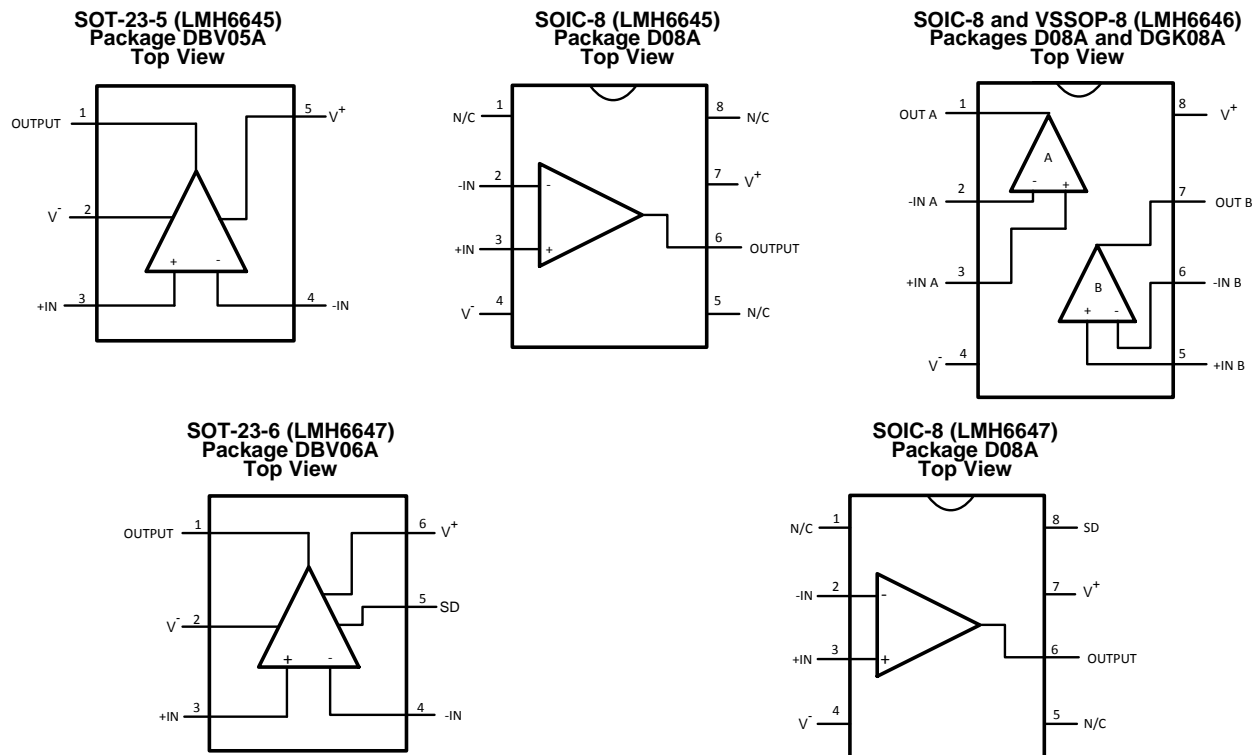

Pin Functions

NAME	PIN					I/O	DESCRIPTION
	NUMBER						
	LMH6645 DBV05A	LMH6646 D08A	LMH6646 DGK08A	LMH6647 DBV06A	LMH6647 D08A		
-IN	4	2		4	2	I	Inverting input
+IN	3	3		3	3	I	Non-inverting input
-IN A			2			I	Inverting Input Channel A
+IN A			3			I	Non-inverting input Channel A
-IN B			6			I	Inverting input Channel B
+IN B			5			I	Non-inverting input Channel B
N/C		1,5,8			1,5	—	No Connection
OUTPUT	1	6		1	6	O	Output
OUT A			1			O	Output Channel A
OUT B			7			O	Output Channel B
SD				5	8	I	Shutdown
V ⁻	2	4	4	2	4	I	Negative Supply
V ⁺	5	7	8	6	7	I	Positive Supply

7 Specifications

7.1 Absolute Maximum Ratings ⁽¹⁾⁽²⁾

over operating free-air temperature range (unless otherwise noted)

		MIN	MAX	UNIT
Output short circuit duration		See ⁽³⁾ and ⁽⁴⁾		
V_{IN} differential		±2.5		V
Voltage at input/output pins		V^+ +0.8, V^- -0.8		V
Supply voltage ($V^+ - V^-$)		12.6		V
Junction temperature ⁽⁵⁾		+150		°C
Soldering Information	Infrared or Convection (20 sec)	235		
	Wave Soldering (10 sec)	260		

- (1) Absolute Maximum Ratings indicate limits beyond which damage to the device may occur. Operating Ratings indicate conditions for which the device is intended to be functional, but specific performance is not ensured. For ensured specifications and the test conditions, see the Electrical Characteristics.
- (2) If Military/Aerospace specified devices are required, please contact the TI Sales Office/Distributors for availability and specifications.
- (3) Applies to both single-supply and split-supply operation. Continuous short circuit operation at elevated ambient temperature can result in exceeding the maximum allowed junction temperature of 150°C.
- (4) Output short circuit duration is infinite for $V_S < 6$ V at room temperature and below. For $V_S > 6$ V, allowable short circuit duration is 1.5 ms.
- (5) The maximum power dissipation is a function of $T_{J(MAX)}$, $R_{\theta JA}$, and T_A . The maximum allowable power dissipation at any ambient temperature is $P_D = (T_{J(MAX)} - T_A) / R_{\theta JA}$. All numbers apply for packages soldered directly onto a PC board.

7.2 Handling Ratings

			MIN	MAX	UNIT
T_{stg}	Storage temperature range		-65	+150	°C
$V_{(ESD)}$	Electrostatic discharge	Human body model (HBM), per ANSI/ESDA/JEDEC JS-001, all pins ⁽¹⁾	2000		V
		Machine model (MM) ⁽²⁾	200		

- (1) JEDEC document JEP155 states that 2000-V HBM allows safe manufacturing with a standard ESD control process. Human body model, 1.5 k Ω in series with 100pF.
- (2) JEDEC document JEP157 states that 200-V MM allows safe manufacturing with a standard ESD control process. Machine model, 0 Ω in series with 200 pF.

7.3 Recommended Operating Conditions⁽¹⁾

over operating free-air temperature range (unless otherwise noted)

		MIN	MAX	UNIT
Supply Voltage ($V^+ - V^-$)		2.5	12	V
Temperature Range ⁽²⁾		-40	+85	°C

- (1) Absolute Maximum Ratings indicate limits beyond which damage to the device may occur. Operating Ratings indicate conditions for which the device is intended to be functional, but specific performance is not ensured. For ensured specifications and the test conditions, see the Electrical Characteristics.
- (2) The maximum power dissipation is a function of $T_{J(MAX)}$, $R_{\theta JA}$, and T_A . The maximum allowable power dissipation at any ambient temperature is $P_D = (T_{J(MAX)} - T_A) / R_{\theta JA}$. All numbers apply for packages soldered directly onto a PC board.

7.4 Thermal Information

THERMAL METRIC ⁽¹⁾	LMH6645		LMH6646		LMH6647		UNIT
	SOT-23		SOIC-8	VSSOP-8	SOT-23	SOIC-8	
	5 PINS	8 PINS	8 PINS	8 PINS	6 PINS	8 PINS	
$R_{\theta JA}$ Junction-to-ambient thermal resistance	265	190	190	235	265	190	°C/W

- (1) For more information about traditional and new thermal metrics, see the *IC Package Thermal Metrics* application report, [SPRA953](http://www.ti.com/lit/zip/SRA953).

7.5 Electrical Characteristics 2.7 V

Unless otherwise specified, all limits ensured for at $T_J = 25^\circ\text{C}$, $V^+ = 2.7\text{V}$, $V^- = 0\text{V}$, $V_{\text{CM}} = V_O = V^+/2$, and $R_f = 2\text{k}\Omega$, and $R_L = 1\text{k}\Omega$ to $V^+/2$.

PARAMETER		TEST CONDITIONS	MIN ⁽¹⁾	TYP ⁽²⁾	MAX ⁽¹⁾	UNIT
BW	-3dB BW	$A_V = +1$, $V_{\text{OUT}} = 200\text{ mV}_{\text{PP}}$, $V_{\text{CM}} = 0.7\text{ V}$	40	55		MHz
e_n	Input-referred voltage noise	$f = 100\text{ kHz}$		17		$\text{nV}/\sqrt{\text{Hz}}$
		$f = 1\text{ kHz}$		25		
i_n	Input-referred current noise	$f = 100\text{ kHz}$		0.75		$\text{pA}/\sqrt{\text{Hz}}$
		$f = 1\text{ kHz}$		1.20		
CT Rej.	Cross-talk rejection (LMH6646 only)	$f = 5\text{MHz}$, Receiver: $R_f = R_g = 510\ \Omega$, $A_V = +2$		47		dB
SR	Slew rate	$A_V = -1$, $V_O = 2\text{ V}_{\text{PP}}$ See ⁽³⁾ , ⁽⁴⁾	15	22		$\text{V}/\mu\text{s}$
T_{ON}	Turn-on time (LMH6647 only)			250		ns
T_{OFF}	Turn-off time (LMH6647 only)			560		ns
TH_{SD}	Shutdown threshold (LMH6647 only)	$I_S \leq 50\ \mu\text{A}$		1.95	2.30	V
I_{SD}	Shutdown pin input current (LMH6647 only)	See ⁽⁵⁾		-20		μA
V_{OS}	Input offset voltage	$0\text{V} \leq V_{\text{CM}} \leq 2.7\text{ V}$	-3	± 1	3	mV
		$-40^\circ\text{C} \leq T_J \leq 85^\circ\text{C}$	-4		4	
TC V_{OS}	Input offset average drift	See ⁽⁶⁾		± 5		$\mu\text{V}/^\circ\text{C}$
I_B	Input bias current	$V_{\text{CM}} = 2.5\text{ V}$ ⁽⁵⁾		0.40	2	μA
		$-40^\circ\text{C} \leq T_J \leq 85^\circ\text{C}$			2.2	
I_B	Input bias current	$V_{\text{CM}} = 0.5\text{ V}$ ⁽⁵⁾		-0.68	-2	μA
		$-40^\circ\text{C} \leq T_J \leq 85^\circ\text{C}$			-2.2	
I_{OS}	Input offset current	$0\text{ V} \leq V_{\text{CM}} \leq 2.7\text{ V}$		1	500	nA
R_{IN}	Common mode input resistance			3		$\text{M}\Omega$
C_{IN}	Common mode input capacitance			2		pF
CMVR	Input common-mode voltage range	CMRR $\geq 50\text{dB}$		-0.5	-0.3	V
			$-40^\circ\text{C} \leq T_J \leq 85^\circ\text{C}$		-0.1	
			$-40^\circ\text{C} \leq T_J \leq 85^\circ\text{C}$	3.0	3.2	
CMRR	Common mode rejection ratio	V_{CM} Stepped from 0 V to 2.7 V	46	77		dB
		V_{CM} Stepped from 0 V to 1.55 V	58	76		
A_{VOL}	Large signal voltage gain	$V_O = 0.35\text{ V}$ to 2.35 V	76	87		dB
		$-40^\circ\text{C} \leq T_J \leq 85^\circ\text{C}$	74			
V_O	Output swing high	$R_L = 1\text{k}$ to $V^+/2$	2.55	2.66		V
		$R_L = 10\text{k}$ to $V^+/2$		2.68		
	Output swing low	$R_L = 1\text{k}$ to $V^+/2$		40	150	mV
		$R_L = 10\text{k}$ to $V^+/2$		20		

(1) All limits are ensured by testing or statistical analysis.

(2) Typical values represent the most likely parametric norm.

(3) Slew rate is the average of the rising and falling slew rates.

(4) ensured based on characterization only.

(5) Positive current corresponds to current flowing into the device.

(6) Offset voltage average drift determined by dividing the change in V_{OS} at temperature extremes into the total temperature change.

Electrical Characteristics 2.7 V (continued)

Unless otherwise specified, all limits ensured for at $T_J = 25^\circ\text{C}$, $V^+ = 2.7\text{V}$, $V^- = 0\text{V}$, $V_{\text{CM}} = V_O = V^+/2$, and $R_f = 2\text{k}\Omega$, and $R_L = 1\text{k}\Omega$ to $V^+/2$.

PARAMETER		TEST CONDITIONS	MIN ⁽¹⁾	TYP ⁽²⁾	MAX ⁽¹⁾	UNIT
I_{SC}	Output short circuit current	Sourcing to V^- $V_{\text{ID}} = 200\text{mV}$ ⁽⁷⁾⁽⁸⁾		43		mA
		Sinking to V^+ $V_{\text{ID}} = -200\text{mV}$ ⁽⁷⁾⁽⁸⁾		42		
I_{OUT}	Output current	$V_{\text{OUT}} = 0.5\text{V}$ from rails		± 20		mA
PSRR	Power supply rejection ratio	$V^+ = 2.7\text{V}$ to 3.7V or $V^- = 0\text{V}$ to -1V	75	83		dB
I_{S}	Supply current (per channel)	Normal Operation		650	1250	μA
		Shutdown Mode (LMH6647 only)		15	50	

(7) Short circuit test is a momentary test.

(8) Output short circuit duration is infinite for $V_{\text{S}} < 6\text{V}$ at room temperature and below. For $V_{\text{S}} > 6\text{V}$, allowable short circuit duration is 1.5ms.

7.6 Electrical Characteristics 5V

Unless otherwise specified, all limits ensured for at $T_J = 25^\circ\text{C}$, $V^+ = 5\text{V}$, $V^- = 0\text{V}$, $V_{\text{CM}} = V_O = V^+/2$, and $R_f = 2\text{k}\Omega$, and $R_L = 1\text{k}\Omega$ to $V^+/2$.

PARAMETER		TEST CONDITIONS	MIN ⁽¹⁾	TYP ⁽²⁾	MAX ⁽¹⁾	UNIT
BW	-3dB BW	$A_V = +1$, $V_{\text{OUT}} = 200\text{ mV}_{\text{PP}}$	40	55		MHz
e_n	Input-referred voltage noise	$f = 100\text{kHz}$		17		$\text{nV}/\sqrt{\text{Hz}}$
		$f = 1\text{kHz}$		25		
i_n	Input-referred current noise	$f = 100\text{kHz}$		0.75		$\text{pA}/\sqrt{\text{Hz}}$
		$f = 1\text{kHz}$		1.20		
CT Rej.	Cross-talk rejection (LMH6646 only)	$f = 5\text{MHz}$, Receiver: $R_f = R_g = 510\Omega$, $A_V = +2$		47		dB
SR	Slew rate	$A_V = -1$, $V_O = 2\text{ V}_{\text{PP}}$ See ⁽³⁾ , ⁽⁴⁾	15	22		$\text{V}/\mu\text{s}$
T_{ON}	Turn-on time (LMH6647 only)			210		ns
T_{OFF}	Turn-off time (LMH6647 only)			500		ns
TH_{SD}	Shutdown threshold (LMH6647 only)	$I_S \leq 50\mu\text{A}$		4.25	4.60	V
I_{SD}	Shutdown pin input current (LMH6647 only)	See ⁽⁵⁾		-20		μA
V_{OS}	Input offset voltage	$0\text{V} \leq V_{\text{CM}} \leq 5\text{V}$	-3	± 1	3	mV
		$-40^\circ\text{C} \leq T_J \leq 85^\circ\text{C}$	-4		4	
TC V_{OS}	Input offset average drift	See ⁽⁶⁾		± 5		$\mu\text{V}/\text{C}$
I_B	Input bias current	$V_{\text{CM}} = 4.8\text{V}^{(5)}$		+0.36	+2	μA
			$-40^\circ\text{C} \leq T_J \leq 85^\circ\text{C}$		-2.2	
		$V_{\text{CM}} = 0.5\text{V}^{(5)}$		-0.68	-2	
		$-40^\circ\text{C} \leq T_J \leq 85^\circ\text{C}$			-2.2	
I_{OS}	Input offset current	$0\text{V} \leq V_{\text{CM}} \leq 5\text{V}$		1	500	nA
R_{IN}	Common mode input resistance			3		$\text{M}\Omega$
C_{IN}	Common mode input capacitance			2		pF
CMVR	Input common-mode voltage range	CMRR $\geq 50\text{dB}$		-0.5	-0.3	V
			$-40^\circ\text{C} \leq T_J \leq 85^\circ\text{C}$		-0.1	
				5.3	5.5	
		$-40^\circ\text{C} \leq T_J \leq 85^\circ\text{C}$	5.1			
CMRR	Common mode rejection ratio	V_{CM} Stepped from 0V to 5V	56	82		dB
		V_{CM} Stepped from 0V to 3.8V	66	85		
A_{VOL}	Large signal voltage gain	$V_O = 1.5\text{V}$ to 3.5V	76	85		dB
		$-40^\circ\text{C} \leq T_J \leq 85^\circ\text{C}$	74			

(1) All limits are ensured by testing or statistical analysis.

(2) Typical values represent the most likely parametric norm.

(3) Slew rate is the average of the rising and falling slew rates.

(4) ensured based on characterization only.

(5) Positive current corresponds to current flowing into the device.

(6) Offset voltage average drift determined by dividing the change in V_{OS} at temperature extremes into the total temperature change.

Electrical Characteristics 5V (continued)

Unless otherwise specified, all limits ensured for at $T_J = 25^\circ\text{C}$, $V^+ = 5\text{V}$, $V^- = 0\text{V}$, $V_{\text{CM}} = V_O = V^+/2$, and $R_f = 2\text{k}\Omega$, and $R_L = 1\text{k}\Omega$ to $V^+/2$.

PARAMETER		TEST CONDITIONS	MIN ⁽¹⁾	TYP ⁽²⁾	MAX ⁽¹⁾	UNIT
V_O	Output swing high	$R_L = 1\text{k to } V^+/2$	4.80	4.95		V
		$R_L = 10\text{k to } V^+/2$		4.98		
	Output swing low	$R_L = 1\text{k to } V^+/2$		50	200	mV
		$R_L = 10\text{k to } V^+/2$		20		
I_{SC}	Output short circuit current	Sourcing to V^- $V_{\text{ID}} = 200\text{mV}$ ⁽⁷⁾⁽⁸⁾		55		mA
		Sinking to V^+ $V_{\text{ID}} = -200\text{mV}$ ⁽⁷⁾⁽⁸⁾		53		
I_{OUT}	Output current	$V_{\text{OUT}} = 0.5\text{V}$ From rails		± 20		mA
PSRR	Power supply rejection ratio	$V^+ = 5\text{V to } 6\text{V}$ or $V^- = 0\text{V to } -1\text{V}$	75	95		dB
I_S	Supply current (per channel)	Normal Operation		700	1400	μA
		Shutdown Mode (LMH6647 only)		10	50	

(7) Short circuit test is a momentary test.

(8) Output short circuit duration is infinite for $V_S < 6\text{V}$ at room temperature and below. For $V_S > 6\text{V}$, allowable short circuit duration is 1.5ms.

7.7 Electrical Characteristics ±5V

Unless otherwise specified, all limits ensured for at $T_J = 25^\circ\text{C}$, $V^+ = 5\text{V}$, $V^- = -5\text{V}$, $V_{\text{CM}} = V_O = 0\text{V}$, $R_f = 2\text{k}\Omega$, and $R_L = 1\text{k}\Omega$ to GND.

PARAMETER		TEST CONDITIONS	MIN ⁽¹⁾	TYP ⁽²⁾	MAX ⁽¹⁾	UNIT	
BW	-3dB BW	$A_V = +1$, $V_{\text{OUT}} = 200\text{ mV}_{\text{PP}}$	40	55		MHz	
e_n	Input-referred voltage noise	$f = 100\text{ kHz}$		17		$\text{nV}/\sqrt{\text{Hz}}$	
		$f = 1\text{ kHz}$		25			
i_n	Input-referred current noise	$f = 100\text{ kHz}$		0.75		$\text{pA}/\sqrt{\text{Hz}}$	
		$f = 1\text{ kHz}$		1.20			
CT Rej.	Cross-talk rejection (LMH6646 only)	$f = 5\text{MHz}$, Receiver: $R_f = R_g = 510\ \Omega$, $A_V = +2$		47		dB	
SR	Slew rate	$A_V = -1$, $V_O = 2\text{ V}_{\text{PP}}$ ⁽³⁾	15	22		V/ μs	
T_{ON}	Turn-on time (LMH6647 only)			200		ns	
T_{OFF}	Turn-off time (LMH6647 only)			700		ns	
TH_{SD}	Shutdown threshold (LMH6647 only)	$I_S \leq 50\ \mu\text{A}$		4.25	4.60	V	
I_{SD}	Shutdown pin input current (LMH6647 only)	See ⁽⁴⁾		-20		μA	
V_{OS}	Input offset voltage	$-5\text{V} \leq V_{\text{CM}} \leq 5\text{V}$	-3	± 1	3	mV	
		$-40^\circ\text{C} \leq T_J \leq 85^\circ\text{C}$	-4		4		
TC V_{OS}	Input offset average drift	See ⁽⁵⁾		± 5		$\mu\text{V}/^\circ\text{C}$	
I_B	Input bias current	$V_{\text{CM}} = 4.8\text{ V}$ ⁽⁴⁾		+0.40	+2	μA	
			$-40^\circ\text{C} \leq T_J \leq 85^\circ\text{C}$				+2.2
		$V_{\text{CM}} = -4.5\text{ V}$ ⁽⁴⁾		-0.65	-2		
			$-40^\circ\text{C} \leq T_J \leq 85^\circ\text{C}$				-2.2
I_{OS}	Input offset current	$-5\text{V} \leq V_{\text{CM}} \leq 5\text{V}$		3	500	nA	
R_{IN}	Common mode input resistance			3		M Ω	
C_{IN}	Common mode input capacitance			2		pF	
CMVR	Input common-mode voltage range	CMRR $\geq 50\text{dB}$		-5.5	-5.3	V	
			$-40^\circ\text{C} \leq T_J \leq 85^\circ\text{C}$				-5.1
			$-40^\circ\text{C} \leq T_J \leq 85^\circ\text{C}$	5.3	5.5		
CMRR	Common mode rejection ratio	V_{CM} Stepped from -5 V to 5 V	60	84		dB	
		V_{CM} Stepped from -5 V to 3.5 V	66	104			
A_{VOL}	Large signal voltage gain	$V_O = -2\text{ V}$ to 2 V	76	85		dB	
		$-40^\circ\text{C} \leq T_J \leq 85^\circ\text{C}$	74				

(1) All limits are ensured by testing or statistical analysis.

(2) Typical values represent the most likely parametric norm.

(3) Slew rate is the average of the rising and falling slew rates.

(4) Positive current corresponds to current flowing into the device.

(5) Offset voltage average drift determined by dividing the change in V_{OS} at temperature extremes into the total temperature change.

Electrical Characteristics ±5V (continued)

Unless otherwise specified, all limits ensured for at $T_J = 25^\circ\text{C}$, $V^+ = 5\text{V}$, $V^- = -5\text{V}$, $V_{\text{CM}} = V_O = 0\text{V}$, $R_f = 2\text{k}\Omega$, and $R_L = 1\text{k}\Omega$ to GND.

PARAMETER		TEST CONDITIONS	MIN ⁽¹⁾	TYP ⁽²⁾	MAX ⁽¹⁾	UNIT
V_O	Output swing high	$R_L = 1\text{ k}\Omega$	4.70	4.92		V
		$R_L = 10\text{ k}\Omega$		4.97		
	Output swing low	$R_L = 1\text{ k}\Omega$		-4.93	-4.70	V
		$R_L = 10\text{ k}\Omega$		-4.98		
I_{SC}	Output short circuit current	Sourcing to V^- $V_{\text{ID}} = 200\text{ mV}^{(6)(7)}$		66		mA
		Sinking to V^+ $V_{\text{ID}} = -200\text{ mV}^{(6)(7)}$		61		
I_{OUT}	Output current	$V_{\text{OUT}} = 0.5\text{V}$ from rails		±20		mA
PSRR	Power supply rejection ratio	$V^+ = 5\text{ V}$ to 6 V or $V^- = -5\text{ V}$ to -6 V	76	95		dB
I_S	Supply current (per channel)	Normal Operation		725	1600	μA
		Shutdown Mode (LMH6647 only)		10	50	

(6) Short circuit test is a momentary test.

(7) Output short circuit duration is infinite for $V_S < 6\text{V}$ at room temperature and below. For $V_S > 6\text{V}$, allowable short circuit duration is 1.5ms.

7.8 Typical Performance Characteristics

At $T_J = 25^\circ\text{C}$. Unless otherwise specified.

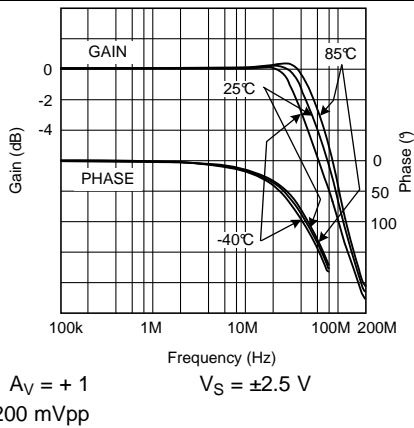

Figure 1. Closed Loop Frequency Response for Various Temperature

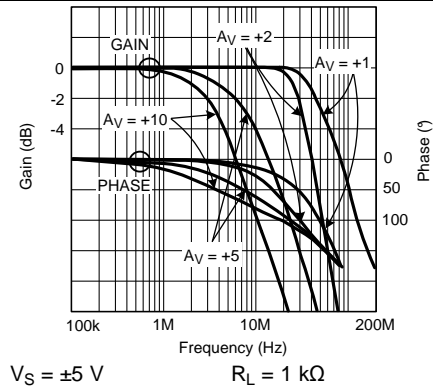

Figure 2. Frequency Response for Various A_V

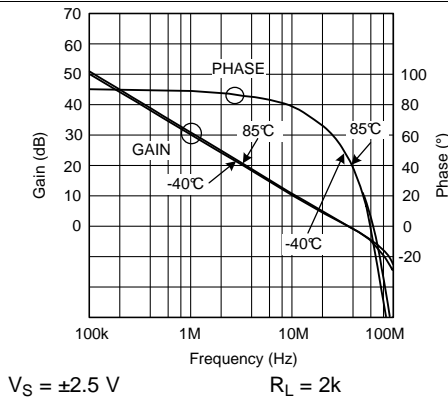

Figure 3. Open Loop Gain/Phase vs. Frequency for Various Temperature

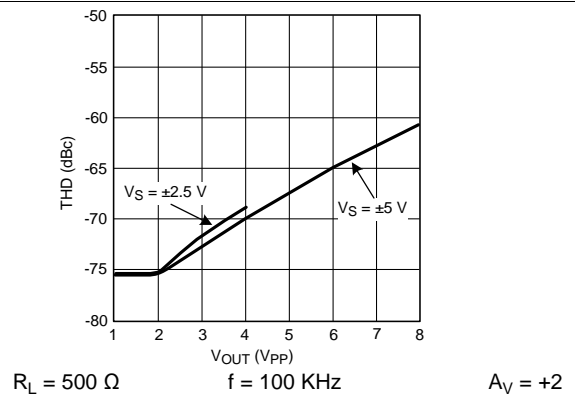

Figure 4. THD vs. Output Swing

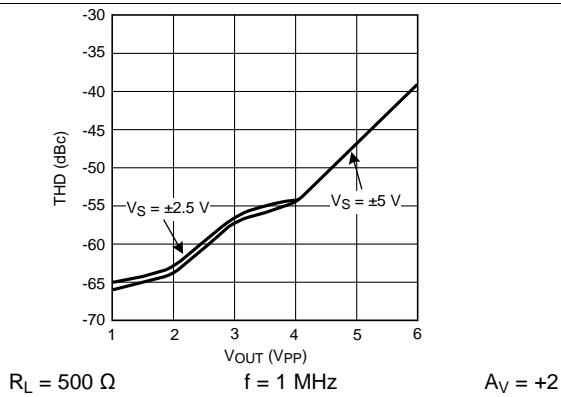

Figure 5. THD vs. Output Swing

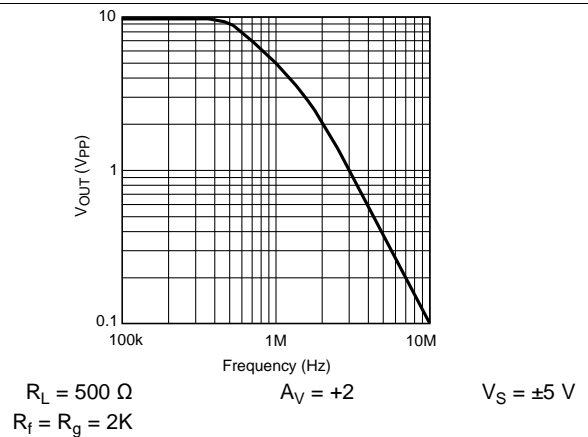

Figure 6. Output Swing vs. Frequency

Typical Performance Characteristics (continued)

At $T_J = 25^\circ\text{C}$. Unless otherwise specified.

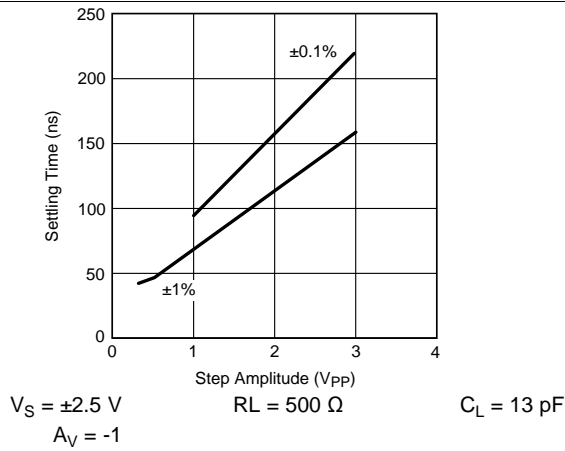

Figure 7. Settling Time vs. Step Size

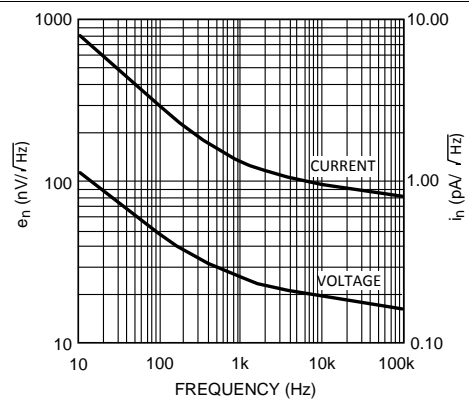

Figure 8. Noise vs. Frequency

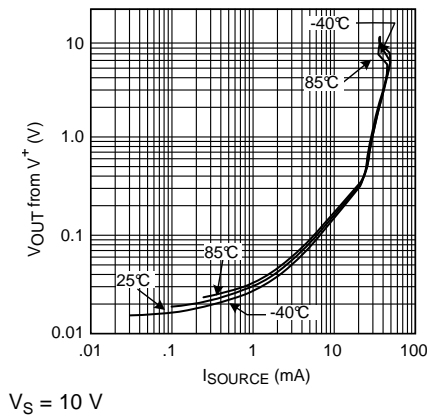

Figure 9. V_{OUT} from V^+ vs. I_{SOURCE}

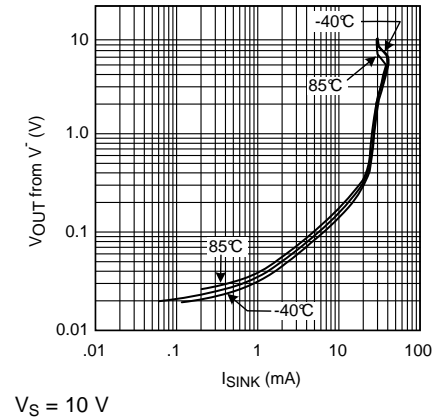

Figure 10. V_{OUT} from V^- vs. I_{SINK}

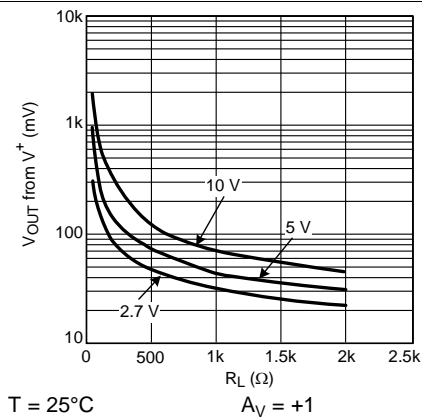

Figure 11. Output Swing from V^+ vs. R_L (tied to $V_S/2$)

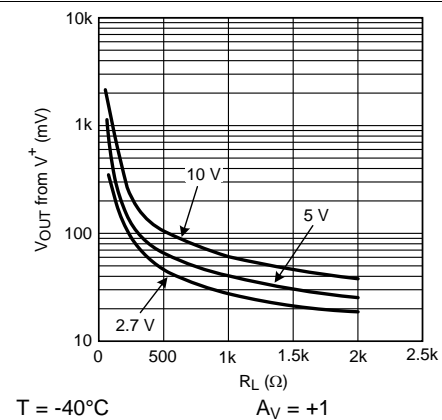

Figure 12. Output Swing from V^+ vs. R_L (Tied to $V_S/2$)

Typical Performance Characteristics (continued)

At $T_J = 25^\circ\text{C}$. Unless otherwise specified.

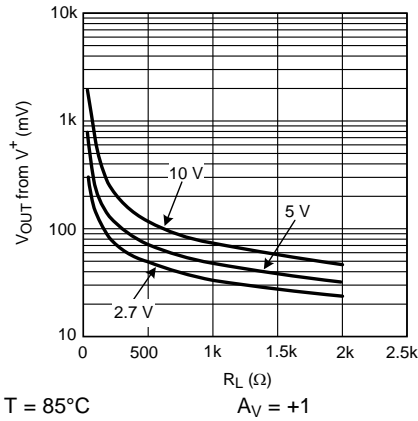

Figure 13. Output Swing from V^+ vs. R_L (Tied to $V_S/2$)

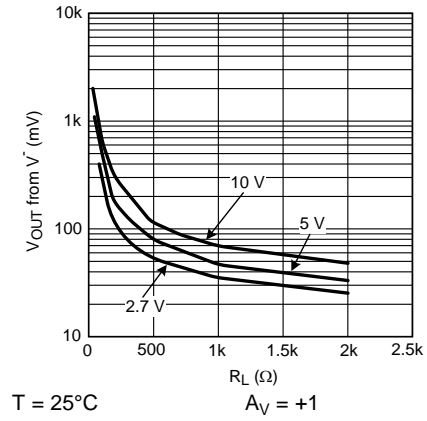

Figure 14. Output Swing from V^- vs. R_L (Tied to $V_S/2$)

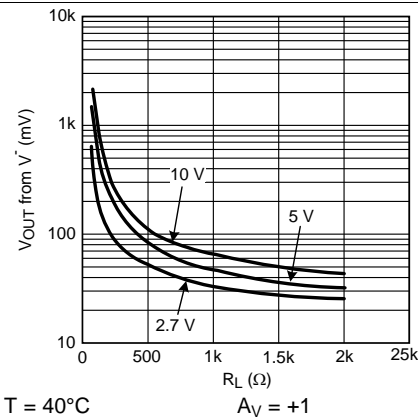

Figure 15. Output Swing from V^- vs. R_L (Tied to $V_S/2$)

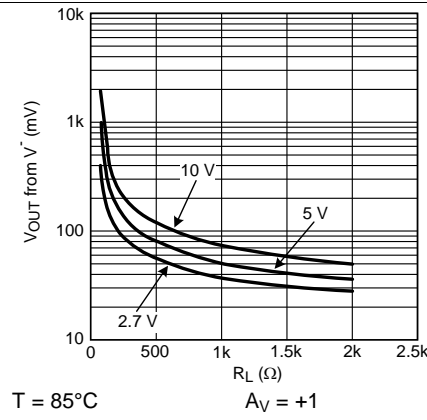

Figure 16. Output Swing from V^- vs. R_L (Tied to $V_S/2$)

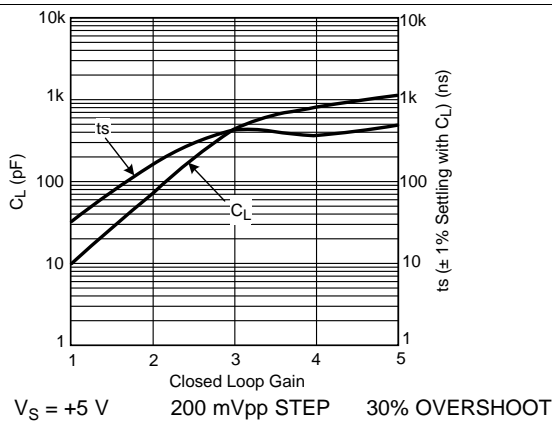

Figure 17. Cap Load Tolerance and Setting Time vs. Closed Loop Gain

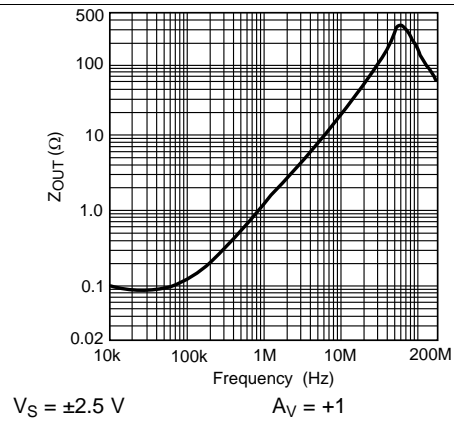

Figure 18. Z_{OUT} vs. Frequency

Typical Performance Characteristics (continued)

At $T_J = 25^\circ\text{C}$. Unless otherwise specified.

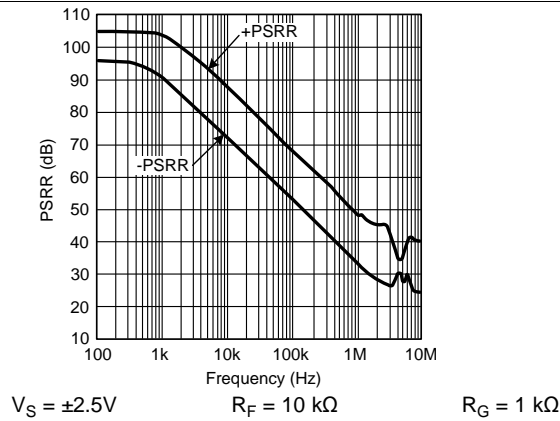

Figure 19. PSRR vs. Frequency

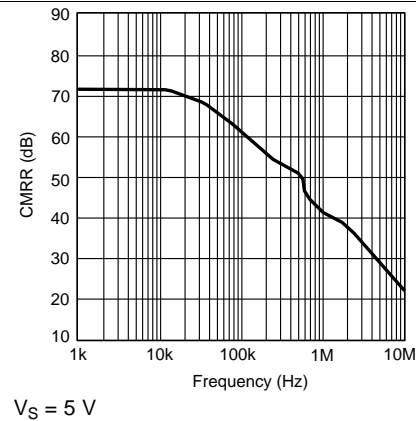

Figure 20. CMRR vs. Frequency

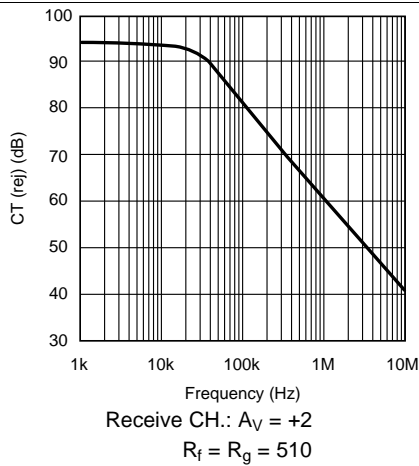

Figure 21. Crosstalk Rejection vs. Frequency (Output to Output, LMH6646)

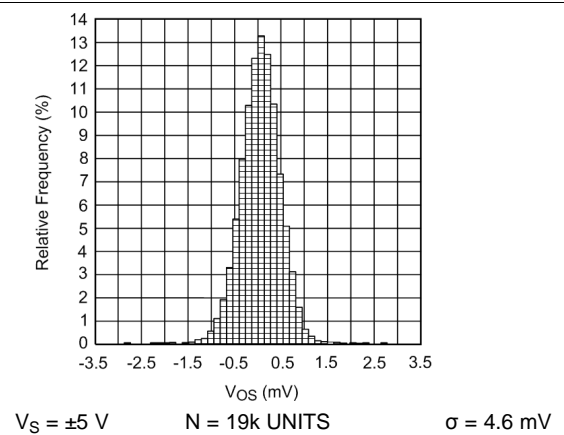

Figure 22. V_{OS} Distribution

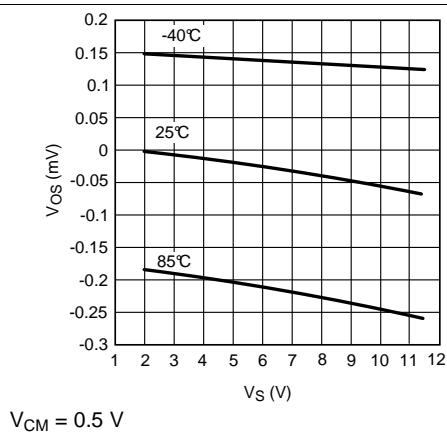

Figure 23. V_{OS} vs. V_S (a Typical Unit)

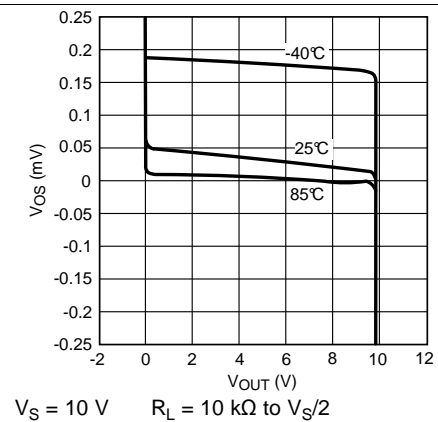

Figure 24. V_{OS} vs. V_{OUT} (a Typical Unit)

Typical Performance Characteristics (continued)

At $T_J = 25^\circ\text{C}$. Unless otherwise specified.

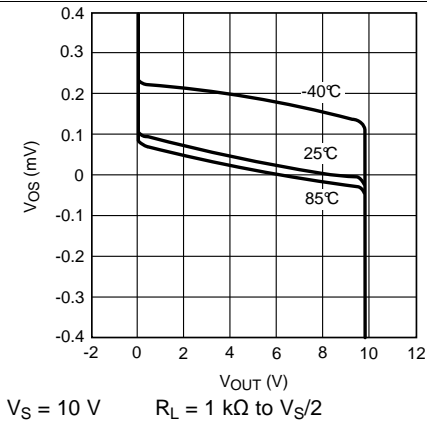
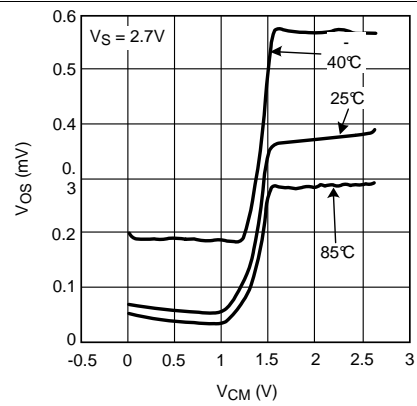
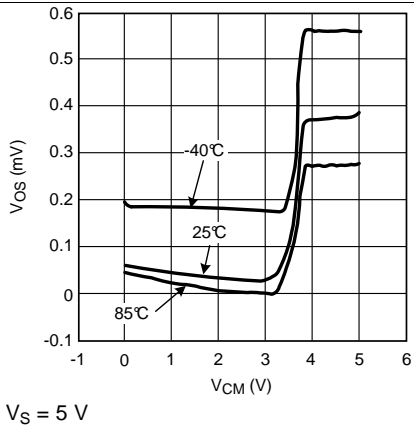

Figure 25. V_{OS} vs. V_{OUT} (a Typical Unit)



$V_S = 2.7\text{ V}$

Figure 26. V_{OS} vs. V_{CM} (a Typical Unit)



$V_S = 5\text{ V}$

Figure 27. V_{OS} vs. V_{CM} (a Typical Unit)

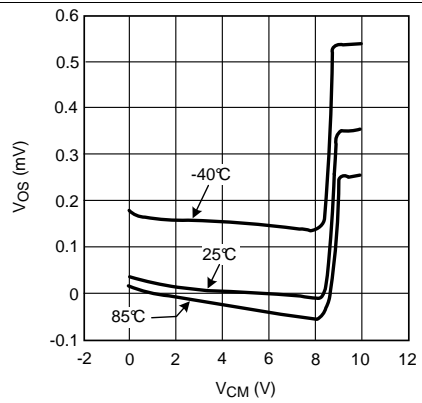

$V_S = 10\text{ V}$

Figure 28. V_{OS} vs. V_{CM} (a Typical Unit)

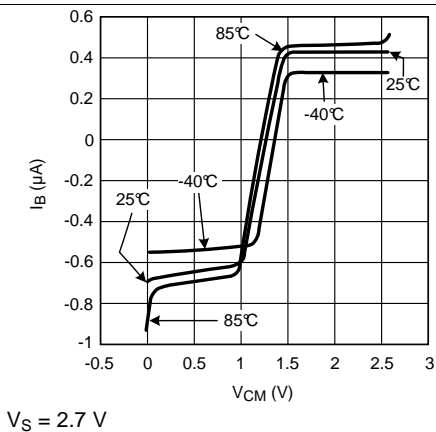

$V_S = 2.7\text{ V}$

Figure 29. I_B vs. V_{CM}

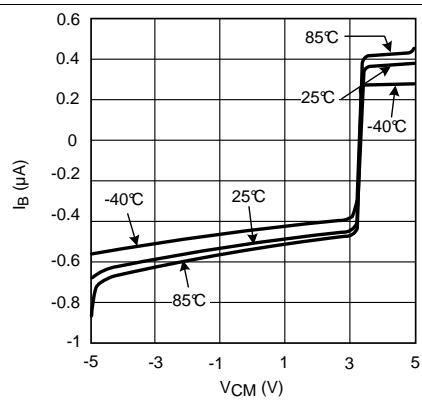

$V_S = \pm 5\text{ V}$

Figure 30. I_B vs. V_{CM}

Typical Performance Characteristics (continued)

At $T_J = 25^\circ\text{C}$. Unless otherwise specified.

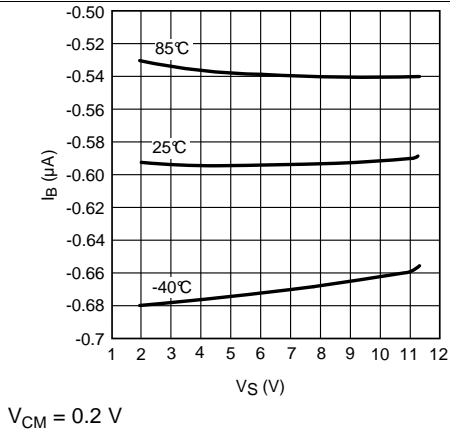

Figure 31. I_B vs. V_S

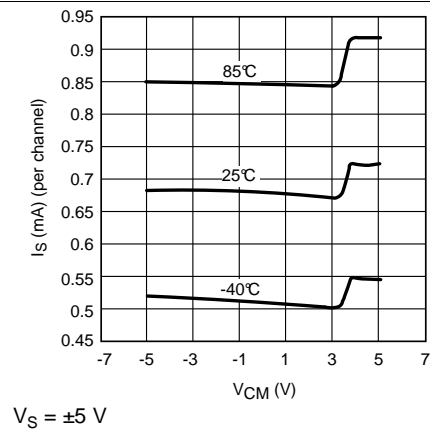

Figure 32. I_S vs. V_{CM}

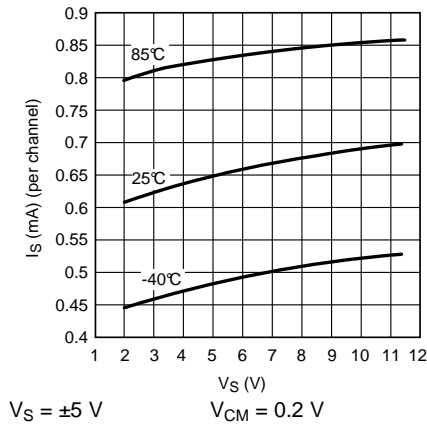

Figure 33. I_S (mA) vs. V_S (V)

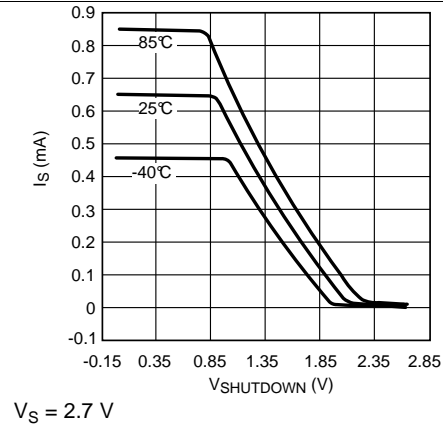

Figure 34. I_S vs. $V_{SHUTDOWN}$ (LMH6647)

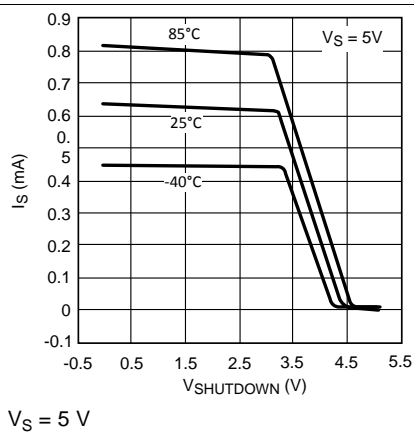

Figure 35. I_S vs. $V_{SHUTDOWN}$ (LMH6647)

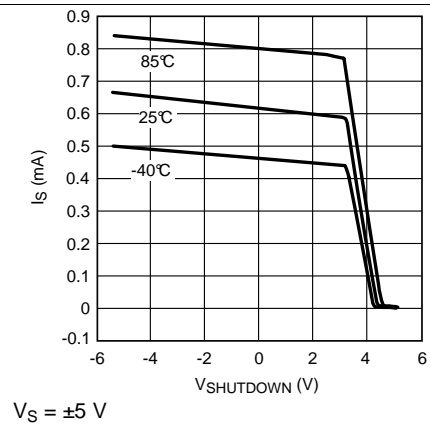

Figure 36. I_S vs. $V_{SHUTDOWN}$ (LMH6647)

Typical Performance Characteristics (continued)

At $T_J = 25^\circ\text{C}$. Unless otherwise specified.

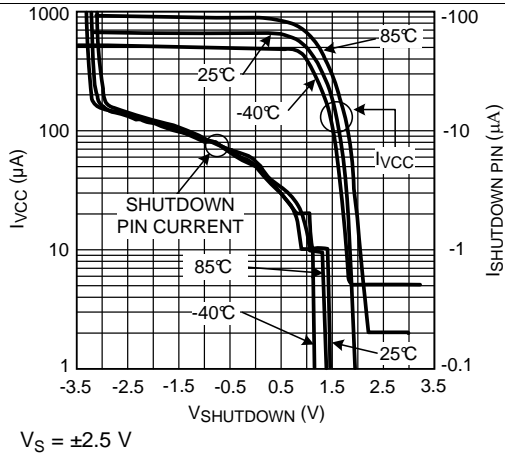

Figure 37. Shutdown Pin and Supply Current vs. Shutdown Voltage (LMH6647)

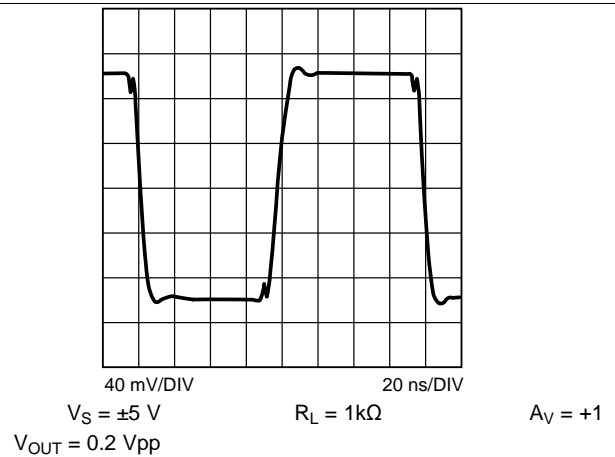

Figure 38. Small Signal Step Response

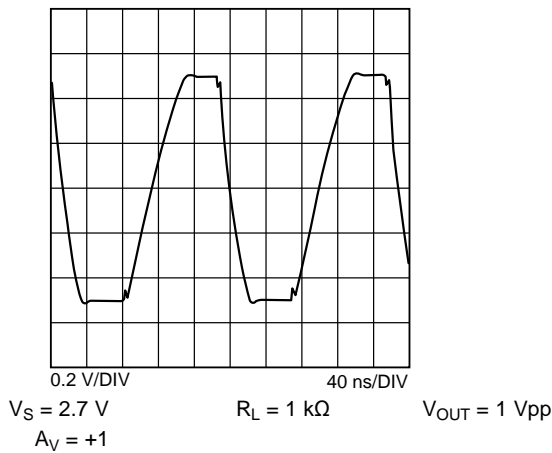

Figure 39. Large Signal Step Response

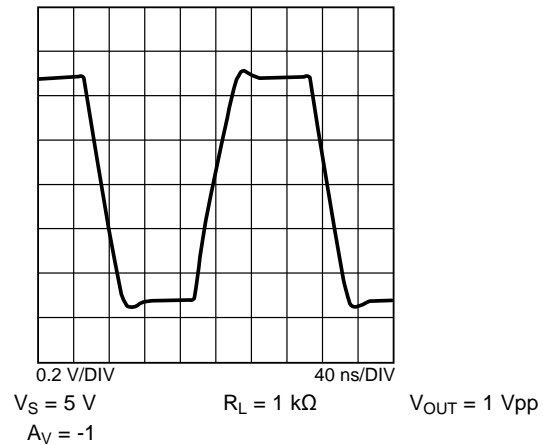

Figure 40. Large Signal Step Response

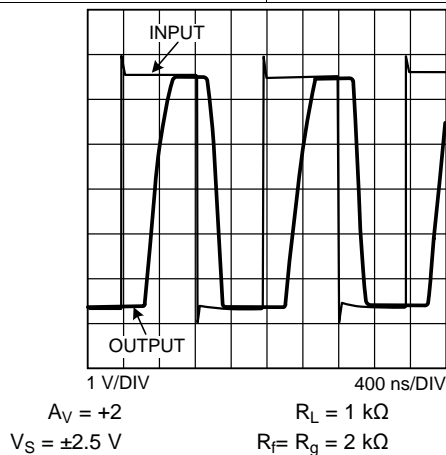

Figure 41. Output Overload Recovery

8 Detailed Description

8.1 Overview

The LMH664x family is based on proprietary VIP10 dielectrically isolated bipolar process.

This device family architecture features the following:

- Complimentary bipolar devices with exceptionally high f_t (~8 GHz) even under low supply voltage (2.7 V) and low Collector bias current.
- Rail-to-Rail input which allows the input common mode voltage to go beyond either rail by about 0.5 V typically.
- A class A-B “turn-around” stage with improved noise, offset, and reduced power dissipation compared to similar speed devices (patent pending).
- Common Emitter push-pull output stage capable of 20 mA output current (at 0.5 V from the supply rails) while consuming only ~700 μ A of total supply current per channel. This architecture allows output to reach within mV of either supply rail at light loads.
- Consistent performance from any supply voltage (2.7 V to 10 V) with little variation with supply voltage for the most important specifications (BW, SR, I_{OUT} , for example)

8.2 Functional Block Diagram

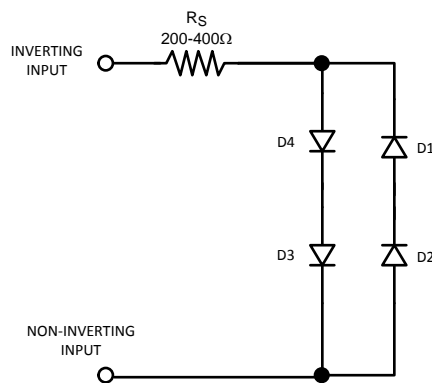

Figure 42. LMH6647 Equivalent Input in Shutdown Mode

During shutdown, the input stage has an equivalent circuit as shown below in [Figure 42](#).

8.3 Feature Description

8.3.1 LMH6647 Micro-power Shutdown

To keep the output at or near ground during shutdown when there is no other device to hold the output low, a switch (transistor) could be used to shunt the output to ground. Figure 43 shows a circuit where a NPN bipolar is used to keep the output near ground (~ 80 mV):

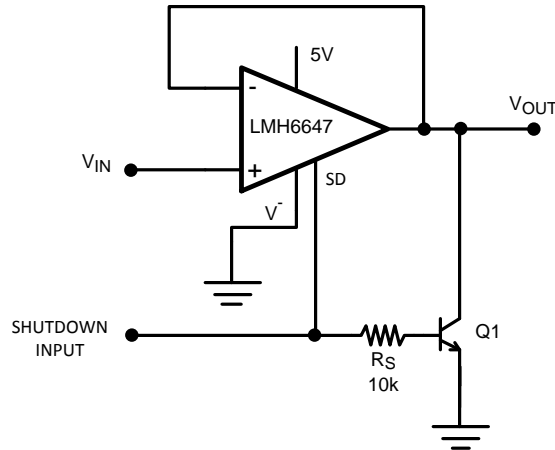

Figure 43. Active Pull-Down Schematic

Figure 44 shows the output waveform.

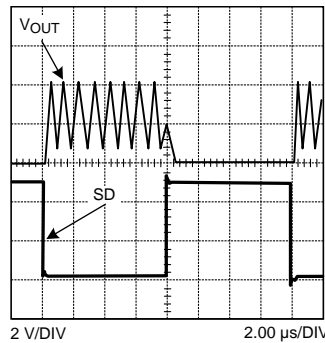

Figure 44. Output Held Low by Active Pull-Down Circuit

NOTE

For normal operation, tie the SD pin to V^- .

If bipolar transistor power dissipation is not tolerable, the switch could be by a N-channel enhancement mode MOSFET.

8.4 Device Functional Modes

The LMH6647 can be shutdown to save power and reduce its supply current to less than 50 μA ensured, by applying a voltage to the SD pin. The SD pin is “active high” and needs to be tied to V^- for normal operation. This input is low current ($< 20 \mu\text{A}$, 4 pF equivalent capacitance) and a resistor to V^- ($\leq 20 \text{k}\Omega$) will result in normal operation. Shutdown is ensured when SD pin is 0.4V or less from V^+ at any operating supply voltage and temperature.

In the shutdown mode, essentially all internal device biasing is turned off in order to minimize supply current flow and the output goes into Hi-Z (high impedance) mode. Complete device Turn-on and Turn-off times vary considerably relative to the output loading conditions, output voltage, and input impedance, but is generally limited to less than 1 μs (see tables for actual data).

As seen in [Figure 42](#) in shutdown, there may be current flow through the internal diodes shown, caused by input potential, if present. This current may flow through the external feedback resistor and result in an apparent output signal. In most shutdown applications the presence of this output is inconsequential. However, if the output is “forced” by another device such as in a multiplexer, the other device will need to conduct the current described in order to maintain the output potential.

The total input common mode voltage range, which extends from below V^- to beyond V^+ , is covered by both an NPN and a PNP stage. The NPN stage is switched on whenever the input is less than 1.2 V from V^+ and the PNP stage covers the rest of the range. In terms of the input voltage, there is an overlapping region where both stages are processing the input signal. This region is about 0.5 V from beginning to the end. As far as the device application is concerned, this transition is a transparent operation. However, keep in mind that the input bias current value and direction will depend on which input stage is operating (see [Figure 29](#)). For low distortion applications, it is best to keep the input common mode voltage from crossing this transition point. Low gain settling applications, which generally encounter larger peak-to-peak input voltages, could be configured as inverting stages to eliminate common mode voltage fluctuations.

In terms of the output, when the output swing approaches either supply rail, the output transistor will enter a quasi-saturated state. A subtle effect of this operational region is that there is an increase in supply current in this state (up to 1 mA). The onset of Quasi-saturation region is a function of output loading (current) and varies from 100 mV at no load to about 1 V when output is delivering 20 mA, as measured from supplies. Both input common mode voltage and output voltage level affect the supply current (see [Figure 32](#)).

With 2.7V supplies and a common mode input voltage range that extends beyond either supply rail, the LMH664x family is well suited to many low voltage/low power applications. Even with 2.7 V supplies, the -3dB BW (@ $A_v = +1$) is typically 55 MHz with a tested limit of 45 MHz. Production testing guarantees that process variations will not compromise speed.

This device family is designed to avoid output phase reversal. With input over-drive, the output is kept near the supply rail (or as close to it as mandated by the closed loop gain setting and the input voltage). [Figure 45](#), below, shows the input and output voltage when the input voltage significantly exceeds the supply voltages.

The output does not exhibit any phase reversal as some op amps do. However, if the input voltage range is exceeded by more than a diode drop beyond either rail, the internal ESD protection diodes will start to conduct. The current flow in these ESD diodes should be externally limited.

Device Functional Modes (continued)

Figure 45 demonstrates that the output is well behaved and there are no spikes or glitches due to the switching. Switching times are approximately around 500 ns based on the time when the output is considered “valid”.

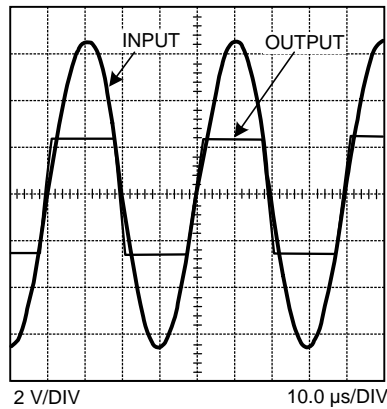

Figure 45. Input/Output Shown with Exceeded Input CMVR

9 Application and Implementation

NOTE

Information in the following applications sections is not part of the TI component specification, and TI does not warrant its accuracy or completeness. TI's customers are responsible for determining suitability of components for their purposes. Customers should validate and test their design implementation to confirm system functionality.

9.1 Application Information

The LMH664x family is well suited to many low voltage/low power applications and is designed to avoid output phase reversal. [Figure 45](#), for example, depicts the Input/Output Shown with Exceeded Input CMVR and functions as a 2:1 MUX operating on a single 2.7-V power supply by utilizing the shutdown feature of the LMH6647.

9.2 Typical Application

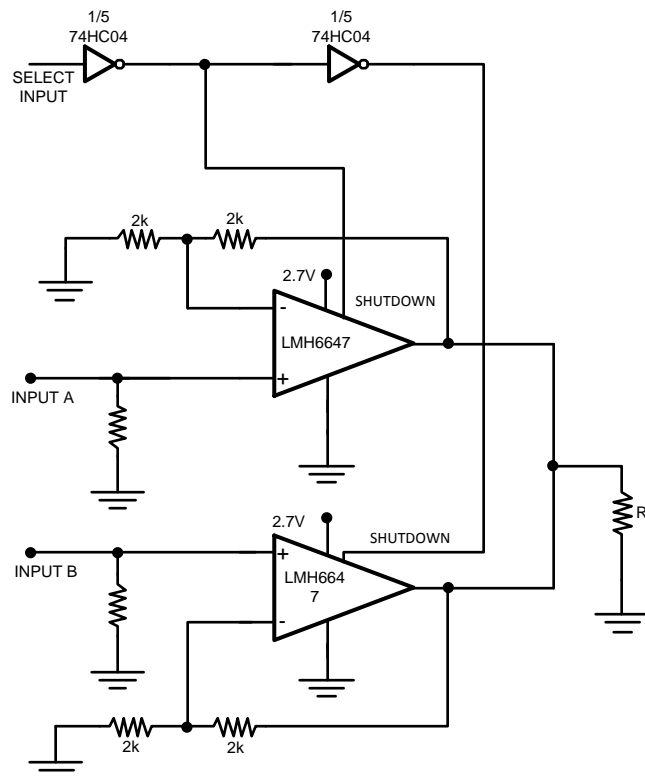

Figure 46. 2:1 MUX Operating off a 2.7V Single Supply

9.2.1 Design Requirements

This application requires fast, glitch-less transition between selected channels. The LMH6647 turn on and turn off times are 250 ns and 560 ns respectively. Transition between channels is devoid of any excessive glitches.

9.2.2 Detailed Design Procedure

In this application, the LMH6647 output pins are directly tied to each other. The shutdown pin of each LMH6647 is driven in-opposite sense of the other (that is, “Low” on 1st LMH6647 with “High” on the 2nd LMH6647, and vice versa). When shutdown is invoked, the device output enters Hi-Z state, while the alternate LMH6647 is being powered on simultaneously. This way, the shutdown function serves the dual purpose of allowing only the input associated with device which is not in shutdown to be selected and to appear at the output.

Typical Application (continued)

9.2.3 Application Curve

Figure 47 shows the MUX output when selecting between a 1 MHz sine and a 250 KHz triangular waveform.

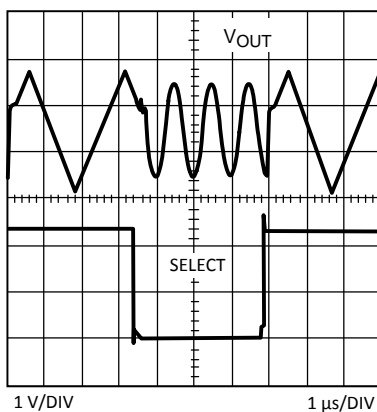

Figure 47. 2:1 MUX Output

10 Power Supply Recommendations

The LMH664x device family can operate off a single supply or with dual supplies. The input CM capability of the parts (CMVR) extends covers the entire supply voltage range for maximum flexibility. Supplies should be decoupled with low inductance, often ceramic, capacitors to ground less than 0.5 inches from the device pins. The use of ground plane is recommended, and as in most high speed devices, it is advisable to remove ground plane close to device sensitive pins such as the inputs.

11 Layout

11.1 Layout Guidelines

Generally, a good high-frequency layout will keep power supply and ground traces away from the inverting input and output pins. Parasitic capacitances on these nodes to ground will cause frequency response peaking and possible circuit oscillations. For more information, see Application Note OA-15, *Frequent Faux Pas in Applying Wideband Current Feedback Amplifiers* ([SNOA367](#)).

Another important parameter in working with high speed/high performance amplifiers is the component values selection. Choosing large valued external resistors will affect the closed loop behavior of the stage because of the interaction of these resistors with parasitic capacitances. These capacitors could be inherent to the device or a by-product of the board layout and component placement. Either way, keeping the resistor values lower will diminish this interaction. On the other hand, choosing very low value resistors could load down nodes and will contribute to higher overall power dissipation.

11.2 Layout Example

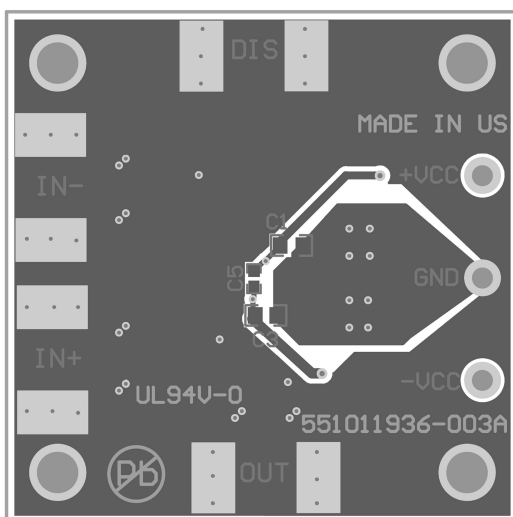

Figure 48. Layer2 Silk (SOT-23 Board Layout)

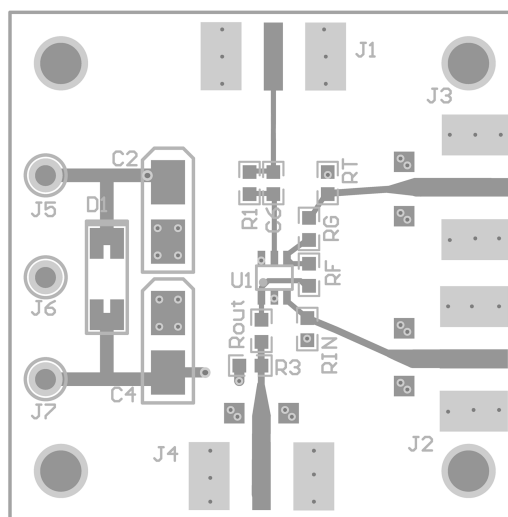

Figure 49. Layer1 Silk (SOT-23 Board Layout)

12 Device and Documentation Support

12.1 Documentation Support

12.1.1 Related Documentation

For related documentation, see the following:

- *Absolute Maximum Ratings for Soldering* ([SNOA549](#))
- *Frequent Faux Pas in Applying Wideband Current Feedback Amplifiers*, Application Note OA-15 ([SNOA367](#))
- *Semiconductor and IC Package Thermal Metrics* ([SPRA953](#))

12.2 Related Links

The table below lists quick access links. Categories include technical documents, support and community resources, tools and software, and quick access to sample or buy.

Table 1. Related Links

PARTS	PRODUCT FOLDER	SAMPLE & BUY	TECHNICAL DOCUMENTS	TOOLS & SOFTWARE	SUPPORT & COMMUNITY
LMH6645	Click here	Click here	Click here	Click here	Click here
LMH6646	Click here	Click here	Click here	Click here	Click here
LMH6647	Click here	Click here	Click here	Click here	Click here

12.3 Trademarks

All trademarks are the property of their respective owners.

12.4 Electrostatic Discharge Caution



These devices have limited built-in ESD protection. The leads should be shorted together or the device placed in conductive foam during storage or handling to prevent electrostatic damage to the MOS gates.

12.5 Glossary

[SLYZ022](#) — *TI Glossary*.

This glossary lists and explains terms, acronyms, and definitions.

13 Mechanical, Packaging, and Orderable Information

The following pages include mechanical, packaging, and orderable information. This information is the most current data available for the designated devices. This data is subject to change without notice and revision of this document. For browser-based versions of this data sheet, refer to the left-hand navigation.

PACKAGING INFORMATION

Orderable part number	Status (1)	Material type (2)	Package Pins	Package qty Carrier	RoHS (3)	Lead finish/ Ball material (4)	MSL rating/ Peak reflow (5)	Op temp (°C)	Part marking (6)
LMH6645MA/NOPB	Active	Production	SOIC (D) 8	95 TUBE	Yes	SN	Level-1-260C-UNLIM	-40 to 85	LMH66 45MA
LMH6645MA/NOPB.A	Active	Production	SOIC (D) 8	95 TUBE	Yes	SN	Level-1-260C-UNLIM	-40 to 85	LMH66 45MA
LMH6645MAX/NOPB	Active	Production	SOIC (D) 8	2500 LARGE T&R	Yes	SN	Level-1-260C-UNLIM	-40 to 85	LMH66 45MA
LMH6645MAX/NOPB.A	Active	Production	SOIC (D) 8	2500 LARGE T&R	Yes	SN	Level-1-260C-UNLIM	-40 to 85	LMH66 45MA
LMH6645MF/NOPB	Active	Production	SOT-23 (DBV) 5	1000 SMALL T&R	Yes	Call TI Sn Nipdau	Level-1-260C-UNLIM	-40 to 85	A68A
LMH6645MF/NOPB.A	Active	Production	SOT-23 (DBV) 5	1000 SMALL T&R	Yes	NIPDAU	Level-1-260C-UNLIM	-40 to 85	A68A
LMH6645MFX/NOPB	Active	Production	SOT-23 (DBV) 5	3000 LARGE T&R	Yes	Call TI Sn Nipdau	Level-1-260C-UNLIM	-40 to 85	A68A
LMH6645MFX/NOPB.A	Active	Production	SOT-23 (DBV) 5	3000 LARGE T&R	Yes	Call TI	Level-1-260C-UNLIM	-40 to 85	A68A
LMH6646MA/NOPB	Active	Production	SOIC (D) 8	95 TUBE	Yes	SN	Level-1-260C-UNLIM	-40 to 85	LMH66 46MA
LMH6646MA/NOPB.A	Active	Production	SOIC (D) 8	95 TUBE	Yes	SN	Level-1-260C-UNLIM	-40 to 85	LMH66 46MA
LMH6646MAX/NOPB	Active	Production	SOIC (D) 8	2500 LARGE T&R	Yes	SN	Level-1-260C-UNLIM	-40 to 85	LMH66 46MA
LMH6646MAX/NOPB.A	Active	Production	SOIC (D) 8	2500 LARGE T&R	Yes	SN	Level-1-260C-UNLIM	-40 to 85	LMH66 46MA
LMH6646MM/NOPB	Active	Production	VSSOP (DGK) 8	1000 SMALL T&R	Yes	SN	Level-1-260C-UNLIM	-40 to 85	A70A
LMH6646MM/NOPB.A	Active	Production	VSSOP (DGK) 8	1000 SMALL T&R	Yes	SN	Level-1-260C-UNLIM	-40 to 85	A70A
LMH6646MMX/NOPB	Active	Production	VSSOP (DGK) 8	3500 LARGE T&R	Yes	SN	Level-1-260C-UNLIM	-40 to 85	A70A
LMH6646MMX/NOPB.A	Active	Production	VSSOP (DGK) 8	3500 LARGE T&R	Yes	SN	Level-1-260C-UNLIM	-40 to 85	A70A
LMH6647MA/NOPB	Active	Production	SOIC (D) 8	95 TUBE	Yes	SN	Level-1-260C-UNLIM	-40 to 85	LMH66 47MA
LMH6647MA/NOPB.A	Active	Production	SOIC (D) 8	95 TUBE	Yes	SN	Level-1-260C-UNLIM	-40 to 85	LMH66 47MA
LMH6647MAX/NOPB	Active	Production	SOIC (D) 8	2500 LARGE T&R	Yes	SN	Level-1-260C-UNLIM	-40 to 85	LMH66 47MA
LMH6647MAX/NOPB.A	Active	Production	SOIC (D) 8	2500 LARGE T&R	Yes	SN	Level-1-260C-UNLIM	-40 to 85	LMH66 47MA

Orderable part number	Status (1)	Material type (2)	Package Pins	Package qty Carrier	RoHS (3)	Lead finish/ Ball material (4)	MSL rating/ Peak reflow (5)	Op temp (°C)	Part marking (6)
LMH6647MF/NOPB	Active	Production	SOT-23 (DBV) 6	1000 SMALL T&R	Yes	SN	Level-1-260C-UNLIM	-40 to 85	A69A
LMH6647MF/NOPB.A	Active	Production	SOT-23 (DBV) 6	1000 SMALL T&R	Yes	SN	Level-1-260C-UNLIM	-40 to 85	A69A
LMH6647MFX/NOPB	Active	Production	SOT-23 (DBV) 6	3000 LARGE T&R	Yes	SN	Level-1-260C-UNLIM	-40 to 85	A69A
LMH6647MFX/NOPB.A	Active	Production	SOT-23 (DBV) 6	3000 LARGE T&R	Yes	SN	Level-1-260C-UNLIM	-40 to 85	A69A

⁽¹⁾ **Status:** For more details on status, see our [product life cycle](#).

⁽²⁾ **Material type:** When designated, preproduction parts are prototypes/experimental devices, and are not yet approved or released for full production. Testing and final process, including without limitation quality assurance, reliability performance testing, and/or process qualification, may not yet be complete, and this item is subject to further changes or possible discontinuation. If available for ordering, purchases will be subject to an additional waiver at checkout, and are intended for early internal evaluation purposes only. These items are sold without warranties of any kind.

⁽³⁾ **RoHS values:** Yes, No, RoHS Exempt. See the [TI RoHS Statement](#) for additional information and value definition.

⁽⁴⁾ **Lead finish/Ball material:** Parts may have multiple material finish options. Finish options are separated by a vertical ruled line. Lead finish/Ball material values may wrap to two lines if the finish value exceeds the maximum column width.

⁽⁵⁾ **MSL rating/Peak reflow:** The moisture sensitivity level ratings and peak solder (reflow) temperatures. In the event that a part has multiple moisture sensitivity ratings, only the lowest level per JEDEC standards is shown. Refer to the shipping label for the actual reflow temperature that will be used to mount the part to the printed circuit board.

⁽⁶⁾ **Part marking:** There may be an additional marking, which relates to the logo, the lot trace code information, or the environmental category of the part.

Multiple part markings will be inside parentheses. Only one part marking contained in parentheses and separated by a "-" will appear on a part. If a line is indented then it is a continuation of the previous line and the two combined represent the entire part marking for that device.

Important Information and Disclaimer: The information provided on this page represents TI's knowledge and belief as of the date that it is provided. TI bases its knowledge and belief on information provided by third parties, and makes no representation or warranty as to the accuracy of such information. Efforts are underway to better integrate information from third parties. TI has taken and continues to take reasonable steps to provide representative and accurate information but may not have conducted destructive testing or chemical analysis on incoming materials and chemicals. TI and TI suppliers consider certain information to be proprietary, and thus CAS numbers and other limited information may not be available for release.

In no event shall TI's liability arising out of such information exceed the total purchase price of the TI part(s) at issue in this document sold by TI to Customer on an annual basis.

TAPE AND REEL INFORMATION

QUADRANT ASSIGNMENTS FOR PIN 1 ORIENTATION IN TAPE

*All dimensions are nominal

Device	Package Type	Package Drawing	Pins	SPQ	Reel Diameter (mm)	Reel Width W1 (mm)	A0 (mm)	B0 (mm)	K0 (mm)	P1 (mm)	W (mm)	Pin1 Quadrant
LMH6645MAX/NOPB	SOIC	D	8	2500	330.0	12.4	6.5	5.4	2.0	8.0	12.0	Q1
LMH6645MF/NOPB	SOT-23	DBV	5	1000	178.0	8.4	3.2	3.2	1.4	4.0	8.0	Q3
LMH6645MF/NOPB	SOT-23	DBV	5	1000	180.0	8.4	3.2	3.2	1.4	4.0	8.0	Q3
LMH6645MFX/NOPB	SOT-23	DBV	5	3000	180.0	8.4	3.2	3.2	1.4	4.0	8.0	Q3
LMH6645MFX/NOPB	SOT-23	DBV	5	3000	178.0	8.4	3.2	3.2	1.4	4.0	8.0	Q3
LMH6646MAX/NOPB	SOIC	D	8	2500	330.0	12.4	6.5	5.4	2.0	8.0	12.0	Q1
LMH6646MM/NOPB	VSSOP	DGK	8	1000	177.8	12.4	5.3	3.4	1.4	8.0	12.0	Q1
LMH6646MMX/NOPB	VSSOP	DGK	8	3500	330.0	12.4	5.3	3.4	1.4	8.0	12.0	Q1
LMH6647MAX/NOPB	SOIC	D	8	2500	330.0	12.4	6.5	5.4	2.0	8.0	12.0	Q1
LMH6647MF/NOPB	SOT-23	DBV	6	1000	178.0	8.4	3.2	3.2	1.4	4.0	8.0	Q3
LMH6647MFX/NOPB	SOT-23	DBV	6	3000	178.0	8.4	3.2	3.2	1.4	4.0	8.0	Q3

TAPE AND REEL BOX DIMENSIONS

*All dimensions are nominal

Device	Package Type	Package Drawing	Pins	SPQ	Length (mm)	Width (mm)	Height (mm)
LMH6645MAX/NOPB	SOIC	D	8	2500	367.0	367.0	35.0
LMH6645MF/NOPB	SOT-23	DBV	5	1000	208.0	191.0	35.0
LMH6645MF/NOPB	SOT-23	DBV	5	1000	210.0	185.0	35.0
LMH6645MFX/NOPB	SOT-23	DBV	5	3000	210.0	185.0	35.0
LMH6645MFX/NOPB	SOT-23	DBV	5	3000	208.0	191.0	35.0
LMH6646MAX/NOPB	SOIC	D	8	2500	367.0	367.0	35.0
LMH6646MM/NOPB	VSSOP	DGK	8	1000	208.0	191.0	35.0
LMH6646MMX/NOPB	VSSOP	DGK	8	3500	367.0	367.0	35.0
LMH6647MAX/NOPB	SOIC	D	8	2500	367.0	367.0	35.0
LMH6647MF/NOPB	SOT-23	DBV	6	1000	208.0	191.0	35.0
LMH6647MFX/NOPB	SOT-23	DBV	6	3000	208.0	191.0	35.0

TUBE

*All dimensions are nominal

Device	Package Name	Package Type	Pins	SPQ	L (mm)	W (mm)	T (μm)	B (mm)
LMH6645MA/NOPB	D	SOIC	8	95	495	8	4064	3.05
LMH6645MA/NOPB.A	D	SOIC	8	95	495	8	4064	3.05
LMH6646MA/NOPB	D	SOIC	8	95	495	8	4064	3.05
LMH6646MA/NOPB.A	D	SOIC	8	95	495	8	4064	3.05
LMH6647MA/NOPB	D	SOIC	8	95	495	8	4064	3.05
LMH6647MA/NOPB.A	D	SOIC	8	95	495	8	4064	3.05

DBV0005A



PACKAGE OUTLINE

SOT-23 - 1.45 mm max height

SMALL OUTLINE TRANSISTOR

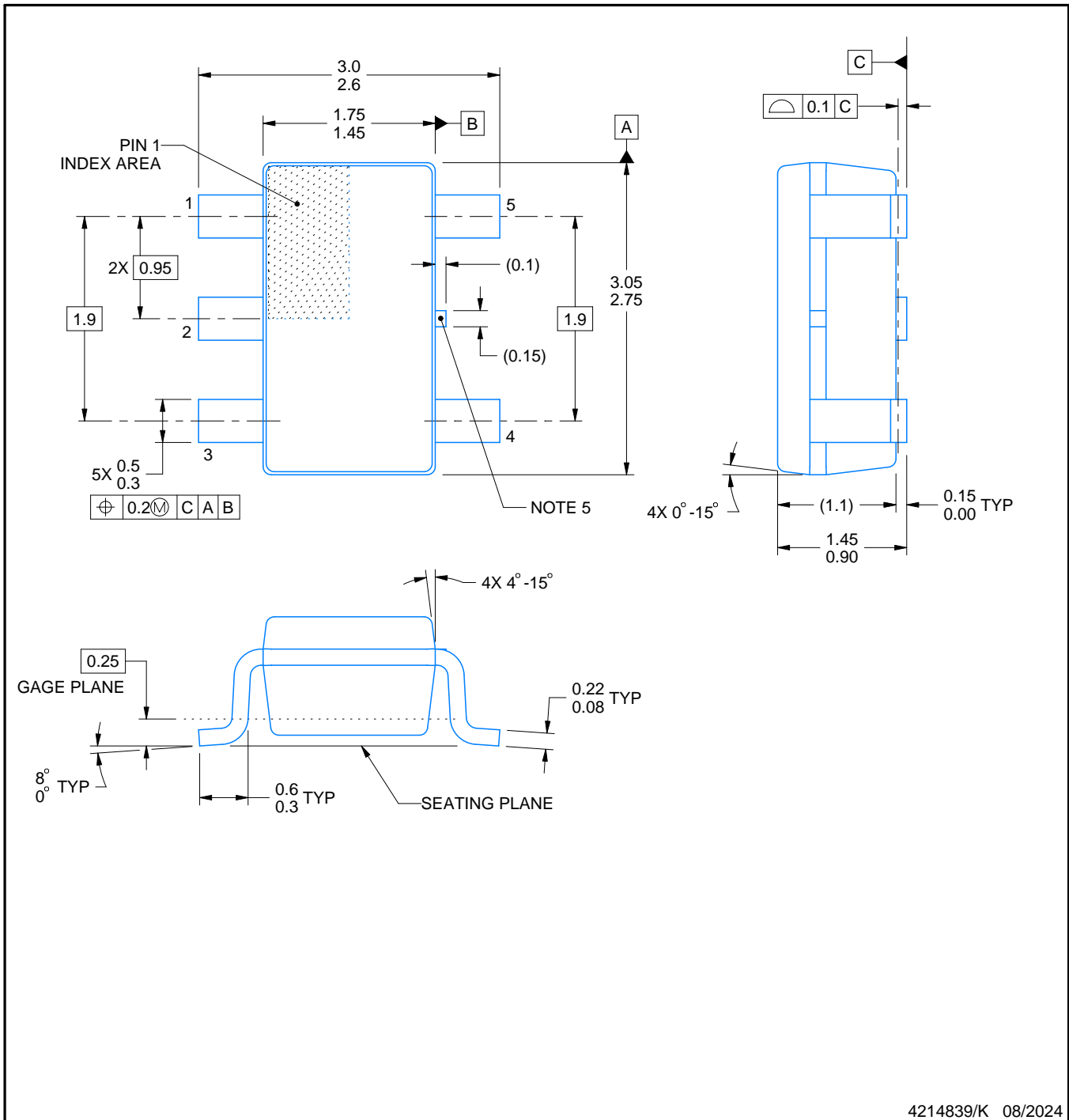

4214839/K 08/2024

NOTES:

1. All linear dimensions are in millimeters. Any dimensions in parenthesis are for reference only. Dimensioning and tolerancing per ASME Y14.5M.
2. This drawing is subject to change without notice.
3. Reference JEDEC MO-178.
4. Body dimensions do not include mold flash, protrusions, or gate burrs. Mold flash, protrusions, or gate burrs shall not exceed 0.25 mm per side.
5. Support pin may differ or may not be present.

EXAMPLE BOARD LAYOUT

DBV0005A

SOT-23 - 1.45 mm max height

SMALL OUTLINE TRANSISTOR



LAND PATTERN EXAMPLE
EXPOSED METAL SHOWN
SCALE:15X



SOLDER MASK DETAILS

4214839/K 08/2024

NOTES: (continued)

- 6. Publication IPC-7351 may have alternate designs.
- 7. Solder mask tolerances between and around signal pads can vary based on board fabrication site.

EXAMPLE STENCIL DESIGN

DBV0005A

SOT-23 - 1.45 mm max height

SMALL OUTLINE TRANSISTOR



SOLDER PASTE EXAMPLE
BASED ON 0.125 mm THICK STENCIL
SCALE:15X

4214839/K 08/2024

NOTES: (continued)

8. Laser cutting apertures with trapezoidal walls and rounded corners may offer better paste release. IPC-7525 may have alternate design recommendations.
9. Board assembly site may have different recommendations for stencil design.

DGK0008A



PACKAGE OUTLINE

VSSOP - 1.1 mm max height

SMALL OUTLINE PACKAGE

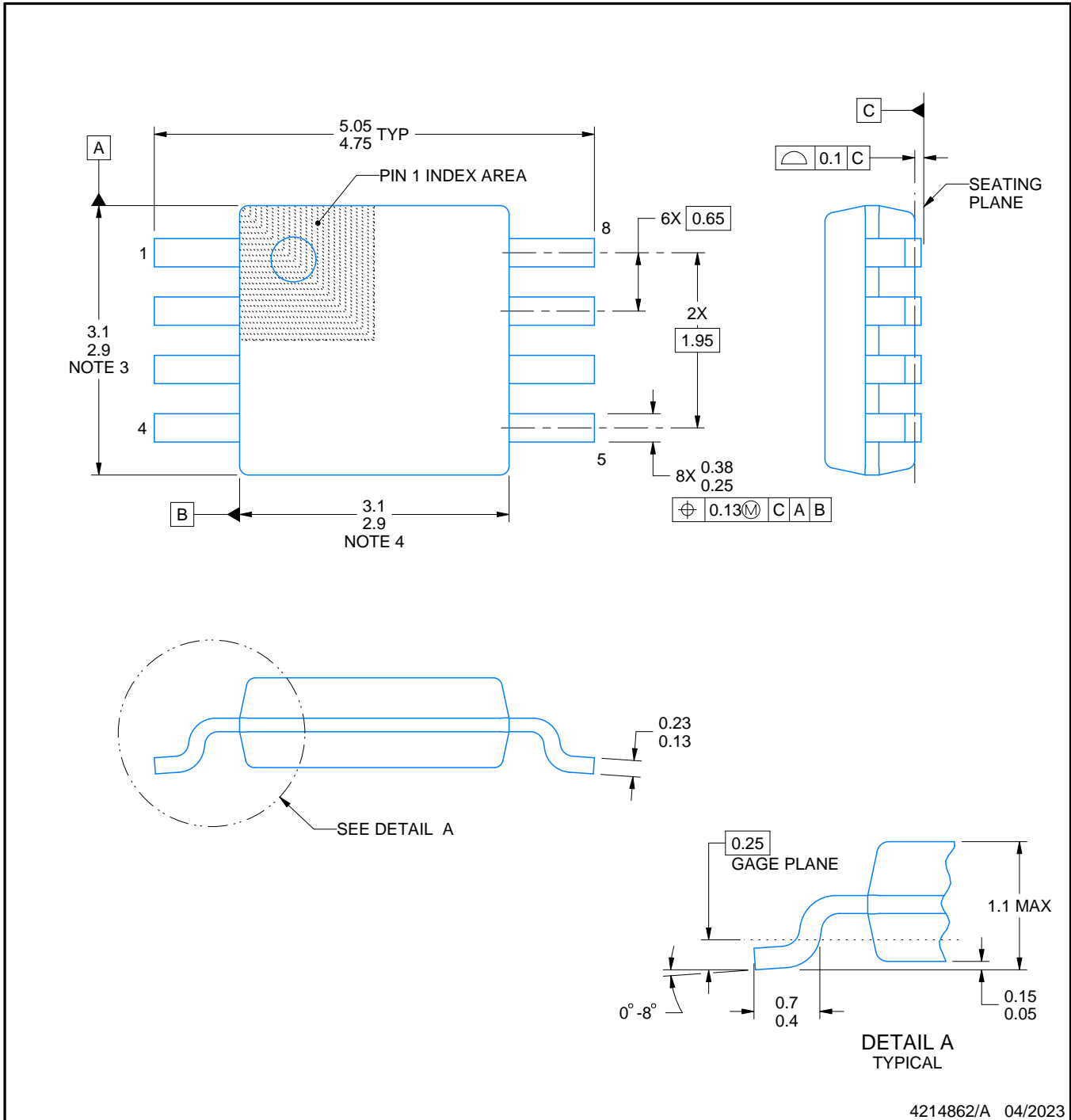

4214862/A 04/2023

NOTES:

PowerPAD is a trademark of Texas Instruments.

1. All linear dimensions are in millimeters. Any dimensions in parenthesis are for reference only. Dimensioning and tolerancing per ASME Y14.5M.
2. This drawing is subject to change without notice.
3. This dimension does not include mold flash, protrusions, or gate burrs. Mold flash, protrusions, or gate burrs shall not exceed 0.15 mm per side.
4. This dimension does not include interlead flash. Interlead flash shall not exceed 0.25 mm per side.
5. Reference JEDEC registration MO-187.

EXAMPLE BOARD LAYOUT

DGK0008A

™ VSSOP - 1.1 mm max height

SMALL OUTLINE PACKAGE



LAND PATTERN EXAMPLE
EXPOSED METAL SHOWN
SCALE: 15X

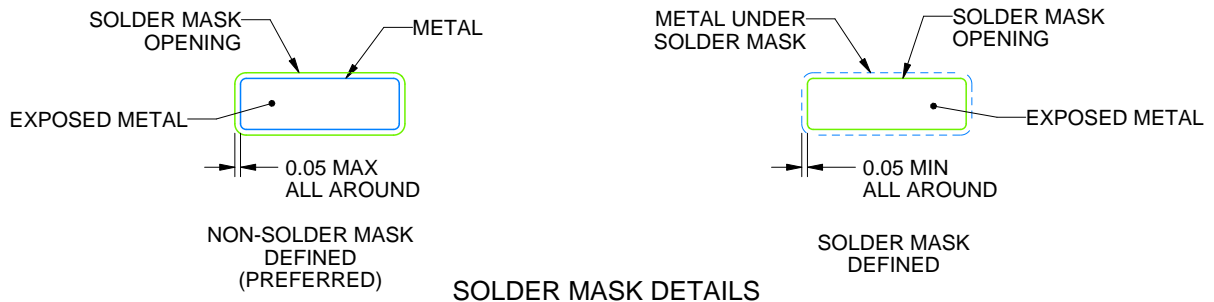

4214862/A 04/2023

NOTES: (continued)

6. Publication IPC-7351 may have alternate designs.
7. Solder mask tolerances between and around signal pads can vary based on board fabrication site.
8. Vias are optional depending on application, refer to device data sheet. If any vias are implemented, refer to their locations shown on this view. It is recommended that vias under paste be filled, plugged or tented.
9. Size of metal pad may vary due to creepage requirement.

EXAMPLE STENCIL DESIGN

DGK0008A

TM VSSOP - 1.1 mm max height

SMALL OUTLINE PACKAGE



SOLDER PASTE EXAMPLE
SCALE: 15X

4214862/A 04/2023

NOTES: (continued)

11. Laser cutting apertures with trapezoidal walls and rounded corners may offer better paste release. IPC-7525 may have alternate design recommendations.
12. Board assembly site may have different recommendations for stencil design.



D0008A

PACKAGE OUTLINE

SOIC - 1.75 mm max height

SMALL OUTLINE INTEGRATED CIRCUIT



4214825/C 02/2019

NOTES:

1. Linear dimensions are in inches [millimeters]. Dimensions in parenthesis are for reference only. Controlling dimensions are in inches. Dimensioning and tolerancing per ASME Y14.5M.
2. This drawing is subject to change without notice.
3. This dimension does not include mold flash, protrusions, or gate burrs. Mold flash, protrusions, or gate burrs shall not exceed .006 [0.15] per side.
4. This dimension does not include interlead flash.
5. Reference JEDEC registration MS-012, variation AA.

EXAMPLE BOARD LAYOUT

D0008A

SOIC - 1.75 mm max height

SMALL OUTLINE INTEGRATED CIRCUIT



LAND PATTERN EXAMPLE
EXPOSED METAL SHOWN
SCALE:8X



SOLDER MASK DETAILS

4214825/C 02/2019

NOTES: (continued)

6. Publication IPC-7351 may have alternate designs.

7. Solder mask tolerances between and around signal pads can vary based on board fabrication site.

EXAMPLE STENCIL DESIGN

D0008A

SOIC - 1.75 mm max height

SMALL OUTLINE INTEGRATED CIRCUIT



SOLDER PASTE EXAMPLE
BASED ON .005 INCH [0.125 MM] THICK STENCIL
SCALE:8X

4214825/C 02/2019

NOTES: (continued)

8. Laser cutting apertures with trapezoidal walls and rounded corners may offer better paste release. IPC-7525 may have alternate design recommendations.
9. Board assembly site may have different recommendations for stencil design.



DBV0006A

PACKAGE OUTLINE

SOT-23 - 1.45 mm max height

SMALL OUTLINE TRANSISTOR

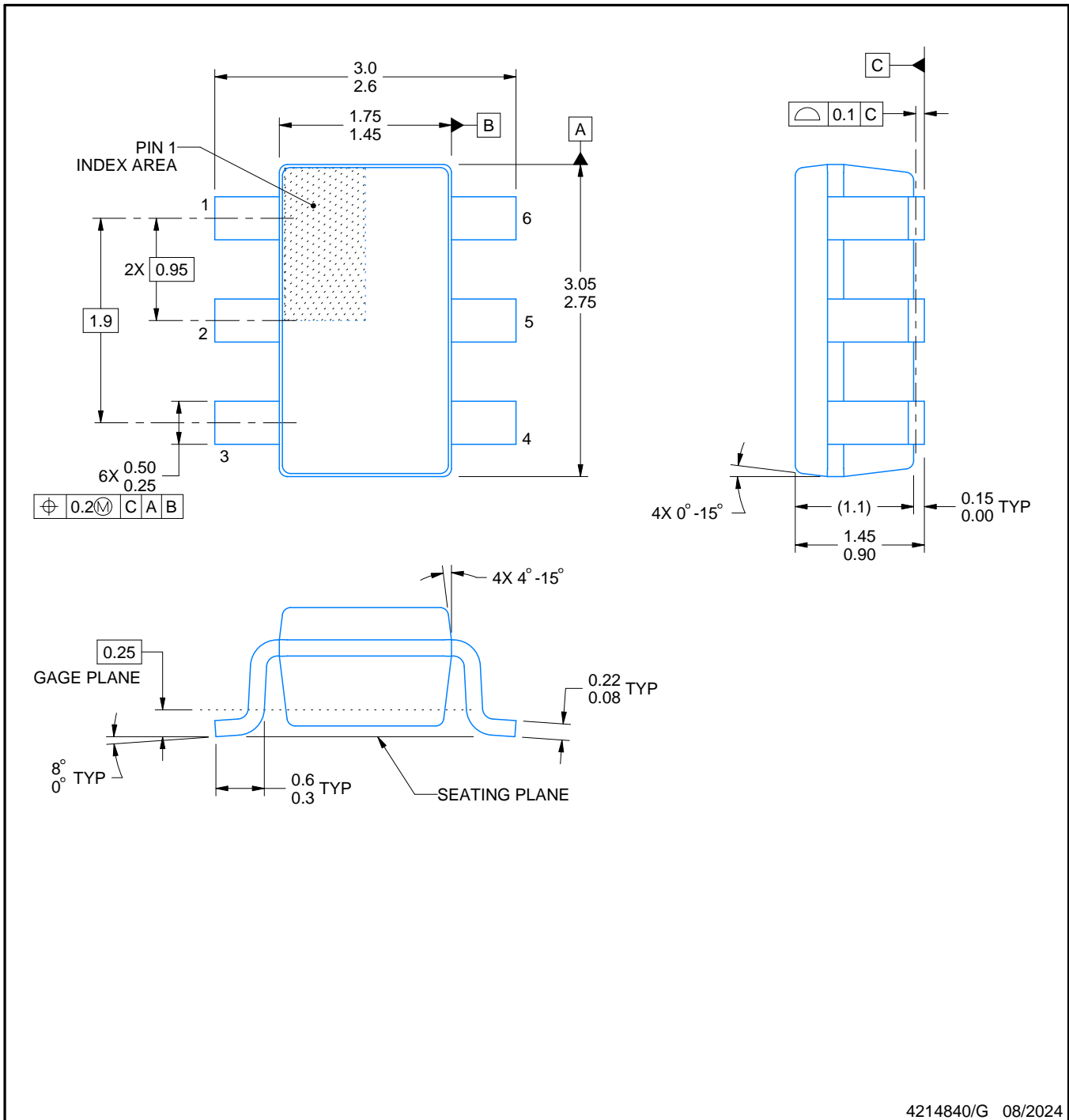

4214840/G 08/2024

NOTES:

1. All linear dimensions are in millimeters. Any dimensions in parenthesis are for reference only. Dimensioning and tolerancing per ASME Y14.5M.
2. This drawing is subject to change without notice.
3. Body dimensions do not include mold flash or protrusion. Mold flash and protrusion shall not exceed 0.25 per side.
4. Leads 1,2,3 may be wider than leads 4,5,6 for package orientation.
5. Reference JEDEC MO-178.

EXAMPLE BOARD LAYOUT

DBV0006A

SOT-23 - 1.45 mm max height

SMALL OUTLINE TRANSISTOR



LAND PATTERN EXAMPLE
EXPOSED METAL SHOWN
SCALE:15X



SOLDER MASK DETAILS

4214840/G 08/2024

NOTES: (continued)

6. Publication IPC-7351 may have alternate designs.

7. Solder mask tolerances between and around signal pads can vary based on board fabrication site.

EXAMPLE STENCIL DESIGN

DBV0006A

SOT-23 - 1.45 mm max height

SMALL OUTLINE TRANSISTOR



SOLDER PASTE EXAMPLE
BASED ON 0.125 mm THICK STENCIL
SCALE:15X

4214840/G 08/2024

NOTES: (continued)

8. Laser cutting apertures with trapezoidal walls and rounded corners may offer better paste release. IPC-7525 may have alternate design recommendations.
9. Board assembly site may have different recommendations for stencil design.

IMPORTANT NOTICE AND DISCLAIMER

TI PROVIDES TECHNICAL AND RELIABILITY DATA (INCLUDING DATASHEETS), DESIGN RESOURCES (INCLUDING REFERENCE DESIGNS), APPLICATION OR OTHER DESIGN ADVICE, WEB TOOLS, SAFETY INFORMATION, AND OTHER RESOURCES "AS IS" AND WITH ALL FAULTS, AND DISCLAIMS ALL WARRANTIES, EXPRESS AND IMPLIED, INCLUDING WITHOUT LIMITATION ANY IMPLIED WARRANTIES OF MERCHANTABILITY, FITNESS FOR A PARTICULAR PURPOSE OR NON-INFRINGEMENT OF THIRD PARTY INTELLECTUAL PROPERTY RIGHTS.

These resources are intended for skilled developers designing with TI products. You are solely responsible for (1) selecting the appropriate TI products for your application, (2) designing, validating and testing your application, and (3) ensuring your application meets applicable standards, and any other safety, security, regulatory or other requirements.

These resources are subject to change without notice. TI grants you permission to use these resources only for development of an application that uses the TI products described in the resource. Other reproduction and display of these resources is prohibited. No license is granted to any other TI intellectual property right or to any third party intellectual property right. TI disclaims responsibility for, and you fully indemnify TI and its representatives against any claims, damages, costs, losses, and liabilities arising out of your use of these resources.

TI's products are provided subject to [TI's Terms of Sale](#), [TI's General Quality Guidelines](#), or other applicable terms available either on ti.com or provided in conjunction with such TI products. TI's provision of these resources does not expand or otherwise alter TI's applicable warranties or warranty disclaimers for TI products. Unless TI explicitly designates a product as custom or customer-specified, TI products are standard, catalog, general purpose devices.

TI objects to and rejects any additional or different terms you may propose.

Copyright © 2026, Texas Instruments Incorporated

Last updated 10/2025