

## 2.3V 至 20V, 750mA 低压降电压稳压器

查询样片: [TPS7A4501-SP](#)

### 特性

- 符合 QMLV, SMD 5962-12224
- 针对快速瞬态响应进行了优化
- 输出电流: **750mA**
- 高输出电压精度: 在 25°C 时为 **1%** (典型值)
- 压降电压: **300mV**
- 低噪声:  $V_{out} = 5V$  时为 **50 $\mu$ V<sub>RMS</sub>** (10Hz 至 **100kHz**)
- 高纹波抑制: **1kHz** 时为 **68dB**
- **1mA** 静态电流
- 无需保护二极管
- 压降中的受控静态电流
- **2.3V 到 20V** 的宽输入电压 ( $V_{in}$ )
- **1.21V 至 20V** 的可调节输出范围
- 关断时静态电流小于 **1 $\mu$ A**
- 与陶瓷输出电容器一起工作时保持稳定
- 反向电池保护
- 反向电流保护

### 应用范围

- **TPS7A4501-SP**: 抗辐射应用
- 射频 (RF) 组件压控稳压器 (VCO), 接收器, 模数转换器 (ADC), 放大器
- 时钟分配
- 洁净模拟电源需求
- **TPS7A4501-SP** 在军用温度范围 (**-55°C 至 125°C**) 内可用
- 可提供工程评估 (IEM) 样品 <sup>(1)</sup>

(1) 这些部件只用于工程评估。它们的加工工艺为非兼容流程 (例如, 无预烧过程等) 并且只在 25°C 的温度额定值下测试。这些部件不适合于品质检定、生产、辐射测试或飞行使用。不担保在整个军用额定温度范围 (-55°C 至 125°C) 内或使用寿命内的器件性能。

### 说明

TPS7A4501 是一款针对快速瞬态响应而进行优化的低压降 (LDO) 稳压器。此器件在压降为 300mV 时可提供 750mA 的输出电流。运行静态电流为 1mA, 在关断时下降到少于 1 $\mu$ A。静态电流受到很好的控制; 与很多其他稳压器一同工作时一样, 它在压降时不上升。除了快速瞬态响应, TPS7A4501 稳压器具有极低的输出噪声, 这使得它非常适合于灵敏 RF 电源应用。

输出电压范围为 1.21V 至 20V。TPS7A4501 在使用低至 10 $\mu$ F 的输出电容器时保持稳定。与其它稳压器一同使用时的常见情况一样, 在无需额外等效串联电阻 (ESR) 的前提下可使用小型陶瓷电容器。内部保护电路包括反向电池保护、电流限制、热限制和反向电流保护。此器件可被用作一个基准电压为 1.21V 的可调器件。TPS7A4501 稳压器采用 10 引脚 GDFP (U) 封装。



Please be aware that an important notice concerning availability, standard warranty, and use in critical applications of Texas Instruments semiconductor products and disclaimers thereto appears at the end of this data sheet.



This integrated circuit can be damaged by ESD. Texas Instruments recommends that all integrated circuits be handled with appropriate precautions. Failure to observe proper handling and installation procedures can cause damage.

ESD damage can range from subtle performance degradation to complete device failure. Precision integrated circuits may be more susceptible to damage because very small parametric changes could cause the device not to meet its published specifications.

**BARE DIE INFORMATION**

DIE THICKNESS	BACKSIDE FINISH	BACKSIDE POTENTIAL	BOND PAD METALLIZATION COMPOSITION	BOND PAD THICKNESS
15 mils.	Silicon with backgrind	Floating	TiW/AlCu2	1627 nm

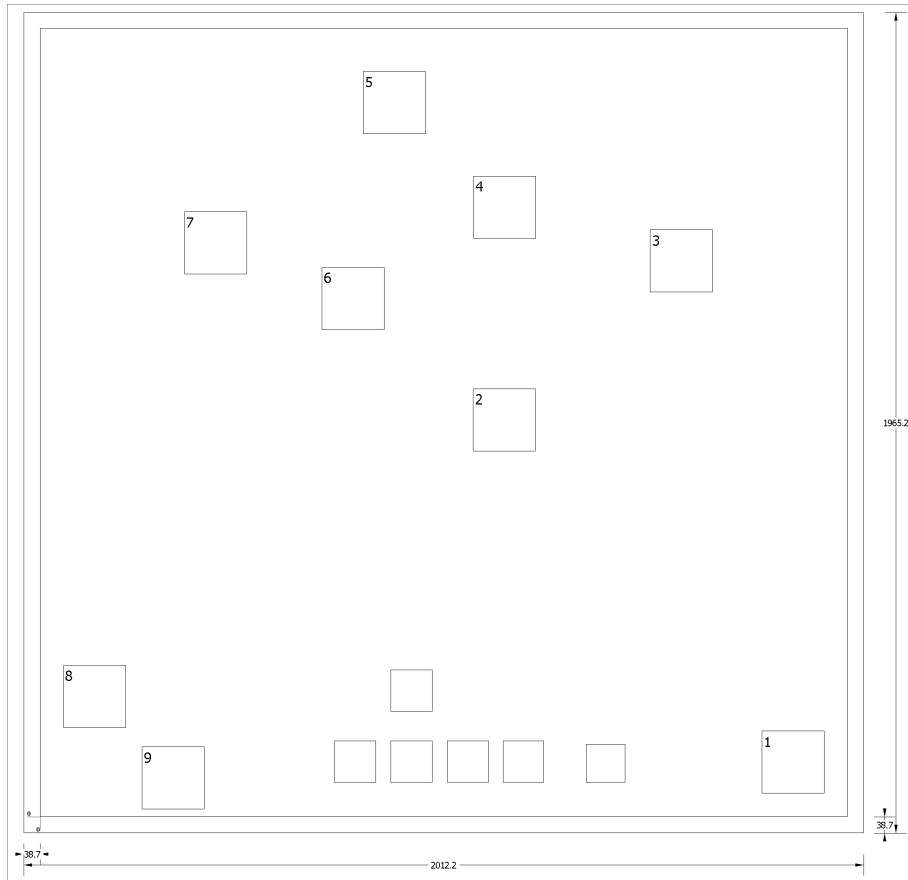

**Table 1. Bond Pad Coordinates in Microns<sup>(1)</sup>**

DESCRIPTION	PAD NUMBER	X MIN	Y MIN	X MAX	Y MAX
SHDN	1	1729.25	55.5	1879.25	205.5
IN	2	1037.25	875	1187.25	1025
IN	3	1460.75	1255.5	1610.75	1405.5
IN	4	1037.75	1384.5	1187.75	1534.5
OUT	5	774.25	1634.75	924.25	1784.75
OUT	6	675.25	1166	825.25	1316
OUT	7	345.5	1299.25	495.5	1449.25
SENSE/ADJ	8	55.5	213	205.5	363
GND	9	244	17.5	394	167.5

(1) Substrate is not to be connected.

## ABSOLUTE MAXIMUM RATINGS<sup>(1)</sup>

over operating junction temperature range (unless otherwise noted)

Input voltage range, $V_{IN}$	IN	-22 V to 22 V
	OUT	-22 V to 22 V
	Input-to-output differential <sup>(2)</sup>	-22 V to 22 V
	ADJ	-7 V to 7 V
	$\overline{SHDN}$	-22 V to 22 V
Maximum lead temperature (10-s soldering time), $T_{lead}$		260°C
Maximum operating junction temperature, $T_J$		150°C
Storage temperature range, $T_{stg}$		-65°C to 150°C

- Stresses beyond those listed under *Absolute Maximum Ratings* may cause permanent damage to the device. These are stress ratings only, and functional operation of the device at these or any other conditions beyond those indicated under *Recommended Operating Conditions* is not implied. Exposure to absolute-maximum-rated conditions for extended periods may affect device reliability.
- Absolute maximum input-to-output differential voltage cannot be achieved with all combinations of rated IN pin and OUT pin voltages. With the IN pin at 22 V, the OUT pin may not be pulled below 0 V. The total measured voltage from IN to OUT can not exceed  $\pm 22$  V.

## RECOMMENDED OPERATING CONDITIONS

over operating junction temperature range (unless otherwise noted)

		MIN	NOM	MAX	UNIT
$T_J$	Operating junction temperature	-55		125	°C

## THERMAL INFORMATION

THERMAL METRIC		TPS7A4501-SP	UNITS
		U	
		10 PINS	
$\theta_{JA}$	Junction-to-ambient thermal resistance <sup>(1)</sup>	86.6	°C/W
$\theta_{JCbott}$	Junction-to-case (bottom) thermal resistance <sup>(2)</sup>	10.3	°C/W
$\theta_{JB}$	Junction-to-board thermal resistance <sup>(3)</sup>	35.6	°C/W
$\psi_{JT}$	Junction-to-top characterization parameter <sup>(4)</sup>	31.7	°C/W
$\psi_{JB}$	Junction-to-board characterization parameter <sup>(5)</sup>	53.5	°C/W

- The junction-to-ambient thermal resistance under natural convection is obtained in a simulation on a JEDEC-standard, high-K board, as specified in JESD51-7, in an environment described in JESD51-2a.
- The junction-to-case (bottom) thermal resistance is obtained by simulating a cold plate test on the exposed (power) pad. No specific JEDEC standard test exists, but a close description can be found in the ANSI SEMI standard G30-88.
- The junction-to-board thermal resistance is obtained by simulating in an environment with a ring cold plate fixture to control the PCB temperature, as described in JESD51-8.
- The junction-to-top characterization parameter,  $\psi_{JT}$ , estimates the junction temperature of a device in a real system and is extracted from the simulation data for obtaining  $\theta_{JA}$ , using a procedure described in JESD51-2a (sections 6 and 7).
- The junction-to-board characterization parameter,  $\psi_{JB}$ , estimates the junction temperature of a device in a real system and is extracted from the simulation data for obtaining  $\theta_{JA}$ , using a procedure described in JESD51-2a (sections 6 and 7).

## ELECTRICAL CHARACTERISTICS

Over operating junction temperature range  $T_J = -55^\circ\text{C}$  to  $125^\circ\text{C}$  (unless otherwise noted)

PARAMETER		TEST CONDITIONS	$T_J$	MIN	TYP <sup>(1)</sup>	MAX	UNIT
$V_{IN}$	Minimum input voltage <sup>(2) (3)</sup>	$I_{LOAD} = 500\text{ mA}$	$25^\circ\text{C}$		1.9	2.3	V
		$I_{LOAD} = 750\text{ mA}$	Full range		2.1	2.5	
$V_{ADJ}$	ADJ pin voltage <sup>(2) (4)</sup>	$V_{IN} = 2.21\text{ V}, I_{LOAD} = 1\text{ mA}$	$25^\circ\text{C}$	1.196	1.21	1.224	V
		$V_{IN} = 2.5\text{ V to }20\text{ V}, I_{LOAD} = 1\text{ mA to }750\text{ mA}$	Full range	1.174	1.21	1.246	
	Line regulation <sup>(2)</sup>	$\Delta V_{IN} = 2.21\text{ V to }20\text{ V}, I_{LOAD} = 1\text{ mA}$	Full range		1.5	4.5	mV
	Load regulation <sup>(2)</sup>	$V_{IN} = 2.5\text{ V}, \Delta I_{LOAD} = 1\text{ mA to }750\text{ mA}$	$25^\circ\text{C}$		2	8	mV
			Full range				
$V_{DO}$	Dropout voltage <sup>(5) (6)</sup> $V_{OUT} = 2.4\text{ V}$	$I_{LOAD} = 1\text{ mA}$	$25^\circ\text{C}$		0.02	0.05	V
			Full range				
		$I_{LOAD} = 100\text{ mA}$	$25^\circ\text{C}$		0.085	0.10	
			Full range				
		$I_{LOAD} = 500\text{ mA}$	$25^\circ\text{C}$		0.17	0.21	
			Full range				
$I_{LOAD} = 750\text{ mA}$	$25^\circ\text{C}$		0.20	0.27			
	Full range				0.33		
$I_{GND}$	GND pin current <sup>(6) (7)</sup> $V_{IN} = 2.5\text{ V}$	$I_{LOAD} = 0\text{ mA}$	Full range		1	1.5	mA
		$I_{LOAD} = 1\text{ mA}$	Full range		1.1	1.6	
		$I_{LOAD} = 100\text{ mA}$	Full range		3.3	7	
		$I_{LOAD} = 500\text{ mA}$	Full range		15	30	
		$I_{LOAD} = 750\text{ mA}$	Full range		28	45	
$\epsilon_N$	Output voltage noise	$C_{OUT} = 22\text{ }\mu\text{F}, I_{LOAD} = 750\text{ mA}, V_{IN} = 7\text{ V}, V_{OUT} = 5\text{ V}$ $B_W = 10\text{ Hz to }100\text{ kHz}$	$25^\circ\text{C}$		50		$\mu\text{V}_{RMS}$
$I_{ADJ}$	ADJ pin bias current <sup>(2) (8)</sup>		$25^\circ\text{C}$		3	7	$\mu\text{A}$
	Shutdown threshold	$V_{OUT} = \text{OFF to ON}$	Full range		0.9	2	V
		$V_{OUT} = \text{ON to OFF}$	Full range	0.15	0.75		
$I_{\overline{\text{SHDN}}}$	$\overline{\text{SHDN}}$ pin current	$V_{\overline{\text{SHDN}}} = 0\text{ V}$	$25^\circ\text{C}$		0.01	1	$\mu\text{A}$
		$V_{\overline{\text{SHDN}}} = 20\text{ V}$	$25^\circ\text{C}$		3	20	
	Quiescent current in shutdown	$V_{IN} = 6\text{ V}, V_{\overline{\text{SHDN}}} = 0\text{ V}$	$25^\circ\text{C}$		0.01	1	$\mu\text{A}$
	Ripple rejection <sup>(9)</sup>	$V_{IN} - V_{OUT} = 1.5\text{ V (avg)}, V_{RIPPLE} = 0.5\text{ V}_{P-P}, f_{RIPPLE} = 120\text{ Hz}, I_{LOAD} = 0.75\text{ A}$	$25^\circ\text{C}$	60	68		dB
$I_{LIMIT}$	Current limit <sup>(9)</sup>	$V_{IN} = 7\text{ V}, V_{OUT} = 0\text{ V}$	$25^\circ\text{C}$		1.7	1.9	A
		$V_{IN} = 2.5\text{ V}$	Full range		1.6	1.9	
$I_{IL}$	Input reverse leakage current	$V_{IN} = -20\text{ V}, V_{OUT} = 0\text{ V}$	Full range			300	$\mu\text{A}$
$I_{RO}$	Reverse output current <sup>(10)</sup>	$V_{OUT} = 1.21\text{ V}, V_{IN} < 1.21\text{ V}$	$25^\circ\text{C}$		300	500	$\mu\text{A}$

- (1) Typical values represent the likely parametric nominal values determined at the time of characterization. Typical values depend on the application and configuration and may vary over time. Typical values are not ensured on production material.
- (2) The TPS7A4501 is tested and specified for these conditions with the ADJ pin connected to the OUT pin.
- (3) Dropout voltages are limited by the minimum input voltage specification under some output voltage/load conditions.
- (4) Operating conditions are limited by maximum junction temperature. The regulated output voltage specification does not apply for all possible combinations of input voltage and output current. When operating at maximum input voltage, the output current range must be limited. When operating at maximum output current, the input voltage range must be limited.
- (5) Dropout voltage is the minimum input to output voltage differential needed to maintain regulation at a specified output current. In dropout, the output voltage is equal to:  $V_{IN} - V_{DROPOUT}$ .
- (6) To satisfy requirements for minimum input voltage, the TPS7A4501 is tested and specified for these conditions with an external resistor divider (two 4.12-k $\Omega$  resistors) for an output voltage of 2.4 V. The external resistor divider adds a 300- $\mu\text{A}$  DC load on the output.
- (7) GND pin current is tested with  $V_{IN} = 2.5\text{ V}$  and a current source load. The GND pin current decreases at higher input voltages.
- (8) ADJ pin bias current flows into the ADJ pin.
- (9) Specification is guaranteed by characterization for KGD and is not tested in production.
- (10) Reverse output current is tested with the IN pin grounded and the OUT pin forced to the rated output voltage. This current flows into the OUT pin and out the GND pin.

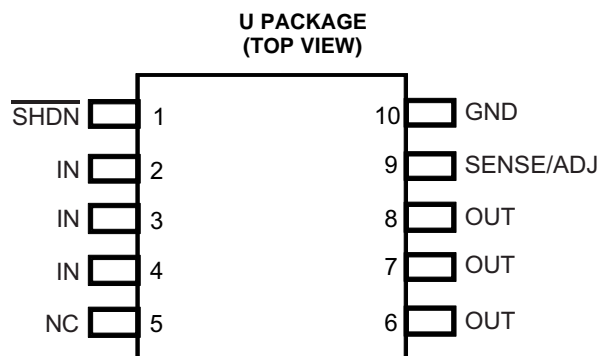
**DEVICE INFORMATION**

**TERMINAL FUNCTIONS**

PIN		DESCRIPTION
NO.	NAME	
1	$\overline{\text{SHDN}}$	Shutdown. $\overline{\text{SHDN}}$ is used to put the TPS7A4501 regulator into a low-power shutdown state. The output is off when $\overline{\text{SHDN}}$ is pulled low. $\overline{\text{SHDN}}$ can be driven by 5-V logic, 3-V logic or open-collector logic with a pullup resistor. The pullup resistor is required to supply the pullup current of the open-collector gate, normally several microamperes, and $\overline{\text{SHDN}}$ current, typically 3 $\mu\text{A}$ . If unused, $\overline{\text{SHDN}}$ must be connected to $V_{\text{IN}}$ . The device is in the low-power shutdown state if $\overline{\text{SHDN}}$ is not connected.
2, 3, 4	IN	Input. Power is supplied to the device through IN. A bypass capacitor is required on this pin if the device is more than six inches away from the main input filter capacitor. In general, the output impedance of a battery rises with frequency, so it is advisable to include a bypass capacitor in battery-powered circuits. A bypass capacitor (ceramic) in the range of 1 $\mu\text{F}$ to 10 $\mu\text{F}$ is sufficient. The TPS7A4501 regulator is designed to withstand reverse voltages on IN with respect to ground and on OUT. In the case of a reverse input, which can happen if a battery is plugged in backwards, the device acts as if there is a diode in series with its input. There is no reverse current flow into the regulator, and no reverse voltage appears at the load. The device protects both itself and the load.
5	NC	This pin is not connected to any internal circuitry. It can be left floating or tied to $V_{\text{IN}}$ or GND.
6, 7, 8	OUT	Output. The output supplies power to the load. A minimum output capacitor (ceramic) of 10 $\mu\text{F}$ is required to prevent oscillations. Larger output capacitors are required for applications with large transient loads to limit peak voltage transients.
9	ADJ	Adjust. This is the input to the error amplifier. ADJ is internally clamped to $\pm 7\text{ V}$ . It has a bias current of 3 $\mu\text{A}$ that flows into the pin. ADJ voltage is 1.21 V referenced to ground, and the output voltage range is 1.21 V to 20 V.
10	GND	Ground.

TYPICAL CHARACTERISTICS

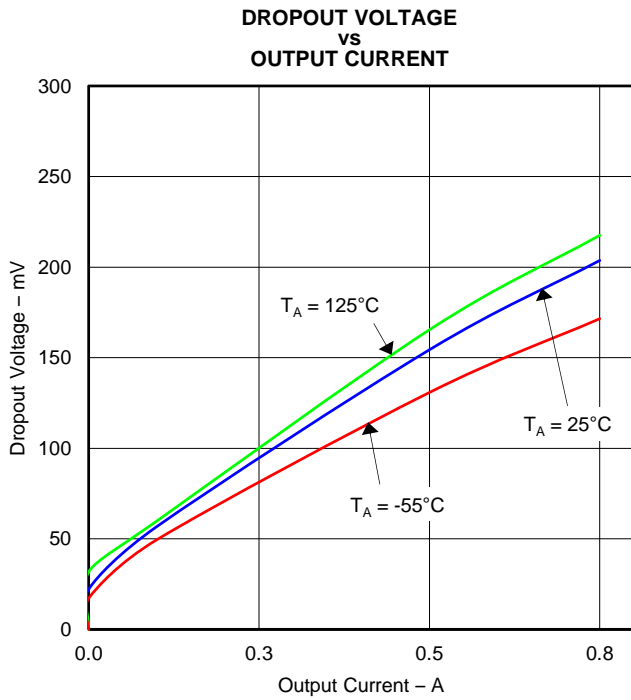

Figure 1.

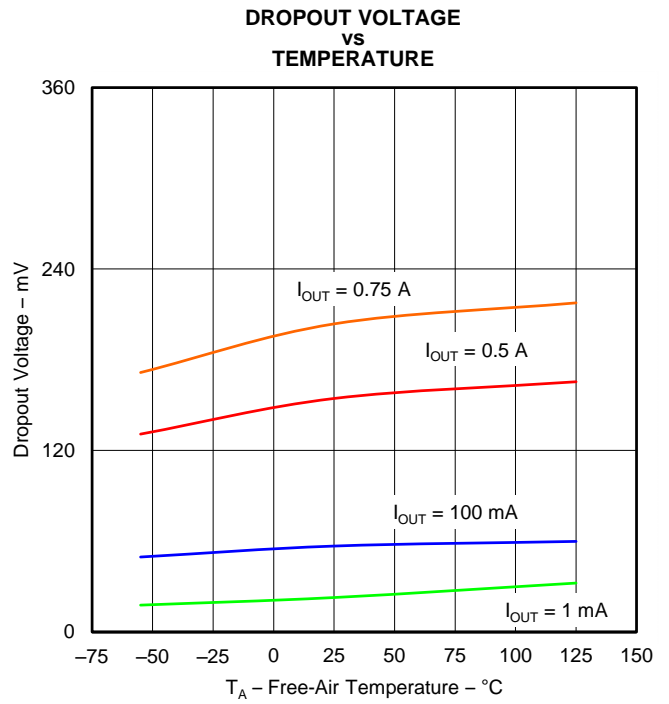

Figure 2.

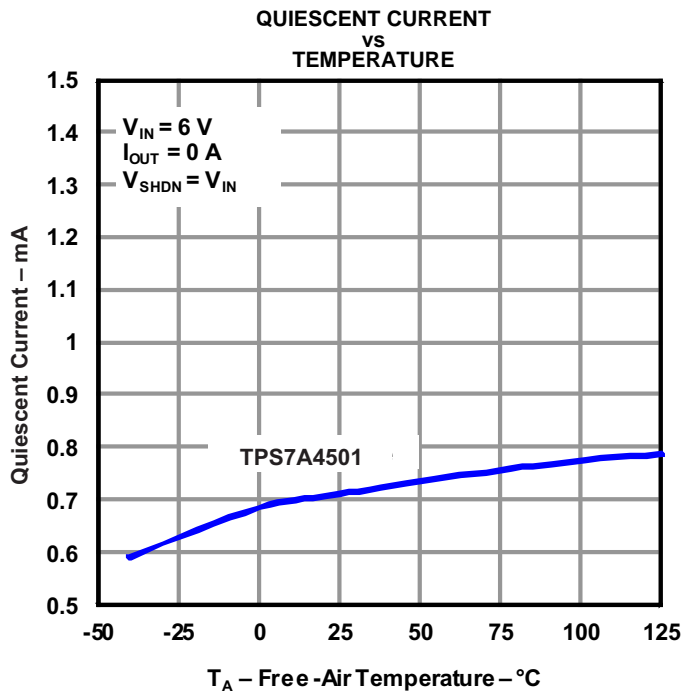

Figure 3.

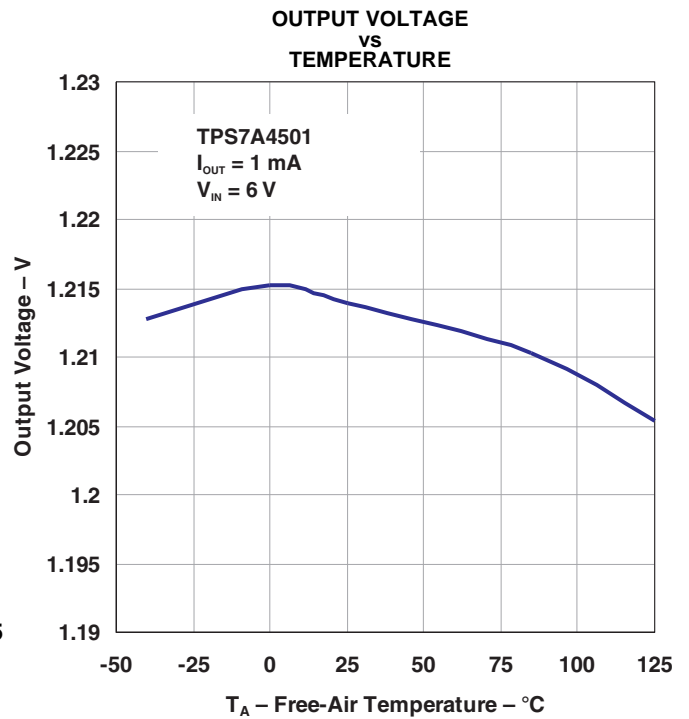

Figure 4.

TYPICAL CHARACTERISTICS (continued)

QUIESCENT CURRENT  
VS  
INPUT VOLTAGE

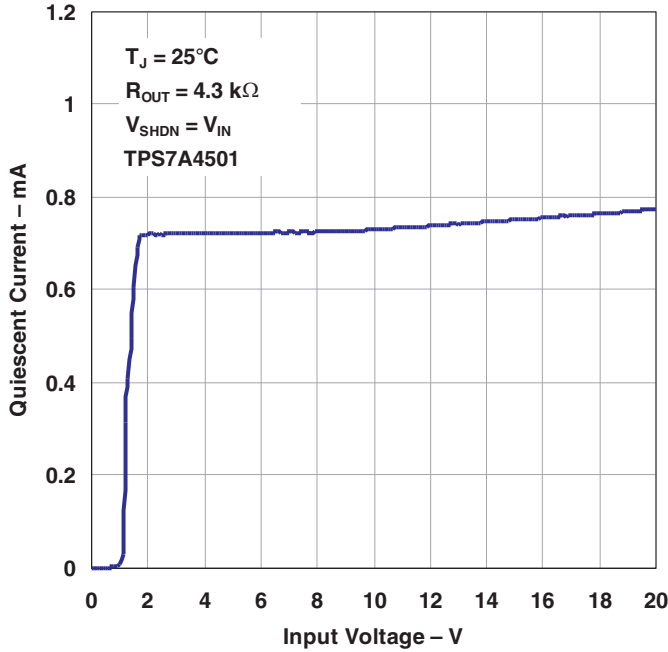

Figure 5.

GROUND CURRENT  
VS  
INPUT VOLTAGE

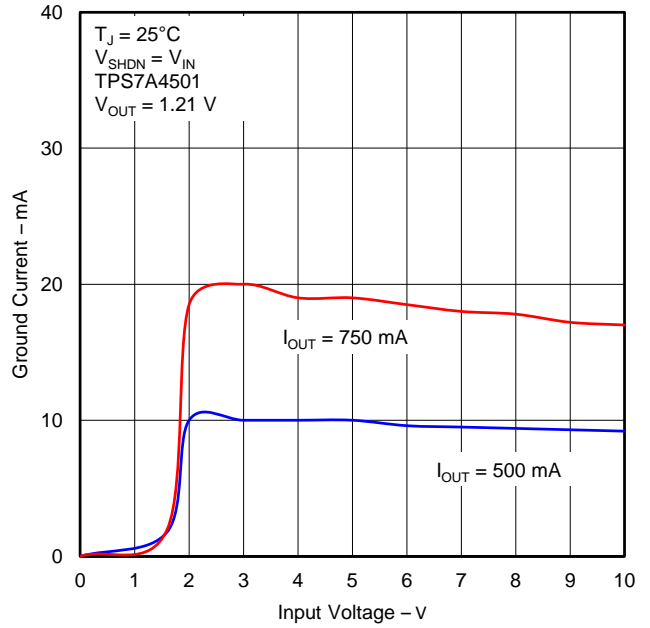

Figure 6.

GROUND CURRENT  
VS  
INPUT VOLTAGE

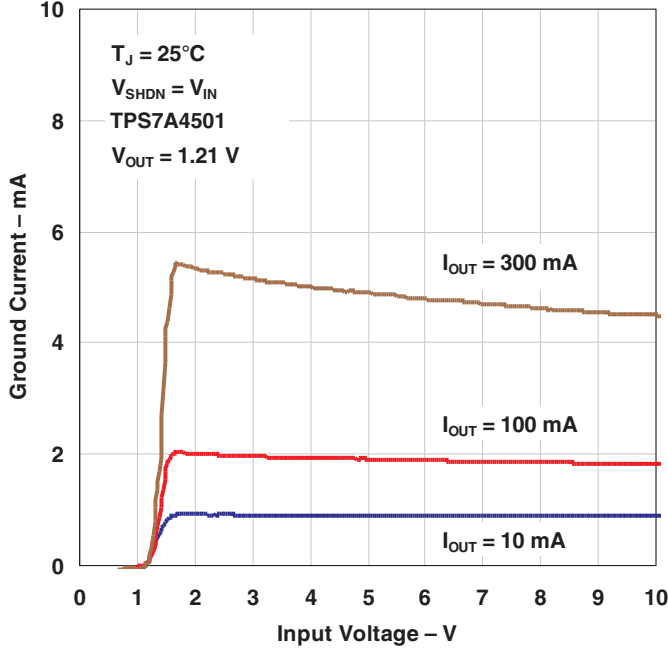

Figure 7.

GROUND CURRENT  
VS  
OUTPUT CURRENT

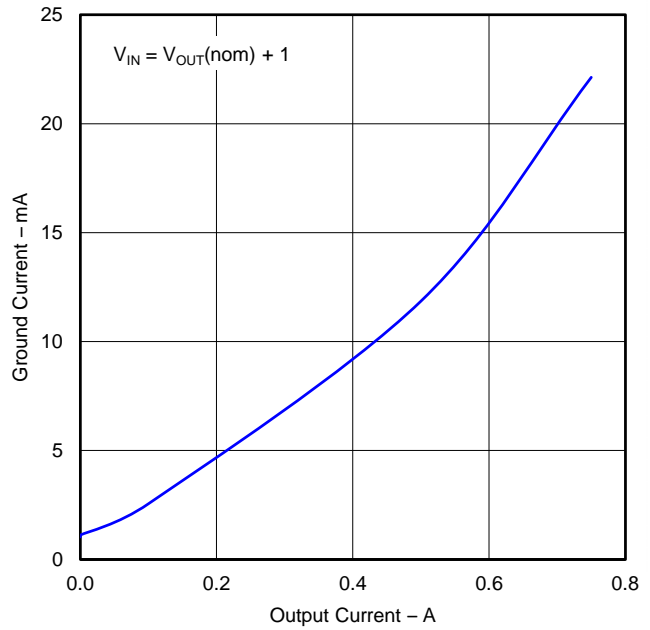

Figure 8.

**TYPICAL CHARACTERISTICS (continued)**

**SHDN INPUT CURRENT  
VS  
TEMPERATURE**

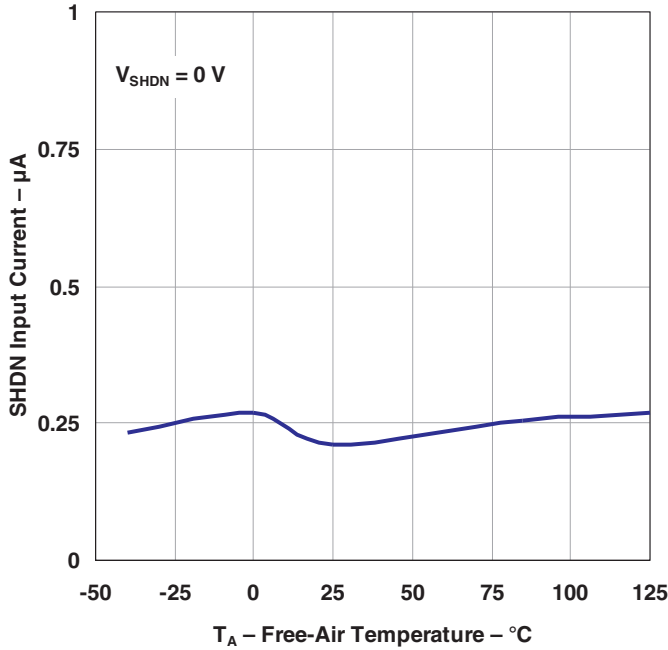

Figure 9.

**SHDN INPUT CURRENT  
VS  
SHDN INPUT VOLTAGE**

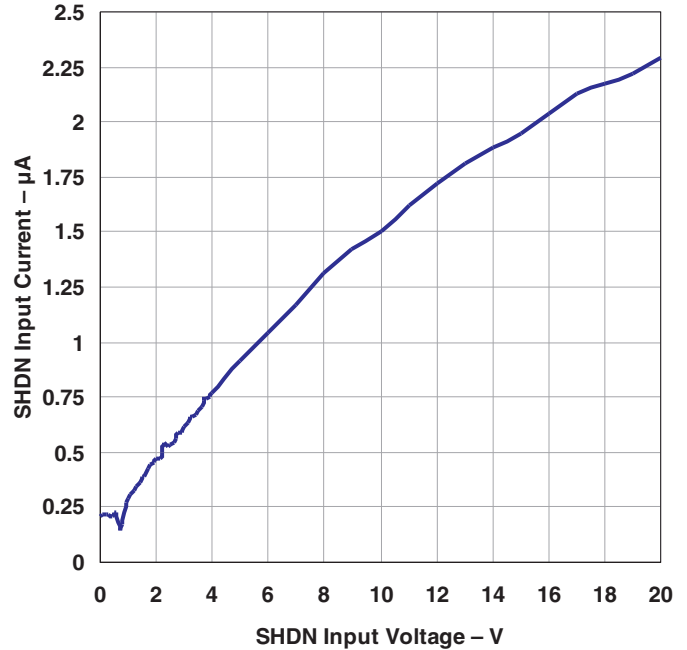

Figure 10.

**SHDN THRESHOLD (OFF TO ON)  
VS  
TEMPERATURE**

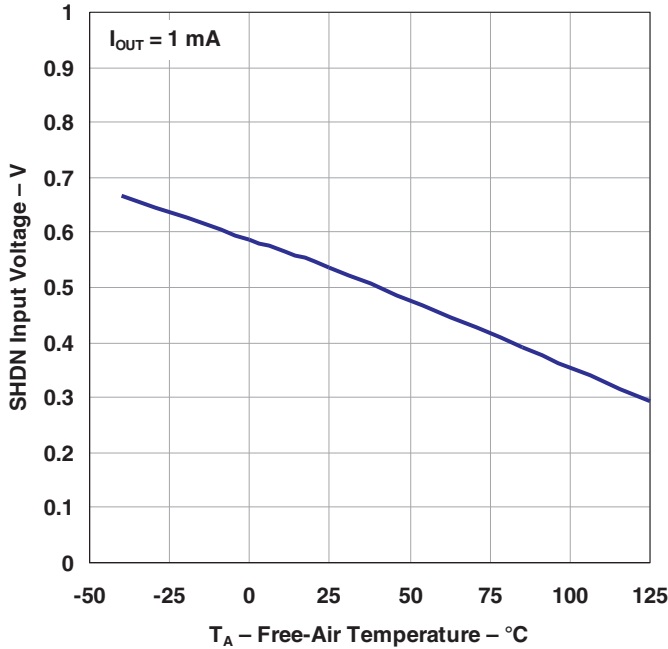

Figure 11.

**SHDN THRESHOLD (ON TO OFF)  
VS  
TEMPERATURE**

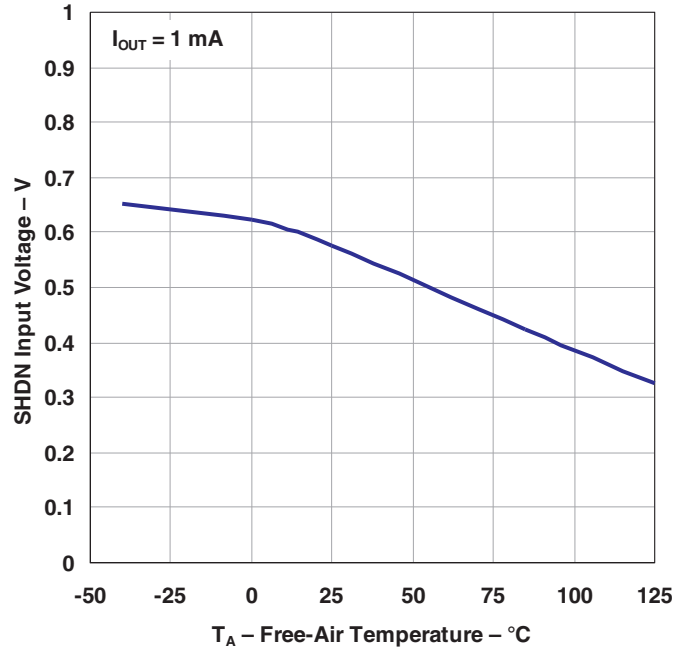

Figure 12.



TYPICAL CHARACTERISTICS (continued)

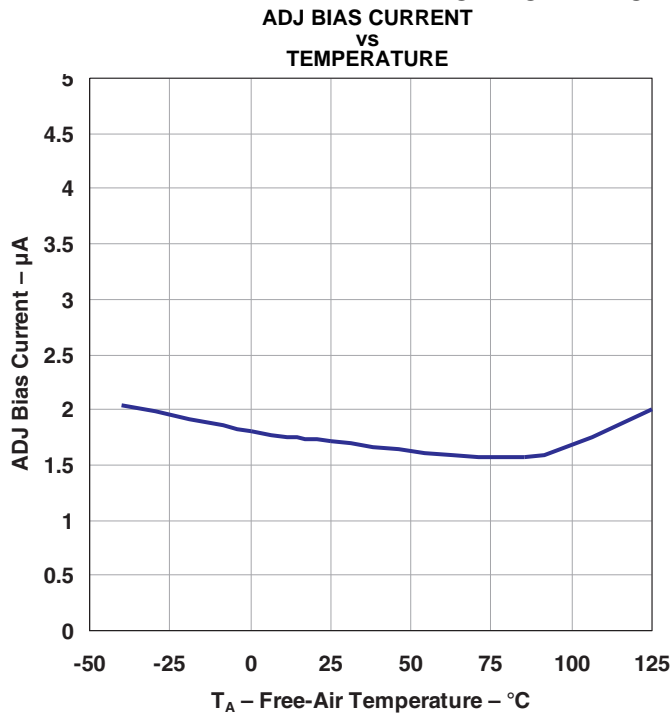

Figure 13.

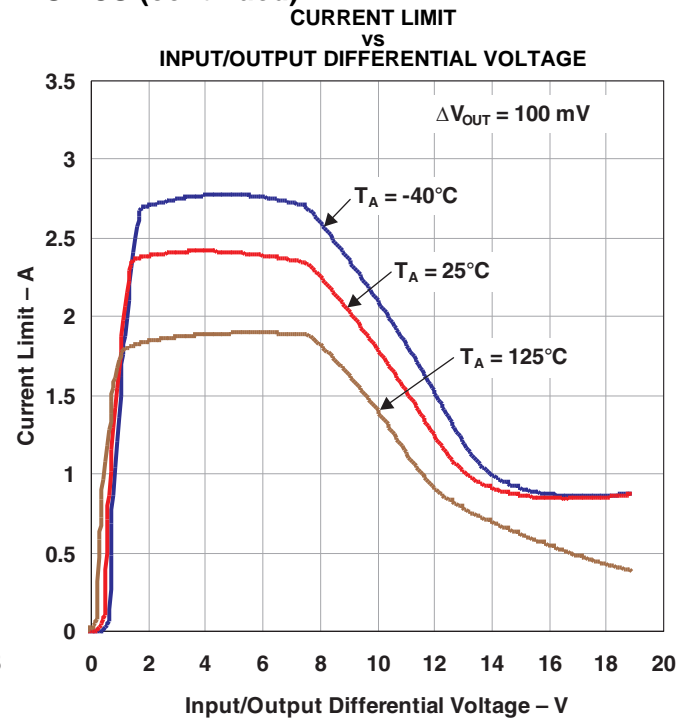

Figure 14.

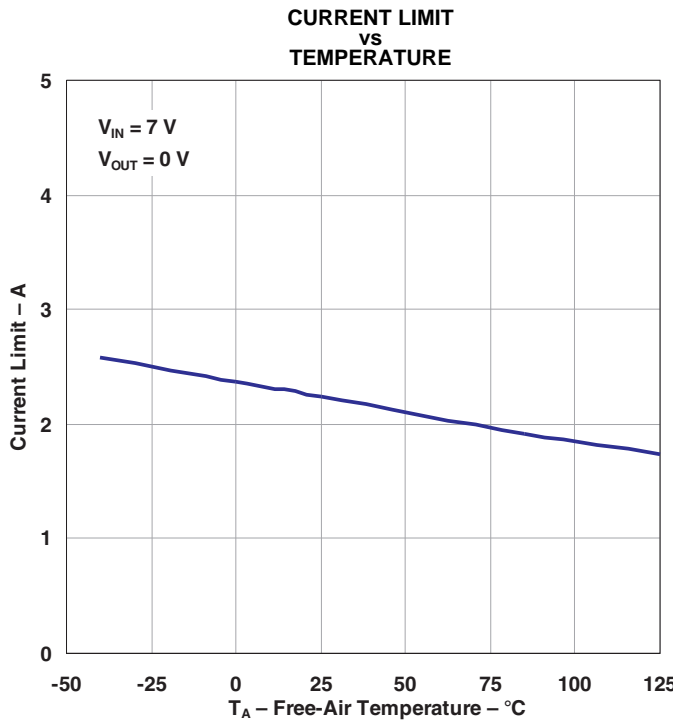

Figure 15.

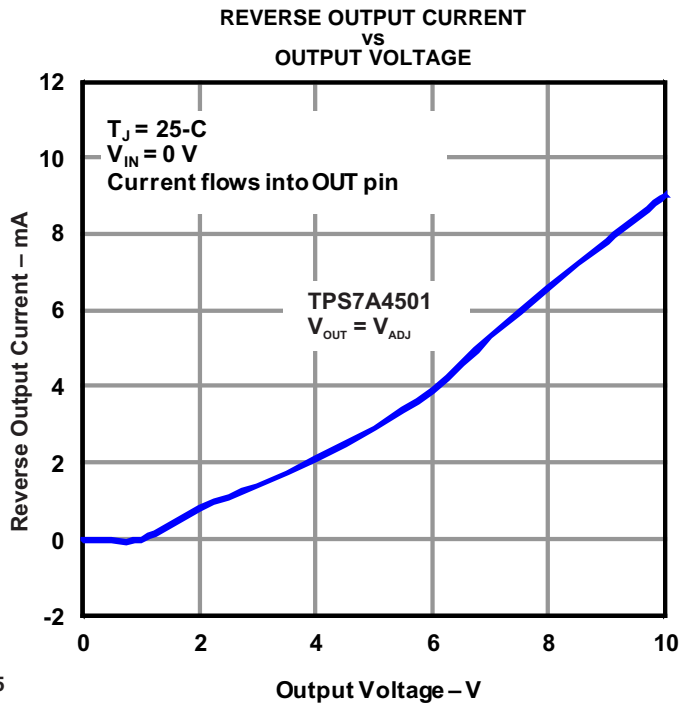

Figure 16.

**TYPICAL CHARACTERISTICS (continued)**

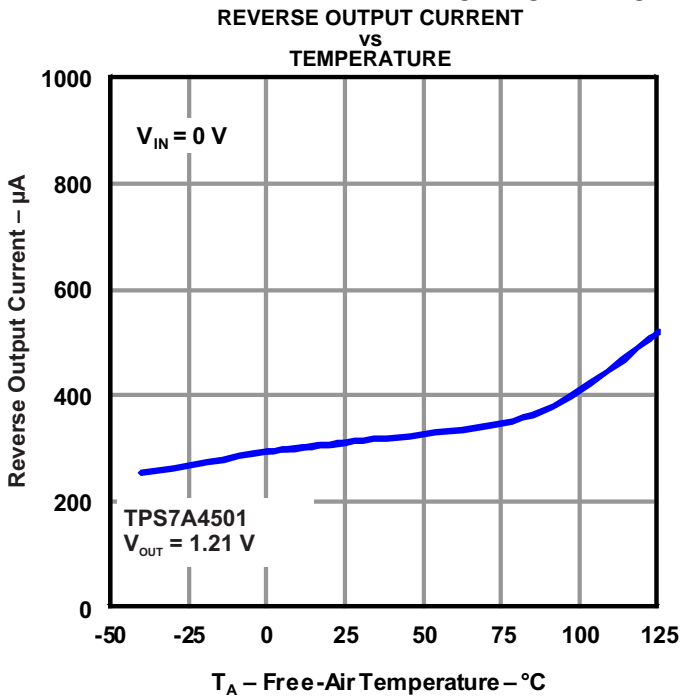

Figure 17.

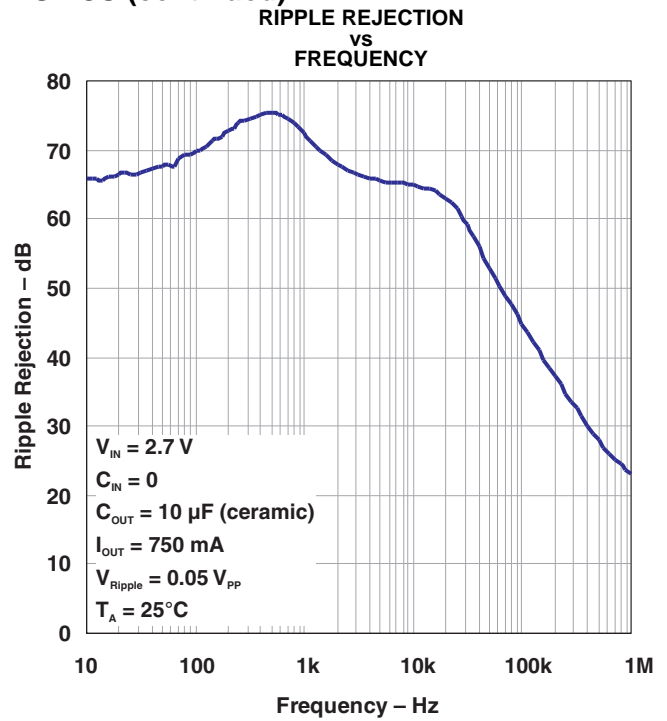

Figure 18.

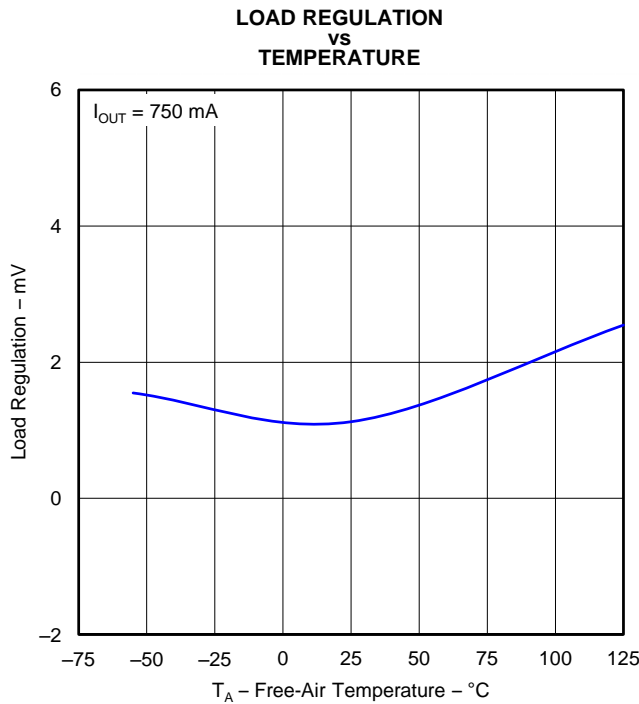

Figure 19.

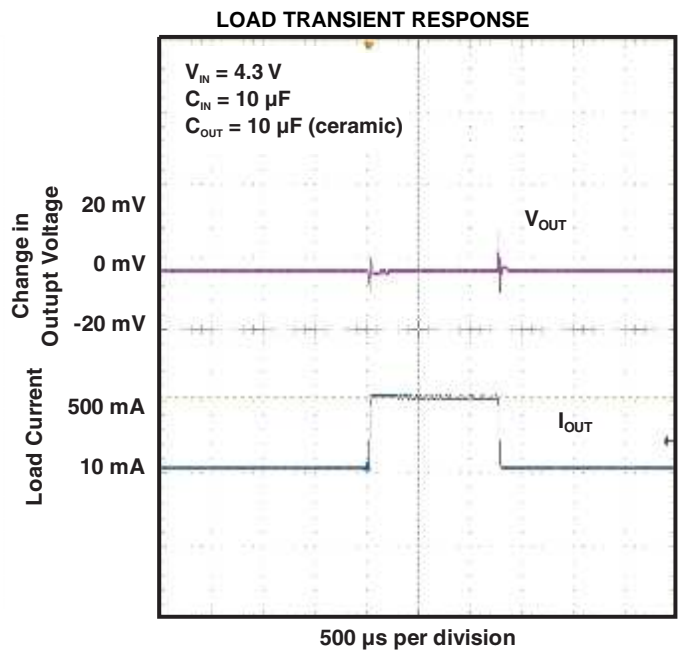

Figure 20.

## APPLICATION INFORMATION

The TPS7A4501 is a 750-mA low-dropout regulator optimized for fast transient response. The device is capable of supplying 750 mA at a dropout voltage of 300 mV. The low operating quiescent current (1 mA) drops to less than 1  $\mu$ A in shutdown. In addition to the low quiescent current, the TPS7A4501 regulator incorporates several protection features that makes it ideal for use in battery-powered systems. The device is protected against both reverse input and reverse

output voltages. In battery-backup applications where the output can be held up by a backup battery when the input is pulled to ground, the TPS7A4501 acts as if it has a diode in series with its output and prevents reverse current flow. Additionally, in dual-supply applications where the regulator load is returned to a negative supply, the output can be pulled below ground by as much as  $(20\text{ V} - V_{IN})$  and still allow the device to start and operate.

### Typical Applications

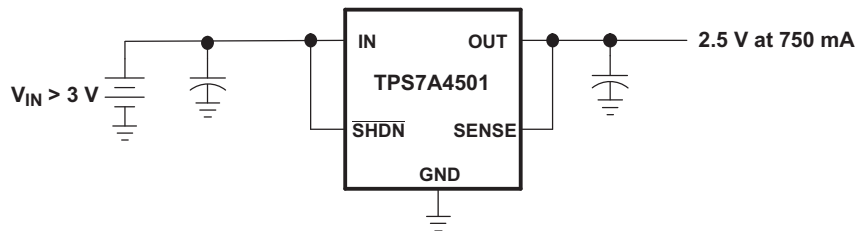

Figure 22. 3.3 V to 2.5 V Regulator

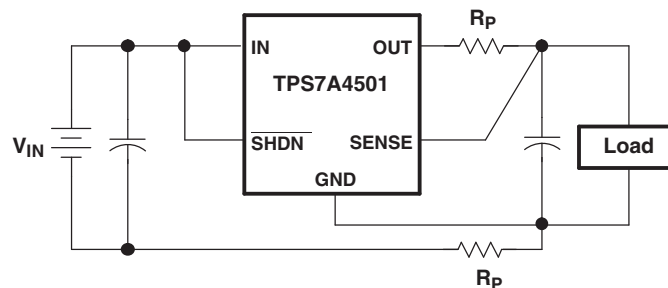
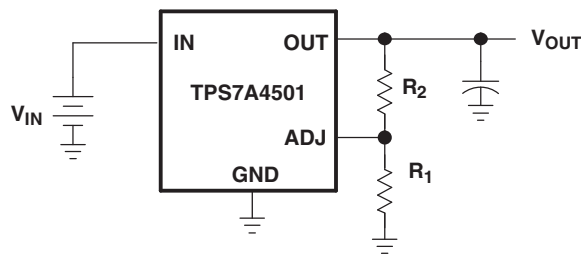

Figure 23. Kelvin Sense Connection

### Adjustable Operation

The adjustable TPS7A4501 has an output voltage range of 1.21 V to 20 V. The output voltage is set by the ratio of two external resistors as shown in Figure 24. The device maintains the voltage at the ADJ pin at 1.21 V referenced to ground. The current in R1 is then equal to (1.21 V/R1), and the current in R2 is the current in R1 plus the ADJ pin bias current. The ADJ pin bias current, 3 μA at 25°C, flows through R2 into the ADJ pin. The output voltage can be calculated using the formula shown in Figure 24. The value of R1 should be less than 4.17 kΩ to minimize errors in the output voltage caused by the ADJ pin bias current. Note that in shutdown the output is turned off, and the divider current is zero.



$$V_{OUT} = 1.21 \text{ V} \left( 1 + \frac{R_2}{R_1} \right) + (I_{ADJ})(R_2)$$

$$V_{ADJ} = 1.21 \text{ V}$$

$$I_{ADJ} = 3 \mu\text{A at } 25^\circ\text{C}$$

$$\text{Output range} = 1.21 \text{ V to } 20 \text{ V}$$

Figure 24. Adjustable Operation

The adjustable device is tested and specified with the ADJ pin tied to the OUT pin for an output voltage of 1.21 V. Specifications for output voltages greater than 1.21 V are proportional to the ratio of the desired output voltage to 1.21 V:  $V_{OUT}/1.21 \text{ V}$ . For example, load regulation for an output current change of 1 mA to 1.5 A is -3 mV (typ) at  $V_{OUT} = 1.21 \text{ V}$ . At  $V_{OUT} = 5 \text{ V}$ , load regulation is:

$$(5 \text{ V}/1.21 \text{ V})(-3 \text{ mV}) = -12.4 \text{ mV}$$

### Compensation

TPS7A4501 is internally compensated, however, a lead network using  $C_3$  can be implemented to boost the phase margin as well as reduce output noise.

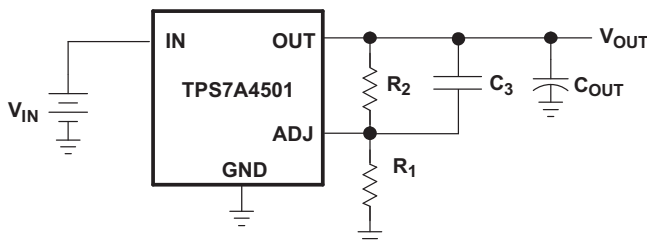

Figure 25. Compensation

$R_1$  bottom resistor,  $R_2$  top resistor form the output voltage divider network.  $C_3$  across  $R_2$  adds a lead network.

For  $R_1 = 3.2 \text{ k}\Omega$  and  $R_2 = 10 \text{ k}\Omega$   $V_{OUT}$  is set at 5 V and  $C_3 = 470 \text{ pF}$ .

Zero and pole can be calculated as shown below.

$$f_{z2} = \frac{1}{2 \cdot \pi \cdot R_2 \cdot C_3} \tag{1}$$

$$f_{z2} = 33.863 \text{ kHz}$$

$$R_{1p} = \frac{R_1 \cdot R_2}{R_1 + R_2} \tag{2}$$

$$R_{1p} = 2.424 \text{ k}\Omega$$

$$f_{p2} = \frac{1}{2 \cdot \pi \cdot R_{1p} \cdot C_3} \tag{3}$$

$$f_{p2} = 139.684 \text{ kHz}$$

### Output Capacitance and Transient Response

The TPS7A4501 regulator is designed to be stable with a wide range of output capacitors. The ESR of the output capacitor affects stability, most notably with small capacitors. A minimum output capacitor of 10 μF with an ESR of 3 Ω or less is recommended to prevent oscillations. Larger values of output capacitance can decrease the peak deviations and provide improved transient response for larger load current changes. Bypass capacitors, used to decouple individual components powered by the TPS7A4501, increase the effective output capacitor value.

Extra consideration must be given to the use of ceramic capacitors. Ceramic capacitors are manufactured with a variety of dielectrics, each with different behavior over temperature and applied voltage. The most common dielectric used for harsh environment is X7R. Ceramic capacitors lose capacitance when DC bias is applied across the capacitor. This capacitance loss is due to the polarization of the ceramic material. The capacitance loss is not permanent: after a large DC bias has been applied, reducing the DC bias will reduce the degree of polarization and capacitance will increase. DC bias effects vary dramatically with voltage rating, case size, capacitor value, and capacitor manufacturer. Since a capacitor could lose more than 50% of its capacitance with DC bias voltages near the voltage rating of the capacitor, it is important to consider DC bias when selecting a ceramic capacitor for an application.

Ceramic capacitors dielectric also change over the temperature range. For example X7R, first two letters X denotes lower temperature range -55°C whereas 7 denotes higher temperature range 125°C and R denotes capacitance variation over the temperature range ( $\pm 15\%$ ). For harsh environment applications minimum dielectric thickness must be 1mil for 100V DC rated capacitor and 0.8mil for 50V DC rated capacitors.

Voltage and temperature coefficients are not the only sources of problems. Some ceramic capacitors have a piezoelectric response. A piezoelectric device generates voltage across its terminals due to mechanical stress, similar to the way a piezoelectric accelerometer or microphone works. For a ceramic capacitor the stress can be induced by vibrations in the system or thermal transients.

Tantalum capacitors can provide higher capacitance per unit volume. Tantalum capacitors can be either manganese dioxide (MNO<sub>2</sub>) based capacitors where cathode is MN02 or polymer. MN02 based tantalum capacitors will exhibit high ESR as compared to polymer based tantalum capacitors. MN02 based tantalum capacitors require in excess of 60% voltage derating. Thus a 10V rated capacitor can only be used for 3.3V application. Whereas polymer based capacitors only require 10% voltage derating. Paralleling ceramic and tantalum capacitors will provide optimum balance between capacitance and ESR.

Table 2 highlights some of the capacitors used in the device.

### Overload Recovery

Like many IC power regulators, the TPS7A4501 has safe operating area protection. The safe area protection decreases the current limit as input-to-output voltage increases and keeps the power transistor inside a safe operating region for all values of input-to-output voltage. The protection is designed to provide some output current at all values of input-to-output voltage up to the device breakdown.

When power is first turned on, as the input voltage rises, the output follows the input, allowing the regulator to start up into very heavy loads. During start up, as the input voltage is rising, the input-to-output voltage differential is small, allowing the regulator to supply large output currents. With a high input voltage, a problem can occur wherein removal of an output short does not allow the output voltage to recover. Other regulators also exhibit this phenomenon, so it is not unique to the TPS7A4501.

The problem occurs with a heavy output load when the input voltage is high and the output voltage is low. Common situations occur immediately after the removal of a short circuit or when the shutdown pin is pulled high after the input voltage has already been turned on. The load line for such a load may intersect the output current curve at two points. If this happens, there are two stable output operating points for the regulator. With this double intersection, the input power supply may need to be cycled down to zero and brought up again to make the output recover.

### Output Voltage Noise

The TPS7A4501 regulator has been designed to provide low output voltage noise over the 10-Hz to 100-kHz bandwidth while operating at full load. Output voltage noise is typically 50  $\mu\text{V}/\sqrt{\text{Hz}}$  over this frequency bandwidth for the TPS7A4501. For higher output voltages (generated by using a resistor divider), the output voltage noise is gained up accordingly.

Higher values of output voltage noise may be measured when care is not exercised with regard to circuit layout and testing. Crosstalk from nearby traces can induce unwanted noise onto the output of the TPS7A4501. Power-supply ripple rejection must also be considered; the TPS7A4501 regulator does not have unlimited power-supply rejection and passes a small portion of the input noise through to the output.

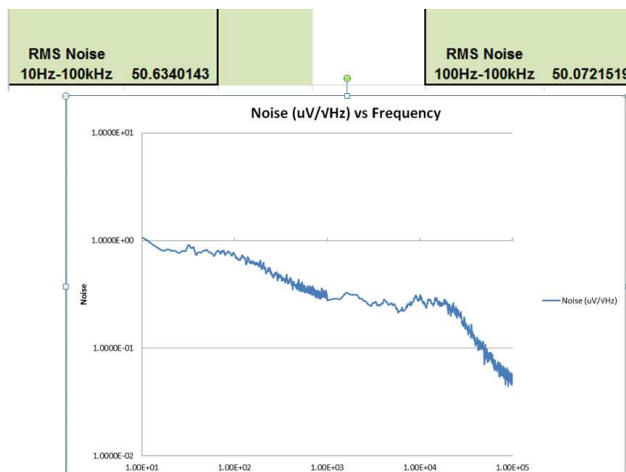

Figure 26. Output Noise Plot,  $V_{IN} = 7\text{ V}$ ,  $V_{OUT} = 5\text{ V}$  at 750 mA,  $C_{OUT} = 22\ \mu\text{F}$  Tantalum Capacitor

**Table 2. TPS7A4501-SP Capacitors**

Capacitor Part Number	Capacitor Details Type Vendor (Capacitor, Voltage, ESR)	Type	Vendor
T493X226M025AH6x20	22 $\mu$ F, 25 V, 35 m $\Omega$	Tantalum - MnO <sub>2</sub>	Kemet
T525D476M016ATE035	47 $\mu$ F, 10 V, 35 m $\Omega$	Tantalum - Polymer	Kemet
T525D107M010ATE025	100 $\mu$ F, 10 V, 25 m $\Omega$	Tantalum - Polymer	Kemet
T541X337M010AH6720	330 $\mu$ F, 10 V, 6 m $\Omega$	Tantalum - Polymer	Kemet
T525D227M010ATE025	220 $\mu$ F, 10 V, 25 m $\Omega$	Tantalum - Polymer	Kemet
T495X107K016ATE100	100 $\mu$ F, 16 V, 100 m $\Omega$	Tantalum - MnO <sub>2</sub>	Kemet
CWR29FK227JTHC	220 $\mu$ F, 10 V, 180 m $\Omega$	Tantalum - MnO <sub>2</sub>	AVX
THJE107K016AJH	100 $\mu$ F, 16 V, 58 m $\Omega$	Tantalum	AVX
THJE227K010AJH	220 $\mu$ F, 10 V, 40 m $\Omega$	Tantalum	AVX
SR2225X7R335K1P5#M123	3.3 $\mu$ F, 25 V, 10 m $\Omega$	Ceramic	Presidio Components Inc.

### Thermal Considerations

The power handling capability of the device is limited by the maximum rated junction temperature (125°C). The power dissipated by the device is made up of two components:

1. Output current multiplied by the input/output voltage differential:  $I_{OUT}(V_{IN} - V_{OUT})$
2. GND pin current multiplied by the input voltage:  $I_{GND}V_{IN}$ .

The GND pin current can be found using the GND Pin Current graphs in *Typical Characteristics*. Power dissipation is equal to the sum of the two components listed above.

### Calculating Junction Temperature

Example: Given an output voltage of 3.3 V, an input voltage range of 4 V to 6 V, an output current range of 0 mA to 500 mA, and a maximum case temperature of 50°C, what is the maximum junction temperature?

The power dissipated by the device is equal to:

$$I_{OUT(MAX)}(V_{IN(MAX)} - V_{OUT}) + I_{GND}(V_{IN(MAX)})$$

where,

$$I_{OUT(MAX)} = 500 \text{ mA}$$

$$V_{IN(MAX)} = 6 \text{ V}$$

$$I_{GND} \text{ at } (I_{OUT} = 500 \text{ mA}, V_{IN} = 6 \text{ V}) = 10 \text{ mA}$$

So,

$$P = 500 \text{ mA} \times (6 \text{ V} - 3.3 \text{ V}) + 10 \text{ mA} \times 6 \text{ V} = 1.41 \text{ W}$$

Using a U package, the thermal resistance is about 10.3°C/W. So the junction temperature rise above case is approximately equal to:

$$1.41 \text{ W} \times 10.3^\circ\text{C/W} = 14.5^\circ\text{C}$$

The TPS7A4501 regulators have internal thermal limiting designed to protect the device during overload conditions. For continuous normal conditions, the maximum junction temperature rating of 125°C must not be exceeded. It is important to give careful consideration to all sources of thermal resistance from junction to ambient. Additional heat sources mounted nearby must also be considered.

For surface-mount devices, heat sinking is accomplished by using the heat-spreading capabilities of the PC board and its copper traces. Copper board stiffeners and plated through-holes can also be used to spread the heat generated by power devices.

The maximum junction temperature is then be equal to the maximum junction-temperature rise above case plus the maximum case temperature or:

$$T_{JMAX} = 50^\circ\text{C} + 14.5^\circ\text{C} = 64.5^\circ\text{C}$$

### Protection Features

The TPS7A4501 regulator incorporates several protection features which makes it ideal for use in battery-powered circuits. In addition to the normal protection features associated with monolithic regulators, such as current limiting and thermal limiting, the device is protected against reverse input voltages, reverse output voltages and reverse voltages from output to input.

Current limit protection and thermal overload protection are intended to protect the device against current overload conditions at the output of the device. For normal operation, the junction temperature should not exceed 125°C.

The input of the device withstands reverse voltages of 20 V. Current flow into the device is limited to less than 1 mA (typically less than 100  $\mu$ A), and no negative voltage appears at the output. The device protects both itself and the load. This provides protection against batteries that can be plugged in backward.

The output of the TPS7A4501 can be pulled below ground without damaging the device. If the input is left open circuit or grounded, the output can be pulled below ground by 20 V. The output acts like an open circuit; no current flows out of the pin. If the input is powered by a voltage source, the output sources the short-circuit current of the device and protects itself by thermal limiting. In this case, grounding the SHDN pin turns off the device and stops the output from sourcing the short-circuit current.

The ADJ pin of the adjustable device can be pulled above or below ground by as much as 7 V without damaging the device. If the input is left open circuit or grounded, the ADJ pin acts like an open circuit when pulled below ground and like a large resistor (typically 5 k $\Omega$ ) in series with a diode when pulled above ground.

In situations where the ADJ pin is connected to a resistor divider that would pull the ADJ pin above its 7-V clamp voltage if the output is pulled high, the ADJ pin input current must be limited to less than 5 mA. For example, a resistor divider is used to provide a regulated 1.5-V output from the 1.21-V reference when the output is forced to 20 V. The top resistor of the resistor divider must be chosen to limit the current into the ADJ pin to less than 5 mA when the ADJ pin is at 7 V. The 13-V difference between OUT and ADJ divided by the 5-mA maximum current into the ADJ pin yields a minimum top resistor value of 2.6 k $\Omega$ .

In circuits where a backup battery is required, several different input/output conditions can occur. The output voltage may be held up while the input is either pulled to ground, pulled to some intermediate voltage, or is left open circuit.

When the IN pin of the TPS7A4501 is forced below the OUT pin or the OUT pin is pulled above the IN pin, input current typically drops to less than 2  $\mu$ A. This can happen if the input of the device is connected to a discharged (low voltage) battery and the output is held up by either a backup battery or a second regulator circuit. The state of the SHDN pin has no effect on the reverse output current when the output is pulled above the input.

修订历史记录

Changes from Original (December 2013) to Revision A	Page
• Changed 产品状态从产品预览改为生产数据 .....	1



## PACKAGING INFORMATION

Orderable Device	Status (1)	Package Type	Package Drawing	Pins	Package Qty	Eco Plan (2)	Lead finish/ Ball material (6)	MSL Peak Temp (3)	Op Temp (°C)	Device Marking (4/5)	Samples
5962-1222402V9A	ACTIVE	XCEPT	KGD	0	100	RoHS & Green	Call TI	N / A for Pkg Type	-55 to 125		<a href="#">Samples</a>
5962-1222402VHA	ACTIVE	CFP	U	10	1	Non-RoHS & Green	SNPB	N / A for Pkg Type	-55 to 125	1222402VHA 7A4501-SP	<a href="#">Samples</a>
5962R1222403V9A	ACTIVE	XCEPT	KGD	0	50	RoHS & Green	Call TI	N / A for Pkg Type	-55 to 125		<a href="#">Samples</a>
5962R1222403VXC	ACTIVE	CFP	HKU	10	1	RoHS-Exempt & Green	AU	N / A for Pkg Type	-55 to 125	R1222403VXC 7A4501-RHA	<a href="#">Samples</a>
TPS7A4501HKU/EM	ACTIVE	CFP	HKU	10	1	RoHS-Exempt & Green	AU	N / A for Pkg Type	25 to 25	7A4501HKU/EM EVAL ONLY	<a href="#">Samples</a>
TPS7A4501U/EM	ACTIVE	CFP	U	10	1	Non-RoHS & Green	SNPB	N / A for Pkg Type	25 to 25	7A4501U/EM EVAL ONLY	<a href="#">Samples</a>
TPS7A4501Y/EM	ACTIVE	XCEPT	KGD	0	5	RoHS & Green	Call TI	N / A for Pkg Type	25 to 25		<a href="#">Samples</a>

(1) The marketing status values are defined as follows:

**ACTIVE:** Product device recommended for new designs.

**LIFEBUY:** TI has announced that the device will be discontinued, and a lifetime-buy period is in effect.

**NRND:** Not recommended for new designs. Device is in production to support existing customers, but TI does not recommend using this part in a new design.

**PREVIEW:** Device has been announced but is not in production. Samples may or may not be available.

**OBSELETE:** TI has discontinued the production of the device.

(2) **RoHS:** TI defines "RoHS" to mean semiconductor products that are compliant with the current EU RoHS requirements for all 10 RoHS substances, including the requirement that RoHS substance do not exceed 0.1% by weight in homogeneous materials. Where designed to be soldered at high temperatures, "RoHS" products are suitable for use in specified lead-free processes. TI may reference these types of products as "Pb-Free".

**RoHS Exempt:** TI defines "RoHS Exempt" to mean products that contain lead but are compliant with EU RoHS pursuant to a specific EU RoHS exemption.

**Green:** TI defines "Green" to mean the content of Chlorine (Cl) and Bromine (Br) based flame retardants meet JS709B low halogen requirements of <=1000ppm threshold. Antimony trioxide based flame retardants must also meet the <=1000ppm threshold requirement.

(3) MSL, Peak Temp. - The Moisture Sensitivity Level rating according to the JEDEC industry standard classifications, and peak solder temperature.

(4) There may be additional marking, which relates to the logo, the lot trace code information, or the environmental category on the device.

(5) Multiple Device Markings will be inside parentheses. Only one Device Marking contained in parentheses and separated by a "~" will appear on a device. If a line is indented then it is a continuation of the previous line and the two combined represent the entire Device Marking for that device.

<sup>(6)</sup> Lead finish/Ball material - Orderable Devices may have multiple material finish options. Finish options are separated by a vertical ruled line. Lead finish/Ball material values may wrap to two lines if the finish value exceeds the maximum column width.

**Important Information and Disclaimer:**The information provided on this page represents TI's knowledge and belief as of the date that it is provided. TI bases its knowledge and belief on information provided by third parties, and makes no representation or warranty as to the accuracy of such information. Efforts are underway to better integrate information from third parties. TI has taken and continues to take reasonable steps to provide representative and accurate information but may not have conducted destructive testing or chemical analysis on incoming materials and chemicals. TI and TI suppliers consider certain information to be proprietary, and thus CAS numbers and other limited information may not be available for release.

In no event shall TI's liability arising out of such information exceed the total purchase price of the TI part(s) at issue in this document sold by TI to Customer on an annual basis.

**TUBE**

\*All dimensions are nominal

Device	Package Name	Package Type	Pins	SPQ	L (mm)	W (mm)	T (μm)	B (mm)
5962-1222402VHA	U	CFP	10	1	506.98	26.16	6220	NA
5962R1222403VXC	HKU	CFP	10	1	506.98	26.16	6220	NA
TPS7A4501HKU/EM	HKU	CFP	10	1	506.98	26.16	6220	NA
TPS7A4501U/EM	U	CFP	10	1	506.98	26.16	6220	NA



# PACKAGE OUTLINE

## HKU0010A

### CFP - 2.63mm max height

CERAMIC DUAL FLATPACK

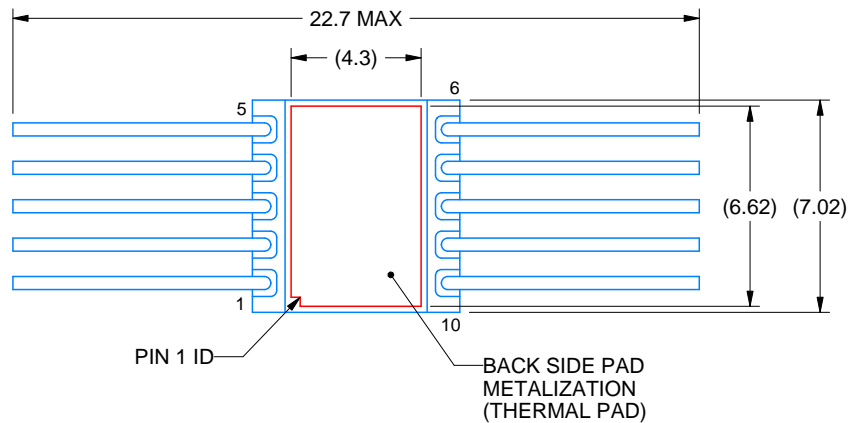
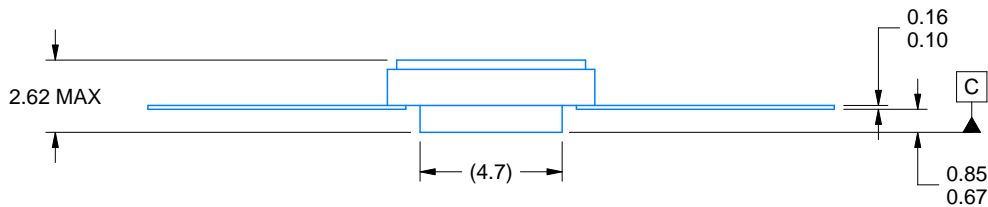
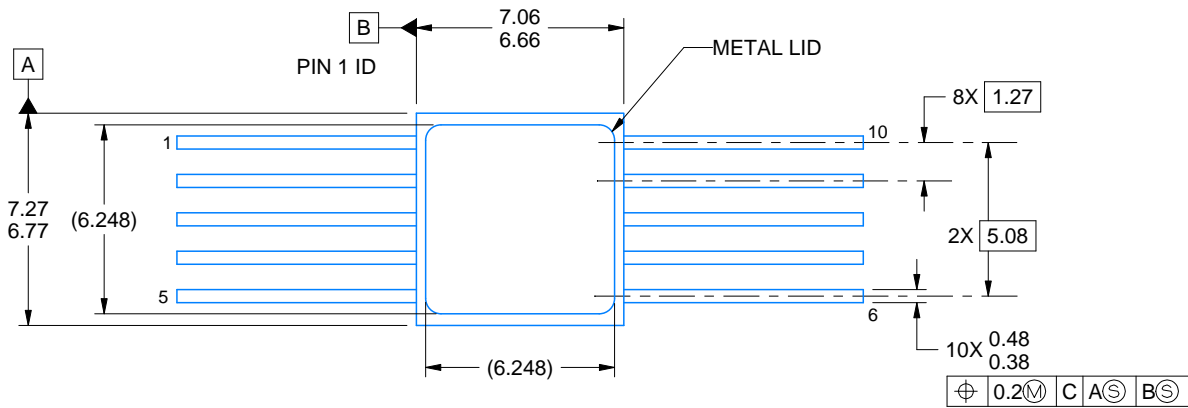

4226200/A 09/2020

#### NOTES:

1. All linear dimensions are in millimeters. Any dimensions in parenthesis are for reference only. Dimensioning and tolerancing per ASME Y14.5M.
2. This drawing is subject to change without notice.
3. This package is hermetically sealed with a metal lid.
4. The terminals are gold plated.
5. This drawing does not comply with MIL STD 1835. Do not use this package for compliant product.
6. Metal lid is connected to back side pad metalization.

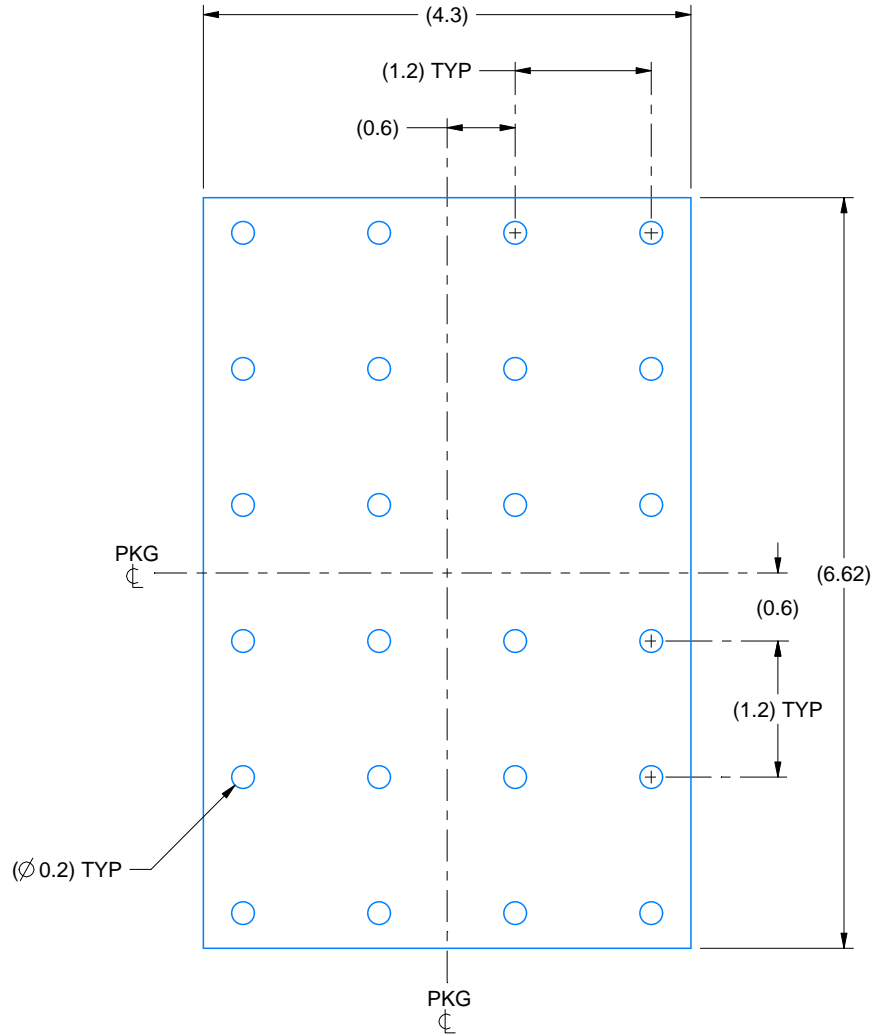

HEATSINK LAND PATTERN EXAMPLE  
EXPOSED METAL SHOWN  
SCALE:15X

# U0010A



## PACKAGE OUTLINE

CFP - 2.03 mm max height

CERAMIC FLATPACK

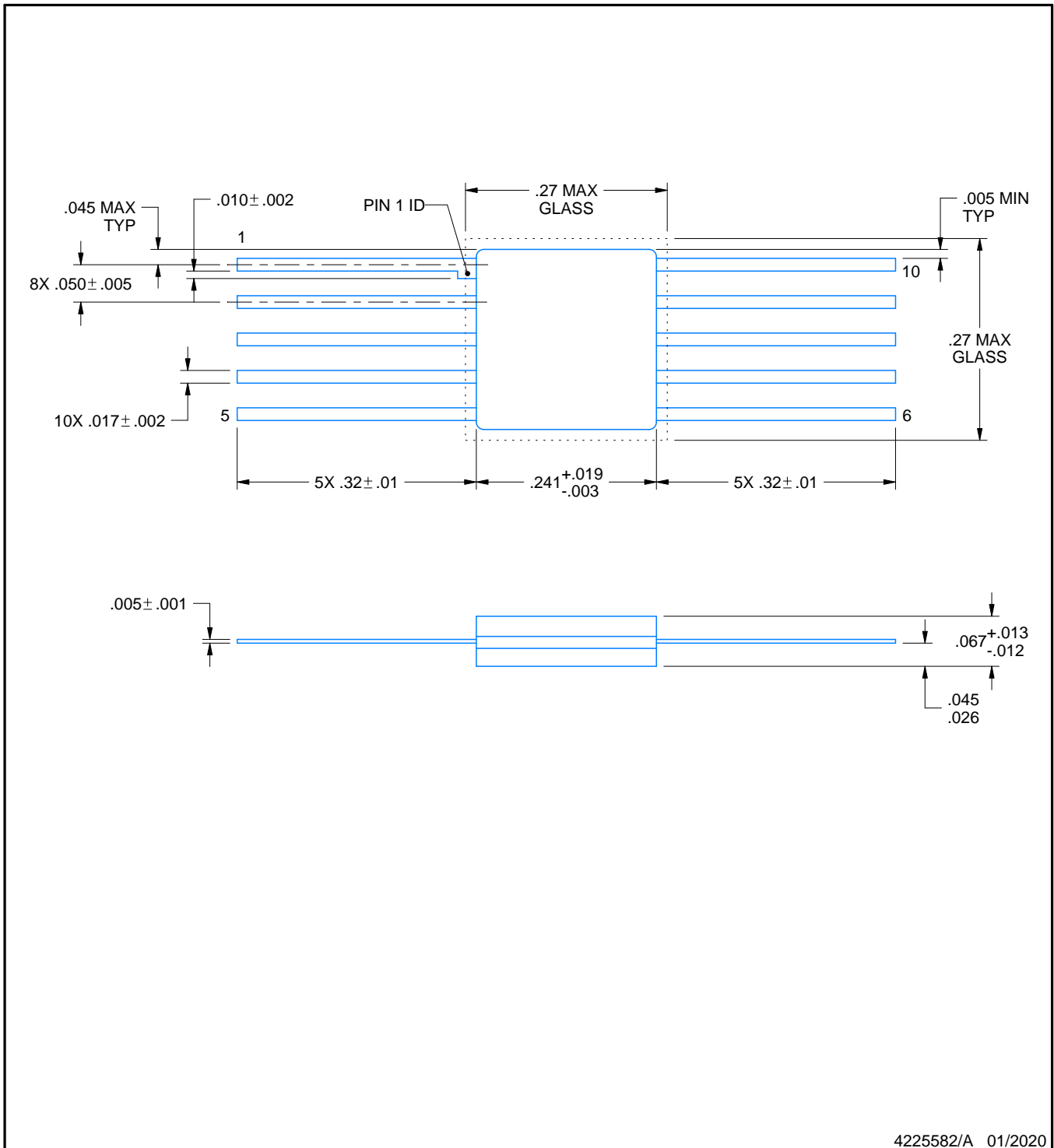

### NOTES:

1. All linear dimensions are in inches. Any dimensions in parenthesis are for reference only. Dimensioning and tolerancing per ASME Y14.5M.
2. This drawing is subject to change without notice.

## 重要声明和免责声明

TI“按原样”提供技术和可靠性数据（包括数据表）、设计资源（包括参考设计）、应用或其他设计建议、网络工具、安全信息和其他资源，不保证没有瑕疵且不做任何明示或暗示的担保，包括但不限于对适销性、某特定用途方面的适用性或不侵犯任何第三方知识产权的暗示担保。

这些资源可供使用 TI 产品进行设计的熟练开发人员使用。您将自行承担以下全部责任：(1) 针对您的应用选择合适的 TI 产品，(2) 设计、验证并测试您的应用，(3) 确保您的应用满足相应标准以及任何其他功能安全、信息安全、监管或其他要求。

这些资源如有变更，恕不另行通知。TI 授权您仅可将这些资源用于研发本资源所述的 TI 产品的应用。严禁对这些资源进行其他复制或展示。您无权使用任何其他 TI 知识产权或任何第三方知识产权。您应全额赔偿因在这些资源的使用中对 TI 及其代表造成的任何索赔、损害、成本、损失和债务，TI 对此概不负责。

TI 提供的产品受 [TI 的销售条款](#) 或 [ti.com](#) 上其他适用条款/TI 产品随附的其他适用条款的约束。TI 提供这些资源并不会扩展或以其他方式更改 TI 针对 TI 产品发布的适用的担保或担保免责声明。

TI 反对并拒绝您可能提出的任何其他或不同的条款。

邮寄地址：Texas Instruments, Post Office Box 655303, Dallas, Texas 75265

Copyright © 2023，德州仪器 (TI) 公司