

TPS6513x 双路正负输出直流/直流转换器

1 特性

- 输入电压范围：2.7V 至 5.5V
- V_{POS} 正升压转换器输出
 - 可调节输出电压：高达 15V
 - 两种开关电流限制选项：0.8 A 和 2 A
 - 转换效率高达 89%
- V_{NEG} 负反相降压/升压转换器输出
 - 可调节输出电压：低至 -15V
 - 两种开关电流限制选项：0.8 A 和 2 A
 - 转换效率高达 81%
- 外部 P 沟道 FET 的控制输出支持与电池连接完全断开
- 1 μ A 关断电流
- 用于灵活输出时序的单个使能输入
- 保护特性
 - V_{POS} 和 V_{NEG} 过压保护
 - 输入欠压闭锁
 - 热关断保护
- 4mm × 4mm VQFN-24 封装 (RGE)

2 应用

- LCD 和 AMOLED 显示器 (约 4 至 17 英寸)
 - 个人电子产品 (笔记本、显示器、游戏)
 - 楼宇自动化 (电梯、恒温器)
 - 医疗保健、健身、EPOS、工业 HMI、测试和测量
- 通用分离轨电源
 - T&M、数据采集、DAC、ADC
 - 差分音频 PA 电源
 - 工厂自动化和控制输入和输出模块
 - 差分 OPAMP 和比较器电源

3 说明

TPS6513x 器件是一款双路输出直流/直流转换器电源，可生成高达 15V 的正输出和低至 -15V 的负输出。该转换器可保持低输出电压纹波。通常，最大输出电流在 200mA 至 500mA 范围内，具体取决于输入电压与输出电压的比率以及电流限制选项。组合 (V_{POS} 和 V_{NEG}) 效率达到 85%，以保持系统冷却或实现更长的电池使用时间。2.7V 至 5.5V 的输入电压范围可以让器件由电池或固定的 3.3V 或 5V 电源轨供电。

此转换器采用定频 PWM 控制拓扑运行，而且，在省电模式下运行时，它在轻负载电流的情况下使用脉冲跳跃模式。它运行的电流仅为 500 μ A 器件静态电流。

独立使能引脚可实现针对两个输出的灵活加电和断电时序。正负输出独立运行，可实现非对称的输出电压和电流。

该转换器具有内部电流限制过压保护功能和热关断功能，以确保在故障情况下实现更高可靠性。该转换器采用 4mm × 4mm VQFN-24 封装。该解决方案尺寸很小，最小开关频率为 1.25MHz，适用于较小的电感器和所需的其他外部组件。

器件信息

器件型号	封装 ⁽¹⁾	封装尺寸 (标称值)
TPS65130	VQFN (24)	4.00mm × 4.00mm
TPS65131		

(1) 如需了解所有可用封装，请参阅数据表末尾的可订购产品附录。

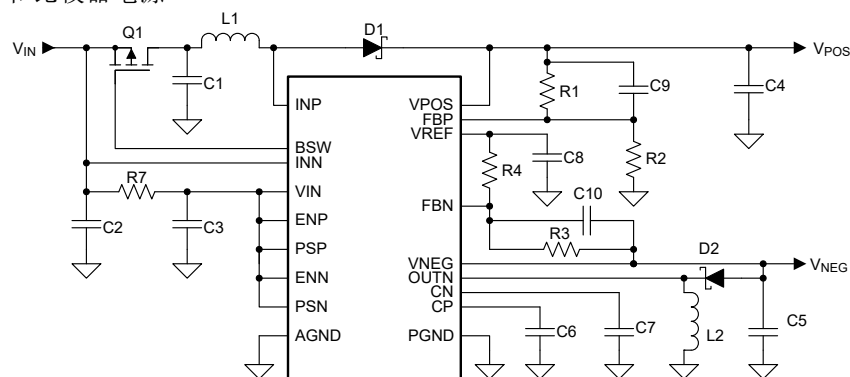

简化版应用



Table of Contents

1 特性	1	7.4 Device Functional Modes.....	10
2 应用	1	8 Applications and Implementation	11
3 说明	1	8.1 Application Information.....	11
4 Revision History	2	8.2 Typical Application.....	11
5 Pin Configuration and Functions	3	9 Layout	27
6 Specifications	4	9.1 Layout Guidelines.....	27
6.1 Absolute Maximum Ratings.....	4	9.2 Layout Example.....	27
6.2 ESD Ratings.....	4	9.3 Thermal Considerations.....	27
6.3 Recommended Operating Conditions.....	4	10 Device and Documentation Support	29
6.4 Thermal Information.....	5	10.1 Device Support.....	29
6.5 Electrical Characteristics.....	5	10.2 接收文档更新通知.....	29
6.6 Switching Characteristics.....	6	10.3 支持资源.....	29
6.7 Typical Characteristics.....	6	10.4 Trademarks.....	29
7 Detailed Description	8	10.5 Electrostatic Discharge Caution.....	29
7.1 Overview.....	8	10.6 术语表.....	29
7.2 Functional Block Diagram.....	8	11 Mechanical, Packaging, and Orderable Information	30
7.3 Feature Description.....	8		

4 Revision History

注：以前版本的页码可能与当前版本的页码不同

Changes from Revision D (January 2016) to Revision E (April 2022)	Page
• 更新了整个文档中的表格、图和交叉参考的编号格式.....	1
• 更新了首页器件说明.....	1
• Changed ESD HBM specification from "±2000" to "±1000".....	4
• Changed text string in 节 8.2.2.1.1 description From "...to set the divider current at 5 μA or greater" To "...to set the divider current at 5 μA to 10 μA".....	12
• Added 节 8.2.3 description.....	15
• Corrected typographic error in x-axis labels for 图 8-39, 图 8-40, 图 8-41, 图 8-45, and 图 8-46.....	16

Changes from Revision C (June 2015) to Revision D (January 2016)	Page
• 将特性项目符号“2.7V 至 5.5V 输入电压范围”移至列表顶部并更改了应用项目符号列表.....	1

Changes from Revision B (September 2004) to Revision C (March 2015)	Page
• 添加了引脚配置和功能部分、ESD 等级表、特性说明部分、器件功能模式、应用和实施部分、电源相关建议部分、布局部分、器件和文档支持部分以及机械、封装和可订购信息部分.....	1
• 添加、更新和重新排列了热性能信息、电气特性、详细说明部分和典型特征部分。.....	1

5 Pin Configuration and Functions



图 5-1. RGE Package, 24-PIN VQFN (Top View)

表 5-1. Pin Functions

PIN		TYPE	DESCRIPTION
NAME	NO.		
AGND	19	—	Analog ground pin
BSW	7	O	Gate control pin for external battery switch. This pin goes low when ENP is set high.
CN	18	—	Compensation pin for inverting converter control
CP	21	—	Compensation pin for boost converter control
ENN	10	I	Enable pin for the negative output voltage (0 V: disabled, VIN: enabled)
ENP	8	I	Enable pin for the positive output voltage (0 V: disabled, VIN: enabled)
FBN	16	I	Feedback pin for the negative output voltage divider
FBP	22	I	Feedback pin for the positive output voltage divider
INN	5, 6	I	Inverting converter switch input
INP	1, 24	I	Boost converter switch input.
NC	12, 20	—	Not connected
OUTN	13, 14	O	Inverting converter switch output.
PGND	2, 3	—	Power ground pin
PSN	11	I	Power-save mode enable for inverter stage (0 V: disabled, VIN: enabled)
PSP	9	I	Power-save mode enable for boost converter stage (0 V: disabled, VIN: enabled)
VIN	4	I	Control supply input
VNEG	15	I	Negative output voltage sense input
VPOS	23	I	Positive output voltage sense input
VREF	17	O	Reference output voltage. Bypass this pin with a 220-nF capacitor to ground. Connect the lower resistor of the negative output voltage divider to this pin

6 Specifications

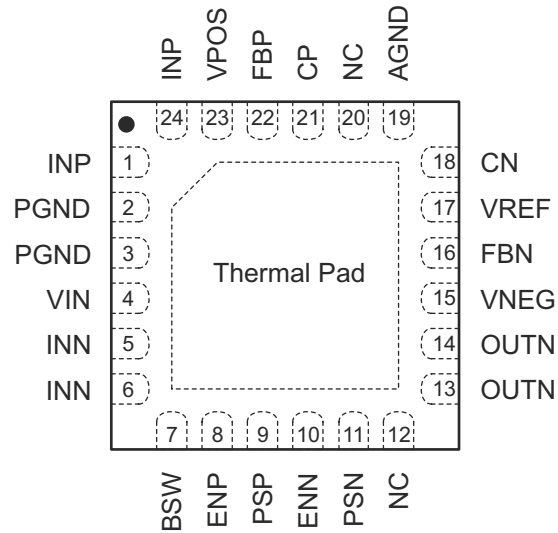
6.1 Absolute Maximum Ratings

over operating free-air temperature range unless otherwise noted⁽¹⁾

	MIN	MAX	UNIT
V _{IN} , I _{NN} Input voltage at pins ⁽²⁾	- 0.3	6	V
V _{POS} Maximum voltage at pin ⁽²⁾	- 0.3	17	V
V _{NEG} Minimum voltage at pin ⁽²⁾	- 17	V _{IN} + 0.3	V
Voltage at pins ENN, ENP, FBP, FBN, CN, CP, PSP, PSN, BSW ⁽²⁾	- 0.3	V _{IN} + 0.3	V
I _{NP} Input voltage at pin ⁽²⁾	- 0.3	17	V
Differential voltage between pins OUTN to V _{INN} ⁽²⁾	- 0.3	24	V
T _J Operating virtual junction temperature	- 40	150	°C
T _{STG} Storage temperature	- 65	150	°C

- (1) Stresses beyond those listed under *Absolute Maximum Ratings* may cause permanent damage to the device. These are stress ratings only, which do not imply functional operation of the device at these or any other conditions beyond those indicated under *Recommended Operating Conditions*. Exposure to absolute-maximum-rated conditions for extended periods may affect device reliability.
- (2) All voltage values are with respect to network ground terminal, unless otherwise noted.

6.2 ESD Ratings

		VALUE	UNIT
V _(ESD) Electrostatic discharge	Human body model (HBM), per ANSI/ESDA/JEDEC JS-001 ⁽¹⁾	±1000	V
	Charged-device model (CDM), per JEDEC specification JEDEC JS-002 ⁽²⁾	±750	

- (1) JEDEC document JEP155 states that 500-V HBM allows safe manufacturing with a standard ESD control process.
- (2) JEDEC document JEP157 states that 250-V CDM allows safe manufacturing with a standard ESD control process.

6.3 Recommended Operating Conditions

over operating free-air temperature, unless otherwise noted

	MIN	MAX	UNIT
V _I , V _{IN} , V _{INN} Application input voltage range, input voltage range at VIN and INN pins	2.7	5.5	V
V _{POS} Adjustable output voltage range for the boost converter	V _I + 0.5	15	V
V _{NEG} Adjustable output voltage range for the inverting converter	- 15	- 2	V
V _{ENN} , V _{ENP} Enable signals voltage	0	5.5	V
V _{PSN} , V _{PSP} Power-save mode enable signals voltage	0	5.5	V
T _A Operating free-air temperature range	- 40	85	°C
T _J Operating junction temperature range	- 40	125	°C

6.4 Thermal Information

THERMAL METRIC ⁽¹⁾		TPS65130x	UNIT
		RGE Package (VQFN)	
		24 PINS	
$R_{\theta JA}$	Junction-to-ambient thermal resistance	34.1	°C/W
$R_{\theta JC(top)}$	Junction-to-case (top) thermal resistance	36.8	°C/W
$R_{\theta JB}$	Junction-to-board thermal resistance	12.2	°C/W
ψ_{JT}	Junction-to-top characterization parameter	0.4	°C/W
ψ_{JB}	Junction-to-board characterization parameter	12.3	°C/W
$R_{\theta JC(bot)}$	Junction-to-case (bottom) thermal resistance	2.8	°C/W

(1) For more information about traditional and new thermal metrics, see the *Semiconductor and IC Package Thermal Metrics* application report, SPRA953.

6.5 Electrical Characteristics

over the full recommended input voltage range $2.7\text{ V} \leq V_{IN} \leq 5.5\text{ V}$ and over the temperature range $-40^\circ\text{C} \leq T_J \leq 125^\circ\text{C}$ unless otherwise noted. Typical values apply for $V_{IN} = 3.6\text{ V}$ and $T_J = 25^\circ\text{C}$.

PARAMETER		TEST CONDITIONS	MIN	TYP	MAX	UNIT	
DC-DC STAGE (V_{POS}, V_{NEG})							
V_{POS}	Adjustable output voltage range		$V_{IN} + 0.5\text{ V}$		15	V	
V_{NEG}	Adjustable output voltage range		-15		-2	V	
V_{REF}	Reference voltage	$I_{REF} = 10\ \mu\text{A}$	1.2	1.213	1.225	V	
I_{FBP}	Positive feedback input bias current	$V_{FBP} = V_{REF}$		50		nA	
I_{FBN}	Negative feedback input bias current	$V_{FBN} = 0.1 V_{REF}$		50		nA	
V_{FBP}	Positive feedback regulation voltage	$V_{IN} = 2.7\text{ V to } 5.5\text{ V}$	1.189	1.213	1.237	V	
V_{FBN}	Negative feedback regulation voltage	$V_{IN} = 2.7\text{ V to } 5.5\text{ V}$	-0.024	0	0.024	V	
Total Output DC accuracy				3%			
$r_{DS(ON)(N)}$	Inverter switch ON-resistance	$V_{IN} = 3.6\text{ V}$		440	620	m Ω	
		$V_{IN} = 5\text{ V}$		330	530		
I_{LIMN}	TPS65130 Inverter switch current limit	$2.7\text{ V} < V_{IN} < 5.5\text{ V}$	700	800	900	mA	
I_{LIMN}	TPS65131 Inverter switch current limit	$V_{IN} = 3.6\text{ V}$	1800	1950	2200	mA	
$r_{DS(ON)(P)}$	Boost switch ON-resistance	$V_{POS} = 5\text{ V}$		230	300	m Ω	
		$V_{POS} = 10\text{ V}$		170	200		
I_{LIMP}	TPS65130 Boost switch current limit	$2.7\text{ V} < V_{IN} < 5.5\text{ V}$, $V_{POS} = 8\text{ V}$	700	800	900	mA	
I_{LIMP}	TPS65131 Boost switch current limit	$V_{IN} = 3.6\text{ V}$, $V_{POS} = 8\text{ V}$	1800	1950	2200	mA	
CONTROL STAGE							
V_{IH}	High level input voltage, ENP, ENN, PSP, PSN		1.4			V	
V_{IL}	Low level input voltage, ENP, ENN, PSP, PSN				0.4	V	
I_{IN}	Input current, ENP, ENN, PSP, PSN	ENP, ENN, PSP, PSN = GND or V_{IN}		0.01	0.1	μA	
R_{BSW}	Output resistance			27		k Ω	
V_{IN}	Input voltage range		2.7		5.5	V	
I_Q	Quiescent current	VIN	$V_{IN} = 3.6\text{ V}$, $I_{POS} = I_{NEG} = 0$, ENP = ENN = PSP = PSN = V_{IN} , $V_{POS} = 8\text{ V}$, $V_{NEG} = -5\text{ V}$		300	500	μA
		VPOS			100	120	μA
		VNEG			100	120	μA
I_{SD}	Shutdown supply current	ENN = ENP = GND		0.2	1.5	μA	
V_{UVLO}	Undervoltage lockout threshold		2.1	2.35	2.7	V	

over the full recommended input voltage range $2.7\text{ V} \leq V_{IN} \leq 5.5\text{ V}$ and over the temperature range $-40^\circ\text{C} \leq T_J \leq 125^\circ\text{C}$ unless otherwise noted. Typical values apply for $V_{IN} = 3.6\text{ V}$ and $T_J = 25^\circ\text{C}$.

PARAMETER	TEST CONDITIONS	MIN	TYP	MAX	UNIT
Thermal shutdown			150		$^\circ\text{C}$
Thermal shutdown hysteresis	Junction temperature decreasing		5		$^\circ\text{C}$

6.6 Switching Characteristics

over the full recommended input voltage range $2.7\text{ V} \leq V_{IN} \leq 5.5\text{ V}$ and over the temperature range $-40^\circ\text{C} \leq T_J \leq 125^\circ\text{C}$ unless otherwise noted. Typical values apply for $V_{IN} = 3.6\text{ V}$ and $T_J = 25^\circ\text{C}$.

PARAMETER	TEST CONDITIONS	MIN	TYP	MAX	UNIT
FREQUENCY					
f_S	Oscillator frequency	1250	1380	1500	kHz
DUTY CYCLE					
D_{MAXP}	Maximum duty cycle boost converter		87.5%		
D_{MAXN}	Maximum duty cycle inverting converter		87.5%		
D_{MINP}	Minimum duty cycle boost converter		12.5%		
D_{MINN}	Minimum duty cycle inverting converter		12.5%		

6.7 Typical Characteristics

At 25°C , unless otherwise noted.



图 6-1. TPS65130 Maximum Output Current (V_{POS}) vs Input Voltage



图 6-2. TPS65131 Maximum Output Current (V_{POS}) vs input Voltage

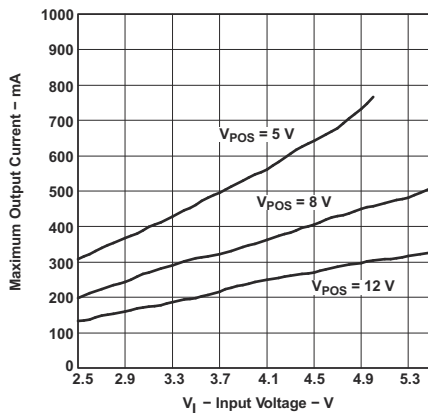

图 6-3. TPS65130 Maximum Output Current (V_{NEG}) vs Input Voltage

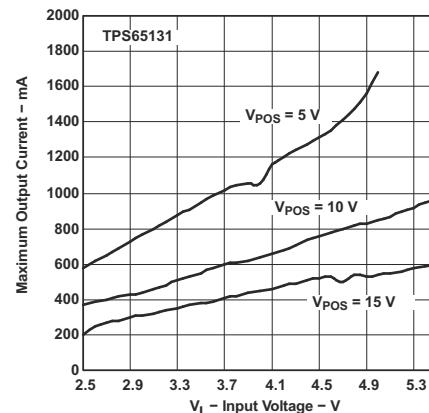

图 6-4. TPS65131 Maximum Output Current (V_{NEG}) vs Input Voltage

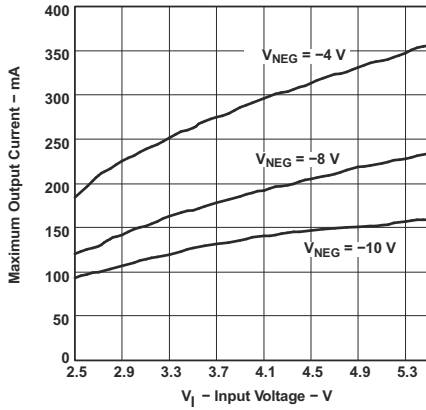

图 6-5. No Load Supply Current into V_{IN} vs Input Voltage

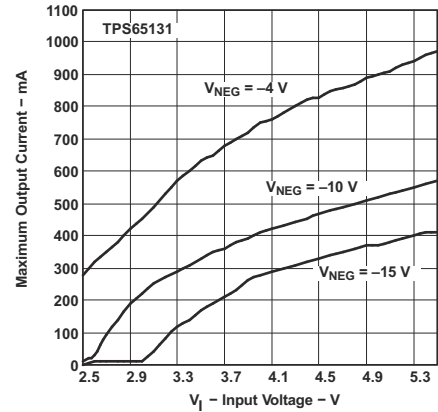

图 6-6. No Load Supply Current into V_{POS} vs Input Voltage

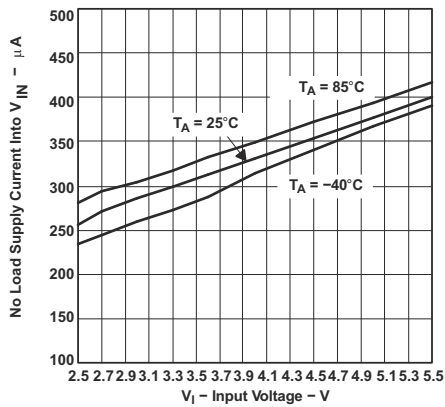

图 6-7. No Load Supply Current into V_{NEG} vs Input Voltage

7 Detailed Description

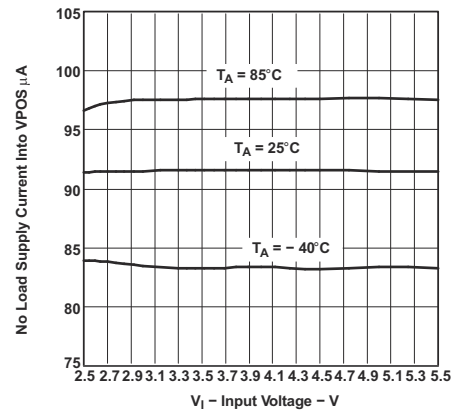
7.1 Overview

The TPS65130/1 operates with an input voltage range of 2.7 V to 5.5 V and can generate both a positive and negative output. Both converters work independently of each other. They only share a common clock and a common voltage reference. Both outputs are separately controlled by a fixed-frequency, pulse-width-modulated (PWM) regulator. In general, each converter operates at continuous conduction mode (CCM). At light loads, the negative converter can enter discontinuous conduction mode (DCM). As the load current decreases, the converters can enter a power-save mode if enabled. This works independently at both converters. Output voltages can go up to 15 V at the boost output and down to -15 V at the inverter output.

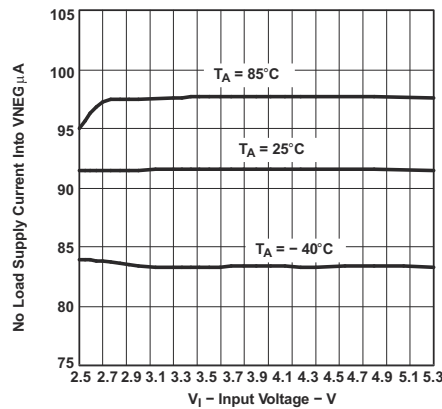
7.2 Functional Block Diagram

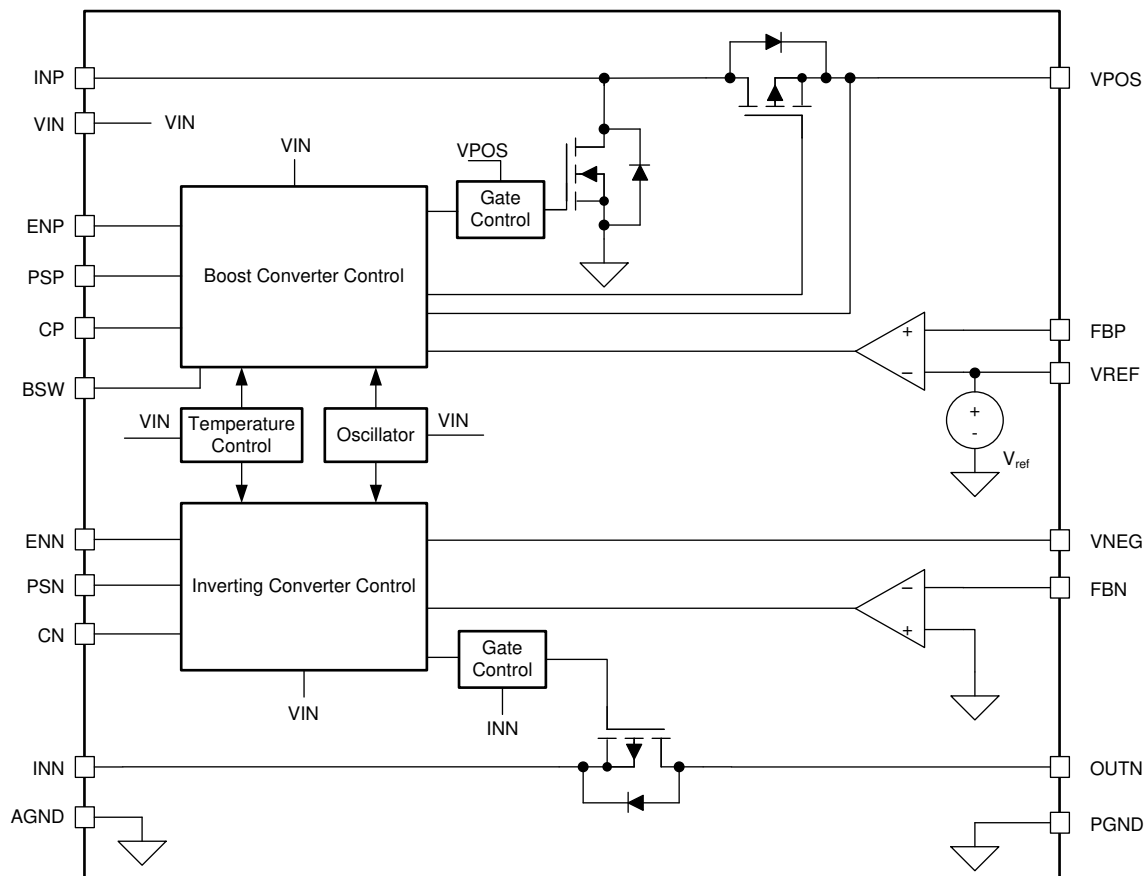

Copyright © 2017, Texas Instruments Incorporated

7.3 Feature Description

7.3.1 Power Conversion

Both converters operate in a fixed-frequency, PWM control scheme. So, the ON-time of the switches varies depending on input-to-output voltage ratio and the load. During this ON-time, the inductors connected to the converters charge with current. In the remaining time, the time period set by the fixed operating frequency, the inductors discharge into the output capacitors through the rectifier diodes. Usually at greater loads, the inductor currents are continuous. At lighter loads, the boost converter uses an additional internal switch to allow current flowing back to the input. This avoids inductor current becoming discontinuous in the boost converter. So, the boost converter is always controlled in a continuous current mode. At the inverting converter, during light loads, the inductor current can become discontinuous. In this case, the control circuit of the inverting controller output automatically takes care of these changing conditions to always operate with an optimum control setup.

7.3.2 Control

The controller circuits of both converters employ a fixed-frequency, multiple-feedforward controller topology. The circuits monitor input voltage, output voltage, and voltage drop across the switches. Changes in the operating conditions of the converters directly affect the duty cycle and must not take the indirect and slow way through the output voltage control loops. Measurement errors in this feedforward system are corrected by a self-learning control system. An external capacitor damps the output to avoid output-voltage steps due to output changes of this selflearning control system.

The voltage loops, determined by the error amplifiers, must only handle small signal errors. The error amplifiers feature internal compensation. Their inputs are the feedback voltages on the FBP and FBN pins. The device uses a comparison of these voltages with the internal reference voltage to generate an accurate and stable output voltage.

7.3.3 Enable

Both converters can be enabled or disabled individually. Applying a logic HIGH signal at the enable pins (ENP for the boost converter, ENN for the inverting converter) enables the corresponding output. After enabling, internal circuitry necessary to operate the specific converter turns on followed by the soft-start period.

Applying a low signal at the enable ENP or ENN pin shuts down the corresponding converter. When both enable pins are low, the device enters shutdown mode, where all internal circuitry turns off. At this point, the device consumes shutdown current flowing into the VIN pin. The output loads of the converters can be disconnected from the input, see [7.3.4](#).

7.3.4 Load Disconnect

The device supports completely disconnecting the load when the converters are disabled. For the inverting converter, the device turns off the internal PMOS switch. If the inverting converter is turned off, no DC current path remains which could discharge the battery or supply.

This is different for the boost converter. The external rectifying diode, together with the boost inductor, form a DC current path which could discharge the battery or supply if any load connects to the output. The device has no internal switch to prevent current from flowing. For this reason, the device offers a PMOS gate control output (BSW) to enable and disable a PMOS switch in this DC current path, ideally directly between the boost inductor and battery. To be able to fully disconnect the battery, the forward direction of the parasitic backgate diode of this switch must point to the battery or supply. The external PMOS switch, which connects to BSW, turns on when the boost converter is enabled and turns off when the boost converter is disabled.

7.3.5 Soft-Start

Both converters have implemented soft-start functions. When each converter is enabled, the implemented switch current limit ramps up slowly to its nominal programmed value in about 1 ms. Soft-start is implemented to limit the input current during start-up to avoid high peak currents at the battery which could interfere with other systems connected to the same battery. Without soft-start, the high input peak current could trigger the implemented switch current limit, which can lead to a significant voltage drops across the series resistance of the battery and its connections.

7.3.6 Overvoltage Protection

Both converters (boost and inverter) have implemented individual overvoltage protection. If the feedback voltage under normal operation exceeds the nominal value by typically 5%, the corresponding converter shuts down immediately to protect any connected circuitry from possible damage.

7.3.7 Undervoltage Lockout

An undervoltage lockout (UVLO) prevents the device from starting up and operating if the supply voltage at the VIN pin is lower than the undervoltage lockout threshold. For this case, the device automatically shuts down both converters when the supply voltage at VIN falls below this threshold. Nevertheless, parts of the control circuits remain active, which is different than device shutdown.

7.3.8 Overtemperature Shutdown

The device automatically shuts down both converters if the implemented internal temperature sensor detects a chip temperature above the thermal shutdown temperature. It automatically starts operating again when the chip temperature falls below this thermal shutdown temperature. The built-in hysteresis avoids undefined operation caused by ringing from shutdown and prevents operating at a temperature close to the overtemperature shutdown threshold.

7.4 Device Functional Modes

7.4.1 Power-Save Mode

The power-save mode can improve efficiency at light loads. In power-save mode, the converter only operates when the output voltage falls below the threshold voltage that is internally set by the device. The converter ramps up the output voltage with one or several operating pulses and goes again into power-save mode once the inductor current becomes discontinuous.

The PSN and PSP logic level selects between power-save mode and continuous-conduction mode. If the specific pins (PSP for the boost converter, PSN for the inverting converter) are HIGH, the power-save mode for the corresponding converter operates at light loads. Similarly, a LOW on the PSP pin or PSN pin disables the power-save mode for the corresponding converter.

7.4.2 Full Operation with $V_{IN} > 2.7\text{ V}$

The recommended minimum input supply voltage for the TPS65130/1 device is 2.7 V. Above this voltage, the device achieves the performance described in this data sheet.

7.4.3 Limited Operation with $V_{UVLO} < V_{IN} < 2.7\text{ V}$

With input supply voltages between V_{UVLO} and 2.7 V, the device continues to operate. No functions are disabled, but full performance is not ensured.

7.4.4 No Operation with $V_{IN} < V_{UVLO}$

The TPS6513x enters an undervoltage lockout condition when the input supply voltage is below the UVLO threshold. In this mode, all device functions are disabled, and the input supply current consumption is minimized. See also [# 7.3.7](#).

8 Applications and Implementation

备注

以下应用部分中的信息不属于 TI 元件规格，TI 不担保其准确性和完整性。TI 的客户负责确定元件是否适合其用途，以及验证和测试其设计实现以确认系统功能。

8.1 Application Information

The TPS6513x boost converter output voltage, V_{POS} , and the inverting converter output voltage, V_{NEG} , require external components to set the required output voltages. The valid output voltage ranges are as shown in [Recommended Operating Conditions](#). The following sections show a typical application example with different output voltage settings and guidance for external component choices.

8.2 Typical Application



图 8-1. Typical Application

8.2.1 Design Requirements

图 8-1 uses the following parameters:

表 8-1. Design Parameters

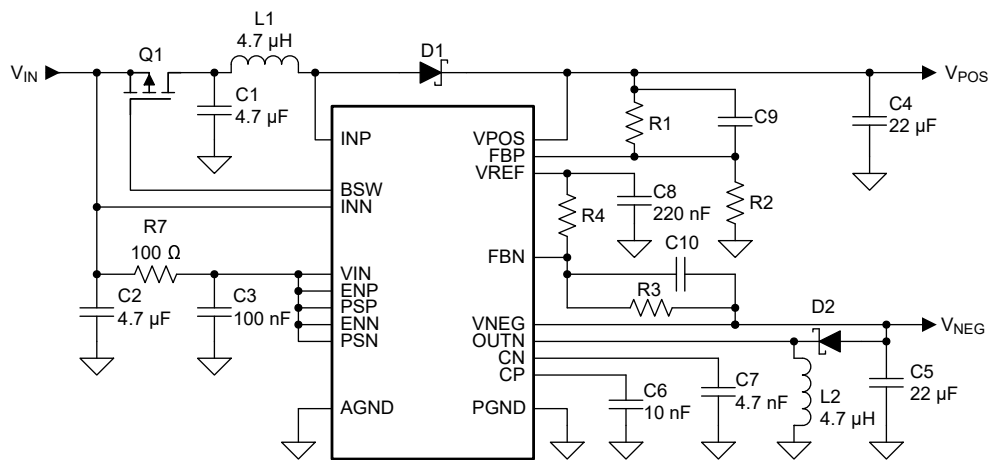
DESIGN PARAMETER	EXAMPLE VALUE	
Input voltage range	2.7 V to 5.5 V	
Boost converter output voltage, V_{POS}	R1 = 1 M Ω R2 = 130k Ω C9 = 6.8 pF	10.5 V
Inverting converter output voltage, V_{NEG}	R3 = 1 M Ω R4 = 121.2 k Ω C10 = 7.5 pF	- 10 V

表 8-2. List of Components

REFERENCE	SETUP	VALUE, DESCRIPTION	
C1, C2	—	4.7 μ F, ceramic, 6.3 V, X5R	
C3		0.1 μ F, ceramic, 10 V, X5R	
C4, C5		4 x 4.7 μ F, ceramic, 25 V, X7R	
C6		10 nF, ceramic, 16 V, X7R	
C7		4.7 nF, 50 V, C0G	
C8		220 nF, ceramic, 6.3 V, X5R	
R1		$V_{POS} = 10.5$ V	1 M Ω
		$V_{POS} = 15$ V	975 k Ω
R2	$V_{POS} = 10.5$ V	130 k Ω	
	$V_{POS} = 15$ V	85.8 k Ω	
R3	$V_{NEG} = -10$ V	1 M Ω	
	$V_{NEG} = -15$ V	1.3 M Ω	
R4	$V_{NEG} = -10$ V	121.2 k Ω	
	$V_{NEG} = -15$ V	104.8 k Ω	
R7	—	100 Ω	
D1, D2		Schottky, 1 A, 20 V, Onsemi MBRM120	
L1, L2		Würth Elektronik 7447789004 (TPS65130), EPCOS B82462-G4472 (TPS65131)	
Q1		MOSFET, P-channel, 12 V, 4 A, Vishay Si2323DS	

8.2.2 Detailed Design Procedure

The TPS65130/1 DC-DC converter is intended for systems typically powered by a single-cell Li-ion or Li-polymer battery with a terminal voltage from 2.7 V up to 4.2 V. Because the recommended input voltage goes up to 5.5 V, the device is also suitable for 3-cell alkaline, NiCd, or NiMH batteries, as well as any regulated supply voltages from 2.7 V to 5.5 V. It provides two independent output voltage rails which are programmed as follows.

8.2.2.1 Programming the Output Voltage

8.2.2.1.1 Boost Converter

The output voltage of the TPS65130/1 boost converter stage can be adjusted with an external resistor divider connected to the FBP pin. The typical value of the voltage at the FBP pin is the reference voltage, which is 1.213 V. The maximum recommended output voltage at the boost converter is 15 V. To achieve appropriate accuracy, the current through the feedback divider should be about 100 times greater than the current into the FBP pin. Typical current into the FBP pin is 0.05 μ A, and the voltage across R2 is 1.213 V. Based on those values, the recommended value for R2 should be lower than 200 k Ω to set the divider current at 5 μ A to 10 μ A.

Calculate the value of resistor R1, as a function of the needed output voltage (V_{POS}), with [方程式 1](#):

$$R1 = R2 \times \left(\frac{V_{POS}}{V_{ref}} - 1 \right) \quad (1)$$

In this example, with $R2 = 130 \text{ k}\Omega$, choose $R1 = 1 \text{ M}\Omega$ to set $V_{POS} = 10.5 \text{ V}$.

8.2.2.1.2 Inverting Converter

The output voltage of the inverting converter stage can also be adjusted with an external resistor divider. It must be connected to the FBN pin. Unlike the feedback divider at the boost converter, the reference point of the feedback divider is not GND but V_{REF} . So the typical value of the voltage at the FBN pin is 0 V. The minimum recommended output voltage at the inverting converter is -15 V . Feedback divider current considerations are similar to the considerations at the boost converter. For the same reasons, the feedback divider current should be in the range of $5 \mu\text{A}$ or greater. The voltage across R4 is 1.213 V . Based on those values, the recommended value for R4 should be lower than $200 \text{ k}\Omega$ to set the divider current at the required value.

Calculate the value of resistor R3, as a function of the needed output voltage (V_{NEG}), with [方程式 2](#):

$$R3 = -R4 \times \left(\frac{V_{NEG}}{V_{ref}} \right) \quad (2)$$

In this example, with $R4 = 121.2 \text{ k}\Omega$, choose $R3 = 1 \text{ M}\Omega$ to set $V_{NEG} = -10 \text{ V}$.

8.2.2.2 Inductor Selection

An inductive converter normally requires two main passive components for storing energy during the conversion. Therefore, each converter requires an inductor and a storage capacitor. In selecting the right inductor, TI recommends keeping the possible peak inductor current below the current limit threshold of the power switch in the chosen configuration. For example, the current limit threshold of the switch for the boost converter and for the inverting converters is nominally 800 mA for the TPS65130 device and 1950 mA for TPS65131 device. The highest peak current through the switches and the inductor depend on the output load, the input voltage (V_{IN}), and the output voltages (V_{POS} , V_{NEG}). Use [方程式 3](#) to estimate the peak inductor current in the boost converter, I_{L_P} . [方程式 4](#) shows the corresponding formula for the inverting converter, I_{L_N} .

$$I_{(L-P)} = \frac{V_{POS}}{V_I \times 0.64} \times I_{POS} \quad (3)$$

$$I_{(L-N)} = \frac{V_I - V_{NEG}}{V_I \times 0.64} \times I_{NEG} \quad (4)$$

The second parameter for choosing the inductor is the desired current ripple in the inductor. Normally, it is advisable to work with a ripple of less than 20% of the average inductor current. A smaller ripple reduces the losses in the inductor, as well as output voltage ripple and EMI. But in the same way, output voltage regulation gets slower, causing greater voltage changes at fast load changes. In addition, a larger inductor usually increases the total system cost. Keep those parameters in mind and calculate the possible inductor value with [方程式 5](#) for the boost converter and [方程式 6](#) for the inverting converter.

$$L1 = \frac{V_I \times (V_{POS} - V_I)}{\Delta I_{(L-P)} \times f \times V_{POS}} \quad (5)$$

$$L2 = \frac{V_I \times V_{NEG}}{\Delta I_{(L-N)} \times f \times (V_{NEG} - V_I)} \quad (6)$$

Parameter f is the switching frequency. For the boost converter, ΔI_{L-P} is the ripple current in the inductor, that is, 20% of I_{L-P} . Accordingly, for the inverting converter, ΔI_{L-N} is the ripple current in the inductor, that is, 20% of I_{L-N} . V_I is the input voltage, which is 3.3 V in this example. So, the calculated inductance value for the boost inductor is 5.1 μ H and for the inverting converter inductor is 5.1 μ H. With these calculated values and the calculated currents, it is possible to choose a suitable inductor.

In typical applications, the recommendation is to choose a 4.7- μ H inductor. The device is optimized to work with inductance values from 3.3 μ H to 6.8 μ H. Nevertheless, operation with greater inductance values may be possible in some applications. Perform detailed stability analysis in this case. Be aware of the possibility that load transients and losses in the circuit can lead to higher currents than estimated in [方程式 3](#) and [方程式 4](#). Also, the losses caused by magnetic hysteresis and conductor resistance are a major parameter for total circuit efficiency.

[表 8-3](#) shows inductors from different suppliers used with the TPS65130/1 converter:

表 8-3. List of Inductors

VENDOR ⁽¹⁾	INDUCTOR SERIES
EPCOS	B8246284-G4
Würth Elektronik	7447789XXX
	744031XXX
TDK	VLF3010
	VLF4012
Cooper Electronics Technologies	SD12

(1) See [Third-party Products Disclaimer](#)

8.2.2.3 Capacitor Selection

8.2.2.3.1 Input Capacitor

As a recommendation, choose an input capacitors of at least 4.7 μ F for the input of the boost converter (INP) and accordingly for the input of the inverting converter (INN). This improves transient behavior of the regulators and EMI behavior of the total power-supply circuit. Choose a ceramic capacitor or a tantalum capacitor. For the use of a tantalum capacitor, an additional, smaller ceramic capacitor (100 nF) in parallel is required. Place the input capacitor(s) close to the input pins..

8.2.2.3.2 Output Capacitors

One of the major parameters necessary to define the capacitance value of the output capacitor is the maximum allowed output voltage ripple of the converter. This ripple is determined by two parameters of the capacitor, the capacitance and the ESR. It is possible to calculate the minimum capacitance needed for the defined ripple, supposing that the ESR is zero. Use [方程式 7](#) for the boost converter output capacitor (C_{4min}) and [方程式 8](#) for the inverting converter output capacitor (C_{5min}).

$$C_{4min} = \frac{I_{POS} \times (V_{POS} - V_I)}{f \times \Delta V_{POS} \times V_{POS}} \quad (7)$$

$$C_{5min} = \frac{I_{NEG} \times V_{NEG}}{f \times \Delta V_{NEG} \times (V_{NEG} - V_I)} \quad (8)$$

The parameter f is the switching frequency. ΔV_{POS} and ΔV_{NEG} are the maximum allowed ripple voltages for each converter. Choosing a ripple voltage in the range of 10 mV requires a minimum capacitance of 12 μ F. The total ripple is larger due to the ESR of the output capacitor. Use [方程式 9](#) for the boost converter and [方程式 10](#) for the inverting converter to calculate this additional ripple component.

$$\Delta V_{(ESR-P)} = I_{POS} \times R_{(ESR-C4)} \quad (9)$$

$$\Delta V_{(ESR-N)} = I_{NEG} \times R_{(ESR-C5)} \quad (10)$$

In this example, an additional ripple of 2 mV is the result of using a typical ceramic capacitor with an ESR in the 10-mΩ range. The total ripple is the sum of the ripple caused by the capacitance and the ripple caused by the ESR of the capacitor. In this example, the total ripple is 10 mV.

Load transients can create additional ripple. When the load current increases rapidly, the output capacitor must provide the additional current until the inductor current increases by the control loop which sets a higher ON-time (duty cycle) of the main switch. The higher duty cycle results in longer inductor charging periods. The inductance itself also limits the rate of increase of the inductor current. When the load current decreases rapidly, the output capacitor must store the excess energy (stored in the inductor) until the regulator has decreased the inductor current by reducing the duty cycle. TI recommends using greater capacitance values, as the foregoing calculations show.

8.2.2.4 Rectifier Diode Selection

Both converters (the boost and inverting converter) require rectifier diodes, D1 and D2. As a recommendation, to reduce losses, use Schottky diodes. The forward current rating needed is equal to the maximum output current. Consider that the maximum currents, I_{POSmax} and I_{NEGmax} , might differ for V_{POS} and V_{NEG} when choosing the diodes.

8.2.2.5 External PMOS Selection

During shutdown, when connected to a power supply, a path from the power supply to the positive output conducts through the inductor and an external diode. Optionally, to fully disconnect the positive output V_{POS} during shutdown, add an external PMOS (Q1). The BSW pin controls the gate of the PMOS. When choosing a proper PMOS, the V_{GS} and V_{GD} voltage ratings must cover the input voltage range, the drain current rating must not be lower than the maximum input current flowing into the application, and conditions of the PMOS operating area must fit.

If there is no intention to use an external PMOS, leave the BSW pin floating.

8.2.2.6 Stabilizing the Control Loop

8.2.2.6.1 Feedforward Capacitor

As a recommendation, to speed up the control loop, place feedforward capacitors in the feedback divider, parallel to R1 (boost converter) and R3 (inverting converter). [方程式 11](#) shows how to calculate the appropriate value for the boost converter, and [方程式 12](#) for the inverting converter.

$$C9 = \frac{6.8 \mu s}{R1} \quad (11)$$

$$C10 = \frac{7.5 \mu s}{R3} \quad (12)$$

To avoid coupling noise into the control loop from the feedforward capacitors, the feedforward effect can be bandwidth-limited by adding a series resistor. Any value from 10 kΩ to 100 kΩ is suitable. The greater the resistance, the lower the noise coupled into the control loop system.

8.2.2.6.2 Compensation Capacitors

The device features completely internally compensated control loops for both converters. The internal feedforward system has built-in error correction which requires external capacitors. As a recommendation, use a 10-nF capacitor at the CP pin of the boost converter and a 4.7-nF capacitor at the CN pin of the inverting converter.

8.2.3 Analog Supply Filter

To ensure a noise free voltage supply of the IC, it is recommended to add an RC or LC filter between INN and VIN pins.

8.2.3.1 RC-Filter

For most applications an RC filter can be used with a resistance value of 100 Ω minimum and capacitor value of 0.1 μF as in the application example [图 8-1](#).

8.2.3.2 LC-Filter

For applications where input voltages V_I with a fast rising edge (slew rate $\geq 275 \text{ mV}/\mu\text{s}$) are expected, it is recommended to replace the resistor R7 with a ferrite bead to minimize the delay between the signals on the INN pin and VIN pin. Select a ferrite bead with the lowest possible DCR and a proper current rating, such as BLM18KG101TN1 for example. A conservative approach for the current rating specification is to set it at 1.5 times or twice the maximum input current.

表 8-4. List of Ferrite Beads

VENDOR	FERRITE BEAD SERIES
Murata	BLMxKG

8.2.4 Application Curves

表 8-5. Table of Figures

FIGURE	DESCRIPTION
图 8-2	TPS65130 efficiency versus output current, $V_{\text{POS}} = 5 \text{ V}$
图 8-3	TPS65131 efficiency versus output current, $V_{\text{POS}} = 5 \text{ V}$
图 8-4	TPS65130 efficiency versus output current, $V_{\text{POS}} = 8 \text{ V}$
图 8-5	TPS65131 efficiency versus output current, $V_{\text{POS}} = 10 \text{ V}$
图 8-6	TPS65130 efficiency versus output current, $V_{\text{POS}} = 12 \text{ V}$
图 8-7	TPS65131 efficiency versus output current, $V_{\text{POS}} = 15 \text{ V}$
图 8-8	TPS65130 efficiency versus output current, $V_{\text{NEG}} = -4 \text{ V}$, ($V_{\text{IN}} = 4 \text{ V}, 3 \text{ V}$)
图 8-9	TPS65131 efficiency versus output current, $V_{\text{NEG}} = -4 \text{ V}$, ($V_{\text{IN}} = 5 \text{ V}, 3 \text{ V}$)
图 8-10	TPS65130 efficiency versus output current, $V_{\text{NEG}} = -8 \text{ V}$, ($V_{\text{IN}} = 4.2 \text{ V}, 3 \text{ V}$)
图 8-11	TPS65131 efficiency versus output current, $V_{\text{NEG}} = -10 \text{ V}$, ($V_{\text{IN}} = 5 \text{ V}, 3 \text{ V}$)
图 8-12	TPS65130 efficiency versus output current, $V_{\text{NEG}} = -10 \text{ V}$, ($V_{\text{IN}} = 4.2 \text{ V}, 3 \text{ V}$)
图 8-13	TPS65131 efficiency versus output current, $V_{\text{NEG}} = -15 \text{ V}$, ($V_{\text{IN}} = 5 \text{ V}, 3 \text{ V}$)
图 8-14	TPS65130 efficiency versus input voltage, $V_{\text{POS}} = 5 \text{ V}$ in power-save mode
图 8-15	TPS65130 efficiency versus input voltage, $V_{\text{POS}} = 8 \text{ V}$ in power-save mode
图 8-16	TPS65130 efficiency versus input voltage, $V_{\text{POS}} = 12 \text{ V}$ in power-save mode
图 8-17	TPS65130 efficiency versus input voltage, $V_{\text{NEG}} = -4 \text{ V}$ in power-save mode
图 8-18	TPS65130 efficiency versus input voltage, $V_{\text{NEG}} = -8 \text{ V}$ in power-save mode
图 8-19	TPS65130 efficiency versus input voltage, $V_{\text{NEG}} = -10 \text{ V}$ in power-save mode
图 8-20	TPS65130 efficiency versus output current, $V_{\text{O}} = 13.5 \text{ V}$ ($+9 \text{ V}, -4.5 \text{ V}$), ($V_{\text{IN}} = 4.2 \text{ V}, 3 \text{ V}$)
图 8-21	TPS65131 efficiency versus output current, $V_{\text{O}} = 30 \text{ V}$ ($\pm 15 \text{ V}$), ($V_{\text{IN}} = 5 \text{ V}, 3 \text{ V}$)
图 8-22	TPS65130 efficiency versus input voltage, $V_{\text{O}} = 13.5 \text{ V}$ ($9 \text{ V}, -4.5 \text{ V}$) in power save mode
图 8-23	TPS65130 output voltage versus output current, $V_{\text{POS}} = 5 \text{ V}$, $V_{\text{IN}} = 3 \text{ V}$
图 8-24	TPS65131 output voltage versus output current, $V_{\text{POS}} = 5 \text{ V}$, $V_{\text{IN}} = 4.2 \text{ V}$
图 8-25	TPS65130 output voltage versus output current, $V_{\text{POS}} = 8 \text{ V}$, $V_{\text{IN}} = 3 \text{ V}$
图 8-26	TPS65131 output voltage versus output current, $V_{\text{POS}} = 10 \text{ V}$, $V_{\text{IN}} = 5 \text{ V}$
图 8-27	TPS65130 output voltage versus output current, $V_{\text{POS}} = 12 \text{ V}$ ($V_{\text{IN}} = 3 \text{ V}$)
图 8-28	TPS65131 output voltage versus output current, $V_{\text{POS}} = 15 \text{ V}$ ($V_{\text{IN}} = 5 \text{ V}$)
图 8-29	TPS65130 output voltage versus output current, $V_{\text{NEG}} = -4 \text{ V}$, $V_{\text{IN}} = 3 \text{ V}$
图 8-30	TPS65131 output voltage versus output current, $V_{\text{NEG}} = -4 \text{ V}$, $V_{\text{IN}} = 5 \text{ V}$

表 8-5. Table of Figures (continued)

FIGURE	DESCRIPTION
图 8-31	TPS65130 output voltage versus output current, $V_{NEG} = -8\text{ V}$, $V_{IN} = 3\text{ V}$
图 8-32	TPS65131 output voltage versus output current, $V_{NEG} = -10\text{ V}$, $V_{IN} = 5\text{ V}$
图 8-33	TPS65130 output voltage versus output current, $V_{NEG} = -10\text{ V}$, $V_{IN} = 3\text{ V}$
图 8-34	TPS65131 output voltage versus output current, $V_{NEG} = -15\text{ V}$, $V_{IN} = 5\text{ V}$
图 8-35	Positive output voltage in continuous current mode
图 8-36	Negative output voltage in continuous current mode
图 8-37	Positive output voltage at power-save mode disabled
图 8-38	Negative output voltage at power-save mode disabled
图 8-39	Positive output voltage in power-save mode, $V_I = 3.6\text{ V}$, $V_{POS} = 5.5\text{ V}$
图 8-40	Negative output voltage in power-save mode, $V_I = 3.6\text{ V}$, $V_{NEG} = -8\text{ V}$
图 8-41	Load transient response, $V_I = 3.6\text{ V}$, $V_{POS} = 8\text{ V}$
图 8-42	Load transient response, $V_I = 3.6\text{ V}$, $V_{NEG} = -8\text{ V}$
图 8-43	Line transient response, $V_I = 3.6\text{ V}$ to 4.2 V , $V_{POS} = 8\text{ V}$
图 8-44	Line transient response, $V_I = 3.6\text{ V}$ to 4.2 V , $V_{NEG} = -8\text{ V}$
图 8-45	Start-up after enable, $V_{POS} = 8\text{ V}$, $V_I = 3.6\text{ V}$
图 8-46	Start-up after enable, $V_{NEG} = -8\text{ V}$, $V_I = 3.6\text{ V}$



图 8-2. TPS65130 Efficiency vs Output Current



图 8-3. TPS65131 Efficiency vs Output Current

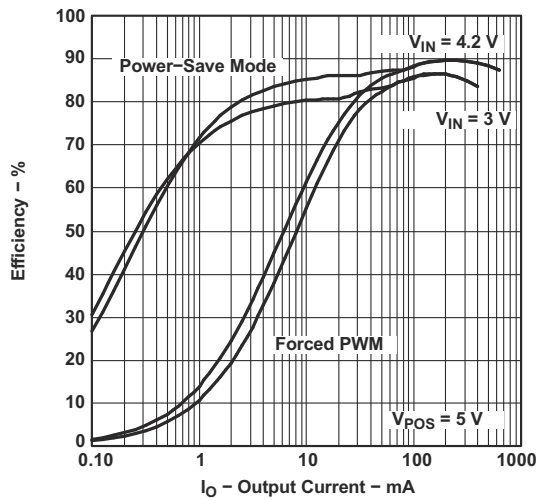

图 8-4. TPS65130 Efficiency vs Output Current

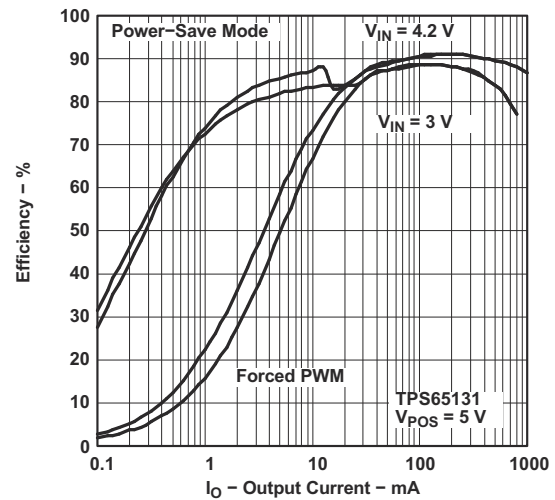

图 8-5. TPS65131 Efficiency vs Output Current

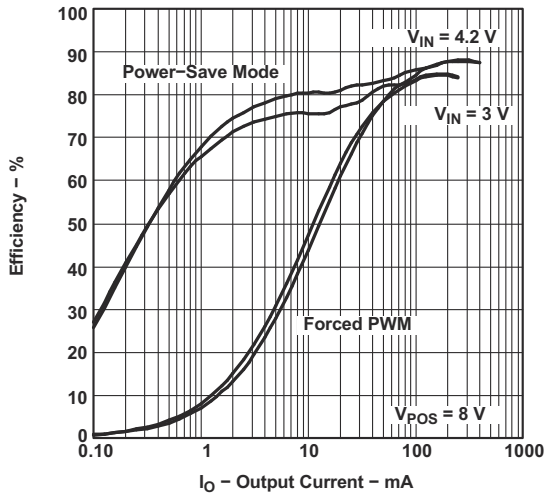

图 8-6. TPS65130 Efficiency vs Output Current

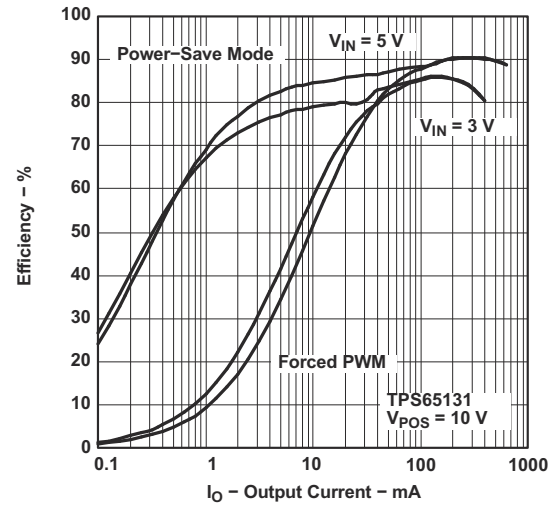

图 8-7. TPS65131 Efficiency vs Output Current

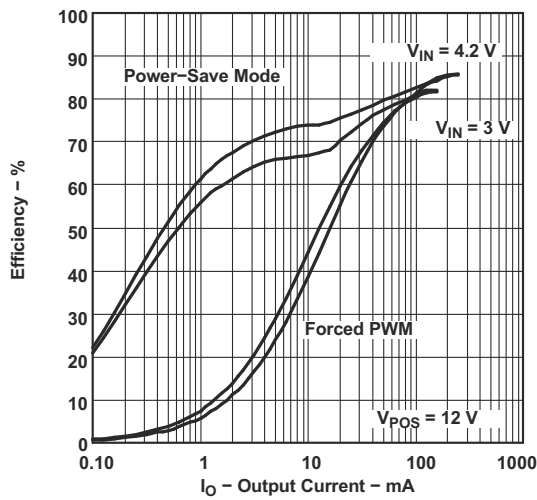

图 8-8. TPS65130 Efficiency vs Output Current

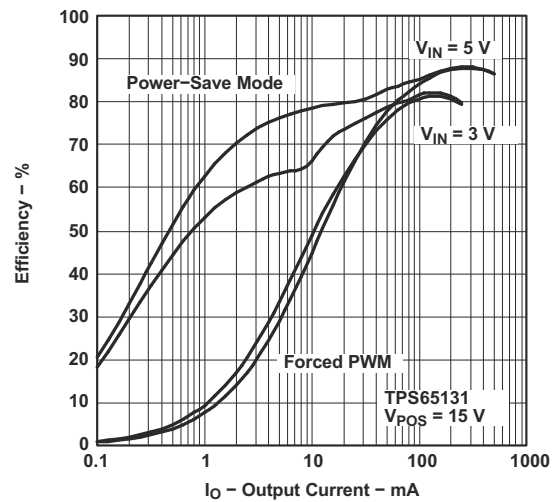

图 8-9. TPS65131 Efficiency vs Output Current

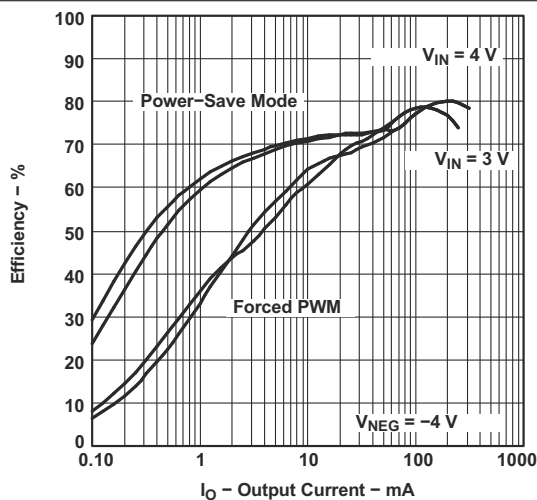

图 8-10. TPS65130 Efficiency vs Output Current

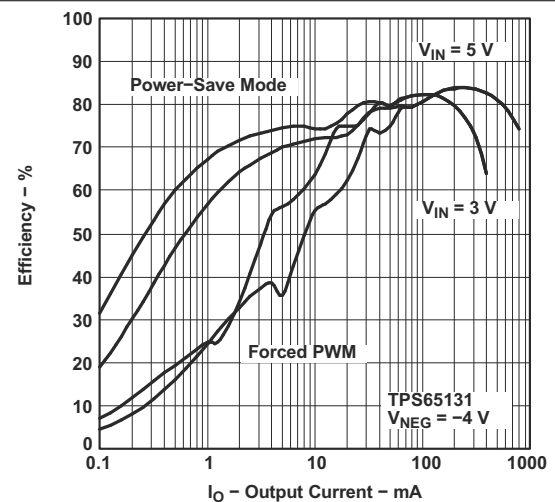

图 8-11. TPS65131 Efficiency vs Output Current

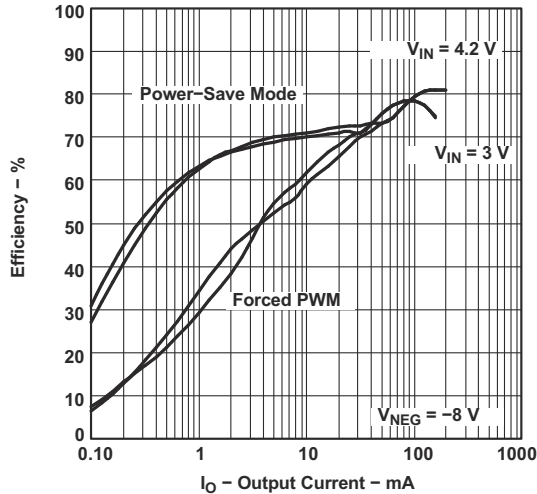

图 8-12. TPS65130 Efficiency vs Output Current

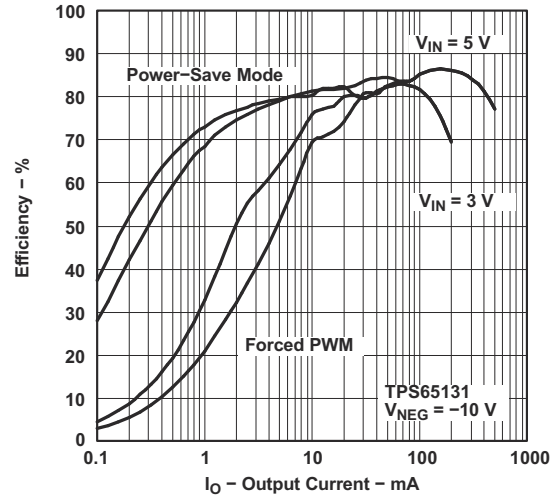

图 8-13. TPS65131 Efficiency vs Output Current

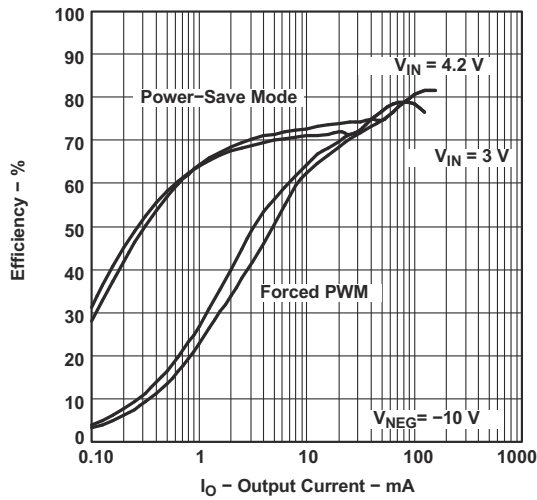

图 8-14. TPS65130 Efficiency vs Input Voltage

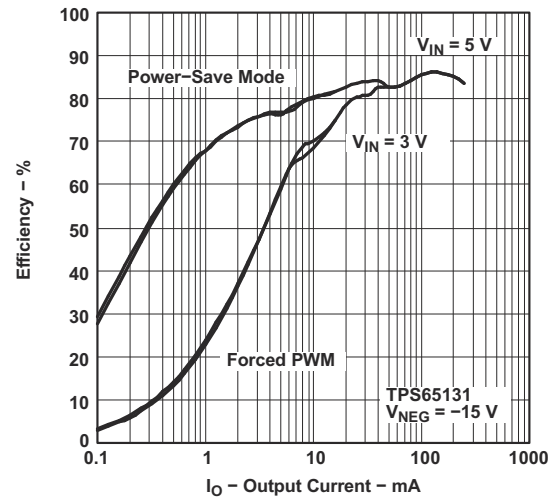

图 8-15. TPS65130 Efficiency vs Input Voltage

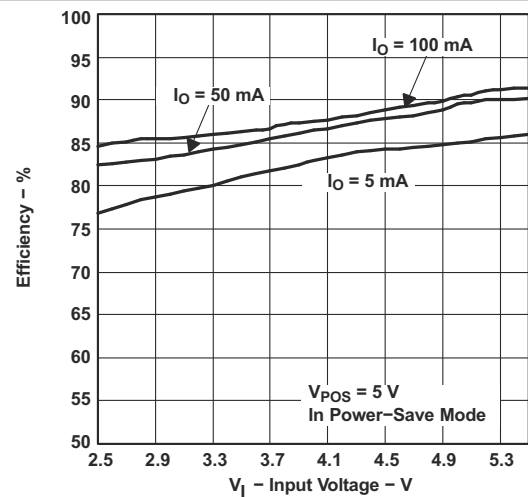

图 8-16. TPS65130 Efficiency vs Input Voltage

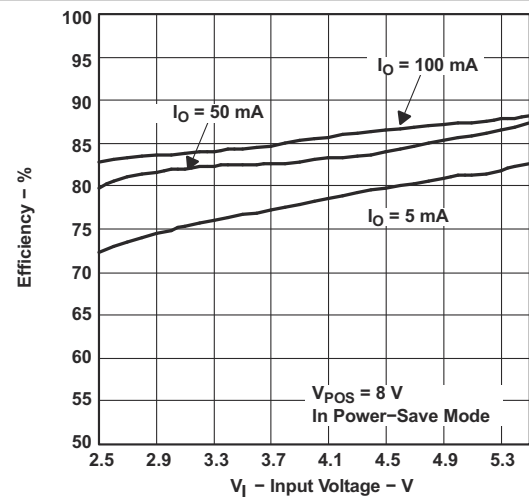

图 8-17. TPS65130 Efficiency vs Input Voltage

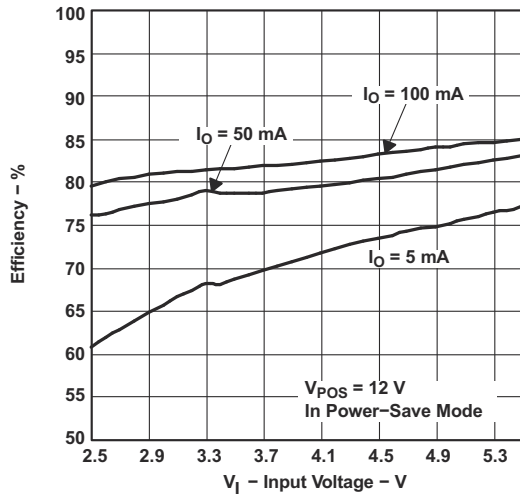

图 8-18. TPS65130 Efficiency vs Input Voltage

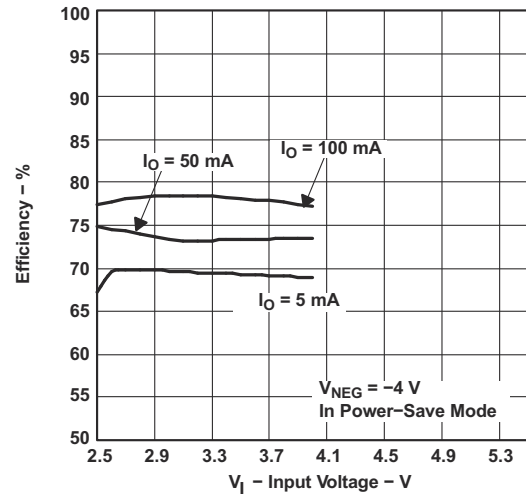

图 8-19. TPS65130 Efficiency vs Input Voltage

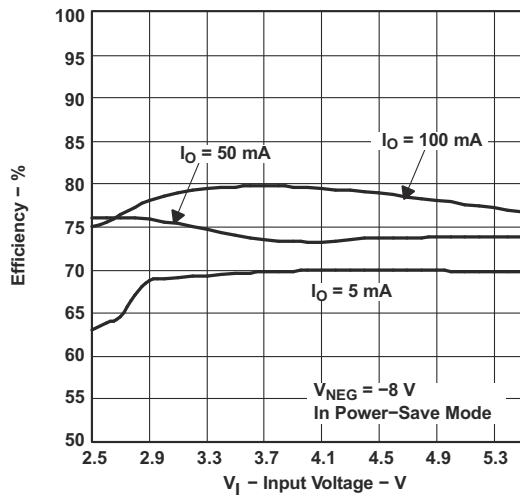

图 8-20. TPS65130 Combined Efficiency vs Output Current

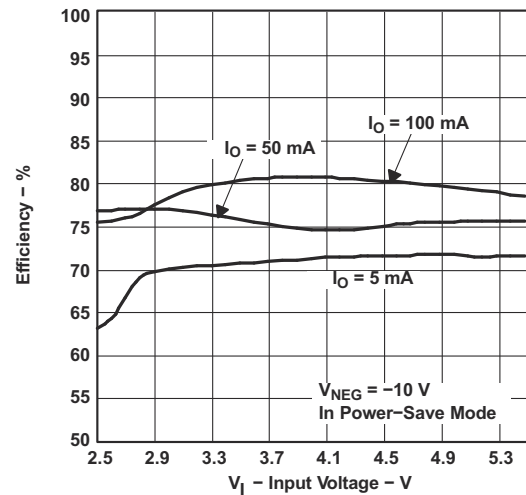

图 8-21. TPS65131 Combined Efficiency vs Output Current

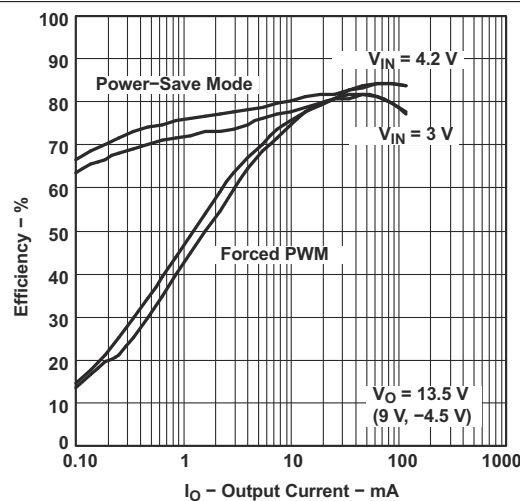

图 8-22. TPS65130 Combined Efficiency vs Input Voltage

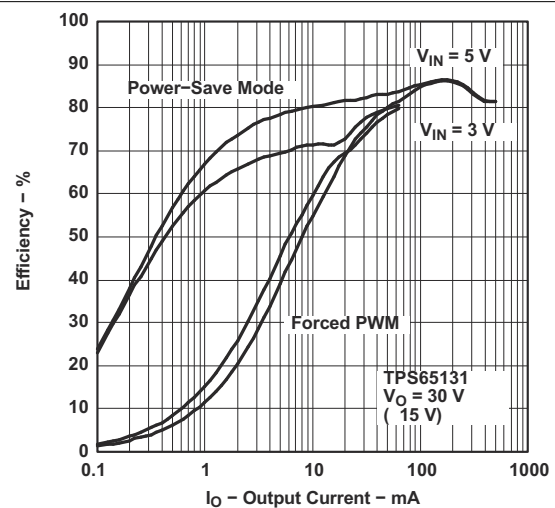

图 8-23. TPS65130 Output Voltage vs Output Current

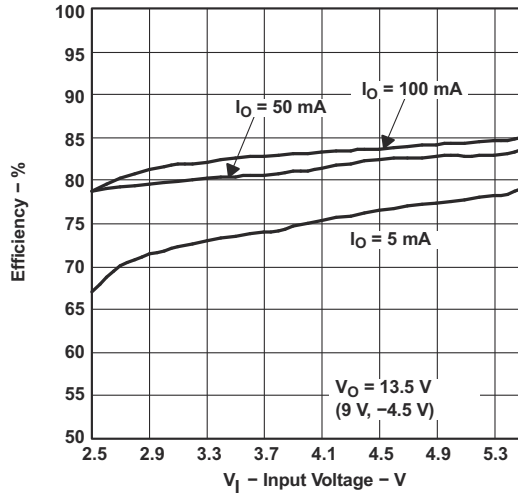

图 8-24. TPS65131 Output Voltage vs Output Current

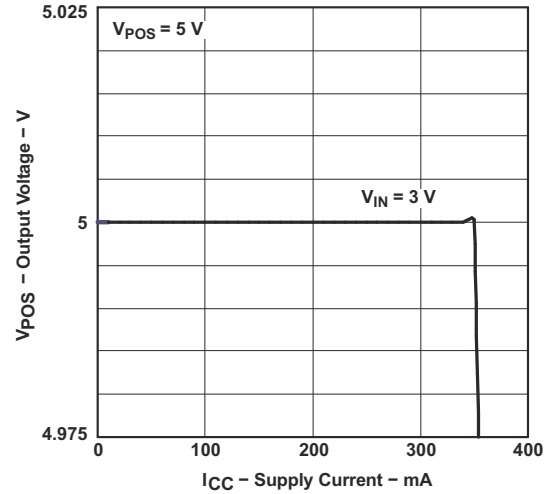

图 8-25. TPS65130 Output Voltage vs Output Current

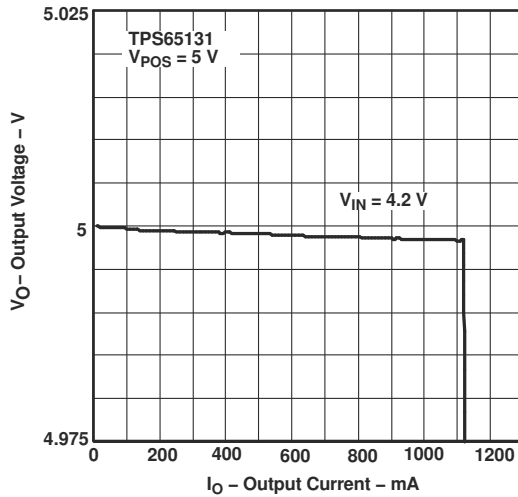

图 8-26. TPS65131 Output Voltage vs Output Current

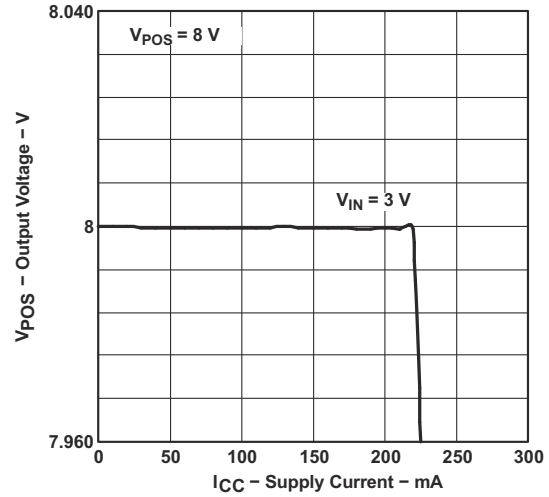

图 8-27. TPS65130 Output Voltage vs Output Current

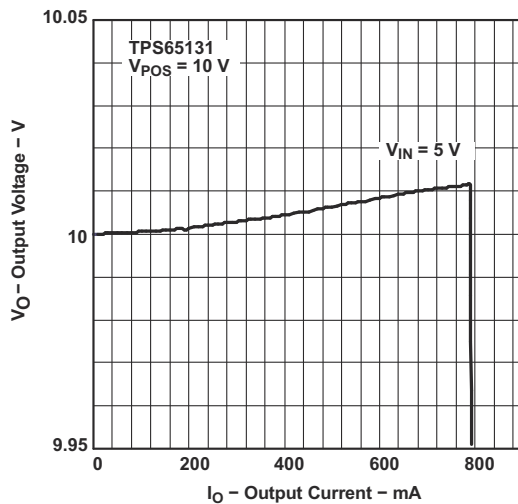

图 8-28. TPS65131 Output Voltage vs Output Current

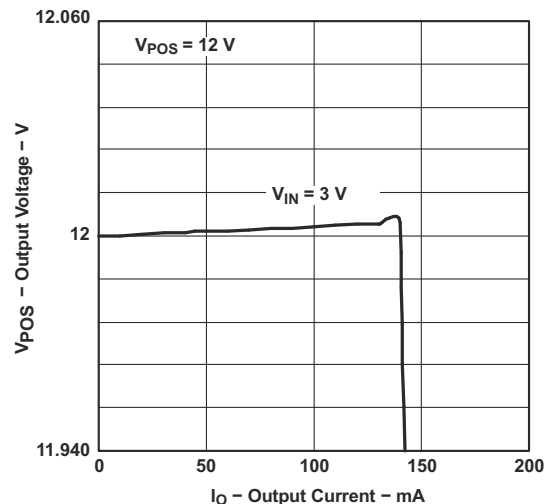

图 8-29. TPS65130 Output Voltage vs Output Current

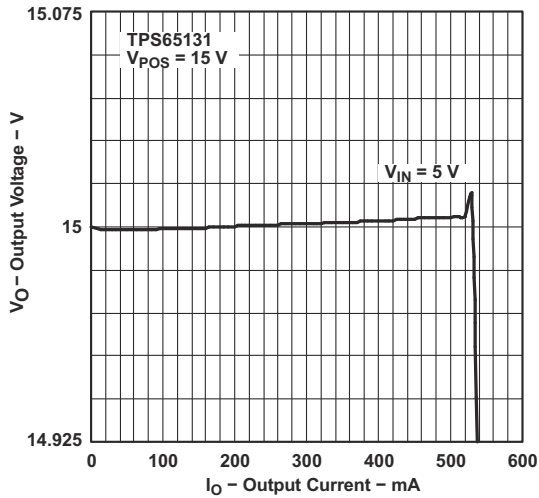

图 8-30. TPS65131 Output Voltage vs Output Current

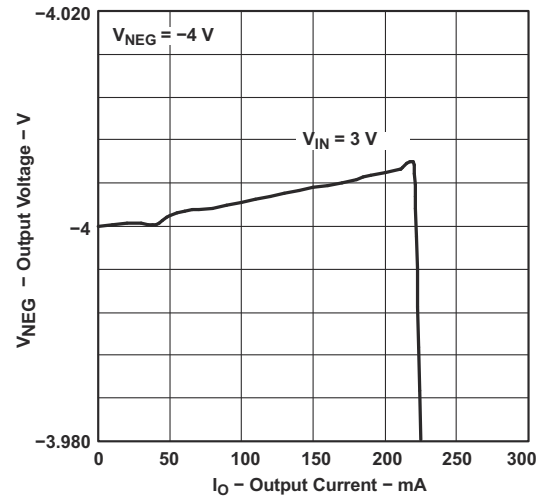

图 8-31. TPS65130 Output Voltage vs Output Current

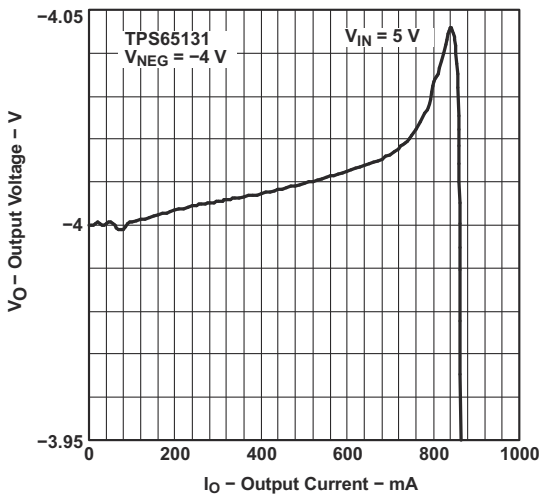

图 8-32. TPS65131 Output Voltage vs Output Current

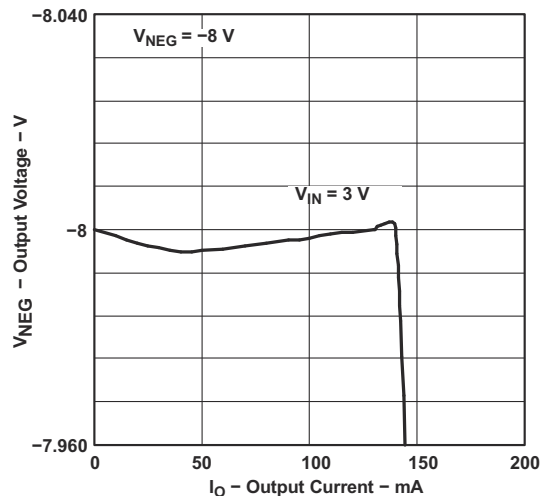

图 8-33. TPS65130 Output Voltage vs Output Current

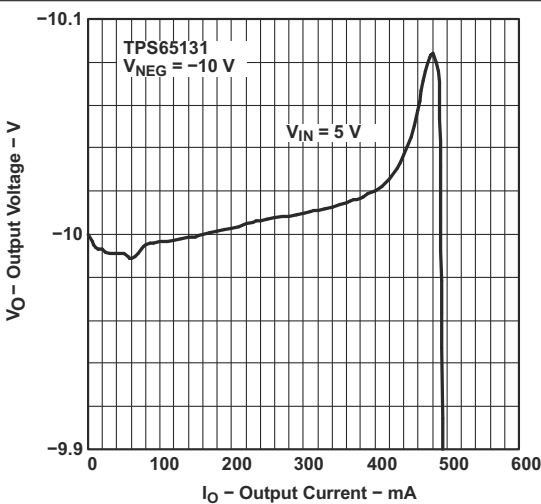

图 8-34. TPS65131 Output Voltage vs Output Current

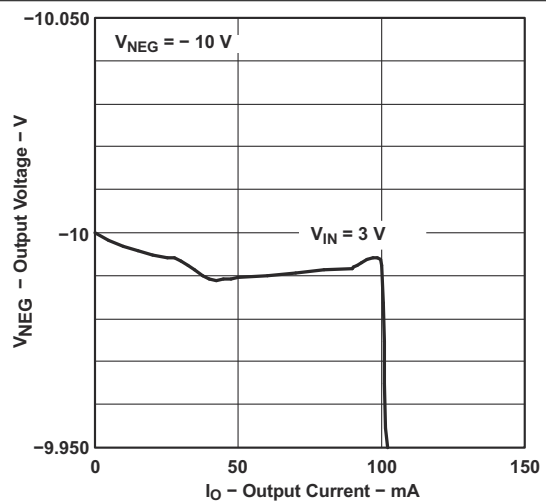

图 8-35. V_{POS} in Continuous Current Mode

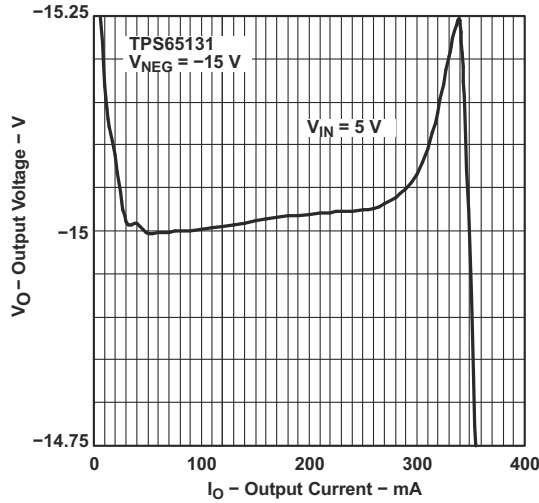

图 8-36. V_{NEG} in Continuous Current Mode

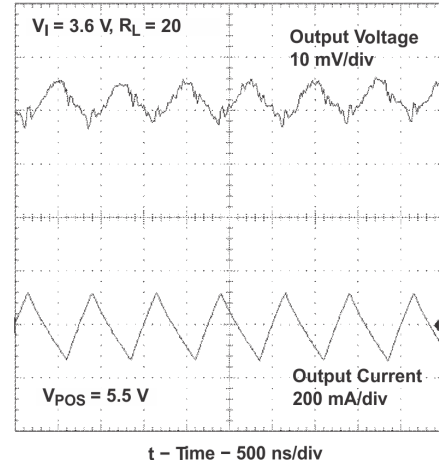

图 8-37. V_{POS} at Power-Save Mode Disabled

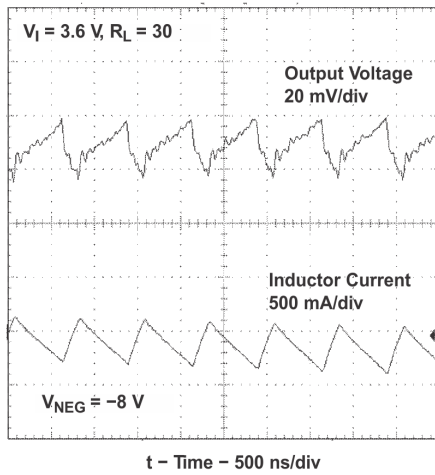

图 8-38. V_{NEG} at Power-Save Mode Disabled

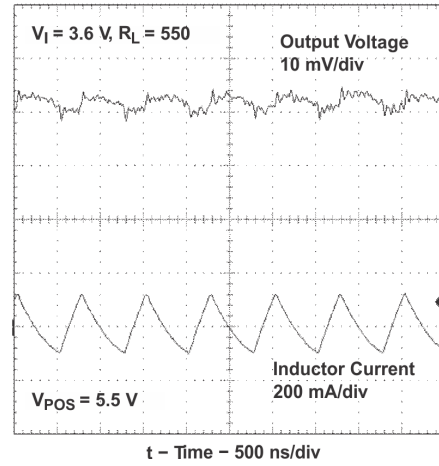

图 8-39. V_{POS} in Power-Save Mode

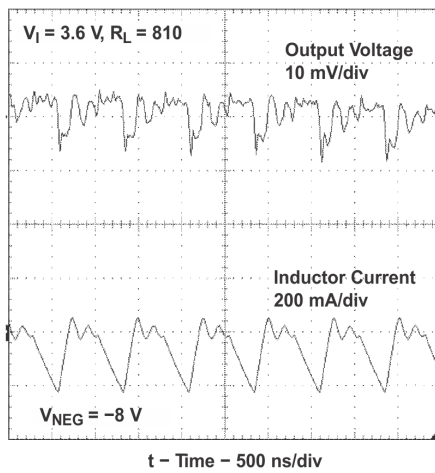

图 8-40. V_{NEG} in Power-Save Mode

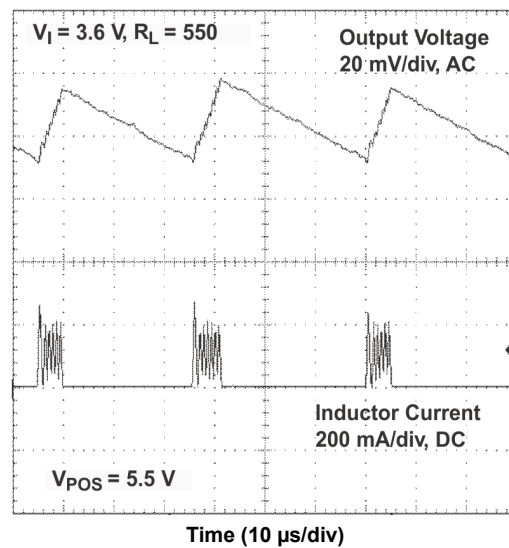

图 8-41. Load Transient Response

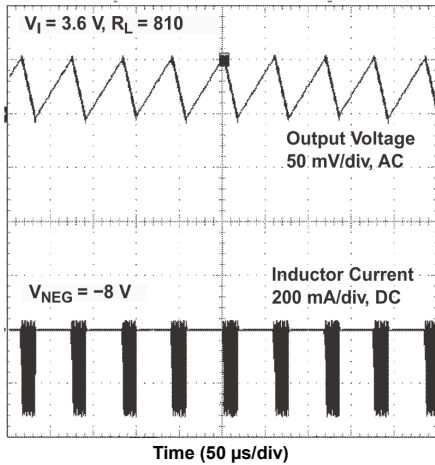

图 8-42. Load Transient Response

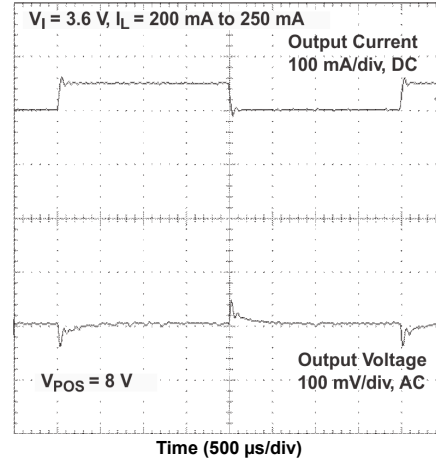

图 8-43. Line Transient Response

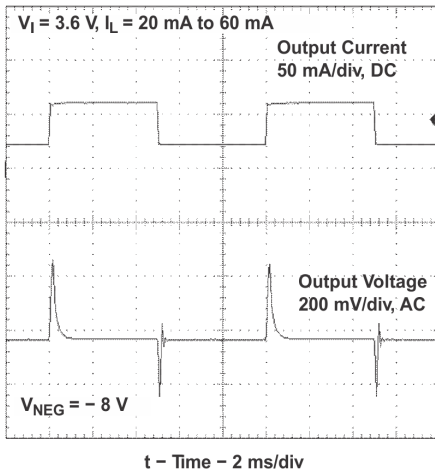

图 8-44. Line Transient Response

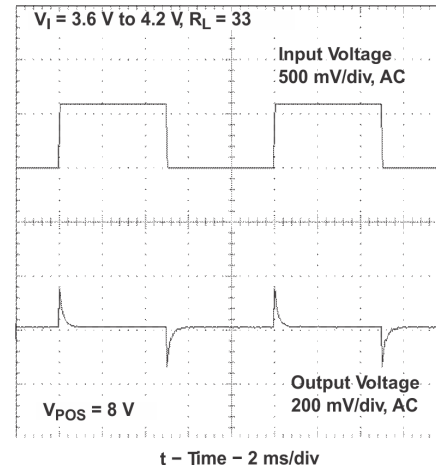

图 8-45. Start-up After Enable

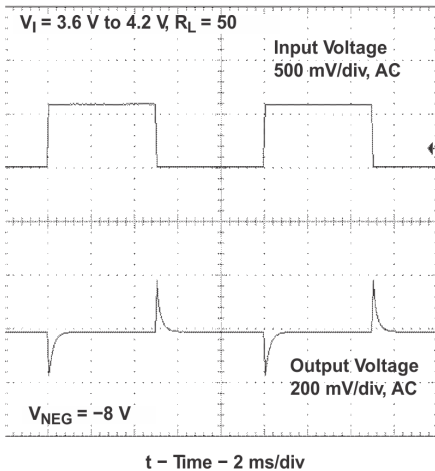

图 8-46. Start-up After Enable

Power Supply Recommendations

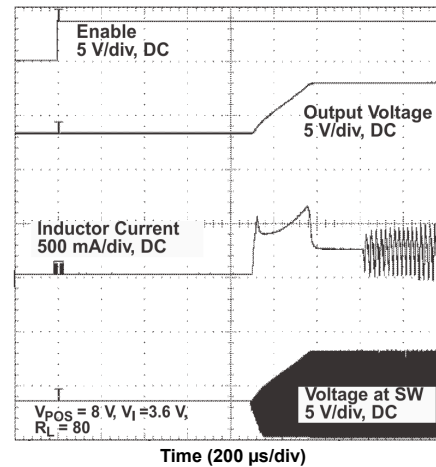
The input voltage ranges from 2.7 V to 5.5 V for the TPS6513x. Consequently, the supply can come, for example, from a 3.3-V or 5-V rail. If the device starts into load during the soft-start phase, the drawn input current can be higher than during post-start operation. Consider the application requirements when selecting the power supply. To avoid unintended toggling of the undervoltage lockout protection, connect the TPS6513x device through a low-impedance path to the power supply.

9 Layout

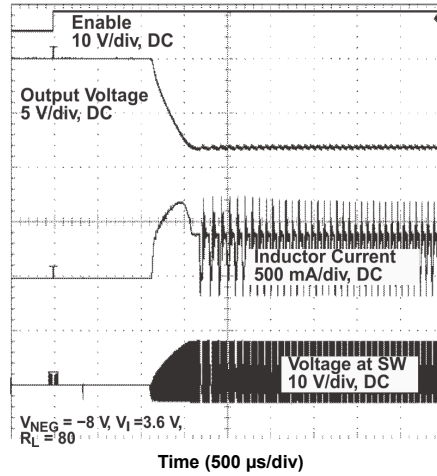
9.1 Layout Guidelines

As for all switching power supplies, the layout is an important step in the design, especially at high peak currents and high switching frequencies. Improper layout might show the symptoms of poor line or load regulation, ground and output voltage shifts, stability issues, unsatisfying EMI behavior or worsened efficiency. Therefore, use wide and short traces for the main current paths and for the power ground tracks. The input capacitors (C1, C2, C3), output capacitors (C4, C5), the inductors (L1, L2), and the rectifying diodes (D1, D2) should be placed as close as possible to the IC to keep parasitic inductances low. Use a wide power ground (PGND) plane. Connect the analog ground pin (AGND) to the PGND plane. Further, connect the PGND plane with the exposed thermal pad. Place the feedback dividers as close as possible to the control pin (boost converter) or the VREF pin (inverting converter) of the IC.

9.2 Layout Example



图 9-1. Layout Recommendation (TPS65130 and TPS65131)

9.3 Thermal Considerations

Implementation of integrated circuits in low-profile and fine-pitch surface-mount packages typically requires special attention to power dissipation. Many system-dependent issues, such as thermal coupling, airflow, added heatsinks and convection surfaces, and the presence of heat-generating components affect the power-dissipation limits of a given component.

These three basic approaches enhance thermal performance:

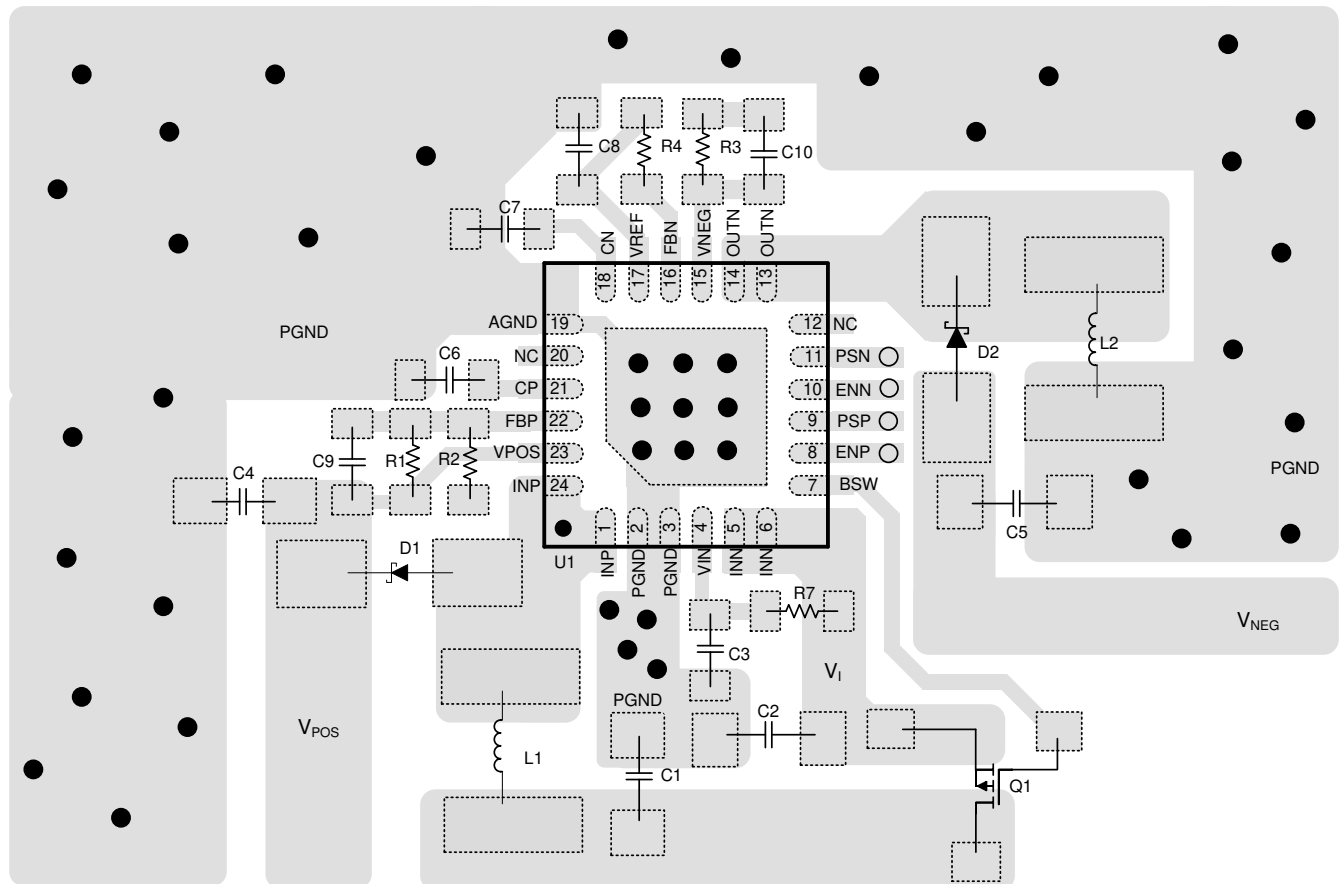
- Improving the power dissipation capability of the PCB design.
- Improving the thermal coupling of the component to the PCB.
- Introducing airflow to the system.

The recommended device junction temperature range, T_J , is -40°C to 125°C . The thermal resistance of the 24-pin QFN, $4\text{-mm} \times 4\text{-mm}$ package (RGE) is $R_{\theta JA} = 34.1^{\circ}\text{C/W}$. The recommended operating ambient temperature range for the device is $T_A = -40^{\circ}\text{C}$ to 85°C . Use [方程式 13](#) to calculate the maximum power dissipation, $P_{D\text{max}}$, as a function of T_A . In this equation, use $T_J = 125^{\circ}\text{C}$ to operate the device within the recommended temperature range, use $T_J = T_{TS}$ to determine the absolute maximum threshold when the device might go into thermal shutdown. If the maximum ambient temperature of the application is lower, more heat dissipation is possible.

$$P_{D\text{max}} = \frac{T_J - T_A}{R_{\theta JA}} \quad (13)$$

10 Device and Documentation Support

10.1 Device Support

10.2 接收文档更新通知

要接收文档更新通知，请导航至 ti.com 上的器件产品文件夹。点击 [订阅更新](#) 进行注册，即可每周接收产品信息更改摘要。有关更改的详细信息，请查看任何已修订文档中包含的修订历史记录。

10.3 支持资源

[TI E2E™ 支持论坛](#) 是工程师的重要参考资料，可直接从专家获得快速、经过验证的解答和设计帮助。搜索现有解答或提出自己的问题可获得所需的快速设计帮助。

链接的内容由各个贡献者“按原样”提供。这些内容并不构成 TI 技术规范，并且不一定反映 TI 的观点；请参阅 TI 的《[使用条款](#)》。

10.4 Trademarks

TI E2E™ is a trademark of Texas Instruments.
所有商标均为其各自所有者的财产。

10.5 Electrostatic Discharge Caution



This integrated circuit can be damaged by ESD. Texas Instruments recommends that all integrated circuits be handled with appropriate precautions. Failure to observe proper handling and installation procedures can cause damage.

ESD damage can range from subtle performance degradation to complete device failure. Precision integrated circuits may be more susceptible to damage because very small parametric changes could cause the device not to meet its published specifications.

10.6 术语表

[TI 术语表](#) 本术语表列出并解释了术语、首字母缩略词和定义。

11 Mechanical, Packaging, and Orderable Information

The following pages include mechanical, packaging, and orderable information. This information is the most current data available for the designated devices. This data is subject to change without notice and revision of this document. For browser-based versions of this data sheet, refer to the left-hand navigation.

TAPE AND REEL INFORMATION

QUADRANT ASSIGNMENTS FOR PIN 1 ORIENTATION IN TAPE

*All dimensions are nominal

Device	Package Type	Package Drawing	Pins	SPQ	Reel Diameter (mm)	Reel Width W1 (mm)	A0 (mm)	B0 (mm)	K0 (mm)	P1 (mm)	W (mm)	Pin1 Quadrant
TPS65130RGER	VQFN	RGE	24	3000	330.0	12.4	4.25	4.25	1.15	8.0	12.0	Q2
TPS65130RGET	VQFN	RGE	24	250	180.0	12.4	4.25	4.25	1.15	8.0	12.0	Q2
TPS65131RGER	VQFN	RGE	24	3000	330.0	12.4	4.25	4.25	1.15	8.0	12.0	Q2
TPS65131RGET	VQFN	RGE	24	250	180.0	12.4	4.25	4.25	1.15	8.0	12.0	Q2

TAPE AND REEL BOX DIMENSIONS



*All dimensions are nominal

Device	Package Type	Package Drawing	Pins	SPQ	Length (mm)	Width (mm)	Height (mm)
TPS65130RGER	VQFN	RGE	24	3000	346.0	346.0	33.0
TPS65130RGET	VQFN	RGE	24	250	210.0	185.0	35.0
TPS65131RGER	VQFN	RGE	24	3000	552.0	346.0	36.0
TPS65131RGET	VQFN	RGE	24	250	552.0	185.0	36.0

TUBE

*All dimensions are nominal

Device	Package Name	Package Type	Pins	SPQ	L (mm)	W (mm)	T (μm)	B (mm)
TPS65131RGER	RGE	VQFN	24	3000	381	5.79	2286	0
TPS65131RGERG4	RGE	VQFN	24	3000	381	5.79	2286	0
TPS65131RGET	RGE	VQFN	24	250	381	5.79	2286	0
TPS65131RGETG4	RGE	VQFN	24	250	381	5.79	2286	0

GENERIC PACKAGE VIEW

RGE 24

VQFN - 1 mm max height

PLASTIC QUAD FLATPACK - NO LEAD

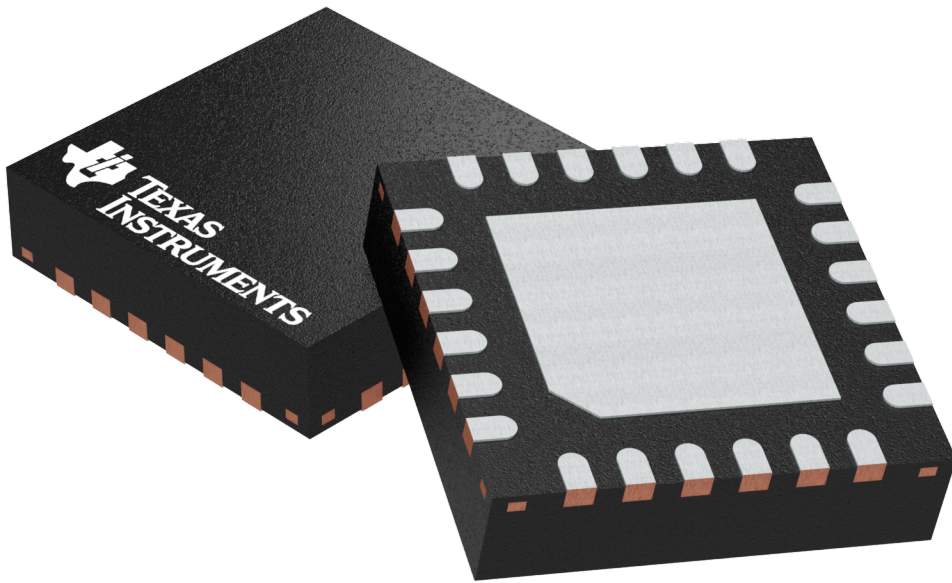

Images above are just a representation of the package family, actual package may vary.
Refer to the product data sheet for package details.

4204104/H

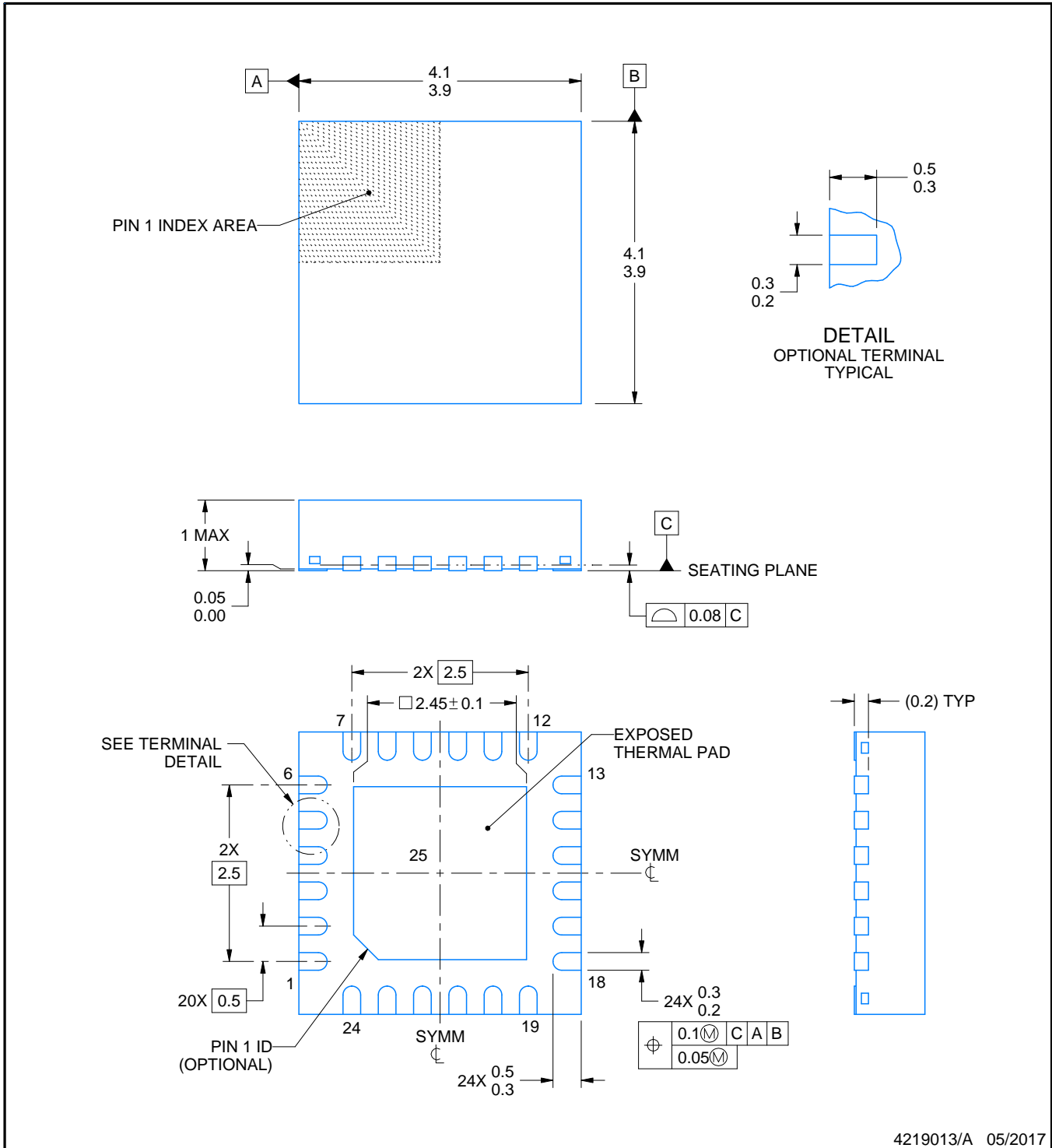

NOTES:

1. All linear dimensions are in millimeters. Any dimensions in parenthesis are for reference only. Dimensioning and tolerancing per ASME Y14.5M.
2. This drawing is subject to change without notice.
3. The package thermal pad must be soldered to the printed circuit board for thermal and mechanical performance.

EXAMPLE BOARD LAYOUT

RGE0024B

VQFN - 1 mm max height

PLASTIC QUAD FLATPACK - NO LEAD

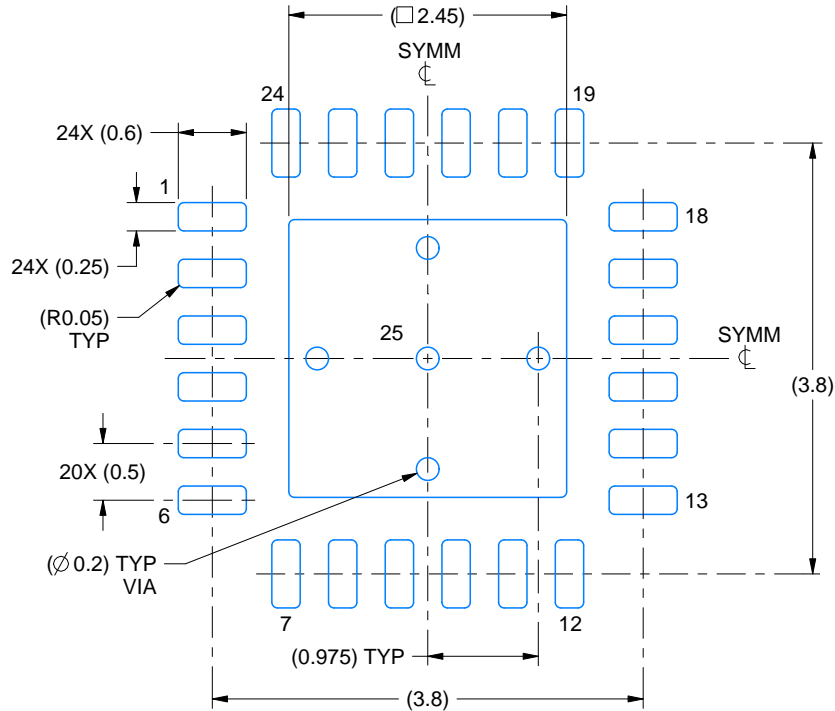

LAND PATTERN EXAMPLE
EXPOSED METAL SHOWN
SCALE:15X



SOLDER MASK DETAILS

4219013/A 05/2017

NOTES: (continued)

- This package is designed to be soldered to a thermal pad on the board. For more information, see Texas Instruments literature number SLUA271 (www.ti.com/lit/slua271).
- Vias are optional depending on application, refer to device data sheet. If any vias are implemented, refer to their locations shown on this view. It is recommended that vias under paste be filled, plugged or tented.

EXAMPLE STENCIL DESIGN

RGE0024B

VQFN - 1 mm max height

PLASTIC QUAD FLATPACK - NO LEAD

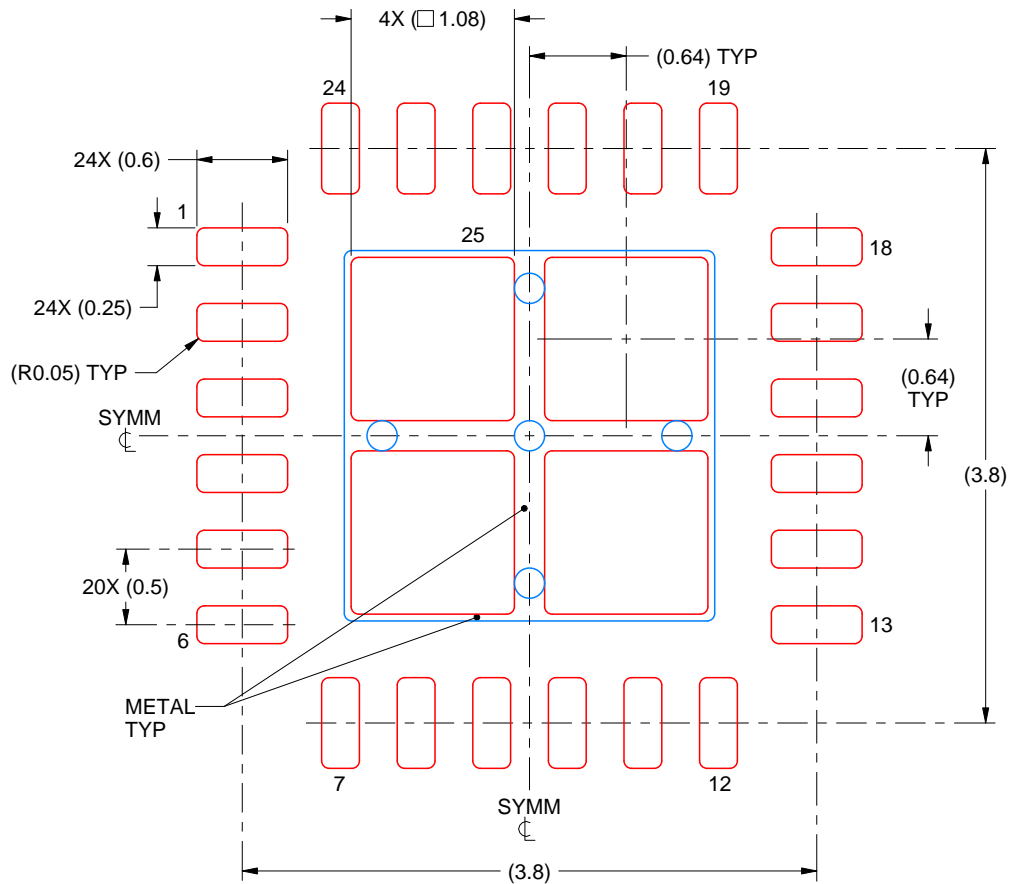

SOLDER PASTE EXAMPLE
 BASED ON 0.125 mm THICK STENCIL

EXPOSED PAD 25
 78% PRINTED SOLDER COVERAGE BY AREA UNDER PACKAGE
 SCALE:20X

4219013/A 05/2017

NOTES: (continued)

6. Laser cutting apertures with trapezoidal walls and rounded corners may offer better paste release. IPC-7525 may have alternate design recommendations.

重要声明和免责声明

TI“按原样”提供技术和可靠性数据（包括数据表）、设计资源（包括参考设计）、应用或其他设计建议、网络工具、安全信息和其他资源，不保证没有瑕疵且不做任何明示或暗示的担保，包括但不限于对适销性、某特定用途方面的适用性或不侵犯任何第三方知识产权的暗示担保。

这些资源可供使用 TI 产品进行设计的熟练开发人员使用。您将自行承担以下全部责任：(1) 针对您的应用选择合适的 TI 产品，(2) 设计、验证并测试您的应用，(3) 确保您的应用满足相应标准以及任何其他功能安全、信息安全、监管或其他要求。

这些资源如有变更，恕不另行通知。TI 授权您仅可将这些资源用于研发本资源所述的 TI 产品的应用。严禁对这些资源进行其他复制或展示。您无权使用任何其他 TI 知识产权或任何第三方知识产权。您应全额赔偿因在这些资源的使用中对 TI 及其代表造成的任何索赔、损害、成本、损失和债务，TI 对此概不负责。

TI 提供的产品受 [TI 的销售条款](#) 或 [ti.com](#) 上其他适用条款/TI 产品随附的其他适用条款的约束。TI 提供这些资源并不会扩展或以其他方式更改 TI 针对 TI 产品发布的适用的担保或担保免责声明。

TI 反对并拒绝您可能提出的任何其他或不同的条款。

邮寄地址：Texas Instruments, Post Office Box 655303, Dallas, Texas 75265

Copyright © 2023，德州仪器 (TI) 公司