

采用 SOT563 封装的 TPS562231 4.5V 至 17V 输入、2A 同步降压转换器

1 特性

- 2A 转换器集成了 95mΩ 和 55mΩ FET
- D-CAP3™ 模式控制，用于快速瞬态响应
- 输入电压范围：4.5V 至 17V
- 输出电压范围：0.6V 至 7V
- 脉冲跳跃模式
- 850kHz 开关频率
- 小于 2μA（典型值）的低关断电流
- 2% 反馈电压精度 (25°C)
- 从预偏置输出电压中启动
- 逐周期过流限制
- 断续模式过流保护
- 非锁存 UVP 和 TSD 保护
- 6 引脚 SOT563 封装
- 精密使能端
- 与 TPS563231 引脚对引脚兼容

2 应用

- 标准 12V 电源轨
- 数字电视电源
- 嵌入式系统
- 网络家庭终端设备
- 数字机顶盒 (STB)
- 监控
- 电表

3 说明

TPS562231 是一款采用 SOT563 封装的简单易用型 2A 同步降压转换器。

该器件经过优化，最大限度地减少了运行所需的外部组件并可实现低待机电流。

这些开关模式电源 (SMPS) 器件采用 D-CAP3 模式控制，该模式控制可提供快速瞬态响应，并同时支持诸如高分子聚合物等低等效串联电阻 (ESR) 输出电容以及超低 ESR 陶瓷电容器（无需外部补偿组件）。

在轻载运行期间，TPS562231 在脉冲跳跃模式 (PSM) 下运行，从而保持高效率。TPS562231 采用 6 引脚 1.6mm × 1.6mm SOT563 (DRL) 封装，额定结温范围为 -40°C 至 125°C。

器件信息⁽¹⁾

器件型号	封装	封装尺寸 (标称值)
TPS562231	DRL (6)	1.60mm x 1.60mm

(1) 如需了解所有可用封装，请参阅数据表末尾的可订购产品附录。

简化电路原理图

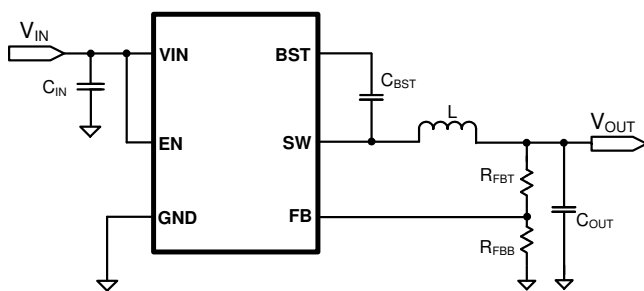

TPS562231 效率

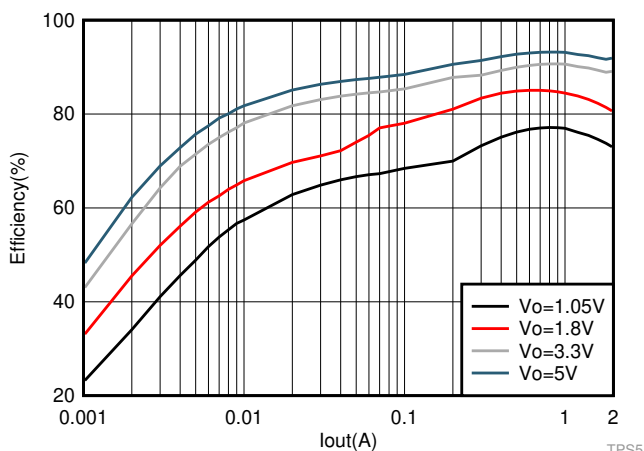

TPS5



目录

1	特性	1	7.4	Device Functional Modes	10
2	应用	1	8	Application and Implementation	12
3	说明	1	8.1	Application Information	12
4	修订历史记录	2	8.2	Typical Application	12
5	Pin Configuration and Functions	3	9	Power Supply Recommendations	16
6	Specifications	4	10	Layout	17
6.1	Absolute Maximum Ratings	4	10.1	Layout Guidelines	17
6.2	ESD Ratings	4	10.2	Layout Example	17
6.3	Recommended Operating Conditions	4	11	器件和文档支持	18
6.4	Thermal Information	5	11.1	器件支持	18
6.5	Electrical Characteristics	6	11.2	接收文档更新通知	18
6.6	Typical Characteristics	7	11.3	社区资源	18
7	Detailed Description	9	11.4	商标	18
7.1	Overview	9	11.5	静电放电警告	18
7.2	Functional Block Diagram	9	11.6	Glossary	18
7.3	Feature Description	9	12	机械、封装和可订购信息	19

4 修订历史记录

注：之前版本的页码可能与当前版本有所不同。

Changes from Revision A (March 2019) to Revision B Page

•	Changed FB I/O Type from 'O' to 'I'	4
---	---	----------

Changes from Original (February 2019) to Revision A Page

•	已更改 将销售状态从“预告信息”更改为“初始发行版”。	1
---	-----------------------------------	----------

5 Pin Configuration and Functions

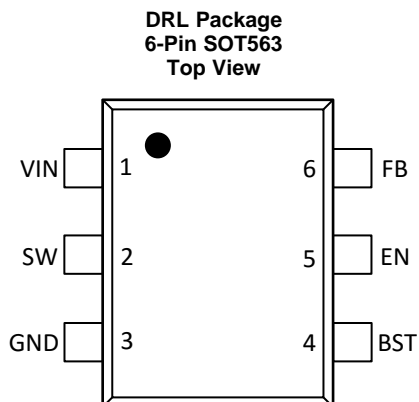

Pin Functions

PIN		I/O	DESCRIPTION
NAME	NO.		
BST	4	O	Supply input for the high-side NFET gate drive circuit. Connect 0.1 μ F capacitor between BST and SW pins.
EN	5	I	Enable input control. High = On, Low = Off. Can be connected to VIN. Do not float. Adjust the input undervoltage lockout with EN resistor divider.
FB	6	I	Converter feedback input. Connect to output voltage with feedback resistor divider.
GND	3	—	Power ground terminals, connected to the source of low-side FET internally. Connect to system ground, ground side of C_{IN} and C_{OUT} . Path to C_{IN} must as short as possible.
SW	2	O	Switch node connection between high-side NFET and low-side NFET.
VIN	1	I	Input voltage supply pin. The drain terminal of high-side power NFET.

6 Specifications

6.1 Absolute Maximum Ratings

 over operating free-air temperature range (unless otherwise noted)⁽¹⁾

		MIN	MAX	UNIT
Input voltage	VIN	-0.3	19	V
	BST	-0.3	24.5	V
	BST (10 ns transient)	-0.3	26.5	V
	BST to SW	-0.3	5.5	V
	FB	-0.3	5.5	V
	EN	-0.3	VIN + 0.3	
	SW	-2	19	V
	SW (10 ns transient)	-3.5	21	V
Operating junction temperature	T _J	-40	150	°C
Storage temperature	T _{stg}	-55	150	°C

(1) Stresses beyond those listed under *Absolute Maximum Ratings* may cause permanent damage to the device. These are stress ratings only, which do not imply functional operation of the device at these or any other conditions beyond those indicated under *Recommended Operating Conditions*. Exposure to absolute-maximum-rated conditions for extended periods may affect device reliability.

6.2 ESD Ratings

		VALUE	UNIT
V _(ESD) Electrostatic discharge	Human-body model (HBM), per ANSI/ESDA/JEDEC JS-001 ⁽¹⁾	±2000	V
	Charged-device model (CDM), per JEDEC specification JESD22-C101 ⁽²⁾	±500	

(1) JEDEC document JEP155 states that 500-V HBM allows safe manufacturing with a standard ESD control process.

(2) JEDEC document JEP157 states that 250-V CDM allows safe manufacturing with a standard ESD control process.

6.3 Recommended Operating Conditions

over operating free-air temperature range (unless otherwise noted)

		MIN	MAX	UNIT
Input voltage	VIN	4.5	17	V
	BST	-0.1	22	
	BST to SW	-0.1	5	
	EN	-0.1	VIN	
	FB	-0.1	4.5	
	SW	-1.8	17	
Operating junction temperature	T _J	-40	125	°C

6.4 Thermal Information

THERMAL METRIC ⁽¹⁾		TPS562231	
		DRL	UNIT
		6 PINS	
θ_{JA}	Junction-to-ambient thermal resistance	135.8	°C/W
$\theta_{JC(top)}$	Junction-to-case (top) thermal resistance	45.5	°C/W
θ_{JB}	Junction-to-board thermal resistance	23.8	°C/W
ψ_{JT}	Junction-to-top characterization parameter	1.2	°C/W
ψ_{JB}	Junction-to-board characterization parameter	24.0	°C/W

(1) For more information about traditional and new thermal metrics, see the [Semiconductor and IC Package Thermal Metrics](#) application report.

6.5 Electrical Characteristics

 $T_J = -40^{\circ}\text{C}$ to 125°C , $V_{IN} = 12\text{ V}$ (unless otherwise noted)

PARAMETER		TEST CONDITIONS	MIN	TYP	MAX	UNIT
POWER SUPPLY (VIN PIN)						
I_{VIN}	Operating – non-switching supply current	$V_{EN} = 5\text{ V}$, $V_{FB} = 0.7\text{ V}$		220	300	μA
I_{VINSN}	Shutdown supply current	$V_{EN} = 0\text{ V}$		2	12	μA
V_{IN_UVLO}	Undervoltage lockout thresholds	Rising threshold		4.0	4.3	V
		Falling threshold	3.3	3.6		
		Hysteresis		0.4		
ENABLE (EN PIN)						
V_{ENH}	EN high-level input voltage		1.1	1.24	1.42	V
V_{ENL}	EN low-level input voltage		1	1.13	1.3	V
R_{EN}	EN pin resistance to GND	$V_{EN} = 12\text{ V}$		1000		k Ω
VOLTAGE REFERENCE (FB PIN)						
V_{REF}	Reference voltage	$V_{IN} = 4.5\text{ V}$ to 17 V , $T_J = 25^{\circ}\text{C}$	588	600	612	mV
		$V_{IN} = 4.5\text{ V}$ to 17 V , $T_J = -40^{\circ}\text{C}$ to 125°C		600		mV
I_{FB}	V_{FB} input current	$V_{FB} = 0.6\text{ V}$		0	± 100	nA
MOSFET						
$R_{DS\text{ON_H}}$	High-side switch resistance	$T_J = 25^{\circ}\text{C}$, $V_{BST} - V_{SW} = 5.5\text{ V}$		95		m Ω
$R_{DS\text{ON_L}}$	Low-side switch resistance	$T_J = 25^{\circ}\text{C}$		55		m Ω
CURRENT LIMIT						
I_{OC_LS}	Low side FET source current limit		2.3	2.8	3.3	A
I_{ZC}	Zero cross current detection	TPS562231		0		A
THERMAL SHUTDOWN						
T_{SDN}	Thermal shutdown threshold ⁽¹⁾	Shutdown temperature		160		$^{\circ}\text{C}$
		Hysteresis		25		
ON-TIME TIMER CONTROL						
$t_{ON(MIN)}$	Minimum on time ⁽¹⁾			80		ns
$t_{OFF(MIN)}$	Minimum off time ⁽¹⁾	$V_{FB} = 0.5\text{ V}$		250		ns
SOFT START						
T_{SS}	Soft-start time	Internal soft-start time		1.5		ms
FREQUENCY						
F_{sw}	Switching frequency	$V_{IN} = 12\text{ V}$, $V_{OUT} = 3.3\text{ V}$, CCM mode		850		kHz
OUTPUT UNDERVOLTAGE AND OVERVOLTAGE PROTECTION						
V_{UVP}	Output UVP falling threshold	Hiccup detect		65		%
T_{HICCUP_WAIT}	UVP propagation delay			0.6		ms
T_{HICCUP_RE}	Hiccup time before restart			24		ms

(1) Not production tested.

6.6 Typical Characteristics

$V_{IN} = 12\text{ V}$ (unless otherwise noted)

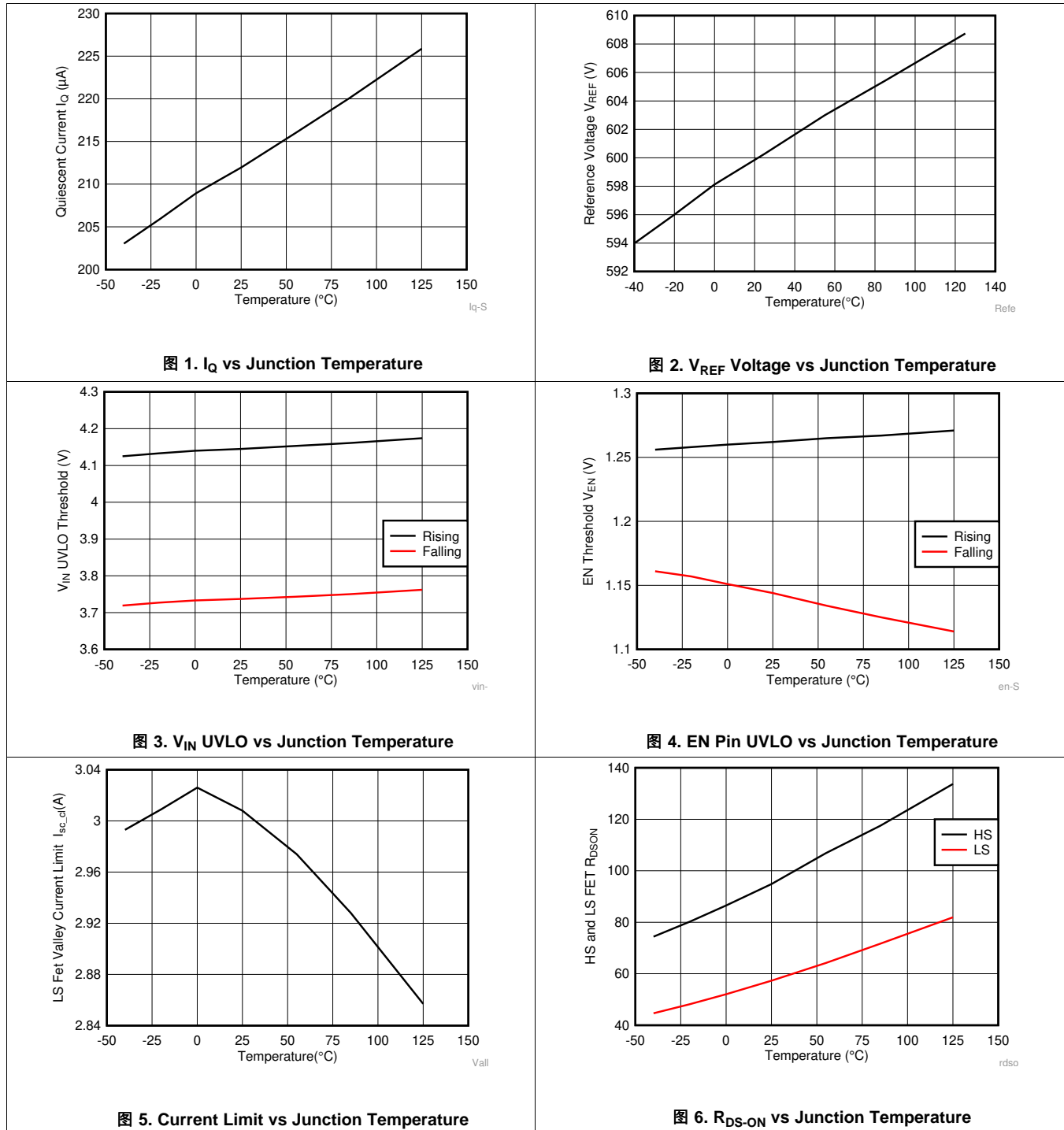

Typical Characteristics (接下页)

$V_{IN} = 12\text{ V}$ (unless otherwise noted)



图 7. TPS562231 $V_{OUT} = 1.05\text{ V}$ Efficiency



图 8. TPS562231 $V_{OUT} = 1.8\text{ V}$ Efficiency

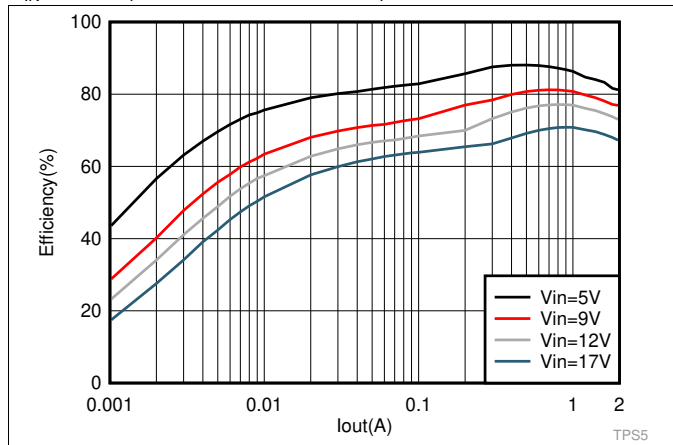

图 9. TPS562231 $V_{OUT} = 3.3\text{ V}$ Efficiency

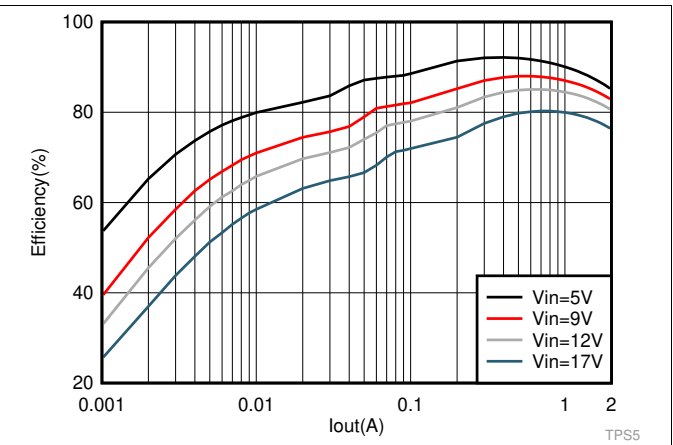

图 10. TPS562231 $V_{OUT} = 5\text{ V}$ Efficiency

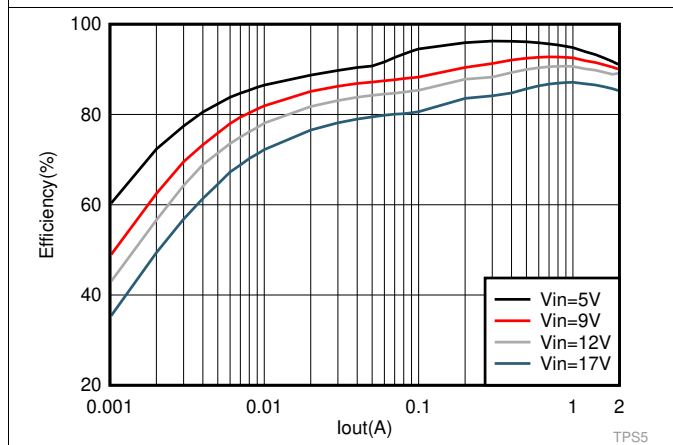

图 11. TPS562231 $V_{OUT} = 3.3\text{ V}$ Load Regulation

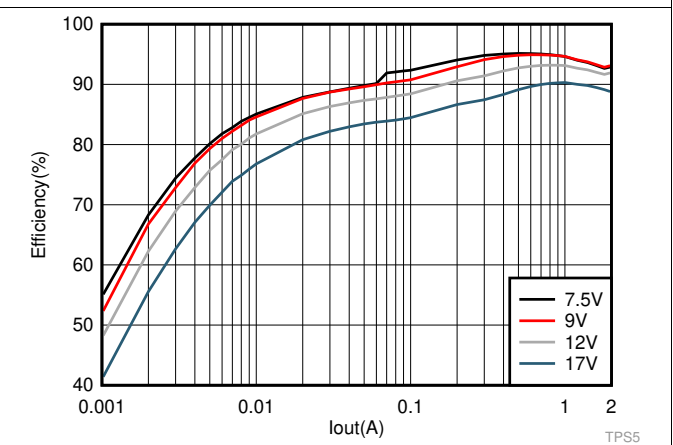

图 12. TPS562231 $V_{OUT} = 3.3\text{ V}$ Line Regulation

7 Detailed Description

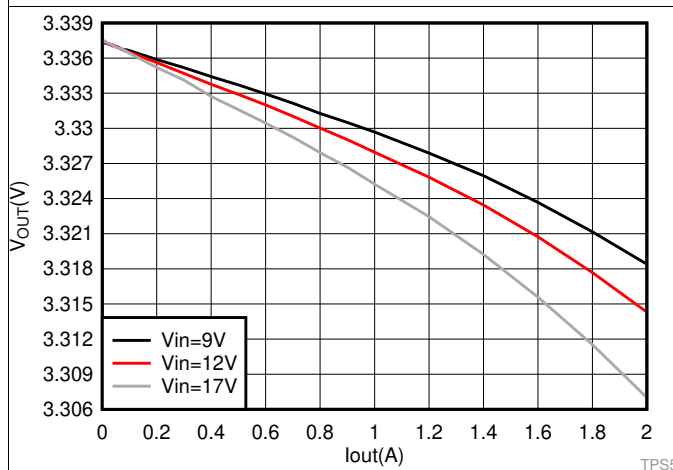
7.1 Overview

The TPS562231 is a 2-A synchronous step-down converter. The proprietary D-CAP3 mode control supports low ESR output capacitors such as specialty polymer capacitors and multi-layer ceramic capacitors without complex external compensation circuits. The fast transient response of D-CAP3 mode control can reduce the output capacitance required to meet a specific level of performance.

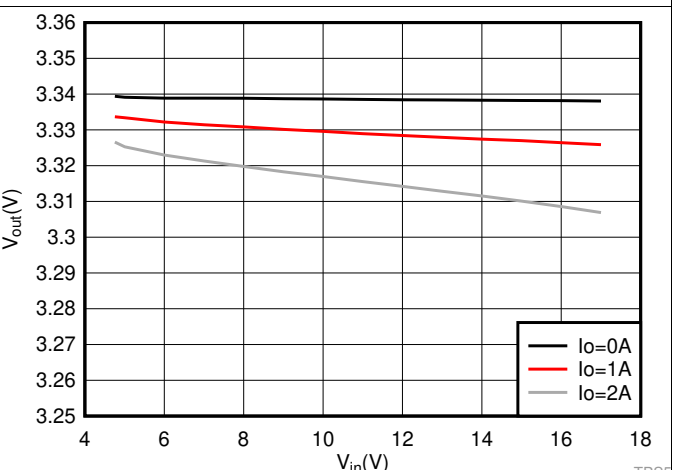
7.2 Functional Block Diagram

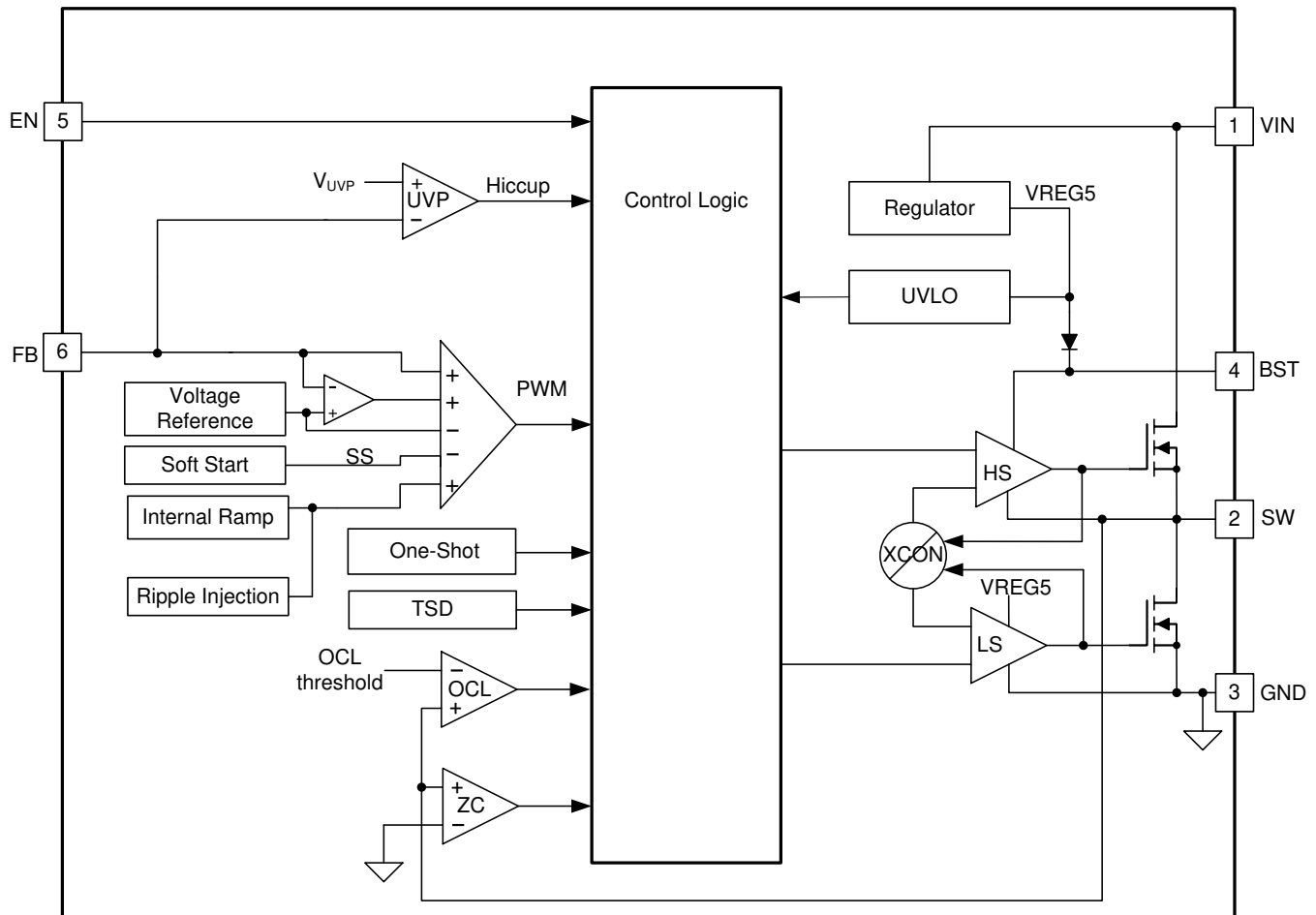

7.3 Feature Description

7.3.1 Adaptive On-Time Control and PWM Operation

The main control loop of the TPS562231 is adaptive on-time pulse width modulation (PWM) controller that supports a proprietary D-CAP3 mode control. The D-CAP3 mode control combines adaptive on-time control with an internal compensation circuit for pseudo-fixed frequency and low external component count configuration with both low-ESR and ceramic output capacitors. It is stable even with virtually no ripple at the output.

At the beginning of each cycle, the high-side MOSFET is turned on. This MOSFET is turned off after internal on-shot timer expires. This one shot duration is set proportional to the converter input voltage, V_{IN} , and inversely proportional to the output voltage, V_{OUT} , to maintain a pseudo-fixed frequency over the input voltage range, hence it is called adaptive on-time control. The on-shot timer is reset and the high-side MOSFET is turned on again when the feedback voltage falls below the reference voltage. An internal ramp is added to reference voltage to simulate output ripple, eliminating the need for ESR induced output ripple from D-CAP3 mode control.

Feature Description (接下页)

7.3.2 Soft Start and Pre-Biased Soft Start

The TPS562231 has an internal 1.5-ms soft-start. When the EN pin becomes high, the internal soft-start function begins ramping up the reference voltage from 0 V to 0.6 V linearly.

If the output capacitor is pre-biased at startup, the devices initiate switching and start ramping up only after the internal reference voltage becomes greater than the feedback voltage V_{FB} . This scheme ensures that the converters ramp up smoothly into regulation point.

7.3.3 Over Current and Short Circuit Protection

The TPS562231 is protected from over-current conditions by cycle-by-cycle current limit on the valley of the inductor current. Hiccup mode will be activated if a fault condition persists to prevent over-heating.

The current going through low-side (LS) MOSFET is sensed and monitored. When the LS MOSFET turns on, the inductor current begins to ramp down. The LS MOSFET will not be turned OFF if its current is above the LS current limit I_{LS_LIMIT} even the feedback voltage, V_{FB} , drops below the reference voltage V_{REF} . The LS MOSFET is kept ON so that inductor current keeps ramping down, until the inductor current ramps below the LS current limit I_{LS_LIMIT} . Then the LS MOSFET is turned OFF and the HS switch is turned on after a dead time.

As the inductor current is limited by I_{LS_LIMIT} , the output voltage tends to drop as the inductor current may be smaller than the load current. Hiccup current protection mode is activated once the V_{FB} drops below the UVP threshold after a delay time (600 μ s typically). In hiccup mode, the regulator is shut down and kept off for 24 ms typically before the TPS562231 try to start again. If over-current or short-circuit fault condition still exist, hiccup will repeat until the fault condition is removed. Hiccup mode reduces power dissipation under severe over-current conditions, prevents over-heating and potential damage to the device.

7.3.4 Undervoltage Lockout (UVLO) Protection

UVLO protection monitors the internal regulator voltage. When the voltage is lower than UVLO threshold voltage, the device is shut off. This protection is non-latching.

7.3.5 Thermal Shutdown

The device monitors the temperature of itself. If the temperature exceeds the threshold value (typically 160°C), the device is shut off. This is a non-latch protection.

7.4 Device Functional Modes

7.4.1 Shutdown Mode

The EN pin provides electrical ON and OFF control for the TPS562231. When V_{EN} is below its threshold (1.13 V typically), the device is in shutdown mode. The switching regulator is turned off and the quiescent current drops to 2.0 μ A typically. The TPS562231 also employ V_{IN} under voltage lock out protection. If V_{IN} voltage is below its UVLO threshold (3.6 V typically), the regulator is turned off.

7.4.2 Continuous Conduction Mode (CCM)

Continuous Conduction Mode (CCM) operation is employed when the load current is higher than half of the peak-to-peak inductor current. In CCM operation, the frequency of operation is pseud fixed, output voltage ripple will be at a minimum in this mode and the maximum output current of 2 A can be supplied.

Device Functional Modes (接下页)

7.4.3 Pulse Skip Mode (PSM, TPS562231)

The TPS562231 is designed with Advanced Eco-mode™ to maintain high light load efficiency. As the output current decreases from heavy load condition, the inductor current is also reduced and eventually comes to point that its rippled valley touches zero level, which is the boundary between continuous conduction mode (CCM) and discontinuous conduction mode (DCM). The low-side MOSFET is turned off when the zero inductor current is detected. As the load current further decreases the converter runs into discontinuous conduction mode. The on-time is kept almost the same as it was in the continuous conduction mode so that it takes longer time to discharge the output capacitor with smaller load current to the level of the reference voltage. This makes the switching frequency lower, proportional to the load current, and keeps the light load efficiency high. The transition point to the light load operation current I_{OUT_LL} can be calculated in [公式 1](#).

$$I_{OUT_LL} = \frac{1}{2 \times L \times f_{SW}} \times \frac{(V_{IN} - V_{OUT}) \times V_{OUT}}{V_{IN}} \quad (1)$$

As the load current continues to decrease, the switching frequency also decreases. The on-time starts to decrease once the switching frequency is lower than 250 kHz. The on-time can be about 22% reduced at most for extremely light load condition. This function is employed to achieve smaller ripple at extremely light load condition.

8 Application and Implementation

注

Information in the following applications sections is not part of the TI component specification, and TI does not warrant its accuracy or completeness. TI's customers are responsible for determining suitability of components for their purposes. Customers should validate and test their design implementation to confirm system functionality.

8.1 Application Information

The devices are typical step-down DC-DC converters. It typically uses to convert a higher dc voltage to a lower dc voltage with a maximum available output current of 2 A. The following design procedure can be used to select component values for the TPS562231. Alternately, the WEBENCH[®] software may be used to generate a complete design. The WEBENCH software uses an iterative design procedure and accesses a comprehensive database of components when generating a design. This section presents a simplified discussion of the design process.

8.2 Typical Application

The TPS562231 only require a few external components to convert from a higher variable voltage supply to a fixed output voltage. 图 13 shows a basic schematic of 3.3-V output application. This section provides the design procedure.



图 13. TPS562231 3.3V/2-A Reference Design

8.2.1 Design Requirements

表 1 shows the design parameters for this application.

表 1. Design Parameters

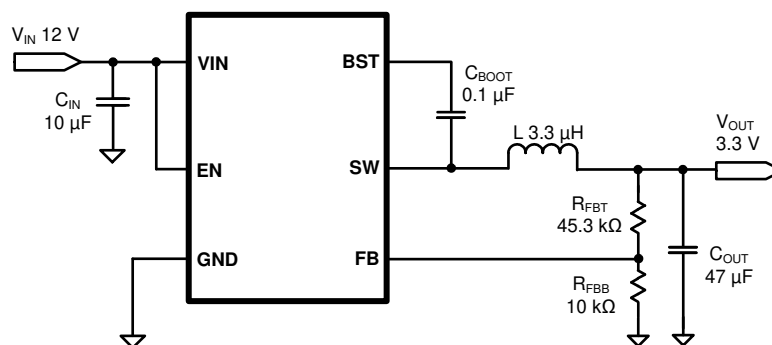
PARAMETER	EXAMPLE VALUE
Input voltage range	4.5 to 17 V
Output voltage	3.3 V
Transient response, 2-A load step	$\Delta V_{out} = \pm 5\%$
Input ripple voltage	400 mV
Output ripple voltage	30 mV
Output current rating	2 A
Operating frequency	850 kHz

8.2.2 Detailed Design Procedure

8.2.2.1 Output Voltage Resistors Selection

The output voltage is set with a resistor divider from the output node to the FB pin. 1% tolerance or better divider resistors is recommended. Start by using 公式 2 to calculate V_{OUT} .

To improve efficiency at very light loads consider using larger value resistors, too high of resistance will be more susceptible to noise and voltage errors from the FB input current will be more noticeable.

$$V_{OUT} = 0.6 \times \left(1 + \frac{R_{FBT}}{R_{FBB}} \right) \quad (2)$$

Choose the value of R_{FBB} to be 10 k Ω . With the desired output voltage set to 3.3 V and the $V_{REF} = 0.6$ V, the R_{FBT} value can then be calculated using 公式 2. The formula yields to a value 45.3 k Ω of R_{FBT} .

8.2.2.2 Output Filter Selection

The LC filter used as the output filter has double pole at:

$$f_p = \frac{1}{2\pi\sqrt{L \times C_{OUT}}} \quad (3)$$

At low frequencies, the overall loop gain is set by the output set-point resistor divider network and the internal gain of the device. The low frequency phase is 180°. At the output filter pole frequency, the gain rolls off at a –40 dB per decade rate and the phase drops rapidly. D-CAP3 introduces a high frequency zero that reduces the gain roll off to –20 dB per decade and increases the phase to 90° one decade above the zero frequency. The inductor and capacitor for the output filter must be selected so that the double pole of 公式 3 is located below the high frequency zero but close enough that the phase boost provided by the high frequency zero provides adequate phase margin for a stable circuit. To meet this requirement use the values recommended in 表 2.

表 2. Recommended Component Values

OUTPUT VOLTAGE (V)	R1 (k Ω)	R2 (k Ω)	L1 (μ H)			C8 + C9 (μ F)
			MIN	TYP	MAX	
1	6.65	10.0	1	1.2	4.7	20 to 68
1.05	7.5	10.0	1	1.2	4.7	20 to 68
1.2	10	10.0	1.2	1.5	4.7	20 to 68
1.5	15	10.0	1.5	1.5	4.7	20 to 68
1.8	20	10.0	1.5	2.2	4.7	20 to 68
2.5	31.6	10.0	2.2	2.2	4.7	20 to 68
3.3	45.3	10.0	2.2	3.3	4.7	20 to 68
5	73.2	10.0	3.3	4.7	4.7	20 to 68
6.5	97.6	10.0	3.3	4.7	4.7	20 to 68

The inductor peak-to-peak ripple current, peak current and RMS current are calculated using 公式 4, 公式 5, and 公式 6. The inductor saturation current rating must be greater than the calculated peak current and the RMS or heating current rating must be greater than the calculated RMS current.

$$I_{L_PP} = \frac{V_{OUT}}{V_{IN_MAX}} \times \frac{V_{IN_MAX} - V_{OUT}}{L \times f_{SW}} \quad (4)$$

$$I_{L_PK} = I_{OUT} + \frac{I_{L_PP}}{2} \quad (5)$$

$$I_{L_RMS} = \sqrt{I_{OUT}^2 + \frac{1}{12} I_{L_PP}^2} \quad (6)$$

For this design example, the calculated peak current is 2.43 A and the calculated RMS current is 2.01A. The inductor used is a WE 74437349033 with a peak current rating of 13.5 A and an RMS current rating of 5 A.

The capacitor value and ESR determines the amount of output voltage ripple. The TPS562231 is intended for use with ceramic or other low ESR capacitors. Recommended values range from 20 μ F to 68 μ F. Use 公式 7 to determine the required RMS current rating for the output capacitor.

$$I_{C_RMS} = \frac{V_{OUT} \times (V_{IN_MAX} - V_{OUT})}{\sqrt{12} \times V_{IN_MAX} \times L \times f_{SW}} \quad (7)$$

For this design two Murata GRM21BR61A226ME44L 22- μ F/10-V output capacitors are used in parallel. The typical ESR is 3m Ω each. The calculated RMS current is 0.39 A and each output capacitor is rated for 5 A.

8.2.2.3 Input Capacitor Selection

The TPS562231 requires an input decoupling capacitor and a bulk capacitor is needed depending on the application. TI recommends a ceramic capacitor over 10- μ F for the decoupling capacitor. An additional 0.1- μ F capacitor from VIN pin to GND pin is also recommended to provide additional high frequency filtering. The capacitor voltage rating needs to be greater than the maximum input voltage, 25 V or higher voltage rating is recommended.

8.2.2.4 Bootstrap Capacitor Selection

A 0.1- μ F ceramic capacitor must be connected between the BST to SW pin for proper operation. 10 V or higher voltage rating is recommended.

8.2.3 Application Curves



图 14. CCM Mode



图 15. DCM Mode

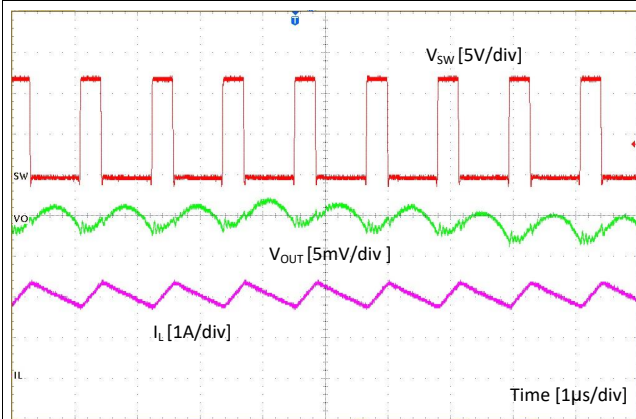

图 16. PSM Mode

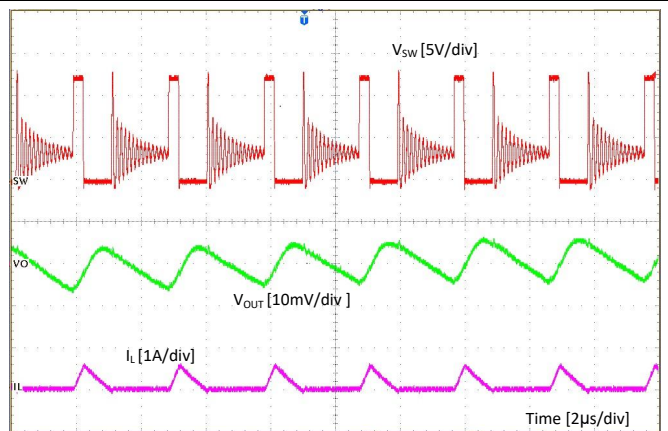

图 17. Start-up by V_{in}

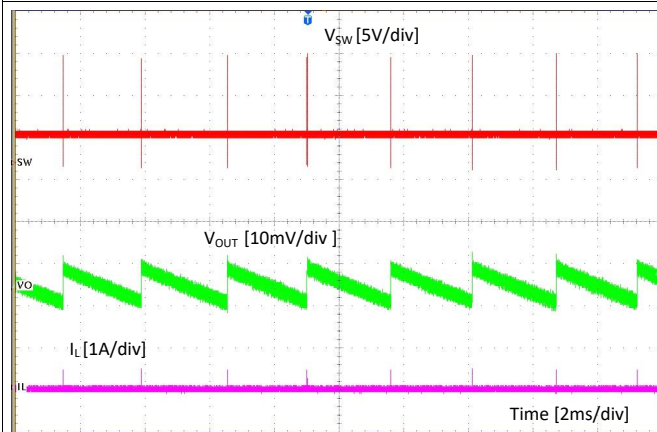

图 18. Start-up by EN

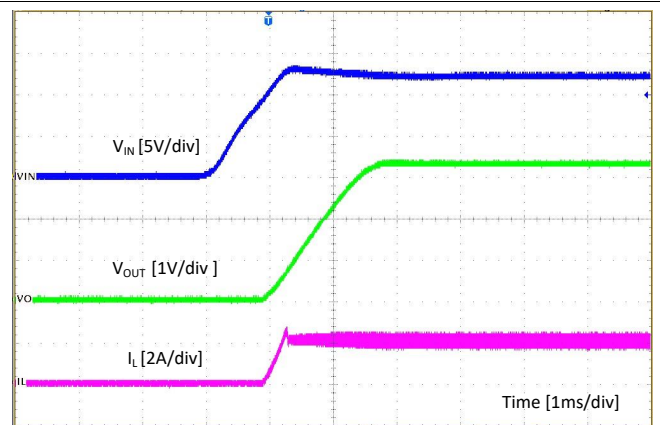

图 19. Load Transient

图 20. Short Protection

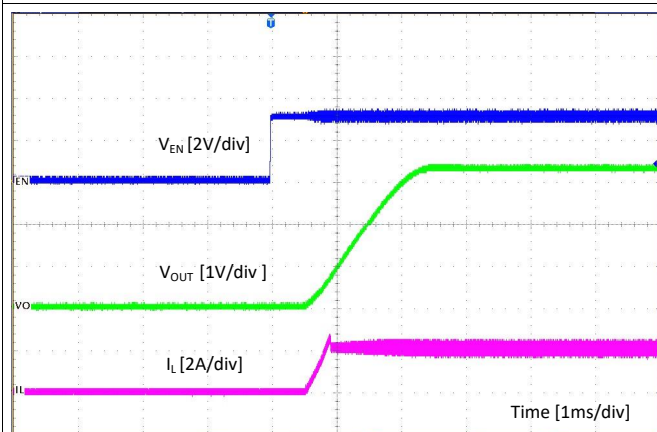
图 21. Short Recovery

9 Power Supply Recommendations

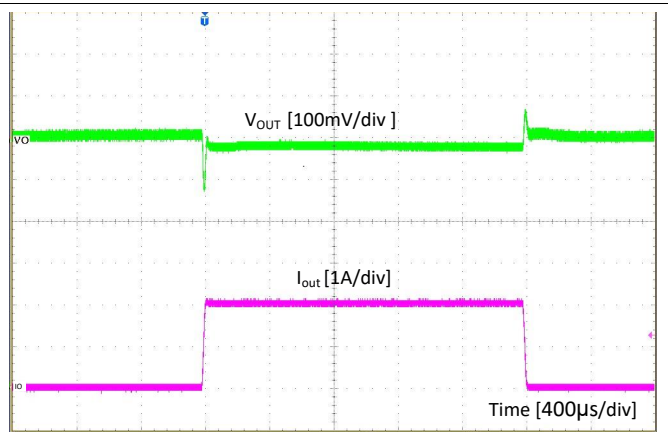
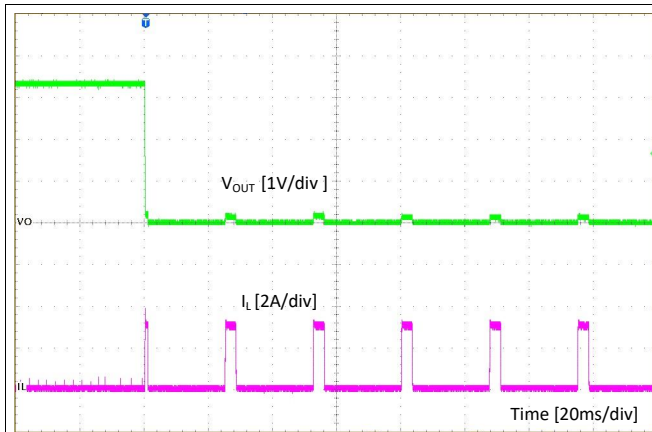
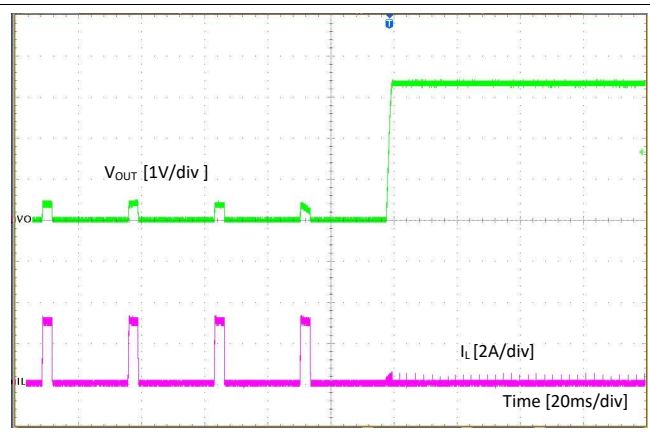
TPS562231 is designed to operate from input supply voltage in the range of 4.5 V to 17 V. Buck converters require the input voltage to be higher than the output voltage for proper operation. The maximum recommended operating duty cycle is 70%. Using that criteria, the minimum recommended input voltage is $V_O / 0.7$.

10 Layout

10.1 Layout Guidelines

1. VIN and GND traces should be as wide as possible to reduce trace impedance. The wide areas are also of advantage from the view point of heat dissipation.
2. The input capacitor and output capacitor should be placed as close to the device as possible to minimize trace impedance.
3. Provide sufficient vias for the input capacitor and output capacitor.
4. Keep the SW trace as physically short and wide as practical to minimize radiated emissions.
5. Do not allow switching current to flow under the device.
6. A separate VOUT path should be connected to the upper feedback resistor.
7. Make a Kelvin connection to the GND pin for the feedback path.
8. Voltage feedback loop should be placed away from the high-voltage switching trace, and preferably has ground shield.
9. The trace of the VFB node should be as small as possible to avoid noise coupling.
10. The GND trace between the output capacitor and the GND pin should be as wide as possible to minimize its trace impedance.

10.2 Layout Example



图 22. TPS562231 Layout

11 器件和文档支持

11.1 器件支持

11.2 接收文档更新通知

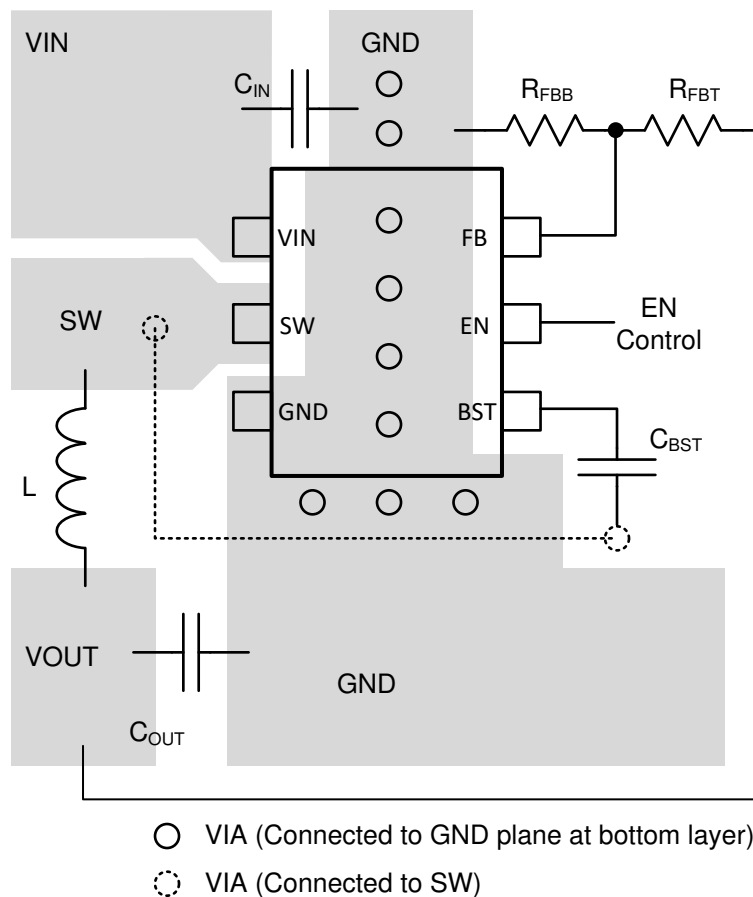
要接收文档更新通知，请导航至 ti.com 上的器件产品文件夹。单击右上角的通知我进行注册，即可每周接收产品信息更改摘要。有关更改的详细信息，请查看任何已修订文档中包含的修订历史记录。

11.3 社区资源

TI E2E™ [support forums](#) are an engineer's go-to source for fast, verified answers and design help — straight from the experts. Search existing answers or ask your own question to get the quick design help you need.

Linked content is provided "AS IS" by the respective contributors. They do not constitute TI specifications and do not necessarily reflect TI's views; see TI's [Terms of Use](#).

11.4 商标

D-CAP3, E2E are trademarks of Texas Instruments.

WEBENCH is a registered trademark of Texas Instruments.

11.5 静电放电警告



ESD 可能会损坏该集成电路。德州仪器 (TI) 建议通过适当的预防措施处理所有集成电路。如果不遵守正确的处理措施和安装程序，可能会损坏集成电路。

ESD 的损坏小至导致微小的性能降级，大至整个器件故障。精密的集成电路可能更容易受到损坏，这是因为非常细微的参数更改都可能会导致器件与其发布的规格不相符。

11.6 Glossary

[SLYZ022](#) — *TI Glossary*.

This glossary lists and explains terms, acronyms, and definitions.

12 机械、封装和可订购信息

以下页面包含机械、封装和可订购信息。这些信息是指定器件的最新可用数据。数据如有变更，恕不另行通知，且不会对此文档进行修订。如需获取此数据表的浏览器版本，请查阅左侧的导航栏。

PACKAGING INFORMATION

Orderable Device	Status (1)	Package Type	Package Drawing	Pins	Package Qty	Eco Plan (2)	Lead finish/ Ball material (6)	MSL Peak Temp (3)	Op Temp (°C)	Device Marking (4/5)	Samples
TPS562231DRLR	ACTIVE	SOT-5X3	DRL	6	4000	RoHS & Green	Call TI SN	Level-1-260C-UNLIM	-40 to 125	2231	Samples
TPS562231DRLT	ACTIVE	SOT-5X3	DRL	6	250	RoHS & Green	Call TI SN	Level-1-260C-UNLIM	-40 to 125	2231	Samples

(1) The marketing status values are defined as follows:

ACTIVE: Product device recommended for new designs.

LIFEBUY: TI has announced that the device will be discontinued, and a lifetime-buy period is in effect.

NRND: Not recommended for new designs. Device is in production to support existing customers, but TI does not recommend using this part in a new design.

PREVIEW: Device has been announced but is not in production. Samples may or may not be available.

OBSOLETE: TI has discontinued the production of the device.

(2) **RoHS:** TI defines "RoHS" to mean semiconductor products that are compliant with the current EU RoHS requirements for all 10 RoHS substances, including the requirement that RoHS substance do not exceed 0.1% by weight in homogeneous materials. Where designed to be soldered at high temperatures, "RoHS" products are suitable for use in specified lead-free processes. TI may reference these types of products as "Pb-Free".

RoHS Exempt: TI defines "RoHS Exempt" to mean products that contain lead but are compliant with EU RoHS pursuant to a specific EU RoHS exemption.

Green: TI defines "Green" to mean the content of Chlorine (Cl) and Bromine (Br) based flame retardants meet JS709B low halogen requirements of <=1000ppm threshold. Antimony trioxide based flame retardants must also meet the <=1000ppm threshold requirement.

(3) MSL, Peak Temp. - The Moisture Sensitivity Level rating according to the JEDEC industry standard classifications, and peak solder temperature.

(4) There may be additional marking, which relates to the logo, the lot trace code information, or the environmental category on the device.

(5) Multiple Device Markings will be inside parentheses. Only one Device Marking contained in parentheses and separated by a "~" will appear on a device. If a line is indented then it is a continuation of the previous line and the two combined represent the entire Device Marking for that device.

(6) Lead finish/Ball material - Orderable Devices may have multiple material finish options. Finish options are separated by a vertical ruled line. Lead finish/Ball material values may wrap to two lines if the finish value exceeds the maximum column width.

Important Information and Disclaimer:The information provided on this page represents TI's knowledge and belief as of the date that it is provided. TI bases its knowledge and belief on information provided by third parties, and makes no representation or warranty as to the accuracy of such information. Efforts are underway to better integrate information from third parties. TI has taken and continues to take reasonable steps to provide representative and accurate information but may not have conducted destructive testing or chemical analysis on incoming materials and chemicals. TI and TI suppliers consider certain information to be proprietary, and thus CAS numbers and other limited information may not be available for release.

In no event shall TI's liability arising out of such information exceed the total purchase price of the TI part(s) at issue in this document sold by TI to Customer on an annual basis.

TAPE AND REEL INFORMATION

QUADRANT ASSIGNMENTS FOR PIN 1 ORIENTATION IN TAPE

*All dimensions are nominal

Device	Package Type	Package Drawing	Pins	SPQ	Reel Diameter (mm)	Reel Width W1 (mm)	A0 (mm)	B0 (mm)	K0 (mm)	P1 (mm)	W (mm)	Pin1 Quadrant
TPS562231DRLR	SOT-5X3	DRL	6	4000	180.0	8.4	1.8	1.8	0.75	4.0	8.0	Q3
TPS562231DRLR	SOT-5X3	DRL	6	4000	180.0	8.4	1.8	1.8	0.75	4.0	8.0	Q3
TPS562231DRLT	SOT-5X3	DRL	6	250	180.0	8.4	1.8	1.8	0.75	4.0	8.0	Q3
TPS562231DRLT	SOT-5X3	DRL	6	250	180.0	8.4	1.8	1.8	0.75	4.0	8.0	Q3

TAPE AND REEL BOX DIMENSIONS

*All dimensions are nominal

Device	Package Type	Package Drawing	Pins	SPQ	Length (mm)	Width (mm)	Height (mm)
TPS562231DRLR	SOT-5X3	DRL	6	4000	210.0	185.0	35.0
TPS562231DRLR	SOT-5X3	DRL	6	4000	210.0	185.0	35.0
TPS562231DRLT	SOT-5X3	DRL	6	250	210.0	185.0	35.0
TPS562231DRLT	SOT-5X3	DRL	6	250	210.0	185.0	35.0

DRL0006A



PACKAGE OUTLINE

SOT - 0.6 mm max height

PLASTIC SMALL OUTLINE

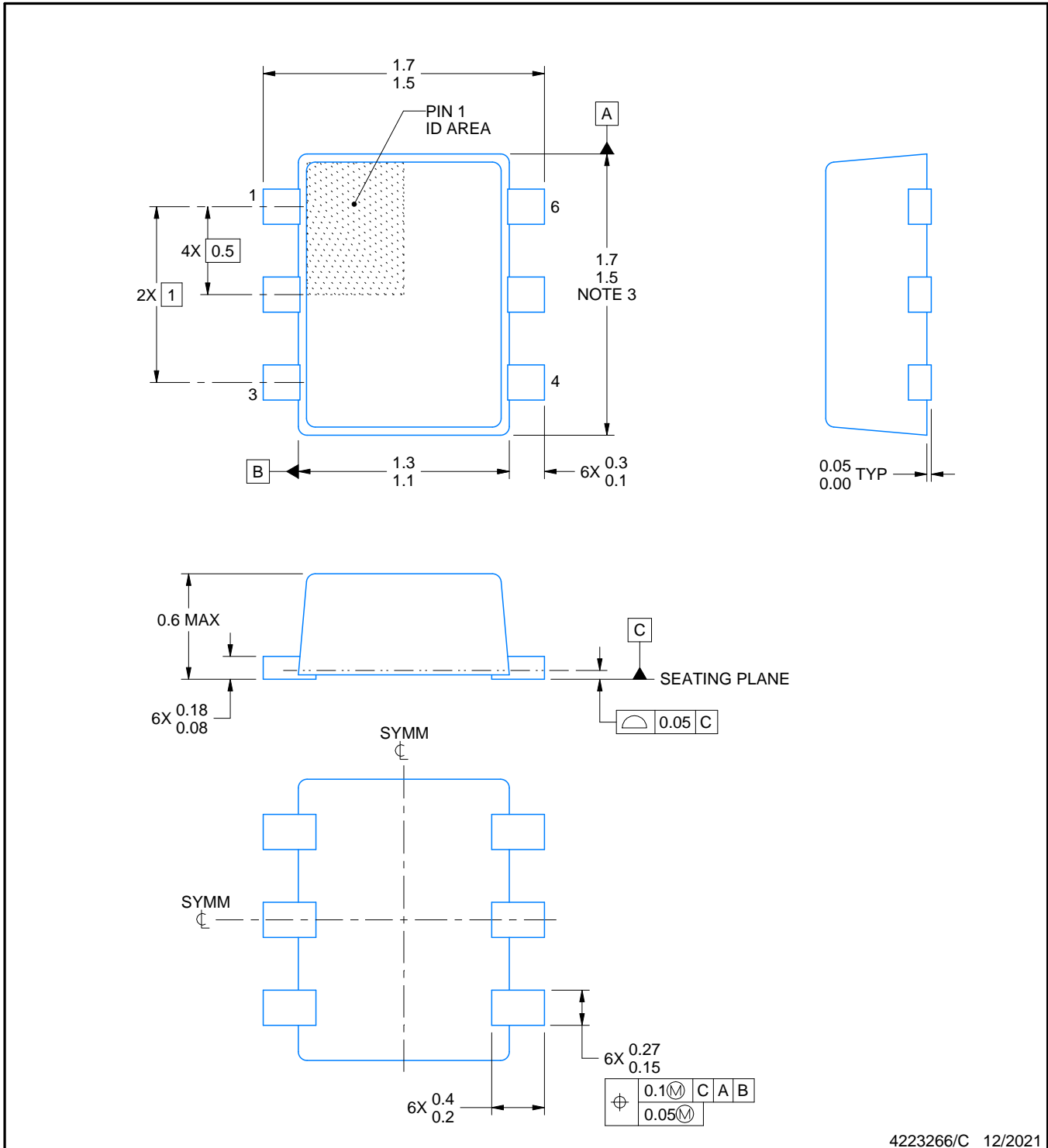

4223266/C 12/2021

NOTES:

1. All linear dimensions are in millimeters. Any dimensions in parenthesis are for reference only. Dimensioning and tolerancing per ASME Y14.5M.
2. This drawing is subject to change without notice.
3. This dimension does not include mold flash, protrusions, or gate burrs. Mold flash, protrusions, or gate burrs shall not exceed 0.15 mm per side.
4. Reference JEDEC registration MO-293 Variation UAAD

EXAMPLE BOARD LAYOUT

DRL0006A

SOT - 0.6 mm max height

PLASTIC SMALL OUTLINE



LAND PATTERN EXAMPLE
SCALE:30X



SOLDERMASK DETAILS

4223266/C 12/2021

NOTES: (continued)

5. Publication IPC-7351 may have alternate designs.
6. Solder mask tolerances between and around signal pads can vary based on board fabrication site.
7. Land pattern design aligns to IPC-610, Bottom Termination Component (BTC) solder joint inspection criteria.

EXAMPLE STENCIL DESIGN

DRL0006A

SOT - 0.6 mm max height

PLASTIC SMALL OUTLINE



SOLDER PASTE EXAMPLE
BASED ON 0.1 mm THICK STENCIL
SCALE:30X

4223266/C 12/2021

NOTES: (continued)

8. Laser cutting apertures with trapezoidal walls and rounded corners may offer better paste release. IPC-7525 may have alternate design recommendations.
9. Board assembly site may have different recommendations for stencil design.

重要声明和免责声明

TI“按原样”提供技术和可靠性数据（包括数据表）、设计资源（包括参考设计）、应用或其他设计建议、网络工具、安全信息和其他资源，不保证没有瑕疵且不做任何明示或暗示的担保，包括但不限于对适销性、某特定用途方面的适用性或不侵犯任何第三方知识产权的暗示担保。

这些资源可供使用 TI 产品进行设计的熟练开发人员使用。您将自行承担以下全部责任：(1) 针对您的应用选择合适的 TI 产品，(2) 设计、验证并测试您的应用，(3) 确保您的应用满足相应标准以及任何其他功能安全、信息安全、监管或其他要求。

这些资源如有变更，恕不另行通知。TI 授权您仅可将这些资源用于研发本资源所述的 TI 产品的应用。严禁对这些资源进行其他复制或展示。您无权使用任何其他 TI 知识产权或任何第三方知识产权。您应全额赔偿因在这些资源的使用中对 TI 及其代表造成的任何索赔、损害、成本、损失和债务，TI 对此概不负责。

TI 提供的产品受 [TI 的销售条款](#) 或 [ti.com](#) 上其他适用条款/TI 产品随附的其他适用条款的约束。TI 提供这些资源并不会扩展或以其他方式更改 TI 针对 TI 产品发布的适用的担保或担保免责声明。

TI 反对并拒绝您可能提出的任何其他或不同的条款。

邮寄地址：Texas Instruments, Post Office Box 655303, Dallas, Texas 75265

Copyright © 2023，德州仪器 (TI) 公司