

## OPAx625 高带宽、高精度、低 THD+N、 16 位和 18 位模数转换器 (ADC) 驱动器

### 1 特性

- 高驱动模式：
  - 增益带宽 (GBW) ( $G = 100$ ): 120MHz
  - 转换率: 115V/ $\mu$ s
  - 4V 输出时的 16 位稳定时间: 280ns
  - 低电压噪声: 10kHz 时为  $2.5\text{nV}/\sqrt{\text{Hz}}$
  - 低输出阻抗: 1MHz 时为  $1\Omega$
  - 偏移电压:  $\pm 100\mu\text{V}$  (最大值)
  - 偏移电压漂移:  $\pm 3\mu\text{V}/^\circ\text{C}$  (最大值)
  - 低静态电流: 2mA (典型值)
- 低功耗模式：
  - GBW: 1MHz
  - 低静态电流: 270 $\mu$ A (典型值)
- 功率可扩展性 特性：
  - 可超快地从低功耗模式切换至高驱动模式: 170ns
- 高交流和直流精度：
  - 低失真: 100kHz 时, HD2 为  $-122\text{dBc}$ , HD3 为  $-140\text{dBc}$
  - 输入共模范围包括负电源轨
  - 轨到轨输出
  - 宽额定温度范围:  $-40^\circ\text{C}$  至  $+125^\circ\text{C}$

### 2 应用

- 精密逐次逼近寄存器 (SAR) ADC 驱动器
- 精密电压基准缓冲器
- 可编程逻辑控制器
- 测试和测量设备
- 功耗敏感型数据采集系统

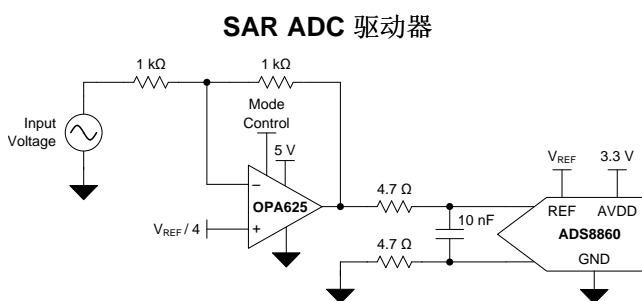

### 3 说明

OPAx625 系列运算放大器是出色的 16 位和 18 位 SAR ADC 驱动器, 具备高精度、低总谐波失真 (THD) 及低噪声等诸多优势, 可提供一套独特的电源可扩展解决方案。该器件系列在额定工作条件下的 16 位稳定时间为 280ns, 可提供真正的 16 位有效位数 (ENOB)。该系列器件具备高直流精度 (偏移电压仅为  $100\mu\text{V}$ )、120MHz 的宽增益带宽积以及  $2.5\text{nV}/\sqrt{\text{Hz}}$  的低宽带噪声, 并且经优化可驱动高吞吐量、高分辨率的 SAR ADC, 例如 ADS88xx 系列 SAR ADC。

此 OPAx625 具有两种工作模式: 高驱动模式和低功耗模式。在创新型低功耗模式下, OPAx625 会跟踪输入信号, 从而能够在 170ns 内以 16 位 ENOB 从低功耗模式切换至高驱动模式。

OPAx625 系列采用 6 引脚小外形尺寸晶体管 (SOT) 封装和 10 引脚超薄小外形尺寸 (VSSOP) 封装, 额定工作温度范围为  $-40^\circ\text{C}$  至  $+125^\circ\text{C}$ 。

#### 器件信息<sup>(1)</sup>

器件型号	封装	封装尺寸 (标称值)
OPA625	SOT (6)	2.90mm x 1.60mm
OPA2625	VSSOP (10)	3.00mm x 3.00mm

(1) 要了解所有可用封装, 请参见数据表末尾的封装选项附录。

#### 16 位 SAR ADC, $f_{\text{IN}} = 10\text{kHz}$ , 1MSPS FFT

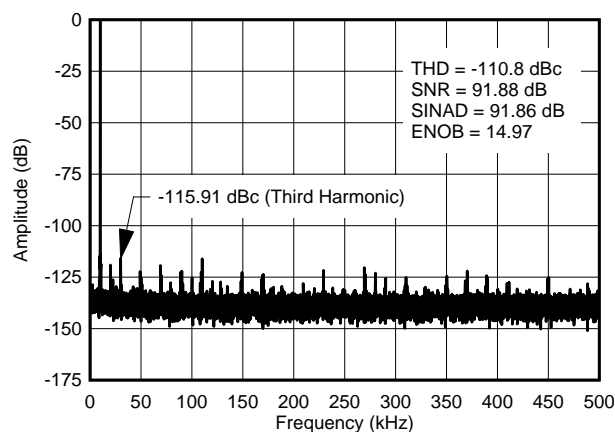

## 目录

<b>1</b>	<b>特性</b> .....	<b>1</b>	<b>8</b>	<b>Detailed Description</b> .....	<b>26</b>
<b>2</b>	<b>应用</b> .....	<b>1</b>	8.1	Overview .....	26
<b>3</b>	<b>说明</b> .....	<b>1</b>	8.2	Functional Block Diagram .....	26
<b>4</b>	<b>修订历史记录</b> .....	<b>2</b>	8.3	Feature Description .....	27
<b>5</b>	<b>Pin Configuration and Functions</b> .....	<b>3</b>	8.4	Device Functional Modes .....	28
<b>6</b>	<b>Specifications</b> .....	<b>4</b>	<b>9</b>	<b>Application and Implementation</b> .....	<b>30</b>
6.1	Absolute Maximum Ratings .....	4	9.1	Application Information .....	30
6.2	ESD Ratings .....	4	9.2	Typical Applications .....	30
6.3	Recommended Operating Conditions .....	4	<b>10</b>	<b>Power Supply Recommendations</b> .....	<b>34</b>
6.4	Thermal Information .....	5	<b>11</b>	<b>Layout</b> .....	<b>34</b>
6.5	Electrical Characteristics High-Drive Mode .....	5	11.1	Layout Guidelines .....	34
6.6	Electrical Characteristics Low-Power Mode .....	7	11.2	Layout Example .....	35
6.7	Electrical Characteristics High-Drive Mode .....	8	<b>12</b>	<b>器件和文档支持</b> .....	<b>36</b>
6.8	Electrical Characteristics Low-Power Mode .....	10	12.1	器件支持 .....	36
6.9	Switching Characteristics .....	11	12.2	文档支持 .....	36
6.10	Typical Characteristics .....	12	12.3	相关链接 .....	36
<b>7</b>	<b>Parameter Measurement Information</b> .....	<b>23</b>	12.4	Community Resources .....	36
7.1	DC Parameter Measurements .....	23	12.5	商标 .....	37
7.2	Transient Parameter Measurements .....	24	12.6	静电放电警告 .....	37
7.3	AC Parameter Measurements .....	24	12.7	Glossary .....	37
7.4	Noise Parameter Measurements .....	25	<b>13</b>	<b>机械、封装和可订购信息</b> .....	<b>37</b>

## 4 修订历史记录

### Changes from Original (April 2015) to Revision A

Page

•	已将 OPA2625 从“产品预览”改为“量产数据”；已添加 OPA2625 规范至数据表 .....	1
•	Changed MODE B pin description options for V+ and V- .....	3
•	Added crosstalk parameter to <i>Electrical Characteristics</i> table .....	5
•	Added crosstalk parameter to <i>Electrical Characteristics</i> table .....	8
•	Changed short-circuit current value from 150 mA to 80 mA in <i>Electrical Characteristics</i> table .....	9
•	Changed short-circuit current value from 100 mA to 50 mA in <i>Electrical Characteristics</i> table .....	10
•	Added OPA2625 data to 图 12 .....	13
•	Added 图 24 .....	15
•	Deleted "18" from several typical characteristic figure titles (typo) .....	19

## 5 Pin Configuration and Functions

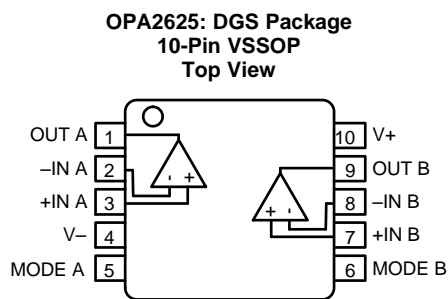
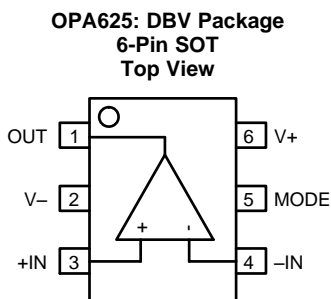

### Pin Functions: OPA625

PIN		I/O	DESCRIPTION
NAME	NO		
+IN	3	I	Noninverting input
-IN	4	I	Inverting input
MODE	5	I	Controls OPA625 mode: V+ = low-power mode V- = high-drive mode NOTE: Do not float this pin.
OUT	1	O	Output terminal
V+	6	—	Positive supply voltage
V-	2	—	Negative supply voltage

### Pin Functions: OPA2625

PIN		I/O	DESCRIPTION
NAME	NO.		
+IN A	3	I	Noninverting input for channel A
-IN A	2	I	Inverting input for channel A
+IN B	7	I	Noninverting input for channel B
-IN B	8	I	Inverting input for channel B
MODE A	5	I	Controls OPA2625 mode for channel A: V+ = low-power mode V- = high-drive mode NOTE: Do not float this pin.
MODE B	6	I	Controls OPA2625 mode for channel B: V+ = low-power mode V- = high-drive mode NOTE: Do not float this pin.
OUT A	1	O	Output terminal for channel A
OUT B	9	O	Output terminal for channel B
V+	10	—	Positive supply voltage
V-	4	—	Negative supply voltage

## 6 Specifications

### 6.1 Absolute Maximum Ratings

 over operating free-air temperature range (unless otherwise noted)<sup>(1)</sup>

		MIN	MAX	UNIT
Supply voltage, $V_S$	(V+) – (V–)	6		V
Input voltage <sup>(2)</sup>	+IN	(V–) – 0.3	(V+) + 0.3	V
	–IN	(V–) – 0.3	(V+) + 0.3	
	MODE	(V–) – 0.3	(V+) + 0.3	
Output voltage	OUT	(V–)	(V+)	V
Sink current	+IN	10		mA
	–IN	10		
	MODE	10		
	OUT	150		
Source current	+IN	10		mA
	–IN	10		
	MODE	10		
	OUT <sup>(2)</sup>	150		
Temperature	Operating junction	–40	150	°C
	Storage, $T_{stg}$	–65	150	

- (1) Stresses beyond those listed under *Absolute Maximum Ratings* may cause permanent damage to the device. These are stress ratings only, which do not imply functional operation of the device at these or any other conditions beyond those indicated under *Recommended Operating Conditions*. Exposure to absolute-maximum-rated conditions for extended periods may affect device reliability.
- (2) For input voltages beyond the power-supply rails, voltage or current must be limited.

### 6.2 ESD Ratings

			VALUE	UNIT
$V_{(ESD)}$	Electrostatic discharge	Human-body model (HBM), per ANSI/ESDA/JEDEC JS-001 <sup>(1)</sup>	±3000	V
		Charged-device model (CDM), per JEDEC specification JESD22-C101 <sup>(2)</sup>	±1500	

- (1) JEDEC document JEP155 states that 500-V HBM allows safe manufacturing with a standard ESD control process.
- (2) JEDEC document JEP157 states that 250-V CDM allows safe manufacturing with a standard ESD control process.

### 6.3 Recommended Operating Conditions

over operating free-air temperature range (unless otherwise noted)

		MIN	NOM	MAX	UNIT
$V_S$	Supply input voltage, (V+) – (V–)	2.7		5.5	V
$V_I$	Input voltage	+IN	(V–)	(V+) – 1.15	V
		–IN	(V–)	(V+) – 1.15	
		MODE	(V–)	(V+)	
$V_O$	Output voltage	(V–)		(V+)	V
$I_O$	Output current	–120		120	mA
$T_A$	Operating free-air temperature	–40		125	°C
$T_J$	Operating junction temperature	–40		125	°C

## 6.4 Thermal Information

THERMAL METRIC <sup>(1)</sup>		OPA625	OPA2625	UNIT
		DBV (SOT)	DGS (VSSOP)	
		6 PINS	10 PINS	
R <sub>θJA</sub>	Junction-to-ambient thermal resistance	184.9	171.7	°C/W
R <sub>θJC(top)</sub>	Junction-to-case (top) thermal resistance	123.6	68.4	°C/W
R <sub>θJB</sub>	Junction-to-board thermal resistance	30.7	91.9	°C/W
ψ <sub>JT</sub>	Junction-to-top characterization parameter	22.1	9.4	°C/W
ψ <sub>JB</sub>	Junction-to-board characterization parameter	30.2	90.5	°C/W
R <sub>θJC(bot)</sub>	Junction-to-case (bottom) thermal resistance	N/A	N/A	°C/W

(1) For more information about traditional and new thermal metrics, see the *Semiconductor and IC Package Thermal Metrics* application report, [SPRA953](#).

## 6.5 Electrical Characteristics High-Drive Mode

at T<sub>A</sub> = 25°C, V<sub>+</sub> = 5 V, V<sub>-</sub> = 0 V, MODE pin connected to V<sub>-</sub> pin, V<sub>COM</sub> = V<sub>O</sub> = 2.5 V, gain (G) = 1, R<sub>F</sub> = 1 kΩ, C<sub>F</sub> = 2.7 pF, C<sub>LOAD</sub> = 20 pF, and R<sub>LOAD</sub> = 2 kΩ connected to 2.5 V (unless otherwise noted)

PARAMETER		TEST CONDITIONS		MIN	TYP	MAX	UNIT
<b>AC PERFORMANCE</b>							
	Unity gain frequency	V <sub>O</sub> = 10 mV <sub>PP</sub>			80		MHz
φ <sub>m</sub>	Phase margin				50		Degrees
GBW	Gain-bandwidth product	G = 100, V <sub>O</sub> = 10 mV <sub>PP</sub>			120		MHz
SR	Slew rate	V <sub>O</sub> = 1-V step, G = 1			45		V/μs
		V <sub>O</sub> = 4-V step, G = 2			115		
t <sub>settle</sub>	Settling time	V <sub>O</sub> = 4-V step, G = 2	Settling time to 0.1% (10-bit accuracy)		80		ns
			to 0.005% (14-bit accuracy)		110		
			to 0.00153% (16-bit accuracy)		280		
	Overshoot	V <sub>O</sub> = 4-V step, G = 2			2.5%		
	Undershoot	V <sub>O</sub> = 4-V step, G = 2			3%		
HD2	Second-order harmonic Distortion	V <sub>O</sub> = 2 V <sub>PP</sub> , G = 2	f = 10 kHz		144		dBc
			f = 100 kHz		122		
			f = 1 MHz		80		
HD3	Third-order harmonic Distortion	V <sub>O</sub> = 2 V <sub>PP</sub> , G = 2	f = 10 kHz		155		dBc
			f = 100 kHz		140		
			f = 1 MHz		80		
	Second-order intermodulation distortion	V <sub>O</sub> = 2 V <sub>PP</sub> , f = 1 MHz, 200-kHz tone spacing			90		dBc
	Third-order intermodulation distortion	V <sub>O</sub> = 2 V <sub>PP</sub> , f = 1 MHz, 200-kHz tone spacing			100		dBc
V <sub>N</sub>	Input noise voltage	f = 0.1 Hz to 10 Hz, peak-to-peak			0.8		μV <sub>PP</sub>
		f = 0.1 Hz to 10 Hz, rms			120		nV <sub>RMS</sub>
V <sub>n</sub>	Input voltage noise density	f = 1 kHz			3.2		nV/√Hz
		f = 10 kHz			2.5		
I <sub>n</sub>	Input current noise density	f = 1 kHz			4.1		pA/√Hz
		f = 10 kHz			2.8		
t <sub>OR</sub>	Overload recovery time	G = 5			50		ns
Z <sub>o</sub>	Open-loop output impedance	f = 1 MHz			1		Ω
	Crosstalk	DC			150		dB
		f = 1 MHz			127		
<b>DC PERFORMANCE</b>							
V <sub>OS</sub>	Input offset voltage	T <sub>A</sub> = -40°C to +125°C			15	±100 ±300	μV

**Electrical Characteristics High-Drive Mode (continued)**

at  $T_A = 25^\circ\text{C}$ ,  $V_+ = 5\text{ V}$ ,  $V_- = 0\text{ V}$ , MODE pin connected to  $V_-$  pin,  $V_{\text{COM}} = V_O = 2.5\text{ V}$ , gain (G) = 1,  $R_F = 1\text{ k}\Omega$ ,  $C_F = 2.7\text{ pF}$ ,  $C_{\text{LOAD}} = 20\text{ pF}$ , and  $R_{\text{LOAD}} = 2\text{ k}\Omega$  connected to  $2.5\text{ V}$  (unless otherwise noted)

PARAMETER	TEST CONDITIONS	MIN	TYP	MAX	UNIT		
dV <sub>OS</sub> /dT	Input offset voltage drift	$T_A = -40^\circ\text{C}$ to $+125^\circ\text{C}$		0.5	$\pm 3$	$\mu\text{V}/^\circ\text{C}$	
		OPA2625 only, $T_A = -40^\circ\text{C}$ to $+125^\circ\text{C}$		0.6	$\pm 4$		
PSRR	Power-supply rejection ratio	$2.7\text{ V} \leq (V_+) \leq 5\text{ V}$	$T_A = -40^\circ\text{C}$ to $+125^\circ\text{C}$		100	dB	
			$T_A = -40^\circ\text{C}$ to $+125^\circ\text{C}$		90		120
I <sub>B</sub>	Input bias current	$T_A = -40^\circ\text{C}$ to $+125^\circ\text{C}$		2	4	$\mu\text{A}$	
		OPA2625 only, $T_A = -40^\circ\text{C}$ to $+125^\circ\text{C}$			5.7		6.5
dl <sub>B</sub> /dT	Input bias current drift	$T_A = -40^\circ\text{C}$ to $+125^\circ\text{C}$		15		nA/ $^\circ\text{C}$	
I <sub>OS</sub>	Input offset current	$T_A = -40^\circ\text{C}$ to $+125^\circ\text{C}$		20	120	nA	
		OPA2625 only, $T_A = -40^\circ\text{C}$ to $+125^\circ\text{C}$			150		200
dl <sub>OS</sub> /dT	Input offset current drift	$T_A = -40^\circ\text{C}$ to $+125^\circ\text{C}$		0.6		nA/ $^\circ\text{C}$	
<b>OPEN LOOP GAIN</b>							
A <sub>OL</sub>	Open-loop gain	$(V_-) + 0.2\text{ V} < V_O < (V_+) - 0.2\text{ V}$ , $R_{\text{LOAD}} = 600\ \Omega$		110		dB	
		$(V_-) + 0.15\text{ V} < V_O < (V_+) - 0.15\text{ V}$ , $R_{\text{LOAD}} = 10\text{ k}\Omega$		114			
		$T_A = -40^\circ\text{C}$ to $+125^\circ\text{C}$	$(V_-) + 0.2\text{ V} < V_O < (V_+) - 0.2\text{ V}$ , $R_{\text{LOAD}} = 600\ \Omega$		106		128
			$(V_-) + 0.15\text{ V} < V_O < (V_+) - 0.15\text{ V}$ , $R_{\text{LOAD}} = 10\text{ k}\Omega$		110		132
<b>INPUT VOLTAGE</b>							
V <sub>CM</sub>	Common-mode voltage range	$T_A = -40^\circ\text{C}$ to $+125^\circ\text{C}$		(V <sub>-</sub> )	(V <sub>+</sub> ) – 1.15	V	
CMRR	Common-mode rejection ratio	$(V_-) < V_{\text{COM}} < (V_+) - 1.15\text{ V}$	$T_A = -40^\circ\text{C}$ to $+125^\circ\text{C}$		100	117	dB
			$T_A = -40^\circ\text{C}$ to $+125^\circ\text{C}$		90	115	
<b>INPUT IMPEDANCE</b>							
Z <sub>ID</sub>	Differential input impedance			27    1.2		K $\Omega$    pF	
Z <sub>IC</sub>	Common-mode input impedance			47    1.5		M $\Omega$    pF	
<b>OUTPUT</b>							
	Output voltage swing to the rail	R <sub>LOAD</sub> = 600 $\Omega$	$T_A = -40^\circ\text{C}$ to $+125^\circ\text{C}$		60	80	mV
			$T_A = -40^\circ\text{C}$ to $+125^\circ\text{C}$			100	
		R <sub>LOAD</sub> = 10 k $\Omega$	$T_A = -40^\circ\text{C}$ to $+125^\circ\text{C}$		20	35	
			$T_A = -40^\circ\text{C}$ to $+125^\circ\text{C}$			40	
I <sub>sc</sub>	Short-circuit current			150		mA	
C <sub>LOAD</sub>	Capacitive load drive	See <a href="#">Typical Characteristics</a>					
<b>MODE</b>							
V <sub>IL</sub>	High-drive (HD) mode threshold	$T_A = -40^\circ\text{C}$ to $+125^\circ\text{C}$		(V <sub>-</sub> )	(V <sub>-</sub> ) + 0.5	V	
V <sub>IH</sub>	Low-power (LP) mode threshold	$T_A = -40^\circ\text{C}$ to $+125^\circ\text{C}$		(V <sub>-</sub> ) + 1.2	(V <sub>+</sub> )	V	
I <sub>IL</sub>	Low-level input current	$T_A = -40^\circ\text{C}$ to $+125^\circ\text{C}$ , $V_{\text{MODE}} \leq (V_-) + 0.5\text{ V}$		0.01	1	$\mu\text{A}$	
I <sub>IH</sub>	High-level input current	$T_A = -40^\circ\text{C}$ to $+125^\circ\text{C}$ , $V_{\text{MODE}} \geq (V_-) + 1.2\text{ V}$		20	30	$\mu\text{A}$	
		OPA2625 only, $T_A = -40^\circ\text{C}$ to $+125^\circ\text{C}$ , $V_{\text{MODE}} \geq (V_-) + 1.2\text{ V}$			1		
<b>POWER SUPPLY</b>							
I <sub>Q</sub>	Quiescent current per amplifier	I <sub>O</sub> = 0 mA, MODE connected to ground	$T_A = -40^\circ\text{C}$ to $+125^\circ\text{C}$		2	2.2	mA
			$T_A = -40^\circ\text{C}$ to $+125^\circ\text{C}$			3.1	

## 6.6 Electrical Characteristics Low-Power Mode

at  $T_A = 25^\circ\text{C}$ ,  $V_+ = 5\text{ V}$ ,  $V_- = 0\text{ V}$ ,  $V_{\text{MODE}} = 5\text{ V}$ ,  $V_{\text{COM}} = V_O = 2.5\text{ V}$ , gain ( $G$ ) = 1,  $R_F = 1\text{ k}\Omega$ ,  $C_F = 2.7\text{ pF}$ ,  $C_{\text{LOAD}} = 20\text{ pF}$ , and  $R_{\text{LOAD}} = 2\text{ k}\Omega$  connected to 2.5 V (unless otherwise noted)

PARAMETER		TEST CONDITIONS	MIN	TYP	MAX	UNIT
<b>AC PERFORMANCE</b>						
GBW	Gain-bandwidth product	$G = 100$ , $V_O = 10\text{ mV}_{\text{PP}}$		1		MHz
$\phi_m$	Phase margin			72		Degrees
SR	Slew rate	$V_O = 1\text{-V step}$		4.3		V/ $\mu\text{s}$
		$V_O = 4\text{-V step}$ , $G = 2$		4.1		
$Z_o$	Open-loop output impedance	$f = 1\text{ MHz}$		12		$\Omega$
<b>DC PERFORMANCE</b>						
$V_{\text{OS}}$	Input offset voltage			0.6	3	mV
		$T_A = -40^\circ\text{C to } +125^\circ\text{C}$		0.7	3.7	
PSRR	Power-supply rejection ratio	$2.7\text{ V} \leq (V_+) \leq 5\text{ V}$		74		dB
			$T_A = -40^\circ\text{C to } +125^\circ\text{C}$	70	100	
$I_B$	Input bias current				150	nA
		$T_A = -40^\circ\text{C to } +125^\circ\text{C}$		140	200	
		OPA2625 only, $T_A = -40^\circ\text{C to } +125^\circ\text{C}$			250	
$I_{\text{OS}}$	Input offset current				20	nA
		$T_A = -40^\circ\text{C to } +125^\circ\text{C}$			25	
<b>OPEN LOOP GAIN</b>						
$A_{\text{OL}}$	Open-loop gain	$T_A = -40^\circ\text{C to } +125^\circ\text{C}$	$(V_-) + 0.2\text{ V} < V_O < (V_+) - 0.2\text{ V}$ , $R_{\text{LOAD}} = 600\ \Omega$	70	100	dB
			$(V_-) + 0.15\text{ V} < V_O < (V_+) - 0.15\text{ V}$ , $R_{\text{LOAD}} = 10\text{ k}\Omega$	90	100	
<b>INPUT VOLTAGE</b>						
$V_{\text{CM}}$	Common-mode voltage range	$T_A = -40^\circ\text{C to } +125^\circ\text{C}$		(V-)	(V+) – 1.15	V
CMRR	Common-mode rejection ratio	$(V_-) < V_{\text{COM}} < (V_+) - 1.15\text{ V}$		66	114	dB
			$T_A = -40^\circ\text{C to } +125^\circ\text{C}$	60	114	
<b>OUTPUT</b>						
	Output voltage swing to the rail	$T_A = -40^\circ\text{C to } +125^\circ\text{C}$	$R_{\text{LOAD}} = 600\ \Omega$		110	mV
			$R_{\text{LOAD}} = 10\text{ k}\Omega$		40	
$I_{\text{sc}}$	Short-circuit current			100		mA
<b>POWER SUPPLY</b>						
$I_Q$	Quiescent current per amplifier	$I_O = 0\text{ mA}$ , MODE connected to V+		270	320	$\mu\text{A}$
			$T_A = -40^\circ\text{C to } +125^\circ\text{C}$		450	

## 6.7 Electrical Characteristics High-Drive Mode

at  $T_A = +25^\circ\text{C}$ ,  $V_+ = 2.7\text{ V}$ ,  $V_- = 0\text{ V}$ ,  $V_{\text{MODE}} = 0\text{ V}$ ,  $V_{\text{COM}} = V_O = 1.35\text{ V}$ , gain ( $G$ ) = 1,  $R_F = 1\text{ k}\Omega$ ,  $C_F = 2.7\text{ pF}$ ,  $C_{\text{LOAD}} = 20\text{ pF}$ , and  $R_{\text{LOAD}} = 1\text{ k}\Omega$  connected to 1.35 V (unless otherwise noted)

PARAMETER		TEST CONDITIONS		MIN	TYP	MAX	UNIT
<b>AC PERFORMANCE</b>							
	Unity gain frequency	$V_O = 10\text{ mV}_{\text{PP}}$			76		MHz
$\phi_m$	Phase margin				45		Degrees
GBW	Gain-bandwidth product	$G = 100$ , $V_O = 10\text{ mV}_{\text{PP}}$			120		MHz
SR	Slew rate	$V_O = 1\text{-V step}$ , $G = 2$			45		V/ $\mu\text{s}$
$t_{\text{settle}}$	Settling time	$V_O = 1\text{-V step}$ , $G = 2$	to 0.1%		80		ns
			to 0.01%		170		
			to 0.000763% (17-bit accuracy)		250		
	Overshoot	$V_O = 1\text{-V step}$ , $G = 2$			6%		
	Undershoot	$V_O = 1\text{-V step}$ , $G = 2$			5%		
HD2	Second order harmonic Distortion	$(V_+ = 3.3\text{ V}, (V_-) = 0\text{ V}, V_{\text{COM}} = 1.1\text{ V}, V_O = 2\text{ V}_{\text{PP}}$	$f = 10\text{ kHz}$		136		dBc
			$f = 100\text{ kHz}$		118		
			$f = 1\text{ MHz}$		80		
HD3	Third order harmonic Distortion	$(V_+ = 3.3\text{ V}, (V_-) = 0\text{ V}, V_{\text{COM}} = 1.1\text{ V}, V_O = 2\text{ V}_{\text{PP}}$	$f = 10\text{ kHz}$		143		dBc
			OPA2625 only, $f = 10\text{ kHz}$		143		
			$f = 100\text{ kHz}$		130		
			OPA2625 only, $f = 100\text{ kHz}$		125		
			$f = 1\text{ MHz}$		85		
	Second order inter-modulation distortion	$(V_+ = 3.3\text{ V}, (V_-) = 0\text{ V}, V_{\text{COM}} = 1.1\text{ V}, V_O = 2\text{ V}_{\text{PP}}, f = 1\text{ MHz}, 200\text{-kHz tone spacing}$			95		dBc
	Third order inter-modulation distortion	$(V_+ = 3.3\text{ V}, (V_-) = 0\text{ V}, V_{\text{COM}} = 1.1\text{ V}, V_O = 1\text{ V}_{\text{PP}}, f = 1\text{ MHz}, 200\text{-kHz tone spacing}$			104		dBc
$V_N$	Input noise voltage	$f = 0.1\text{ Hz to } 10\text{ Hz peak to peak}$			0.8		$\mu\text{V}_{\text{PP}}$
		$f = 0.1\text{ Hz to } 10\text{ Hz rms}$			120		$\text{nV}_{\text{RMS}}$
$V_n$	Input voltage noise density	$f = 10\text{ kHz}$			2.5		$\text{nV}/\sqrt{\text{Hz}}$
$I_n$	Input current noise density	$f = 10\text{ kHz}$			2.8		$\text{pA}/\sqrt{\text{Hz}}$
$t_{\text{OR}}$	Overload recovery time	$G = 5$			35		ns
$Z_o$	Open-loop output impedance	$f = 1\text{ MHz}$			1.3		$\Omega$
	Crosstalk	DC			150		dB
		$f = 1\text{ MHz}$			127		
<b>DC PERFORMANCE</b>							
$V_{\text{OS}}$	Input offset voltage				15	$\pm 100$	$\mu\text{V}$
		$T_A = -40^\circ\text{C to } +125^\circ\text{C}$				$\pm 300$	
$dV_{\text{OS}}/dT$	Input offset voltage drift	$T_A = -40^\circ\text{C to } +125^\circ\text{C}$			0.5	$\pm 3.1$	$\mu\text{V}/^\circ\text{C}$
		OPA2625 only, $T_A = -40^\circ\text{C to } +125^\circ\text{C}$			0.6	$\pm 4$	
$I_B$	Input bias current				2	4	$\mu\text{A}$
		$T_A = -40^\circ\text{C to } +125^\circ\text{C}$				5.7	
		OPA2625 only, $T_A = -40^\circ\text{C to } +125^\circ$				6.5	
$dI_B/dT$	Input bias current drift	$T_A = -40^\circ\text{C to } +125^\circ\text{C}$			15		$\text{nA}/^\circ\text{C}$
$I_{\text{OS}}$	Input offset current				20	120	nA
		$T_A = -40^\circ\text{C to } +125^\circ\text{C}$				150	
		OPA2625 only, $T_A = -40^\circ\text{C to } +125^\circ$				200	
$dI_{\text{OS}}/dT$	Input offset current drift	$T_A = -40^\circ\text{C to } +125^\circ\text{C}$			80		$\text{pA}/^\circ\text{C}$
<b>OPEN-LOOP GAIN</b>							



**Electrical Characteristics High-Drive Mode (continued)**

at  $T_A = +25^\circ\text{C}$ ,  $V_+ = 2.7\text{ V}$ ,  $V_- = 0\text{ V}$ ,  $V_{\text{MODE}} = 0\text{ V}$ ,  $V_{\text{COM}} = V_O = 1.35\text{ V}$ , gain ( $G$ ) = 1,  $R_F = 1\text{ k}\Omega$ ,  $C_F = 2.7\text{ pF}$ ,  $C_{\text{LOAD}} = 20\text{ pF}$ , and  $R_{\text{LOAD}} = 1\text{ k}\Omega$  connected to 1.35 V (unless otherwise noted)

PARAMETER	TEST CONDITIONS	MIN	TYP	MAX	UNIT	
$A_{\text{OL}}$ Open-loop gain	$(V_-) + 0.2\text{ V} < V_O < (V_+) - 0.2\text{ V}$ , $R_{\text{LOAD}} = 600\ \Omega$	110			dB	
	$(V_-) + 0.15\text{ V} < V_O < (V_+) - 0.15\text{ V}$ , $R_{\text{LOAD}} = 10\text{ k}\Omega$	114				
	$T_A = -40^\circ\text{C}$ to $+125^\circ\text{C}$	$(V_-) + 0.2\text{ V} < V_O < (V_+) - 0.2\text{ V}$ , $R_{\text{LOAD}} = 600\ \Omega$	106	128		
		$(V_-) + 0.15\text{ V} < V_O < (V_+) - 0.15\text{ V}$ , $R_{\text{LOAD}} = 10\text{ k}\Omega$	110	132		
<b>INPUT VOLTAGE</b>						
$V_{\text{CM}}$ Common-mode voltage range	$T_A = -40^\circ\text{C}$ to $+125^\circ\text{C}$	(V-)		(V+) – 1.15	V	
$\text{CMRR}$ Common-mode rejection ratio	$(V_-) < V_{\text{COM}} < (V_+) - 1.15\text{ V}$ $T_A = -40^\circ\text{C}$ to $+125^\circ\text{C}$	100	117		dB	
		90	115			
<b>INPUT IMPEDANCE</b>						
$Z_{\text{ID}}$ Differential input impedance			27    0.8		k $\Omega$    pF	
$Z_{\text{IC}}$ Common-mode input impedance			47    1.2		M $\Omega$    pF	
<b>OUTPUT</b>						
Output voltage swing to the rail	$R_{\text{LOAD}} = 600\ \Omega$	$T_A = -40^\circ\text{C}$ to $+125^\circ\text{C}$	60	80	mV	
				100		
	$R_{\text{LOAD}} = 10\text{ k}\Omega$	$T_A = -40^\circ\text{C}$ to $+125^\circ\text{C}$	20	35		
				40		
$I_{\text{SC}}$ Short-circuit current			80		mA	
$C_{\text{LOAD}}$ Capacitive load drive		See <a href="#">Typical Characteristics</a>				
<b>MODE</b>						
$V_{\text{IL}}$ High-drive (HD) mode threshold	$T_A = -40^\circ\text{C}$ to $+125^\circ\text{C}$	(V-)		(V-) + 0.5	V	
$V_{\text{IH}}$ Low-power (LP) mode threshold	$T_A = -40^\circ\text{C}$ to $+125^\circ\text{C}$	(V-) + 1.2		(V+)	V	
<b>POWER SUPPLY</b>						
$I_{\text{Q}}$ Quiescent current per amplifier	$I_{\text{Q}} = 0\text{ mA}$ MODE connected to ground $T_A = -40^\circ\text{C}$ to $+125^\circ\text{C}$		2	2.1	mA	
				2.8		

### 6.8 Electrical Characteristics Low-Power Mode

at  $T_A = +25^\circ\text{C}$ ,  $V_+ = 2.7\text{ V}$ ,  $V_- = 0\text{ V}$ ,  $V_{\text{MODE}} = 2.7\text{ V}$ ,  $V_{\text{COM}} = V_O = 1.35\text{ V}$ , gain ( $G$ ) = 1,  $R_F = 1\text{ k}\Omega$ ,  $C_F = 2.7\text{ pF}$ ,  $C_{\text{LOAD}} = 20\text{ pF}$ , and  $R_{\text{LOAD}} = 1\text{ k}\Omega$  connected to 1.35 V (unless otherwise noted)

PARAMETER		TEST CONDITIONS	MIN	TYP	MAX	UNIT
<b>AC PERFORMANCE</b>						
GBW	Gain-bandwidth product	$G = 100$ , $V_{\text{IN}} = 10\text{ mV}_{\text{PP}}$		0.8		MHz
$\phi_m$	Phase margin			72		Degrees
SR	Slew rate	$V_O = 1\text{ V-step}$ , $G = 2$		3.7		V/ $\mu\text{s}$
$Z_o$	Open-loop output impedance	$f = 1\text{ MHz}$		13		$\Omega$
<b>DC PERFORMANCE</b>						
$V_{\text{OS}}$	Input offset voltage			0.6	3	mV
		$T_A = -40^\circ\text{C to } +125^\circ\text{C}$		0.7	$\pm 3.6$	
$I_B$	Input bias current				150	nA
		$T_A = -40^\circ\text{C to } +125^\circ\text{C}$		140	220	
		OPA2625 only, $T_A = -40^\circ\text{C to } +125^\circ$			250	
$I_{\text{OS}}$	Input offset current				20	nA
		$T_A = -40^\circ\text{C to } +125^\circ\text{C}$			25	
<b>OPEN LOOP GAIN</b>						
$A_{\text{OL}}$	Open-loop gain	$T_A = -40^\circ\text{C to } +125^\circ\text{C}$	$(V_-) + 0.2\text{ V} < V_O < (V_+) - 0.2\text{ V}$ , $R_{\text{LOAD}} = 600\ \Omega$	74	100	dB
			$(V_-) + 0.15\text{ V} < V_O < (V_+) - 0.15\text{ V}$ , $R_{\text{LOAD}} = 10\text{ k}\Omega$	84	100	
<b>INPUT VOLTAGE</b>						
$V_{\text{CM}}$	Common-mode voltage range	$T_A = -40^\circ\text{C to } +125^\circ\text{C}$		(V-)	(V+) - 1.15	V
CMRR	Common-mode rejection ratio	$(V_-) < V_{\text{COM}} < (V_+) - 1.15\text{ V}$		66	114	dB
			$T_A = -40^\circ\text{C to } +125^\circ\text{C}$	60	114	
<b>OUTPUT</b>						
	Output voltage swing to rail	$T_A = -40^\circ\text{C to } +125^\circ\text{C}$	$R_{\text{LOAD}} = 600\ \Omega$		110	mV
			$R_{\text{LOAD}} = 10\text{ k}\Omega$		40	
$I_{\text{sc}}$	Short-circuit current			50		mA
<b>POWER SUPPLY</b>						
$I_Q$	Quiescent current per amplifier	$I_O = 0\text{ mA}$ , MODE connected to V+		250	270	$\mu\text{A}$
			$T_A = -40^\circ\text{C to } +125^\circ\text{C}$		400	

### 6.9 Switching Characteristics

at  $T_A = 25^\circ\text{C}$ ,  $V_+ = 5\text{ V}$ ,  $V_- = 0\text{ V}$ , MODE pin connected to  $V_-$  pin, gain ( $G$ ) = 1,  $V_{\text{COM}} = V_O = 2.5\text{ V}$ ,  $C_{\text{LOAD}} = 20\text{ pF}$ , and  $R_{\text{LOAD}} = 1\text{ k}\Omega$  connected to  $2.5\text{ V}$  (unless otherwise noted)

PARAMETER	TEST CONDITIONS	MIN	TYP	MAX	UNIT
$t_{\text{LP-HD}}$ Delay time, MODE pin falling (low-power mode to high-drive mode)	Settling time to within $50\text{ }\mu\text{V}$ of final value, MODE pin = high to low (LP to HD), $V_O = 3.8\text{ V}$		180		ns
	$t_{\text{LP-HD}}$ is defined as the time taken for the quiescent current to increase from 110% of its value in LP mode to 90% of its value in HD mode.		170		ns
$t_{\text{HD-LP}}$ Delay time, MODE pin rising (high-drive mode to low-power mode)	$t_{\text{HD-LP}}$ is defined as the time taken for the quiescent current to decrease from 90% of its value in HD mode to 110% of its value in LP mode.		300		ns

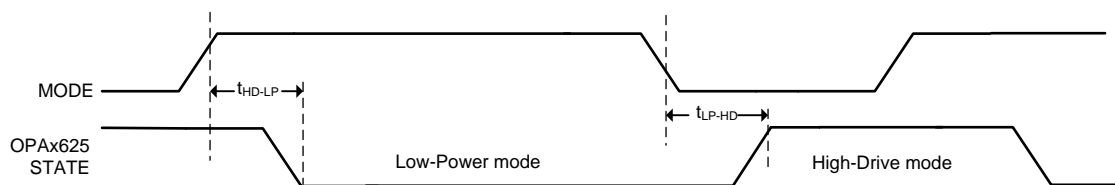

**图 1. Switching Characteristics Timing Diagram**

### 6.10 Typical Characteristics

At  $T_A = 25^\circ\text{C}$ ,  $V_+ = 5\text{ V}$ ,  $V_- = 0\text{ V}$ ,  $\text{MODE} = V_-$ ,  $V_{\text{COM}} = V_O = 2.5\text{ V}$ , gain ( $G$ ) = 2,  $R_F = 1\text{ k}\Omega$ ,  $C_F = 2.7\text{ pF}$ ,  $C_{\text{LOAD}} = 20\text{ pF}$ , and  $R_{\text{LOAD}} = 2\text{ k}\Omega$  connected to  $2.5\text{ V}$  (unless otherwise noted)



图 2. Small-Signal Frequency Response for Various Gains



图 3. Large-Signal Frequency Response for Various Gains

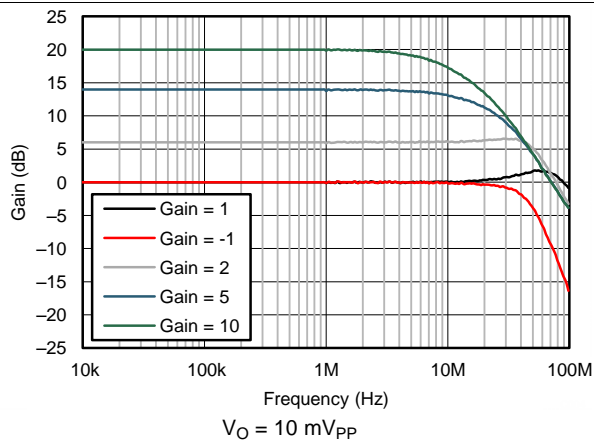

图 4. Small-Signal Frequency Response for Various Power Supply Voltages

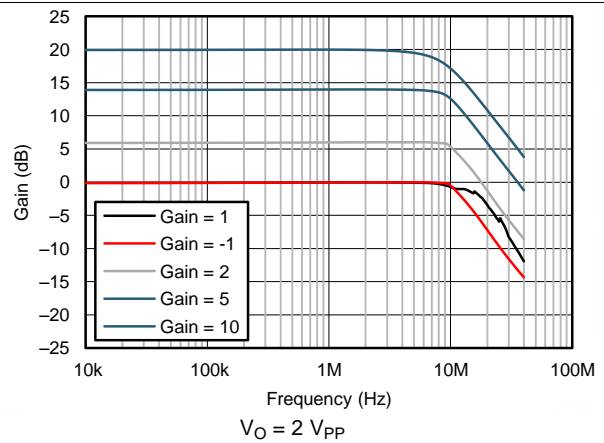

图 5. Small-Signal Frequency Response for Various Capacitive Loads

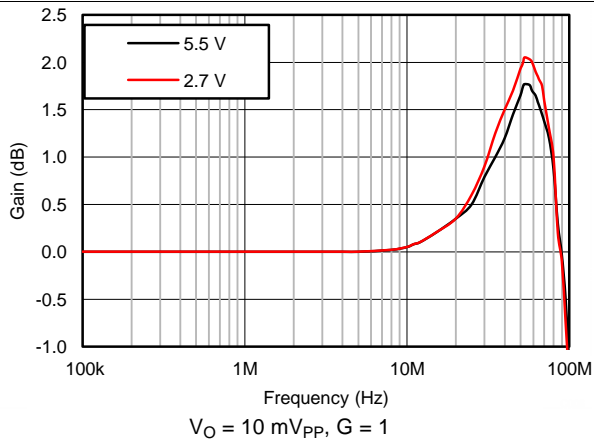

图 6. Large-Signal Frequency Response for Various Capacitive Loads

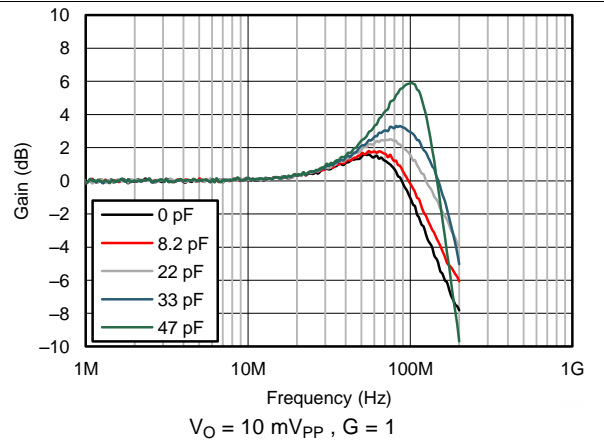

图 7. Small-Signal Frequency Response for Various Resistive Loads

Typical Characteristics (接下页)

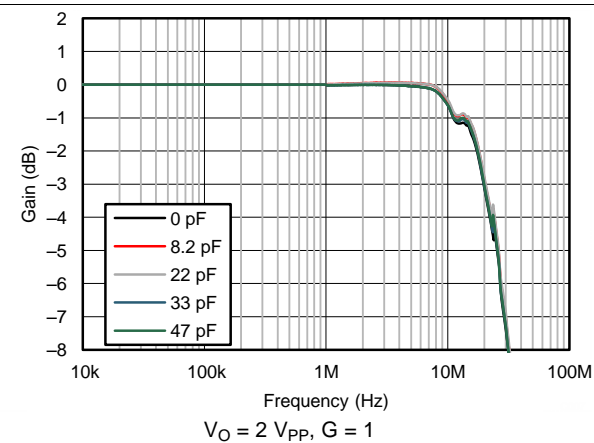
At  $T_A = 25^\circ\text{C}$ ,  $V_+ = 5\text{ V}$ ,  $V_- = 0\text{ V}$ ,  $\text{MODE} = \text{V-}$ ,  $V_{\text{COM}} = V_O = 2.5\text{ V}$ , gain ( $G$ ) = 2,  $R_F = 1\text{ k}\Omega$ ,  $C_F = 2.7\text{ pF}$ ,  $C_{\text{LOAD}} = 20\text{ pF}$ , and  $R_{\text{LOAD}} = 2\text{ k}\Omega$  connected to  $2.5\text{ V}$  (unless otherwise noted)

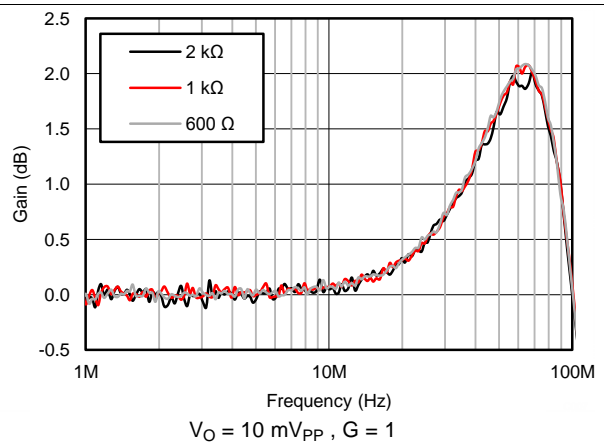

图 8. High-Drive Mode Open-Loop Gain and Phase vs Frequency



图 9. High-Drive Mode Open-Loop Output Impedance vs Frequency

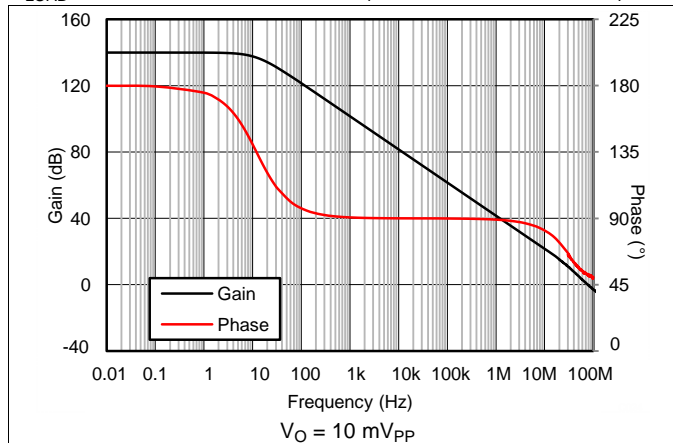

图 10. Low-Power Mode Open-Loop Gain and Phase vs Frequency

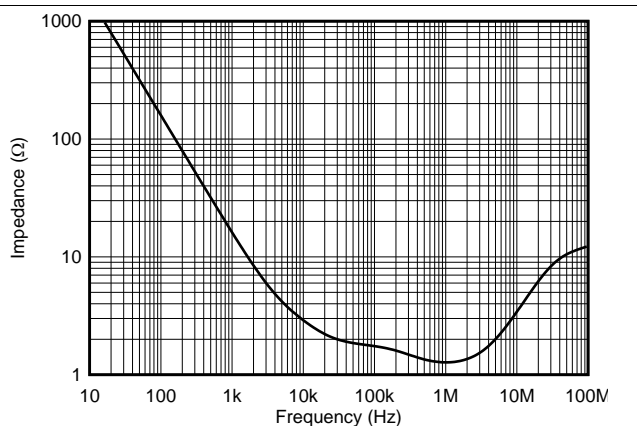

图 11. Low-Power Mode Open-Loop Output Impedance vs Frequency

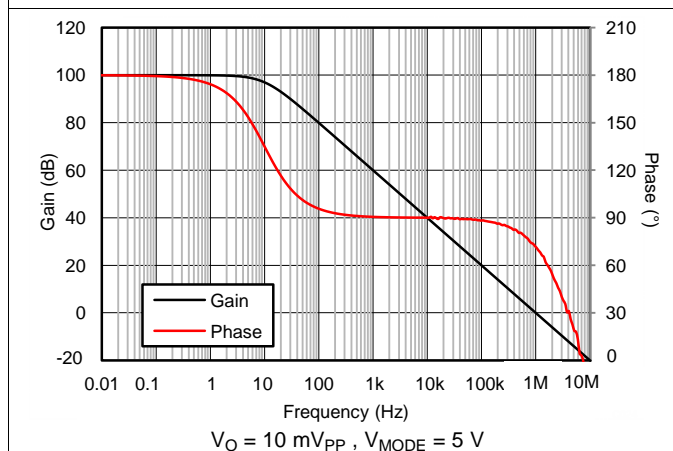

图 12. Common-Mode Rejection Ratio vs Frequency

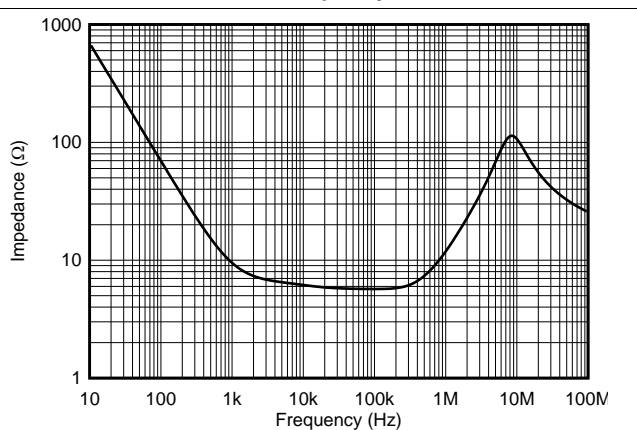

图 13. Power-Supply Rejection Ratio vs Frequency

Typical Characteristics (接下页)

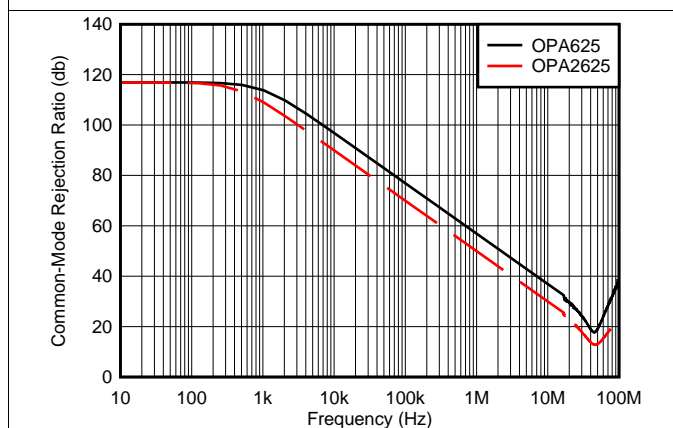
At  $T_A = 25^\circ\text{C}$ ,  $V_+ = 5\text{ V}$ ,  $V_- = 0\text{ V}$ ,  $\text{MODE} = V_-$ ,  $V_{\text{COM}} = V_O = 2.5\text{ V}$ , gain ( $G$ ) = 2,  $R_F = 1\text{ k}\Omega$ ,  $C_F = 2.7\text{ pF}$ ,  $C_{\text{LOAD}} = 20\text{ pF}$ , and  $R_{\text{LOAD}} = 2\text{ k}\Omega$  connected to  $2.5\text{ V}$  (unless otherwise noted)

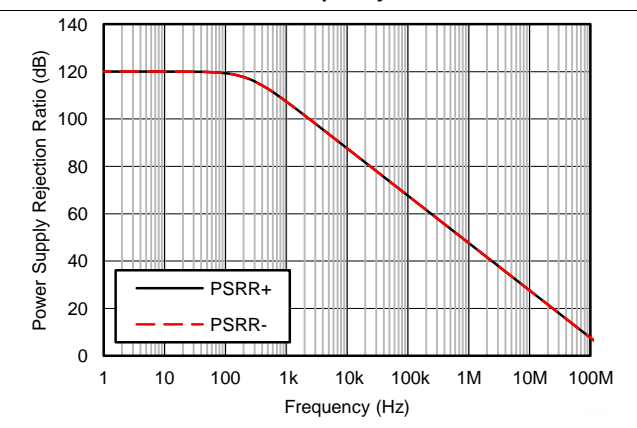

图 14. Series Resistance for Capacitive Load Stability



图 15. Overshoot vs Capacitive Load,  $G = 1$

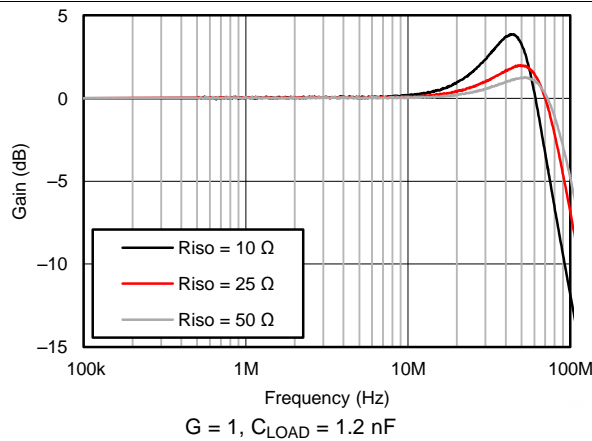

图 16. Overshoot vs Capacitive Load,  $G = -1$

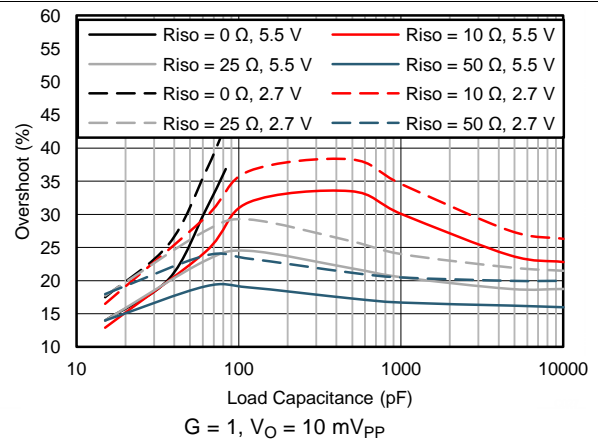

图 17. Distortion vs Frequency for Various Gains

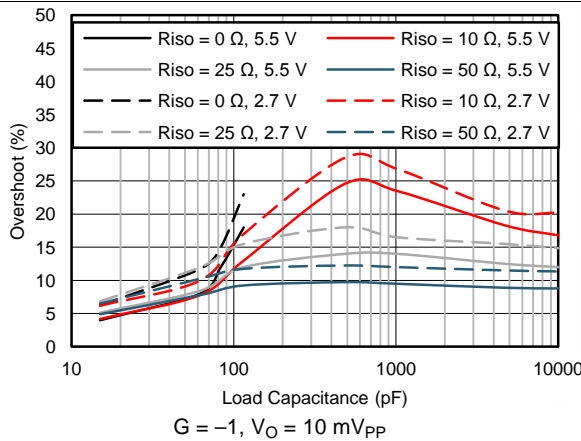

图 18. Distortion vs Frequency for Various Power Supplies

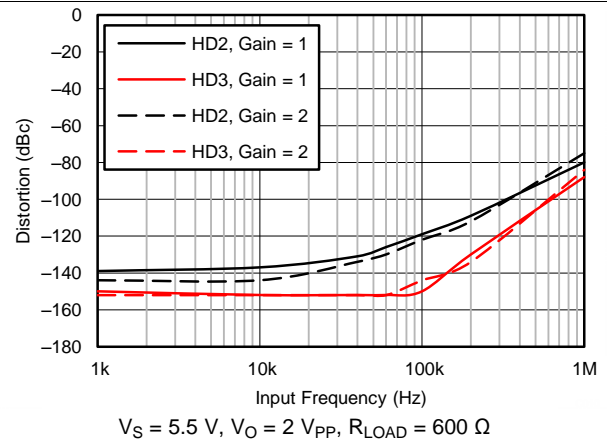

图 19. Distortion vs Frequency for Various Power Supplies

Typical Characteristics (接下页)

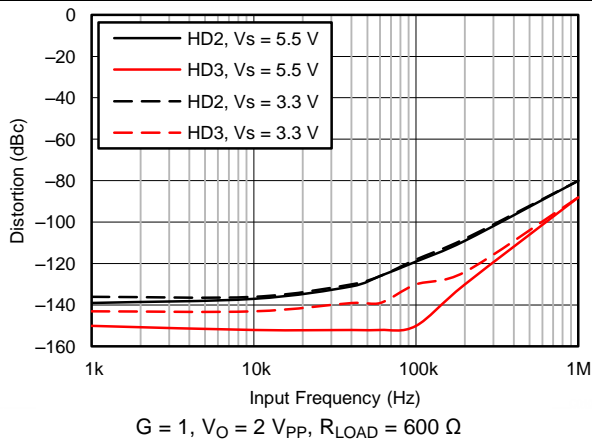
At  $T_A = 25^\circ\text{C}$ ,  $V_+ = 5\text{ V}$ ,  $V_- = 0\text{ V}$ ,  $\text{MODE} = V_-$ ,  $V_{\text{COM}} = V_O = 2.5\text{ V}$ , gain ( $G$ ) = 2,  $R_F = 1\text{ k}\Omega$ ,  $C_F = 2.7\text{ pF}$ ,  $C_{\text{LOAD}} = 20\text{ pF}$ , and  $R_{\text{LOAD}} = 2\text{ k}\Omega$  connected to 2.5 V (unless otherwise noted)

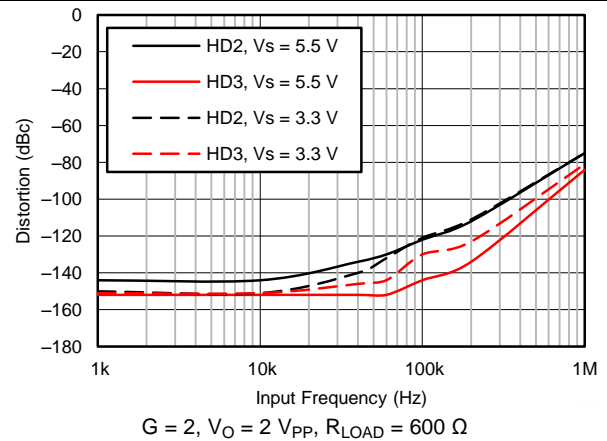

图 20. Total Harmonic Distortion vs Output Voltage for Various Frequencies



图 21. Total Harmonic Distortion vs Frequency for Various Loads

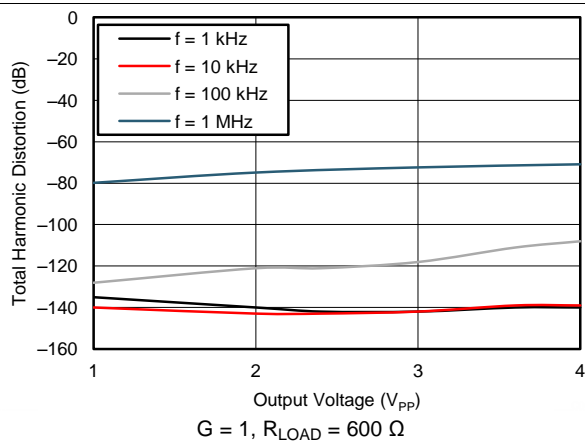

图 22. Voltage Noise Density vs Frequency

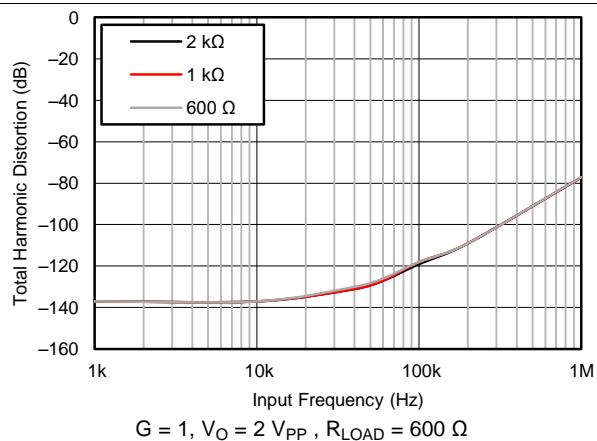

图 23. Current Noise Density vs Frequency

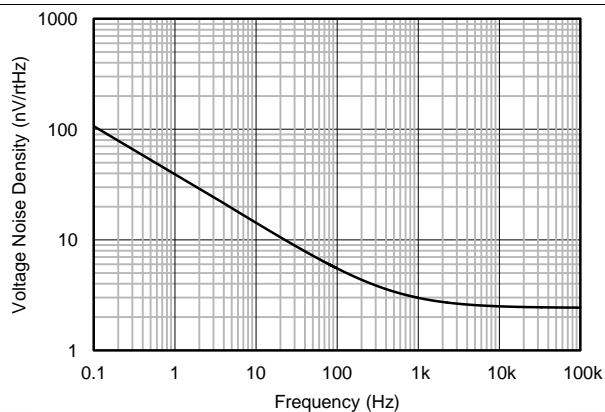

图 24. Crosstalk vs Frequency

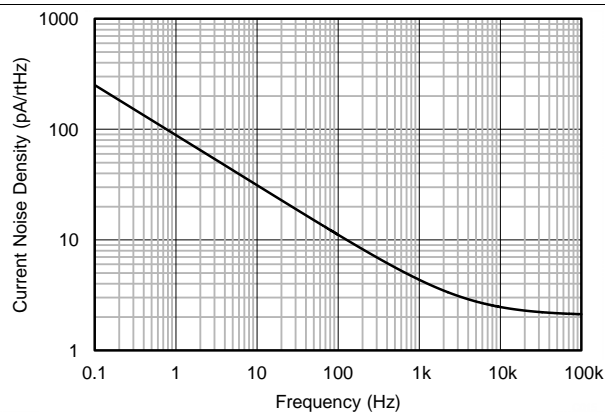

图 25. 0.1-Hz to 10-Hz Voltage Noise

Typical Characteristics (接下页)

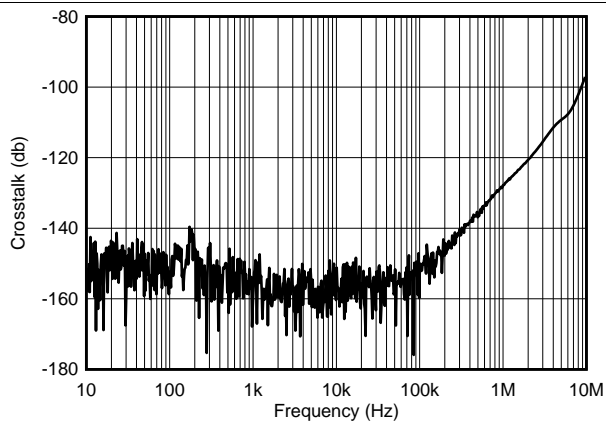
At  $T_A = 25^\circ\text{C}$ ,  $V_+ = 5\text{ V}$ ,  $V_- = 0\text{ V}$ ,  $\text{MODE} = \text{V-}$ ,  $V_{\text{COM}} = V_O = 2.5\text{ V}$ , gain ( $G$ ) = 2,  $R_F = 1\text{ k}\Omega$ ,  $C_F = 2.7\text{ pF}$ ,  $C_{\text{LOAD}} = 20\text{ pF}$ , and  $R_{\text{LOAD}} = 2\text{ k}\Omega$  connected to  $2.5\text{ V}$  (unless otherwise noted)

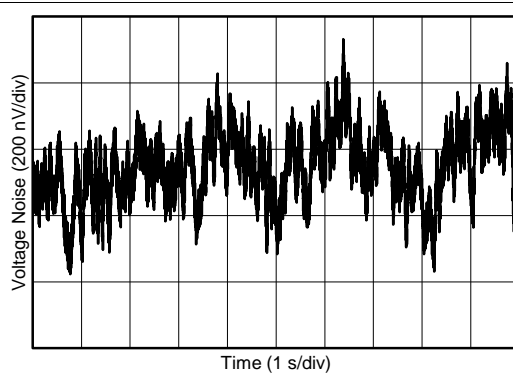

图 26. Slew Rate vs Output Step Size



图 27. Maximum Output Voltage vs Frequency

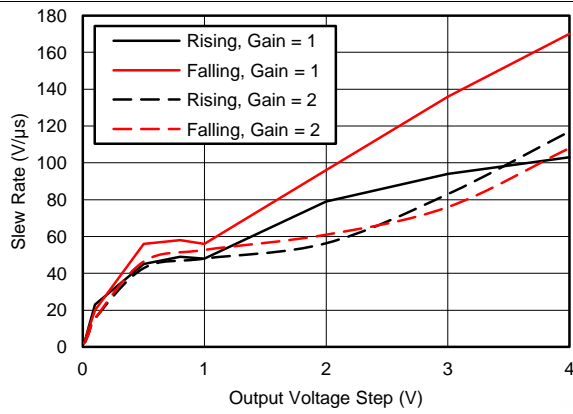

$G = 1$ ,  $V_O = 4\text{-V step}$

图 28. Large-Signal Pulse Response

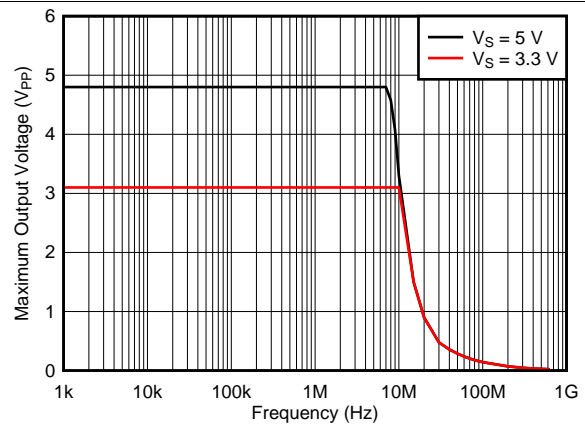
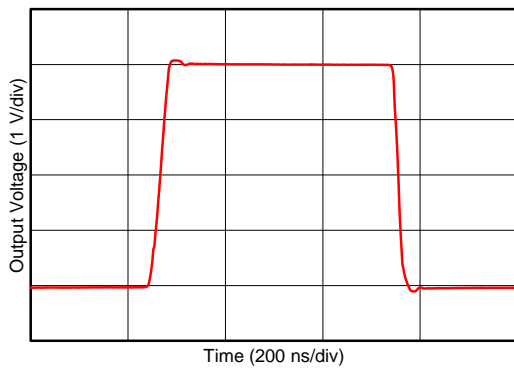
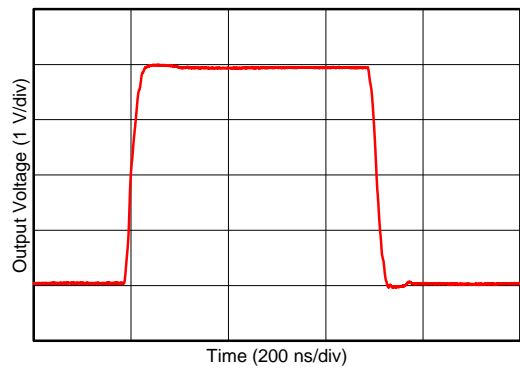

$G = -1$ ,  $V_O = 4\text{-V step}$

图 29. Large-Signal Pulse Response

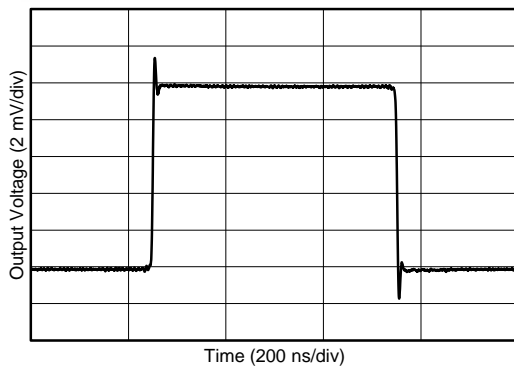

$G = 1$ ,  $V_O = 10\text{-mV step}$

图 30. Small-Signal Pulse Response

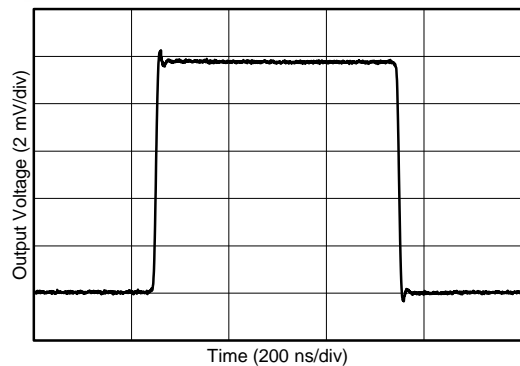

$G = -1$ ,  $V_O = 10\text{-mV step}$

图 31. Small-Signal Pulse Response



Typical Characteristics (接下页)

At  $T_A = 25^\circ\text{C}$ ,  $V_+ = 5\text{ V}$ ,  $V_- = 0\text{ V}$ ,  $\text{MODE} = V_-$ ,  $V_{\text{COM}} = V_O = 2.5\text{ V}$ , gain ( $G$ ) = 2,  $R_F = 1\text{ k}\Omega$ ,  $C_F = 2.7\text{ pF}$ ,  $C_{\text{LOAD}} = 20\text{ pF}$ , and  $R_{\text{LOAD}} = 2\text{ k}\Omega$  connected to  $2.5\text{ V}$  (unless otherwise noted)



图 32. 16-Bit Negative Settling Time



图 33. 16-Bit Positive Settling Time

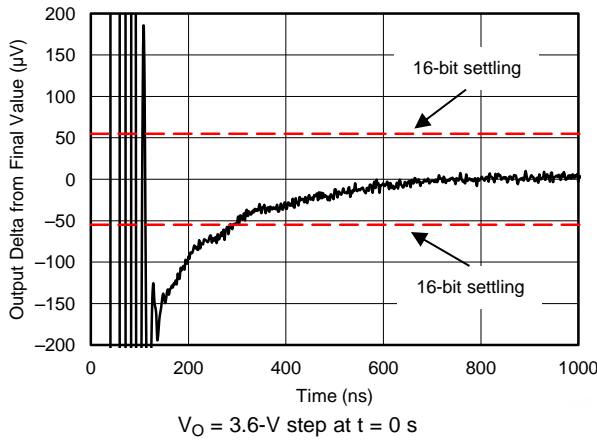

图 34. No Phase Reversal

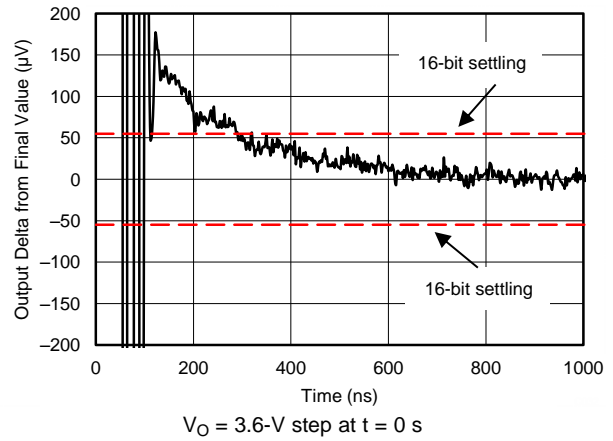

图 35. Positive Overload Recovery

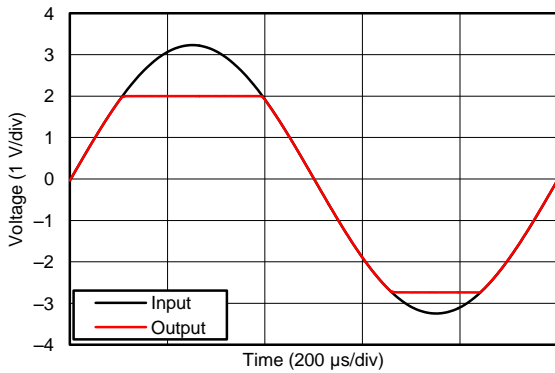

图 36. Negative Overload Recovery

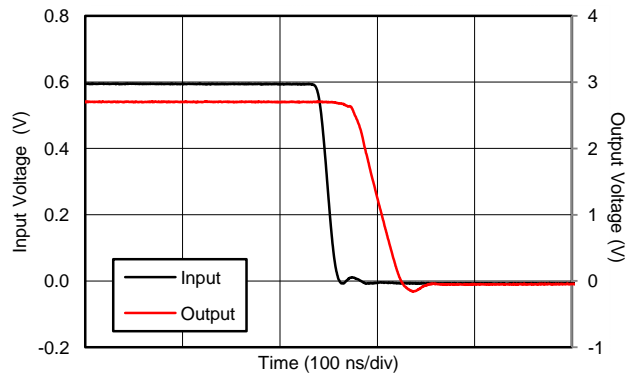

图 37. Input Offset Voltage Distribution

Typical Characteristics (接下页)

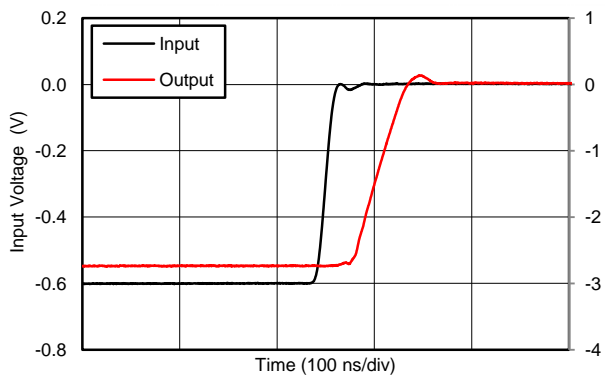
At  $T_A = 25^\circ\text{C}$ ,  $V_+ = 5\text{ V}$ ,  $V_- = 0\text{ V}$ ,  $\text{MODE} = V_-$ ,  $V_{\text{COM}} = V_O = 2.5\text{ V}$ , gain ( $G$ ) = 2,  $R_F = 1\text{ k}\Omega$ ,  $C_F = 2.7\text{ pF}$ ,  $C_{\text{LOAD}} = 20\text{ pF}$ , and  $R_{\text{LOAD}} = 2\text{ k}\Omega$  connected to  $2.5\text{ V}$  (unless otherwise noted)

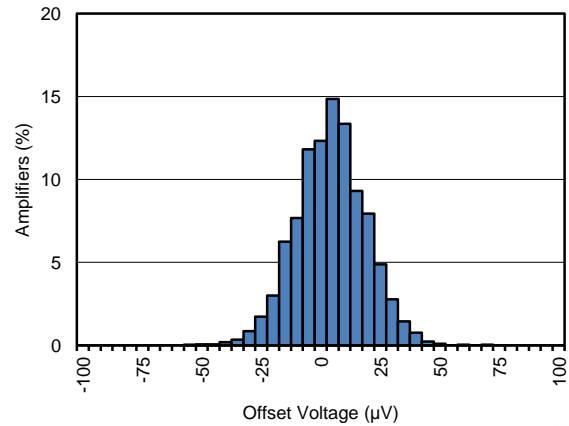

图 38. Input Offset Voltage Distribution



图 39. Input Offset Voltage Distribution

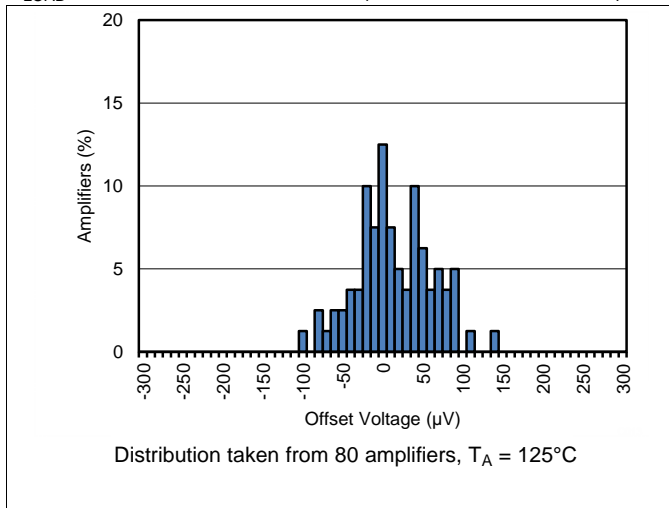

图 40. Input Offset Voltage Distribution

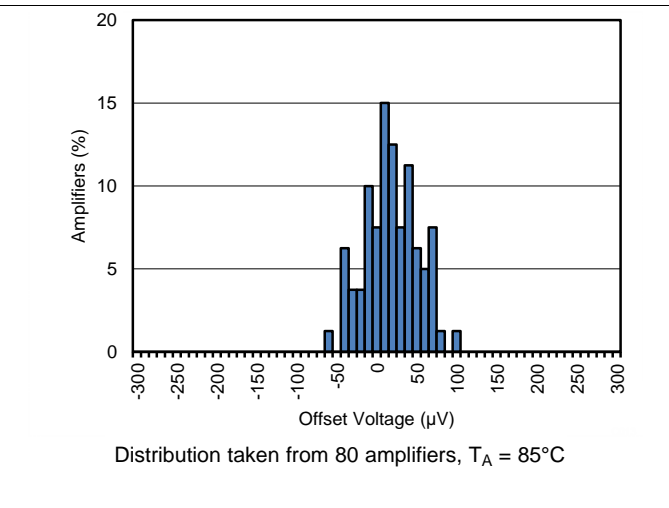

图 41. Input Offset Voltage vs Temperature

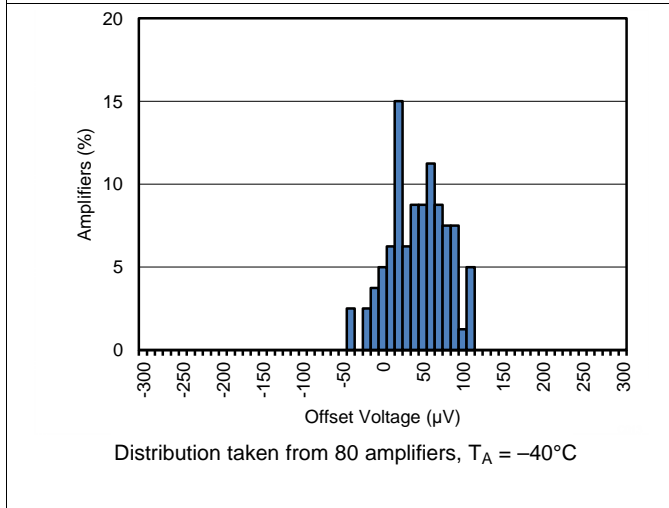

图 42. Input Offset Voltage Drift Distribution

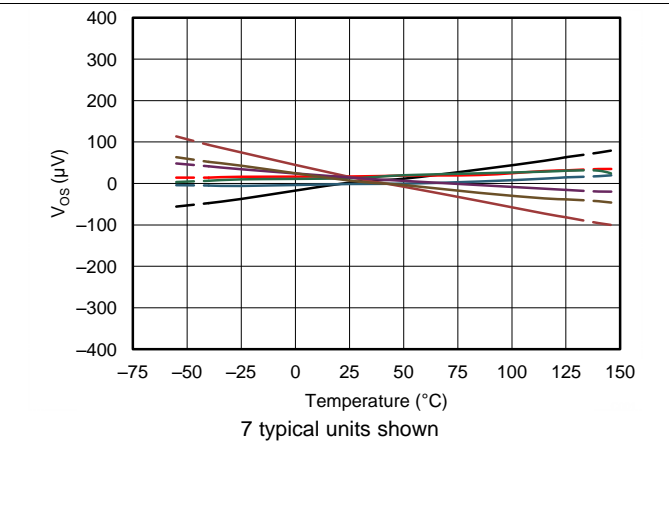

图 43. Input Bias Current Distribution

Typical Characteristics (接下页)

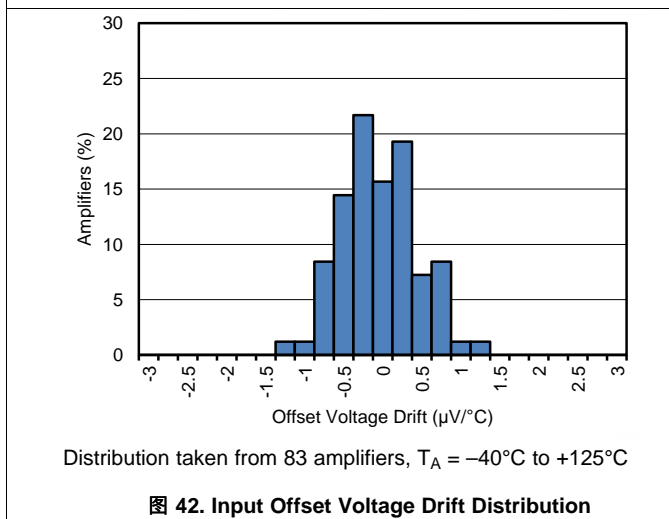
At  $T_A = 25^\circ\text{C}$ ,  $V_+ = 5\text{ V}$ ,  $V_- = 0\text{ V}$ ,  $\text{MODE} = \text{V-}$ ,  $V_{\text{COM}} = V_O = 2.5\text{ V}$ , gain ( $G$ ) = 2,  $R_F = 1\text{ k}\Omega$ ,  $C_F = 2.7\text{ pF}$ ,  $C_{\text{LOAD}} = 20\text{ pF}$ , and  $R_{\text{LOAD}} = 2\text{ k}\Omega$  connected to  $2.5\text{ V}$  (unless otherwise noted)

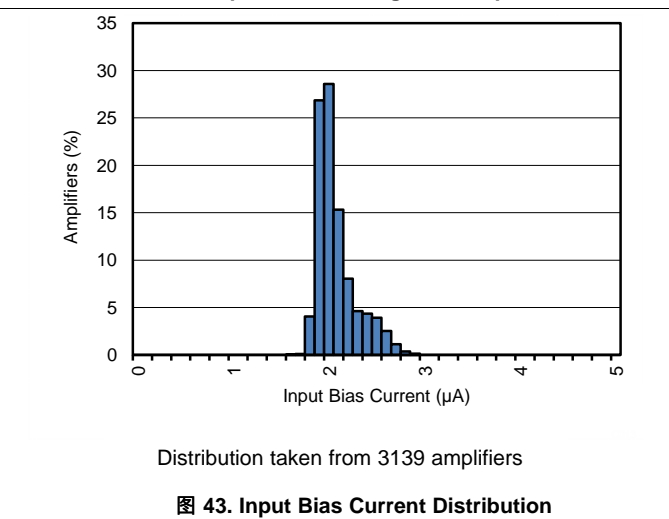

图 44. Input Bias Current vs Temperature



Distribution taken from 3139 amplifiers

图 45. Input Offset Current Distribution

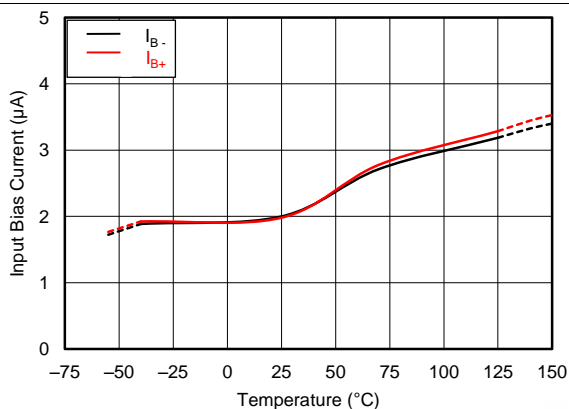
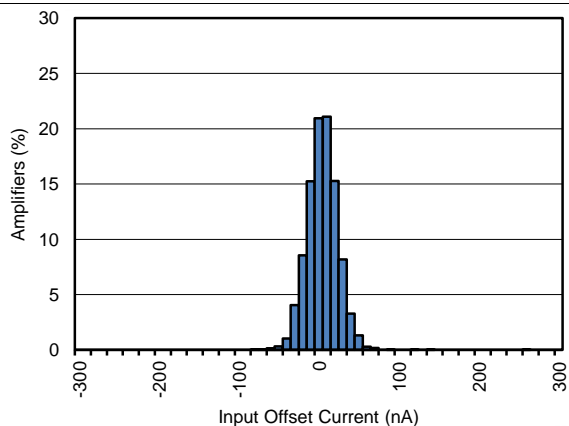

图 46. Input Offset Current vs Temperature



图 47. Common-Mode Rejection Ratio vs Temperature

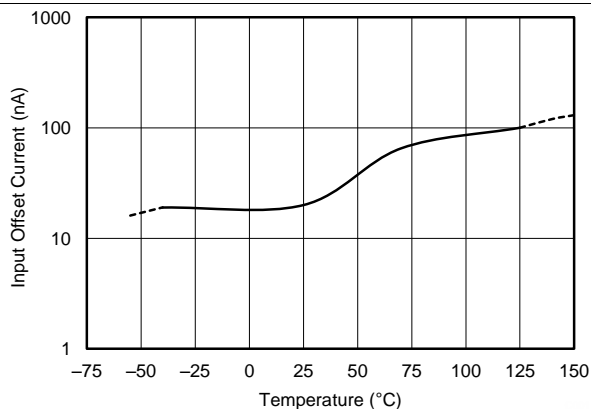

图 48. Power-Supply Rejection Ratio vs Temperature

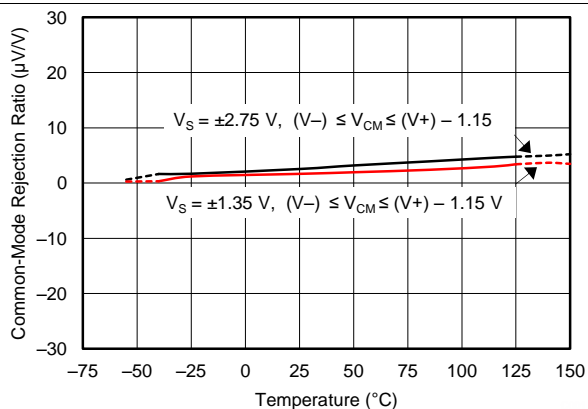

图 49. Open-Loop Gain vs Temperature with 10-kΩ Load

Typical Characteristics (接下页)

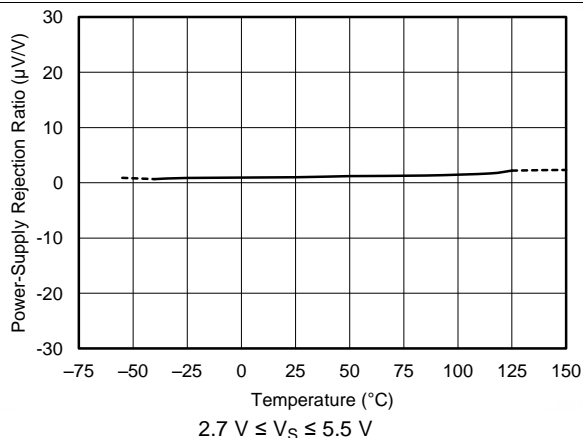
At  $T_A = 25^\circ\text{C}$ ,  $V_+ = 5\text{ V}$ ,  $V_- = 0\text{ V}$ , MODE = V-,  $V_{\text{COM}} = V_O = 2.5\text{ V}$ , gain (G) = 2,  $R_F = 1\text{ k}\Omega$ ,  $C_F = 2.7\text{ pF}$ ,  $C_{\text{LOAD}} = 20\text{ pF}$ , and  $R_{\text{LOAD}} = 2\text{ k}\Omega$  connected to 2.5 V (unless otherwise noted)

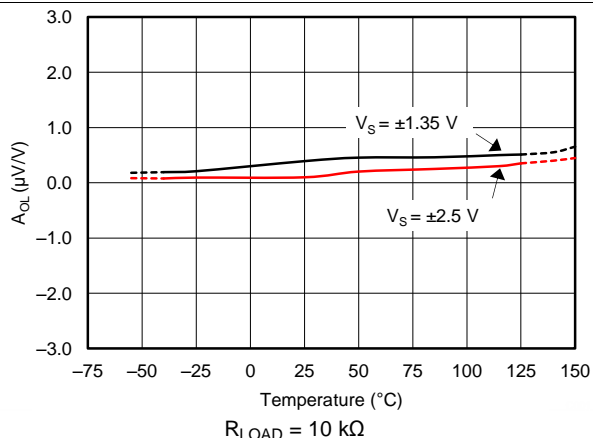

图 50. Open-Loop Gain vs Temperature with 600-Ω Load



图 51. Input Bias Current vs Input Common-Mode Voltage

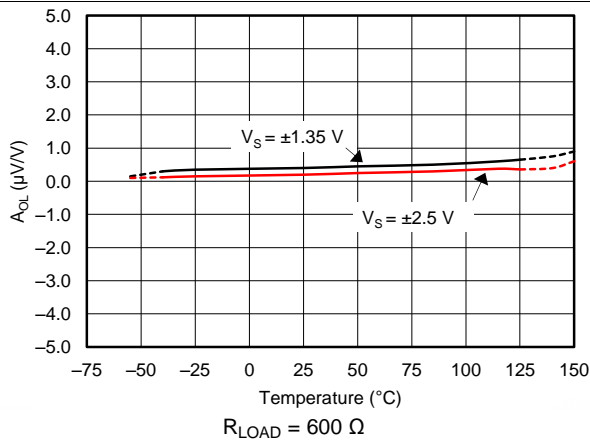

图 52. Input Offset Voltage vs Power-Supply Voltage

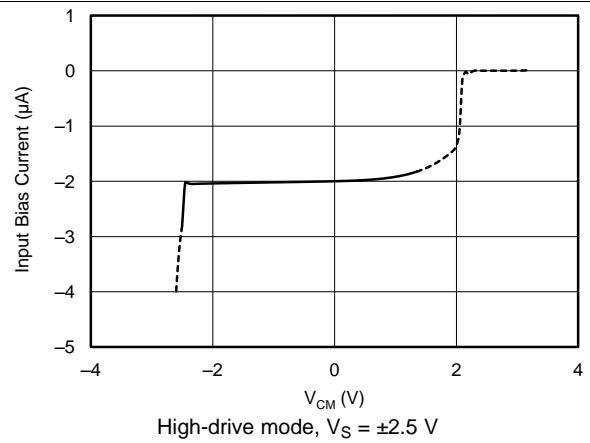

图 53. Input Offset Voltage vs Common-Mode Voltage

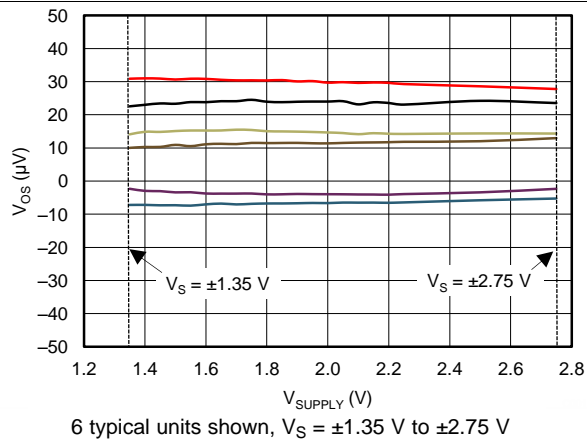

图 54. Output Voltage vs Output Current

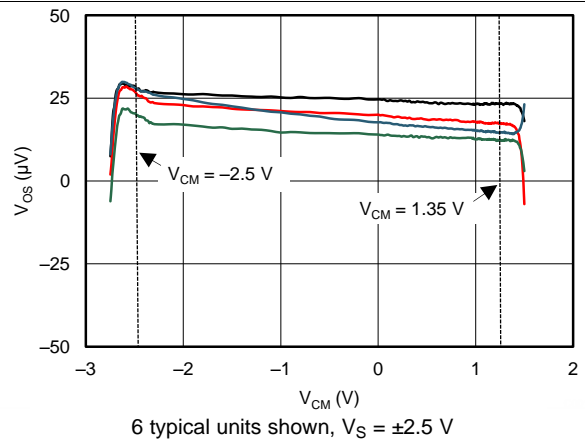

图 55. Short-Circuit Current vs Temperature

Typical Characteristics (接下页)

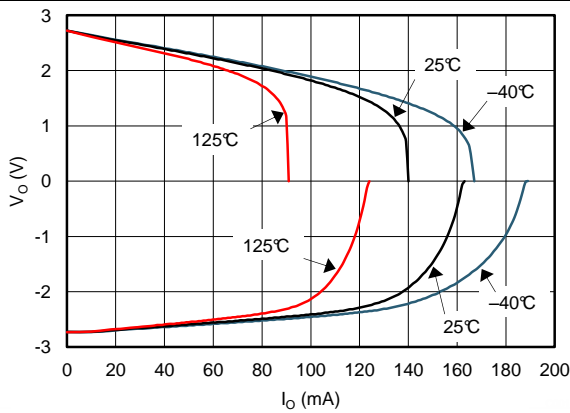
At  $T_A = 25^\circ\text{C}$ ,  $V_+ = 5\text{ V}$ ,  $V_- = 0\text{ V}$ ,  $\text{MODE} = V_-$ ,  $V_{\text{COM}} = V_O = 2.5\text{ V}$ , gain ( $G$ ) = 2,  $R_F = 1\text{ k}\Omega$ ,  $C_F = 2.7\text{ pF}$ ,  $C_{\text{LOAD}} = 20\text{ pF}$ , and  $R_{\text{LOAD}} = 2\text{ k}\Omega$  connected to  $2.5\text{ V}$  (unless otherwise noted)

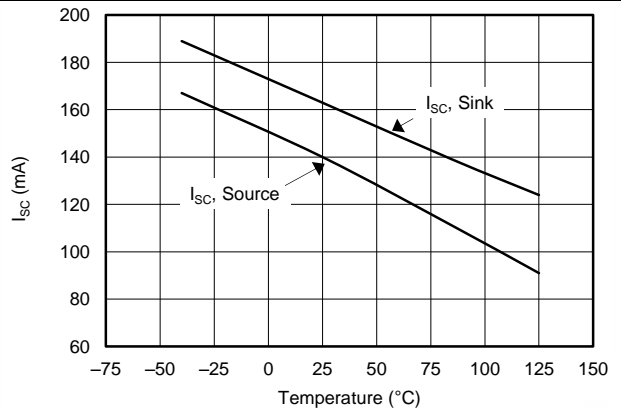

图 56. High-Drive Mode Quiescent Current vs Power-Supply Voltage



图 57. High-Drive Mode Quiescent Current vs Temperature

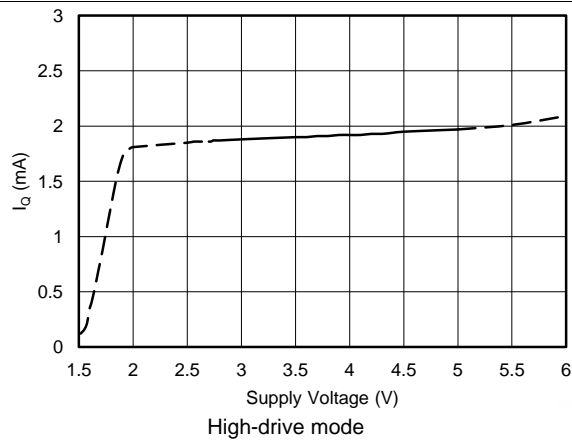

图 58. Low-Power Mode Quiescent Current vs Temperature

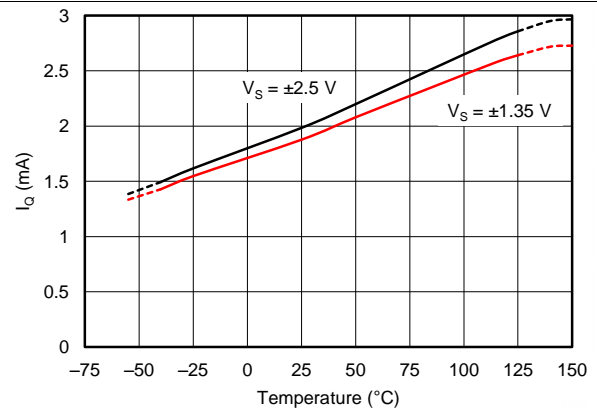

图 59. Low-Power Mode Quiescent Current vs Power-Supply Voltage

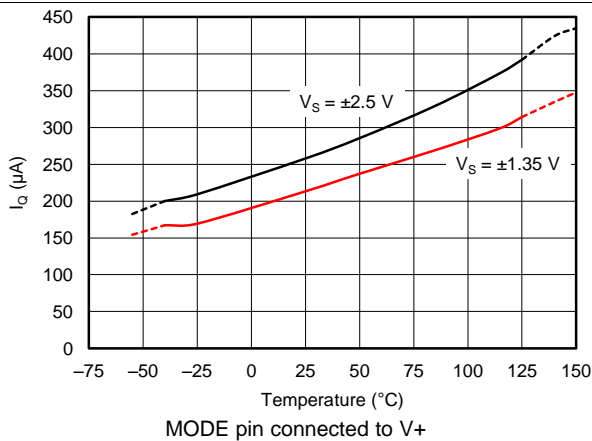

图 60. Quiescent Current When MODE transitions From High To Low

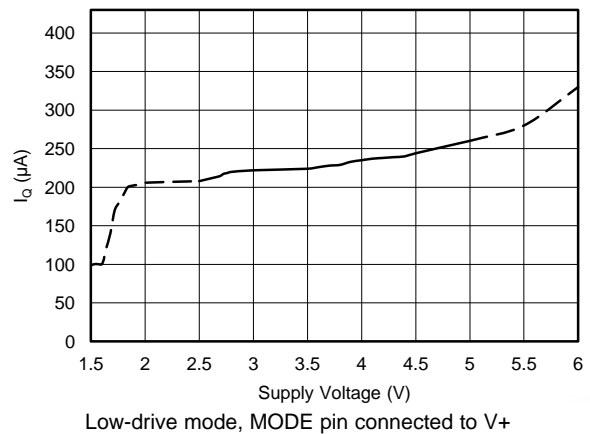

图 61. Quiescent Current When MODE Transitions From Low To High

Typical Characteristics (接下页)

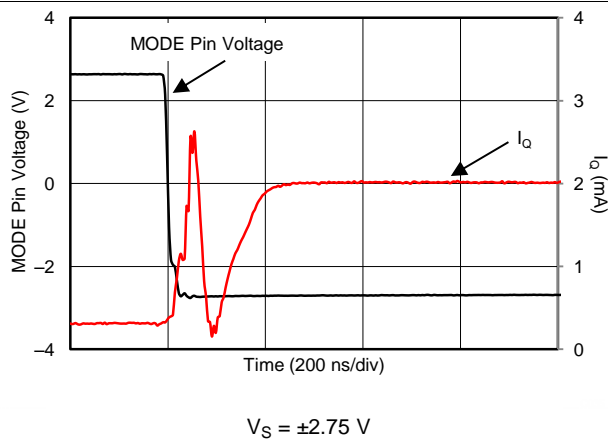
At  $T_A = 25^\circ\text{C}$ ,  $V_+ = 5\text{ V}$ ,  $V_- = 0\text{ V}$ ,  $\text{MODE} = V_-$ ,  $V_{\text{COM}} = V_O = 2.5\text{ V}$ , gain ( $G$ ) = 2,  $R_F = 1\text{ k}\Omega$ ,  $C_F = 2.7\text{ pF}$ ,  $C_{\text{LOAD}} = 20\text{ pF}$ , and  $R_{\text{LOAD}} = 2\text{ k}\Omega$  connected to  $2.5\text{ V}$  (unless otherwise noted)

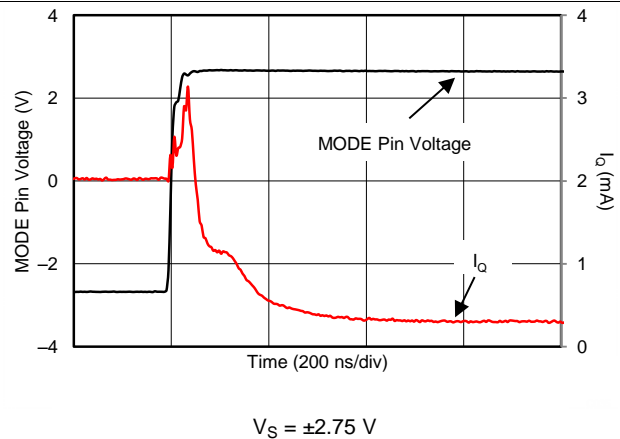
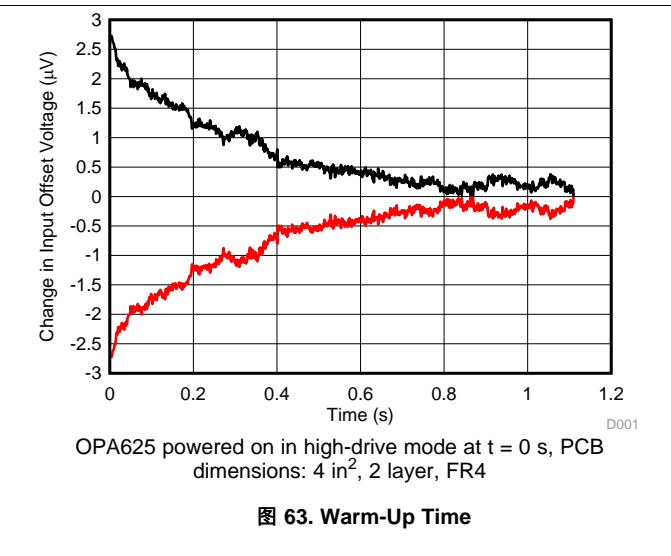
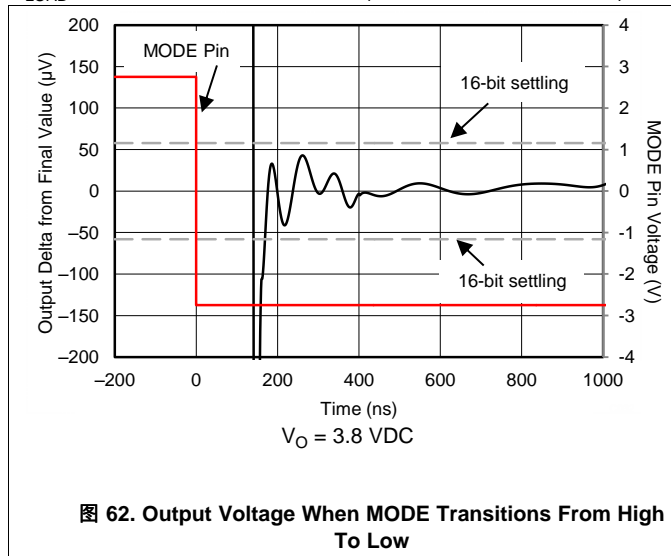

## 7 Parameter Measurement Information

### 7.1 DC Parameter Measurements

The circuit shown in 图 64 is used to measure the dc input offset related parameters of the OPAx625. Input offset voltage, power supply rejection ratio, common mode rejection ratio and open loop gain can be measured with this circuit. The basic test procedure requires setting the inputs (the power-supply voltage,  $V_S$ , and the common-mode voltage,  $V_{CM}$ ), to the desired values.  $V_O$  is set to the desired value by adjusting the loop-drive voltage while measuring  $V_O$ . After all inputs are configured, measure the input offset at the  $V_X$  measurement point. Calculate the input offset voltage by dividing the measured result by 101. Changing the voltages on the various inputs changes the input offset voltage. The input parameters can be measured according to the relationships illustrated in 公式 1 through 公式 5.



图 64. DC-Parameters Measurement Circuit

$$V_{OS} = \frac{V_X}{101} \tag{1}$$

$$V_{OSDrift} = \frac{\Delta V_{OS}}{\Delta \text{Temperature}} \tag{2}$$

$$PSRR = \frac{\Delta V_{OS}}{\Delta V_{SUPPLY}} \tag{3}$$

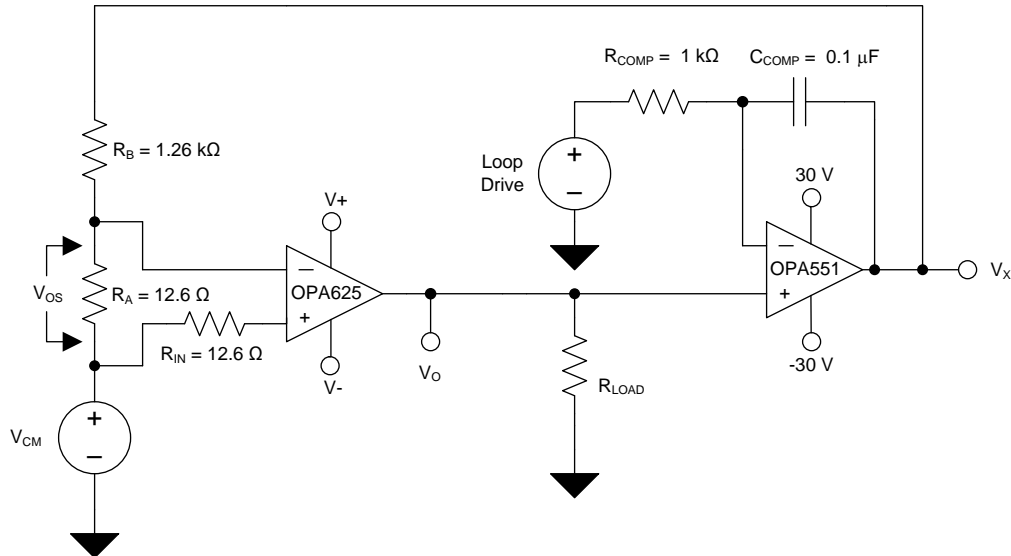
$$CMRR = \frac{\Delta V_{OS}}{\Delta V_{CM}} \tag{4}$$

$$AOL = \frac{\Delta V_O}{\Delta V_{OS}} \tag{5}$$

### 7.2 Transient Parameter Measurements

The circuit shown in 图 65 is used to measure the transient response of the OPAx625. Configure  $V+$ ,  $V-$ ,  $R_{ISO}$ ,  $R_{LOAD}$ , and  $C_{LOAD}$  as desired. Monitor the input and output voltages on an oscilloscope or other signal analyzer. Use this circuit to measure large-signal and small-signal transient response, slew rate, overshoot, and capacitive-load stability.



图 65. Pulse-Response Measurement Circuit

### 7.3 AC Parameter Measurements

The circuit shown in 图 66 is used to measure the ac parameters of the OPAx625. Configure  $V+$ ,  $V-$ , and  $C_{LOAD}$  as desired. The THS4271 are used to buffer the input and output of the OPAx625 to prevent loading by the gain phase analyzer. Monitor the input and output voltages on a gain phase analyzer. Use this circuit to measure the gain bandwidth product, and open-loop gain versus frequency versus capacitive load.

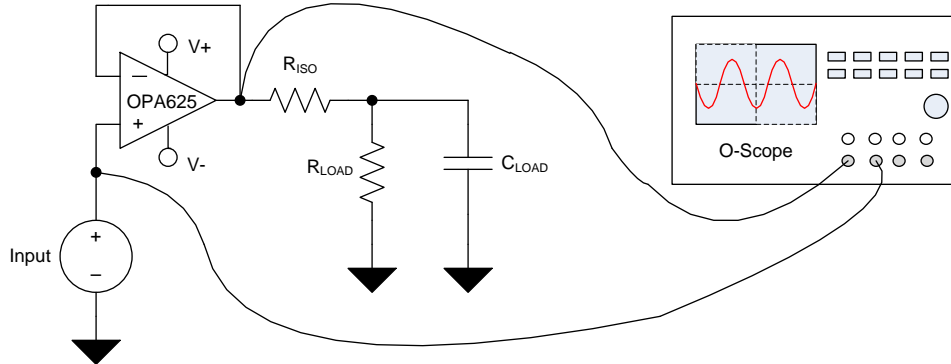

图 66. AC-Parameters Measurement Circuit



### 7.4 Noise Parameter Measurements

The circuit shown in 图 67 is used to measure the voltage noise of the OPAx625. Configure V+, V–, and C<sub>LOAD</sub> as desired.

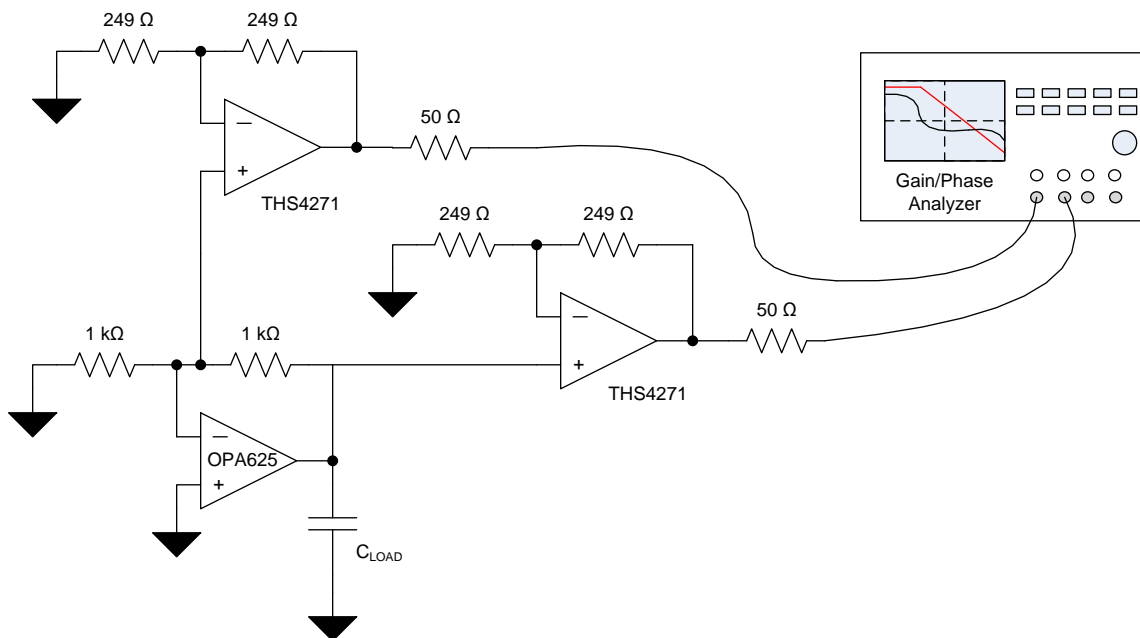

图 67. Voltage Noise Measurement Circuit

The circuit shown in 图 68 is used to measure the current noise of the OPAx625. Configure V+, V– and C<sub>LOAD</sub> as desired.

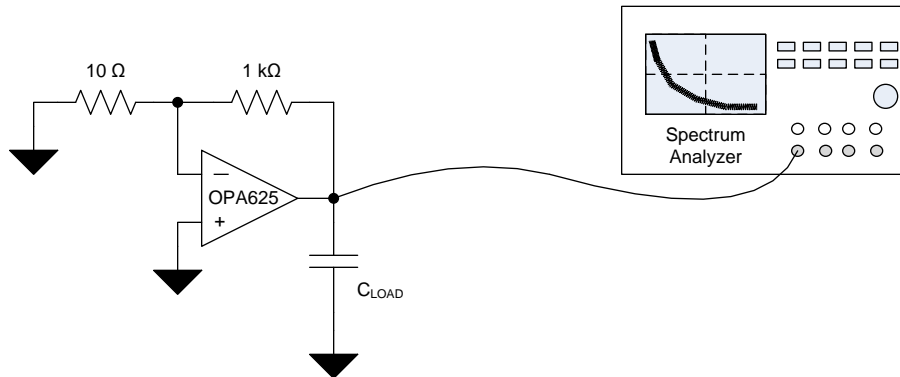

图 68. Current Noise Measurement Circuit

The circuit shown in 图 69 is used to measure the OPAx625 0.1-Hz to 10-Hz voltage noise. Configure V+, V–, and C<sub>LOAD</sub> as desired.

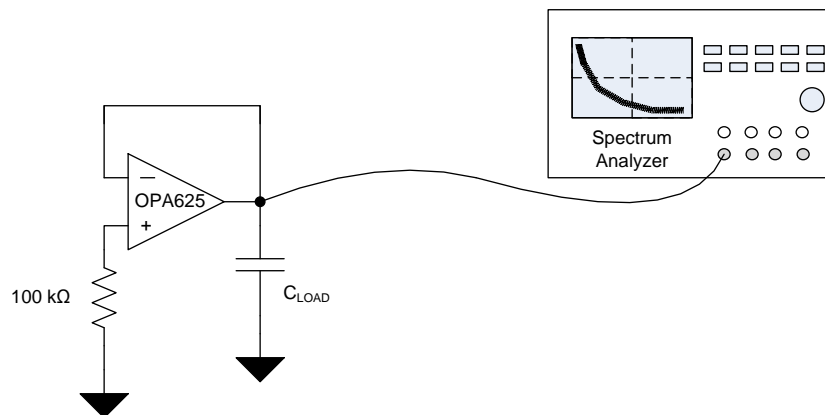

图 69. 0.1-Hz to 10-Hz Voltage-Noise Measurement Circuit

## 8 Detailed Description

### 8.1 Overview

The OPAx625 is a fast-settling, high slew rate, high-bandwidth, voltage-feedback operational amplifier. Low offset and low offset drift combine with the superior dynamic performance and very low output impedance, resulting in an amplifier suited for driving 16-bit SAR ADCs, and buffering precision voltage references in industrial applications. The OPAx625 is comprised of a low-noise input stage, a slew boost stage, and a rail-to-rail output stage. A mode bias select feature allows the OPAx625 to be configured in a high-drive mode and a low-power mode. High-drive mode is used when driving SAR ADCs during the ADC signal acquisition period. The OPAx625 is also configurable in low-power mode while the SAR ADC is converting the acquired signal, thus saving overall system power. To facilitate a fast transition from low-power mode to high-drive mode, the OPAx625 does not completely shut down while in low-power mode; rather, the device remains as an active amplifier with a lower bandwidth (1 MHz) and relaxed dc specifications.

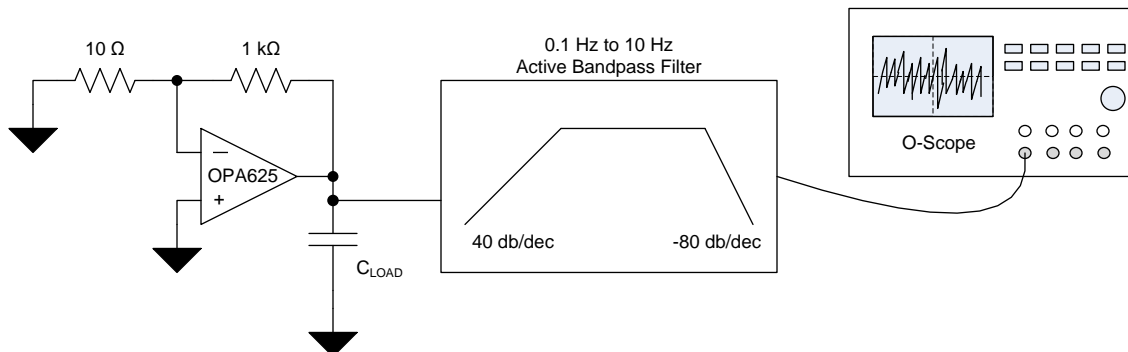
### 8.2 Functional Block Diagram

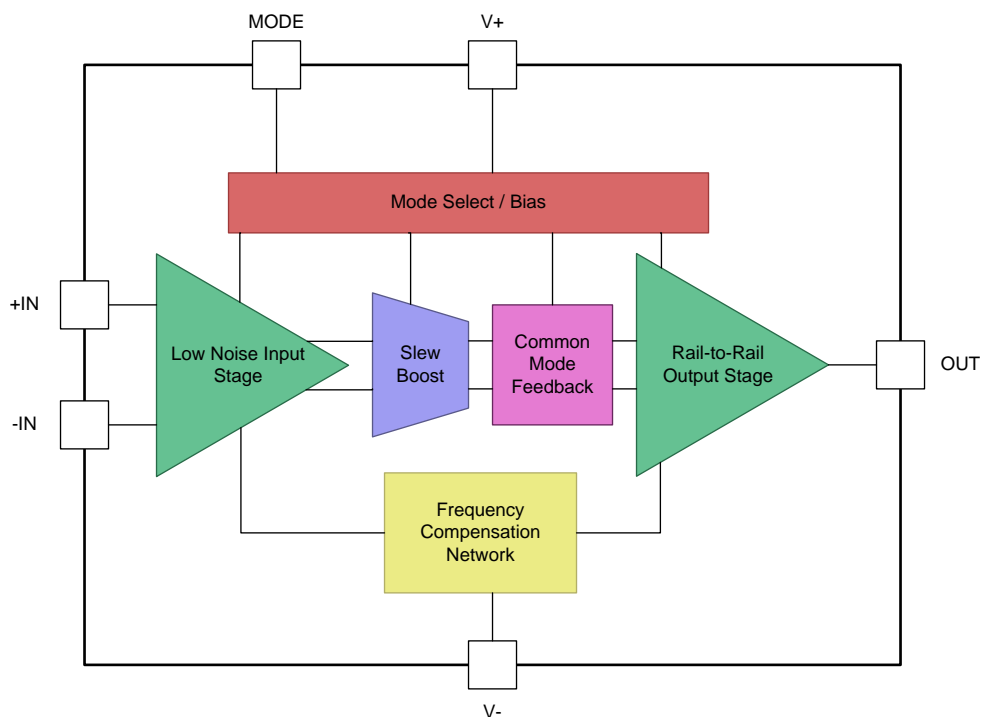

## 8.3 Feature Description

### 8.3.1 SAR ADC Driver

The OPA625 is designed to drive precision (16-bit and 18-bit) SAR ADCs at sample rates up to 1 MSPS. The combination of low output impedance, low THD, low noise, and fast settling time make the OPA625 the ideal choice for driving both the SAR ADC inputs, as well as the reference input to the ADC. Internal slew boost circuitry increases the slew rate as a function of the input signal magnitude, resulting in settling from a 4-V step input to 16-bit levels within 280 ns. Low output impedance ( $1\ \Omega$  at 1 MHz) ensures capacitive load stability with minimal overshoot.

### 8.3.2 Electrical Overstress

Designers often ask questions about the capability of an operational amplifier to withstand electrical overstress (EOS). These questions tend to focus on the device inputs, but may involve the supply voltage pins or even the output pin. Each of these different pin functions have electrical stress limits determined by the voltage breakdown characteristics of the particular semiconductor fabrication process and specific circuits connected to the pin. Additionally, internal electrostatic discharge (ESD) protection is built into these circuits to protect them from accidental ESD events both before and during product assembly. Having a good understanding of this basic ESD circuitry and its relevance to an electrical overstress event is helpful. See [Figure 70](#) for an illustration of the ESD circuits contained in the OPA625. The ESD protection circuitry involves several current-steering diodes connected from the input and output pins and routed back to the internal power-supply lines, where the diodes meet at an absorption device or the power-supply ESD cell, internal to the operational amplifier. This protection circuitry is intended to remain inactive during normal circuit operation.



图 70. Simplified ESD Circuit

## 8.4 Device Functional Modes

The OPAx625 has two functional modes: high-drive and low-power. In low-power mode, the quiescent current of the OPAx625 is reduced to 270  $\mu\text{A}$  (typ), and results in significantly lower bandwidth, higher noise, and lower output current drive. The OPAx625 transitions from low-power mode to high-drive mode in 170 ns.

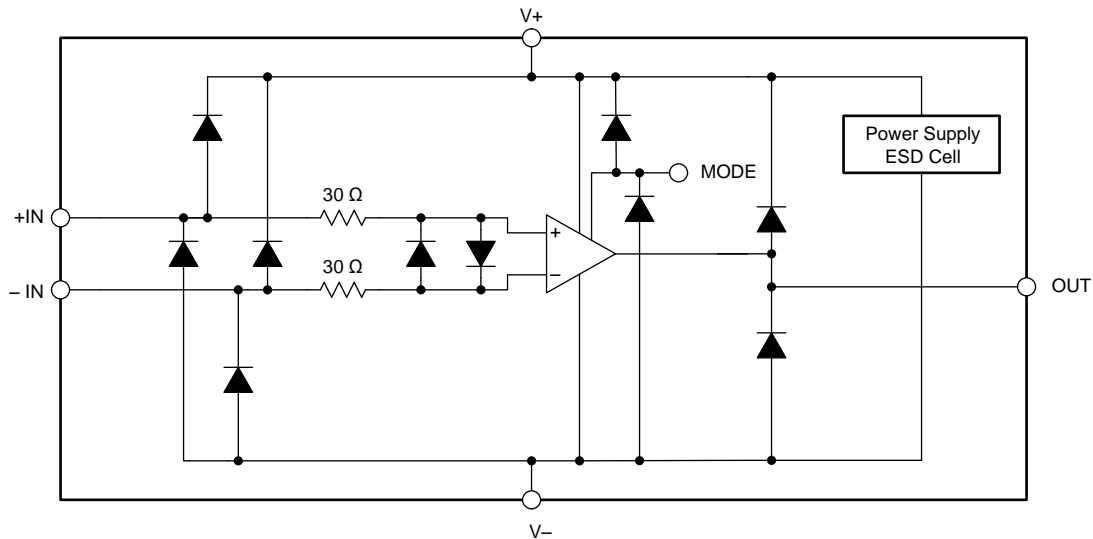
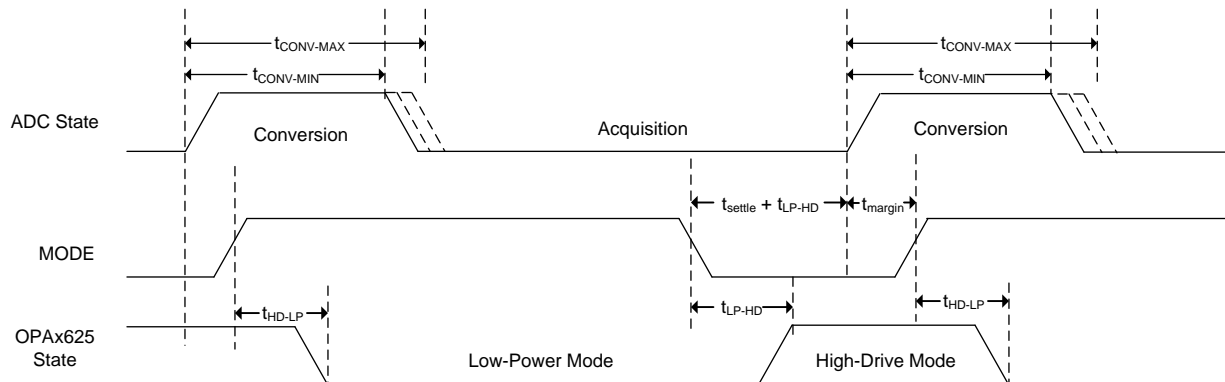

**图 71. Simplified Timing Diagram: Power-Scaling Precision Signal Chain**

### 8.4.1 High-Drive Mode

Place the OPAx625 into high-drive mode by applying a logic level low to the MODE pin. The MODE pin can be driven by a general-purpose input/output (GPIO) from the system controller, from discrete logic gates, or can be connected directly to the V<sub>-</sub> pin. Do not leave the MODE pin floating. When driving the MODE pin from a microcontroller GPIO, make sure that the GPIO is not placed into a high-impedance state. Placing the GPIO into a high impedance state results in the MODE pin essentially floating, and is not recommended. Do not drive the MODE pin voltage below the voltage at the V<sub>-</sub> pin; see the [Absolute Maximum Ratings](#) for the allowable voltage to drive the MODE pin. Use the MODE pin to force the OPAx625 in either the high-drive mode or the low-power mode. The OPAx625 has 120-MHz gain bandwidth, 2.5-nV/ $\sqrt{\text{Hz}}$  input-referred noise, and consumes just 2 mA of quiescent current in high-drive mode. In addition, the OPAx625 also has an offset voltage of 100  $\mu\text{V}$  (max) and offset voltage drift of 1  $\mu\text{V}/^\circ\text{C}$  (typ). This combination of high precision, high speed, and low noise makes this device suitable for use as an input driver for high-precision, high-throughput SAR ADCs such as [ADS88xx](#) family of SAR ADC, as shown in [图 73](#).

In high-drive mode, the OPAx625 is fully specified as a wideband, low-noise, low-distortion precision amplifier. High-drive mode is the primary mode of operation of the OPAx625 when driving the inputs of a SAR ADC during the signal acquisition period just before the start of the conversion period. Placing the OPAx625 into the high-drive mode before the acquisition period is complete, and before the start of the conversion period, allows the OPAx625 to settle to the final value just prior to the conversion. When the ADC is converting the input signal, and therefore no longer acquiring the signal, place the OPAx625 into the low-power mode to reduce system power. Using low-power mode allows the OPAx625 power consumption to scale directly with the sample rate.

The OPAx625 is unique in that the switching between the modes occurs in 170 ns (typ). This fast switching is achieved by the architecture of the OPAx625 during low-power mode; see the [Low-Power Mode](#) section for more information.

## Device Functional Modes (接下页)

### 8.4.2 Low-Power Mode

Place the OPAx625 low-power mode by applying a logic level high to the MODE pin. The MODE pin can be driven by a GPIO from the system controller, from discrete logic gates, or can be connected to directly to the V+ pin. Do not leave the MODE pin floating. When driving the MODE pin from a microcontroller GPIO, make sure that the GPIO is not placed into a high-impedance state. Placing the GPIO into a high-impedance state results in the MODE pin essentially floating, and is not recommended. Do not allow the MODE pin voltage to exceed the voltage at the V+ pin; see the [Absolute Maximum Ratings](#) for the allowable voltage to drive the MODE pin.

In low-power mode, the OPAx625 is fully specified as a general-purpose operational amplifier. The MODE signal can be controlled so that the OPAx625 is placed in high-drive mode just before the ADC enters the acquisition phase. This configuration makes sure that the voltage on the antialiasing filter capacitor settles to the required precision before the acquisition period is complete. The power consumed by the OPAx625 scales with the throughput of the system when operated in this manner. This feature is extremely useful in power-critical applications and variable-throughput data acquisition systems.

The OPAx625 is unique in that the switching between the modes occurs in 170 ns (typ). This fast switching is achieved by the architecture of the OPAx625 during low-power mode. Most amplifiers in power-down or shut-down mode consume very minimal power, but are also not operating in a linear fashion. For example, the output of a typical amplifier, when disabled, can be placed into a high-impedance state, and thus unable to drive any load whatsoever. Switching from a shut-down state to a linear state requires charging internal capacitances and bias points to a level within the linear operating range. Typically, this switch can take several microseconds or longer. This problem is solved with the OPAx625. The OPAx625 operates as a linear operational amplifier in low-power mode, and the output tracks the input signal, but with a lower bandwidth and slightly higher offset and noise. Switching from low-power mode to high-drive mode and settling to 16-bit levels occurs in 170 ns (typ) as a result of maintaining operation in a linear fashion throughout the duration of each mode. This configuration allows for dynamic power scaling, while still maintaining high throughput rates.



图 72. Output Voltage when Mode Pin Changes High to Low

## 9 Application and Implementation

### 注

Information in the following applications sections is not part of the TI component specification, and TI does not warrant its accuracy or completeness. TI's customers are responsible for determining suitability of components for their purposes. Customers should validate and test their design implementation to confirm system functionality.

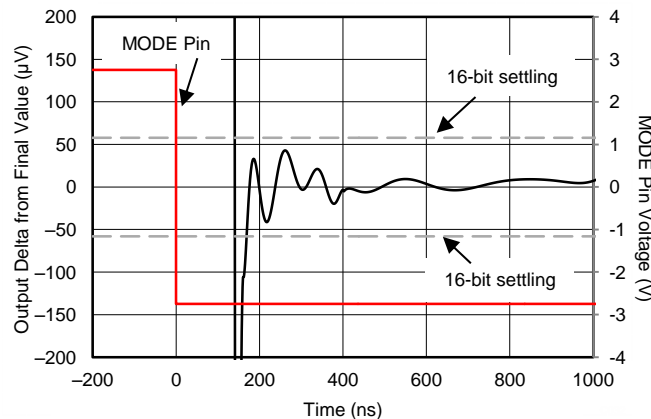
### 9.1 Application Information

The OPAx625 is a precision, high-speed, voltage-feedback operational amplifier. Fast settling to 16-bit levels, low THD, and low noise make the OPAx625 suitable for driving SAR ADC inputs and buffering precision voltage references. With a wide power-supply voltage range from 2.7 V to 5.5 V, and operating from  $-40^{\circ}\text{C}$  to  $+125^{\circ}\text{C}$ , the OPAx625 is suitable for a variety of high-speed, industrial applications. The following sections show application information for the OPAx625. For simplicity, power-supply decoupling capacitors are not shown in these diagrams.

### 9.2 Typical Applications

#### 9.2.1 Single-Supply, 16-Bit, 1-MSPS SAR ADC Driver



图 73. Single-Supply, 16-Bit, 1-MSPS SAR ADC Driver

##### 9.2.1.1 Design Requirements

SAR ADCs, such as the [ADS8860](#), use sampling capacitors on the data converter input. During the signal acquisition phase, these sampling capacitors are connected to the ADC analog input terminals, AINP and AINN, through a set of switches. After the acquisition period has elapsed, the internal sampling capacitors are disconnected from the input terminals and connected to the input of the ADC through a second set of switches, during this period the ADC is performing the analog-to-digital conversion. 图 74 illustrates this architecture.

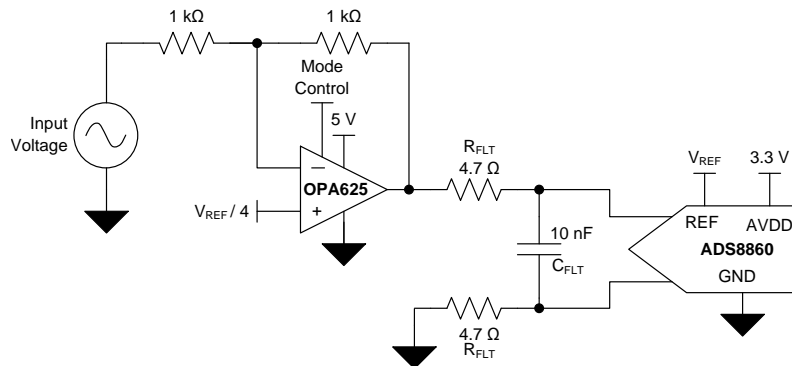

图 74. Simplified SAR ADC Input

## Typical Applications (接下页)

The SAR ADC inputs and sampling capacitors must be driven by the OPA625 to 16-bit levels within the acquisition time of the ADC. For the example illustrated in 图 73, the OPA625 is used to drive the ADS8860 at a sample rate of 1 MSPS.

### 9.2.1.2 Detailed Design Procedure

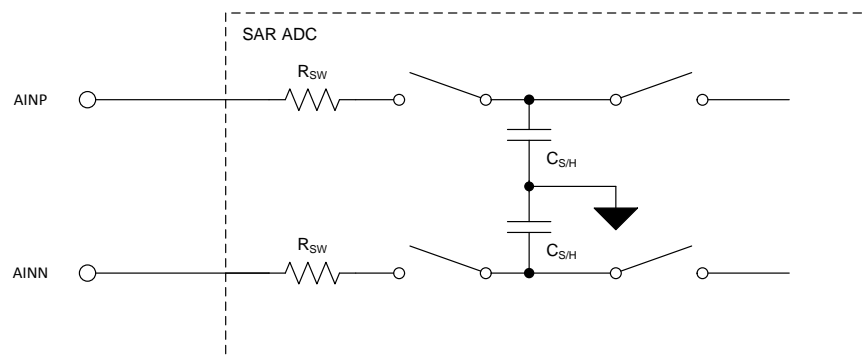
The circuit illustrated in 图 73 consists of the SAR ADC driver, a low-pass filter and the SAR ADC. The SAR ADC driver circuit consists of an OPA625 configured in an inverting gain of 1. The filter consists of  $R_{FLT}$  and  $C_{FLT}$ , connected between the output of the OPA625 and input of the ADS8860. Selecting the proper values for each of these passive components is critical to obtain the best performance from the ADC. Capacitor  $C_{FLT}$  serves as a charge reservoir, providing the necessary charge to the ADC sampling capacitors. The dynamic load presented by the ADC creates a glitch on the filter capacitor,  $C_{FLT}$ . To minimize the magnitude of this glitch, choose a value for  $C_{FLT}$  large enough to maintain a glitch amplitude of less than 100 mV. Maintaining such a low glitch amplitude at the amplifier output makes sure that the amplifier remains in the linear operating region, and results in a minimum settling time. Using 公式 6, a 10-nF capacitor is selected for  $C_{FLT}$ .

$$C_{FLT} \geq 15 \times C_{SH} \quad (6)$$

Connecting a 10-nF capacitor directly to the output of the OPA625 degrades the OPA625 phase margin and results in stability and settling-time problems. To properly drive the 10-nF capacitor, use a series resistor ( $R_{FLT}$ ) to isolate the capacitor,  $C_{FLT}$ , from the OPA625.  $R_{FLT}$  must be sized based upon several constraints. To determine a suitable value for  $R_{FLT}$ , consider the impact upon the THD due to the voltage divider effect from  $R_{FLT}$  reacting with the switch resistance ( $R_{SW}$ ) of the ADC input circuit, as well as the impact of the output impedance upon amplifier stability. In this example, 4.7- $\Omega$  resistors are selected. In this design example, 图 16 can be used to estimate a suitable value for  $R_{ISO}$ .  $R_{ISO}$  represents the total resistance in series with  $C_{FLT}$ , and in this example is equivalent to  $2 \times R_{FLT}$ .



For step-by-step design procedure, circuit schematics, bill of materials, printed circuit board (PCB) files, simulation results, and test results, refer to TI Precision Design, TIDU014, "Power-optimized 16-bit 1MSPS Data Acquisition Block for Lowest Distortion and Noise Reference Design".

### 9.2.1.3 Application Curves

图 75 illustrates the performance of the circuit shown in 图 73.

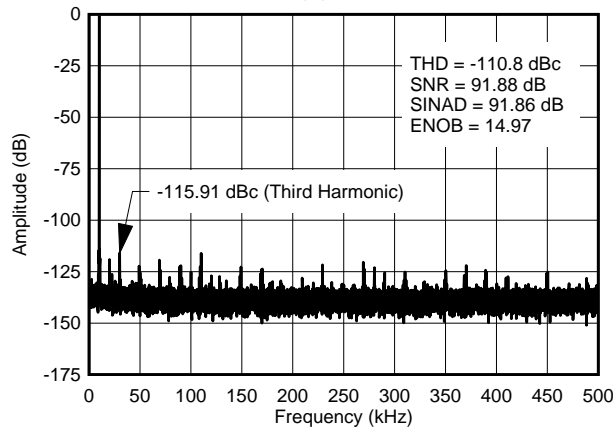

4096-point FFT at 1 MSPS,  $f_{IN} = 10$  kHz,  $V_{IN} = 1.5 V_{RMS}$

图 75. ADC Output FFT for 图 73

### 9.2.2 Single-Supply, 16-Bit, 1-MSPS, Multiplexed, SAR ADC Driver

In order to operate a high-resolution, 16-bit ADC at its maximum throughput, the full-scale voltage step must settle to better than 16-bit accuracy at the ADC inputs within the minimum specified acquisition time ( $t_{ACQ}$ ). This settling imposes very stringent requirements on the driver amplifier in terms of large-signal bandwidth, slew rate, and settling time. illustrates a typical multiplexed ADC driver application using the OPA625.



图 76. Single-Supply, 16-Bit, 1-MSPS, Multiplexed, SAR ADC Driver

#### 9.2.2.1 Design Requirements

To optimize this circuit for performance, this design does not allow any large signal input transients at the inputs of the driver circuit for a small quiet-time period ( $t_{QT}$ ) towards the end of the previous conversion. The input step voltage can appear anytime from the beginning of conversion (CONVST rising edge) until the elapse of a half cycle time ( $0.5 \times t_{CYC}$ ). This timing constraint on the input step allows a minimum settling time of ( $t_{QT} + t_{ACQ}$ ) for the ADC input to settle within the required accuracy, in the worst-case scenario. This provides more time for the amplifier's output to slew and settle within the required accuracy before the next conversion starts. illustrates this timing sequence.

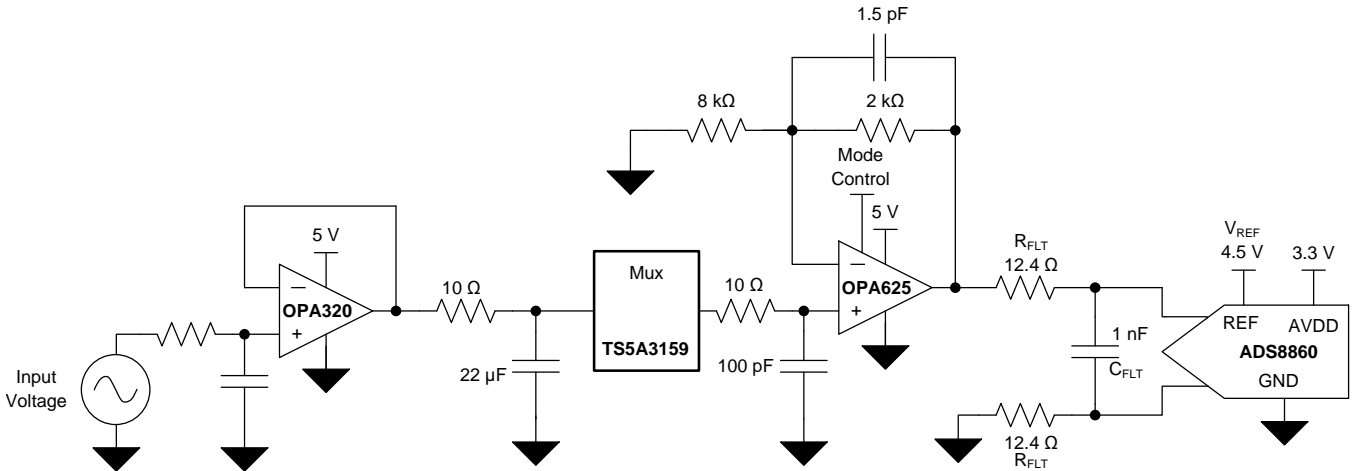

图 77. Timing Diagram for Input Signals



### 9.2.2.2 Detailed Design Procedure

An ADC input driver circuit mainly consists of two parts: a driving amplifier and a fly-wheel RC filter. The amplifier is used for signal conditioning of the input voltage and its low output impedance provides a buffer between the signal source and the ADC input. The RC filter helps attenuate the sampling charge-injection from the switched-capacitor input stage of the ADC as well as acts as an anti-aliasing filter to band-limit the wideband noise contributed by the front-end circuit. The design of the ADC input driver involves optimizing the bandwidth of the circuit, driven primarily by the following requirements:

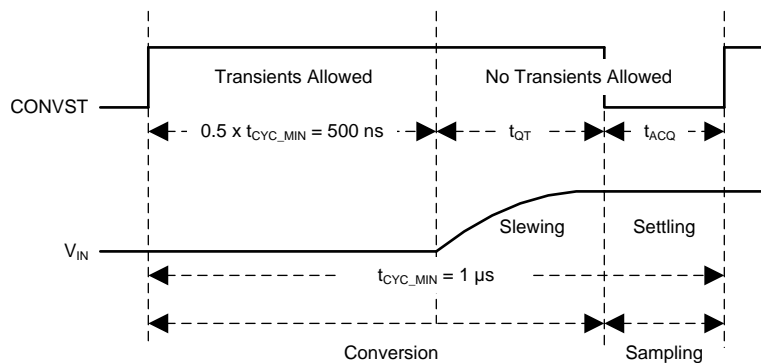
- The  $R_{FLT}C_{FLT}$  filter bandwidth should be low to band-limit the noise fed into the input of the ADC thereby increasing the signal-to-noise ratio (SNR) of the system.
- The overall system bandwidth should be large enough to accommodate optimal settling of the input signal at the ADC input before the start of conversion.

$C_{FLT}$  is chosen based upon 公式 7 .  $C_{FLT}$  is chosen to be 1 nF.

$$C_{FLT} \geq 15 \times C_{SH} \tag{7}$$

Connecting a 1-nF capacitor directly to the output of the OPA625 would degrade the OPA625 phase margin and result in stability and settling time problems. To properly drive the 1-nF capacitor, a series resistor,  $R_{FLT}$ , is used to isolate the capacitor,  $C_{FLT}$ , from the OPA625.  $R_{FLT}$  must be sized based upon several constraints. To determine a suitable value for  $R_{FLT}$ , the system designer must consider the impact upon the THD due to the voltage divider effect from  $R_{FLT}$  reacting with the switch resistance,  $R_{SW}$ , of the ADC input circuit as well as the impact of the output impedance upon amplifier stability. In this example 12.4-Ω resistors are selected. In this design example, 图 15 can be used to estimate a suitable value for  $R_{ISO}$ .  $R_{ISO}$  represents the total resistance in series with  $C_{FLT}$ , which in this example is equivalent to  $2 \times R_{FLT}$ .



For step-by-step design procedure, circuit schematics, bill of materials, printed circuit board (PCB) files, simulation results, and test results, refer to TI Precision Design, TIDU012, "Power-optimized 16-bit 1MSPS Data Acquisition Block for Lowest Distortion and Noise Reference Design".

### 9.2.2.3 Application Curves

图 78 illustrates the performance of the circuit shown in 图 76.

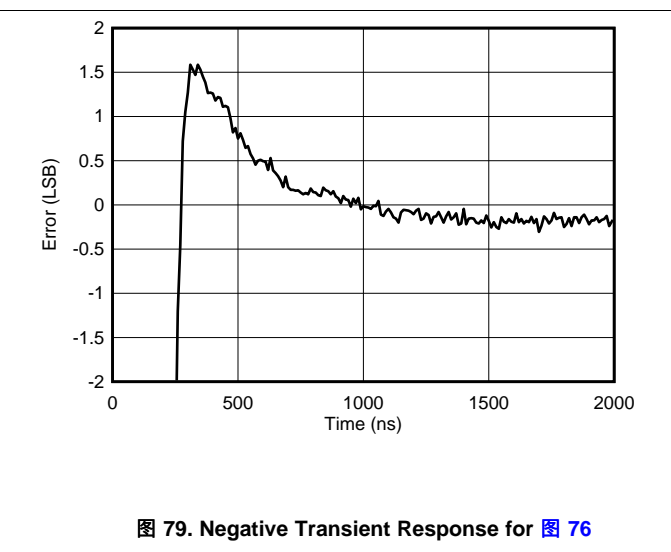
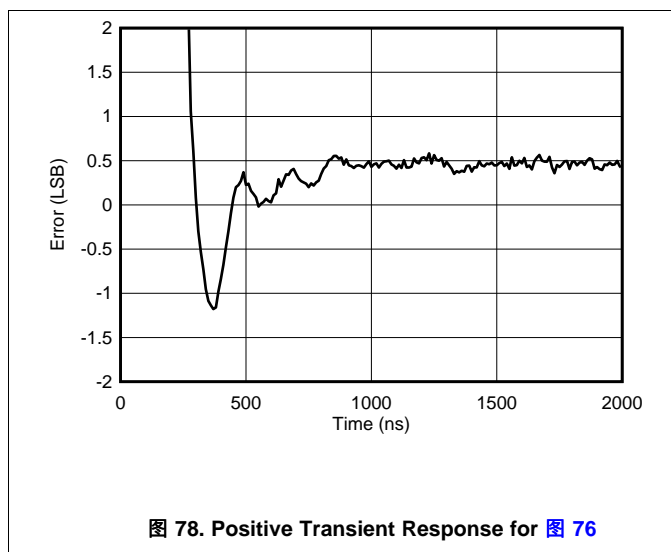

## 10 Power Supply Recommendations

The OPAx625 is specified for operation from 2.7 V to 5.5 V ( $\pm 1.35$  V to  $\pm 2.75$  V); many specifications apply from  $-40^{\circ}\text{C}$  to  $+125^{\circ}\text{C}$ . Parameters that can exhibit significant variance with regard to operating voltage or temperature are presented in the [Typical Characteristics](#). Place bypass capacitors close to the power-supply pins to reduce errors coupling in from noisy or high-impedance power supplies. For more detailed information on bypass capacitor placement, see the [Layout](#) section.

### CAUTION

Supply voltages larger than 6 V can cause permanent damage to the device. See to the [Absolute Maximum Ratings](#) section.

## 11 Layout

### 11.1 Layout Guidelines

For best operational performance of the device, use good PCB layout practices, including:

- Use bypass capacitors to reduce the noise coupled from the power supply. Connect low ESR, ceramic, bypass capacitors between the power supply pins ( $V+$  and  $V-$ ) and the ground plane. Place the bypass capacitors as close to the device as possible with the 100-nF capacitor closest to the device, as indicated in [Figure 80](#). For single-supply applications, bypass capacitors on the  $V-$  pin are not required.
- Separate grounding for analog and digital portions of the circuitry is one of the simplest and most-effective methods of noise suppression. One or more layers on multilayer PCBs are usually devoted to ground planes. A ground plane helps distribute heat and reduces EMI noise pickup. Make sure to physically separate digital and analog grounds paying attention to the flow of the ground current. For more detailed information refer to [SLOA089](#), *Circuit Board Layout Techniques*.
- In order to reduce parasitic coupling, run the input traces as far away from the supply or output traces as possible. If it is not possible to keep them separate, it is much better to cross the sensitive trace perpendicular as opposed to in parallel with the noisy trace.
- Minimize parasitic coupling between  $+IN$  and  $OUT$  for best ac performance.
- Place the external components as close to the device as possible. As shown in [Figure 80](#), keeping RF, CF, and RG close to the inverting input will minimize parasitic capacitance.
- Keep the length of input traces as short as possible. Always remember that the input traces are the most sensitive part of the circuit.
- Cleaning the PCB following board assembly is recommended for best performance.
- Any precision integrated circuit may experience performance shifts due to moisture ingress into the plastic package. Following any aqueous PCB cleaning process, bake the PCB assembly to remove moisture introduced into the device packaging during the cleaning process. A low-temperature, post-cleaning bake at  $85^{\circ}\text{C}$  for 30 minutes is sufficient for most circumstances.

### 11.2 Layout Example



图 80. PCB Layout Example

## 12 器件和文档支持

### 12.1 器件支持

#### 12.1.1 开发支持

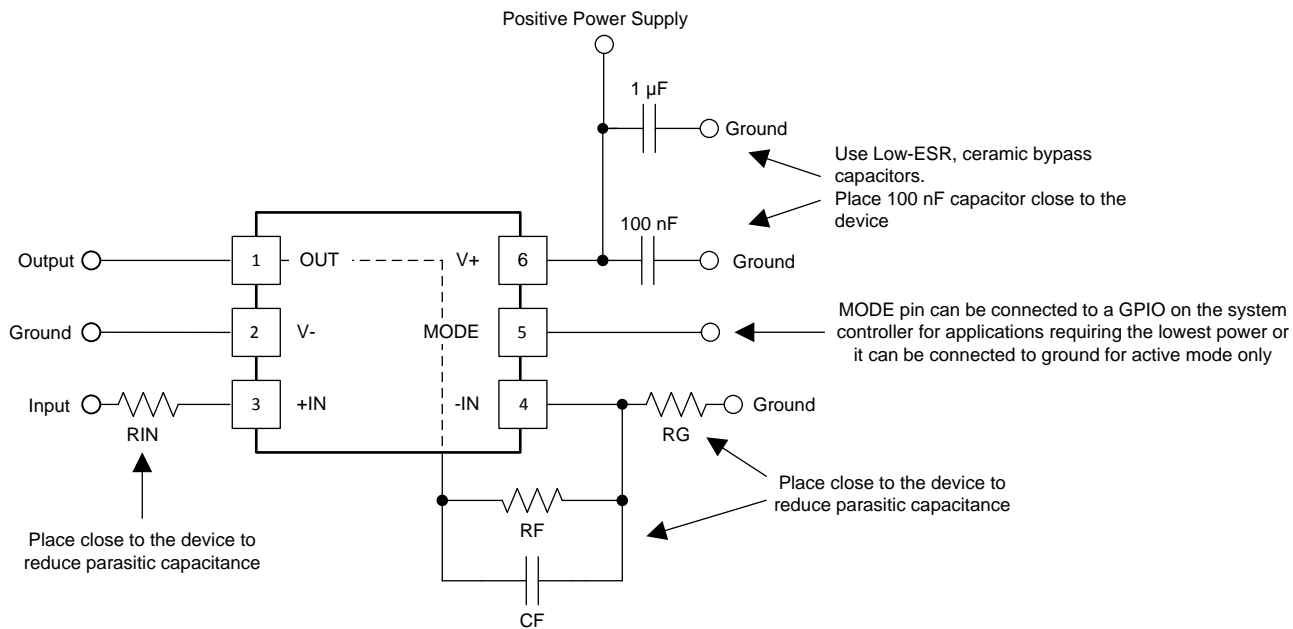
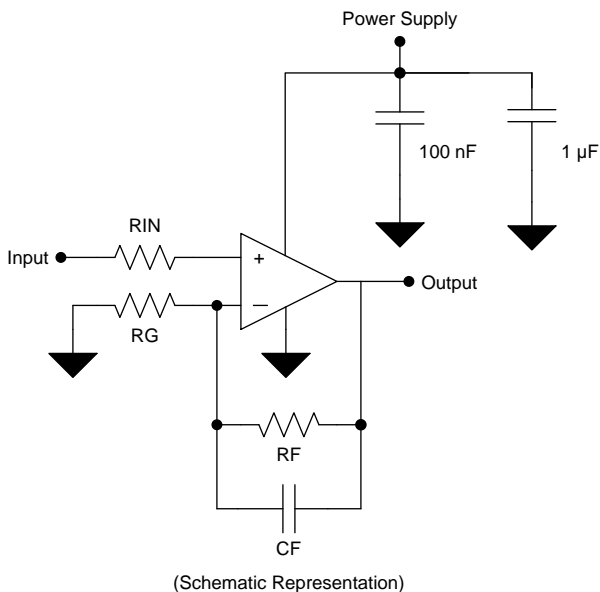
##### 12.1.1.1 TINA-TI™ (免费软件下载)

TINA™是一款简单、功能强大且易于使用的电路仿真程序，此程序基于 SPICE 引擎。TINA-TI 是 TINA 软件的一款免费全功能版本，除了一系列无源和有源模型外，此版本软件还预先载入了一个宏模型库。TINA-TI 提供所有传统的 SPICE 直流、瞬态和频域分析，以及其他设计功能。

TINA-TI 可从 Analog eLab Design Center (模拟电子实验室设计中心) [免费下载](#)，它提供全面的后续处理能力，使得用户能够以多种方式形成结果。虚拟仪器提供选择输入波形和探测电路节点、电压和波形的功能，从而创建一个动态的快速入门工具。

##### 12.1.1.2 TI 高精度设计

欲获取 TI 高精度设计，请访问 <http://www.ti.com.cn/ww/analog/precision-designs/>。TI 高精度设计是由 TI 公司高精度模拟应用专家创建的模拟解决方案，提供了许多实用电路的工作原理、组件选择、仿真、完整印刷电路板 (PCB) 电路原理图和布局布线、物料清单以及性能测量结果。

### 12.2 文档支持

#### 12.2.1 相关文档

《16 位、1MSPS 多路复用数据采集参考设计指南》，[TIDUAD9](#)

### 12.3 相关链接

**表 1** 列出了快速访问链接。范围包括技术文档、支持与社区资源、工具和软件，并且可以快速访问样片或购买链接。

**表 1. 相关链接**

器件	产品文件夹	样片与购买	技术文档	工具与软件	支持与社区
OPA625	<a href="#">请单击此处</a>	<a href="#">请单击此处</a>	<a href="#">请单击此处</a>	<a href="#">请单击此处</a>	<a href="#">请单击此处</a>
OPA2625	<a href="#">请单击此处</a>	<a href="#">请单击此处</a>	<a href="#">请单击此处</a>	<a href="#">请单击此处</a>	<a href="#">请单击此处</a>

### 12.4 Community Resources

The following links connect to TI community resources. Linked contents are provided *AS IS* by the respective contributors. They do not constitute TI specifications and do not necessarily reflect TI's views; see TI's [Terms of Use](#).

**TI E2E™ Online Community** *TI's Engineer-to-Engineer (E2E) Community*. Created to foster collaboration among engineers. At [e2e.ti.com](http://e2e.ti.com), you can ask questions, share knowledge, explore ideas and help solve problems with fellow engineers.

**Design Support** *TI's Design Support* Quickly find helpful E2E forums along with design support tools and contact information for technical support.

## 12.5 商标

E2E is a trademark of Texas Instruments.

TINA-TI is a trademark of Texas Instruments, Inc and DesignSoft, Inc.

TINA is a trademark of DesignSoft, Inc.

All other trademarks are the property of their respective owners.

## 12.6 静电放电警告



ESD 可能会损坏该集成电路。德州仪器 (TI) 建议通过适当的预防措施处理所有集成电路。如果不遵守正确的处理措施和安装程序，可能会损坏集成电路。

ESD 的损坏小至导致微小的性能降级，大至整个器件故障。精密的集成电路可能更容易受到损坏，这是因为非常细微的参数更改都可能会导致器件与其发布的规格不相符。

## 12.7 Glossary

[SLYZ022](#) — *TI Glossary*.

This glossary lists and explains terms, acronyms, and definitions.

## 13 机械、封装和可订购信息

以下页中包括机械、封装和可订购信息。这些信息是针对指定器件可提供的最新数据。这些数据会在无通知且不对本文档进行修订的情况下发生改变。欲获得该数据表的浏览器版本，请查阅左侧的导航栏。

**PACKAGING INFORMATION**

Orderable part number	Status (1)	Material type (2)	Package   Pins	Package qty   Carrier	RoHS (3)	Lead finish/ Ball material (4)	MSL rating/ Peak reflow (5)	Op temp (°C)	Part marking (6)
<a href="#">OPA2625IDGSR</a>	Active	Production	VSSOP (DGS)   10	2500   LARGE T&R	Yes	NIPDAUAG	Level-2-260C-1 YEAR	-40 to 125	2625
OPA2625IDGSR.Z	Active	Production	VSSOP (DGS)   10	2500   LARGE T&R	Yes	NIPDAUAG	Level-2-260C-1 YEAR	-40 to 125	2625
<a href="#">OPA2625IDGST</a>	Active	Production	VSSOP (DGS)   10	250   SMALL T&R	Yes	NIPDAUAG	Level-2-260C-1 YEAR	-40 to 125	2625
OPA2625IDGST.Z	Active	Production	VSSOP (DGS)   10	250   SMALL T&R	Yes	NIPDAUAG	Level-2-260C-1 YEAR	-40 to 125	2625
<a href="#">OPA625IDBVR</a>	Active	Production	SOT-23 (DBV)   6	3000   LARGE T&R	Yes	NIPDAU	Level-1-260C-UNLIM	-40 to 125	O625
OPA625IDBVR.Z	Active	Production	SOT-23 (DBV)   6	3000   LARGE T&R	Yes	NIPDAU	Level-1-260C-UNLIM	-40 to 125	O625
OPA625IDBVRG4.Z	Active	Production	SOT-23 (DBV)   6	3000   LARGE T&R	Yes	NIPDAU	Level-1-260C-UNLIM	-40 to 125	O625
<a href="#">OPA625IDBVT</a>	Active	Production	SOT-23 (DBV)   6	250   SMALL T&R	Yes	NIPDAU	Level-1-260C-UNLIM	-40 to 125	O625
OPA625IDBVT.Z	Active	Production	SOT-23 (DBV)   6	250   SMALL T&R	Yes	NIPDAU	Level-1-260C-UNLIM	-40 to 125	O625

(1) **Status:** For more details on status, see our [product life cycle](#).

(2) **Material type:** When designated, preproduction parts are prototypes/experimental devices, and are not yet approved or released for full production. Testing and final process, including without limitation quality assurance, reliability performance testing, and/or process qualification, may not yet be complete, and this item is subject to further changes or possible discontinuation. If available for ordering, purchases will be subject to an additional waiver at checkout, and are intended for early internal evaluation purposes only. These items are sold without warranties of any kind.

(3) **RoHS values:** Yes, No, RoHS Exempt. See the [TI RoHS Statement](#) for additional information and value definition.

(4) **Lead finish/Ball material:** Parts may have multiple material finish options. Finish options are separated by a vertical ruled line. Lead finish/Ball material values may wrap to two lines if the finish value exceeds the maximum column width.

(5) **MSL rating/Peak reflow:** The moisture sensitivity level ratings and peak solder (reflow) temperatures. In the event that a part has multiple moisture sensitivity ratings, only the lowest level per JEDEC standards is shown. Refer to the shipping label for the actual reflow temperature that will be used to mount the part to the printed circuit board.

(6) **Part marking:** There may be an additional marking, which relates to the logo, the lot trace code information, or the environmental category of the part.

Multiple part markings will be inside parentheses. Only one part marking contained in parentheses and separated by a "-" will appear on a part. If a line is indented then it is a continuation of the previous line and the two combined represent the entire part marking for that device.

**Important Information and Disclaimer:**The information provided on this page represents TI's knowledge and belief as of the date that it is provided. TI bases its knowledge and belief on information provided by third parties, and makes no representation or warranty as to the accuracy of such information. Efforts are underway to better integrate information from third parties. TI has taken and continues to take reasonable steps to provide representative

and accurate information but may not have conducted destructive testing or chemical analysis on incoming materials and chemicals. TI and TI suppliers consider certain information to be proprietary, and thus CAS numbers and other limited information may not be available for release.

In no event shall TI's liability arising out of such information exceed the total purchase price of the TI part(s) at issue in this document sold by TI to Customer on an annual basis.

**TAPE AND REEL INFORMATION**

**QUADRANT ASSIGNMENTS FOR PIN 1 ORIENTATION IN TAPE**

\*All dimensions are nominal

Device	Package Type	Package Drawing	Pins	SPQ	Reel Diameter (mm)	Reel Width W1 (mm)	A0 (mm)	B0 (mm)	K0 (mm)	P1 (mm)	W (mm)	Pin1 Quadrant
OPA2625IDGSR	VSSOP	DGS	10	2500	330.0	12.4	5.3	3.4	1.4	8.0	12.0	Q1
OPA2625IDGST	VSSOP	DGS	10	250	330.0	12.4	5.3	3.4	1.4	8.0	12.0	Q1
OPA625IDBVR	SOT-23	DBV	6	3000	178.0	9.0	3.23	3.17	1.37	4.0	8.0	Q3
OPA625IDBVT	SOT-23	DBV	6	250	178.0	9.0	3.23	3.17	1.37	4.0	8.0	Q3



**TAPE AND REEL BOX DIMENSIONS**

\*All dimensions are nominal

Device	Package Type	Package Drawing	Pins	SPQ	Length (mm)	Width (mm)	Height (mm)
OPA2625IDGSR	VSSOP	DGS	10	2500	366.0	364.0	50.0
OPA2625IDGST	VSSOP	DGS	10	250	366.0	364.0	50.0
OPA625IDBVR	SOT-23	DBV	6	3000	180.0	180.0	18.0
OPA625IDBVT	SOT-23	DBV	6	250	180.0	180.0	18.0

# DGS0010A



# PACKAGE OUTLINE

## VSSOP - 1.1 mm max height

SMALL OUTLINE PACKAGE



4221984/A 05/2015

### NOTES:

1. All linear dimensions are in millimeters. Any dimensions in parenthesis are for reference only. Dimensioning and tolerancing per ASME Y14.5M.
2. This drawing is subject to change without notice.
3. This dimension does not include mold flash, protrusions, or gate burrs. Mold flash, protrusions, or gate burrs shall not exceed 0.15 mm per side.
4. This dimension does not include interlead flash. Interlead flash shall not exceed 0.25 mm per side.
5. Reference JEDEC registration MO-187, variation BA.

# EXAMPLE BOARD LAYOUT

DGS0010A

VSSOP - 1.1 mm max height

SMALL OUTLINE PACKAGE



LAND PATTERN EXAMPLE  
SCALE:10X



SOLDER MASK DETAILS  
NOT TO SCALE

4221984/A 05/2015

NOTES: (continued)

- 6. Publication IPC-7351 may have alternate designs.
- 7. Solder mask tolerances between and around signal pads can vary based on board fabrication site.

# EXAMPLE STENCIL DESIGN

DGS0010A

VSSOP - 1.1 mm max height

SMALL OUTLINE PACKAGE



SOLDER PASTE EXAMPLE  
BASED ON 0.125 mm THICK STENCIL  
SCALE:10X

4221984/A 05/2015

NOTES: (continued)

8. Laser cutting apertures with trapezoidal walls and rounded corners may offer better paste release. IPC-7525 may have alternate design recommendations.
9. Board assembly site may have different recommendations for stencil design.

# DBV0006A



## PACKAGE OUTLINE

SOT-23 - 1.45 mm max height

SMALL OUTLINE TRANSISTOR

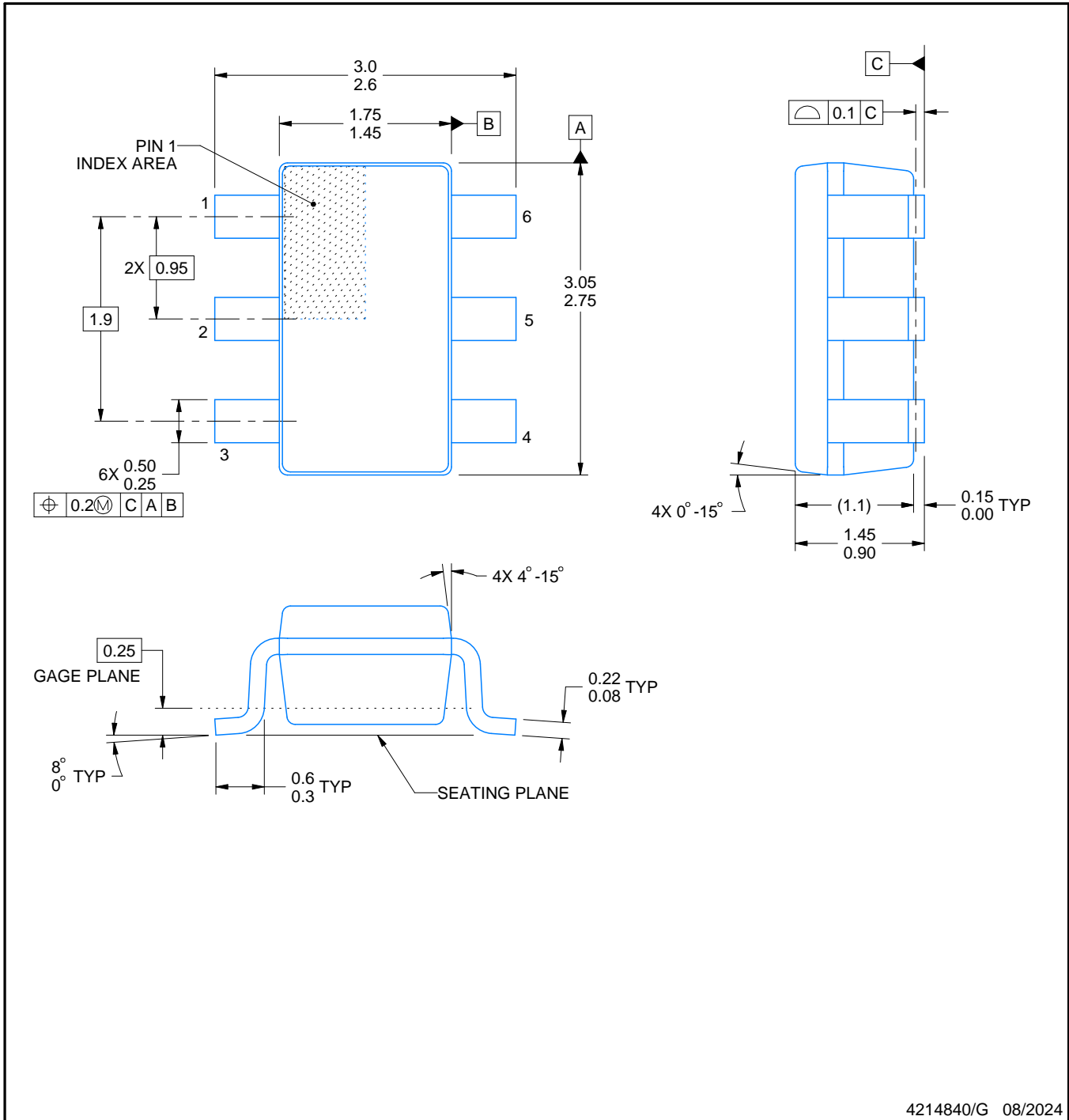

4214840/G 08/2024

### NOTES:

1. All linear dimensions are in millimeters. Any dimensions in parenthesis are for reference only. Dimensioning and tolerancing per ASME Y14.5M.
2. This drawing is subject to change without notice.
3. Body dimensions do not include mold flash or protrusion. Mold flash and protrusion shall not exceed 0.25 per side.
4. Leads 1,2,3 may be wider than leads 4,5,6 for package orientation.
5. Reference JEDEC MO-178.

# EXAMPLE BOARD LAYOUT

DBV0006A

SOT-23 - 1.45 mm max height

SMALL OUTLINE TRANSISTOR



LAND PATTERN EXAMPLE  
EXPOSED METAL SHOWN  
SCALE:15X

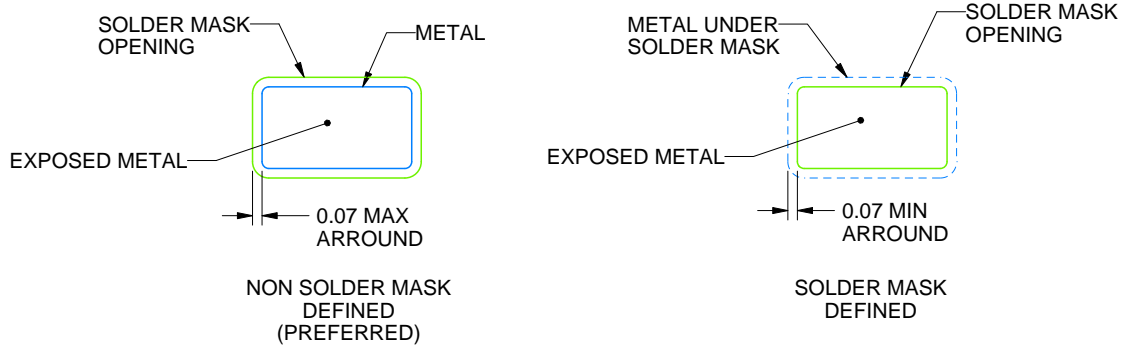

SOLDER MASK DETAILS

4214840/G 08/2024

NOTES: (continued)

6. Publication IPC-7351 may have alternate designs.
7. Solder mask tolerances between and around signal pads can vary based on board fabrication site.

# EXAMPLE STENCIL DESIGN

DBV0006A

SOT-23 - 1.45 mm max height

SMALL OUTLINE TRANSISTOR



SOLDER PASTE EXAMPLE  
BASED ON 0.125 mm THICK STENCIL  
SCALE:15X

4214840/G 08/2024

NOTES: (continued)

8. Laser cutting apertures with trapezoidal walls and rounded corners may offer better paste release. IPC-7525 may have alternate design recommendations.
9. Board assembly site may have different recommendations for stencil design.

## 重要通知和免责声明

TI“按原样”提供技术和可靠性数据（包括数据表）、设计资源（包括参考设计）、应用或其他设计建议、网络工具、安全信息和其他资源，不保证没有瑕疵且不做任何明示或暗示的担保，包括但不限于对适销性、某特定用途方面的适用性或不侵犯任何第三方知识产权的暗示担保。

这些资源可供使用 TI 产品进行设计的熟练开发人员使用。您将自行承担以下全部责任：(1) 针对您的应用选择合适的 TI 产品，(2) 设计、验证并测试您的应用，(3) 确保您的应用满足相应标准以及任何其他功能安全、信息安全、监管或其他要求。

这些资源如有变更，恕不另行通知。TI 授权您仅可将这些资源用于研发本资源所述的 TI 产品的相关应用。严禁以其他方式对这些资源进行复制或展示。您无权使用任何其他 TI 知识产权或任何第三方知识产权。您应全额赔偿因在这些资源的使用中对 TI 及其代表造成的任何索赔、损害、成本、损失和债务，TI 对此概不负责。

TI 提供的产品受 [TI 的销售条款](#) 或 [ti.com](#) 上其他适用条款/TI 产品随附的其他适用条款的约束。TI 提供这些资源并不会扩展或以其他方式更改 TI 针对 TI 产品发布的适用的担保或担保免责声明。

TI 反对并拒绝您可能提出的任何其他或不同的条款。

邮寄地址：Texas Instruments, Post Office Box 655303, Dallas, Texas 75265  
版权所有 © 2025，德州仪器 (TI) 公司