

OPAx197 36V 轨到轨输入/输出、低失调电压精密运算放大器

1 特性

- 低失调电压: $\pm 100\mu\text{V}$ (最大值)
- 低失调电压温漂: $\pm 2.5\mu\text{V}/^\circ\text{C}$ (最大值)
- 低噪声: 1kHz 时为 $5.5\text{nV}/\sqrt{\text{Hz}}$
- 高共模抑制: 120dB (最小值)
- 低偏置电流: $\pm 5\text{pA}$ (典型值)
- 轨到轨输入和输出
- 高带宽: 10MHz GBW
- 高压摆率: $20\text{V}/\mu\text{s}$
- 低静态电流: 每个放大器 1mA (典型值)
- 宽电源电压范围: $\pm 2.25\text{V}$ 至 $\pm 18\text{V}$, $+4.5\text{V}$ 至 $+36\text{V}$
- 已过滤电磁干扰 (EMI) 和射频干扰 (RFI) 的输入
- 电源轨的差分输入电压范围
- 高容性负载驱动能力: 1nF
- 行业标准封装:
 - SOIC-8、SOT-5 和 VSSOP-8 单体封装
 - SOIC-8 和 VSSOP-8 双列封装
 - 四通道电源版本采用 SOIC-14 和 TSSOP-14 封装

2 应用

- 多路复用数据采集系统
- 测试和测量设备
- 高分辨率模数转换器 (ADC) 驱动器放大器
- SAR ADC 基准缓冲器
- 可编程逻辑控制器
- 高侧和低侧电流检测
- 高精度比较器

3 说明

OPAx197 系列 (OPA197、OPA2197 和 OPA4197) 是新一代 36V 运算放大器。

这些器件具有出色的直流精度和交流性能, 包括轨至轨输入/输出、低偏移 (典型值为 $\pm 25\mu\text{V}$)、低温漂 (典型值为 $\pm 0.25\mu\text{V}/^\circ\text{C}$) 和 10MHz 带宽。

OPAx196 拥有 拥有诸多独一无二的特性, 例如电源轨的差分输入电压范围、高输出电流 ($\pm 65\text{mA}$)、高达 1nF 的高容性负载驱动以及高转换率 ($20\text{V}/\mu\text{s}$), 是稳健耐用的高性能运算放大器, 适用于各种高压工业应用。

OPA197 系列运算放大器采用标准封装, 在 -40°C 至 $+125^\circ\text{C}$ 的额定温度范围内工作。

器件信息⁽¹⁾

器件型号	封装	封装尺寸 (标称值)
OPA197	SOIC (8)	4.90mm x 3.90mm
	小外形尺寸晶体管 (SOT) (5)	2.90mm x 1.60mm
	VSSOP (8)	3.00mm x 3.00mm
OPA2197	SOIC (8)	4.90mm x 3.90mm
	VSSOP (8)	3.00mm x 3.00mm
OPA4197	SOIC (14)	8.65mm x 3.90mm
	TSSOP (14)	5.00mm x 4.40mm

(1) 如需了解所有可用封装, 请参阅数据表末尾的封装选项附录。

OPA197 应用于高压多路复用数据采集系统

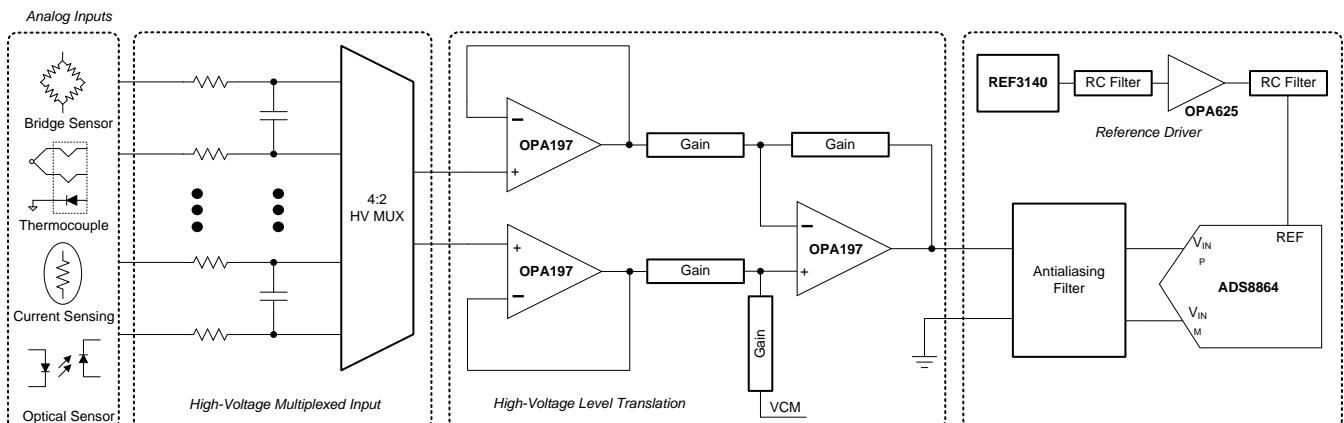

目录

1	特性	1	7.3	Feature Description	20
2	应用	1	7.4	Device Functional Modes	26
3	说明	1	8	Application and Implementation	27
4	修订历史记录	2	8.1	Application Information	27
5	Pin Configuration and Functions	3	8.2	Typical Applications	27
6	Specifications	5	9	Power Supply Recommendations	30
6.1	Absolute Maximum Ratings	5	10	Layout	31
6.2	ESD Ratings	5	10.1	Layout Guidelines	31
6.3	Recommended Operating Conditions	5	10.2	Layout Example	31
6.4	Thermal Information: OPA197	6	11	器件和文档支持	32
6.5	Thermal Information: OPA2197	6	11.1	器件支持	32
6.6	Thermal Information: OPA4197	6	11.2	文档支持	32
6.7	Electrical Characteristics: $V_S = \pm 4\text{ V to } \pm 18\text{ V}$ ($V_S = 8\text{ V to } 36\text{ V}$)	7	11.3	相关链接	32
6.8	Electrical Characteristics: $V_S = \pm 2.25\text{ V to } \pm 4\text{ V}$ ($V_S = 4.5\text{ V to } 8\text{ V}$)	9	11.4	接收文档更新通知	33
6.9	Typical Characteristics	11	11.5	社区资源	33
7	Detailed Description	19	11.6	商标	33
7.1	Overview	19	11.7	静电放电警告	33
7.2	Functional Block Diagram	19	11.8	Glossary	33
			12	机械、封装和可订购信息	33

4 修订历史记录

Changes from Revision B (October 2016) to Revision C	Page
• 已更改 将“低失调电压: $\pm 250\mu\text{V}$ (最大值)”更改成了“低失调电压: $\pm 100\mu\text{V}$ (最大值)”	1
• Changed <i>Electrical Characteristics: $V_S = \pm 4\text{ V to } \pm 18\text{ V}$ ($V_S = 8\text{ V to } 36\text{ V}$)</i> Input offset voltage $V_S = \pm 18\text{ V}$ under OFFSET VOLTAGE from " ± 250 " to " ± 100 "; remove " $T_A = 0^\circ\text{C to } 85^\circ\text{C}$ " and " $T_A = -40^\circ\text{C to } +125^\circ\text{C}$ " rows from same	7
• Changed <i>Electrical Characteristics: $V_S = \pm 4\text{ V to } \pm 18\text{ V}$ ($V_S = 8\text{ V to } 36\text{ V}$)</i> Input offset voltage $V_{CM} = (V+) - 1.5\text{ V}$ under OFFSET VOLTAGE from " ± 250 " to " ± 100 "; remove " $T_A = 0^\circ\text{C to } 85^\circ\text{C}$ " and " $T_A = -40^\circ\text{C to } +125^\circ\text{C}$ " rows from same	7
• Changed <i>Electrical Characteristics: $V_S = \pm 2.25\text{ V to } \pm 4\text{ V}$ ($V_S = 4.5\text{ V to } 8\text{ V}$)</i> Input offset voltage $V_S = \pm 2.25\text{ V}$, $V_{CM} = (V+) - 3\text{ V}$ under OFFSET VOLTAGE from " ± 250 " to " ± 100 "; remove " $T_A = 0^\circ\text{C to } 85^\circ\text{C}$ " and " $T_A = -40^\circ\text{C to } +125^\circ\text{C}$ " rows from same	9
• Changed <i>Electrical Characteristics: $V_S = \pm 4\text{ V to } \pm 18\text{ V}$ ($V_S = 8\text{ V to } 36\text{ V}$)</i> Input offset voltage $V_S = \pm 3\text{ V}$, $V_{CM} = (V+) - 1.5\text{ V}$ under OFFSET VOLTAGE from " ± 250 " to " ± 100 "; remove " $T_A = 0^\circ\text{C to } 85^\circ\text{C}$ " and " $T_A = -40^\circ\text{C to } +125^\circ\text{C}$ " rows from same	9
• Changed "0" on Frequency (Hz) axis to "0.1"	11
• Changed "...to achieve a very low offset voltage of $250\mu\text{V}$ (max)..." to "...to achieve a very low offset voltage of $100\mu\text{V}$ (maximum)..."	19

Changes from Revision A (July 2016) to Revision B	Page
• Added new row for PW package to <i>Input bias current</i> parameter	7
• Added new row for PW package to <i>Input offset current</i> parameter	7
• Added new footnote (1) to <i>Open-loop gain</i> parameter	7
• Changed <i>Slew rate</i> parameter from $20\text{ V}/\mu\text{s}$: to $14\text{ V}/\mu\text{s}$	10

Changes from Original (January 2016) to Revision A	Page
• Added OPA2197 and OPA4197 CDM values to ESD Ratings table	5

5 Pin Configuration and Functions

**D and DGK Packages: OPA197
8-Pin SOIC and VSSOP
Top View**

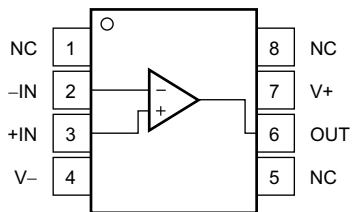

**D and DGK Packages: OPA2197
8-Pin SOIC and VSSOP
Top View**

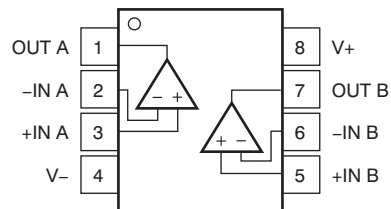

**DBV Package: OPA197
5-Pin SOT
Top View**

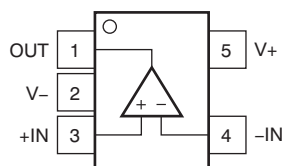

**D and PW Packages: OPA4197
14-Pin SOIC and TSSOP
Top View**

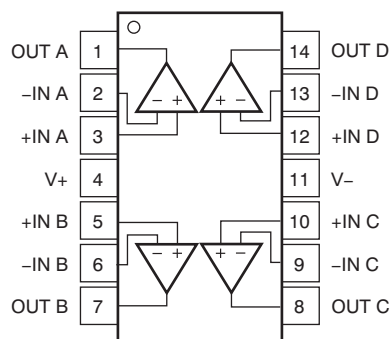

OPA197, OPA2197, OPA4197

ZHCSEI8C – JANUARY 2016 – REVISED MARCH 2018

www.ti.com.cn
Pin Functions: OPA197

PIN			I/O	DESCRIPTION
NAME	OPA197			
	D (SOIC), DGK (VSSOP)	DBV (SOT)		
+IN	3	3	I	Noninverting input
–IN	2	4	I	Inverting input
NC	1, 5, 8	—	—	No internal connection (can be left floating)
OUT	6	1	O	Output
V+	7	5	—	Positive (highest) power supply
V–	4	2	—	Negative (lowest) power supply

Pin Functions: OPA2197 and OPA4197

PIN			I/O	DESCRIPTION
NAME	OPA2197	OPA4197		
	D (SOIC), DGK (VSSOP)	D (SOIC), PW (TSSOP)		
+IN A	3	3	I	Noninverting input, channel A
+IN B	5	5	I	Noninverting input, channel B
+IN C	—	10	I	Noninverting input, channel C
+IN D	—	12	I	Noninverting input, channel D
–IN A	2	2	I	Inverting input, channel A
–IN B	6	6	I	Inverting input, channel B
–IN C	—	9	I	Inverting input, channel C
–IN D	—	13	I	Inverting input, channel D
OUT A	1	1	O	Output, channel A
OUT B	7	7	O	Output, channel B
OUT C	—	8	O	Output, channel C
OUT D	—	14	O	Output, channel D
V+	8	4	—	Positive (highest) power supply
V–	4	11	—	Negative (lowest) power supply

6 Specifications

6.1 Absolute Maximum Ratings⁽¹⁾

over operating free-air temperature range (unless otherwise noted)

		MIN	MAX	UNIT	
Supply voltage, $V_S = (V+) - (V-)$	Dual supply	±20		V	
	Single supply	40			
Signal input pins	Voltage	Common-mode	(V-) – 0.5	(V+) + 0.5	V
		Differential	(V+) – (V-) + 0.2		
	Current	±10		mA	
Output short circuit ⁽²⁾		Continuous			
Temperature	Operating, T_A	–55	150	°C	
	Junction, T_J	150			
	Storage, T_{stg}	–65	150		

- (1) Stresses beyond those listed under *Absolute Maximum Ratings* may cause permanent damage to the device. These are stress ratings only, which do not imply functional operation of the device at these or any other conditions beyond those indicated under *Recommended Operating Conditions*. Exposure to absolute-maximum-rated conditions for extended periods may affect device reliability.
- (2) Short-circuit to ground, one amplifier per package.

6.2 ESD Ratings

			VALUE	UNIT
ALL DEVICES				
$V_{(ESD)}$	Electrostatic discharge	Human-body model (HBM), per ANSI/ESDA/JEDEC JS-001 ⁽¹⁾	±4000	V
OPA197				
$V_{(ESD)}$	Electrostatic discharge	Charged-device model (CDM), per JEDEC specification JESD22-C101 ⁽²⁾	±1000	V
OPA2197				
$V_{(ESD)}$	Electrostatic discharge	Charged-device model (CDM), per JEDEC specification JESD22-C101 ⁽²⁾	±750	V
OPA4197				
$V_{(ESD)}$	Electrostatic discharge	Charged-device model (CDM), per JEDEC specification JESD22-C101 ⁽²⁾	±500	V

- (1) JEDEC document JEP155 states that 500-V HBM allows safe manufacturing with a standard ESD control process.
- (2) JEDEC document JEP157 states that 250-V CDM allows safe manufacturing with a standard ESD control process.

6.3 Recommended Operating Conditions

over operating free-air temperature range (unless otherwise noted)

		MIN	NOM	MAX	UNIT
Supply voltage, $V_S = (V+) - (V-)$	Dual supply	±2.25		±18	V
	Single supply	4.5		36	
Operating temperature, T_A		–40		125	°C

6.4 Thermal Information: OPA197

THERMAL METRIC ⁽¹⁾		OPA197			UNIT
		D (SOIC)	DBV (SOT)	DGK (VSSOP)	
		8 PINS	5 PINS	8 PINS	
$R_{\theta JA}$	Junction-to-ambient thermal resistance	115.8	158.8	180.4	°C/W
$R_{\theta JC(top)}$	Junction-to-case(top) thermal resistance	60.1	60.7	67.9	°C/W
$R_{\theta JB}$	Junction-to-board thermal resistance	56.4	44.8	102.1	°C/W
Ψ_{JT}	Junction-to-top characterization parameter	12.8	1.6	10.4	°C/W
Ψ_{JB}	Junction-to-board characterization parameter	55.9	4.2	100.3	°C/W
$R_{\theta JC(bot)}$	Junction-to-case(bottom) thermal resistance	N/A	N/A	N/A	°C/W

(1) For more information about traditional and new thermal metrics, see the [Semiconductor and IC Package Thermal Metrics](#) application report.

6.5 Thermal Information: OPA2197

THERMAL METRIC ⁽¹⁾		OPA2197		UNIT
		D (SOIC)	DGK (VSSOP)	
		8 PINS	8 PINS	
$R_{\theta JA}$	Junction-to-ambient thermal resistance	107.9	158	°C/W
$R_{\theta JC(top)}$	Junction-to-case(top) thermal resistance	53.9	48.6	°C/W
$R_{\theta JB}$	Junction-to-board thermal resistance	48.9	78.7	°C/W
Ψ_{JT}	Junction-to-top characterization parameter	6.6	3.9	°C/W
Ψ_{JB}	Junction-to-board characterization parameter	48.3	77.3	°C/W
$R_{\theta JC(bot)}$	Junction-to-case(bottom) thermal resistance	N/A	N/A	°C/W

(1) For more information about traditional and new thermal metrics, see the [Semiconductor and IC Package Thermal Metrics](#) application report.

6.6 Thermal Information: OPA4197

THERMAL METRIC ⁽¹⁾		OPA4197		UNIT
		D (SOIC)	PW (TSSOP)	
		14 PINS	14 PINS	
$R_{\theta JA}$	Junction-to-ambient thermal resistance	86.4	92.6	°C/W
$R_{\theta JC(top)}$	Junction-to-case(top) thermal resistance	46.3	27.5	°C/W
$R_{\theta JB}$	Junction-to-board thermal resistance	41.0	33.6	°C/W
Ψ_{JT}	Junction-to-top characterization parameter	11.3	1.9	°C/W
Ψ_{JB}	Junction-to-board characterization parameter	40.7	33.1	°C/W
$R_{\theta JC(bot)}$	Junction-to-case(bottom) thermal resistance	N/A	N/A	°C/W

(1) For more information about traditional and new thermal metrics, see the [Semiconductor and IC Package Thermal Metrics](#) application report.

6.7 Electrical Characteristics: $V_S = \pm 4\text{ V to } \pm 18\text{ V}$ ($V_S = 8\text{ V to } 36\text{ V}$)

at $T_A = 25^\circ\text{C}$, $V_{CM} = V_{OUT} = V_S / 2$, and $R_{LOAD} = 10\text{ k}\Omega$ connected to $V_S / 2$, (unless otherwise noted)

PARAMETER		TEST CONDITIONS		MIN	TYP	MAX	UNIT
OFFSET VOLTAGE							
V_{OS}	Input offset voltage	$V_S = \pm 18\text{ V}$			± 25	± 100	μV
		$V_{CM} = (V+) - 1.5\text{ V}$			± 10	± 100	
dV_{OS}/dT	Input offset voltage drift	$V_S = \pm 18\text{ V}$, $V_{CM} = (V+) - 3\text{ V}$	$T_A = -40^\circ\text{C to } +125^\circ\text{C}$		± 0.5	± 2.5	$\mu\text{V}/^\circ\text{C}$
		$V_S = \pm 18\text{ V}$, $V_{CM} = (V+) - 1.5\text{ V}$			± 0.8	± 4.5	
PSRR	Power-supply rejection ratio	$T_A = -40^\circ\text{C to } +125^\circ\text{C}$			± 1	± 3	$\mu\text{V/V}$
INPUT BIAS CURRENT							
I_B	Input bias current	$T_A = -40^\circ\text{C to } +125^\circ\text{C}$			± 5	± 20	μA
		PW package only				± 5	nA
I_{OS}	Input offset current	$T_A = -40^\circ\text{C to } +125^\circ\text{C}$			± 2	± 20	μA
		PW package only				± 2	nA
NOISE							
E_n	Input voltage noise	$(V-) - 0.1\text{ V} < V_{CM} < (V+) - 3\text{ V}$	$f = 0.1\text{ Hz to } 10\text{ Hz}$		1.30		μV_{PP}
		$(V+) - 1.5\text{ V} < V_{CM} < (V+) + 0.1\text{ V}$	$f = 0.1\text{ Hz to } 10\text{ Hz}$		4		
e_n	Input voltage noise density	$(V-) - 0.1\text{ V} < V_{CM} < (V+) - 3\text{ V}$	$f = 100\text{ Hz}$		10.5		$\text{nV}/\sqrt{\text{Hz}}$
			$f = 1\text{ kHz}$		5.5		
		$(V+) - 1.5\text{ V} < V_{CM} < (V+) + 0.1\text{ V}$	$f = 100\text{ Hz}$		32		
			$f = 1\text{ kHz}$		12.5		
i_n	Input current noise density	$f = 1\text{ kHz}$			1.5		$\text{fA}/\sqrt{\text{Hz}}$
INPUT VOLTAGE							
V_{CM}	Common-mode voltage range			$(V-) - 0.1$		$(V+) + 0.1$	V
CMRR	Common-mode rejection ratio	$V_S = \pm 18\text{ V}$, $(V-) - 0.1\text{ V} < V_{CM} < (V+) - 3\text{ V}$	$T_A = -40^\circ\text{C to } +125^\circ\text{C}$		120	140	dB
		$V_S = \pm 18\text{ V}$, $(V+) - 1.5\text{ V} < V_{CM} < (V+)$			110	126	
		$V_S = \pm 18\text{ V}$, $(V+) - 3\text{ V} < V_{CM} < (V+) - 1.5\text{ V}$		100	120		
					See Typical Characteristics		
INPUT IMPEDANCE							
Z_{ID}	Differential				100 1.6		$\text{M}\Omega \parallel \text{pF}$
Z_{IC}	Common-mode				1 6.4		$10^{13}\Omega \parallel \text{pF}$
OPEN-LOOP GAIN							
A_{OL}	Open-loop voltage gain ⁽¹⁾	$V_S = \pm 18\text{ V}$, $(V-) + 0.6\text{ V} < V_O < (V+) - 0.6\text{ V}$, $R_{LOAD} = 2\text{ k}\Omega$	$T_A = -40^\circ\text{C to } +125^\circ\text{C}$		120	134	dB
		$V_S = \pm 18\text{ V}$, $(V-) + 0.3\text{ V} < V_O < (V+) - 0.3\text{ V}$, $R_{LOAD} = 10\text{ k}\Omega$			110	126	
		$V_S = \pm 18\text{ V}$, $(V-) + 0.6\text{ V} < V_O < (V+) - 0.6\text{ V}$, $R_{LOAD} = 2\text{ k}\Omega$	$T_A = -40^\circ\text{C to } +125^\circ\text{C}$		120	143	
		$V_S = \pm 18\text{ V}$, $(V-) + 0.3\text{ V} < V_O < (V+) - 0.3\text{ V}$, $R_{LOAD} = 10\text{ k}\Omega$			110	134	

(1) For OPA2197, OPA4197: When driving high current loads on multiple channels, make sure the junction temperature does not exceed 125°C .

Electrical Characteristics: $V_S = \pm 4\text{ V}$ to $\pm 18\text{ V}$ ($V_S = 8\text{ V}$ to 36 V) (continued)

 at $T_A = 25^\circ\text{C}$, $V_{CM} = V_{OUT} = V_S / 2$, and $R_{LOAD} = 10\text{ k}\Omega$ connected to $V_S / 2$, (unless otherwise noted)

PARAMETER		TEST CONDITIONS		MIN	TYP	MAX	UNIT	
FREQUENCY RESPONSE								
GBW	Unity gain bandwidth				10		MHz	
SR	Slew rate	$V_S = \pm 18\text{ V}$, $G = 1$, 10-V step			20		V/ μs	
t_s	Settling time	To 0.01%	$V_S = \pm 18\text{ V}$, $G = 1$, 10-V step		1.4		μs	
			$V_S = \pm 18\text{ V}$, $G = 1$, 5-V step		0.9			
		To 0.001%	$V_S = \pm 18\text{ V}$, $G = 1$, 10-V step		2.1			
			$V_S = \pm 18\text{ V}$, $G = 1$, 5-V step		1.8			
t_{OR}	Overload recovery time	$V_{IN} \times G = V_S$			200		ns	
THD+N	Total harmonic distortion + noise	$G = 1$, $f = 1\text{ kHz}$, $V_O = 3.5\text{ V}_{RMS}$			0.00008%			
OUTPUT								
V_O	Voltage output swing from rail	Positive rail	No load		5	25	mV	
			$R_{LOAD} = 10\text{ k}\Omega$		95	125		
			$R_{LOAD} = 2\text{ k}\Omega$		430	500		
		Negative rail	No load		5	25		
			$R_{LOAD} = 10\text{ k}\Omega$		95	125		
			$R_{LOAD} = 2\text{ k}\Omega$		430	500		
I_{SC}	Short-circuit current	$V_S = \pm 18\text{ V}$			± 65		mA	
C_{LOAD}	Capacitive load drive				See Typical Characteristics			
Z_O	Open-loop output impedance	$f = 1\text{ MHz}$, $I_O = 0\text{ A}$, See Figure 26			375		Ω	
POWER SUPPLY								
I_Q	Quiescent current per amplifier	$I_O = 0\text{ A}$			1	1.3	mA	
		$T_A = -40^\circ\text{C}$ to $+125^\circ\text{C}$, $I_O = 0\text{ A}$				1.5		
TEMPERATURE								
	Thermal protection ⁽²⁾				140		$^\circ\text{C}$	

 (2) For a detailed description of thermal protection, see the [Thermal Protection](#) section.

6.8 Electrical Characteristics: $V_S = \pm 2.25\text{ V to } \pm 4\text{ V}$ ($V_S = 4.5\text{ V to } 8\text{ V}$)

 at $T_A = 25^\circ\text{C}$, $V_{CM} = V_{OUT} = V_S / 2$, and $R_{LOAD} = 10\text{ k}\Omega$ connected to $V_S / 2$ (unless otherwise noted)

PARAMETER		TEST CONDITIONS		MIN	TYP	MAX	UNIT
OFFSET VOLTAGE							
V_{OS}	Input offset voltage	$V_S = \pm 2.25\text{ V}$, $V_{CM} = (V+) - 3\text{ V}$			± 5	± 100	μV
		$(V+) - 3.5\text{ V} < V_{CM} < (V+) - 1.5\text{ V}$		See Common-Mode Voltage Range section			
		$V_S = \pm 3\text{ V}$, $V_{CM} = (V+) - 1.5\text{ V}$			± 10	± 100	μV
dV_{OS}/dT	Input offset voltage drift	$V_S = \pm 2.25\text{ V}$, $V_{CM} = (V+) - 3\text{ V}$		$T_A = -40^\circ\text{C to } +125^\circ\text{C}$	± 0.5	± 2.5	$\mu\text{V}/^\circ\text{C}$
		$V_S = \pm 2.25\text{ V}$, $V_{CM} = (V+) - 1.5\text{ V}$			± 0.8	± 4.5	
PSRR	Power-supply rejection ratio	$T_A = -40^\circ\text{C to } +125^\circ\text{C}$, $V_{CM} = V_S / 2 - 0.75\text{ V}$			± 2		$\mu\text{V/V}$
INPUT BIAS CURRENT							
I_B	Input bias current				± 5	± 20	pA
		$T_A = -40^\circ\text{C to } +125^\circ\text{C}$				± 5	nA
I_{OS}	Input offset current				± 2	± 20	pA
		$T_A = -40^\circ\text{C to } +125^\circ\text{C}$				± 2	nA
NOISE							
E_n	Input voltage noise	$(V-) - 0.1\text{ V} < V_{CM} < (V+) - 3\text{ V}$, $f = 0.1\text{ Hz to } 10\text{ Hz}$			1.30		μV_{PP}
		$(V+) - 1.5\text{ V} < V_{CM} < (V+) + 0.1\text{ V}$, $f = 0.1\text{ Hz to } 10\text{ Hz}$			4		
e_n	Input voltage noise density	$(V-) - 0.1\text{ V} < V_{CM} < (V+) - 3\text{ V}$	$f = 100\text{ Hz}$		10.5		$\text{nV}/\sqrt{\text{Hz}}$
			$f = 1\text{ kHz}$		5.5		
		$(V+) - 1.5\text{ V} < V_{CM} < (V+) + 0.1\text{ V}$	$f = 100\text{ Hz}$		32		
			$f = 1\text{ kHz}$		12.5		
i_n	Input current noise density				1.5		$\text{fA}/\sqrt{\text{Hz}}$
INPUT VOLTAGE							
V_{CM}	Common-mode voltage range			$(V-) - 0.1$		$(V+) + 0.1$	V
CMRR	Common-mode rejection ratio	$V_S = \pm 2.25\text{ V}$, $(V-) - 0.1\text{ V} < V_{CM} < (V+) - 3\text{ V}$	$T_A = -40^\circ\text{C to } +125^\circ\text{C}$	90	110		dB
			$T_A = -40^\circ\text{C to } +125^\circ\text{C}$	88	104		
		$V_S = \pm 2.25\text{ V}$, $(V+) - 1.5\text{ V} < V_{CM} < (V+) + 0.1\text{ V}$	$T_A = -40^\circ\text{C to } +125^\circ\text{C}$	94	120		
			$T_A = -40^\circ\text{C to } +125^\circ\text{C}$	77	100		
				See Typical Characteristics			
INPUT IMPEDANCE							
Z_{ID}	Differential			100 1.6			$\text{M}\Omega \parallel \text{pF}$
Z_{IC}	Common-mode			1 6.4			$10^{13}\Omega \parallel \text{pF}$
OPEN-LOOP GAIN							
A_{OL}	Open-loop voltage gain	$V_S = \pm 2.25\text{ V}$, $(V-) + 0.6\text{ V} < V_O < (V+) - 0.6\text{ V}$, $R_{LOAD} = 2\text{ k}\Omega$	$T_A = -40^\circ\text{C to } +125^\circ\text{C}$	104	126		dB
			$T_A = -40^\circ\text{C to } +125^\circ\text{C}$	100	114		
		$V_S = \pm 2.25\text{ V}$, $(V-) + 0.3\text{ V} < V_O < (V+) - 0.3\text{ V}$, $R_{LOAD} = 10\text{ k}\Omega$	$T_A = -40^\circ\text{C to } +125^\circ\text{C}$	104	134		
			$T_A = -40^\circ\text{C to } +125^\circ\text{C}$	100	120		

Electrical Characteristics: $V_S = \pm 2.25\text{ V}$ to $\pm 4\text{ V}$ ($V_S = 4.5\text{ V}$ to 8 V) (continued)

 at $T_A = 25^\circ\text{C}$, $V_{CM} = V_{OUT} = V_S / 2$, and $R_{LOAD} = 10\text{ k}\Omega$ connected to $V_S / 2$ (unless otherwise noted)

PARAMETER		TEST CONDITIONS		MIN	TYP	MAX	UNIT
FREQUENCY RESPONSE							
GBW	Unity gain bandwidth				10		MHz
SR	Slew rate	$G = 1$, 1-V step			14		V/ μs
t_s	Settling time	To 0.01%	$V_S = \pm 3\text{ V}$, $G = 1$, 5-V step		1		μs
t_{OR}	Overload recovery time	$V_{IN} \times G = V_S$			200		ns
OUTPUT							
V_O	Voltage output swing from rail	Positive rail	No load		5	25	mV
			$R_{LOAD} = 10\text{ k}\Omega$		95	125	
			$R_{LOAD} = 2\text{ k}\Omega$		430	500	
		Negative rail	No load		5	25	
			$R_{LOAD} = 10\text{ k}\Omega$		95	125	
			$R_{LOAD} = 2\text{ k}\Omega$		430	500	
I_{SC}	Short-circuit current	$V_S = \pm 2.25\text{ V}$			± 65		mA
C_{LOAD}	Capacitive load drive			See Typical Characteristics			
Z_O	Open-loop output impedance	$f = 1\text{ MHz}$, $I_O = 0\text{ A}$, see Figure 26			375		Ω
POWER SUPPLY							
I_Q	Quiescent current per amplifier	$I_O = 0\text{ A}$			1	1.3	mA
				$T_A = -40^\circ\text{C}$ to $+125^\circ\text{C}$		1.5	
TEMPERATURE							
	Thermal protection ⁽¹⁾				140		$^\circ\text{C}$

 (1) For a detailed description of thermal protection, see the [Thermal Protection](#) section.

6.9 Typical Characteristics

Table 1. Table of Graphs

DESCRIPTION	FIGURE
Offset Voltage Production Distribution	Figure 1 , Figure 2 , Figure 3
Offset Voltage Drift Distribution	Figure 4
Offset Voltage vs Temperature	Figure 5
Offset Voltage vs Common-Mode Voltage	Figure 6 , Figure 7 , Figure 8
Offset Voltage vs Power Supply	Figure 9
Open-Loop Gain and Phase vs Frequency	Figure 10
Closed-Loop Gain and Phase vs Frequency	Figure 11
Input Bias Current vs Common-Mode Voltage	Figure 12
Input Bias Current vs Temperature	Figure 13
Output Voltage Swing vs Output Current (maximum supply)	Figure 14 , Figure 15
CMRR and PSRR vs Frequency	Figure 16
CMRR vs Temperature	Figure 17
PSRR vs Temperature	Figure 18
0.1-Hz to 10-Hz Noise	Figure 19
Input Voltage Noise Spectral Density vs Frequency	Figure 20
THD+N Ratio vs Frequency	Figure 21
THD+N vs Output Amplitude	Figure 22
Quiescent Current vs Supply Voltage	Figure 23
Quiescent Current vs Temperature	Figure 24
Open Loop Gain vs Temperature	Figure 25
Open Loop Output Impedance vs Frequency	Figure 26
Small Signal Overshoot vs Capacitive Load (100-mV output step)	Figure 27 , Figure 28
No Phase Reversal	Figure 29
Positive Overload Recovery	Figure 30
Negative Overload Recovery	Figure 31
Small-Signal Step Response (100 mV)	Figure 32 , Figure 33
Large-Signal Step Response	Figure 34
Settling Time	Figure 35 , Figure 36 , ,
Short-Circuit Current vs Temperature	Figure 37
Maximum Output Voltage vs Frequency	Figure 38
Propagation Delay Rising Edge	Figure 39
Propagation Delay Falling Edge	Figure 40

OPA197, OPA2197, OPA4197

ZHCSEI8C – JANUARY 2016 – REVISED MARCH 2018

www.ti.com.cn

at $T_A = 25^\circ\text{C}$, $V_S = \pm 18\text{ V}$, $V_{CM} = V_S / 2$, $R_{LOAD} = 10\text{ k}\Omega$ connected to $V_S / 2$, and $C_L = 100\text{ pF}$ (unless otherwise noted)

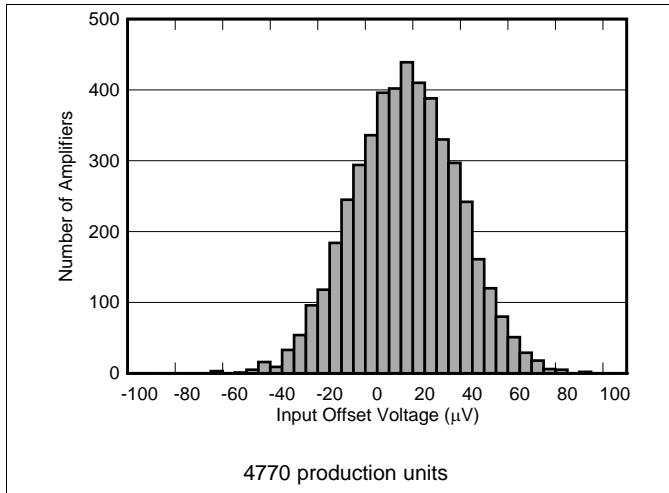

Figure 1. Offset Voltage Production Distribution at 25°C

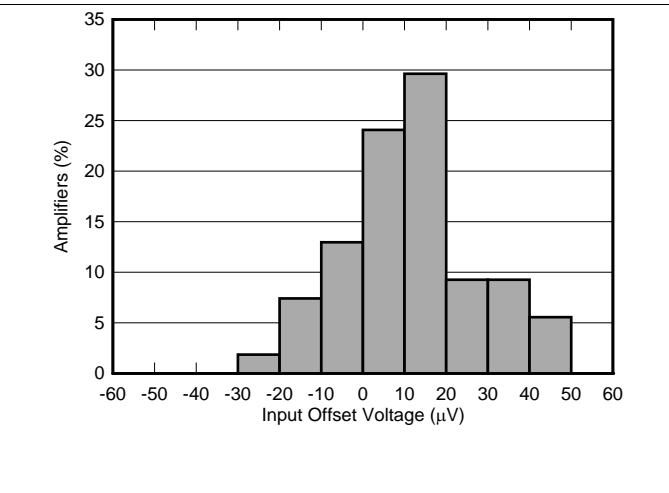

Figure 2. Offset Voltage Production Distribution at 125°C

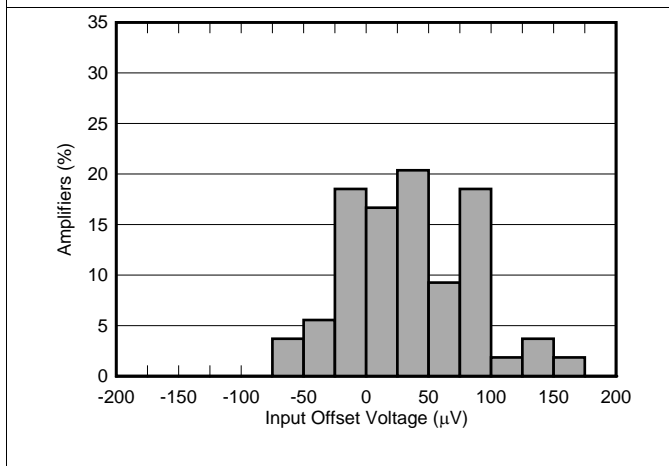

Figure 3. Offset Voltage Production Distribution at -40°C

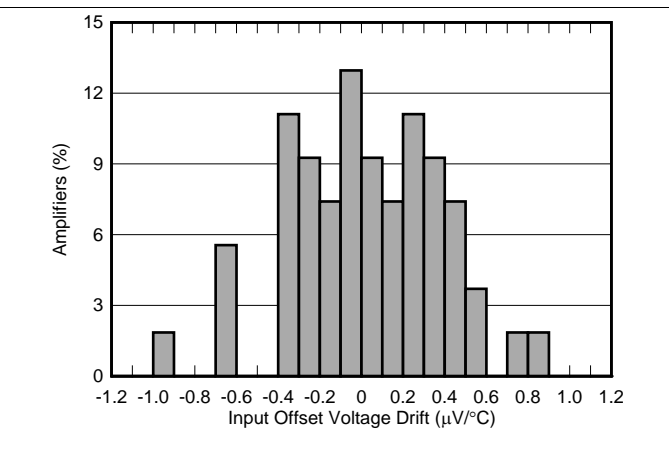

Figure 4. Offset Voltage Drift Distribution from -40°C to +125°C

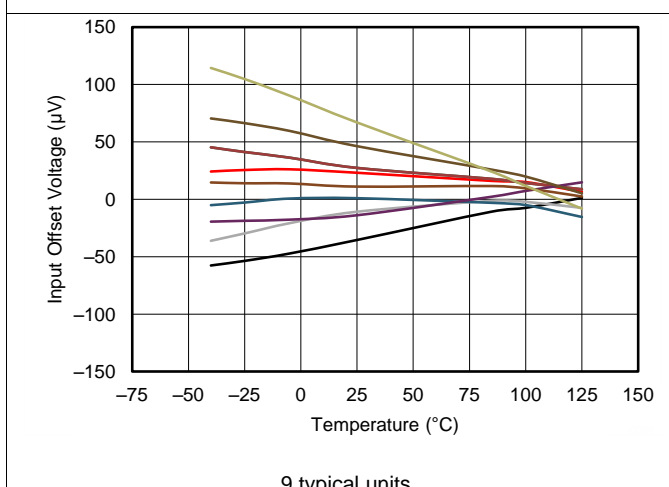

Figure 5. Offset Voltage vs Temperature

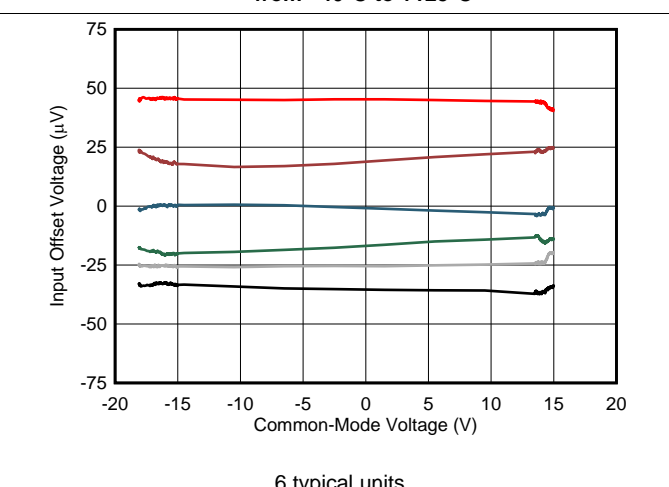
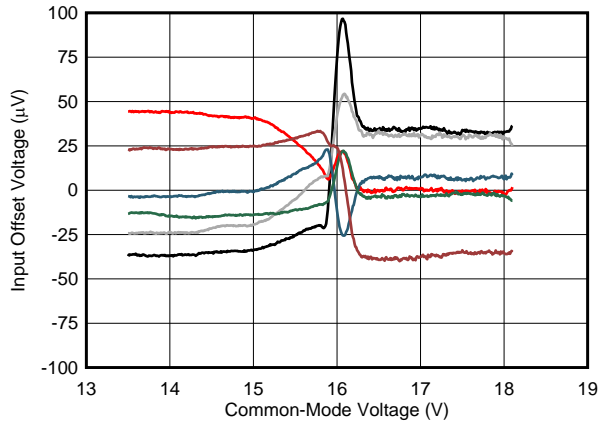

Figure 6. Offset Voltage vs Common-Mode Voltage

at $T_A = 25^\circ\text{C}$, $V_S = \pm 18\text{ V}$, $V_{CM} = V_S / 2$, $R_{LOAD} = 10\text{ k}\Omega$ connected to $V_S / 2$, and $C_L = 100\text{ pF}$ (unless otherwise noted)



6 typical units

Figure 7. Offset Voltage vs Common-Mode Voltage

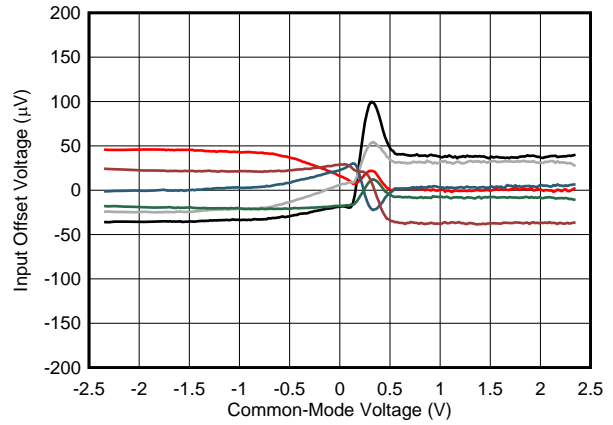

6 typical units

Figure 8. Offset Voltage vs Common-Mode Voltage

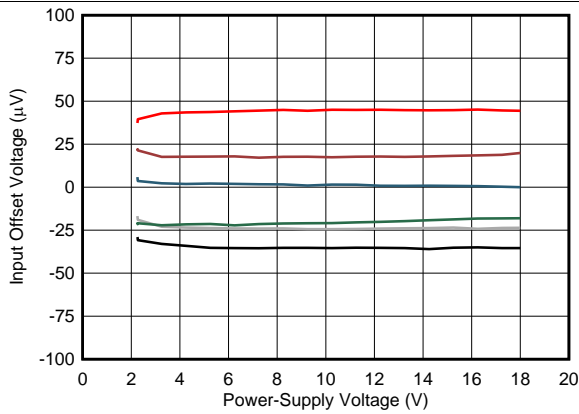

6 typical units

Figure 9. Offset Voltage vs Power Supply

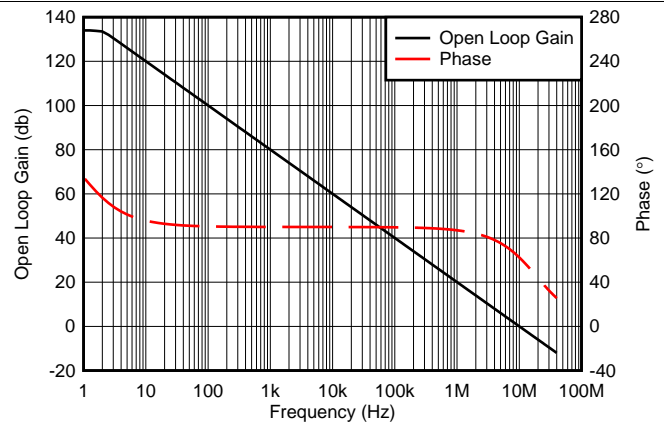

$C_{LOAD} = 15\text{ pF}$

Figure 10. Open-Loop Gain and Phase vs Frequency

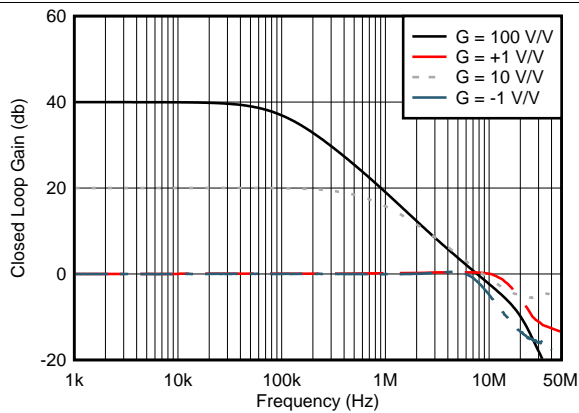

Figure 11. Closed-Loop Gain and Phase vs Frequency

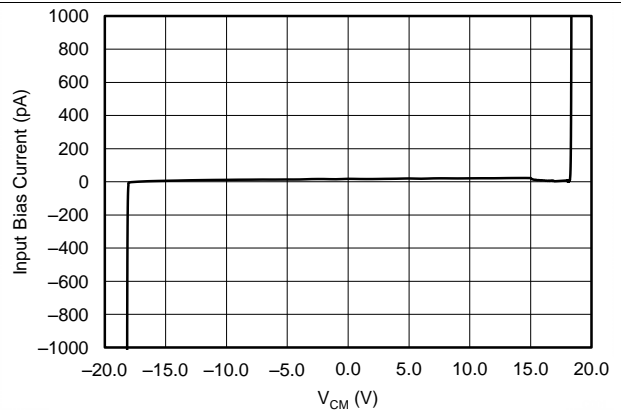

Figure 12. Input Bias Current vs Common-Mode Voltage

at $T_A = 25^\circ\text{C}$, $V_S = \pm 18\text{ V}$, $V_{CM} = V_S / 2$, $R_{LOAD} = 10\text{ k}\Omega$ connected to $V_S / 2$, and $C_L = 100\text{ pF}$ (unless otherwise noted)

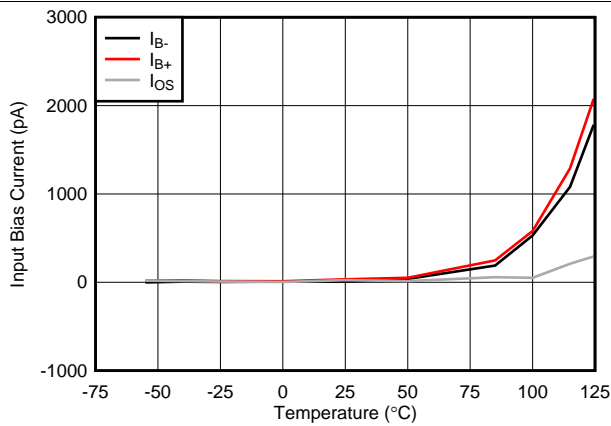

Figure 13. Input Bias Current vs Temperature

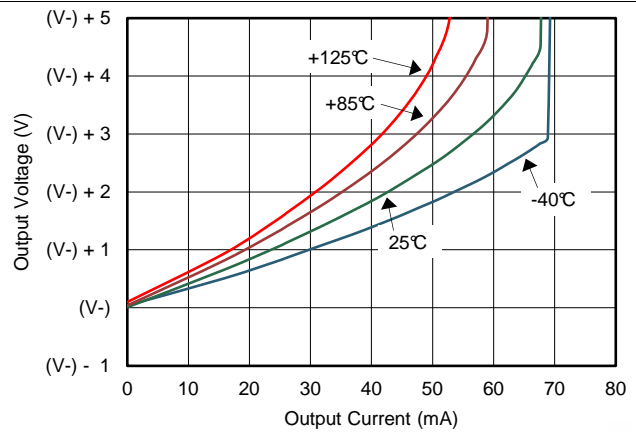

Figure 14. Output Voltage Swing from Negative Power Supply vs Output Current (Maximum Supply)

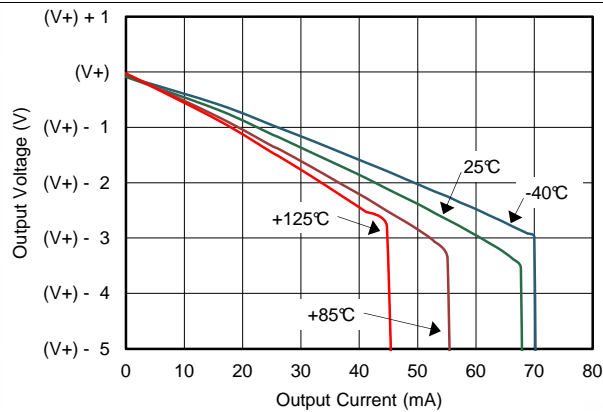

Figure 15. Output Voltage Swing from Positive Power Supply vs Output Current (Maximum Supply)

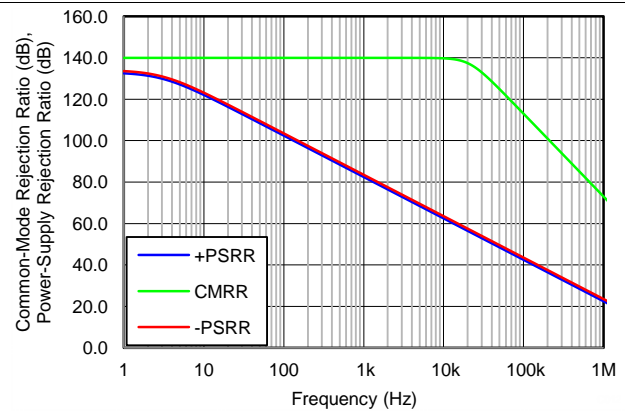

Figure 16. CMRR and PSRR vs Frequency

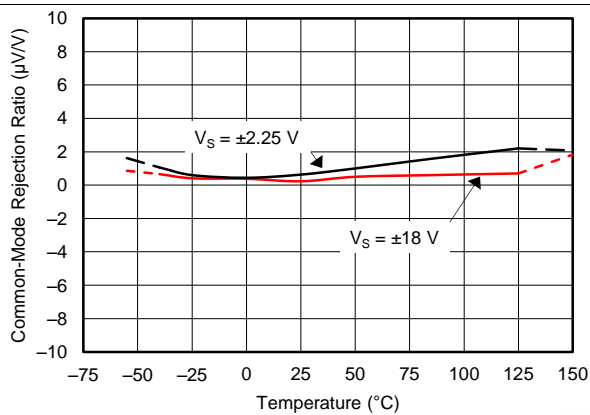

Figure 17. CMRR vs Temperature

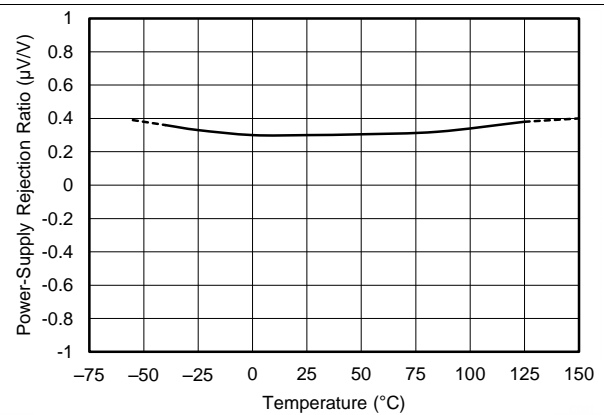

Figure 18. PSRR vs Temperature

at $T_A = 25^\circ\text{C}$, $V_S = \pm 18\text{ V}$, $V_{CM} = V_S / 2$, $R_{LOAD} = 10\text{ k}\Omega$ connected to $V_S / 2$, and $C_L = 100\text{ pF}$ (unless otherwise noted)

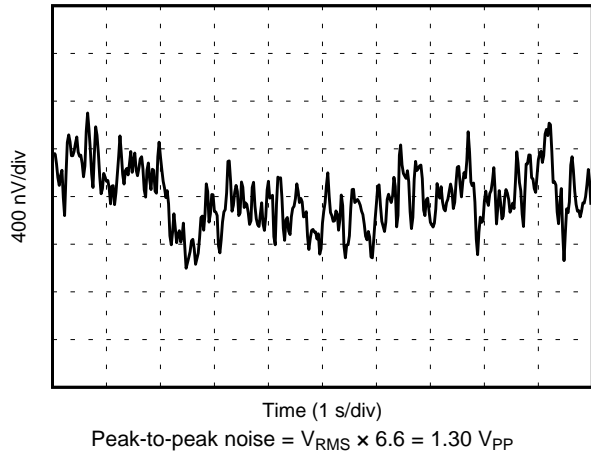

Figure 19. 0.1-Hz to 10-Hz Noise

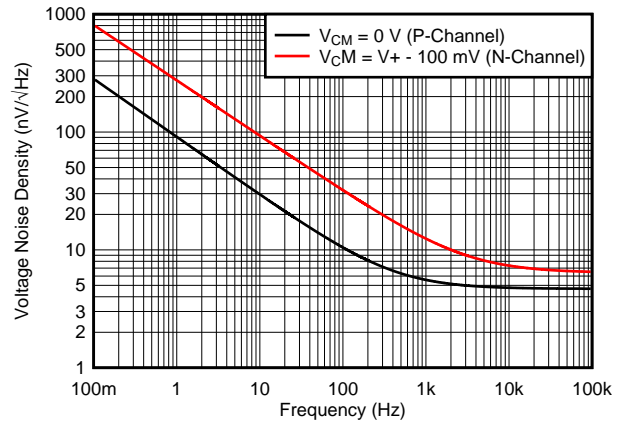
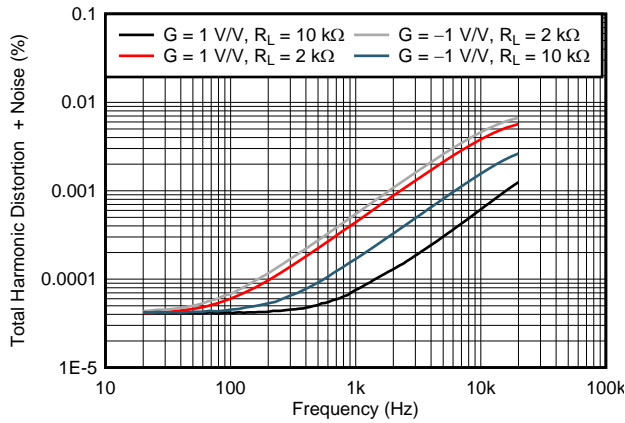
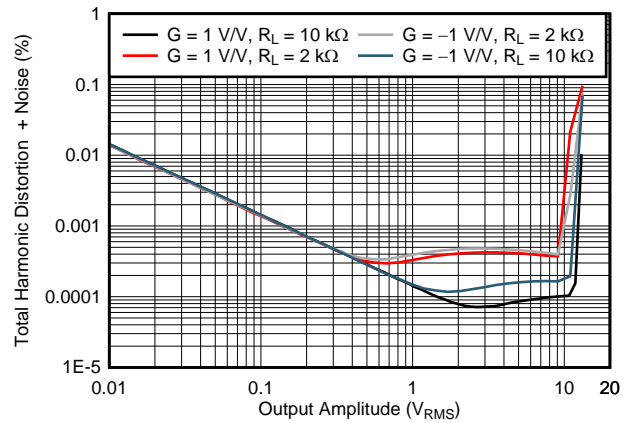

Figure 20. Input Voltage Noise Spectral Density vs Frequency



$V_{OUT} = 3.5 V_{RMS}$, $BW = 80\text{ kHz}$

Figure 21. THD+N Ratio vs Frequency



$f = 1\text{ kHz}$, $BW = 80\text{ kHz}$

Figure 22. THD+N vs Output Amplitude

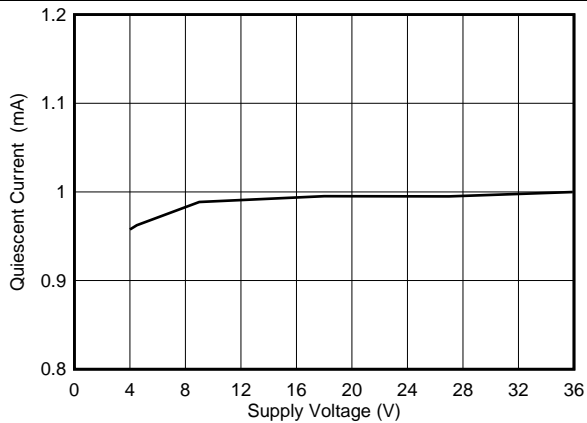

Figure 23. Quiescent Current vs Supply Voltage

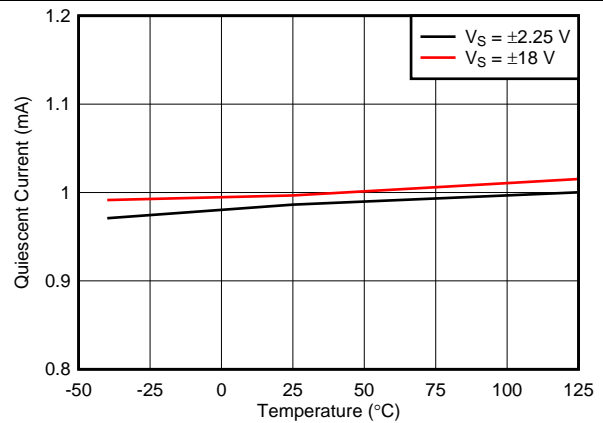

Figure 24. Quiescent Current vs Temperature

OPA197, OPA2197, OPA4197

ZHCSEI8C – JANUARY 2016 – REVISED MARCH 2018

www.ti.com.cn

at $T_A = 25^\circ\text{C}$, $V_S = \pm 18\text{ V}$, $V_{CM} = V_S / 2$, $R_{LOAD} = 10\text{ k}\Omega$ connected to $V_S / 2$, and $C_L = 100\text{ pF}$ (unless otherwise noted)

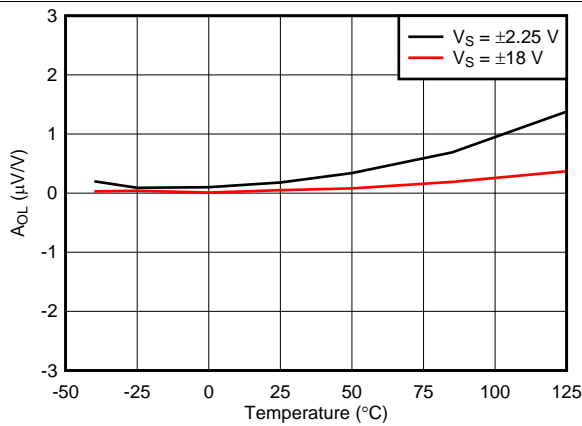

Figure 25. Open-Loop Gain vs Temperature

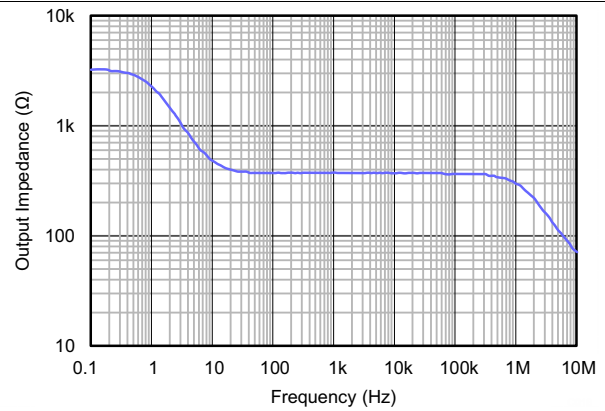
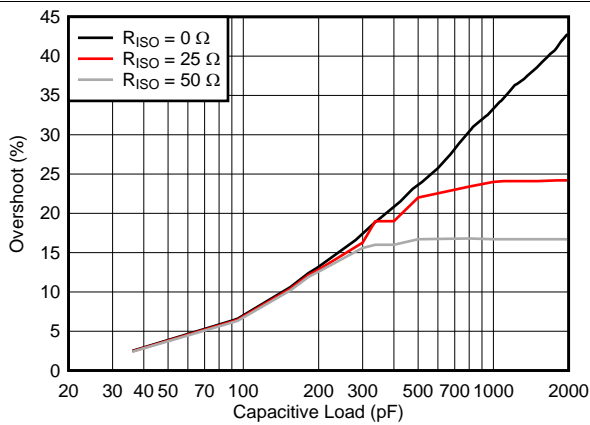
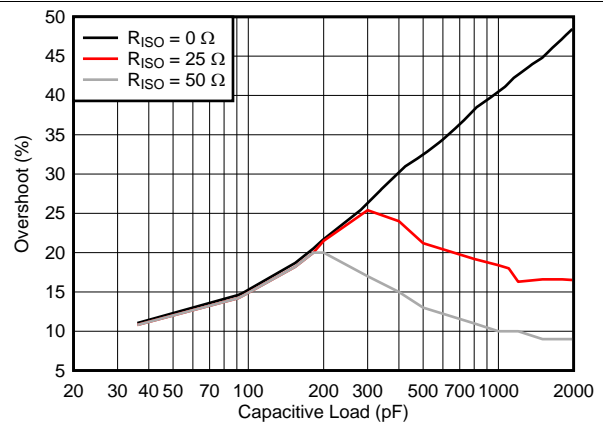

Figure 26. Open-Loop Output Impedance vs Frequency



$G = -1\text{ V/V}$

Figure 27. Small-Signal Overshoot vs Capacitive Load (100-mV Output Step)



$G = 1\text{ V/V}$

Figure 28. Small-Signal Overshoot vs Capacitive Load (100-mV Output Step)

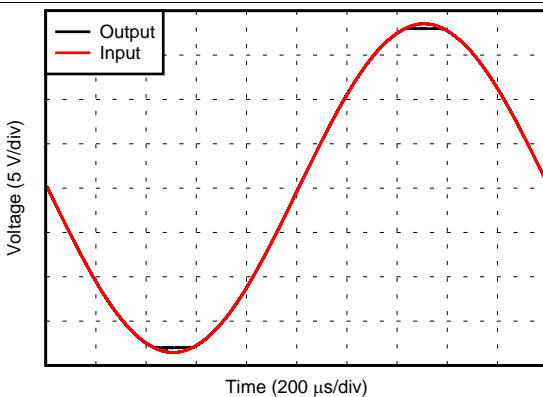

$V_S = \pm 18\text{ V}$, input = $\pm 18.5\text{ V}_{PP}$

Figure 29. No Phase Reversal

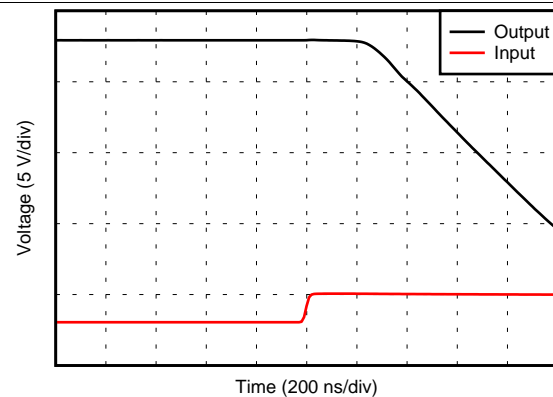

$G = -10\text{ V/V}$

Figure 30. Positive Overload Recovery

at $T_A = 25^\circ\text{C}$, $V_S = \pm 18\text{ V}$, $V_{CM} = V_S / 2$, $R_{LOAD} = 10\text{ k}\Omega$ connected to $V_S / 2$, and $C_L = 100\text{ pF}$ (unless otherwise noted)

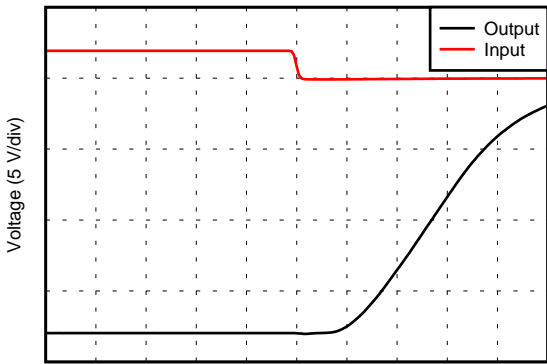

Time (200 ns/div)

$G = -10\text{ V/V}$

Figure 31. Negative Overload Recovery

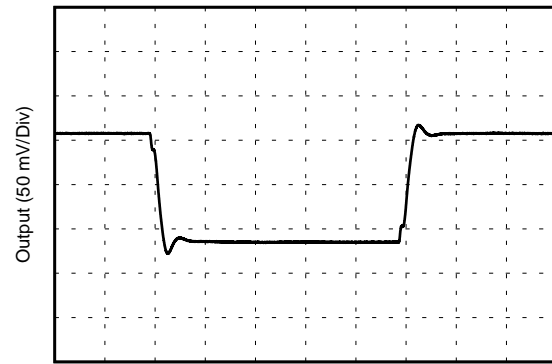

Time (200 ns/Div)

$G = 1\text{ V/V}$

Figure 32. Small-Signal Step Response

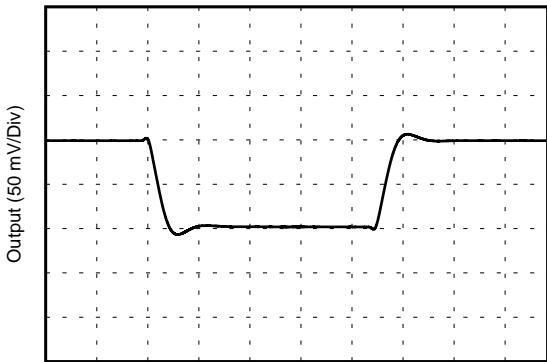

Time (150 ns/Div)

$G = -1\text{ V/V}$

Figure 33. Small-Signal Step Response

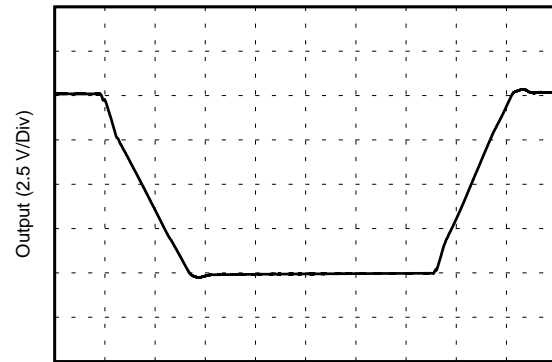

Time (300 ns/Div)

$G = 1\text{ V/V}$

Figure 34. Large-Signal Step Response

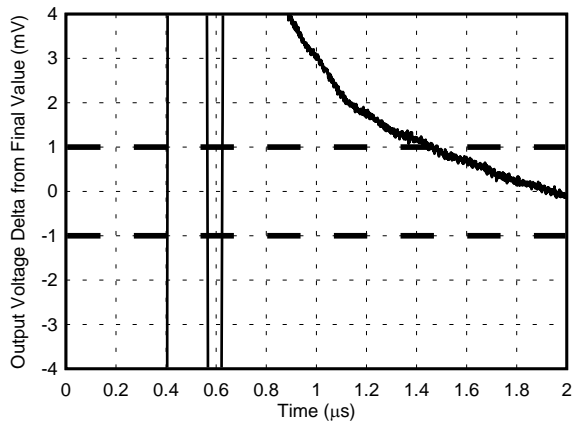

$G = 1$, 0.01% settling = $\pm 1\text{ mV}$, step applied at $t = 0$

Figure 35. Settling Time (10-V Positive Step)

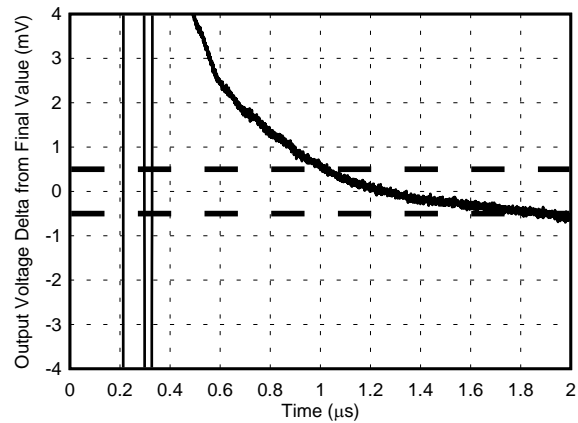

$G = 1$, 0.01% settling = $\pm 500\text{ }\mu\text{V}$, step applied at $t = 0$

Figure 36. Settling Time (5-V Positive Step)

OPA197, OPA2197, OPA4197

ZHCSEI8C – JANUARY 2016 – REVISED MARCH 2018

www.ti.com.cn

at $T_A = 25^\circ\text{C}$, $V_S = \pm 18\text{ V}$, $V_{CM} = V_S / 2$, $R_{LOAD} = 10\text{ k}\Omega$ connected to $V_S / 2$, and $C_L = 100\text{ pF}$ (unless otherwise noted)

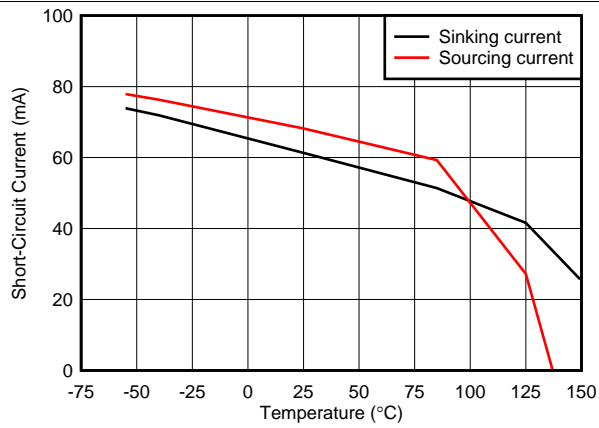

Figure 37. Short-Circuit Current vs Temperature

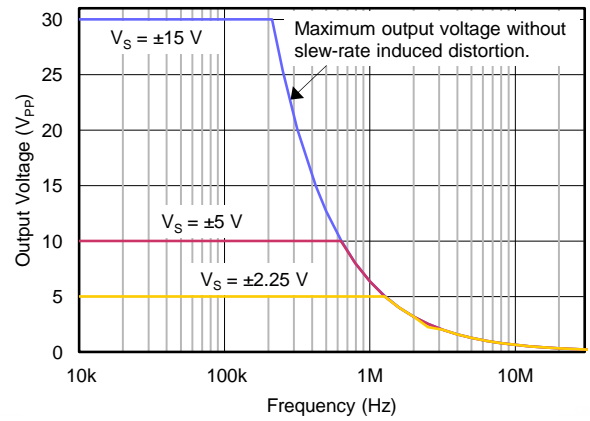

Figure 38. Maximum Output Voltage vs Frequency

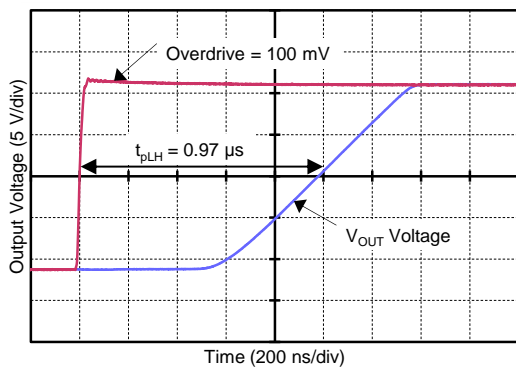

Figure 39. Propagation Delay Rising Edge

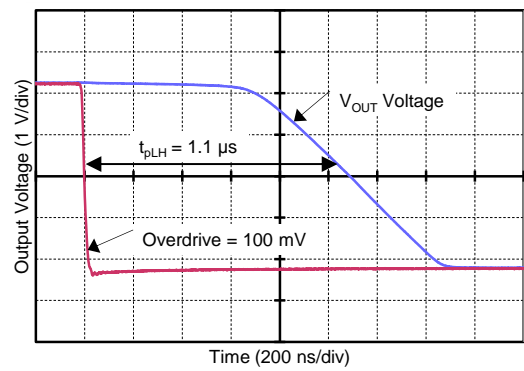

Figure 40. Propagation Delay Falling Edge

7 Detailed Description

7.1 Overview

The OPAx197 uses a patented two-temperature trim architecture to achieve a very low offset voltage of 250 μV (max) and low voltage offset drift of 0.75 $\mu\text{V}/^\circ\text{C}$ (maximum) over the full specified temperature range. This level of precision performance at wide supply voltages makes these amplifiers useful for high-impedance industrial sensors, filters, and high-voltage data acquisition.

7.2 Functional Block Diagram

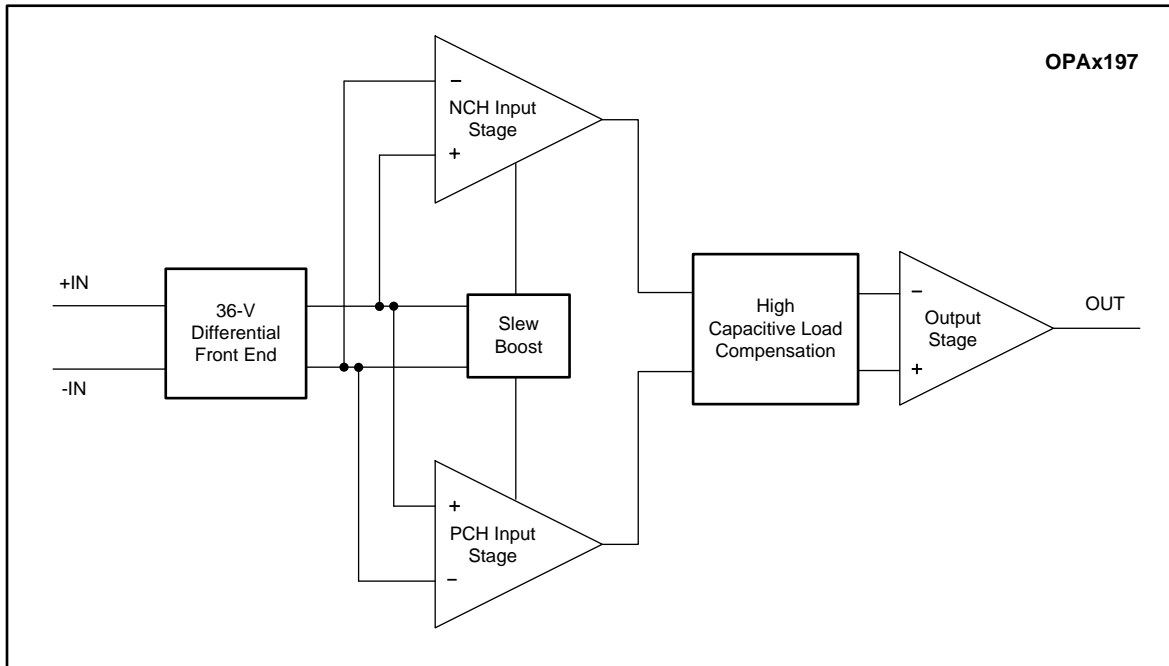

7.3 Feature Description

7.3.1 Input Protection Circuitry

The OPAx197 uses a unique input architecture to eliminate the need for input protection diodes, but still provides robust input protection under transient conditions. Conventional input diode protection schemes shown in Figure 41 can be activated by fast transient step responses and can introduce signal distortion and settling time delays because of alternate current paths, as shown in Figure 42. For low-gain circuits, these fast-ramping input signals forward-bias back-to-back diodes, causing an increase in input current, and resulting in extended settling time, as shown in Figure 43.

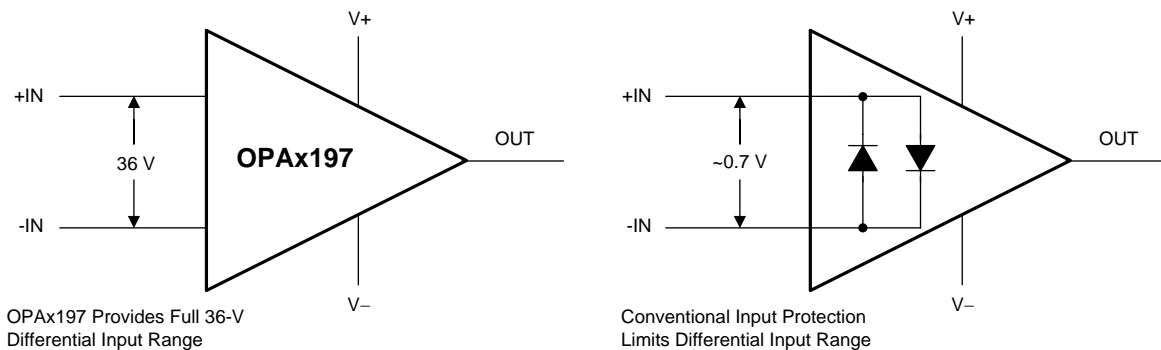

Figure 41. OPA197 Input Protection Does Not Limit Differential Input Capability

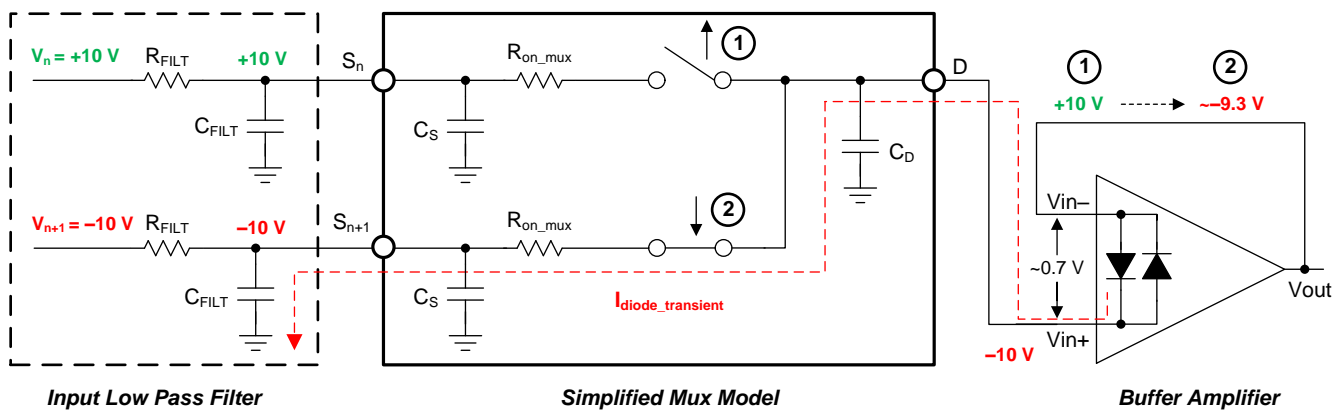

Figure 42. Back-to-Back Diodes Create Settling Issues

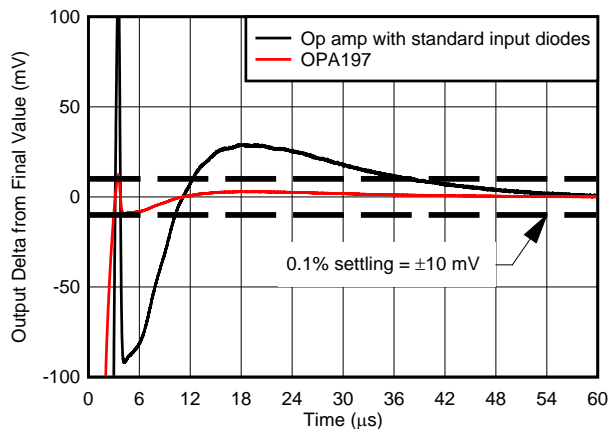

Figure 43. OPA197 Protection Circuit Maintains Fast-Settling Transient Response

Feature Description (continued)

The OPAx197 family of operational amplifiers provides a true high-impedance differential input capability for high-voltage applications. This patented input protection architecture does not introduce additional signal distortion or delayed settling time, making the device an optimal op amp for multichannel, high-switched, input applications. The OPA197 can tolerate a maximum differential swing (voltage between inverting and noninverting pins of the op amp) of up to 36 V, making the device suitable for use as a comparator or in applications with fast-ramping input signals such as multiplexed data-acquisition systems, as shown in [Figure 53](#).

7.3.2 EMI Rejection

The OPAx197 uses integrated electromagnetic interference (EMI) filtering to reduce the effects of EMI from sources such as wireless communications and densely-populated boards with a mix of analog signal chain and digital components. EMI immunity can be improved with circuit design techniques; the OPAx197 benefits from these design improvements. Texas Instruments has developed the ability to accurately measure and quantify the immunity of an operational amplifier over a broad frequency spectrum extending from 10 MHz to 6 GHz. [Figure 44](#) shows the results of this testing on the OPA197. [Table 2](#) shows the EMIRR IN+ values for the OPA197 at particular frequencies commonly encountered in real-world applications. Applications listed in [Table 2](#) may be centered on or operated near the particular frequency shown. Detailed information can also be found in the application report *EMI Rejection Ratio of Operational Amplifiers*, [SBOA128](#), available for download from [www.ti.com](#).

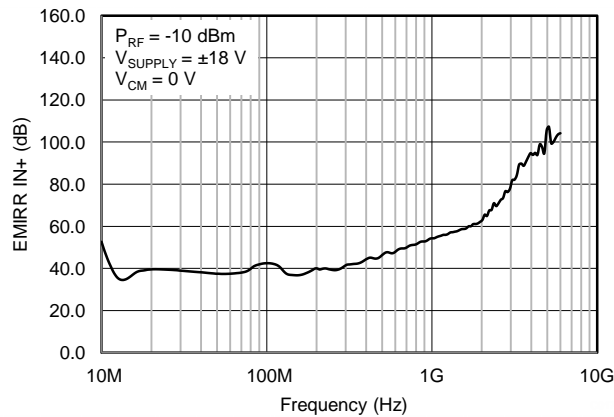

Figure 44. EMIRR Testing

Table 2. OPA197 EMIRR IN+ For Frequencies of Interest

FREQUENCY	APPLICATION OR ALLOCATION	EMIRR IN+
400 MHz	Mobile radio, mobile satellite, space operation, weather, radar, ultra-high frequency (UHF) applications	44.1 dB
900 MHz	Global system for mobile communications (GSM) applications, radio communication, navigation, GPS (to 1.6 GHz), GSM, aeronautical mobile, UHF applications	52.8 dB
1.8 GHz	GSM applications, mobile personal communications, broadband, satellite, L-band (1 GHz to 2 GHz)	61.0 dB
2.4 GHz	802.11b, 802.11g, 802.11n, Bluetooth®, mobile personal communications, industrial, scientific and medical (ISM) radio band, amateur radio and satellite, S-band (2 GHz to 4 GHz)	69.5 dB
3.6 GHz	Radiolocation, aero communication and navigation, satellite, mobile, S-band	88.7 dB
5.0 GHz	802.11a, 802.11n, aero communication and navigation, mobile communication, space and satellite operation, C-band (4 GHz to 8 GHz)	105.5 dB

7.3.3 Phase Reversal Protection

The OPAx197 family has internal phase-reversal protection. Many op amps exhibit a phase reversal when the input is driven beyond its linear common-mode range. This condition is most often encountered in noninverting circuits when the input is driven beyond the specified common-mode voltage range, causing the output to reverse into the opposite rail. The OPAx197 is a rail-to-rail input op amp; therefore, the common-mode range can extend up to the rails. Input signals beyond the rails do not cause phase reversal; instead, the output limits into the appropriate rail. This performance is shown in Figure 45.

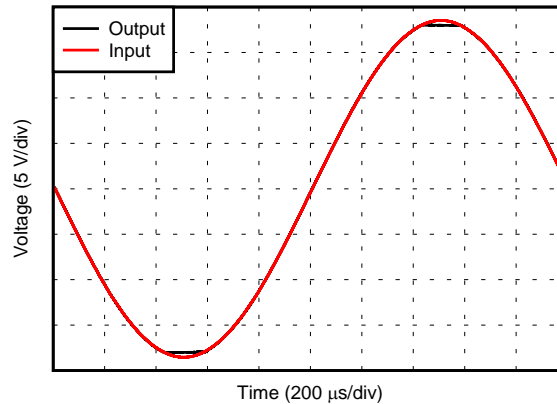

Figure 45. No Phase Reversal

7.3.4 Thermal Protection

The internal power dissipation of any amplifier causes its internal (junction) temperature to rise. This phenomenon is called *self heating*. The absolute maximum junction temperature of the OPAx197 is 150°C. Exceeding this temperature causes damage to the device. The OPAx197 has a thermal protection feature that prevents damage from self heating. The protection works by monitoring the temperature of the device and turning off the op amp output drive for temperatures above 140°C. Figure 46 shows an application example for the OPA197 that has significant self heating (159°C) because of its power dissipation (0.81 W). Thermal calculations indicate that for an ambient temperature of 65°C the device junction temperature must reach 187°C. The actual device, however, turns off the output drive to maintain a safe junction temperature. Figure 46 depicts how the circuit behaves during thermal protection. During normal operation, the device acts as a buffer so the output is 3 V. When self heating causes the device junction temperature to increase above 140°C, the thermal protection forces the output to a high-impedance state and the output is pulled to ground through resistor RL.

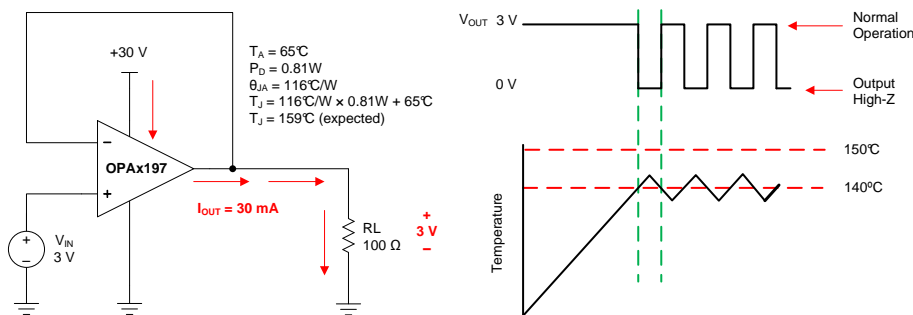

Figure 46. Thermal Protection

7.3.5 Capacitive Load and Stability

The OPAx197 features a patented output stage capable of driving large capacitive loads, and in a unity-gain configuration, directly drives up to 1 nF of pure capacitive load. Increasing the gain enhances the ability of the amplifier to drive greater capacitive loads; see Figure 47 and Figure 48. The particular op amp circuit configuration, layout, gain, and output loading are some of the factors to consider when establishing whether an amplifier will be stable in operation.

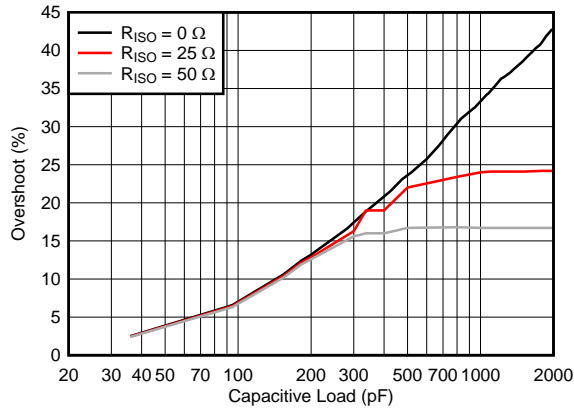

Figure 47. Small-Signal Overshoot vs Capacitive Load (100-mV Output Step, G = -1 V/V)

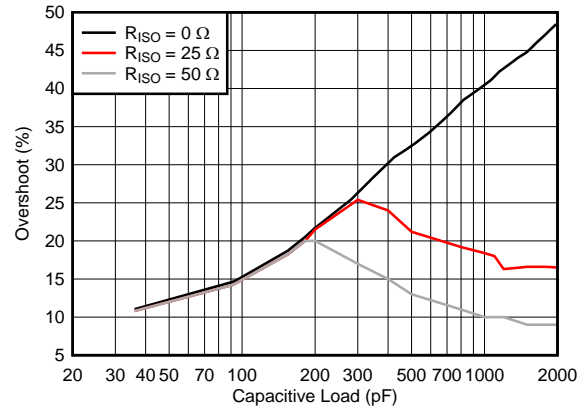

Figure 48. Small-Signal Overshoot vs Capacitive Load (100-mV Output Step, G = 1 V/V)

For additional drive capability in unity-gain configurations, improve capacitive load drive by inserting a small (10-Ω to 20-Ω) resistor, R_{ISO} , in series with the output, as shown in Figure 49. This resistor significantly reduces ringing while maintaining dc performance for purely capacitive loads. However, if there is a resistive load in parallel with the capacitive load, a voltage divider is created, introducing a gain error at the output and slightly reducing the output swing. The error introduced is proportional to the ratio R_{ISO} / R_L , and is generally negligible at low output levels. A high capacitive load drive makes the OPA197 well suited for applications such as reference buffers, MOSFET gate drives, and cable-shield drives. The circuit shown in Figure 49 uses an isolation resistor, R_{ISO} , to stabilize the output of an op amp. R_{ISO} modifies the open-loop gain of the system for increased phase margin, and results using the OPA197 are summarized in Table 3. For additional information on techniques to optimize and design using this circuit, TI Precision Design TIDU032 details complete design goals, simulation, and test results.

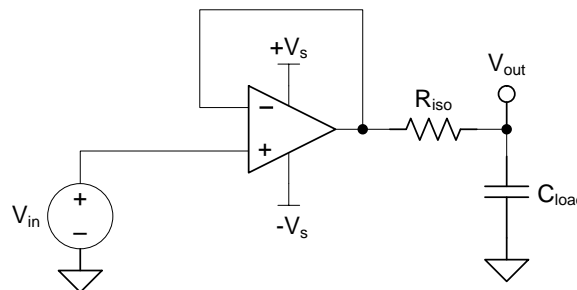

Figure 49. Extending Capacitive Load Drive with the OPA197

Table 3. OPA197 Capacitive Load Drive Solution Using Isolation Resistor Comparison of Calculated and Measured Results

PARAMETER	VALUE									
	100 pF		1000 pF		0.01 μF		0.1 μF		1 μF	
Phase Margin	45°	60°	45°	60°	45°	60°	45°	60°	45°	60°
R_{ISO} (Ω)	47.0	360.0	24.0	100.0	20.0	51.0	6.2	15.8	2.0	4.7
Measured Overshoot (%)	23.2	8.6	10.4	22.5	9.0	22.1	8.7	23.1	8.6	21.0
Calculated PM	45.1°	58.1°	45.8°	59.7°	46.1°	60.1°	45.2°	60.2°	47.2°	60.2°



For step-by-step design procedure, circuit schematics, bill of materials, printed circuit board (PCB) files, simulation results, and test results, refer to TI Precision Design TIDU032, [Capacitive Load Drive Solution using an Isolation Resistor](#).

7.3.6 Common-Mode Voltage Range

The OPAx197 is a 36-V, true rail-to-rail input operational amplifier with an input common-mode range that extends 100 mV beyond either supply rail. This wide range is achieved with paralleled complementary N-channel and P-channel differential input pairs, as shown in Figure 50. The N-channel pair is active for input voltages close to the positive rail, typically $(V+) - 3\text{ V}$ to 100 mV above the positive supply. The P-channel pair is active for inputs from 100 mV below the negative supply to approximately $(V+) - 1.5\text{ V}$. There is a small transition region, typically $(V+) - 3\text{ V}$ to $(V+) - 1.5\text{ V}$ in which both input pairs are on. This transition region can vary modestly with process variation, and within this region PSRR, CMRR, offset voltage, offset drift, noise and THD performance may be degraded compared to operation outside this region.

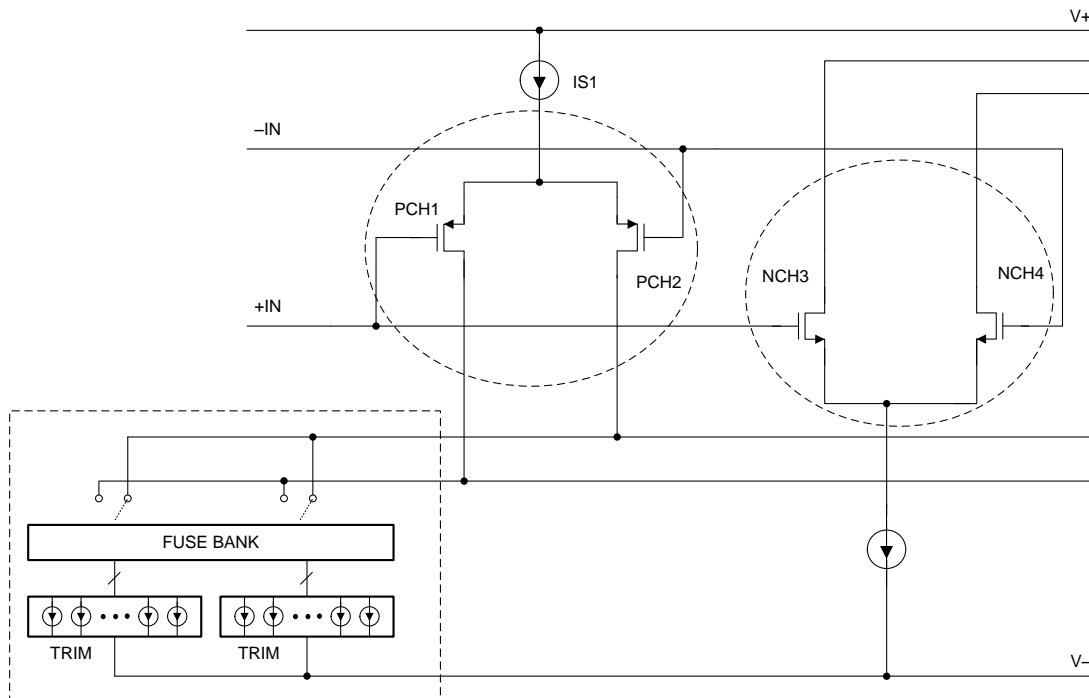

Figure 50. Rail-to-Rail Input Stage

To achieve the best performance for two-stage rail-to-rail input amplifiers, avoid the transition region when possible. The OPAx197 uses a precision trim for both the N-channel and P-channel regions. This technique enables significantly lower levels of offset than previous-generation devices, causing variance in the transition region of the input stages to appear exaggerated relative to offset over the full common-mode voltage range, as shown in Figure 51.

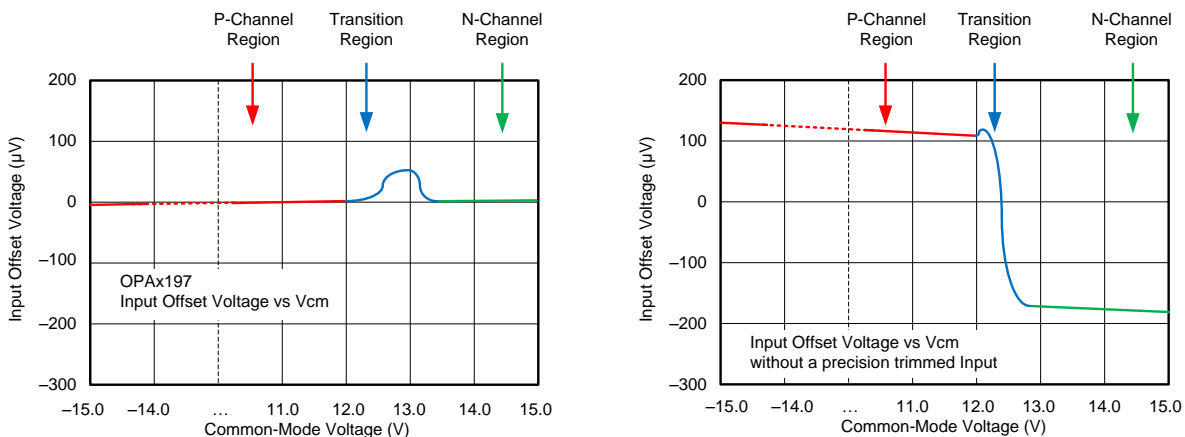

Figure 51. Common-Mode Transition vs Standard Rail-to-Rail Amplifiers

7.3.7 Electrical Overstress

Designers often ask questions about the capability of an operational amplifier to withstand electrical overstress (EOS). These questions tend to focus on the device inputs, but may involve the supply voltage pins or even the output pin. Each of these different pin functions have electrical stress limits determined by the voltage breakdown characteristics of the particular semiconductor fabrication process and specific circuits connected to the pin. Additionally, internal electrostatic discharge (ESD) protection is built into these circuits to protect them from accidental ESD events both before and during product assembly.

Having a good understanding of this basic ESD circuitry and its relevance to an electrical overstress event is helpful. See [Figure 52](#) for an illustration of the ESD circuits contained in the OPAx197 (indicated by the dashed line area). The ESD protection circuitry involves several current-steering diodes connected from the input and output pins and routed back to the internal power-supply lines, where the diodes meet at an absorption device or the power-supply ESD cell, internal to the operational amplifier. This protection circuitry is intended to remain inactive during normal circuit operation.

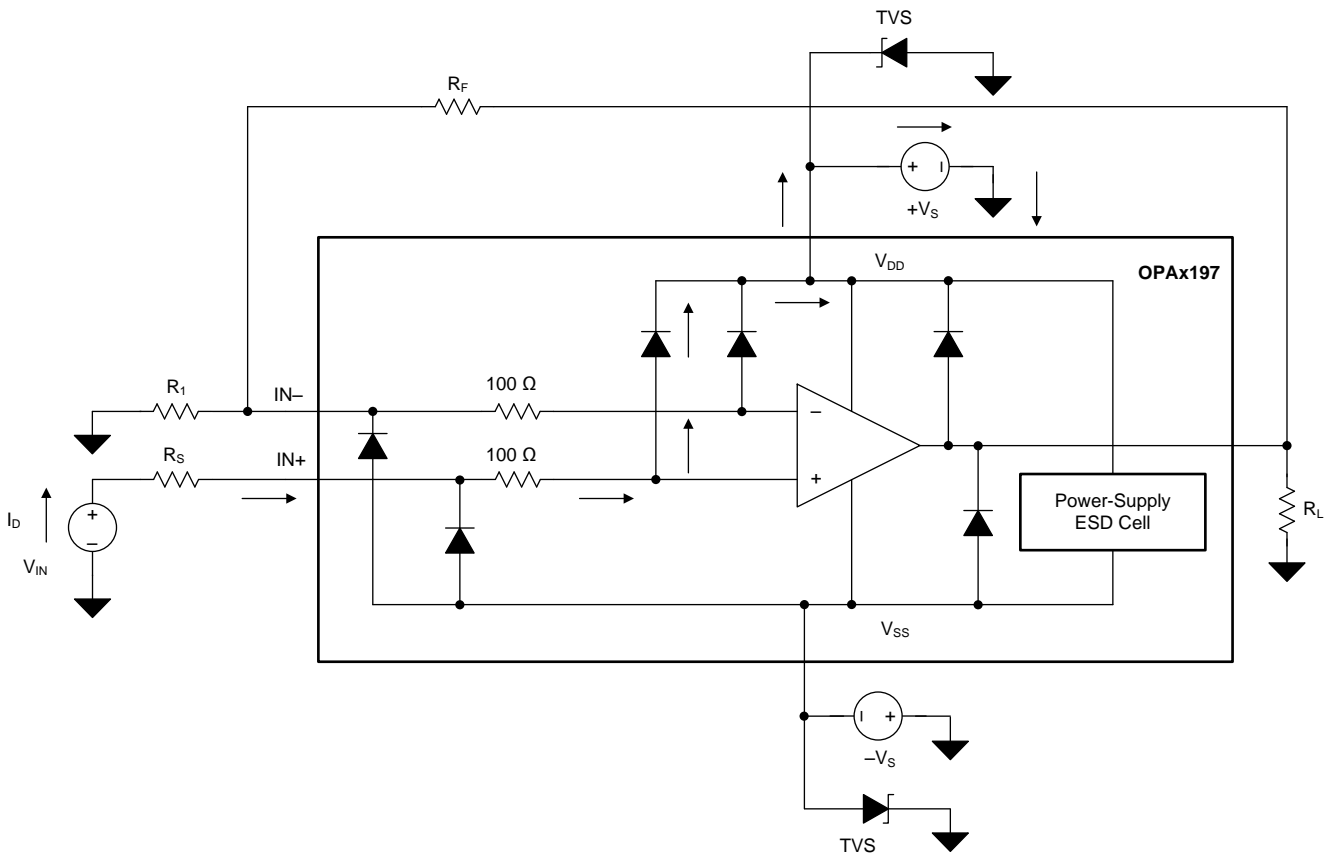

Figure 52. Equivalent Internal ESD Circuitry Relative to a Typical Circuit Application

An ESD event is very short in duration and very high voltage (for example, 1 kV, 100 ns), whereas an EOS event is long duration and lower voltage (for example, 50 V, 100 ms). The ESD diodes are designed for out-of-circuit ESD protection (that is, during assembly, test, and storage of the device before being soldered to the PCB). During an ESD event, the ESD signal is passed through the ESD steering diodes to an absorption circuit (labeled ESD power-supply circuit). The ESD absorption circuit clamps the supplies to a safe level.

Although this behavior is necessary for out-of-circuit protection, excessive current and damage is caused if activated in-circuit. A transient voltage suppressors (TVS) can be used to prevent against damage caused by turning on the ESD absorption circuit during an in-circuit ESD event. Using the appropriate current limiting resistors and TVS diodes allows for the use of device ESD diodes to protect against EOS events.

7.3.8 Overload Recovery

Overload recovery is defined as the time required for the op amp output to recover from a saturated state to a linear state. The output devices of the op amp enter a saturation region when the output voltage exceeds the rated operating voltage, either due to the high input voltage or the high gain. After the device enters the saturation region, the charge carriers in the output devices require time to return back to the linear state. After the charge carriers return back to the linear state, the device begins to slew at the specified slew rate. Thus, the propagation delay in case of an overload condition is the sum of the overload recovery time and the slew time. The overload recovery time for the OPAx197 is approximately 200 ns.

7.4 Device Functional Modes

The OPAx197 has a single functional mode and is operational when the power-supply voltage is greater than 4.5 V (± 2.25 V). The maximum power supply voltage for the OPAx197 is 36 V (± 18 V).

8 Application and Implementation

NOTE

Information in the following applications sections is not part of the TI component specification, and TI does not warrant its accuracy or completeness. TI's customers are responsible for determining suitability of components for their purposes. Customers should validate and test their design implementation to confirm system functionality.

8.1 Application Information

The OPAx197 family offers outstanding dc precision and ac performance. These devices operate up to 36-V supply rails and offer true rail-to-rail input/output, ultralow offset voltage and offset voltage drift, as well as 10-MHz bandwidth and high capacitive load drive. These features make the OPAx197 a robust, high-performance operational amplifier for high-voltage industrial applications.

8.2 Typical Applications

8.2.1 16-Bit Precision Multiplexed Data-Acquisition System

Figure 53 shows a 16-bit, differential, 4-channel, multiplexed data-acquisition system. This example is typical in industrial applications that require low distortion and a high-voltage differential input. The circuit uses the ADS8864, a 16-bit, 400-kSPS successive-approximation-resistor (SAR) analog-to-digital converter (ADC), along with a precision, high-voltage, signal-conditioning front end, and a 4-channel differential multiplexer (mux). This application example explains the process for optimizing the precision, high-voltage, front-end drive circuit using the OPA197 and OPA140 to achieve excellent dynamic performance and linearity with the ADS8864.

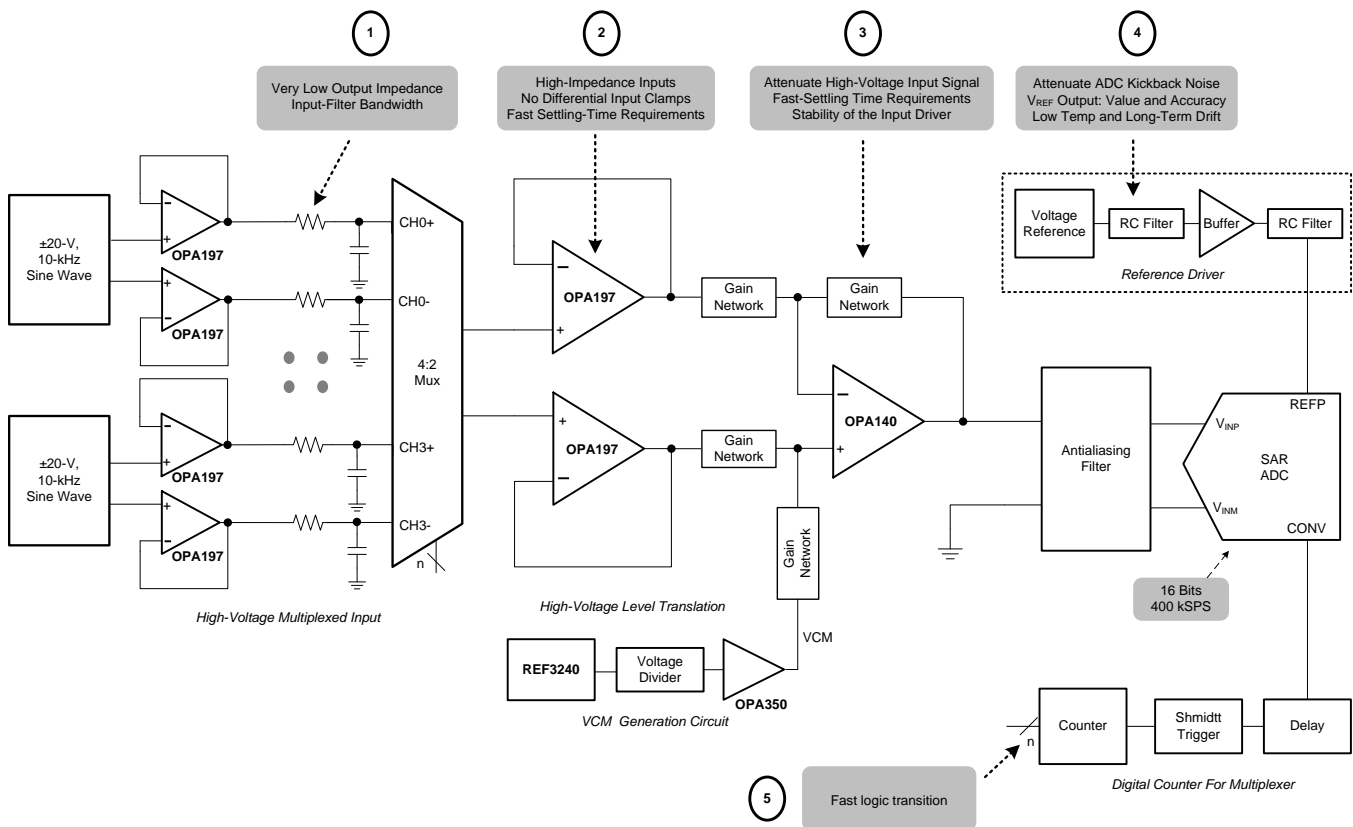

Figure 53. OPA197 in 16-Bit, 400-kSPS, 4-Channel, Multiplexed Data Acquisition System for High-Voltage Inputs With Lowest Distortion

Typical Applications (continued)

8.2.1.1 Design Requirements

The primary objective is to design a ± 20 V, differential 4-channel multiplexed data acquisition system with lowest distortion using the 16-bit ADS8864 at a throughput of 400 kSPS for a 10 kHz full-scale pure sine-wave input. The design requirements for this block design are:

- System Supply Voltage: ± 15 V
- ADC Supply Voltage: 3.3 V
- ADC Sampling Rate: 400 kSPS
- ADC Reference Voltage (REFP): 4.096 V
- System Input Signal: A high-voltage differential input signal with a peak amplitude of 10 V and frequency (f_{IN}) of 10 kHz are applied to each differential input of the mux.

8.2.1.2 Detailed Design Procedure

The purpose of this precision design is to design an optimal high voltage multiplexed data acquisition system for highest system linearity and fast settling. The overall system block diagram is shown in [Figure 53](#). The circuit is a multichannel data acquisition signal chain consisting of an input low-pass filter, multiplexer (mux), mux output buffer, attenuating SAR ADC driver, digital counter for mux and the reference driver. The architecture allows fast sampling of multiple channels using a single ADC, providing a low-cost solution. The two primary design considerations to maximize the performance of a precision multiplexed data acquisition system are the mux input analog front-end and the high-voltage level translation SAR ADC driver design. However, carefully design each analog circuit block based on the ADC performance specifications in order to achieve the fastest settling at 16-bit resolution and lowest distortion system. The diagram includes the most important specifications for each individual analog block.

This design systematically approaches each analog circuit block to achieve a 16-bit settling for a full-scale input stage voltage and linearity for a 10-kHz sinusoidal input signal at each input channel. The first step in the design is to understand the requirement for extremely low impedance input-filter design for the mux. This understanding helps in the decision of an appropriate input filter and selection of a mux to meet the system settling requirements. The next important step is the design of the attenuating analog front end (AFE) used to level translate the high-voltage input signal to a low-voltage ADC input while maintaining the amplifier stability. The next step is to design a digital interface to switch the mux input channels with minimum delay. The final design challenge is to design a high-precision, reference-driver circuit that provides the required REFP reference voltage with low offset, drift, and noise contributions.

8.2.1.3 Application Curve

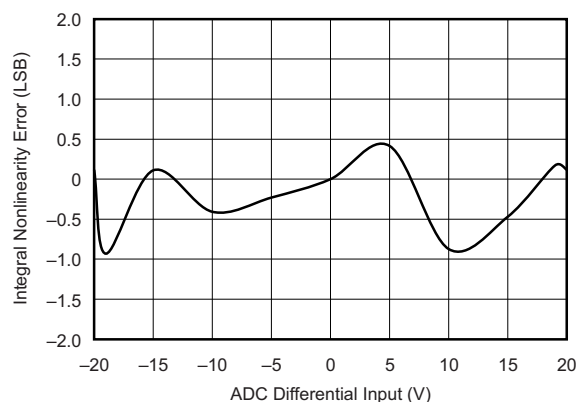

Figure 54. ADC 16-Bit Linearity Error for the Multiplexed Data Acquisition Block



For step-by-step design procedure, circuit schematics, bill of materials, PCB files, simulation results, and test results, refer to [TI Precision Design TIDU181, 16-bit, 400-kSPS, 4-Channel, Multiplexed Data Acquisition System for High Voltage Inputs with Lowest Distortion](#).

8.2.2 Slew Rate Limit for Input Protection

In control systems for valves or motors, abrupt changes in voltages or currents can cause mechanical damages. By controlling the slew rate of the command voltages into the drive circuits, the load voltages ramps up and down at a safe rate. For symmetrical slew-rate applications (positive slew rate equals negative slew rate), one additional op amp provides slew-rate control for a given analog gain stage. The unique input protection and high output current and slew rate of the OPAx197 make the device an optimal amplifier to achieve slew rate control for both dual- and single-supply systems. [Figure 55](#) shows the OPA197 in a slew-rate limit design.

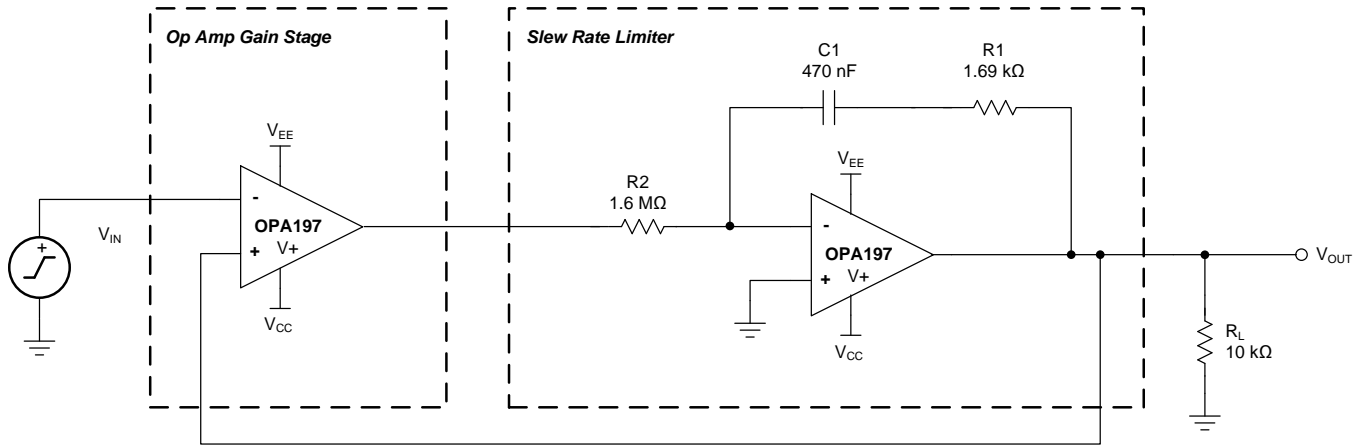

Figure 55. Slew Rate Limiter Uses One Op Amp



For step-by-step design procedure, circuit schematics, bill of materials, PCB files, simulation results, and test results, refer to [TI Precision Design TIDU026, Slew Rate Limiter Uses One Op Amp](#).

8.2.3 Precision Reference Buffer

The OPAx197 features high output current drive capability and low input offset voltage, making the device an excellent reference buffer to provide an accurate buffered output with ample drive current for transients. For the 10- μF ceramic capacitor shown in [Figure 56](#), R_{ISO} , a 37.4- Ω isolation resistor, provides separation of two feedback paths for optimal stability. Feedback path number one is through R_{F} and is directly at the output, V_{OUT} . Feedback path number two is through R_{Fx} and C_{F} and is connected at the output of the op amp. The optimized stability components shown for the 10- μF load give a closed-loop signal bandwidth at V_{OUT} of 4 kHz, while still providing a loop gain phase margin of 89°. Any other load capacitances require recalculation of the stability components: R_{F} , R_{Fx} , C_{F} , and R_{ISO} .

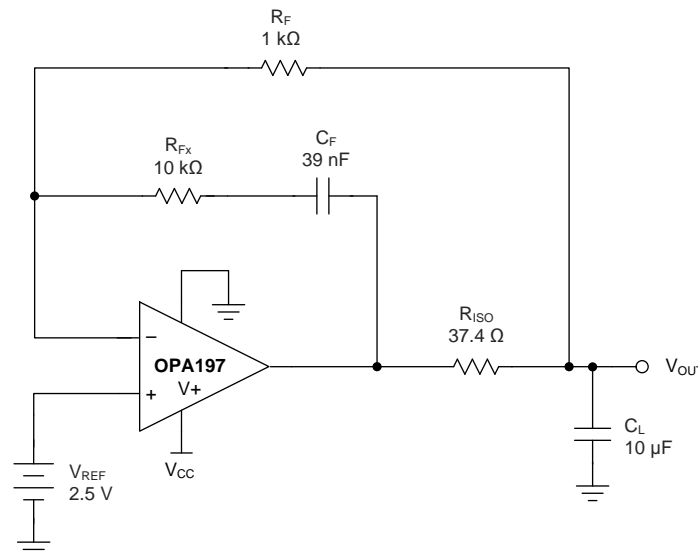

Figure 56. Precision Reference Buffer

9 Power Supply Recommendations

The OPAx197 is specified for operation from 4.5 V to 36 V (± 2.25 V to ± 18 V); many specifications apply from -40°C to $+125^{\circ}\text{C}$. Parameters that can exhibit significant variance with regard to operating voltage or temperature are presented in the [Typical Characteristics](#).

CAUTION

Supply voltages larger than 40 V can permanently damage the device; see the [Absolute Maximum Ratings](#).

Place 0.1- μF bypass capacitors close to the power-supply pins to reduce errors coupling in from noisy or high-impedance power supplies. For more detailed information on bypass capacitor placement, refer to the [Layout](#) section.

10 Layout

10.1 Layout Guidelines

For best operational performance of the device, use good PCB layout practices, including:

- Noise can propagate into analog circuitry through the power pins of the circuit as a whole and op amp itself. Bypass capacitors are used to reduce the coupled noise by providing low-impedance power sources local to the analog circuitry.
 - Connect low-ESR, 0.1- μ F ceramic bypass capacitors between each supply pin and ground, placed as close to the device as possible. A single bypass capacitor from V+ to ground is applicable for single-supply applications.
- Separate grounding for analog and digital portions of circuitry is one of the simplest and most-effective methods of noise suppression. One or more layers on multilayer PCBs are usually devoted to ground planes. A ground plane helps distribute heat and reduces EMI noise pickup. Make sure to physically separate digital and analog grounds paying attention to the flow of the ground current. For more detailed information refer to *Circuit Board Layout Techniques*, [SLOA089](#).
- In order to reduce parasitic coupling, run the input traces as far away from the supply or output traces as possible. If these traces cannot be kept separate, crossing the sensitive trace perpendicular is much better as opposed to in parallel with the noisy trace.
- Place the external components as close to the device as possible. As shown in [Figure 57](#), keeping RF and RG close to the inverting input minimizes parasitic capacitance.
- Keep the length of input traces as short as possible. Always remember that the input traces are the most sensitive part of the circuit.
- Consider a driven, low-impedance guard ring around the critical traces. A guard ring can significantly reduce leakage currents from nearby traces that are at different potentials.
- Cleaning the PCB following board assembly is recommended for best performance.
- Any precision integrated circuit may experience performance shifts due to moisture ingress into the plastic package. Following any aqueous PCB cleaning process, baking the PCB assembly is recommended to remove moisture introduced into the device packaging during the cleaning process. A low temperature, post cleaning bake at 85°C for 30 minutes is sufficient for most circumstances.

10.2 Layout Example

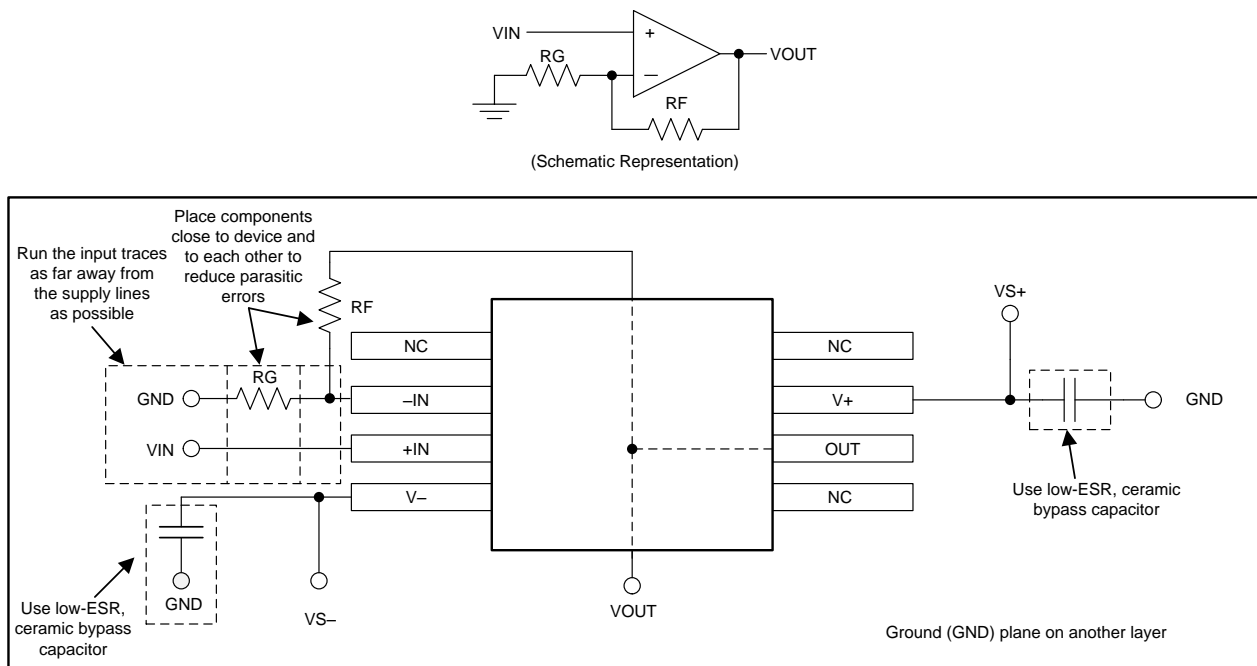

Figure 57. Operational Amplifier Board Layout for Noninverting Configuration

11 器件和文档支持

11.1 器件支持

11.1.1 开发支持

11.1.1.1 TINA-TI™ (免费下载)

TINA™是一款简单、功能强大且易于使用的电路仿真程序，此程序基于 SPICE 引擎。TINA-TI 是 TINA 软件的一款免费全功能版本，除了一系列无源和有源模型外，此版本软件还预先载入了一个宏模型库。TINA-TI 提供所有传统的 SPICE 直流、瞬态和频域分析，以及其他设计功能。

TINA-TI 可从 Analog eLab Design Center (模拟电子实验室设计中心) [免费下载](#)，它提供全面的后续处理能力，使得用户能够以多种方式形成结果。虚拟仪器提供选择输入波形和探测电路节点、电压和波形的功能，从而创建一个动态的快速入门工具。

注

这些文件需要安装 TINA 软件 (由 DesignSoft™提供) 或者 TINA-TI 软件。请从 [TINA-TI 文件夹](#) 中下载免费的 TINA-TI 软件。

11.1.1.2 TI 高精度设计

OPA197 采用多种 TI 高精度设计，获取相关内容请访问 [TI 高精度设计网站](#)。TI 高精度设计是由 TI 公司高精度模拟应用专家创建的模拟解决方案，提供了许多实用电路的工作原理、组件选择、仿真、完整印刷电路板 (PCB) 电路原理图和布局布线、物料清单以及性能测量结果。

11.2 文档支持

11.2.1 相关文档

如需相关文档，请参阅：

- 《[电路板布局布线技巧](#)》 (文献编号：SLOA089)
- 《[适用于所有人的运算放大器](#)》 (文献编号：SLOD006)

11.3 相关链接

[表 4](#) 列出了快速访问链接。类别包括技术文档、支持和社区资源、工具和软件以及申请样片或购买产品的快速访问链接。

表 4. 相关链接

器件	产品文件夹	样片与购买	技术文档	工具和软件	支持和社区
OPA197	请单击此处	请单击此处	请单击此处	请单击此处	请单击此处
OPA2197	请单击此处	请单击此处	请单击此处	请单击此处	请单击此处
OPA4197	请单击此处	请单击此处	请单击此处	请单击此处	请单击此处

11.4 接收文档更新通知

要接收文档更新通知，请导航至 TI.com.cn 上的器件产品文件夹。请单击右上角的提醒我进行注册，即可每周接收产品信息更改摘要。有关更改的详细信息，请查看任何已修订文档中包含的修订历史记录。

11.5 社区资源

下列链接提供到 TI 社区资源的连接。链接的内容由各个分销商“按照原样”提供。这些内容并不构成 TI 技术规范，并且不一定反映 TI 的观点；请参阅 TI 的《使用条款》。

TI E2E™ 在线社区 *TI 的工程师对工程师 (E2E) 社区*。此社区的创建目的在于促进工程师之间的协作。在 e2e.ti.com 中，您可以咨询问题、分享知识、拓展思路并与同行工程师一道帮助解决问题。

设计支持 *TI 参考设计支持* 可帮助您快速查找有帮助的 E2E 论坛、设计支持工具以及技术支持的联系信息。

11.6 商标

E2E is a trademark of Texas Instruments.

TINA-TI is a trademark of Texas Instruments, Inc and DesignSoft, Inc.

Bluetooth is a registered trademark of Bluetooth SIG, Inc.

TINA, DesignSoft are trademarks of DesignSoft, Inc.

All other trademarks are the property of their respective owners.

11.7 静电放电警告



ESD 可能会损坏该集成电路。德州仪器 (TI) 建议通过适当的预防措施处理所有集成电路。如果不遵守正确的处理措施和安装程序，可能会损坏集成电路。

ESD 的损坏小至导致微小的性能降级，大至整个器件故障。精密的集成电路可能更容易受到损坏，这是因为非常细微的参数更改都可能会导致器件与其发布的规格不相符。

11.8 Glossary

[SLYZ022](#) — *TI Glossary*.

This glossary lists and explains terms, acronyms, and definitions.

12 机械、封装和可订购信息

以下页面包含机械、封装和可订购信息。这些信息是指定器件的最新可用数据。数据如有变更，恕不另行通知，且不会对此文档进行修订。如需获取此数据表的浏览器版本，请查阅左侧的导航栏。

PACKAGING INFORMATION

Orderable Device	Status (1)	Package Type	Package Drawing	Pins	Package Qty	Eco Plan (2)	Lead finish/ Ball material (6)	MSL Peak Temp (3)	Op Temp (°C)	Device Marking (4/5)	Samples
OPA197ID	ACTIVE	SOIC	D	8	75	RoHS & Green	NIPDAU	Level-2-260C-1 YEAR	-40 to 125	OPA197	Samples
OPA197IDBVR	ACTIVE	SOT-23	DBV	5	3000	RoHS & Green	NIPDAU	Level-2-260C-1 YEAR	-40 to 125	12MV	Samples
OPA197IDBVT	ACTIVE	SOT-23	DBV	5	250	RoHS & Green	NIPDAU	Level-2-260C-1 YEAR	-40 to 125	12MV	Samples
OPA197IDGKR	ACTIVE	VSSOP	DGK	8	2500	RoHS & Green	NIPDAU	Level-2-260C-1 YEAR	-40 to 125	12ST	Samples
OPA197IDGKT	ACTIVE	VSSOP	DGK	8	250	RoHS & Green	NIPDAU	Level-2-260C-1 YEAR	-40 to 125	12ST	Samples
OPA197IDR	ACTIVE	SOIC	D	8	2500	RoHS & Green	NIPDAU	Level-2-260C-1 YEAR	-40 to 125	OPA197	Samples
OPA2197ID	ACTIVE	SOIC	D	8	75	RoHS & Green	NIPDAU	Level-2-260C-1 YEAR	-40 to 125	2197	Samples
OPA2197IDGKR	ACTIVE	VSSOP	DGK	8	2500	RoHS & Green	NIPDAU	Level-2-260C-1 YEAR	-40 to 125	4HV	Samples
OPA2197IDGKT	ACTIVE	VSSOP	DGK	8	250	RoHS & Green	NIPDAU	Level-2-260C-1 YEAR	-40 to 125	4HV	Samples
OPA2197IDR	ACTIVE	SOIC	D	8	2500	RoHS & Green	NIPDAU	Level-2-260C-1 YEAR	-40 to 125	2197	Samples
OPA4197ID	ACTIVE	SOIC	D	14	50	RoHS & Green	NIPDAU	Level-3-260C-168 HR	-40 to 125	OPA4197	Samples
OPA4197IDR	ACTIVE	SOIC	D	14	2500	RoHS & Green	NIPDAU	Level-3-260C-168 HR	-40 to 125	OPA4197	Samples
OPA4197IPW	ACTIVE	TSSOP	PW	14	90	RoHS & Green	SN	Level-3-260C-168 HR	-40 to 125	OPA4197	Samples
OPA4197IPWR	ACTIVE	TSSOP	PW	14	2000	RoHS & Green	SN	Level-3-260C-168 HR	-40 to 125	OPA4197	Samples

(1) The marketing status values are defined as follows:

ACTIVE: Product device recommended for new designs.

LIFEBUY: TI has announced that the device will be discontinued, and a lifetime-buy period is in effect.

NRND: Not recommended for new designs. Device is in production to support existing customers, but TI does not recommend using this part in a new design.

PREVIEW: Device has been announced but is not in production. Samples may or may not be available.

OBsolete: TI has discontinued the production of the device.

(2) **RoHS:** TI defines "RoHS" to mean semiconductor products that are compliant with the current EU RoHS requirements for all 10 RoHS substances, including the requirement that RoHS substance do not exceed 0.1% by weight in homogeneous materials. Where designed to be soldered at high temperatures, "RoHS" products are suitable for use in specified lead-free processes. TI may reference these types of products as "Pb-Free".

RoHS Exempt: TI defines "RoHS Exempt" to mean products that contain lead but are compliant with EU RoHS pursuant to a specific EU RoHS exemption.

Green: TI defines "Green" to mean the content of Chlorine (Cl) and Bromine (Br) based flame retardants meet JS709B low halogen requirements of ≤ 1000 ppm threshold. Antimony trioxide based flame retardants must also meet the ≤ 1000 ppm threshold requirement.

(3) MSL, Peak Temp. - The Moisture Sensitivity Level rating according to the JEDEC industry standard classifications, and peak solder temperature.

(4) There may be additional marking, which relates to the logo, the lot trace code information, or the environmental category on the device.

(5) Multiple Device Markings will be inside parentheses. Only one Device Marking contained in parentheses and separated by a "~" will appear on a device. If a line is indented then it is a continuation of the previous line and the two combined represent the entire Device Marking for that device.

(6) Lead finish/Ball material - Orderable Devices may have multiple material finish options. Finish options are separated by a vertical ruled line. Lead finish/Ball material values may wrap to two lines if the finish value exceeds the maximum column width.

Important Information and Disclaimer: The information provided on this page represents TI's knowledge and belief as of the date that it is provided. TI bases its knowledge and belief on information provided by third parties, and makes no representation or warranty as to the accuracy of such information. Efforts are underway to better integrate information from third parties. TI has taken and continues to take reasonable steps to provide representative and accurate information but may not have conducted destructive testing or chemical analysis on incoming materials and chemicals. TI and TI suppliers consider certain information to be proprietary, and thus CAS numbers and other limited information may not be available for release.

In no event shall TI's liability arising out of such information exceed the total purchase price of the TI part(s) at issue in this document sold by TI to Customer on an annual basis.

TAPE AND REEL INFORMATION

QUADRANT ASSIGNMENTS FOR PIN 1 ORIENTATION IN TAPE

*All dimensions are nominal

Device	Package Type	Package Drawing	Pins	SPQ	Reel Diameter (mm)	Reel Width W1 (mm)	A0 (mm)	B0 (mm)	K0 (mm)	P1 (mm)	W (mm)	Pin1 Quadrant
OPA197IDBVR	SOT-23	DBV	5	3000	180.0	8.4	3.23	3.17	1.37	4.0	8.0	Q3
OPA197IDBVT	SOT-23	DBV	5	250	180.0	8.4	3.23	3.17	1.37	4.0	8.0	Q3
OPA197IDGKR	VSSOP	DGK	8	2500	330.0	12.4	5.3	3.4	1.4	8.0	12.0	Q1
OPA197IDGKT	VSSOP	DGK	8	250	177.8	12.4	5.3	3.4	1.4	8.0	12.0	Q1
OPA197IDR	SOIC	D	8	2500	330.0	12.4	6.4	5.2	2.1	8.0	12.0	Q1
OPA2197IDGKR	VSSOP	DGK	8	2500	330.0	12.4	5.3	3.4	1.4	8.0	12.0	Q1
OPA2197IDGKT	VSSOP	DGK	8	250	177.8	12.4	5.3	3.4	1.4	8.0	12.0	Q1
OPA2197IDR	SOIC	D	8	2500	330.0	12.4	6.4	5.2	2.1	8.0	12.0	Q1
OPA4197IDR	SOIC	D	14	2500	330.0	16.4	6.5	9.0	2.1	8.0	16.0	Q1
OPA4197IPWR	TSSOP	PW	14	2000	330.0	12.4	6.9	5.6	1.6	8.0	12.0	Q1

TAPE AND REEL BOX DIMENSIONS

*All dimensions are nominal

Device	Package Type	Package Drawing	Pins	SPQ	Length (mm)	Width (mm)	Height (mm)
OPA197IDBVR	SOT-23	DBV	5	3000	223.0	270.0	35.0
OPA197IDBVT	SOT-23	DBV	5	250	223.0	270.0	35.0
OPA197IDGKR	VSSOP	DGK	8	2500	346.0	346.0	29.0
OPA197IDGKT	VSSOP	DGK	8	250	223.0	270.0	35.0
OPA197IDR	SOIC	D	8	2500	356.0	356.0	35.0
OPA2197IDGKR	VSSOP	DGK	8	2500	346.0	346.0	29.0
OPA2197IDGKT	VSSOP	DGK	8	250	223.0	270.0	35.0
OPA2197IDR	SOIC	D	8	2500	356.0	356.0	35.0
OPA4197IDR	SOIC	D	14	2500	356.0	356.0	35.0
OPA4197IPWR	TSSOP	PW	14	2000	356.0	356.0	35.0

TUBE

*All dimensions are nominal

Device	Package Name	Package Type	Pins	SPQ	L (mm)	W (mm)	T (μm)	B (mm)
OPA197ID	D	SOIC	8	75	506.6	8	3940	4.32
OPA2197ID	D	SOIC	8	75	506.6	8	3940	4.32
OPA4197ID	D	SOIC	14	50	506.6	8	3940	4.32
OPA4197IPW	PW	TSSOP	14	90	508	8.5	3250	2.8

DBV0005A



PACKAGE OUTLINE

SOT-23 - 1.45 mm max height

SMALL OUTLINE TRANSISTOR



4214839/J 02/2024

NOTES:

1. All linear dimensions are in millimeters. Any dimensions in parenthesis are for reference only. Dimensioning and tolerancing per ASME Y14.5M.
2. This drawing is subject to change without notice.
3. Reference JEDEC MO-178.
4. Body dimensions do not include mold flash, protrusions, or gate burrs. Mold flash, protrusions, or gate burrs shall not exceed 0.25 mm per side.
5. Support pin may differ or may not be present.

EXAMPLE BOARD LAYOUT

DBV0005A

SOT-23 - 1.45 mm max height

SMALL OUTLINE TRANSISTOR



LAND PATTERN EXAMPLE
EXPOSED METAL SHOWN
SCALE:15X



SOLDER MASK DETAILS

4214839/J 02/2024

NOTES: (continued)

- 6. Publication IPC-7351 may have alternate designs.
- 7. Solder mask tolerances between and around signal pads can vary based on board fabrication site.

EXAMPLE STENCIL DESIGN

DBV0005A

SOT-23 - 1.45 mm max height

SMALL OUTLINE TRANSISTOR



SOLDER PASTE EXAMPLE
BASED ON 0.125 mm THICK STENCIL
SCALE:15X

4214839/J 02/2024

NOTES: (continued)

8. Laser cutting apertures with trapezoidal walls and rounded corners may offer better paste release. IPC-7525 may have alternate design recommendations.
9. Board assembly site may have different recommendations for stencil design.

D (R-PDSO-G14)

PLASTIC SMALL OUTLINE



- NOTES:
- A. All linear dimensions are in inches (millimeters).
 - B. This drawing is subject to change without notice.
 -  Body length does not include mold flash, protrusions, or gate burrs. Mold flash, protrusions, or gate burrs shall not exceed 0.006 (0,15) each side.
 -  Body width does not include interlead flash. Interlead flash shall not exceed 0.017 (0,43) each side.
 - E. Reference JEDEC MS-012 variation AB.

D (R-PDSO-G14)

PLASTIC SMALL OUTLINE



- NOTES:
- A. All linear dimensions are in millimeters.
 - B. This drawing is subject to change without notice.
 - C. Publication IPC-7351 is recommended for alternate designs.
 - D. Laser cutting apertures with trapezoidal walls and also rounding corners will offer better paste release. Customers should contact their board assembly site for stencil design recommendations. Refer to IPC-7525 for other stencil recommendations.
 - E. Customers should contact their board fabrication site for solder mask tolerances between and around signal pads.

PW (R-PDSO-G14)

PLASTIC SMALL OUTLINE



4040064-3/G 02/11

- NOTES:
- A. All linear dimensions are in millimeters. Dimensioning and tolerancing per ASME Y14.5M-1994.
 - B. This drawing is subject to change without notice.
 - C. Body length does not include mold flash, protrusions, or gate burrs. Mold flash, protrusions, or gate burrs shall not exceed 0,15 each side.
 - D. Body width does not include interlead flash. Interlead flash shall not exceed 0,25 each side.
 - E. Falls within JEDEC MO-153



D0008A

PACKAGE OUTLINE

SOIC - 1.75 mm max height

SMALL OUTLINE INTEGRATED CIRCUIT



4214825/C 02/2019

NOTES:

- Linear dimensions are in inches [millimeters]. Dimensions in parenthesis are for reference only. Controlling dimensions are in inches. Dimensioning and tolerancing per ASME Y14.5M.
- This drawing is subject to change without notice.
- This dimension does not include mold flash, protrusions, or gate burrs. Mold flash, protrusions, or gate burrs shall not exceed $.006$ [0.15] per side.
- This dimension does not include interlead flash.
- Reference JEDEC registration MS-012, variation AA.

EXAMPLE BOARD LAYOUT

D0008A

SOIC - 1.75 mm max height

SMALL OUTLINE INTEGRATED CIRCUIT



LAND PATTERN EXAMPLE
 EXPOSED METAL SHOWN
 SCALE:8X



SOLDER MASK DETAILS

4214825/C 02/2019

NOTES: (continued)

- 6. Publication IPC-7351 may have alternate designs.
- 7. Solder mask tolerances between and around signal pads can vary based on board fabrication site.

EXAMPLE STENCIL DESIGN

D0008A

SOIC - 1.75 mm max height

SMALL OUTLINE INTEGRATED CIRCUIT



SOLDER PASTE EXAMPLE
BASED ON .005 INCH [0.125 MM] THICK STENCIL
SCALE:8X

4214825/C 02/2019

NOTES: (continued)

8. Laser cutting apertures with trapezoidal walls and rounded corners may offer better paste release. IPC-7525 may have alternate design recommendations.
9. Board assembly site may have different recommendations for stencil design.

DGK (S-PDSO-G8)

PLASTIC SMALL-OUTLINE PACKAGE



- NOTES:
- A. All linear dimensions are in millimeters.
 - B. This drawing is subject to change without notice.
 - C. Body length does not include mold flash, protrusions, or gate burrs. Mold flash, protrusions, or gate burrs shall not exceed 0.15 per end.
 - D. Body width does not include interlead flash. Interlead flash shall not exceed 0.50 per side.
 - E. Falls within JEDEC MO-187 variation AA, except interlead flash.



- NOTES:
- A. All linear dimensions are in millimeters.
 - B. This drawing is subject to change without notice.
 - C. Publication IPC-7351 is recommended for alternate designs.
 - D. Laser cutting apertures with trapezoidal walls and also rounding corners will offer better paste release. Customers should contact their board assembly site for stencil design recommendations. Refer to IPC-7525 for other stencil recommendations.
 - E. Customers should contact their board fabrication site for solder mask tolerances between and around signal pads.

重要声明和免责声明

TI“按原样”提供技术和可靠性数据（包括数据表）、设计资源（包括参考设计）、应用或其他设计建议、网络工具、安全信息和其他资源，不保证没有瑕疵且不做任何明示或暗示的担保，包括但不限于对适销性、某特定用途方面的适用性或不侵犯任何第三方知识产权的暗示担保。

这些资源可供使用 TI 产品进行设计的熟练开发人员使用。您将自行承担以下全部责任：(1) 针对您的应用选择合适的 TI 产品，(2) 设计、验证并测试您的应用，(3) 确保您的应用满足相应标准以及任何其他功能安全、信息安全、监管或其他要求。

这些资源如有变更，恕不另行通知。TI 授权您仅可将这些资源用于研发本资源所述的 TI 产品的应用。严禁对这些资源进行其他复制或展示。您无权使用任何其他 TI 知识产权或任何第三方知识产权。您应全额赔偿因在这些资源的使用中对 TI 及其代表造成的任何索赔、损害、成本、损失和债务，TI 对此概不负责。

TI 提供的产品受 [TI 的销售条款](#) 或 [ti.com](#) 上其他适用条款/TI 产品随附的其他适用条款的约束。TI 提供这些资源并不会扩展或以其他方式更改 TI 针对 TI 产品发布的适用的担保或担保免责声明。

TI 反对并拒绝您可能提出的任何其他或不同的条款。

邮寄地址：Texas Instruments, Post Office Box 655303, Dallas, Texas 75265
Copyright © 2024，德州仪器 (TI) 公司