

LPV7215 Micropower, CMOS Input, RRIO, 1.8-V, Push-Pull Output Comparator

1 Features

- (For $V^+ = 1.8\text{ V}$, Typical Unless Otherwise Noted)
- Ultra-Low Power Consumption: 580 nA
- Wide Supply Voltage Range: 1.8 V to 5.5 V
- Propagation Delay: 4.5 μs
- Push-Pull Output Current Drive at 5 V 19 mA
- Temperature Range: -40°C to 125°C
- Rail-to-Rail Input
- Tiny 5-Pin SOT-23 and SC70 Packages

2 Applications

- RC Timers
- Window Detectors
- IR Receivers
- Multivibrators
- Alarm and Monitoring Circuits

3 Description

The LPV7215 device is an ultra-low-power comparator with a typical power supply current of 580 nA. It has the best-in-class power supply current versus propagation delay performance available among TI's low-power comparators. The propagation delay is as low as 4.5 μs with 100-mV overdrive at 1.8-V supply.

Designed to operate over a wide range of supply voltages, from 1.8 V to 5.5 V, with ensured operation at 1.8 V, 2.7 V, and 5 V, the LPV7215 is ideal for use in a variety of battery-powered applications. With rail-to-rail common-mode voltage range, the LPV7215 is well suited for single-supply operation.

Featuring a push-pull output stage, the LPV7215 allows for operation with absolute minimum power consumption when driving any capacitive or resistive load.

Available in a choice of space-saving packages, the LPV7215 is ideal for use in handheld electronics and mobile phone applications. The LPV7215 is manufactured with TI's advanced VIP50 process.

Device Information⁽¹⁾

PART NUMBER	PACKAGE	BODY SIZE (NOM)
LPV7215	SOT-23 (5)	2.90 mm x 1.60 mm
	SC70 (5)	2.00 mm x 1.25 mm

(1) For all available packages, see the orderable addendum at the end of the data sheet.

Supply Current vs Supply Voltage

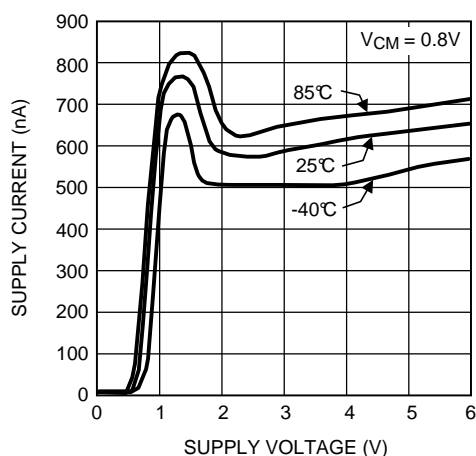

Propagation Delay vs Overdrive

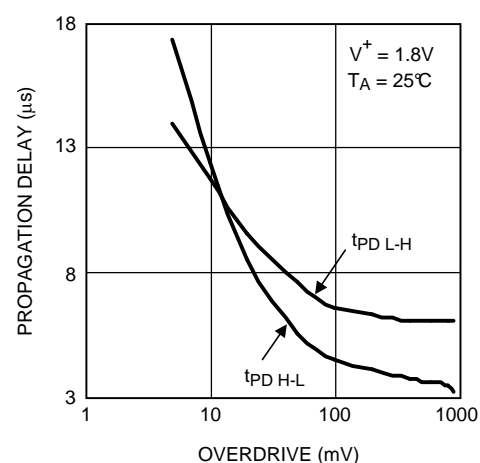

Table of Contents

1 Features	1	7.3 Feature Description	14
2 Applications	1	7.4 Device Functional Modes	16
3 Description	1	8 Application and Implementation	20
4 Revision History	2	8.1 Application Information	20
5 Pin Configuration and Functions	3	8.2 Typical Applications	20
6 Specifications	3	9 Power Supply Recommendations	24
6.1 Absolute Maximum Ratings	3	10 Layout	24
6.2 ESD Ratings	3	10.1 Layout Guidelines	24
6.3 Recommended Operating Conditions	4	10.2 Layout Example	24
6.4 Thermal Information	4	11 Device and Documentation Support	25
6.5 Electrical Characteristics: 1.8 V	4	11.1 Device Support	25
6.6 Electrical Characteristics: 2.7 V	6	11.2 Receiving Notification of Documentation Updates	25
6.7 Electrical Characteristics: 5 V	7	11.3 Community Resources	25
6.8 Typical Characteristics	9	11.4 Trademarks	25
7 Detailed Description	14	11.5 Electrostatic Discharge Caution	25
7.1 Overview	14	11.6 Glossary	25
7.2 Functional Block Diagram	14	12 Mechanical, Packaging, and Orderable Information	25

4 Revision History

NOTE: Page numbers for previous revisions may differ from page numbers in the current version.

Changes from Revision I (April 2013) to Revision J	Page
• Added <i>ESD Ratings</i> table, <i>Feature Description</i> section, <i>Device Functional Modes</i> , <i>Application and Implementation</i> section, <i>Power Supply Recommendations</i> section, <i>Layout</i> section, <i>Device and Documentation Support</i> section, and <i>Mechanical, Packaging, and Orderable Information</i> section	1
• Updated values in the <i>Thermal Information</i> table to align with JEDEC standards.	4

Changes from Revision H (April 2013) to Revision I	Page
• Changed layout of National Data Sheet to TI format	22

5 Pin Configuration and Functions

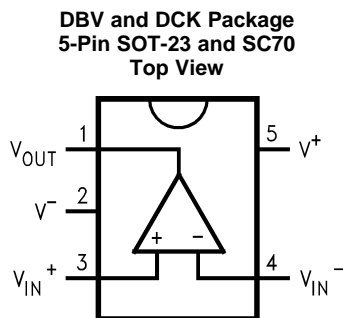

Pin Functions

PIN		I/O	DESCRIPTION
NO.	NAME		
1	V _{OUT}	O	Output
2	V ⁻	P	Negative Supply
3	V _{IN+}	I	Noninverting Input
4	V _{IN-}	I	Inverting Input
5	V ⁺	P	Positive Supply

6 Specifications

6.1 Absolute Maximum Ratings

over operating free-air temperature range (unless otherwise noted)⁽¹⁾

	MIN	MAX	UNIT
V _{IN} differential	-2.5	2.5	V
Supply voltage (V ⁺ - V ⁻)		6	V
Voltage at input and output pins	V ⁻ - 0.3	V ⁺ + 0.3	V
Junction temperature, T _J ⁽²⁾		150	°C
Storage temperature, T _{stg}	-65	150	°C

- (1) Stresses beyond those listed under *Absolute Maximum Ratings* may cause permanent damage to the device. These are stress ratings only, which do not imply functional operation of the device at these or any other conditions beyond those indicated under *Recommended Operating Conditions*. Exposure to absolute-maximum-rated conditions for extended periods may affect device reliability.
- (2) The maximum power dissipation is a function of T_{J(MAX)}, θ_{JA}. The maximum allowable power dissipation at any ambient temperature is P_D = (T_{J(MAX)} - T_A) / θ_{JA}. All numbers apply for packages soldered directly onto a PCB.

6.2 ESD Ratings

		VALUE	UNIT
V _(ESD) Electrostatic discharge	Human-body model (HBM) ⁽¹⁾	±2000	V
	Machine model (MM) ⁽²⁾	±200	

- (1) Human-body model, applicable std. MIL-STD-883, Method 3015.7.
- (2) Machine model, applicable std. JESD22-A115-A (ESD MM std. of JEDEC) Field-Induced Charge-Device Model, applicable std. JESD22-C101-C (ESD FICDM std. of JEDEC).

6.3 Recommended Operating Conditions

over operating free-air temperature range (unless otherwise noted)

	MIN	MAX	UNIT
Temperature ⁽¹⁾	-40	125	°C
Supply voltage (V ⁺ – V ⁻)	1.8	5.5	V

(1) The maximum power dissipation is a function of T_{J(MAX)}, θ_{JA}. The maximum allowable power dissipation at any ambient temperature is P_D = (T_{J(MAX)} – T_A) / θ_{JA}. All numbers apply for packages soldered directly onto a PCB.

6.4 Thermal Information

THERMAL METRIC ⁽¹⁾	LPV7215		UNIT
	DBV (SOT-23)	DCK (SC70)	
	5 PINS	5 PINS	
R _{θJA} Junction-to-ambient thermal resistance ⁽²⁾	234	456	°C/W
R _{θJC(top)} Junction-to-case (top) thermal resistance	153	110.8	°C/W
R _{θJB} Junction-to-board thermal resistance	51.7	59.8	°C/W
ψ _{JT} Junction-to-top characterization parameter	38	3.6	°C/W
ψ _{JB} Junction-to-board characterization parameter	51.2	59	°C/W
R _{θJC(bot)} Junction-to-case (bottom) thermal resistance	n/a	n/a	°C/W

- (1) For more information about traditional and new thermal metrics, see the [Semiconductor and IC Package Thermal Metrics](#) application report.
- (2) The maximum power dissipation is a function of T_{J(MAX)}, θ_{JA}. The maximum allowable power dissipation at any ambient temperature is P_D = (T_{J(MAX)} – T_A) / θ_{JA}. All numbers apply for packages soldered directly onto a PCB.

6.5 Electrical Characteristics: 1.8 V

Unless otherwise specified, all limits are specified for T_A = 25°C, V⁺ = 1.8V, V⁻ = 0 V, and V_{CM} = V⁺/2, V_O = V⁻.⁽¹⁾

PARAMETER	TEST CONDITIONS	MIN ⁽²⁾	TYP ⁽³⁾	MAX ⁽²⁾	UNIT
I _S Supply current	V _{CM} = 0.3 V	T _A = 25°C	580	750	nA
		Temperature extremes		1050	
	V _{CM} = 1.5 V	T _A = 25°C	790	980	
		Temperature extremes		1300	
V _{OS} Input offset voltage	V _{CM} = 0 V	T _A = 25°C	±0.3	±6	mV
		Temperature extremes		±8	
	V _{CM} = 1.8 V	T _A = 25°C	±0.4	±5	
		Temperature extremes		±7	
TCV _{OS} Input offset average drift	See ⁽⁴⁾		±1		µV/C
I _B Input bias current ⁽⁵⁾	V _{CM} = 1.6 V		-40		fA
I _{OS} Input offset current			10		fA

- (1) Electrical table values apply only for factory testing conditions at the temperature indicated. Factory testing conditions result in very limited self-heating of the device.
- (2) Limits are 100% production tested at 25°C. Limits over the operating temperature range are specified through correlations using statistical quality control (SQC) method.
- (3) Typical values represent the most likely parametric norm as determined at the time of characterization. Actual typical values may vary over time and also depend on the application and configuration. The typical values are not tested and are not specified on shipped production material.
- (4) Offset voltage average drift determined by dividing the change in V_{OS} at temperature extremes into the total temperature change.
- (5) Positive current corresponds to current flowing into the device.

Electrical Characteristics: 1.8 V (continued)

Unless otherwise specified, all limits are specified for $T_A = 25^\circ\text{C}$, $V^+ = 1.8\text{V}$, $V^- = 0\text{V}$, and $V_{\text{CM}} = V^+/2$, $V_O = V^-$.⁽¹⁾

PARAMETER		TEST CONDITIONS		MIN ⁽²⁾	TYP ⁽³⁾	MAX ⁽²⁾	UNIT
CMRR	Common-mode rejection ratio	V_{CM} Stepped from 0 V to 0.7 V	$T_A = 25^\circ\text{C}$	66	88		dB
			Temperature extremes	62			
		V_{CM} Stepped from 1.2 V to 1.8 V	$T_A = 25^\circ\text{C}$	68	87		
			Temperature extremes	62			
PSRR	Power supply rejection ratio	$V^+ = 1.8\text{V}$ to 5.5 V, $V_{\text{CM}} = 0\text{V}$	$T_A = 25^\circ\text{C}$	66	82		dB
			Temperature extremes	63			
CMVR	Input common-mode voltage range	CMRR $\geq 40\text{ dB}$	Temperature Extremes	-0.1		1.9	V
A_V	Voltage gain				120		dB
V_O	Output swing high	$I_O = 500\ \mu\text{A}$	$T_A = 25^\circ\text{C}$	1.63	1.69		V
			Temperature extremes	1.58			
		$I_O = 1\text{ mA}$	$T_A = 25^\circ\text{C}$	1.46	1.6		
			Temperature extremes	1.37			
	Output swing low	$I_O = -500\ \mu\text{A}$	$T_A = 25^\circ\text{C}$		88	180	mV
			Temperature extremes			230	
$I_O = -1\text{ mA}$		$T_A = 25^\circ\text{C}$		180	310		
		Temperature extremes			400		
I_{OUT}	Output current	Source $V_O = V^+/2$	$T_A = 25^\circ\text{C}$	1.75	2.26		mA
			Temperature extremes	1.3			
		Sink $V_O = V^+/2$	$T_A = 25^\circ\text{C}$	2.35	3.1		
			Temperature extremes	1.45			
Propagation delay (high to low)		Overdrive = 10 mV			13		μs
		Overdrive = 100 mV	$T_A = 25^\circ\text{C}$		4.5	6.5	
			Temperature extremes			9	
Propagation delay (low to high)		Overdrive = 10 mV			12.5		μs
		Overdrive = 100 mV	$T_A = 25^\circ\text{C}$		6.6	9	
			Temperature extremes			12	
t_{rise}	Rise time	Overdrive = 10 mV $C_L = 30\text{ pF}$, $R_L = 1\text{ M}\Omega$			80		ns
		Overdrive = 100 mV $C_L = 30\text{ pF}$, $R_L = 1\text{ M}\Omega$			75		
t_{fall}	Fall time	Overdrive = 10 mV $C_L = 30\text{ pF}$, $R_L = 1\text{ M}\Omega$			70		ns
		Overdrive = 100 mV $C_L = 30\text{ pF}$, $R_L = 1\text{ M}\Omega$			65		

6.6 Electrical Characteristics: 2.7 V

Unless otherwise specified, all limits are specified for $T_A = 25^\circ\text{C}$, $V^+ = 2.7\text{ V}$, $V^- = 0\text{ V}$, and $V_{CM} = V^+/2$, $V_O = V^-$.⁽¹⁾

PARAMETER		TEST CONDITIONS		MIN ⁽²⁾	TYP ⁽³⁾	MAX ⁽²⁾	UNIT
I_S	Supply current	$V_{CM} = 0.3\text{ V}$	$T_A = 25^\circ\text{C}$	605	780	nA	
			Temperature extremes	1100			
		$V_{CM} = 2.4\text{ V}$	$T_A = 25^\circ\text{C}$	815	1010		
			Temperature extremes	1350			
V_{OS}	Input offset voltage	$V_{CM} = 0\text{ V}$	$T_A = 25^\circ\text{C}$	± 0.3	± 6	mV	
			Temperature extremes	± 8			
		$V_{CM} = 2.7\text{ V}$	$T_A = 25^\circ\text{C}$	± 0.3	± 5		
			Temperature extremes	± 7			
TCV_{OS}	Input offset average drift	See ⁽⁴⁾		± 1		$\mu\text{V}/\text{C}$	
I_B	Input bias current ⁽⁵⁾	$V_{CM} = 1.8\text{ V}$		-40		fA	
I_{OS}	Input offset current			20		fA	
CMRR	Common-mode rejection ratio	V_{CM} Stepped from 0 V to 1.6 V	$T_A = 25^\circ\text{C}$	72	90	dB	
			Temperature extremes	66			
		V_{CM} Stepped from 2.1V to 2.7V	$T_A = 25^\circ\text{C}$	71	94		
			Temperature extremes	63			
		V_{CM} Stepped from 0 V to 2.7 V	$T_A = 25^\circ\text{C}$	47	80		
			Temperature extremes	46			
PSRR	Power supply rejection ratio	$V^+ = 1.8\text{ V to } 5.5\text{ V}$, $V_{CM} = 0\text{ V}$	$T_A = 25^\circ\text{C}$	66	82	dB	
			Temperature extremes	63			
CMVR	Input common-mode voltage range	CMRR $\geq 40\text{ dB}$	Temperature extremes	-0.1	2.8	V	
A_V	Voltage gain			120		dB	
V_O	Output swing high	$I_O = 500\ \mu\text{A}$	$T_A = 25^\circ\text{C}$	2.57	2.62	V	
			Temperature extremes	2.53			
		$I_O = 1\text{ mA}$	$T_A = 25^\circ\text{C}$	2.47	2.53		
			Temperature extremes	2.4			
	Output swing low	$I_O = -500\ \mu\text{A}$	$T_A = 25^\circ\text{C}$	60	130	mV	
			Temperature extremes	190			
		$I_O = -1\text{ mA}$	$T_A = 25^\circ\text{C}$	120	250		
			Temperature extremes	330			

- (1) Electrical table values apply only for factory testing conditions at the temperature indicated. Factory testing conditions result in very limited self-heating of the device.
- (2) Limits are 100% production tested at 25°C . Limits over the operating temperature range are specified through correlations using statistical quality control (SQC) method.
- (3) Typical values represent the most likely parametric norm as determined at the time of characterization. Actual typical values may vary over time and also depend on the application and configuration. The typical values are not tested and are not specified on shipped production material.
- (4) Offset voltage average drift determined by dividing the change in V_{OS} at temperature extremes into the total temperature change.
- (5) Positive current corresponds to current flowing into the device.

Electrical Characteristics: 2.7 V (continued)

Unless otherwise specified, all limits are specified for $T_A = 25^\circ\text{C}$, $V^+ = 2.7\text{ V}$, $V^- = 0\text{ V}$, and $V_{CM} = V^+/2$, $V_O = V^-$.⁽¹⁾

PARAMETER		TEST CONDITIONS		MIN ⁽²⁾	TYP ⁽³⁾	MAX ⁽²⁾	UNIT
I_{OUT}	Output current	Source $V_O = V^+/2$	$T_A = 25^\circ\text{C}$	4.5	5.7		mA
			Temperature extremes	3.4			
		Sink $V_O = V^+/2$	$T_A = 25^\circ\text{C}$	5.6	7.5		
			Temperature extremes	3.2			
	Propagation delay (high to low)	Overdrive = 10 mV			14.5		μs
		Overdrive = 100 mV	$T_A = 25^\circ\text{C}$		5.8	8.5	
			Temperature extremes			10.5	
		Overdrive = 100 mV	$T_A = 25^\circ\text{C}$		15		
Temperature extremes			7.5	10			
	Propagation delay (low to high)	Overdrive = 10 mV			15		μs
		Overdrive = 100 mV	$T_A = 25^\circ\text{C}$		7.5	10	
			Temperature extremes			12.5	
		Overdrive = 100 mV	$T_A = 25^\circ\text{C}$		90		
Temperature extremes			85				
t_{rise}	Rise time	Overdrive = 10 mV $C_L = 30\text{ pF}$, $R_L = 1\text{ M}\Omega$			90		ns
		Overdrive = 100 mV $C_L = 30\text{ pF}$, $R_L = 1\text{ M}\Omega$			85		
t_{fall}	Fall time	Overdrive = 10 mV $C_L = 30\text{ pF}$, $R_L = 1\text{ M}\Omega$			85		ns
		Overdrive = 100 mV $C_L = 30\text{ pF}$, $R_L = 1\text{ M}\Omega$			75		

6.7 Electrical Characteristics: 5 V

Unless otherwise specified, all limits are specified for $T_A = 25^\circ\text{C}$, $V^+ = 5\text{ V}$, $V^- = 0\text{ V}$, and $V_{CM} = V^+/2$, $V_O = V^-$.⁽¹⁾

PARAMETER		TEST CONDITIONS		MIN ⁽²⁾	TYP ⁽³⁾	MAX ⁽²⁾	UNIT
I_S	Supply current	$V_{CM} = 0.3\text{ V}$	$T_A = 25^\circ\text{C}$		612	790	nA
			Temperature extremes			1150	
		$V_{CM} = 4.7\text{ V}$	$T_A = 25^\circ\text{C}$		825	1030	
			Temperature extremes			1400	
V_{OS}	Input offset voltage	$V_{CM} = 0\text{ V}$	$T_A = 25^\circ\text{C}$		± 0.3	± 6	mV
			Temperature extremes			± 8	
		$V_{CM} = 5\text{ V}$	$T_A = 25^\circ\text{C}$			± 5	
			Temperature extremes			± 7	
TCV_{OS}	Input offset average drift	See ⁽⁴⁾			± 1		$\mu\text{V}/\text{C}$
I_B	Input bias current ⁽⁵⁾	$V_{CM} = 4.5\text{ V}$			-400		fA
I_{OS}	Input offset current				20		fA

- (1) Electrical table values apply only for factory testing conditions at the temperature indicated. Factory testing conditions result in very limited self-heating of the device.
- (2) Limits are 100% production tested at 25°C . Limits over the operating temperature range are specified through correlations using statistical quality control (SQC) method.
- (3) Typical values represent the most likely parametric norm as determined at the time of characterization. Actual typical values may vary over time and also depend on the application and configuration. The typical values are not tested and are not specified on shipped production material.
- (4) Offset voltage average drift determined by dividing the change in V_{OS} at temperature extremes into the total temperature change.
- (5) Positive current corresponds to current flowing into the device.

Electrical Characteristics: 5 V (continued)

 Unless otherwise specified, all limits are specified for $T_A = 25^\circ\text{C}$, $V^+ = 5\text{ V}$, $V^- = 0\text{ V}$, and $V_{CM} = V^+/2$, $V_O = V^-$. ⁽¹⁾

PARAMETER		TEST CONDITIONS		MIN ⁽²⁾	TYP ⁽³⁾	MAX ⁽²⁾	UNIT
CMRR	Common-mode rejection ratio	V_{CM} Stepped from 0 V to 3.9 V	$T_A = 25^\circ\text{C}$	72	98		dB
			Temperature extremes	66			
		V_{CM} Stepped from 4.4 V to 5 V	$T_A = 25^\circ\text{C}$	73	92		
			Temperature extremes	67			
PSRR	Power supply rejection ratio	$V^+ = 1.8\text{ V}$ to 5.5 V, $V_{CM} = 0\text{ V}$	$T_A = 25^\circ\text{C}$	66	82		dB
			Temperature extremes	63			
CMVR	Input common-mode voltage range	CMRR $\geq 40\text{ dB}$	Temperature extremes	-0.1		5.1	V
A_V	Voltage gain				120		dB
V_O	Output swing high	$I_O = 500\ \mu\text{A}$	$T_A = 25^\circ\text{C}$	4.9	4.94		V
			Temperature extremes	4.86			
		$I_O = 1\text{ mA}$	$T_A = 25^\circ\text{C}$	4.82	4.89		
			Temperature extremes	4.77			
	Output swing low	$I_O = -500\ \mu\text{A}$	$T_A = 25^\circ\text{C}$		43	90	mV
			Temperature extremes			130	
$I_O = -1\text{ mA}$		$T_A = 25^\circ\text{C}$		88	170		
		Temperature extremes			230		
I_{OUT}	Output current	Source $V_O = V^+/2$	$T_A = 25^\circ\text{C}$	13	17		mA
			Temperature extremes	7.5			
		Sink $V_O = V^+/2$	$T_A = 25^\circ\text{C}$	14.5	19		
			Temperature extremes	8.5			
Propagation delay (high to low)		Overdrive = 10 mV			18		μs
		Overdrive = 100 mV	$T_A = 25^\circ\text{C}$		7.7	13.5	
			Temperature extremes			16	
Propagation delay (low to high)		Overdrive = 10 mV			30		μs
		Overdrive = 100 mV	$T_A = 25^\circ\text{C}$		12	15	
			Temperature extremes			20	
t_{rise}	Rise time	Overdrive = 10 mV $C_L = 30\text{ pF}$, $R_L = 1\text{ M}\Omega$			100		ns
		Overdrive = 100 mV $C_L = 30\text{ pF}$, $R_L = 1\text{ M}\Omega$			100		
t_{fall}	Fall time	Overdrive = 10 mV $C_L = 30\text{ pF}$, $R_L = 1\text{ M}\Omega$			115		ns
		Overdrive = 100 mV $C_L = 30\text{ pF}$, $R_L = 1\text{ M}\Omega$			95		

6.8 Typical Characteristics

At $T_j = 25^\circ\text{C}$ unless otherwise specified.

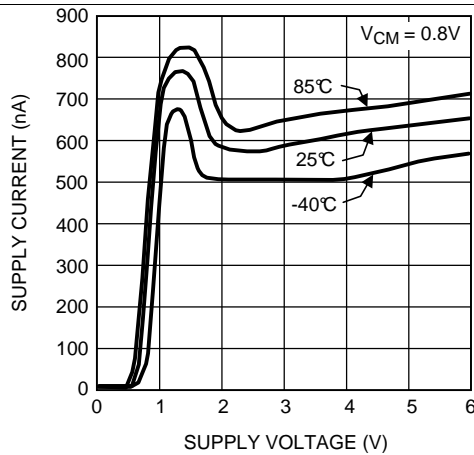

Figure 1. Supply Current vs Supply Voltage

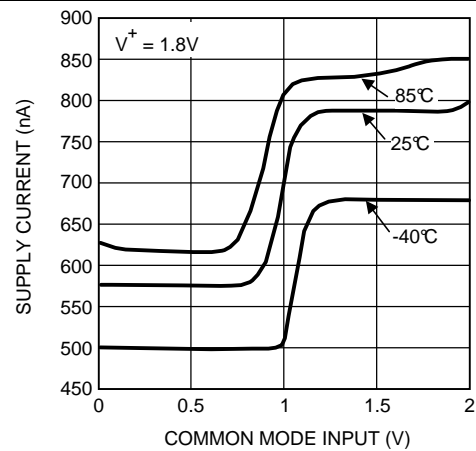

Figure 2. Supply Current vs Common-Mode Input

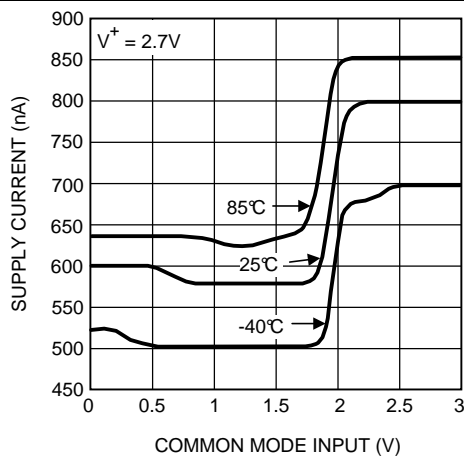

Figure 3. Supply Current vs Common-Mode Input

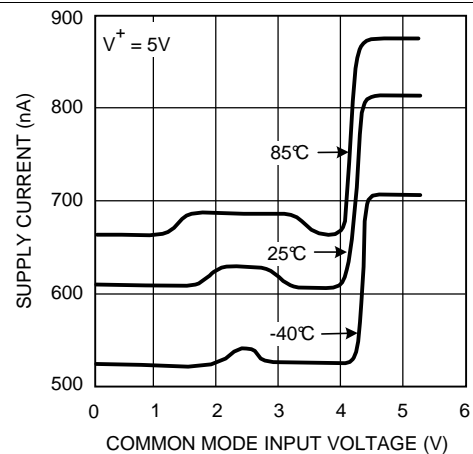

Figure 4. Supply Current vs Common-Mode Input

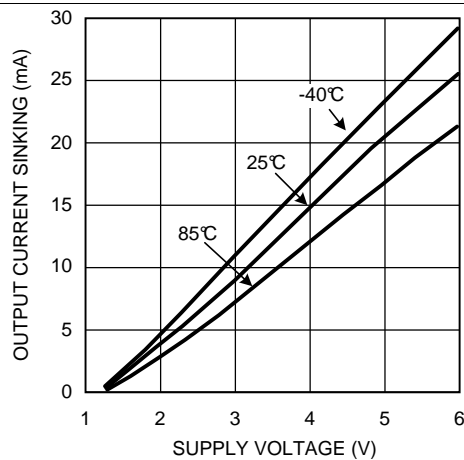

Figure 5. Short-Circuit Sinking Current vs Supply Voltage

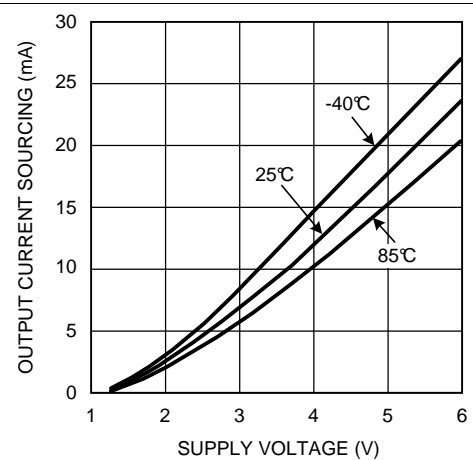

Figure 6. Short-Circuit Sourcing Current vs Supply Voltage

Typical Characteristics (continued)

At $T_J = 25^\circ\text{C}$ unless otherwise specified.

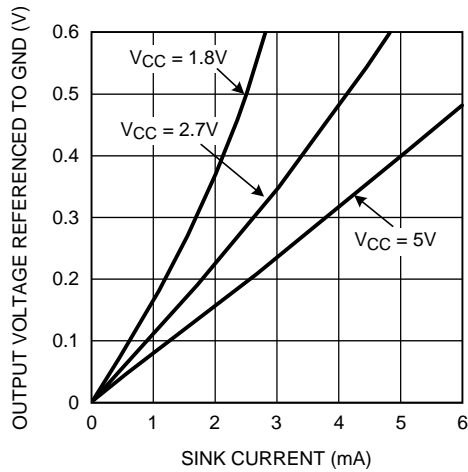

Figure 7. Output Voltage Low vs Sink Current

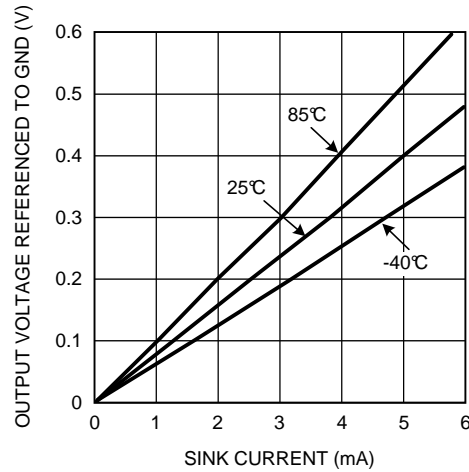

Figure 8. Output Voltage Low vs Sink Current

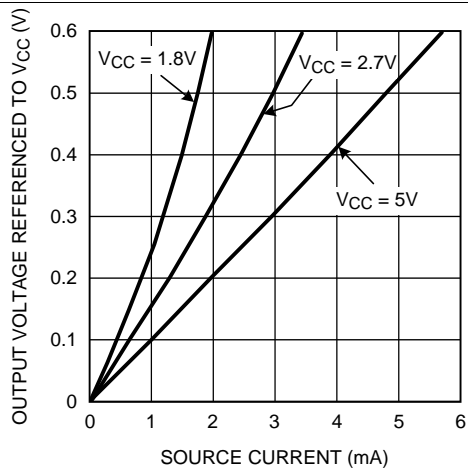

Figure 9. Output Voltage High vs Source Current

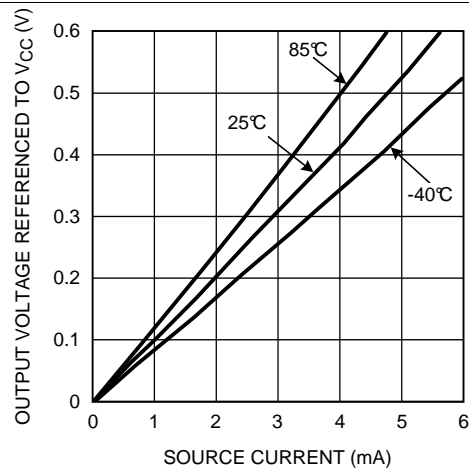

Figure 10. Output Voltage High vs Source Current

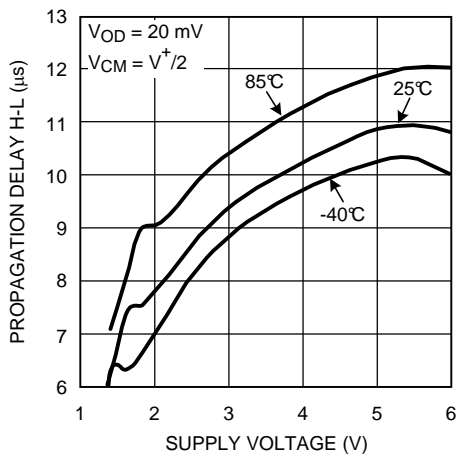

Figure 11. Propagation Delay vs Supply Voltage

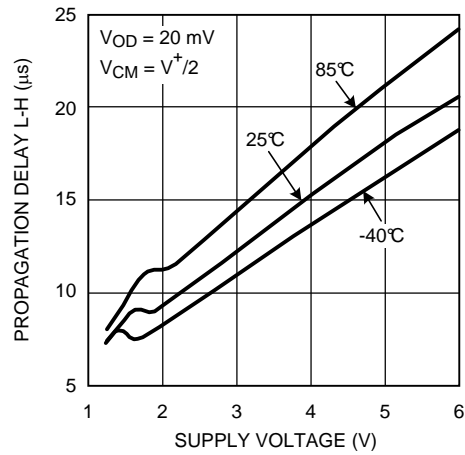
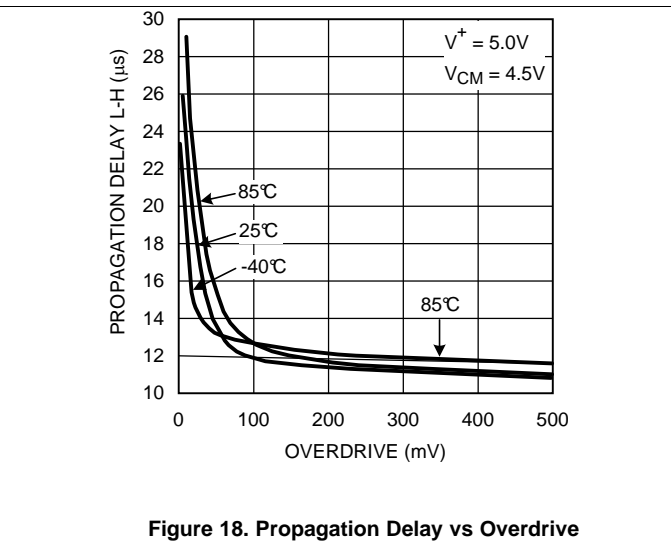
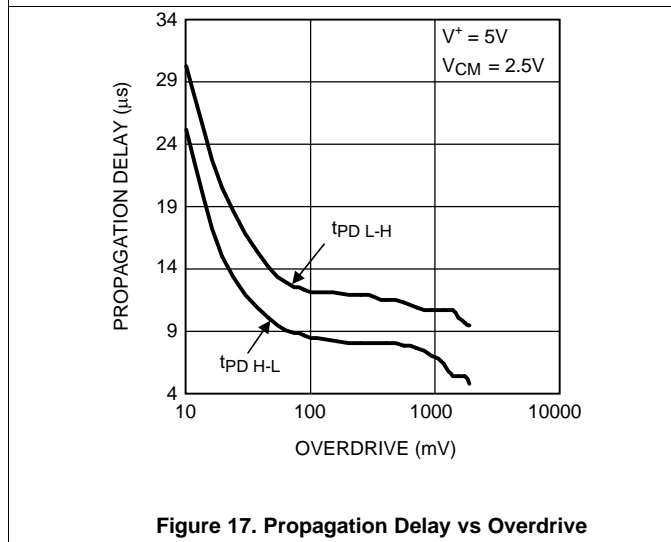
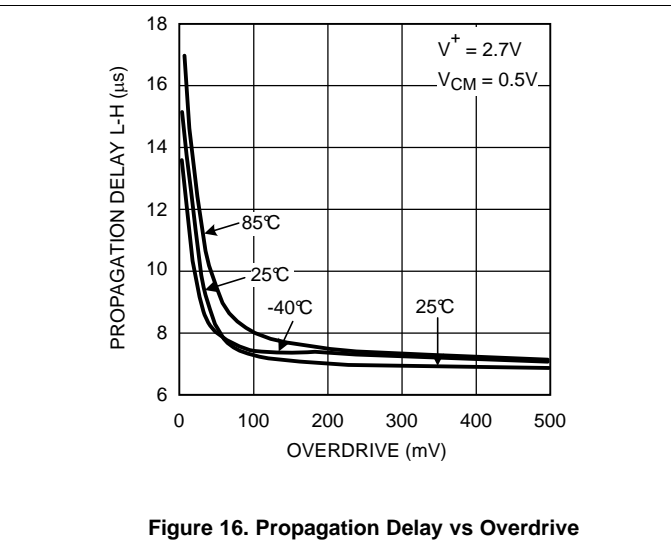
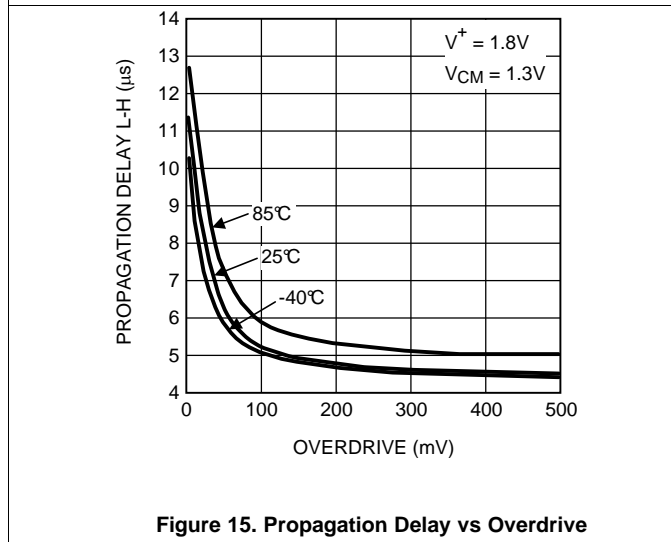
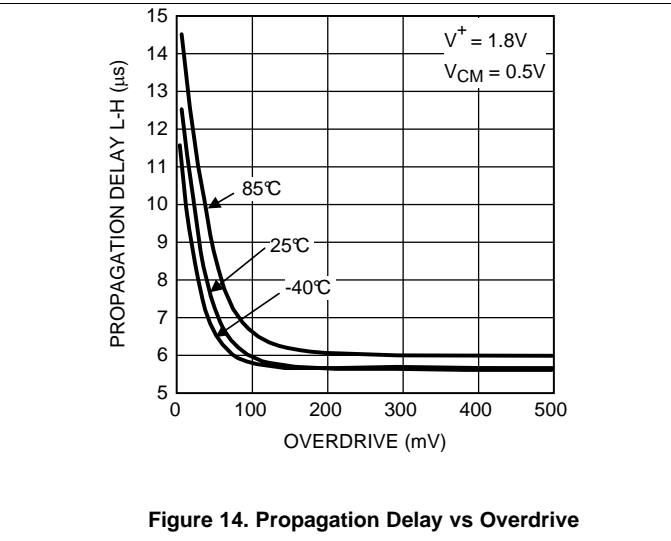
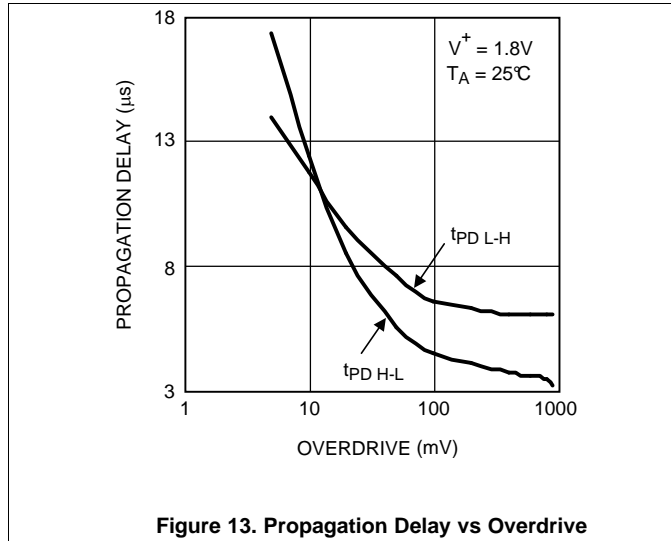

Figure 12. Propagation Delay vs Supply Voltage

Typical Characteristics (continued)

At $T_J = 25^\circ\text{C}$ unless otherwise specified.



Typical Characteristics (continued)

At $T_J = 25^\circ\text{C}$ unless otherwise specified.

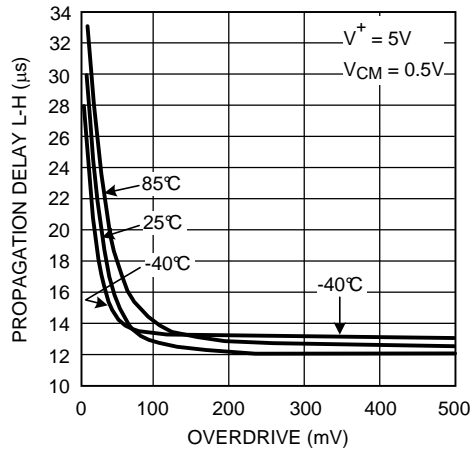

Figure 19. Propagation Delay vs Overdrive

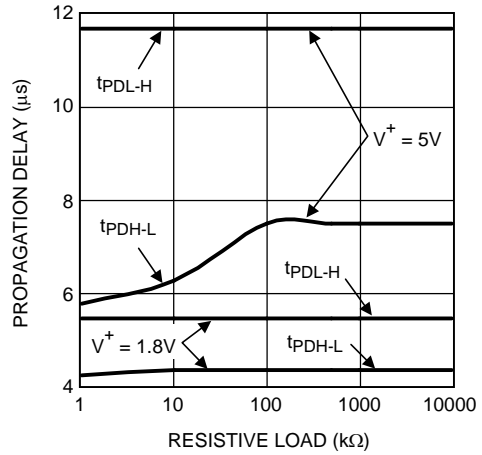

Figure 20. Propagation Delay vs Resistive Load

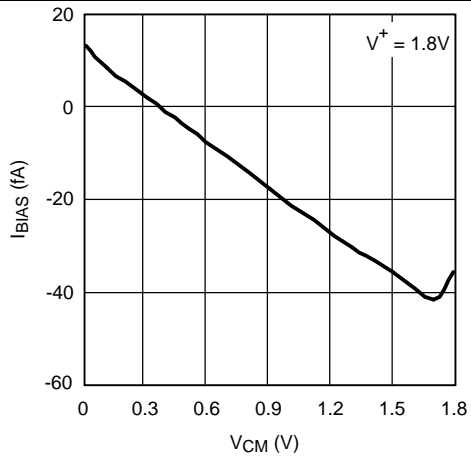

Figure 21. I_{BIAS} vs V_{CM}

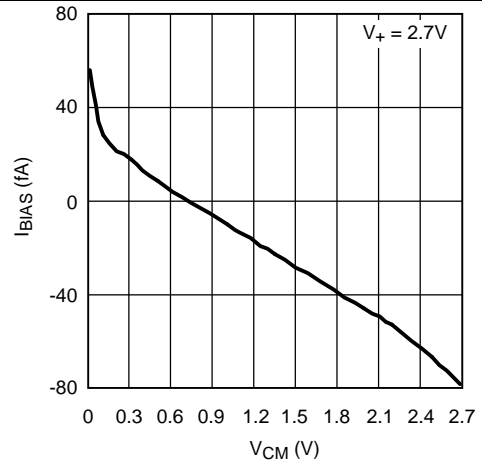

Figure 22. I_{BIAS} vs V_{CM}

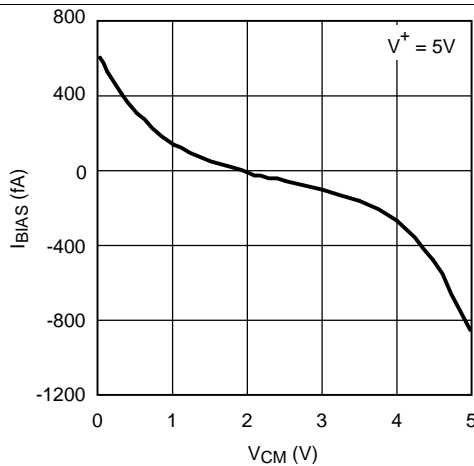

Figure 23. I_{BIAS} vs V_{CM}

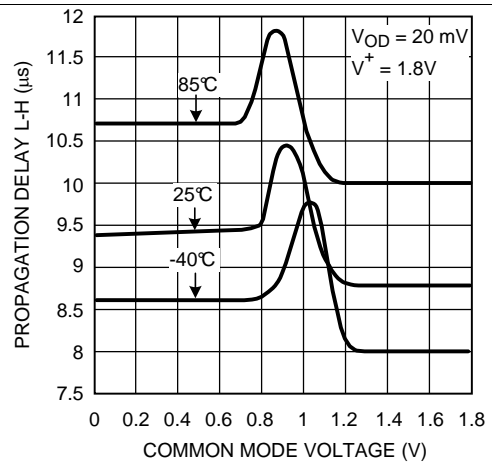

Figure 24. Propagation Delay vs Common-Mode Input

Typical Characteristics (continued)

At $T_J = 25^\circ\text{C}$ unless otherwise specified.

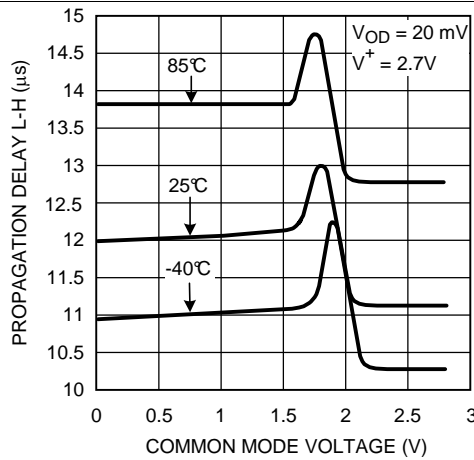

Figure 25. Propagation Delay vs Common-Mode Input

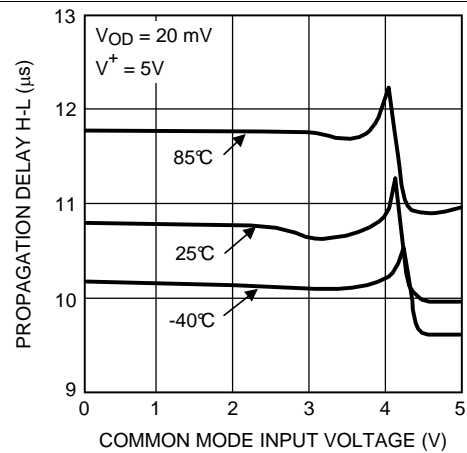

Figure 26. Propagation Delay vs Common-Mode Input

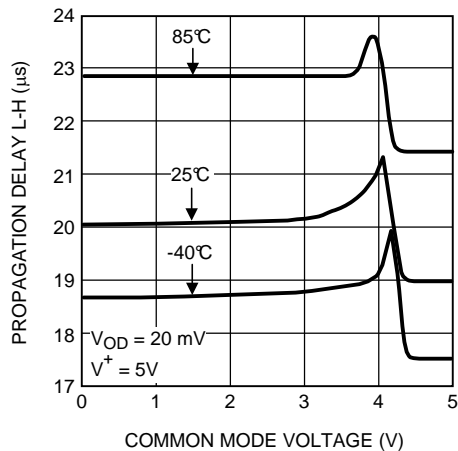

Figure 27. Propagation Delay vs Common-Mode Input

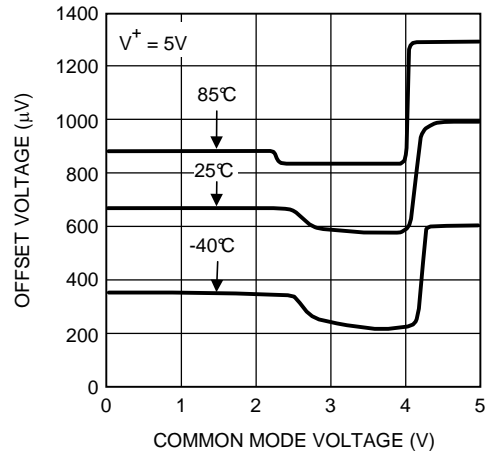

Figure 28. Offset Voltage vs Common-Mode Input

7 Detailed Description

7.1 Overview

The LPV7215 is a single-channel comparator with a push-pull output stage. This comparator is optimized for low-power consumption and single-supply operation with greater than rail-to-rail input operation. The push-pull output of the LPV7215 supports rail-to-rail output swing and interfaces with TTL/CMOS logic.

7.2 Functional Block Diagram

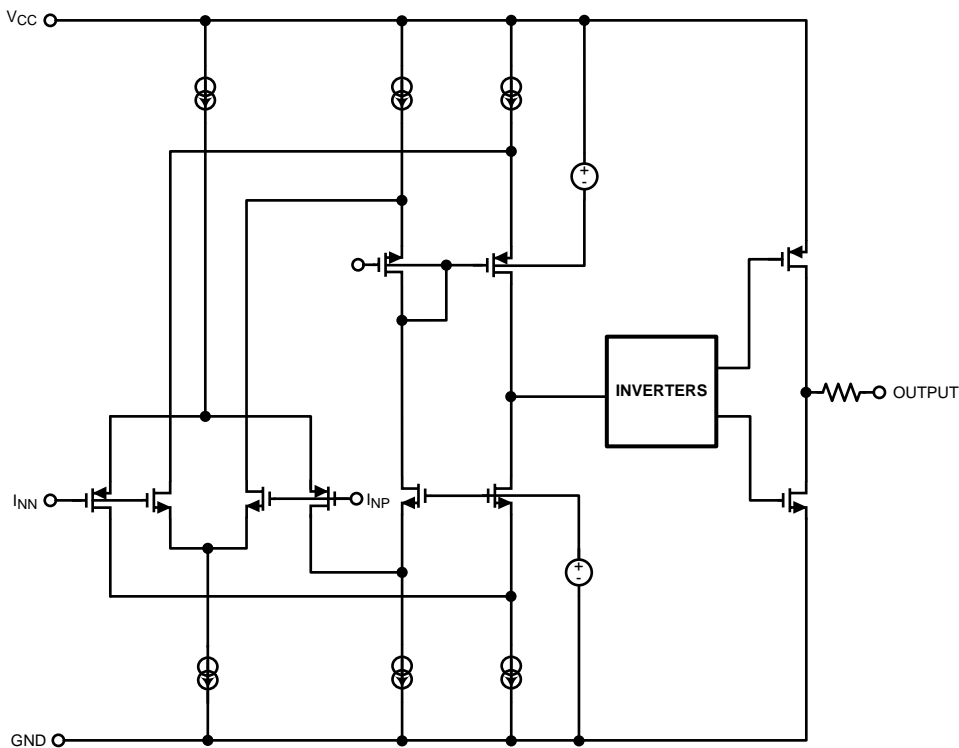

Copyright © 2016, Texas Instruments Incorporated

7.3 Feature Description

Low supply current and fast propagation delay distinguish the LPV7215 from other low-power comparators.

7.3.1 Input Stage

The LPV7215 has rail-to-rail input common-mode voltage range. It can operate at any differential input voltage within this limit as long as the differential voltage is greater than zero. A differential input of zero volts may result in oscillation.

The differential input stage of the comparator is a pair of PMOS and NMOS transistors, therefore, no current flows into the device. The input bias current measured is the leakage current in the MOS transistors and input protection diodes. This low bias current allows the comparator to interface with a variety of circuitry and devices with minimal concern about matching the input resistances.

The input to the comparator is protected from excessive voltage by internal ESD diodes connected to both supply rails. This protects the circuit from both ESD events, as well as signals that significantly exceed the supply voltages. When this occurs the ESD protection diodes become forward-biased and draw current into these structures, resulting in no input current to the terminals of the comparator. Until this occurs, there is essentially no input current to the diodes. As a result, placing a large resistor in series with an input that may be exposed to large voltages, limits the input current but have no other noticeable effect.

Feature Description (continued)

7.3.2 Output Stage

The LPV7215 has a MOS push-pull rail-to-rail output stage. The push-pull transistor configuration of the output keeps the total system power consumption to a minimum. The only current consumed by the LPV7215 is the less than 1- μ A supply current and the current going directly into the load. No power is wasted through the pullup resistor when the output is low. The output stage is specifically designed with dead time between the time when one transistor is turned off and the other is turned on (break-before-make) to minimize shoot through currents. The internal logic controls the break-before-make timing of the output transistors. The break-before-make delay varies with temperature and power condition.

7.3.3 Output Current

Even though the LPV7215 uses less than 1- μ A supply current, the outputs are able to drive very large currents. The LPV7215 can source up to 17 mA and can sink up to 19 mA, when operated at 5-V supply. This large current handling capability allows driving heavy loads directly.

7.3.4 Response Time

Depending upon the amount of overdrive, the propagation delay is typically 6 to 30 μ s. The curves showing propagation delay vs overdrive in the [Typical Characteristics](#) section shows the delay time when the input is preset with 100 mV across the inputs and then is driven the other way by 10 mV to 500 mV.

The output signal can show a step during switching depending on the load. A fast RC time constant due to both small capacitive and resistive loads shows a significant step in the output signal. A slow RC time constant due to either a large resistive or capacitive load has a clipped corner on the output signal. The step is observed more prominently during a falling transition from high to low.

The plot in [Figure 29](#) shows the output for single 5-V supply with a 100-k Ω resistor. The step is at 1.3 V.

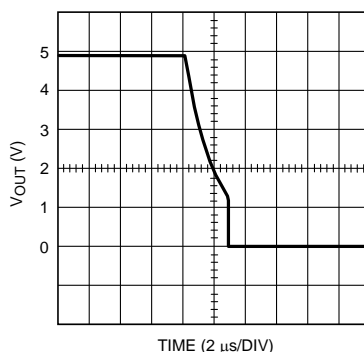

Figure 29. Output Signal Without Capacitive Load

The plot in [Figure 30](#) shows the output signal when a 20-pF capacitor is added as a load. The step is at about 2.5 V.

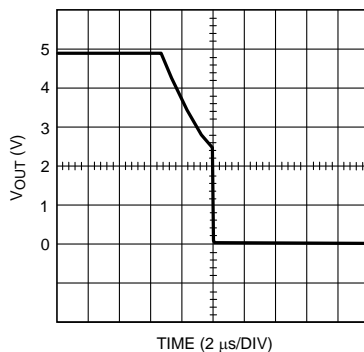

Figure 30. Output Signal With 20-pF Load

7.4 Device Functional Modes

7.4.1 Capacitive and Resistive Loads

The propagation delay is not affected by capacitive loads at the output of the LPV7215. However, resistive loads slightly affect the propagation delay on the falling edge by a reduction of almost 2 μs depending on the load resistance value.

7.4.2 Noise

Most comparators have rather low gain. This allows the output to spend time between high and low when the input signal changes slowly. The result is that the output may oscillate between high and low when the differential input is near zero. The exceptionally high gain of this comparator, 120 dB, eliminates this problem. Less than 1 μV of change on the input drives the output from one rail to the other rail. If the input signal is noisy, the output cannot ignore the noise unless some hysteresis is provided by positive feedback (see [Hysteresis](#)).

7.4.3 Hysteresis

To improve propagation delay when low overdrive is needed, hysteresis can be added.

7.4.4 Inverting Comparator With Hysteresis

The inverting comparator with hysteresis requires a three resistor network that is referenced to the supply voltage V^+ of the comparator as shown in [Figure 31](#). When V_{IN} at the inverting input is less than V_A , the voltage at the noninverting node of the comparator ($V_{\text{IN}} < V_A$), the output voltage is high (for simplicity assume V_O switches as high as V^+). The three network resistors can be represented as $R_1//R_3$ in series with R_2 .

The lower input trip voltage V_{A1} is defined as [Equation 1](#).

$$V_{A1} = V_{\text{CC}}R_2 / ((R_1//R_3) + R_2) \quad (1)$$

When V_{IN} is greater than V_A , the output voltage is low or very close to ground. In this case the three network resistors can be presented as $R_2//R_3$ in series with R_1 .

The upper trip voltage V_{A2} is defined as [Equation 2](#).

$$V_{A2} = V_{\text{CC}} (R_2//R_3) / (R_1 + (R_2//R_3)) \quad (2)$$

The total hysteresis provided by the network is defined as $\Delta V_A = V_{A1} - V_{A2}$, as shown in [Equation 3](#).

$$\Delta V_A = \frac{+V_{\text{CC}}R_1R_2}{R_1R_2 + R_1R_3 + R_2R_3} \quad (3)$$

Device Functional Modes (continued)

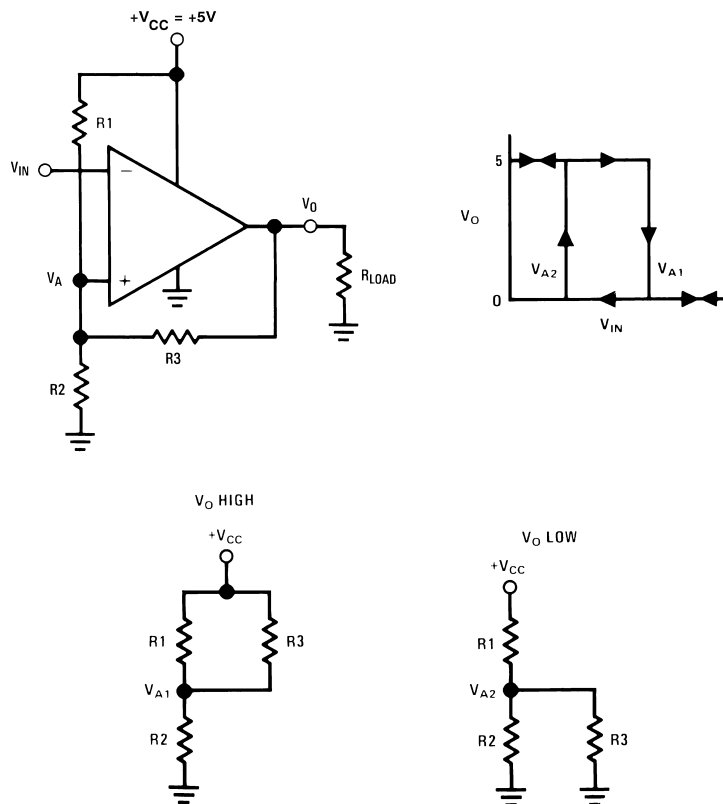

Figure 31. Inverting Comparator With Hysteresis

7.4.5 Noninverting Comparator With Hysteresis

A noninverting comparator with hysteresis requires a two resistor network, and a voltage reference (V_{REF}) at the inverting input. When V_{IN} is low, the output is also low. For the output to switch from low to high, V_{IN} must rise up to V_{IN1} where V_{IN1} is calculated by Equation 4.

$$V_{IN1} = \frac{V_{REF}(R_1 + R_2)}{R_2} \tag{4}$$

As soon as V_O switches to V_{CC}, V_A steps to a value greater than V_{REF}, which is given by Equation 5.

$$V_A = V_{IN} + \frac{(V_{CC} - V_{IN1})R_1}{R_1 + R_2} \tag{5}$$

To make the comparator switch back to its low state, V_{IN} must equal V_{REF} before V_A again equals V_{REF}. V_{IN2} can be calculated by Equation 6.

$$V_{IN2} = \frac{V_{REF}(R_1 + R_2) - V_{CC} R_1}{R_2} \tag{6}$$

The hysteresis of this circuit is the difference between V_{IN1} and V_{IN2}, as shown in Equation 7.

$$\Delta V_{IN} = V_{CC}R_1/R_2 \tag{7}$$

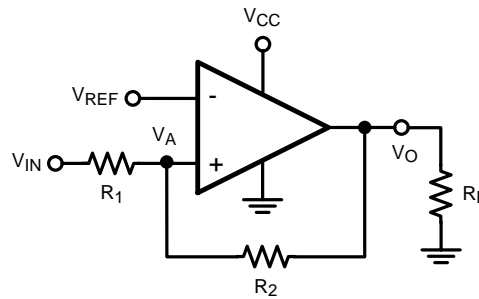
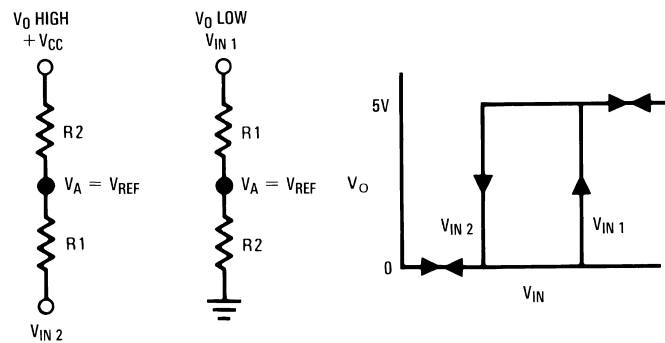
Device Functional Modes (continued)

Figure 32. Noninverting Comparator With Hysteresis

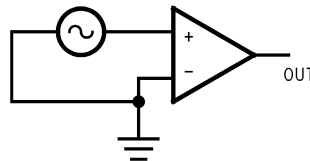
Figure 33. Noninverting Comparator With Hysteresis
7.4.6 Zero Crossing Detector

In a zero crossing detector circuit, the inverting input is connected to ground and the noninverting input is connected to a 100-mV_{PP} AC signal. As the signal at the noninverting input crosses 0 V, the comparator's output changes state.

Figure 34. Zero Crossing Detector

To improve switching times and to center the input threshold to ground a small amount of positive feedback is added to the circuit. The voltage divider, R_4 and R_5 , establishes a reference voltage, V_1 , at the positive input. By making the series resistance, R_1 plus R_2 equal to R_5 , the switching condition, $V_1 = V_2$, is satisfied when $V_{IN} = 0$. The positive feedback resistor, R_6 , is made very large with respect to R_5 ($R_6 = 2000 R_5$). The resultant hysteresis established by this network is very small ($\Delta V_1 < 10$ mV) but it is sufficient to insure rapid output voltage transitions. Diode D_1 is used to insure that the inverting input terminal of the comparator never goes below approximately -100 mV. As the input terminal goes negative, D_1 will forward bias, clamping the node between R_1 and R_2 to approximately -700 mV. This sets up a voltage divider with R_2 and R_3 preventing V_2 from going below ground. The maximum negative input overdrive is limited by the current handling ability of D_1 .

Device Functional Modes (continued)

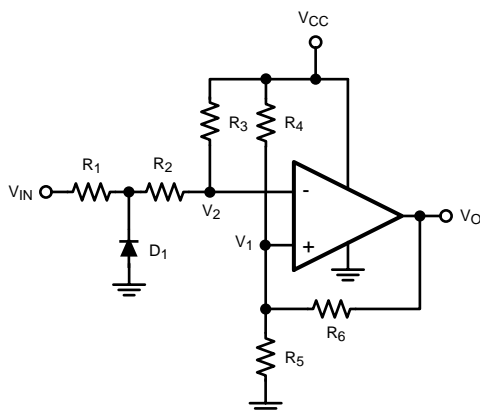

Figure 35. Zero Crossing Detector With Positive Feedback

7.4.7 Threshold Detector

Instead of tying the inverting input to 0 V, the inverting input can be tied to a reference voltage. As the input on the noninverting input passes the V_{REF} threshold, the comparator's output changes state. It is important to use a stable reference voltage to ensure a consistent switching point.

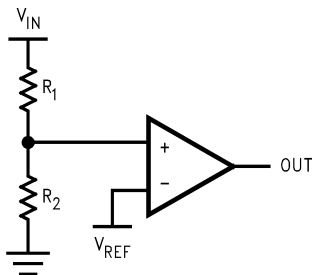

Figure 36. Threshold Detector

8 Application and Implementation

NOTE

Information in the following applications sections is not part of the TI component specification, and TI does not warrant its accuracy or completeness. TI's customers are responsible for determining suitability of components for their purposes. Customers should validate and test their design implementation to confirm system functionality.

8.1 Application Information

The LPV7215 is an ultra-low-power comparator with a typical power supply current of 580 nA. It has the best-in-class power supply current versus propagation delay performance available among TI's low-power comparators. The propagation delay is as low as 4.5 μ s with 100-mV overdrive at 1.8-V supply.

8.2 Typical Applications

8.2.1 Square Wave Generator

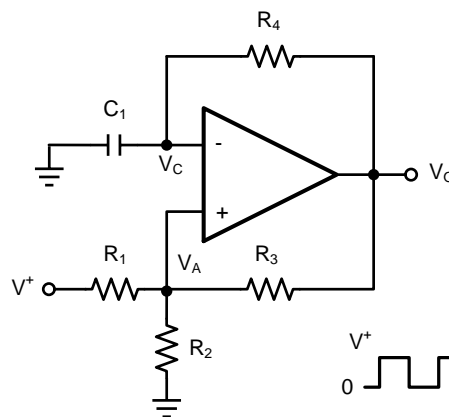

Copyright © 2016, Texas Instruments Incorporated

Figure 37. Square Wave Generator Schematic

8.2.1.1 Design Requirements

A typical application for a comparator is as a square wave oscillator. The circuit in [Figure 38](#) generates a square wave whose period is set by the RC time constant of the capacitor C₁ and resistor R₄. The maximum frequency is limited by the large signal propagation delay of the comparator and by the capacitive loading at the output, which limits the output slew rate.

8.2.1.2 Detailed Design Procedure

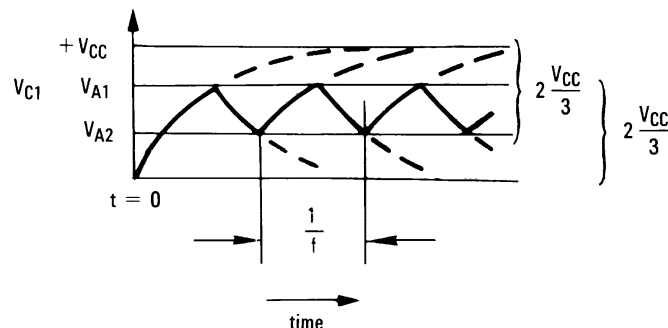

Figure 38. Square Wave Oscillator

Typical Applications (continued)

Consider the output of Figure 38 to be high to analyze the circuit. That implies that the inverted input (V_C) is lower than the noninverting input (V_A). This causes the C_1 to be charged through R_4 , and the voltage V_C increases until it is equal to the noninverting input. The value of V_A at this point is in Equation 8.

$$V_{A1} = \frac{V_{CC} \times R_2}{R_2 + R_1 \parallel R_3} \tag{8}$$

If $R_1 = R_2 = R_3$ then $V_{A1} = 2 V_{CC}/3$

At this point the comparator switches pulling down the output to the negative rail. The value of V_A at this point, as shown in Equation 9:

$$V_{A2} = \frac{V_{CC}(R_2 \parallel R_3)}{R_1 + (R_2 \parallel R_3)} \tag{9}$$

If $R_1 = R_2 = R_3$ then $V_{A2} = V_{CC}/3$

The capacitor C_1 now discharges through R_4 , and the voltage V_C decreases until it is equal to V_{A2} , at which point the comparator switches again, bringing it back to the initial stage. The time period is equal to twice the time it takes to discharge C_1 from $2 V_{CC}/3$ to $V_{CC}/3$, which is given by $R_4 C_1 \times \ln 2$. Hence the formula for the frequency is given by Equation 10:

$$F = 1/(2 \times R_4 \times C_1 \times \ln 2) \tag{10}$$

8.2.1.3 Application Curves

Figure 39 shows the simulated results of an oscillator using the following values:

1. $R_1 = R_2 = R_3 = R_4 = 100 \text{ k}\Omega$
2. $C_1 = 100 \text{ pF}$, $C_L = 20 \text{ pF}$
3. $V_+ = 5 \text{ V}$, $V_- = \text{GND}$
4. C_{STRAY} (not shown) from V_a to $\text{GND} = 10 \text{ pF}$

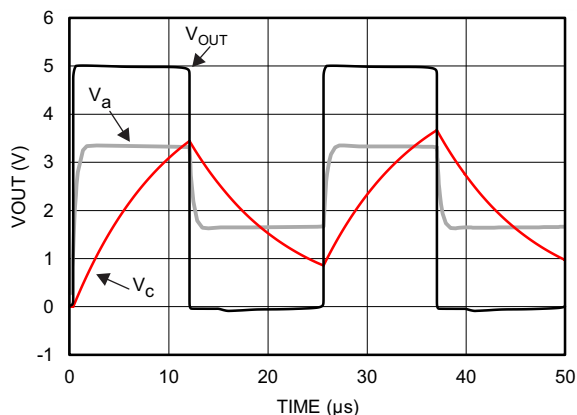

Figure 39. Square Wave Oscillator Output Waveform

Typical Applications (continued)

8.2.2 Window Detector

A window detector monitors the input signal to determine if it falls between two voltage levels.

The comparator outputs A and B are high only when $V_{REF1} < V_{IN} < V_{REF2}$ or *within the window*. These are defined as:

$$V_{REF1} = R_3 / (R_1 + R_2 + R_3) \times V^+ \tag{11}$$

$$V_{REF2} = (R_2 + R_3) / (R_1 + R_2 + R_3) \times V^+ \tag{12}$$

Others names for window detectors are: threshold detector, level detectors, and amplitude trigger or detector.

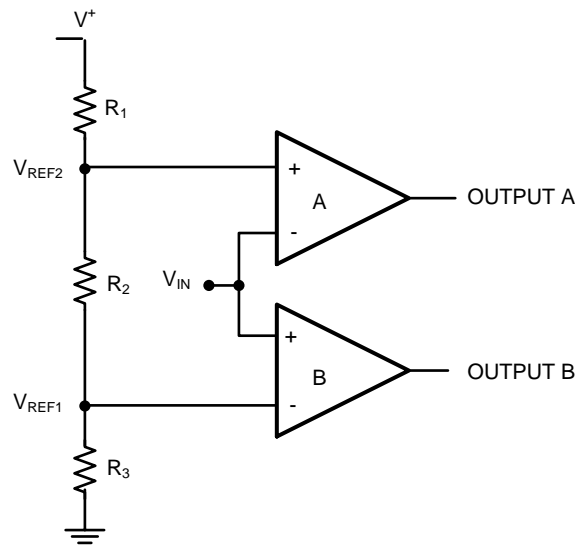

Copyright © 2016, Texas Instruments Incorporated

Figure 40. Window Detector

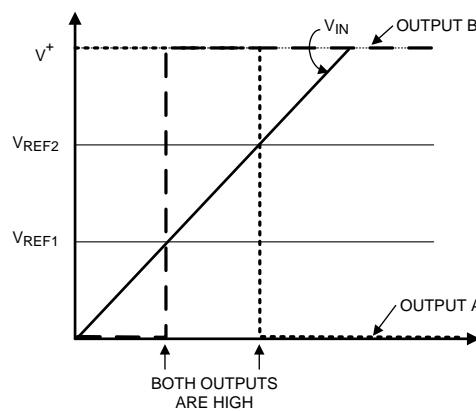
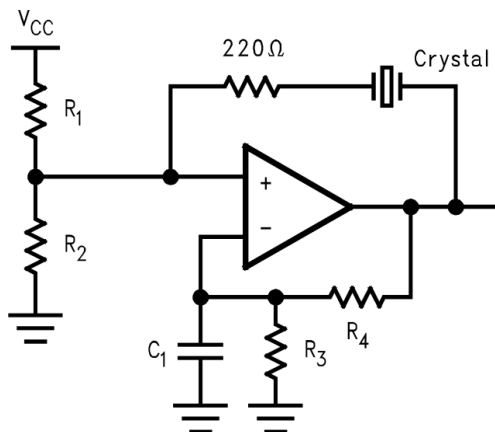

Figure 41. Window Detector Output Signal

Typical Applications (continued)

8.2.3 Crystal Oscillator

A simple crystal oscillator using the LPV7215 is shown in [Figure 42](#). Resistors R_1 and R_2 set the bias point at the comparator's noninverting input. Resistors, R_3 and R_4 and capacitor C_1 set the inverting input node at an appropriate DC average level based on the output. The crystal's path provides resonant positive feedback and stable oscillation occurs. The output duty cycle for this circuit is roughly 50%, but it is affected by resistor tolerances and to a lesser extent by the comparator offset.



Copyright © 2016, Texas Instruments Incorporated

Figure 42. Crystal Oscillator

8.2.4 IR Receiver

The LPV7215 can also be used as an infrared receiver. The infrared photo diode creates a current relative to the amount of infrared light present. The current creates a voltage across R_D . When this voltage level crosses the voltage applied by the voltage divider to the inverting input, the output transitions.

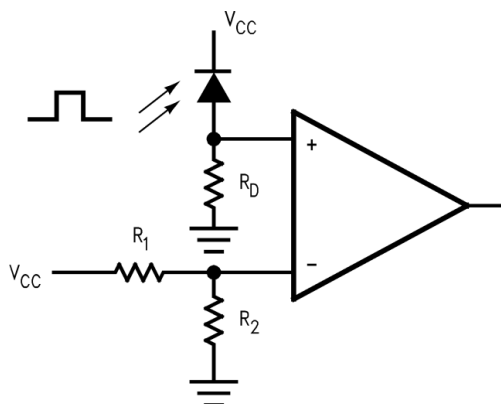

Copyright © 2016, Texas Instruments Incorporated

Figure 43. IR Receiver

9 Power Supply Recommendations

Comparators are very sensitive to input noise. To minimize supply noise, power supplies must be capacitively decoupled by a 0.01- μ F ceramic capacitor in parallel with a 10- μ F electrolytic capacitor.

10 Layout

10.1 Layout Guidelines

Proper grounding and the use of a ground plane help ensure the specified performance of the LPV7215. Minimizing trace lengths, reducing unwanted parasitic capacitance and using surface-mount components also helps.

10.2 Layout Example

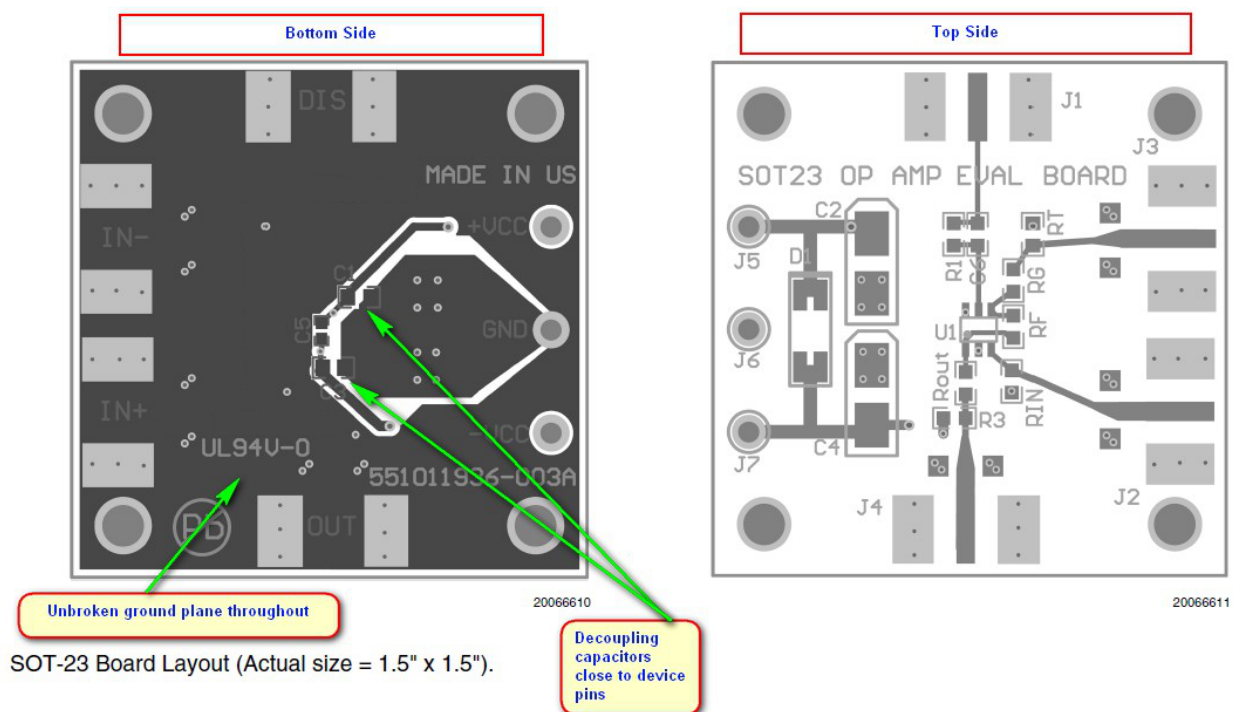

Figure 44. LPV7215 Layout Example

11 Device and Documentation Support

11.1 Device Support

11.1.1 Development Support

TINA-TI SPICE-Based Analog Simulation Program, <http://www.ti.com/tool/tina-ti>

DIP Adapter Evaluation Module, <http://www.ti.com/tool/dip-adapter-evm>

TI Universal Operational Amplifier Evaluation Module, <http://www.ti.com/tool/opampevm>

11.1.2 Documentation Support

11.1.2.1 Related Documentation

For related documentation, see the following

[AN-74 - A Quad of Independently Functioning Comparators](#) (SNOA654).

11.2 Receiving Notification of Documentation Updates

To receive notification of documentation updates, navigate to the device product folder on ti.com. In the upper right corner, click on *Alert me* to register and receive a weekly digest of any product information that has changed. For change details, review the revision history included in any revised document.

11.3 Community Resources

The following links connect to TI community resources. Linked contents are provided "AS IS" by the respective contributors. They do not constitute TI specifications and do not necessarily reflect TI's views; see TI's [Terms of Use](#).

TI E2E™ Online Community *TI's Engineer-to-Engineer (E2E) Community*. Created to foster collaboration among engineers. At e2e.ti.com, you can ask questions, share knowledge, explore ideas and help solve problems with fellow engineers.

Design Support *TI's Design Support* Quickly find helpful E2E forums along with design support tools and contact information for technical support.

11.4 Trademarks

E2E is a trademark of Texas Instruments.
All other trademarks are the property of their respective owners.

11.5 Electrostatic Discharge Caution



These devices have limited built-in ESD protection. The leads should be shorted together or the device placed in conductive foam during storage or handling to prevent electrostatic damage to the MOS gates.

11.6 Glossary

[SLYZ022](#) — *TI Glossary*.

This glossary lists and explains terms, acronyms, and definitions.

12 Mechanical, Packaging, and Orderable Information

The following pages include mechanical, packaging, and orderable information. This information is the most current data available for the designated devices. This data is subject to change without notice and revision of this document. For browser-based versions of this data sheet, refer to the left-hand navigation.

PACKAGING INFORMATION

Orderable Device	Status (1)	Package Type	Package Drawing	Pins	Package Qty	Eco Plan (2)	Lead finish/ Ball material (6)	MSL Peak Temp (3)	Op Temp (°C)	Device Marking (4/5)	Samples
LPV7215MF/NOPB	ACTIVE	SOT-23	DBV	5	1000	RoHS & Green	NIPDAU SN	Level-1-260C-UNLIM	-40 to 125	C30A	Samples
LPV7215MFX/NOPB	ACTIVE	SOT-23	DBV	5	3000	RoHS & Green	NIPDAU SN	Level-1-260C-UNLIM	-40 to 125	C30A	Samples
LPV7215MG/NOPB	ACTIVE	SC70	DCK	5	1000	RoHS & Green	SN	Level-1-260C-UNLIM	-40 to 125	C37	Samples
LPV7215MGX/NOPB	ACTIVE	SC70	DCK	5	3000	RoHS & Green	SN	Level-1-260C-UNLIM	-40 to 125	C37	Samples

(1) The marketing status values are defined as follows:

ACTIVE: Product device recommended for new designs.

LIFEBUY: TI has announced that the device will be discontinued, and a lifetime-buy period is in effect.

NRND: Not recommended for new designs. Device is in production to support existing customers, but TI does not recommend using this part in a new design.

PREVIEW: Device has been announced but is not in production. Samples may or may not be available.

OBSOLETE: TI has discontinued the production of the device.

(2) **RoHS:** TI defines "RoHS" to mean semiconductor products that are compliant with the current EU RoHS requirements for all 10 RoHS substances, including the requirement that RoHS substance do not exceed 0.1% by weight in homogeneous materials. Where designed to be soldered at high temperatures, "RoHS" products are suitable for use in specified lead-free processes. TI may reference these types of products as "Pb-Free".

RoHS Exempt: TI defines "RoHS Exempt" to mean products that contain lead but are compliant with EU RoHS pursuant to a specific EU RoHS exemption.

Green: TI defines "Green" to mean the content of Chlorine (Cl) and Bromine (Br) based flame retardants meet JS709B low halogen requirements of <=1000ppm threshold. Antimony trioxide based flame retardants must also meet the <=1000ppm threshold requirement.

(3) MSL, Peak Temp. - The Moisture Sensitivity Level rating according to the JEDEC industry standard classifications, and peak solder temperature.

(4) There may be additional marking, which relates to the logo, the lot trace code information, or the environmental category on the device.

(5) Multiple Device Markings will be inside parentheses. Only one Device Marking contained in parentheses and separated by a "-" will appear on a device. If a line is indented then it is a continuation of the previous line and the two combined represent the entire Device Marking for that device.

(6) Lead finish/Ball material - Orderable Devices may have multiple material finish options. Finish options are separated by a vertical ruled line. Lead finish/Ball material values may wrap to two lines if the finish value exceeds the maximum column width.

Important Information and Disclaimer:The information provided on this page represents TI's knowledge and belief as of the date that it is provided. TI bases its knowledge and belief on information provided by third parties, and makes no representation or warranty as to the accuracy of such information. Efforts are underway to better integrate information from third parties. TI has taken and

continues to take reasonable steps to provide representative and accurate information but may not have conducted destructive testing or chemical analysis on incoming materials and chemicals. TI and TI suppliers consider certain information to be proprietary, and thus CAS numbers and other limited information may not be available for release.

In no event shall TI's liability arising out of such information exceed the total purchase price of the TI part(s) at issue in this document sold by TI to Customer on an annual basis.

TAPE AND REEL INFORMATION

QUADRANT ASSIGNMENTS FOR PIN 1 ORIENTATION IN TAPE

*All dimensions are nominal

Device	Package Type	Package Drawing	Pins	SPQ	Reel Diameter (mm)	Reel Width W1 (mm)	A0 (mm)	B0 (mm)	K0 (mm)	P1 (mm)	W (mm)	Pin1 Quadrant
LPV7215MF/NOPB	SOT-23	DBV	5	1000	180.0	8.4	3.2	3.2	1.4	4.0	8.0	Q3
LPV7215MF/NOPB	SOT-23	DBV	5	1000	178.0	8.4	3.2	3.2	1.4	4.0	8.0	Q3
LPV7215MFX/NOPB	SOT-23	DBV	5	3000	180.0	8.4	3.2	3.2	1.4	4.0	8.0	Q3
LPV7215MFX/NOPB	SOT-23	DBV	5	3000	178.0	8.4	3.2	3.2	1.4	4.0	8.0	Q3
LPV7215MG/NOPB	SC70	DCK	5	1000	178.0	8.4	2.25	2.45	1.2	4.0	8.0	Q3
LPV7215MGX/NOPB	SC70	DCK	5	3000	178.0	8.4	2.25	2.45	1.2	4.0	8.0	Q3

TAPE AND REEL BOX DIMENSIONS

*All dimensions are nominal

Device	Package Type	Package Drawing	Pins	SPQ	Length (mm)	Width (mm)	Height (mm)
LPV7215MF/NOPB	SOT-23	DBV	5	1000	210.0	185.0	35.0
LPV7215MF/NOPB	SOT-23	DBV	5	1000	208.0	191.0	35.0
LPV7215MFX/NOPB	SOT-23	DBV	5	3000	210.0	185.0	35.0
LPV7215MFX/NOPB	SOT-23	DBV	5	3000	208.0	191.0	35.0
LPV7215MG/NOPB	SC70	DCK	5	1000	208.0	191.0	35.0
LPV7215MGX/NOPB	SC70	DCK	5	3000	208.0	191.0	35.0

EXAMPLE BOARD LAYOUT

DBV0005A

SOT-23 - 1.45 mm max height

SMALL OUTLINE TRANSISTOR

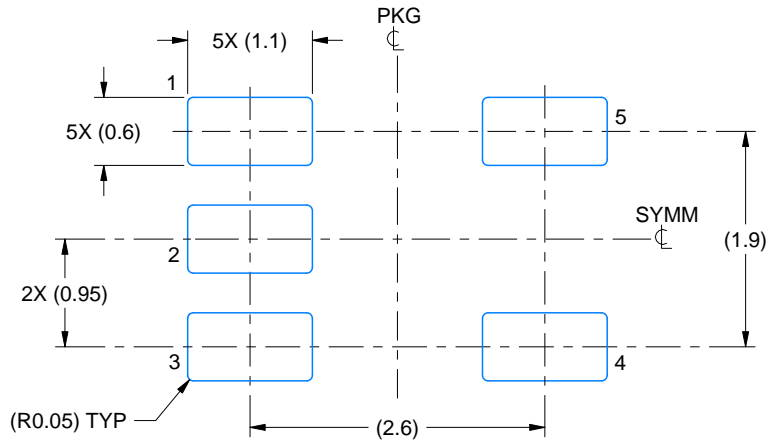

LAND PATTERN EXAMPLE
EXPOSED METAL SHOWN
SCALE:15X

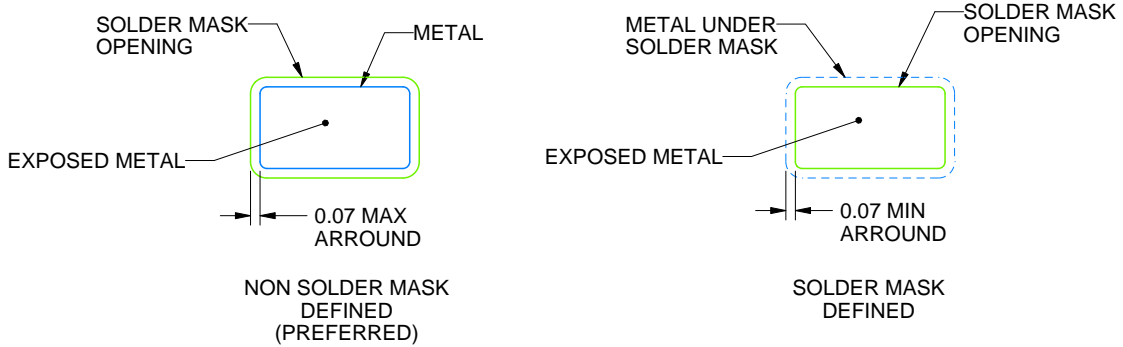

SOLDER MASK DETAILS

4214839/K 08/2024

NOTES: (continued)

- 6. Publication IPC-7351 may have alternate designs.
- 7. Solder mask tolerances between and around signal pads can vary based on board fabrication site.

EXAMPLE STENCIL DESIGN

DBV0005A

SOT-23 - 1.45 mm max height

SMALL OUTLINE TRANSISTOR

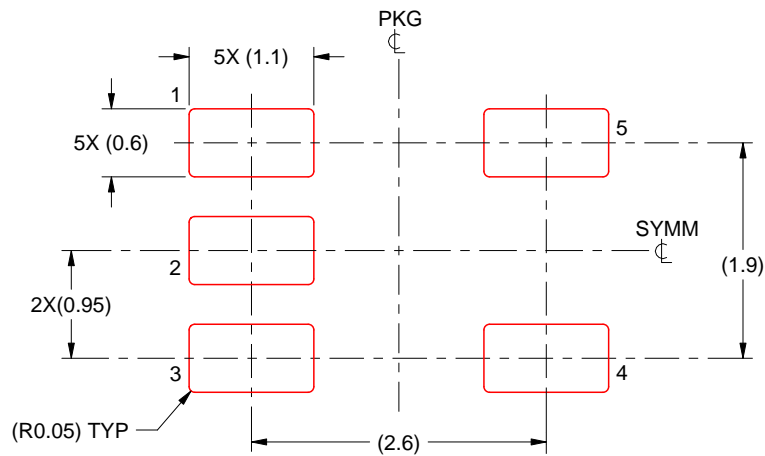

SOLDER PASTE EXAMPLE
BASED ON 0.125 mm THICK STENCIL
SCALE:15X

4214839/K 08/2024

NOTES: (continued)

8. Laser cutting apertures with trapezoidal walls and rounded corners may offer better paste release. IPC-7525 may have alternate design recommendations.
9. Board assembly site may have different recommendations for stencil design.

DCK0005A



PACKAGE OUTLINE

SOT - 1.1 max height

SMALL OUTLINE TRANSISTOR

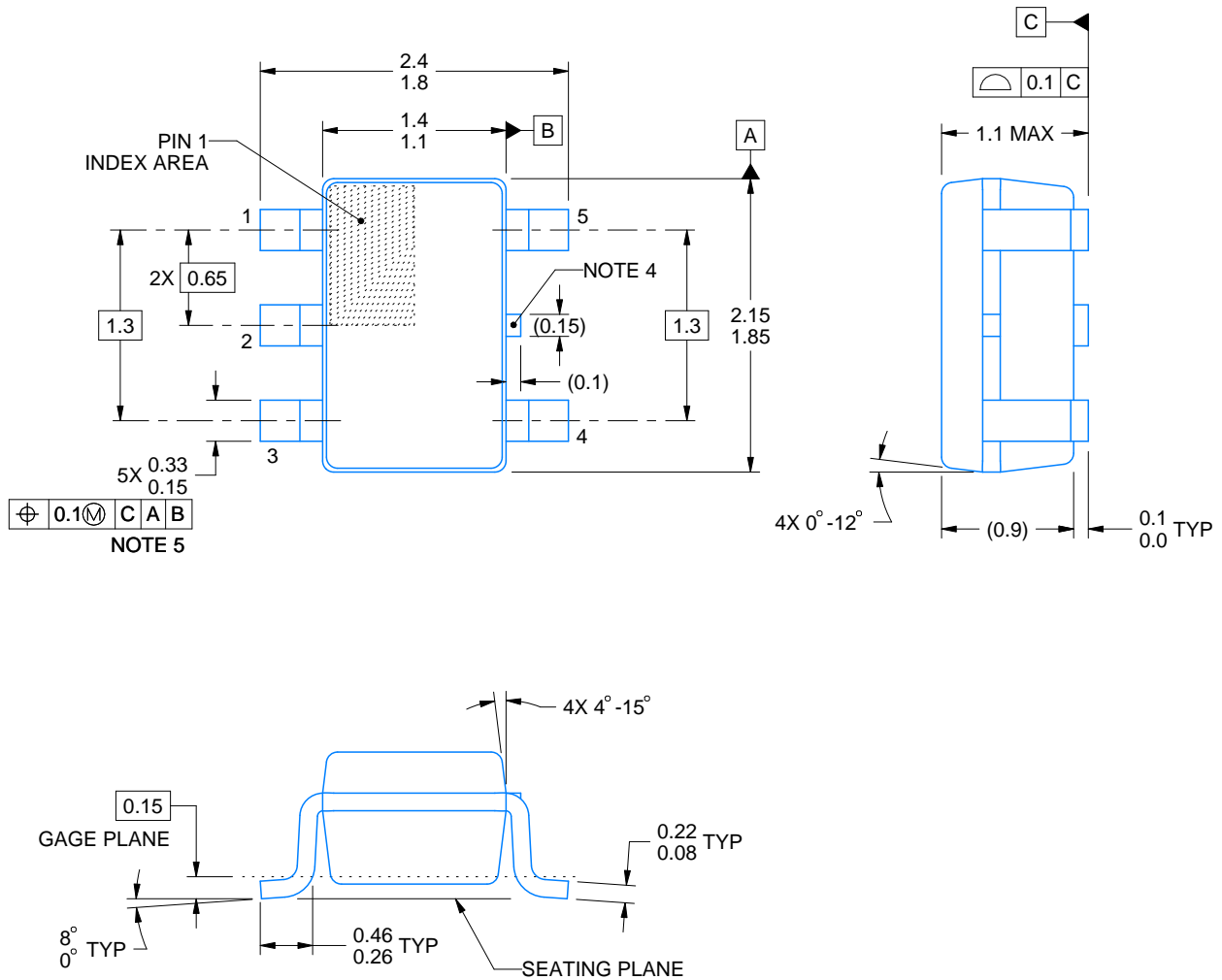

4214834/G 11/2024

NOTES:

1. All linear dimensions are in millimeters. Any dimensions in parenthesis are for reference only. Dimensioning and tolerancing per ASME Y14.5M.
2. This drawing is subject to change without notice.
3. Reference JEDEC MO-203.
4. Support pin may differ or may not be present.
5. Lead width does not comply with JEDEC.
6. Body dimensions do not include mold flash, protrusions, or gate burrs. Mold flash, protrusions, or gate burrs shall not exceed 0.25mm per side

EXAMPLE BOARD LAYOUT

DCK0005A

SOT - 1.1 max height

SMALL OUTLINE TRANSISTOR

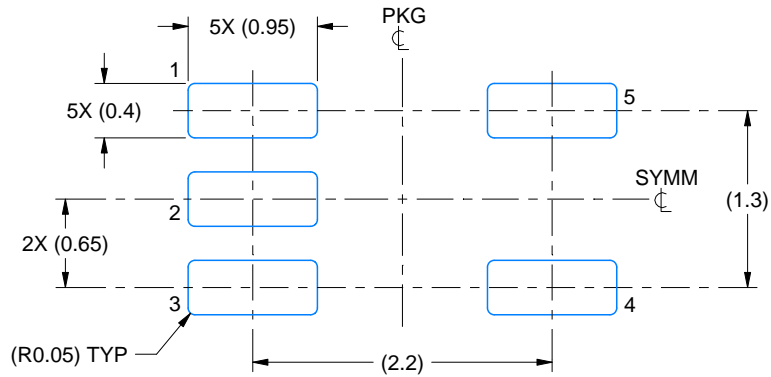

LAND PATTERN EXAMPLE
EXPOSED METAL SHOWN
SCALE:18X

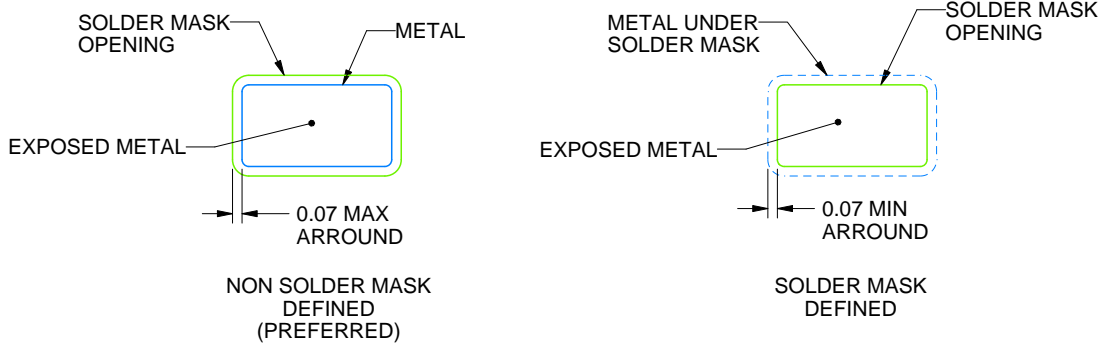

SOLDER MASK DETAILS

4214834/G 11/2024

NOTES: (continued)

- 7. Publication IPC-7351 may have alternate designs.
- 8. Solder mask tolerances between and around signal pads can vary based on board fabrication site.

EXAMPLE STENCIL DESIGN

DCK0005A

SOT - 1.1 max height

SMALL OUTLINE TRANSISTOR

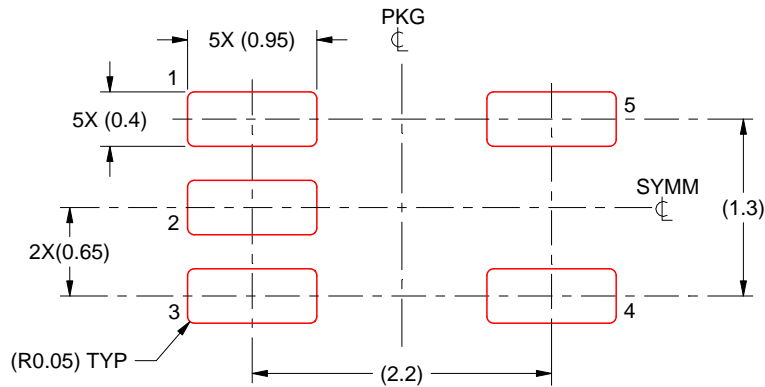

SOLDER PASTE EXAMPLE
BASED ON 0.125 THICK STENCIL
SCALE: 18X

4214834/G 11/2024

NOTES: (continued)

9. Laser cutting apertures with trapezoidal walls and rounded corners may offer better paste release. IPC-7525 may have alternate design recommendations.
10. Board assembly site may have different recommendations for stencil design.

IMPORTANT NOTICE AND DISCLAIMER

TI PROVIDES TECHNICAL AND RELIABILITY DATA (INCLUDING DATA SHEETS), DESIGN RESOURCES (INCLUDING REFERENCE DESIGNS), APPLICATION OR OTHER DESIGN ADVICE, WEB TOOLS, SAFETY INFORMATION, AND OTHER RESOURCES "AS IS" AND WITH ALL FAULTS, AND DISCLAIMS ALL WARRANTIES, EXPRESS AND IMPLIED, INCLUDING WITHOUT LIMITATION ANY IMPLIED WARRANTIES OF MERCHANTABILITY, FITNESS FOR A PARTICULAR PURPOSE OR NON-INFRINGEMENT OF THIRD PARTY INTELLECTUAL PROPERTY RIGHTS.

These resources are intended for skilled developers designing with TI products. You are solely responsible for (1) selecting the appropriate TI products for your application, (2) designing, validating and testing your application, and (3) ensuring your application meets applicable standards, and any other safety, security, regulatory or other requirements.

These resources are subject to change without notice. TI grants you permission to use these resources only for development of an application that uses the TI products described in the resource. Other reproduction and display of these resources is prohibited. No license is granted to any other TI intellectual property right or to any third party intellectual property right. TI disclaims responsibility for, and you will fully indemnify TI and its representatives against, any claims, damages, costs, losses, and liabilities arising out of your use of these resources.

TI's products are provided subject to [TI's Terms of Sale](#) or other applicable terms available either on [ti.com](https://www.ti.com) or provided in conjunction with such TI products. TI's provision of these resources does not expand or otherwise alter TI's applicable warranties or warranty disclaimers for TI products.

TI objects to and rejects any additional or different terms you may have proposed.

Mailing Address: Texas Instruments, Post Office Box 655303, Dallas, Texas 75265

Copyright © 2025, Texas Instruments Incorporated