

# LM48411 Boomer® Audio Power Amplifier Series Ultra-Low EMI, Filterless, 2.5W, Stereo, Class D Audio Power Amplifier with E<sup>2</sup>S

Check for Samples: [LM48411](#)

## FEATURES

- E<sup>2</sup>S System Reduces EMI Preserving Audio Quality and Efficiency
- Output Short Circuit Protection
- Stereo Class D Operation
- No Output Filter Required for Inductive Loads
- Logic Selectable Gain
- Independent Shutdown Control
- Minimum External Components
- "Click and Pop" Suppression Circuitry
- Micro-Power Shutdown Mode
- Available in Space-Saving 0.5mm Pitch DSBGA Package

## APPLICATIONS

- Mobile Phones
- PDAs
- Portable Electronic Devices

## KEY SPECIFICATIONS

- Efficiency at 3.6V, 500mW into 8Ω Speaker: 87% (typ)
- Efficiency at 3.6V, 100mW into 8Ω Speaker: 80% (typ)
- Efficiency at 5V, 1W into 8Ω Speaker: 88% (typ)
- Quiescent Current, 3.6V Supply: 4.2mA (typ)
- Power Output at  $V_{DD} = 5V$   $R_L = 4\Omega$ , THD  $\leq 10\%$ : 2.5W (typ)
- Power Output at  $V_{DD} = 5V$   $R_L = 8\Omega$ , THD  $\leq 10\%$ : 1.5W (typ)
- Total Shutdown Power Supply Current: 0.01μA (typ)
- Single Supply Range: 2.4V to 5.5V

## DESCRIPTION

The LM48411 is a single supply, high efficiency, 2.5W/channel Class D audio amplifier. The LM48411 features TI's Enhanced Emissions Suppression (E<sup>2</sup>S) system, that features a unique patent-pending ultra low EMI, spread spectrum, PWM architecture, that significantly reduces RF emissions while preserving audio quality and efficiency. The E<sup>2</sup>S system improves battery life, reduces external component count, board area consumption, system cost, and simplifying design.

The LM48411 is designed to meet the demands of mobile phones and other portable communication devices. Operating on a single 5V supply, it is capable of delivering 2.5W/channel of continuous output power to a 4Ω load with less than 10% THD+N. Its flexible power supply requirements allow operation from 2.4V to 5.5V. The wide band spread spectrum architecture of the LM48411 reduces EMI-radiated emissions due to the modulator frequency.

The LM48411 features high efficiency compared to a conventional Class AB amplifier. The E<sup>2</sup>S system includes an advanced, patent-pending edge rate control (ERC) architecture that further reduce emissions by minimizing the high frequency component of the device output, while maintaining high quality audio reproduction and high efficiency ( $\eta = 87\%$  at  $V_{DD} = 3.6V$ ,  $P_O = 500mW$ ). Four gain options are pin selectable through GAIN0 and GAIN1 pins.

The LM48411 features a low-power consumption shutdown mode. Shutdown may be enabled by driving the Shutdown pin to a logic low (GND).

Output short circuit protection prevents the device from being damaged during fault conditions. Superior click and pop suppression eliminates audible transients on power up/down and during shutdown. Independent left/right shutdown control maximizes power savings in mixed mono/stereo applications.



Please be aware that an important notice concerning availability, standard warranty, and use in critical applications of Texas Instruments semiconductor products and disclaimers thereto appears at the end of this data sheet.

All trademarks are the property of their respective owners.

LM48411 RF Emissions

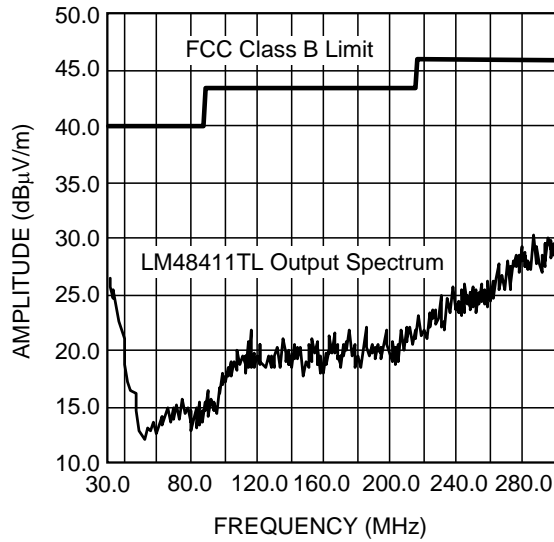

Figure 1. RF Emissions — 3in cable

Typical Application

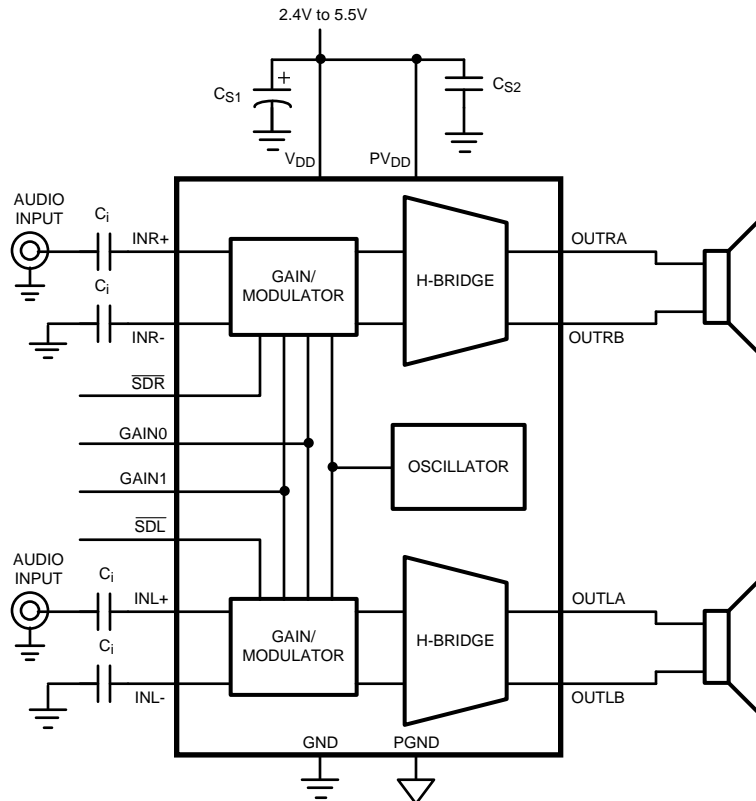
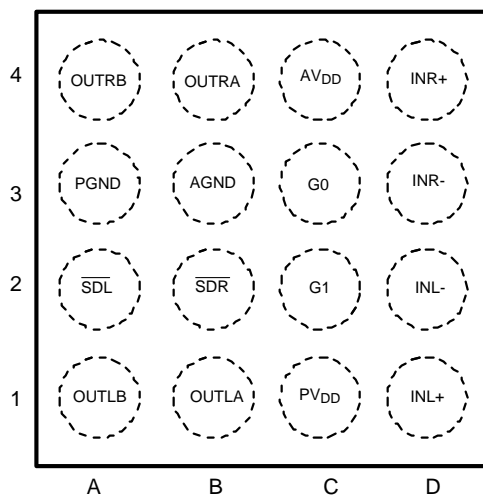

Figure 2. Typical Audio Amplifier Application Circuit

## Connection Diagram



**Figure 3. DSBGA - Top View**  
See YZR0016 Package

### PIN DESCRIPTIONS

Bump	Name	Function
A1	OUTLB	Left Channel output B
A2	$\overline{\text{SDL}}$	Left channel active low shutdown
A3	PGND	Power GND
A4	OUTRB	Right channel output B
B1	OUTLA	Left channel output A
B2	$\overline{\text{SDR}}$	Right channel active low shutdown
B3	AGND	Ground
B4	OUTRA	Right channel output A
C1	PV <sub>DD</sub>	Power V <sub>DD</sub>
C2	G1	Gain setting input 1
C3	G0	Gain setting input 0
C4	AV <sub>DD</sub>	Power supply
D1	INL+	Non-inverting left channel input
D2	INL-	Inverting left channel input
D3	INR-	Inverting right channel input
D4	INR+	Non-inverting right channel input



These devices have limited built-in ESD protection. The leads should be shorted together or the device placed in conductive foam during storage or handling to prevent electrostatic damage to the MOS gates.

**Absolute Maximum Ratings**<sup>(1)(2)(3)</sup>

Supply Voltage <sup>(1)</sup>		6.0V
Storage Temperature		-65°C to +150°C
Voltage at Any Input Pin		$V_{DD} + 0.3V \geq V \geq GND - 0.3V$
Power Dissipation <sup>(4)</sup>		Internally Limited
ESD Rating, all other pins <sup>(5)</sup>		2.0kV
ESD Rating <sup>(6)</sup>		200V
Junction Temperature ( $T_{JMAX}$ )		150°C
Thermal Resistance	$\theta_{JA}$ (DSBGA)	63.6°C/W
Soldering Information	See <a href="#">SNVA009</a> "microSMD Wafers Level Chip Scale Package."	

- (1) "Absolute Maximum Ratings" indicate limits beyond which damage to the device may occur, including inoperability and degradation of device reliability and/or performance. Functional operation of the device and/or non-degradation at the Absolute *Absolute Maximum Ratings* or other conditions beyond those indicated in the *Recommended Operating Conditions* is not implied. The *Recommended Operating Conditions* indicate conditions at which the device is functional and the device should not be operated beyond such conditions. All voltages are measured with respect to the ground pin, unless otherwise specified
- (2) The *Electrical Characteristics* tables list ensured specifications under the listed *Recommended Operating Conditions* except as otherwise modified or specified by the *Electrical Characteristics Conditions* and/or Notes. Typical specifications are estimations only and are not ensured.
- (3) If Military/Aerospace specified devices are required, please contact the TI Sales Office/ Distributors for availability and specifications.
- (4) The maximum power dissipation must be derated at elevated temperatures and is dictated by  $T_{JMAX}$ ,  $\theta_{JA}$ , and the ambient temperature,  $T_A$ . The maximum allowable power dissipation is  $P_{DMAX} = (T_{JMAX} - T_A) / \theta_{JA}$  or the number given in *Absolute Maximum Ratings*, whichever is lower. For the LMxxxxx, see [Power Derating](#) curves for additional information.
- (5) Human body model, applicable std. JESD22-A114C.
- (6) Machine model, applicable std. JESD22-A115-A.

**Operating Ratings**<sup>(1)(2)</sup>

Temperature Range $T_{MIN} \leq T_A \leq T_{MAX}$		$-40^\circ\text{C} \leq T_A \leq 85^\circ\text{C}$
Supply Voltage		$2.4V \leq V_{DD} \leq 5.5V$

- (1) "Absolute Maximum Ratings" indicate limits beyond which damage to the device may occur, including inoperability and degradation of device reliability and/or performance. Functional operation of the device and/or non-degradation at the Absolute *Absolute Maximum Ratings* or other conditions beyond those indicated in the *Recommended Operating Conditions* is not implied. The *Recommended Operating Conditions* indicate conditions at which the device is functional and the device should not be operated beyond such conditions. All voltages are measured with respect to the ground pin, unless otherwise specified
- (2) The *Electrical Characteristics* tables list ensured specifications under the listed *Recommended Operating Conditions* except as otherwise modified or specified by the *Electrical Characteristics Conditions* and/or Notes. Typical specifications are estimations only and are not ensured.

## Electrical Characteristics

The following specifications apply for  $A_V = 6\text{dB}$ ,  $R_L = 15\mu\text{H}+8\Omega$ ,  $f = 1\text{kHz}$ , unless otherwise specified. Limits apply for  $T_A = 25^\circ\text{C}$ .  $V_{DD} = 3.6\text{V}$ .

Symbol	Parameter	Conditions	LM48411		Units (Limits)
			Typical <sup>(1)</sup>	Limit <sup>(2)(3)</sup>	
$ V_{OS} $	Differential Output Offset Voltage	$V_I = 0\text{V}$ , $A_V = 2\text{V/V}$ , $V_{DD} = 2.4\text{V to } 5.0\text{V}$	5		mV
$I_{DD}$	Quiescent Power Supply Current	$V_{IN} = 0\text{V}$ , No Load, $V_{DD} = 5.0\text{V}$	5.1	7.5	mA (max)
		$V_{IN} = 0\text{V}$ , No Load, $V_{DD} = 3.6\text{V}$	4.2	6.0	mA (max)
		$V_{IN} = 0\text{V}$ , No Load, $V_{DD} = 2.4\text{V}$	3.0	4.5	mA (max)
		$V_{IN} = 0\text{V}$ , $R_L = 8\Omega$ , $V_{DD} = 5.0\text{V}$	5.2		mA
		$V_{IN} = 0\text{V}$ , $R_L = 8\Omega$ , $V_{DD} = 3.6\text{V}$	4.2		mA
		$V_{IN} = 0\text{V}$ , $R_L = 8\Omega$ , $V_{DD} = 2.4\text{V}$	3.0		mA
$I_{SD}$	Shutdown Current <sup>(3)</sup>	$V_{SDR} = V_{SDL} = \text{GND}$	0.01	1.0	$\mu\text{A}$ (max)
$V_{SDIH}$	Shutdown voltage input high	For SDR, SDL		1.4	V (min)
$V_{SDIL}$	Shutdown voltage input low	For SDR, SDL		0.4	V (max)
$A_V$	Gain	$\text{GAIN}_0, \text{GAIN}_1 = \text{GND}$ $R_L = \infty$	6	$6\pm 0.5$	dB
		$\text{GAIN}_0 = V_{DD}, \text{GAIN}_1 = \text{GND}$ $R_L = \infty$	12	$12\pm 0.5$	dB
		$\text{GAIN}_0 = \text{GND}, \text{GAIN}_1 = V_{DD}$ $R_L = \infty$	18	$18\pm 0.5$	dB
		$\text{GAIN}_0, \text{GAIN}_1 = V_{DD}$ $R_L = \infty$	24	$24\pm 0.5$	dB
$R_{IN}$	Input Resistance	$A_V = 6\text{dB}$	56		k $\Omega$
		$A_V = 12\text{dB}$	37.5		k $\Omega$
		$A_V = 18\text{dB}$	22.5		k $\Omega$
		$A_V = 24\text{dB}$	12.5		k $\Omega$
$T_{WU}$	Wake Up Time	$\sqrt{V_{SDR}/V_{SDL}} = 0.4\text{V}$	4.2		ms

(1) Typical values represent most likely parametric norms at  $T_A = +25^\circ\text{C}$ , and at the *Recommended Operation Conditions* at the time of product characterization and are not specified.

(2) Datasheet min/max specification limits are not specified by test or statistical analysis.

(3) Shutdown current is measured in a normal room environment. Exposure to direct sunlight will increase  $I_{SD}$  by a maximum of  $2\mu\text{A}$ . The Shutdown pin should be driven as close as possible to GND for minimal shutdown current and to  $V_{DD}$  for the best THD performance in PLAY mode. See the [Application Information](#) section under [SHUTDOWN FUNCTION](#) for more information.

## Electrical Characteristics (continued)

The following specifications apply for  $A_V = 6\text{dB}$ ,  $R_L = 15\mu\text{H} + 8\Omega$ ,  $f = 1\text{kHz}$ , unless otherwise specified. Limits apply for  $T_A = 25^\circ\text{C}$ .  $V_{DD} = 3.6\text{V}$ .

Symbol	Parameter	Conditions	LM48411		Units (Limits)
			Typical <sup>(1)</sup>	Limit <sup>(2)(3)</sup>	
$P_O$	Output Power	$R_L = 15\mu\text{H} + 4\Omega + 15\mu\text{H}$ THD = 10% (max) $f = 1\text{kHz}$ , 22kHz BW			
		$V_{DD} = 5\text{V}$	2.5		W
		$V_{DD} = 3.6\text{V}$	1.2		W
		$V_{DD} = 2.5\text{V}$	530		mW
		$R_L = 15\mu\text{H} + 4\Omega + 15\mu\text{H}$ THD = 1% (max) $f = 1\text{kHz}$ , 22kHz BW			
		$V_{DD} = 5\text{V}$	2		W
		$V_{DD} = 3.6\text{V}$	1		W
		$V_{DD} = 2.5\text{V}$	430		mW
		$R_L = 15\mu\text{H} + 8\Omega + 15\mu\text{H}$ THD = 10% (max) $f = 1\text{kHz}$ , 22kHz BW			
		$V_{DD} = 5\text{V}$	1.5		W
		$V_{DD} = 3.6\text{V}$	760		mW
		$V_{DD} = 2.5\text{V}$	330		mW
		$R_L = 15\mu\text{H} + 8\Omega + 15\mu\text{H}$ THD = 1% (max) $f = 1\text{kHz}$ , 22kHz BW			
		$V_{DD} = 5\text{V}$	1.25		W
		$V_{DD} = 3.6\text{V}$	615		mW
$V_{DD} = 2.5\text{V}$	270		mW		
THD+N	Total Harmonic Distortion + Noise	$P_O = 500\text{mW}$ , $f = 1\text{kHz}$ , $R_L = 8\Omega$	0.05		%
		$P_O = 300\text{mW}$ , $f = 1\text{kHz}$ , $R_L = 8\Omega$	0.03		%
PSRR	Power Supply Rejection Ratio (Input Referred)	$V_{\text{Ripple}} = 200\text{mV}_{\text{PP}}$ Sine, $f_{\text{Ripple}} = 217\text{Hz}$ , $V_{DD} = 3.6, 5\text{V}$ Inputs to AC GND, $C_I = 2\mu\text{F}$	78		dB
		$V_{\text{Ripple}} = 200\text{mV}_{\text{PP}}$ Sine, $f_{\text{Ripple}} = 1\text{kHz}$ , $V_{DD} = 3.6, 5\text{V}$ Inputs to AC GND, $C_I = 2\mu\text{F}$	77		dB
SNR	Signal to Noise Ratio	$V_{DD} = 5\text{V}$ , $P_O = 1\text{W}_{\text{RMS}}$	96		dB
$\epsilon_{\text{OUT}}$	Output Noise (Input Referred)	$V_{DD} = 3.6\text{V}$ , A Weighted	22		$\mu\text{V}_{\text{RMS}}$
CMRR	Common Mode Rejection Ratio (Input Referred)	$V_{DD} = 3.6\text{V}$ , $V_{\text{Ripple}} = 1\text{V}_{\text{PP}}$ Sine $f_{\text{Ripple}} = 217\text{Hz}$	64		dB
$\eta$	Efficiency	$V_{DD} = 5\text{V}$ , $P_{\text{OUT}} = 1\text{W}$ $R_L = 8\Omega$	88		%
Xtalk	Crosstalk	$P_O = 500\text{mW}$ , $f = \text{kHz}$	84		dB

### Typical Performance Characteristics

The performance graphs were taken using the Audio Precision AUX-0025 Switching Amplifier measurement Filter in series with the LC filter on the demo board.

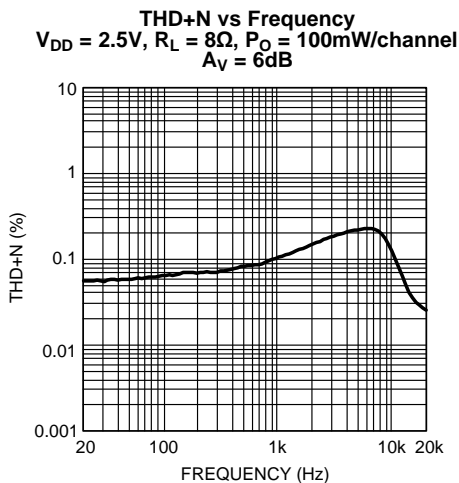

Figure 4.

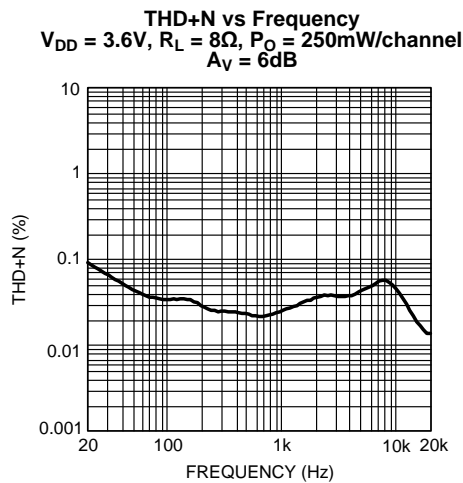

Figure 5.

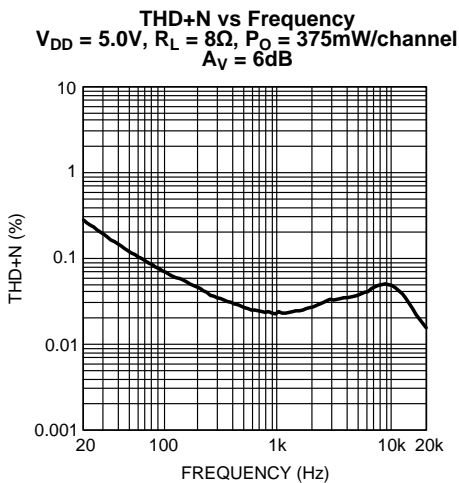

Figure 6.

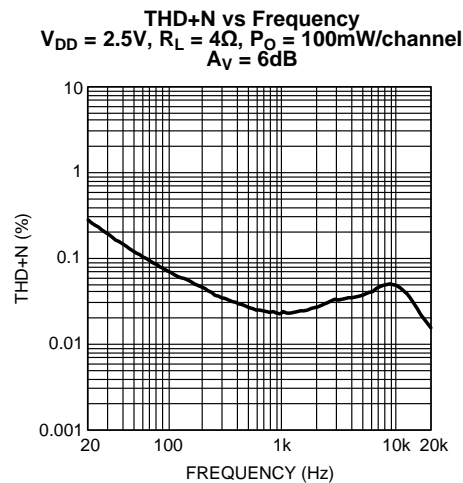

Figure 7.

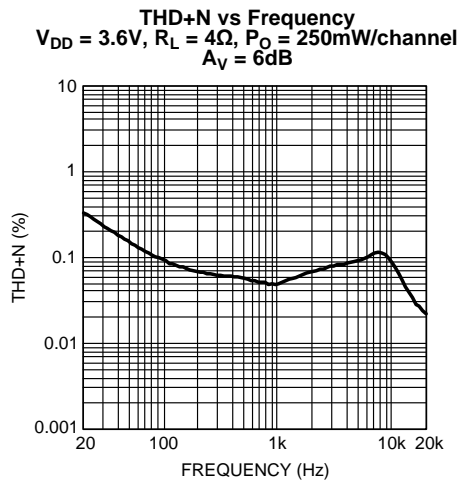

Figure 8.

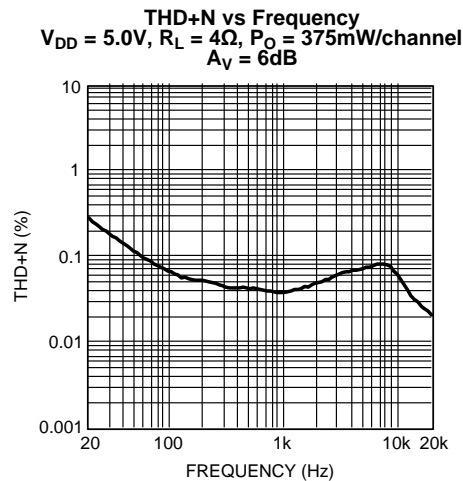

Figure 9.

**Typical Performance Characteristics (continued)**

The performance graphs were taken using the Audio Precision AUX-0025 Switching Amplifier measurement Filter in series with the LC filter on the demo board.

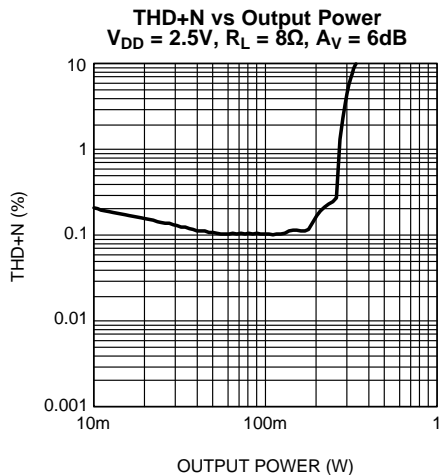

Figure 10.

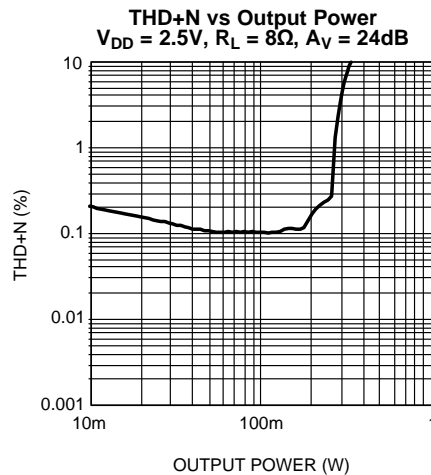

Figure 11.

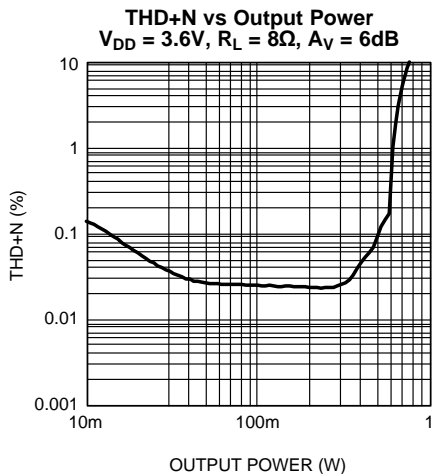

Figure 12.

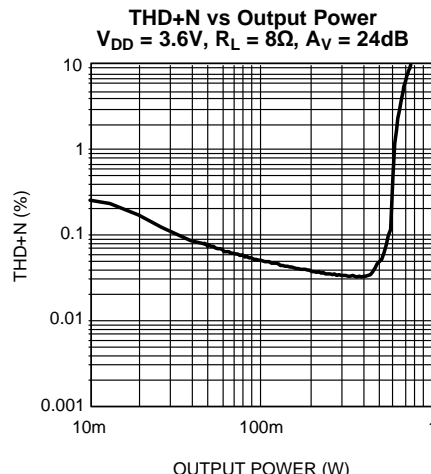

Figure 13.

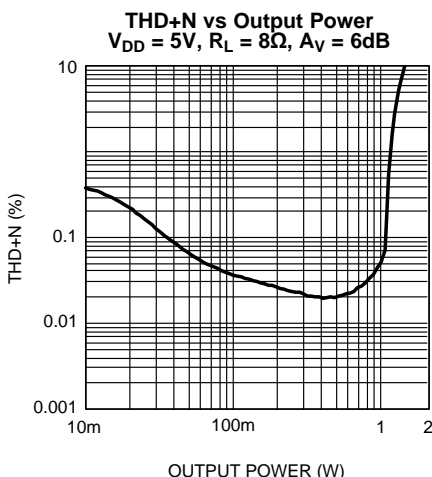

Figure 14.

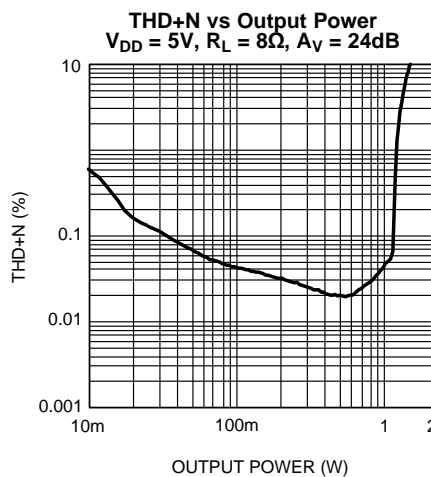

Figure 15.



### Typical Performance Characteristics (continued)

The performance graphs were taken using the Audio Precision AUX-0025 Switching Amplifier measurement Filter in series with the LC filter on the demo board.

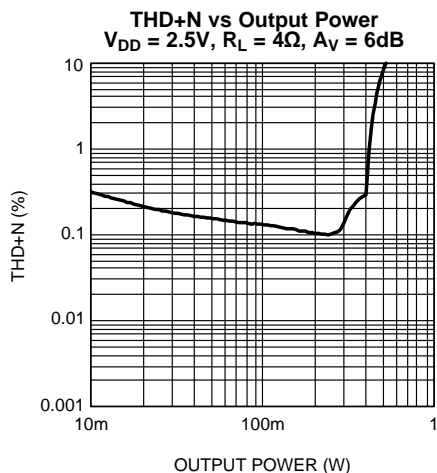

Figure 16.

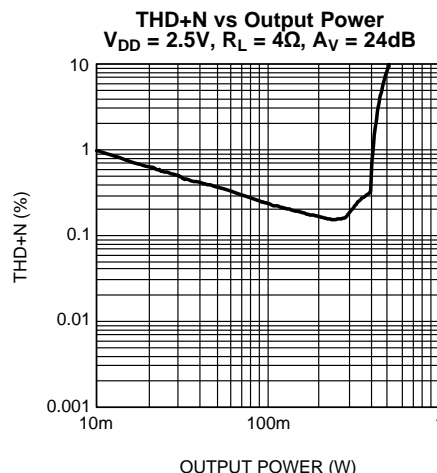

Figure 17.

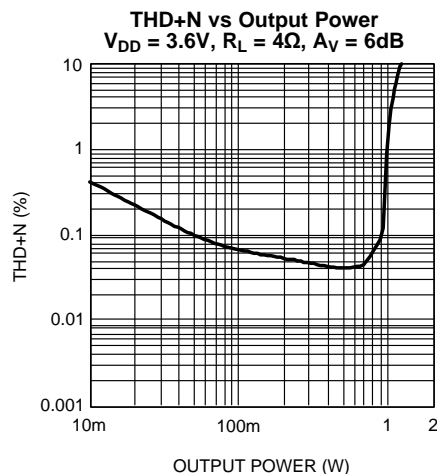

Figure 18.

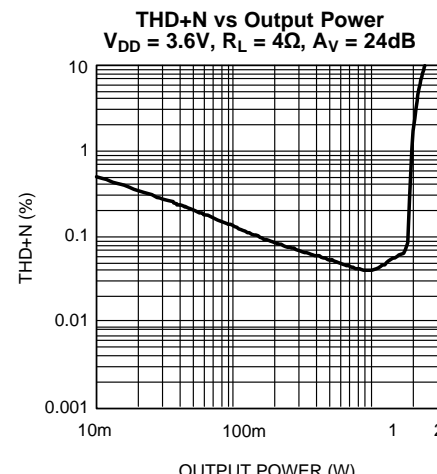

Figure 19.

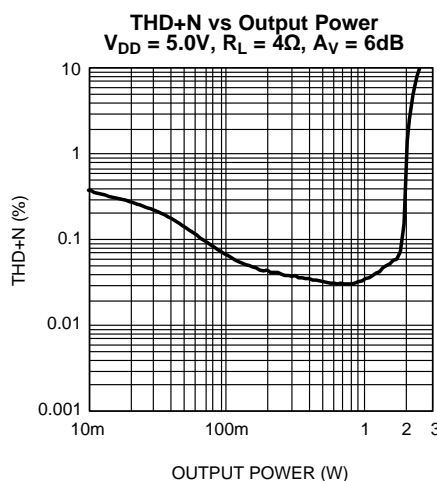

Figure 20.

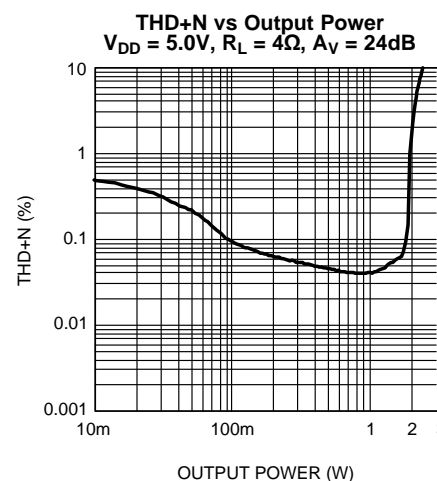

Figure 21.

### Typical Performance Characteristics (continued)

The performance graphs were taken using the Audio Precision AUX-0025 Switching Amplifier measurement Filter in series with the LC filter on the demo board.

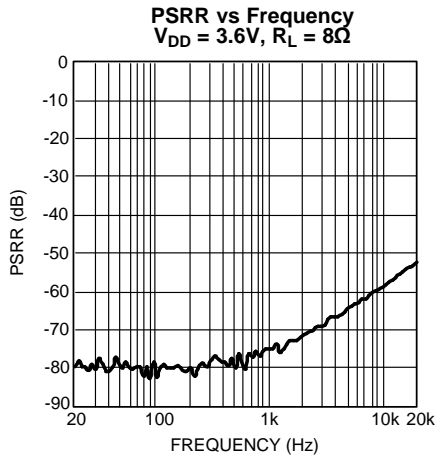

Figure 22.

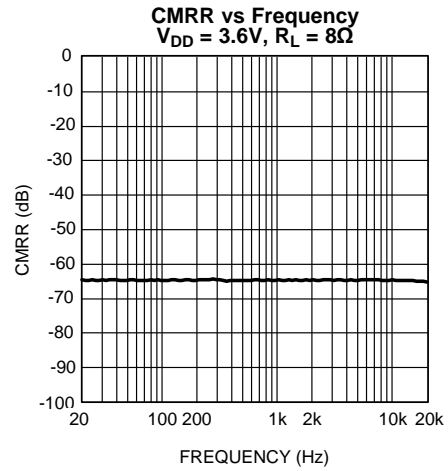

Figure 23.

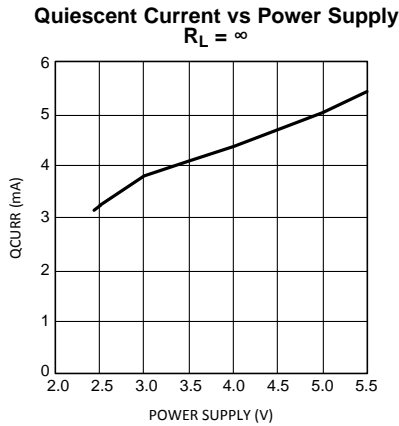

Figure 24.

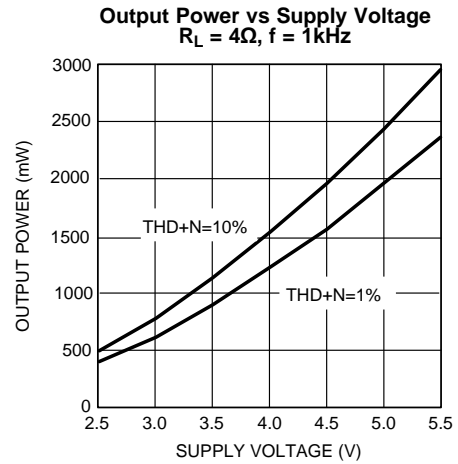

Figure 25.

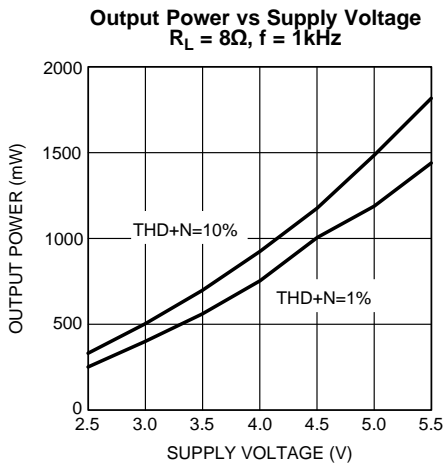

Figure 26.

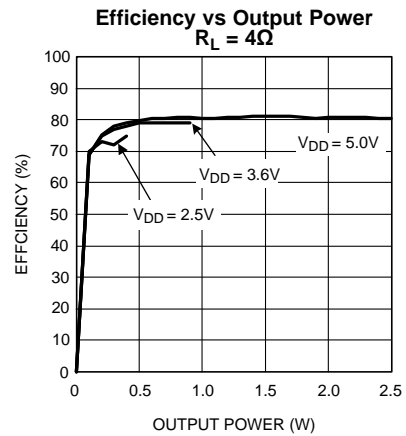

Figure 27.

### Typical Performance Characteristics (continued)

The performance graphs were taken using the Audio Precision AUX-0025 Switching Amplifier measurement Filter in series with the LC filter on the demo board.

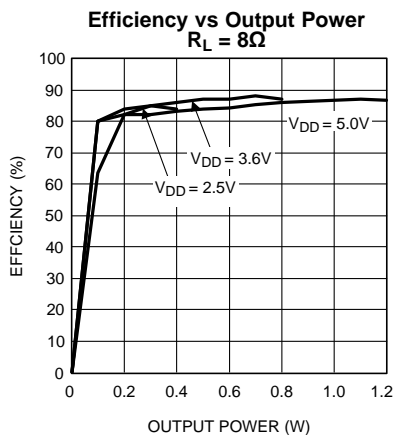

Figure 28.

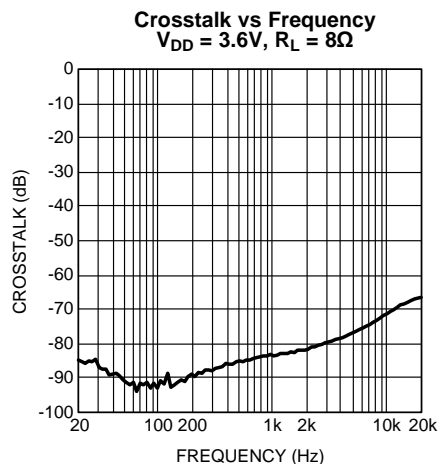

Figure 29.

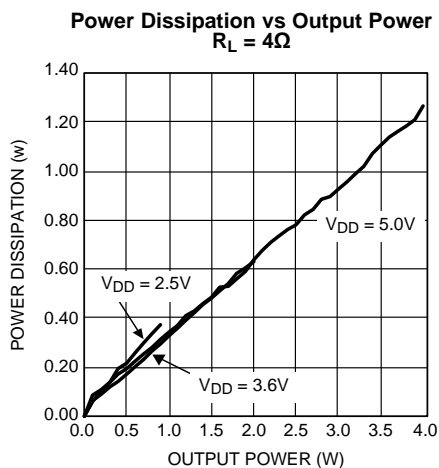

Figure 30.

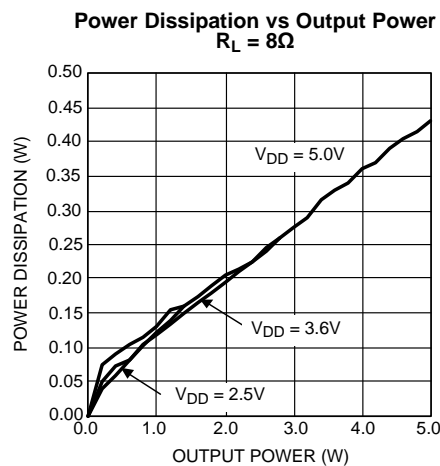

Figure 31.

## External Components Description

(Figure 2)

Components		Functional Description
1.	$C_S$	Supply bypass capacitor which provides power supply filtering. Refer to the <a href="#">Power Supply Bypassing</a> section for information concerning proper placement and selection of the supply bypass capacitor.
2.	$C_I$	Input AC coupling capacitor which blocks the DC voltage at the amplifier's input terminals.

## APPLICATION INFORMATION

### GENERAL AMPLIFIER FUNCTION

The LM48411 features a filterless modulation scheme. The differential outputs of the device switch at 300kHz from  $V_{DD}$  to GND. When there is no input signal applied, the two outputs ( $V_{O1}$  and  $V_{O2}$ ) switch with a 50% duty cycle, with both outputs in phase. Because the outputs of the LM48411 are differential, the two signals cancel each other. This results in no net voltage across the speaker, thus there is no load current during an idle state, conserving power.

With an input signal applied, the duty cycle (pulse width) of the LM48411 outputs changes. For increasing output voltages, the duty cycle of  $V_{O1}$  increases, while the duty cycle of  $V_{O2}$  decreases. For decreasing output voltages, the converse occurs, the duty cycle of  $V_{O2}$  increases while the duty cycle of  $V_{O1}$  decreases. The difference between the two pulse widths yields the differential output voltage.

### SPREAD SPECTRUM MODULATION

The LM48411 features a filterless spread spectrum modulation scheme that eliminates the need for output filters, ferrite beads or chokes. The switching frequency varies by  $\pm 30\%$  about a 300kHz center frequency, reducing the wideband spectral content, improving EMI emissions radiated by the speaker and associated cables and traces. Where a fixed frequency class D exhibits large amounts of spectral energy at multiples of the switching frequency, the spread spectrum architecture of the LM48411 spreads that energy over a larger bandwidth. The cycle-to-cycle variation of the switching period does not affect the audio reproduction of efficiency.

### ENHANCED EMISSIONS SUPPRESSION SYSTEM (E<sup>2</sup>S)

The LM48411 features TI's patent-pending E<sup>2</sup>S system that reduces EMI, while maintaining high quality audio reproduction and efficiency. The E<sup>2</sup>S system features a synchronizable oscillator with selectable spread spectrum, and advanced edge rate control (ERC). The LM48411 ERC greatly reduces the high frequency components of the output square waves by controlling the output rise and fall times, slowing the transitions to reduce RF emissions, while maximizing THD+N and efficiency performance.

### POWER DISSIPATION AND EFFICIENCY

In general terms, efficiency is considered to be the ratio of useful work output divided by the total energy required to produce it with the difference being the power dissipated, typically, in the IC. The key here is "useful" work. For audio systems, the energy delivered in the audible bands is considered useful including the distortion products of the input signal. Sub-sonic (DC) and super-sonic components (>22kHz) are not useful. The difference between the power flowing from the power supply and the audio band power being transduced is dissipated in the LM48411 and in the transducer load. The amount of power dissipation in the LM48411 is very low. This is because the ON resistance of the switches used to form the output waveforms is typically less than  $0.25\Omega$ . This leaves only the transducer load as a potential "sink" for the small excess of input power over audio band output power. The LM48411 dissipates only a fraction of the excess power requiring no additional PCB area or copper plane to act as a heat sink.

### DIFFERENTIAL AMPLIFIER EXPLANATION

As logic supply voltages continue to shrink, designers are increasingly turning to differential analog signal handling to preserve signal to noise ratios with restricted voltage swing. The LM48411 is a fully differential amplifier that features differential input and output stages. A differential amplifier amplifies the difference between the two input signals. Traditional audio power amplifiers have typically offered only single-ended inputs resulting in a 6dB reduction in signal to noise ratio relative to differential inputs. The LM48411 also offers the possibility of

DC input coupling which eliminates the two external AC coupling, DC blocking capacitors. The LM48411 can be used, however, as a single ended input amplifier while still retaining its fully differential benefits. In fact, completely unrelated signals may be placed on the input pins. The LM48411 simply amplifies the difference between the signals. A major benefit of a differential amplifier is the improved common mode rejection ratio (CMRR) over single input amplifiers. The common-mode rejection characteristic of the differential amplifier reduces sensitivity to ground offset related noise injection, especially important in high noise applications.

## PCB LAYOUT CONSIDERATIONS

As output power increases, interconnect resistance (PCB traces and wires) between the amplifier, load and power supply create a voltage drop. The voltage loss on the traces between the LM48411 and the load results in lower output power and decreased efficiency. Higher trace resistance between the supply and the LM48411 has the same effect as a poorly regulated supply, increased ripple on the supply line also reducing the peak output power. The effects of residual trace resistance increases as output current increases due to higher output power, decreased load impedance or both. To maintain the highest output voltage swing and corresponding peak output power, the PCB traces that connect the output pins to the load and the supply pins to the power supply should be as wide as possible to minimize trace resistance.

The use of power and ground planes will give the best THD+N performance. While reducing trace resistance, the use of power planes also creates parasitic capacitors that help to filter the power supply line.

The inductive nature of the transducer load can also result in overshoot on one or both edges, clamped by the parasitic diodes to GND and  $V_{DD}$  in each case. From an EMI standpoint, this is an aggressive waveform that can radiate or conduct to other components in the system and cause interference. It is essential to keep the power and output traces short and well shielded if possible. Use of ground planes, beads, and micro-strip layout techniques are all useful in preventing unwanted interference.

As the distance from the LM48411 and the speaker increase, the amount of EMI radiation will increase since the output wires or traces acting as antenna become more efficient with length. What is acceptable EMI is highly application specific. Ferrite chip inductors placed close to the LM48411 may be needed to reduce EMI radiation. The value of the ferrite chip is very application specific.

## SHUTDOWN FUNCTION

In order to reduce power consumption while not in use, the LM48411 contains shutdown circuitry that reduces current draw to less than 0.01 $\mu$ A. The trigger point for shutdown is shown as a typical value in the Electrical Characteristics Tables and in the Shutdown Hysteresis Voltage graphs found in the [Typical Performance Characteristics](#) section. It is best to switch between ground and supply for minimum current usage while in the shutdown state. While the LM48411 may be disabled with shutdown voltages in between ground and supply, the idle current will be greater than the typical 0.01 $\mu$ A value.

The LM48411 has an internal resistor connected between GND and Shutdown pins. The purpose of this resistor is to eliminate any unwanted state changes when the Shutdown pin is floating. The LM48411 will enter the shutdown state when the Shutdown pin is left floating or if not floating, when the shutdown voltage has crossed the threshold. To minimize the supply current while in the shutdown state, the Shutdown pin should be driven to GND or left floating. If the Shutdown pin is not driven to GND, the amount of additional resistor current due to the internal shutdown resistor can be found by [Equation 1](#) below.

$$(V_{SD} - GND) / 300k\Omega \quad (1)$$

With only a 0.5V difference, an additional 1.7 $\mu$ A of current will be drawn while in the shutdown state.

## AUDIO AMPLIFIER POWER SUPPLY BYPASSING FILTERING

Proper power supply bypassing is critical for low noise performance and high PSRR. Place the supply bypass capacitor as close to the device as possible. Typical applications employ a voltage regulator with 10 $\mu$ F and 0.1 $\mu$ F bypass capacitors that increase supply stability. These capacitors do not eliminate the need for bypassing of the LM48411 supply pins. A 1 $\mu$ F capacitor is recommended.

## AUDIO AMPLIFIER INPUT CAPACITOR SELECTION

Input capacitors may be required for some applications, or when the audio source is single-ended. Input capacitors block the DC component of the audio signal, eliminating any conflict between the DC component of the audio source and the bias voltage of the LM48411. The input capacitors create a high-pass filter with the input resistance  $R_i$ . The -3dB point of the high pass filter is found using [Equation 2](#) below.

$$f = 1 / 2\pi R_i C_i \quad (2)$$

The values for  $R_i$  can be found in the EC table for each gain setting.

The input capacitors can also be used to remove low frequency content from the audio signal. Small speakers cannot reproduce, and may even be damaged by low frequencies. High pass filtering the audio signal helps protect the speakers. When the LM48411 is using a single-ended source, power supply noise on the ground is seen as an input signal. Setting the high-pass filter point above the power supply noise frequencies, 217 Hz in a GSM phone, for example, filters out the noise such that it is not amplified and heard on the output. Capacitors with a tolerance of 10% or better are recommended for impedance matching and improved CMRR and PSRR.

## AUDIO AMPLIFIER GAIN SETTING

The LM48411 features four internally configured gain settings. The device gain is selected through the two logic inputs,  $G_0$  and  $G_1$ . The gain settings are as shown in the following table.

LOGIC INPUT		GAIN	
$G_1$	$G_0$	V/V	dB
0	0	2	6
0	1	4	12
1	0	8	18
1	1	16	24

## Build of Materials

Designator	Description	Footprint	Quantity
C1, C2	Ceramic Capacitor 0.1 $\mu$ F, 50V, 10%	805	2
C3 – C6	Tantalum Capacitors 1 $\mu$ F 20V, 10%, Size A	1206	4
C11	Tantalum Capacitors 10 $\mu$ F 20V, 10% Size B	1411	1
JP1–5, JP8–11	Jumper Header Vertical Mount 2X1 0.100		9
JP6, JP7	Jumper Header Vertical Mount 3x1 0.100		2

### Demonstration Board Schematic

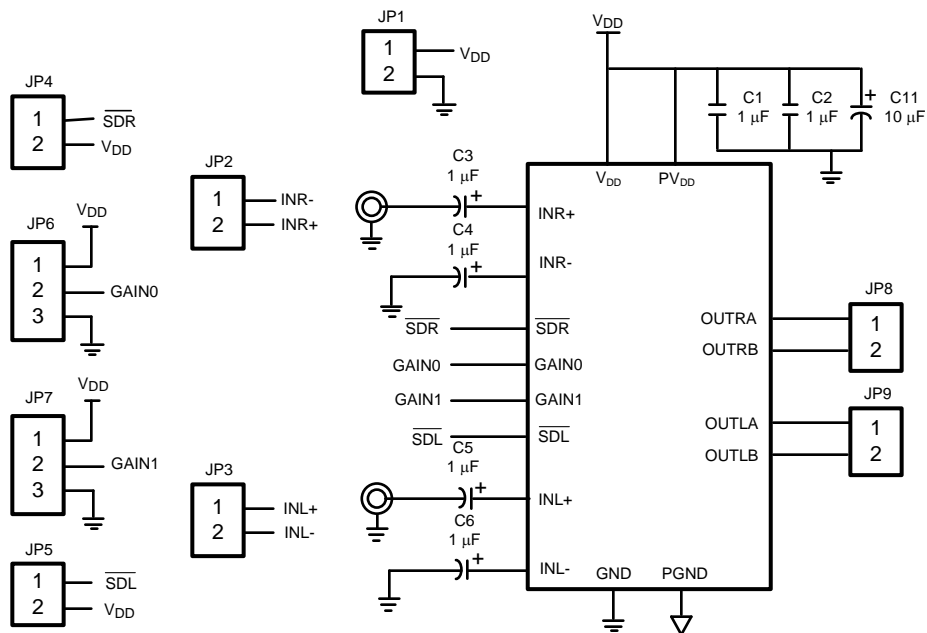

### Demonstration Board Layout

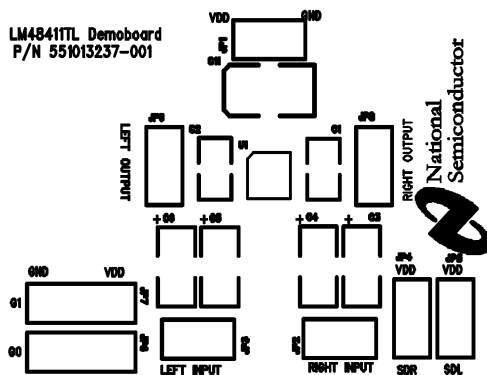

Figure 32. Top Silkscreen Layer

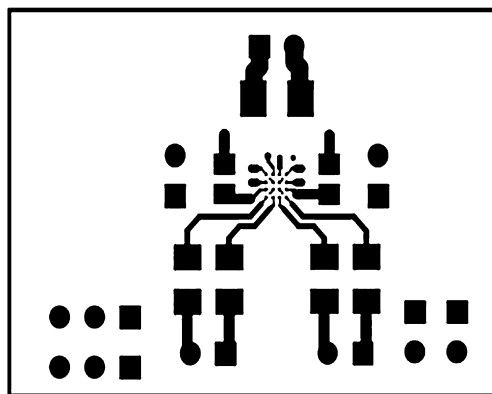

Figure 33. Top Layer

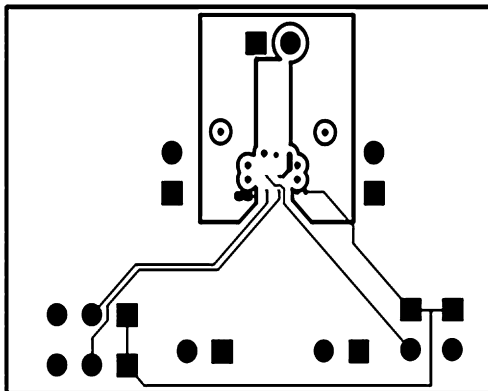

Figure 34. Mid 1 Layer

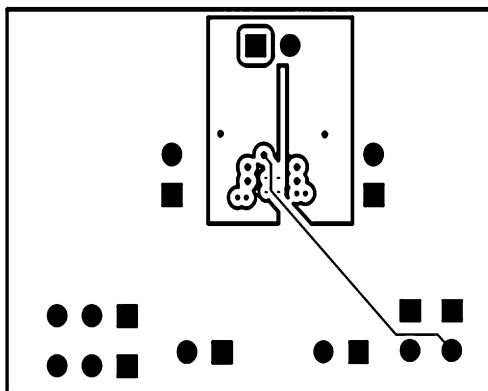

Figure 35. Mid 2 Layer

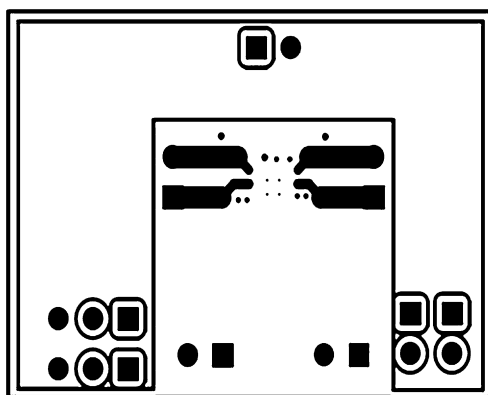

Figure 36. Bottom Layer



## REVISION HISTORY

Rev	Date	Description
1.0	09/21/07	Initial release.
1.1	10/01/07	Fixed few typos.
1.2	11/30/07	Added the demo boards and BOM.
1.3	12/19/07	Edited the 16–bump DSBGA package diagram and the Pin Description table.
1.4	01/08/08	Edited the 16–bump DSBGA package diagram.
1.5	06/27/08	Text edits.
1.6	07/03/08	Text edits (under SHUTDOWN FUNCTION).

**Changes from Revision F (May 2013) to Revision G**
**Page**

- |  |           |
|--|-----------|
| <ul style="list-style-type: none"> <li>• Changed layout of National Data Sheet to TI format .....</li> </ul> | <b>16</b> |
|--|-----------|

**PACKAGING INFORMATION**

Orderable Device	Status (1)	Package Type	Package Drawing	Pins	Package Qty	Eco Plan (2)	Lead finish/ Ball material (6)	MSL Peak Temp (3)	Op Temp (°C)	Device Marking (4/5)	Samples
LM48411TL/NOPB	ACTIVE	DSBGA	YZR	16	250	RoHS & Green	SNAGCU	Level-1-260C-UNLIM	-40 to 85	GJ2	<b>Samples</b>
LM48411TLX/NOPB	ACTIVE	DSBGA	YZR	16	3000	RoHS & Green	SNAGCU	Level-1-260C-UNLIM	-40 to 85	GJ2	<b>Samples</b>

(1) The marketing status values are defined as follows:

**ACTIVE:** Product device recommended for new designs.

**LIFEBUY:** TI has announced that the device will be discontinued, and a lifetime-buy period is in effect.

**NRND:** Not recommended for new designs. Device is in production to support existing customers, but TI does not recommend using this part in a new design.

**PREVIEW:** Device has been announced but is not in production. Samples may or may not be available.

**OBSOLETE:** TI has discontinued the production of the device.

(2) **RoHS:** TI defines "RoHS" to mean semiconductor products that are compliant with the current EU RoHS requirements for all 10 RoHS substances, including the requirement that RoHS substance do not exceed 0.1% by weight in homogeneous materials. Where designed to be soldered at high temperatures, "RoHS" products are suitable for use in specified lead-free processes. TI may reference these types of products as "Pb-Free".

**RoHS Exempt:** TI defines "RoHS Exempt" to mean products that contain lead but are compliant with EU RoHS pursuant to a specific EU RoHS exemption.

**Green:** TI defines "Green" to mean the content of Chlorine (Cl) and Bromine (Br) based flame retardants meet JS709B low halogen requirements of <=1000ppm threshold. Antimony trioxide based flame retardants must also meet the <=1000ppm threshold requirement.

(3) MSL, Peak Temp. - The Moisture Sensitivity Level rating according to the JEDEC industry standard classifications, and peak solder temperature.

(4) There may be additional marking, which relates to the logo, the lot trace code information, or the environmental category on the device.

(5) Multiple Device Markings will be inside parentheses. Only one Device Marking contained in parentheses and separated by a "~" will appear on a device. If a line is indented then it is a continuation of the previous line and the two combined represent the entire Device Marking for that device.

(6) Lead finish/Ball material - Orderable Devices may have multiple material finish options. Finish options are separated by a vertical ruled line. Lead finish/Ball material values may wrap to two lines if the finish value exceeds the maximum column width.

**Important Information and Disclaimer:**The information provided on this page represents TI's knowledge and belief as of the date that it is provided. TI bases its knowledge and belief on information provided by third parties, and makes no representation or warranty as to the accuracy of such information. Efforts are underway to better integrate information from third parties. TI has taken and continues to take reasonable steps to provide representative and accurate information but may not have conducted destructive testing or chemical analysis on incoming materials and chemicals. TI and TI suppliers consider certain information to be proprietary, and thus CAS numbers and other limited information may not be available for release.

In no event shall TI's liability arising out of such information exceed the total purchase price of the TI part(s) at issue in this document sold by TI to Customer on an annual basis.



**TAPE AND REEL INFORMATION**

**QUADRANT ASSIGNMENTS FOR PIN 1 ORIENTATION IN TAPE**

\*All dimensions are nominal

Device	Package Type	Package Drawing	Pins	SPQ	Reel Diameter (mm)	Reel Width W1 (mm)	A0 (mm)	B0 (mm)	K0 (mm)	P1 (mm)	W (mm)	Pin1 Quadrant
LM48411TL/NOPB	DSBGA	YZR	16	250	178.0	8.4	2.18	2.18	0.76	4.0	8.0	Q1
LM48411TLX/NOPB	DSBGA	YZR	16	3000	178.0	8.4	2.18	2.18	0.76	4.0	8.0	Q1

**TAPE AND REEL BOX DIMENSIONS**

\*All dimensions are nominal

Device	Package Type	Package Drawing	Pins	SPQ	Length (mm)	Width (mm)	Height (mm)
LM48411TL/NOPB	DSBGA	YZR	16	250	208.0	191.0	35.0
LM48411TLX/NOPB	DSBGA	YZR	16	3000	208.0	191.0	35.0

YZR0016

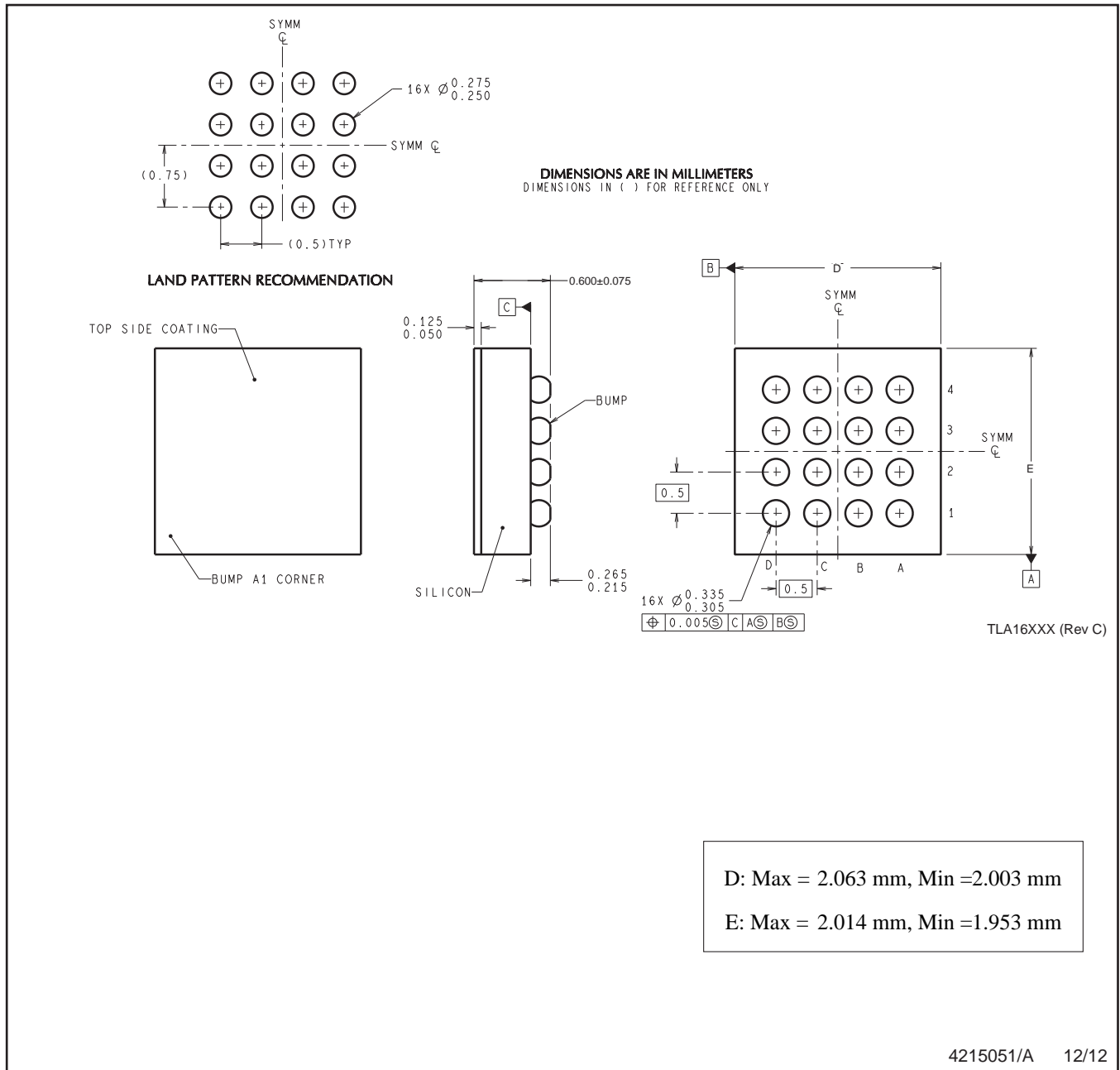

D: Max = 2.063 mm, Min = 2.003 mm  
E: Max = 2.014 mm, Min = 1.953 mm

NOTES: A. All linear dimensions are in millimeters. Dimensioning and tolerancing per ASME Y14.5M-1994.  
B. This drawing is subject to change without notice.

## IMPORTANT NOTICE AND DISCLAIMER

TI PROVIDES TECHNICAL AND RELIABILITY DATA (INCLUDING DATA SHEETS), DESIGN RESOURCES (INCLUDING REFERENCE DESIGNS), APPLICATION OR OTHER DESIGN ADVICE, WEB TOOLS, SAFETY INFORMATION, AND OTHER RESOURCES "AS IS" AND WITH ALL FAULTS, AND DISCLAIMS ALL WARRANTIES, EXPRESS AND IMPLIED, INCLUDING WITHOUT LIMITATION ANY IMPLIED WARRANTIES OF MERCHANTABILITY, FITNESS FOR A PARTICULAR PURPOSE OR NON-INFRINGEMENT OF THIRD PARTY INTELLECTUAL PROPERTY RIGHTS.

These resources are intended for skilled developers designing with TI products. You are solely responsible for (1) selecting the appropriate TI products for your application, (2) designing, validating and testing your application, and (3) ensuring your application meets applicable standards, and any other safety, security, regulatory or other requirements.

These resources are subject to change without notice. TI grants you permission to use these resources only for development of an application that uses the TI products described in the resource. Other reproduction and display of these resources is prohibited. No license is granted to any other TI intellectual property right or to any third party intellectual property right. TI disclaims responsibility for, and you will fully indemnify TI and its representatives against, any claims, damages, costs, losses, and liabilities arising out of your use of these resources.

TI's products are provided subject to [TI's Terms of Sale](#) or other applicable terms available either on [ti.com](https://www.ti.com) or provided in conjunction with such TI products. TI's provision of these resources does not expand or otherwise alter TI's applicable warranties or warranty disclaimers for TI products.

TI objects to and rejects any additional or different terms you may have proposed.

Mailing Address: Texas Instruments, Post Office Box 655303, Dallas, Texas 75265  
Copyright © 2023, Texas Instruments Incorporated