

LM393B、LM2903B、LM193、LM293、LM393 和 LM2903 双路比较器

1 特性

- 全新 **LM393B** 和 **LM2903B**
- 改进了 B 版本的规格
 - 最大额定值：高达 38V
 - ESD 等级 (HBM)：2kV
 - 低输入失调电压：0.37mV
 - 低输入偏置电流：3.5nA
 - 低电源电流：每个比较器 200 μ A
 - 更短的响应时间 (1 μ s)
 - **LM393B** 的工作温度范围
 - 采用 2 x 2mm 微型 WSON 封装
- B 版本可直接取代 LM293、LM393 和 LM2903 的 A 和 V 版本
- 共模输入电压范围包括接地
- 差分输入电压范围等于最大额定电源电压： $\pm 38V$
- 低输出饱和电压
- 输出与 TTL、MOS 和 CMOS 兼容

2 应用

- 扫地机器人
- 单相 UPS
- 服务器 PSU
- 无绳电动工具
- 无线基础设施
- 电器
- 楼宇自动化
- 工厂自动化与控制
- 电机驱动器
- 信息娱乐系统与仪表组

3 说明

LM393B 和 **LM2903B** 器件是业界通用 **LM393** 和 **LM2903** 比较器系列的下一代版本。下一代 B 版本比较器具有更低的失调电压、更高的电源电压能力、更低的电源电流、更低的输入偏置电流和更低的传播延迟，并通过专用 ESD 钳位提高了 2kV ESD 性能和输入耐用性。**LM393B** 和 **LM2903B** 可直接替代 **LM293**、**LM393** 和 **LM2903** (“A” 和 “V” 版本)。

所有器件都包含两个独立的电压比较器，这些比较器可在宽电压范围内由单电源供电运行。静态电流不受电源电压的影响。

器件信息

器件型号	封装 ⁽¹⁾	本体尺寸 (标称值)
LM393B、LM2903B、LM193、LM293、LM293A、LM393、LM393A、LM2903、LM2903V、LM2903AV	SOIC (8)	4.90mm x 3.91mm
LM393B、LM2903B、LM293、LM293A、LM393、LM393A、LM2903	VSSOP (8)	3.00mm x 3.00mm
LM293、LM393、LM393A、LM2903	PDIP (8)	9.81mm x 6.35mm
LM393、LM393A、LM2903	SO (8)	6.20mm x 5.30mm
LM393B、LM2903B、LM393、LM393A、LM2903、LM2903V、LM2903AV	TSSOP (8)	3.00mm x 4.40mm
LM393B、LM2903B	SOT-23 (8)	2.90mm x 1.60mm
LM393B、LM2903B	WSON (8)	2.00mm x 2.00mm

(1) 如需了解所有可用封装，请参阅数据表末尾的可订购产品附录。

系列比较表

规格	LM393B	LM2903B	LM393 LM393A	LM2903	LM2903V LM2903AV	LM193	LM293 LM293A	单位
电源电压	2 至 36	2 至 36	2 至 30	2 至 30	2 至 32	2 至 30	2 至 30	V
总电源电流 (5V 至 36V 最大值)	0.6 至 0.8	0.6 至 0.8	1 至 2.5	1 至 2.5	1 至 2.5	1 至 2.5	1 至 2.5	mA
温度范围	-40 至 85	-40 至 125	0 至 70	-40 至 125	-40 至 125	-55 至 125	-25 至 85	°C
ESD (HBM)	2000	2000	1000	1000	1000	1000	1000	V
失调电压 (整个温度范围内的最大值)	± 4	± 4	± 9 ± 4	± 15	± 15 ± 4	± 9	± 9 ± 4	mV
输入偏置电流 (典型值/最大值)	3.5/25	3.5/25	25/250	25/250	25/250	25/100	25/250	nA
响应时间 (典型值)	1	1	1.3	1.3	1.3	1.3	1.3	μ sec



内容

1 特性	1	5.12 LMx93x 和 LM2903x 的典型特性	11
2 应用	1	6 详细说明	17
3 说明	1	6.1 概述.....	17
4 引脚配置和功能	3	6.2 功能方框图.....	17
5 规格	4	6.3 特性说明.....	17
5.1 绝对最大额定值.....	4	6.4 器件功能模式.....	17
5.2 建议运行条件.....	4	7 应用和实施	18
5.3 热性能信息 : LMx93x 和 LM2903x.....	5	7.1 应用信息.....	18
5.4 ESD 等级.....	5	7.2 典型应用.....	18
5.5 电气特性 LM393B.....	6	8 器件和文档支持	21
5.6 电气特性 LM2903B.....	7	8.1 接收文档更新通知.....	21
5.7 LM393B 和 LM2903B 的开关特性.....	7	8.2 支持资源.....	21
5.8 LM193、LM293 和 LM393 (无 A 后缀) 的电气特性	8	8.3 商标.....	21
5.9 LM293A 和 LM393A 的电气特性.....	9	8.4 静电放电警告.....	21
5.10 LM2903、LM2903V 和 LM2903AV 的电气特性.....	10	8.5 术语表.....	21
5.11 开关特性 : LM193、LM239、LM393、LM2903 (所有 “A” 和 “V” 版本)	10	9 修订历史记录	21
		10 机械、封装和可订购信息	22

4 引脚配置和功能



图 4-1. D、DGK、JG、P、PS、DDF 或 PW 封装 8 引脚 SOIC、VSSOP、PDIP、SO 或 TSSOP 顶视图



将散热焊盘直接连接到 GND 引脚。

图 4-2. DSG 封装 8 引脚 WSON (带有外露焊盘) 顶视图

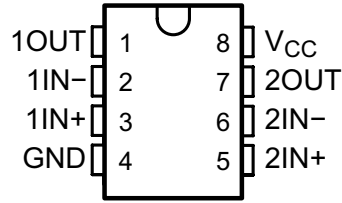
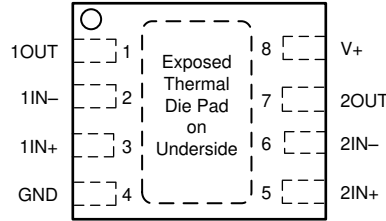
表 4-1. 引脚功能

名称	引脚		I/O	说明
	SOIC、VSSOP、PDIP、SO、DDF 和 TSSOP	DSG		
1OUT	1	1	输出	比较器 1 的输出引脚
1IN -	2	2	输入	比较器 1 的负输入引脚
1IN+	3	3	输入	比较器 1 的正输入引脚
GND	4	4	—	接地
2IN+	5	5	输入	比较器 2 的正输入引脚
2IN-	6	6	输入	比较器 2 的负输入引脚
2OUT	7	7	输出	比较器 2 的输出引脚
V _{CC}	8	8	—	正电源
散热焊盘	—	PAD	—	直接连接到 GND 引脚

5 规格

5.1 绝对最大额定值

在自然通风条件下的工作温度范围内测得 (除非另有说明) ⁽¹⁾

		最小值	最大值	单位
V _{CC} 电源电压 ⁽²⁾	非 B 版本	-0.3	36	V
	仅限 B 版本		38	
V _{ID} 差分输入电压 ⁽³⁾	非 B 版本	-36	36	V
	仅限 B 版本	-38	38	
V _I 输入电压 (任一输入)	非 B 版本	-0.3	36	V
	仅限 B 版本		38	
I _{IK} 输入电流 ⁽⁵⁾			-50	mA
V _O 输出电压	非 B 版本	-0.3	36	V
	仅限 B 版本		38	
I _O 输出电流	非 B 版本		20	mA
	仅限 B 版本		25	
I _{SC} 输出接地短路的持续时间 ⁽⁴⁾			无限	
T _J 运行虚拟结温			150	°C
T _{stg} 贮存温度		-65	150	°C

- (1) 应力超出绝对最大额定值下列出的值可能会对器件造成永久损坏。这些列出的值仅仅是应力额定值，并不表示器件在这些条件下以及在建议运行条件以外的任何其他条件下能够正常运行。长时间处于绝对最大额定条件下可能会影响器件的可靠性。生产过程中没有必要对产品的所有参数进行测试。
- (2) 除差分电压外的所有电压值都是相对于网络接地而言的。
- (3) 差分电压是相对于 IN⁻ 的 IN⁺ 上的值。
- (4) 从输出到 V_{CC} 的短路会导致过热，并且最终会发生损坏。
- (5) 输入电流通过寄生二极管流至接地端并开启寄生晶体管，这会增加 I_{CC} 并可能导致输出不正确。移除输入电流后，将恢复正常运行。

5.2 建议运行条件

在自然通风条件下的工作温度范围内测得 (除非另有说明)

		最小值	最大值	单位
电源电压, V _S = (V ⁺) - (V ⁻)	非 V 后缀器件	2	30	V
	V 后缀器件	2	32	
	“B” 版本器件	2	36	
输入电压范围, V _{IVR}	非 B 后缀器件	0	(V ⁺) - 2.0	V
	“B” 版本器件	-0.1		
环境温度, T _A	LM193	-55	125	°C
	LM2903、LM2903V、LM2903AV、LM2903B	-40	125	
	LM393B	-40	85	
	LM293、LM293A	-25	85	
	LM393、LM393A	0	70	

5.3 热性能信息：LMx93x 和 LM2903x

热指标 ⁽¹⁾		LMx93x、LM2903x					单位
		D (SOIC)	PW (TSSOP)	DGK (VSSOP)	DDF (SOT-23)	DSG (WSON)	
		8 引脚	8 引脚	8 引脚	8 引脚	8 引脚	
R _{θJA}	结至环境热阻	148.5	200.6	193.7	197.9	96.9	°C/W
R _{θJC(top)}	结至外壳（顶部）热阻	90.2	89.6	82.9	119.2	119.0	°C/W
R _{θJB}	结至电路板热阻	91.8	131.3	115.5	115.4	63.1	°C/W
ψ _{JT}	结至顶部特征参数	38.5	22.1	20.8	19.4	12.4	°C/W
ψ _{JB}	结至电路板特征参数	91.1	129.6	113.9	113.7	63.0	°C/W
R _{θJC(bot)}	结至外壳（底部）热阻	-	-	-	-	37.8	°C/W

(1) 有关新旧热指标的更多信息，请参阅 [半导体和 IC 封装热指标](#) 报告。

5.4 ESD 等级

		值	单位
V _(ESD)	静电放电	人体放电模型 (HBM)，符合 ANSI/ESDA/JEDEC JS-001 标准 ⁽¹⁾	±2000
		充电器件模型 (CDM)，符合 JEDEC 规范 JESD22-C101 ⁽²⁾	±1000

(1) JEDEC 文档 JEP155 指出：500V HBM 时能够在标准 ESD 控制流程下安全生产。

(2) JEDEC 文档 JEP157 指出：250V CDM 时能够在标准 ESD 控制流程下安全生产。

5.5 电气特性 LM393B

$V_S = 5V$, $V_{CM} = (V^-)$; $T_A = 25^\circ C$ (除非另有说明)。

参数		测试条件	最小值	典型值	最大值	单位
V_{IO}	输入失调电压	$V_S = 5$ 至 $36V$	-2.5	± 0.37	2.5	mV
		$V_S = 5$ 至 $36V$, $T_A = -40^\circ C$ 至 $+85^\circ C$	-4		4	
	输入失调电压 (仅 DGK 封装)	$V_S = 5$ 至 $36V$	-3.5	± 0.37	3.5	
		$V_S = 5$ 至 $36V$, $T_A = -40^\circ C$ 至 $+85^\circ C$	-5		5	
I_B	输入偏置电流			-3.5	-25	nA
		$T_A = -40^\circ C$ 至 $+85^\circ C$			-50	nA
I_{OS}	输入失调电流		-10	± 0.5	10	nA
		$T_A = -40^\circ C$ 至 $+85^\circ C$	-25		25	nA
V_{CM}	共模范围 (1)	$V_S = 3$ 至 $36V$	(V^-)		$(V^+) - 1.5$	V
		$V_S = 3$ 至 $36V$, $T_A = -40^\circ C$ 至 $+85^\circ C$	(V^-)		$(V^+) - 2.0$	V
A_{VD}	大信号差分电压放大	$V_S = 15V$, $V_O = 1.4V$ 至 $11.4V$; $R_L \geq 15k$ 至 (V^+)	50	200		V/mV
V_{OL}	低电平输出电压 {相对于 (V^-) 的摆幅}	$I_{SINK} \leq 4mA$, $V_{ID} = -1V$		110	400	mV
		$I_{SINK} \leq 4mA$, $V_{ID} = -1V$ $T_A = -40^\circ C$ 至 $+85^\circ C$			550	mV
I_{OH-LKG}	高电平输出漏电流	$(V^+) = V_O = 5V$; $V_{ID} = 1V$		0.1	20	nA
		$(V^+) = V_O = 36V$; $V_{ID} = 1V$		0.3	50	nA
I_{OL}	低电平输出电流	$V_{OL} = 1.5V$; $V_{ID} = -1V$; $V_S = 5V$	6	21		mA
I_Q	静态电流 (所有比较器)	$V_S = 5V$, 空载		400	600	μA
		$V_S = 36V$, 空载, $T_A = -40^\circ C$ 至 $+85^\circ C$		550	800	μA

- (1) 任一输入端的电压不应低于负 0.3V, 否则输出可能不正确, 并且可能产生过大的输入电流。共模电压范围的上限受 $V_{CC} - 2V$ 的限制。不过, 只有一个输入需要处于有效的共模范围之内, 另一个输入可以达到最大 V_{CC} 电平, 比较器会提供适当的输出状态。任一输入或两个输入可以达到最大 V_{CC} 电平而不会造成损坏。

5.6 电气特性 LM2903B

$V_S = 5V$, $V_{CM} = (V_-)$; $T_A = 25^\circ C$ (除非另有说明)。

参数		测试条件	最小值	典型值	最大值	单位
V_{IO}	输入失调电压	$V_S = 5$ 至 $36V$	-2.5	± 0.37	2.5	mV
		$V_S = 5$ 至 $36V$, $T_A = -40^\circ C$ 至 $+125^\circ C$	-4		4	
	输入失调电压 (仅 DGK 封装)	$V_S = 5$ 至 $36V$	-3.5	± 0.37	3.5	
		$V_S = 5$ 至 $36V$, $T_A = -40^\circ C$ 至 $+125^\circ C$	-5		5	
I_B	输入偏置电流			-3.5	-25	nA
		$T_A = -40^\circ C$ 至 $+125^\circ C$			-50	nA
I_{OS}	输入失调电流		-10	± 0.5	10	nA
		$T_A = -40^\circ C$ 至 $+125^\circ C$	-25		25	nA
V_{CM}	共模范围 (1)	$V_S = 3$ 至 $36V$	(V_-)		$(V_+) - 1.5$	V
		$V_S = 3$ 至 $36V$, $T_A = -40^\circ C$ 至 $+125^\circ C$	(V_-)		$(V_+) - 2.0$	V
A_{VD}	大信号差分电压放大	$V_S = 15V$, $V_O = 1.4V$ 至 $11.4V$; $R_L \geq 15k$ 至 (V_+)	50	200		V/mV
V_{OL}	低电平输出电压 {相对于 (V_-) 的摆幅}	$I_{SINK} \leq 4mA$, $V_{ID} = -1V$		110	400	mV
		$I_{SINK} \leq 4mA$, $V_{ID} = -1V$ $T_A = -40^\circ C$ 至 $+125^\circ C$			550	mV
I_{OH-LKG}	高电平输出漏电流	$(V_+) = V_O = 5V$; $V_{ID} = 1V$		0.1	20	nA
		$(V_+) = V_O = 36V$; $V_{ID} = 1V$		0.3	50	nA
I_{OL}	低电平输出电流	$V_{OL} = 1.5V$; $V_{ID} = -1V$; $V_S = 5V$	6	21		mA
I_Q	静态电流 (所有比较器)	$V_S = 5V$, 空载		400	600	μA
		$V_S = 36V$, 空载, $T_A = -40^\circ C$ 至 $+125^\circ C$		550	800	μA

- (1) 任一输入端的电压不应低于负 0.3V, 否则输出可能不正确, 并且可能产生过大的输入电流。共模电压范围的上限受 $V_{CC} - 2V$ 的限制。不过, 只有一个输入需要处于有效的共模范围之内, 另一个输入可以达到最大 V_{CC} 电平, 比较器会提供适当的输出状态。任一输入或两个输入可以达到最大 V_{CC} 电平而不会造成损坏。

5.7 LM393B 和 LM2903B 的开关特性

$V_S = 5V$ 、 $V_O_{PULLUP} = 5V$ 、 $V_{CM} = V_S/2$ 、 $C_L = 15pF$ 、 $R_L = 5.1k \text{ Ohm}$ 、 $T_A = 25^\circ C$ (除非另有说明)。

参数		测试条件	最小值	典型值	最大值	单位
$t_{\text{响应}}$	高电平到低电平的传播延迟时间; TTL 输入信号 (1)	TTL 输入, $V_{ref} = 1.4V$		300		ns
$t_{\text{响应}}$	高电平到低电平的传播延迟时间; 小规模输入信号 (1)	输入过驱 = 5mV, 输入阶跃 = 100mV		1000		ns

- (1) 高电平到低电平以及低电平到高电平是指输入端的转换。

5.8 LM193、LM293 和 LM393 (无 A 后缀) 的电气特性

在指定自然通风温度下, $V_{CC} = 5V$ (除非另有说明)

参数	测试条件		T_A ⁽¹⁾	LM193			LM293 LM393			单位
				最小值	典型值	最大值	最小值	典型值	最大值	
V_{IO} 输入失调电压	$V_{CC} = 5V$ 至 $30V$, $V_{IC} = V_{ICRmin}$, $V_O = 1.4V$		25°C	2	5	2	5		mV	
			完整范围	9			9			
I_{IO} 输入失调电流	$V_O = 1.4V$		25°C	3	25	5	50		nA	
			完整范围	100			250			
I_{IB} 输入偏置电流	$V_O = 1.4V$		25°C	-25	-100	-25	-250		nA	
			完整范围	-300			-400			
V_{ICR} 共模输入电压范围 ⁽²⁾			25°C	0 至 $V_{CC} - 1.5$		0 至 $V_{CC} - 1.5$			V	
			完整范围	0 至 $V_{CC} - 2$		0 至 $V_{CC} - 2$				
A_{VD} 大信号差分电压放大	$V_{CC} = 15V$, $V_O = 1.4V$ 至 $11.4V$, $R_L \geq 15k\Omega$ 至 V_{CC}		25°C	50	200	50	200		V/mV	
I_{OH} 高电平输出电流	$V_{OH} = 5V$	$V_{ID} = 1V$	25°C	0.1			0.1	50	nA	
	$V_{OH} = 30V$	$V_{ID} = 1V$	完整范围	1			1		μA	
V_{OL} 低电平输出电压	$I_{OL} = 4mA$, $V_{ID} = -1V$		25°C	150	400	130	400		mV	
			完整范围	700			700			
I_{OL} 低电平输出电流	$V_{OL} = 1.5V$,	$V_{ID} = -1V$	25°C	6			6		mA	
I_{CC} 电源电流	$R_L = \infty$		$V_{CC} = 5V$	25°C	0.8	1	0.45	1	mA	
			$V_{CC} = 30V$	完整范围	2.5			0.55		2.5

- (1) LM193 的完整范围 (最小值或最大值) 为 $-55^\circ C$ 至 $125^\circ C$, LM293 的完整范围为 $-25^\circ C$ 至 $85^\circ C$ 。除非另有说明, 否则所有特性均在零共模输入电压下测量。
- (2) 任一输入端的电压不应低于负 $0.3V$, 否则输出可能不正确, 并且可能产生过大的输入电流。共模电压范围的上限受 $V_{CC} - 2V$ 的限制。不过, 只有一个输入需要处于有效的共模范围之内, 另一个输入可以达到最大 V_{CC} 电平, 比较器会提供适当的输出状态。任一输入或两个输入可以达到最大 V_{CC} 电平而不会造成损坏。

5.9 LM293A 和 LM393A 的电气特性

在指定自然通风温度下, $V_{CC} = 5V$ (除非另有说明)

参数	测试条件	T_A (1)	LM293A LM393A		单位
			最小值	典型值 最大值	
V_{IO} 输入失调电压	$V_{CC} = 5V$ 至 $30V$, $V_O = 1.4V$ $V_{IC} = V_{ICR(min)}$	$25^\circ C$	1	2	mV
		完整范围	4		
I_{IO} 输入失调电流	$V_O = 1.4V$	$25^\circ C$	5	50	nA
		完整范围	150		
I_{IB} 输入偏置电流	$V_O = 1.4V$	$25^\circ C$	-25	-250	nA
		完整范围	-400		
V_{ICR} 共模输入电压范围(2)		$25^\circ C$	0 至 $V_{CC} - 1.5$		V
		完整范围	0 至 $V_{CC} - 2$		
A_{VD} 大信号差分电压放大	$V_{CC} = 15V$, $V_O = 1.4V$ 至 $11.4V$, $R_L \geq 15k\Omega$ 至 V_{CC}	$25^\circ C$	50	200	V/mV
I_{OH} 高电平输出电流	$V_{OH} = 5V$, $V_{ID} = 1V$	$25^\circ C$	0.1	50	nA
	$V_{OH} = 30V$, $V_{ID} = 1V$	完整范围	1		μA
V_{OL} 低电平输出电压	$I_{OL} = 4mA$, $V_{ID} = -1V$	$25^\circ C$	110	400	mV
		完整范围	700		
I_{OL} 低电平输出电流	$V_{OL} = 1.5V$, $V_{ID} = -1V$,	$25^\circ C$	6		mA
I_{CC} 电源电流	$R_L = \infty$	$V_{CC} = 5V$	0.60	1	mA
		$V_{CC} = 30V$	完整范围	0.72 2.5	

- (1) LM293A 的完整范围 (最小值或最大值) 为 $-25^\circ C$ 至 $85^\circ C$, LM393A 的完整范围为 $0^\circ C$ 至 $70^\circ C$ 。除非另有说明, 否则所有特性均在零共模输入电压下测量。
- (2) 任一输入端的电压不应低于负 $0.3V$, 否则输出可能不正确, 并且可能产生过大的输入电流。共模电压范围的上限受 $V_{CC} - 2V$ 的限制。不过, 只有一个输入需要处于有效的共模范围之内, 另一个输入可以达到最大 V_{CC} 电平, 比较器能提供适当的输出状态。任一输入或两个输入可以达到最大 V_{CC} 电平而不会造成损坏。

5.10 LM2903、LM2903V 和 LM2903AV 的电气特性

在指定自然通风温度下， $V_{CC} = 5V$ (除非另有说明)

参数	测试条件	T_A (1)	LM2903、LM2903V			LM2903AV			单位	
			最小值	典型值	最大值	最小值	典型值	最大值		
V_{IO} 输入失调电压	$V_{CC} = 5V$ 至最大值(2), $V_O = 1.4V$, $V_{IC} = V_{ICR(min)}$,	25°C		2	7		1	2	mV	
		完整范围			15			4		
I_{IO} 输入失调电流	$V_O = 1.4V$	25°C		5	50		5	50	nA	
		完整范围			200			200		
I_{IB} 输入偏置电流	$V_O = 1.4V$	25°C		-25	-250		-25	-250	nA	
		完整范围			-500			-500		
V_{ICR} 共模输入电压范围(3)		25°C		0 至 $V_{CC} - 1.5$			0 至 $V_{CC} - 1.5$		V	
		完整范围		0 至 $V_{CC} - 2$			0 至 $V_{CC} - 2$			
A_{VD} 大信号差分电压放大	$V_{CC} = 15V$, $V_O = 1.4V$ 至 11.4V, $R_L \geq 15k\Omega$ 至 V_{CC}	25°C		25	100		25	100	V/mV	
I_{OH} 高电平输出电流	$V_{OH} = 5V$, $V_{ID} = 1V$	25°C		0.1	50		0.1	50	nA	
	$V_{OH} = V_{CC}$ 最大值(2), $V_{ID} = 1V$	完整范围			1			1	μA	
V_{OL} 低电平输出电压	$I_{OL} = 4mA$, $V_{ID} = -1V$,	25°C		150	400		150	400	mV	
		完整范围			700			700		
I_{OL} 低电平输出电流	$V_{OL} = 1.5V$, $V_{ID} = -1V$	25°C		6			6		mA	
I_{CC} 电源电流	$R_L = \infty$	$V_{CC} = 5V$	25°C		0.8	1		0.8	1	mA
		$V_{CC} =$ 最大值	完整范围			2.5			2.5	

- (1) LM2903 的完整范围 (最小值或最大值) 为 $-40^\circ C$ 至 $125^\circ C$ 。除非另有说明，否则所有特性均在零共模输入电压下测量。
 (2) 在非 V 型器件中， V_{CC} 最大值 = 30V；对于 V 后缀器件， V_{CC} 最大值 = 32V。
 (3) 任一输入端的电压不应低于负 0.3V，否则输出可能不正确，并且可能产生过大的输入电流。共模电压范围的上限受 $V_{CC} - 2V$ 的限制。不过，只有一个输入需要处于有效的共模范围之内，另一个输入可以达到最大 V_{CC} 电平，比较器会提供适当的输出状态。任一输入或两个输入可以达到最大 V_{CC} 电平而不会造成损坏。

5.11 开关特性：LM193、LM239、LM393、LM2903 (所有“A”和“V”版本)

$V_{CC} = 5V$, $T_A = 25^\circ C$

参数	测试条件	典型值	单位
响应时间	R_L 通过 5.1k Ω 连接到 5V, $C_L = 15pF$ (1)(2)	具有 5mV 过驱的 100mV 输入阶跃	1.3
		TTL 电平输入阶跃	0.3

- (1) C_L 包括探针和夹具电容。
 (2) 指定的响应时间是输入阶跃函数与输出超过 1.4V 的那一时刻之间的间隔。

5.12 LMx93x 和 LM2903x 的典型特性

$T_A = 25^\circ\text{C}$, $V_S = 5\text{V}$, $R_{\text{PULLUP}} = 5.1\text{k}$, $C_L = 15\text{pF}$, $V_{\text{CM}} = 0\text{V}$, $V_{\text{UNDERDRIVE}} = 100\text{mV}$, $V_{\text{OVERDRIVE}} = 100\text{mV}$ (除非另有说明)。



图 5-1. 总电源电流与电源电压之间的关系



图 5-2. 3V 下总电源电流与输入电压之间的关系

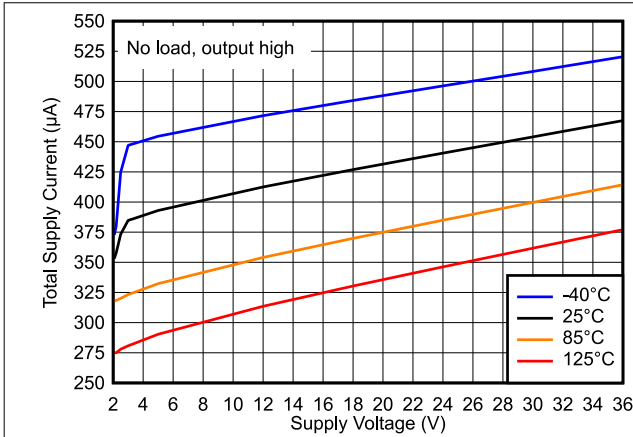

图 5-3. 3.3V 下总电源电流与输入电压之间的关系

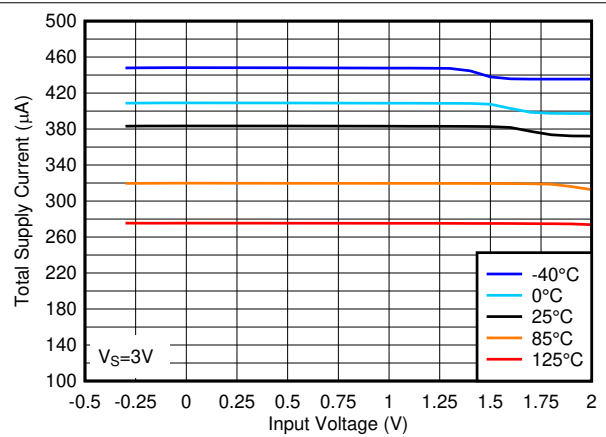

图 5-4. 5V 下总电源电流与输入电压之间的关系

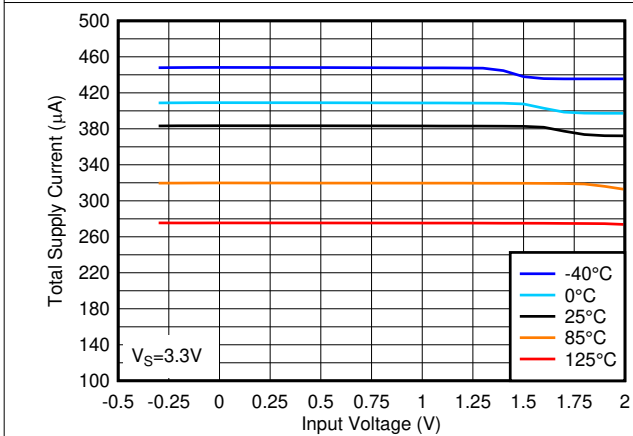

图 5-5. 12V 下总电源电流与输入电压之间的关系

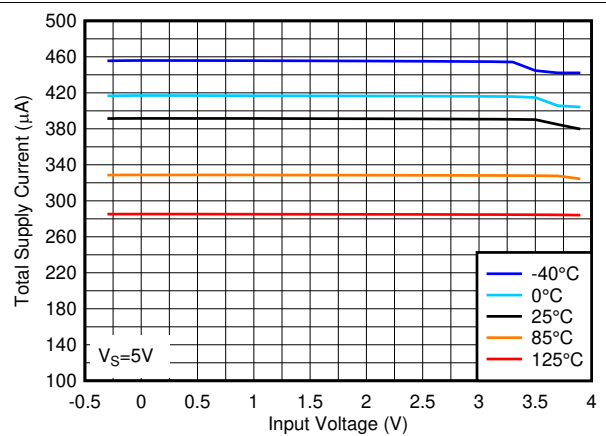

图 5-6. 36V 下总电源电流与输入电压之间的关系

5.12 LMx93x 和 LM2903x 的典型特性 (续)

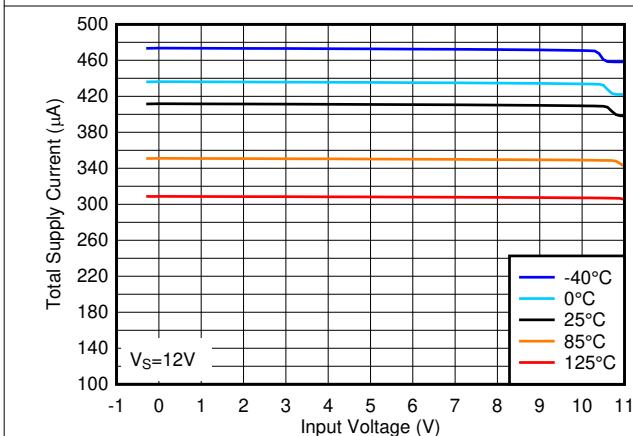
$T_A = 25^\circ\text{C}$, $V_S = 5\text{V}$, $R_{\text{PULLUP}} = 5.1\text{k}$, $C_L = 15\text{pF}$, $V_{\text{CM}} = 0\text{V}$, $V_{\text{UNDERDRIVE}} = 100\text{mV}$, $V_{\text{OVERDRIVE}} = 100\text{mV}$ (除非另有说明)。

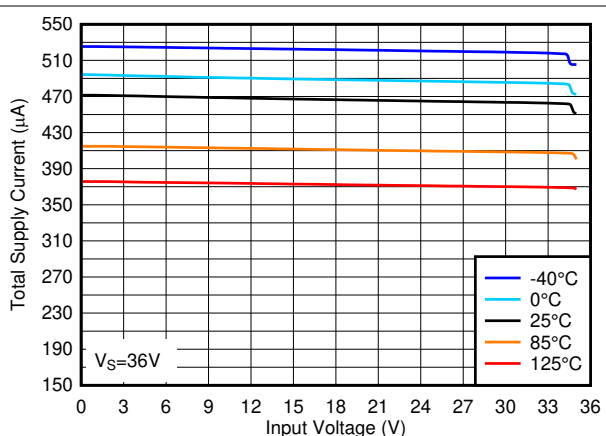

图 5-7. 3V 下输入失调电压与温度之间的关系



图 5-8. 5V 下输入失调电压与温度之间的关系

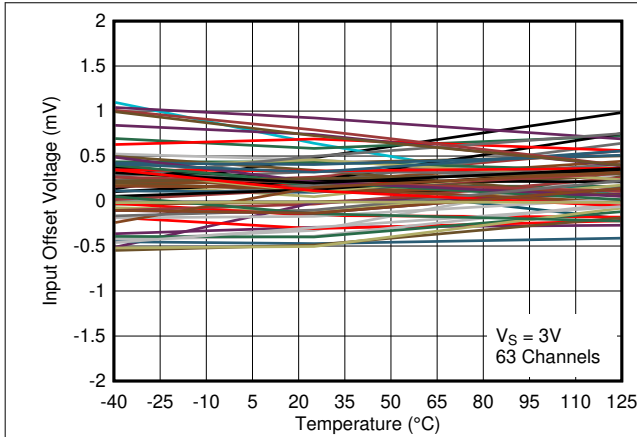

图 5-9. 12V 下输入失调电压与温度之间的关系

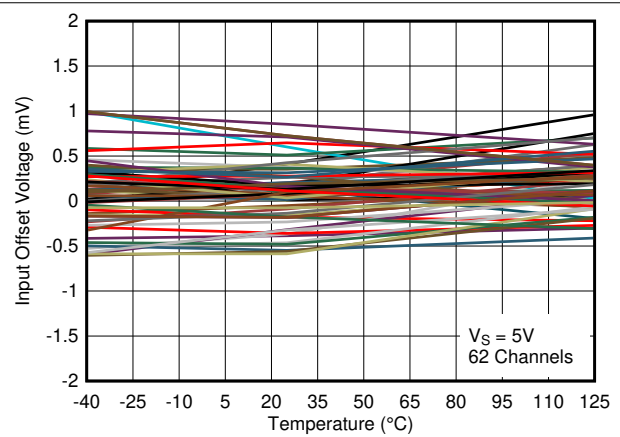

图 5-10. 36V 下输入失调电压与温度之间的关系

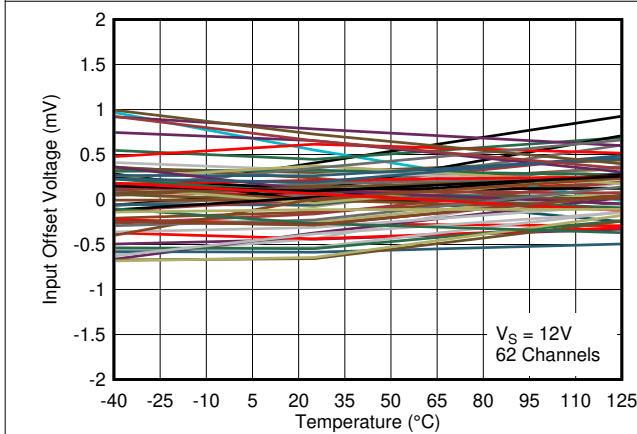

图 5-11. -40°C 下输入失调电压与电源电压之间的关系

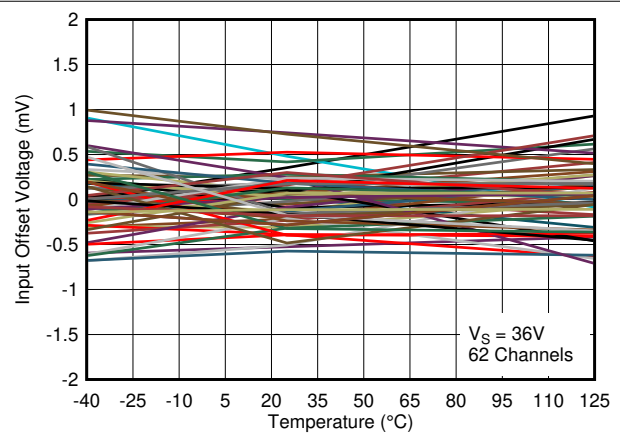

图 5-12. 25°C 下输入失调电压与电源电压之间的关系

5.12 LMx93x 和 LM2903x 的典型特性 (续)

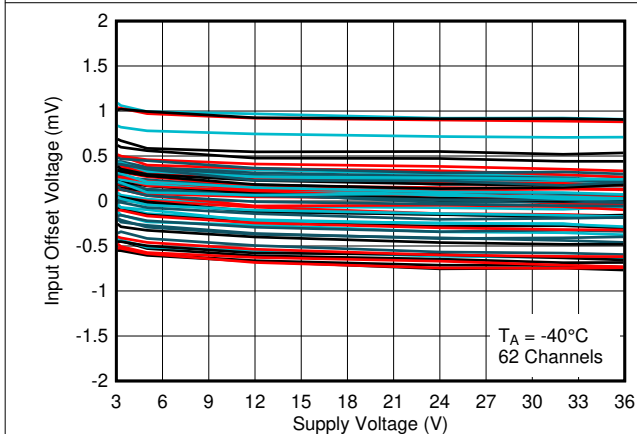
$T_A = 25^\circ\text{C}$, $V_S = 5\text{V}$, $R_{\text{PULLUP}} = 5.1\text{k}$, $C_L = 15\text{pF}$, $V_{\text{CM}} = 0\text{V}$, $V_{\text{UNDERDRIVE}} = 100\text{mV}$, $V_{\text{OVERDRIVE}} = 100\text{mV}$ (除非另有说明)。

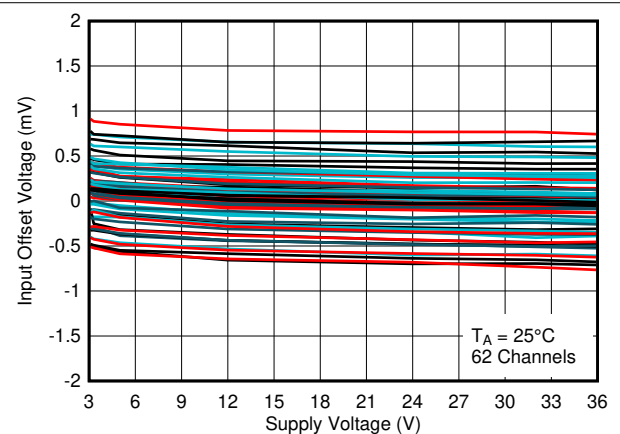

图 5-13. 85°C 下输入失调电压与电源电压之间的关系



图 5-14. 125°C 下输入失调电压与电源电压之间的关系

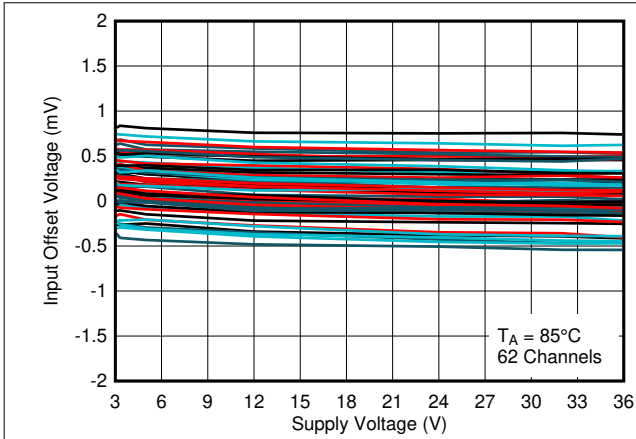

图 5-15. 输入偏置电流与电源电压之间的关系

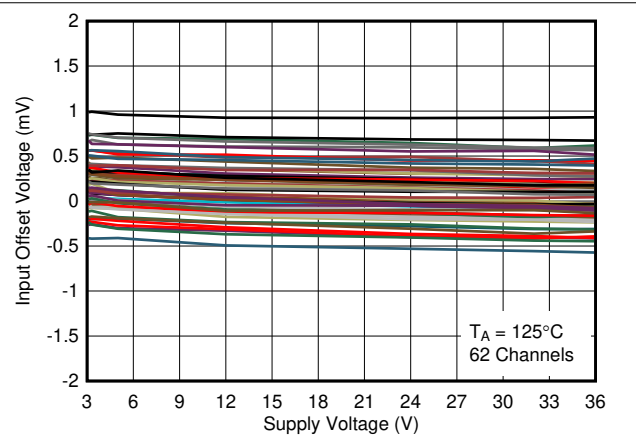

图 5-16. 5V 下输入偏置电流与输入电压之间的关系

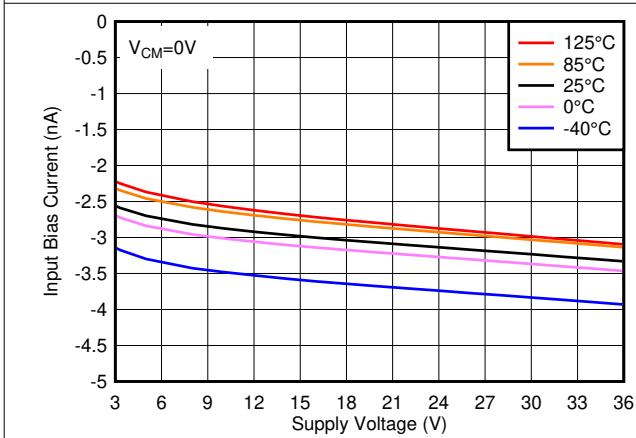

图 5-17. 12V 下输入偏置电流与输入电压之间的关系

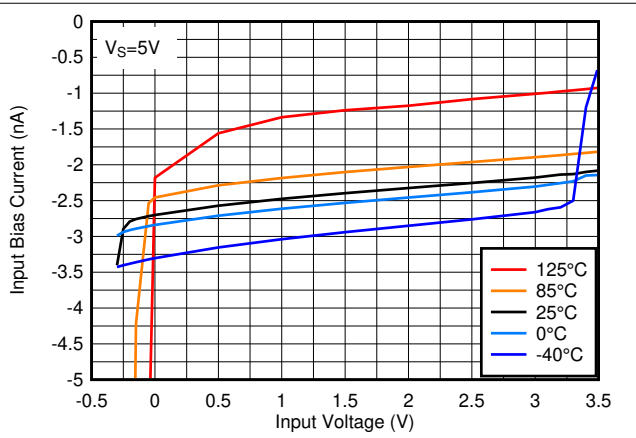

图 5-18. 36V 下输入偏置电流与输入电压之间的关系

5.12 LMx93x 和 LM2903x 的典型特性 (续)

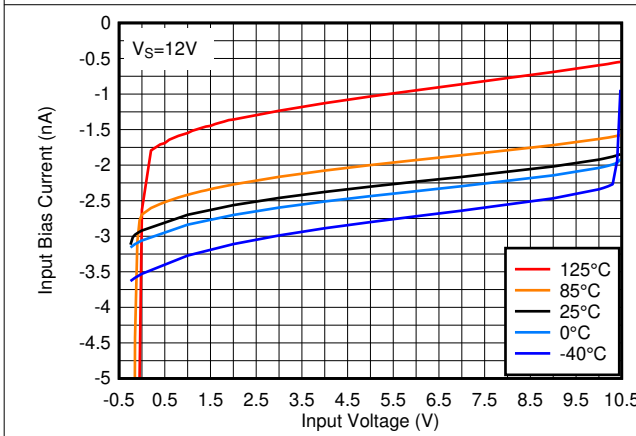
$T_A = 25^\circ\text{C}$, $V_S = 5\text{V}$, $R_{\text{PULLUP}} = 5.1\text{k}$, $C_L = 15\text{pF}$, $V_{\text{CM}} = 0\text{V}$, $V_{\text{UNDERDRIVE}} = 100\text{mV}$, $V_{\text{OVERDRIVE}} = 100\text{mV}$ (除非另有说明)。

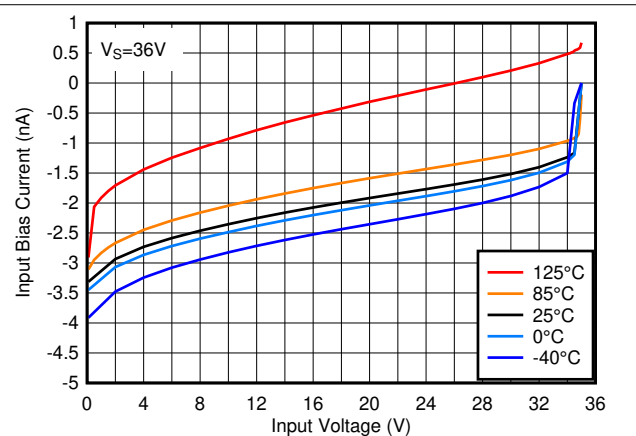

图 5-19. 3V 下输出低电平电压与输出灌电流之间的关系



图 5-20. 5V 下输出低电平电压与输出灌电流之间的关系

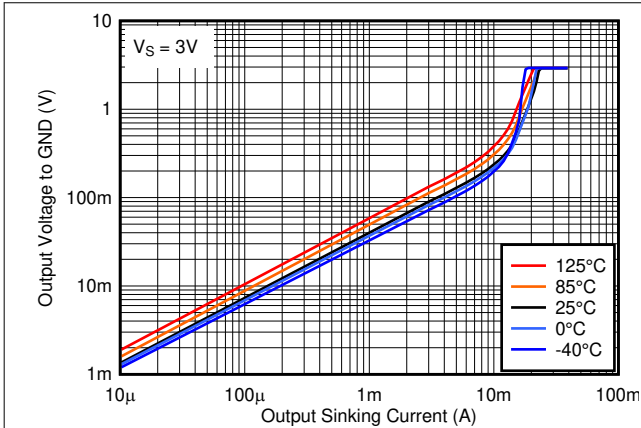

图 5-21. 12V 下输出低电平电压与输出灌电流之间的关系

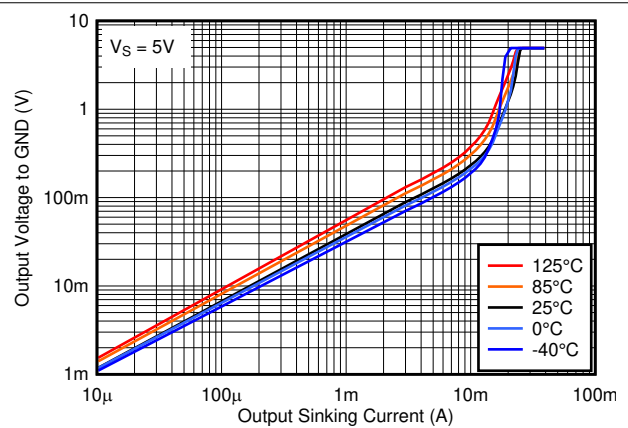

图 5-22. 36V 下输出低电平电压与输出灌电流之间的关系

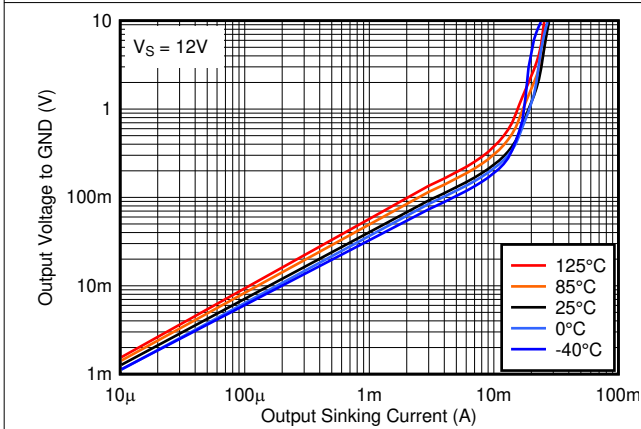

图 5-23. 5V 下输出高电平漏电流与温度之间的关系

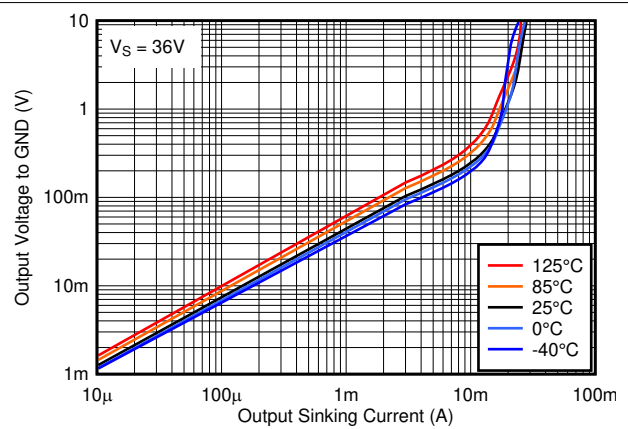

图 5-24. 36V 下输出高电平漏电流与温度之间的关系

5.12 LMx93x 和 LM2903x 的典型特性 (续)

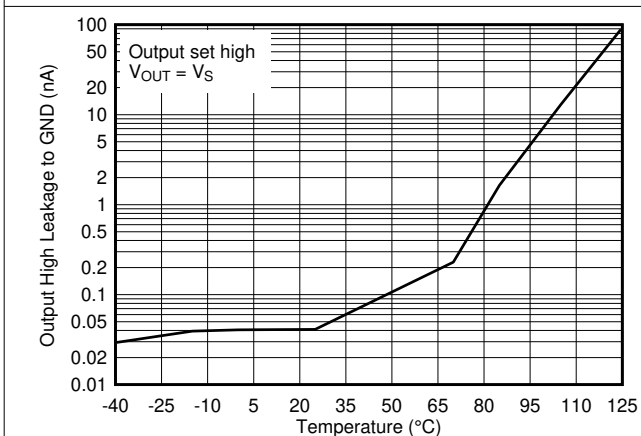
$T_A = 25^\circ\text{C}$, $V_S = 5\text{V}$, $R_{\text{PULLUP}} = 5.1\text{k}$, $C_L = 15\text{pF}$, $V_{\text{CM}} = 0\text{V}$, $V_{\text{UNDERDRIVE}} = 100\text{mV}$, $V_{\text{OVERDRIVE}} = 100\text{mV}$ (除非另有说明)。

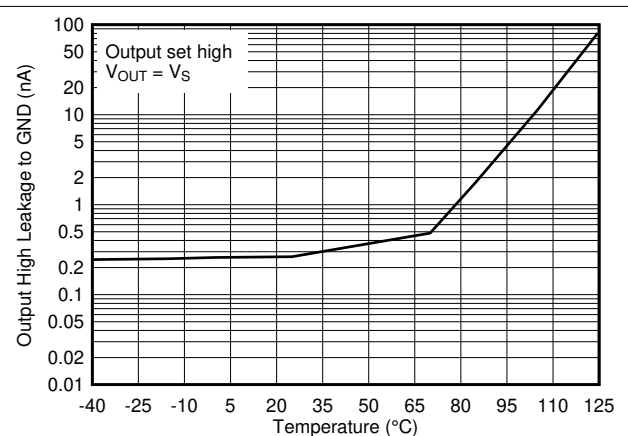

图 5-25. 高电平至低电平传播延迟与输入过驱电压之间的关系, 5V



图 5-26. 低电平至高电平传播延迟与输入过驱电压之间的关系, 5V

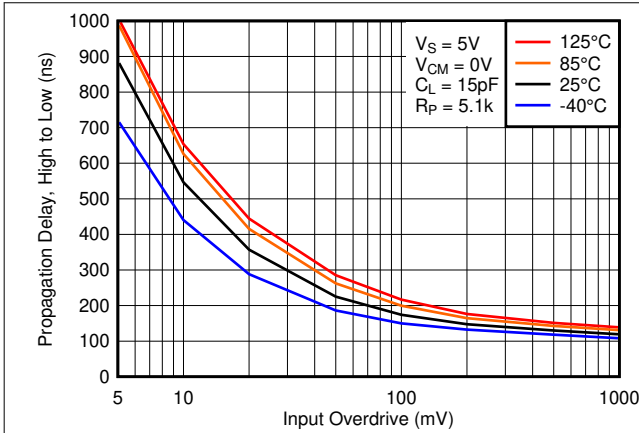

图 5-27. 高电平至低电平传播延迟与输入过驱电压之间的关系, 12V

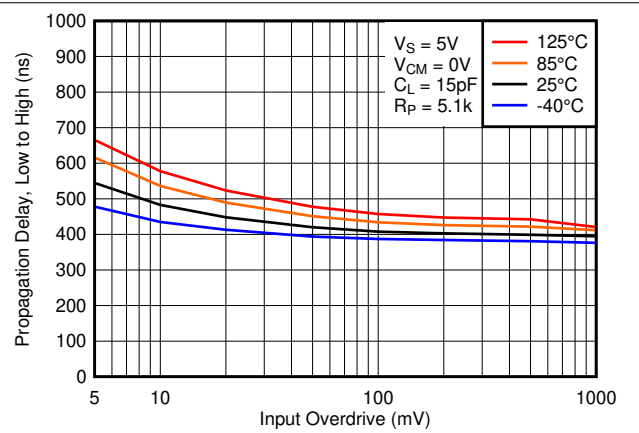

图 5-28. 低电平至高电平传播延迟与输入过驱电压之间的关系, 12V

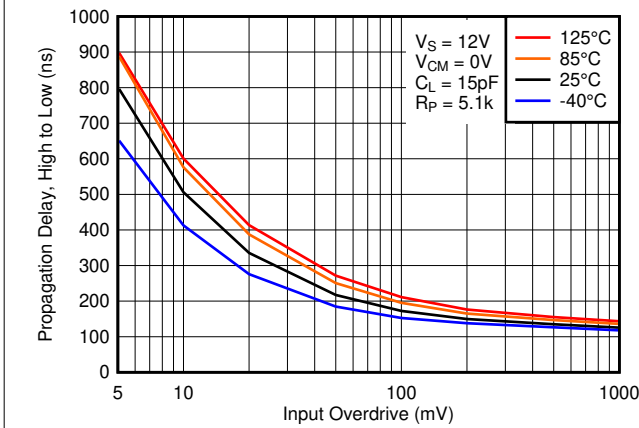

图 5-29. 高电平至低电平传播延迟与输入过驱电压之间的关系, 36V

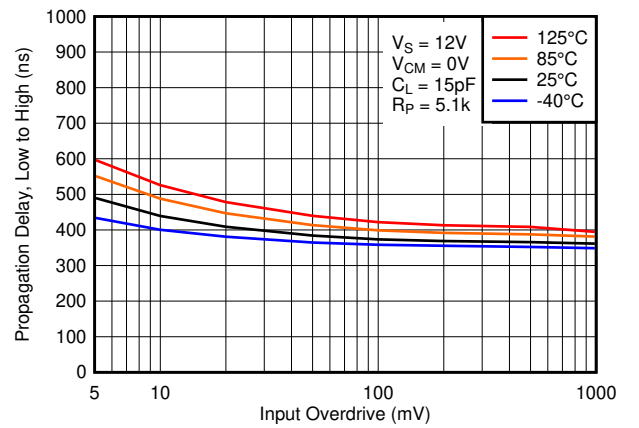

图 5-30. 低电平至高电平传播延迟与输入过驱电压之间的关系, 36V

5.12 LMx93x 和 LM2903x 的典型特性 (续)

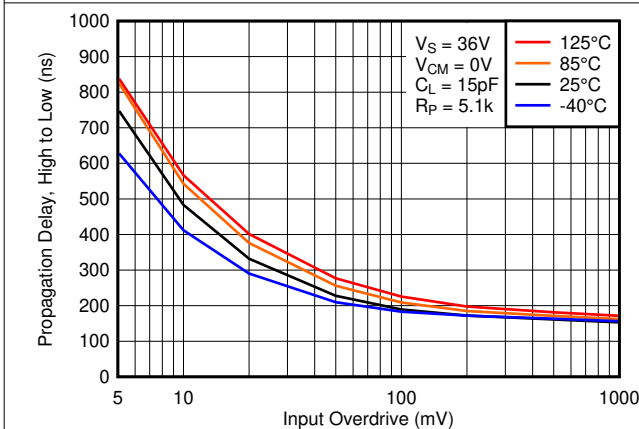
$T_A = 25^\circ\text{C}$, $V_S = 5\text{V}$, $R_{\text{PULLUP}} = 5.1\text{k}$, $C_L = 15\text{pF}$, $V_{\text{CM}} = 0\text{V}$, $V_{\text{UNDERDRIVE}} = 100\text{mV}$, $V_{\text{OVERDRIVE}} = 100\text{mV}$ (除非另有说明)。

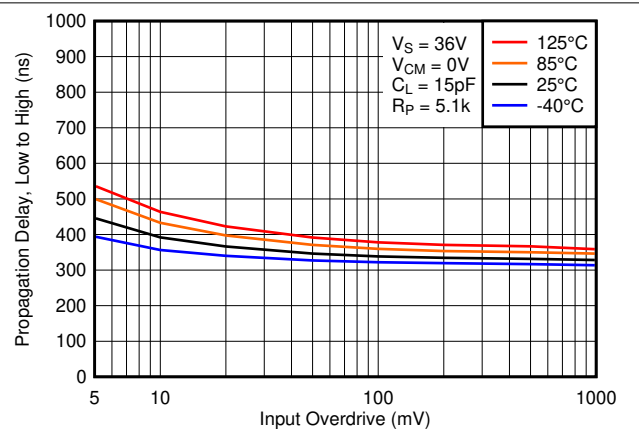

图 5-31. 高电平至低电平转换时各种过驱的响应时间



图 5-32. 低电平至高电平转换时各种过驱的响应时间

6 详细说明

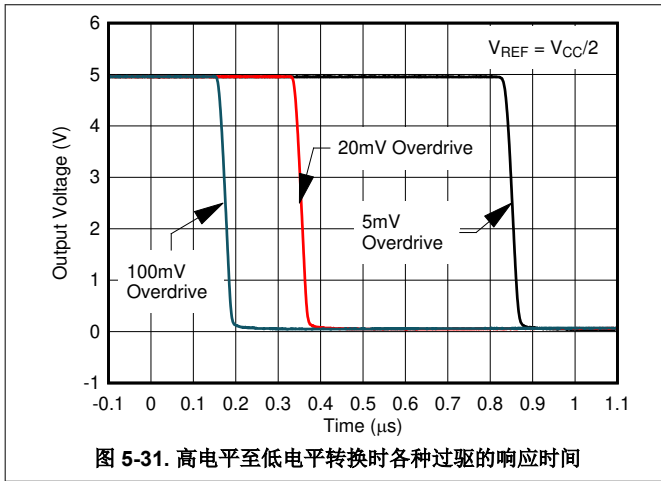
6.1 概述

这些双路比较器能够在电源引脚上以高达 36V 的绝对最大电压 (“B” 版本为 38V) 运行。这些器件已经证明可广泛应用于各种应用。这是因为这些器件具有非常宽的电源电压范围、低 I_q 和快速响应。

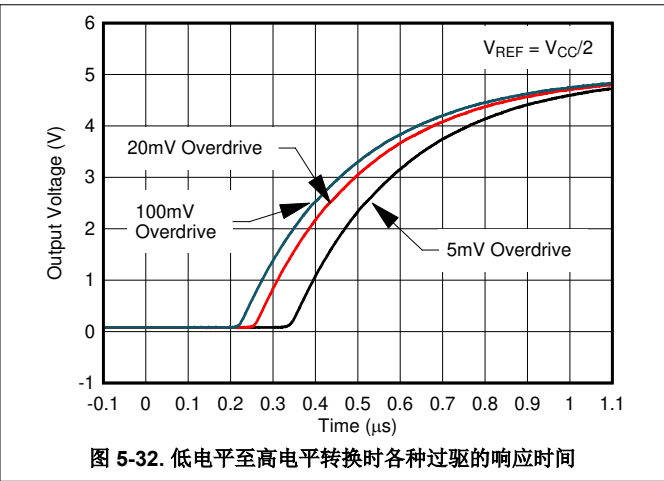
开路集电极输出使用户能够对 VCC 的所需逻辑电平独立进行电平转换，同时还在多个输出连接在一起时启用 AND 功能。

6.2 功能方框图



图 6-1. 原理图 (每个比较器)

6.3 特性说明

该比较器包含一个 PNP 达林顿对输入，使器件能够获得非常高的增益，能快速响应且在最小的输入偏置电流下运行。输入达林顿对限制了输入共模电压能力，使比较器在接地至 $V_{CC} - 2V$ 的过温条件下准确运行。在 Q3 周围添加了一个钳位，以模拟两个输入超出原装经典硅输入电压范围时的情况。

输出包含一个开漏 NPN (下拉或低侧) 晶体管。当负输入电压高于正输入电压和失调电压时，输出 NPN 会灌入电流。 V_{OL} 是电阻性的，并且与输出电流成比例。请参阅“输出低电压与输出灌电流间的关系”图，了解有关输出电流的 V_{OL} 值。

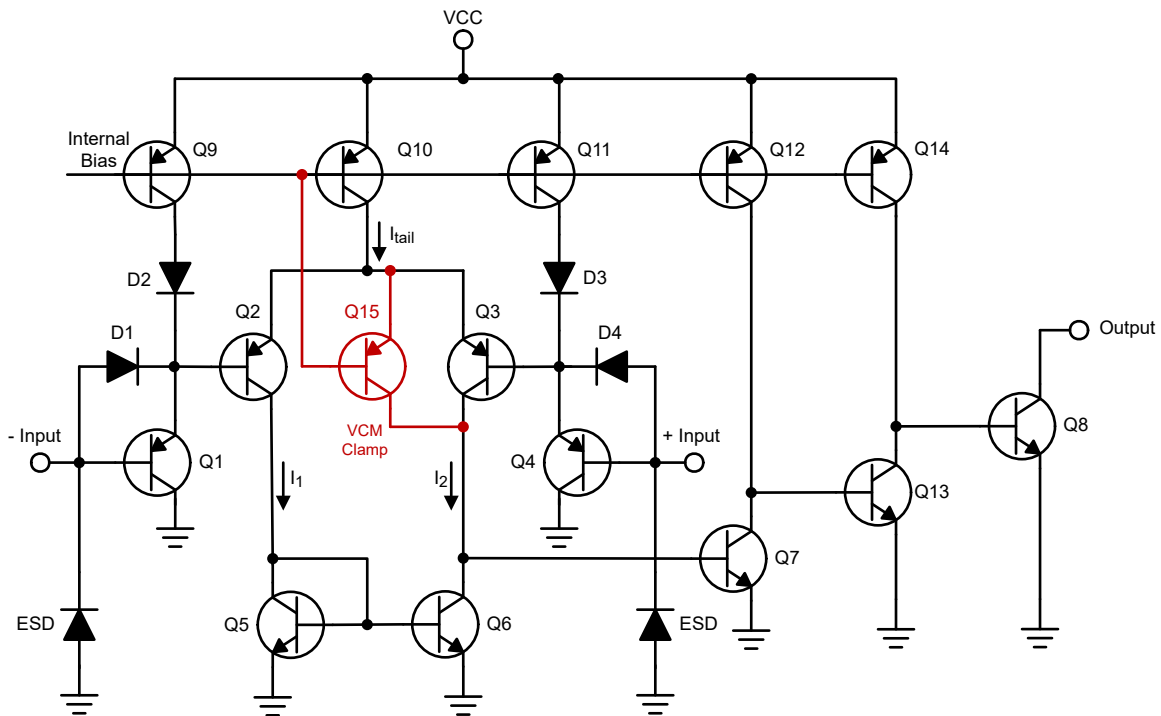
6.4 器件功能模式

6.4.1 电压比较

该器件仅作为电压比较器运行，其能比较正负引脚之间的差分电压，并根据输入差分极性输出逻辑低电平或高阻抗 (能上拉的逻辑高电平)。

7 应用和实施

备注

以下应用部分中的信息不属于 TI 器件规格的范围，TI 不担保其准确性和完整性。TI 的客户应负责确定器件是否适用于其应用。客户应验证并测试其设计，以确保系统功能。

7.1 应用信息

该器件通常用于将单个信号与基准信号进行比较，或将两个信号相互比较。许多用户利用开漏输出将比较逻辑输出驱动为 MCU 或逻辑器件的逻辑电压电平。宽电源范围和高电压功能使该比较器成为向更高或更低电压进行电平转换的理想选择。

7.2 典型应用



图 7-1. 单端和差分比较器配置

7.2.1 设计要求

本设计示例使用表 7-1 中所列的参数作为输入参数。

表 7-1. 设计参数

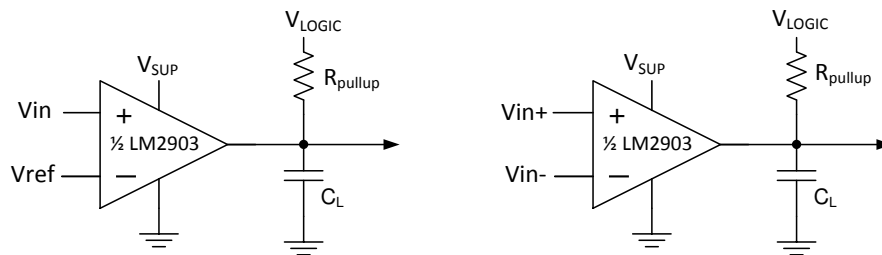
设计参数	示例值
输入电压范围	0V 至 $V_{sup}-2V$
电源电压	4.5V 至 V_{CC} 最大值
逻辑电源电压	0V 至 V_{CC} 最大值
输出电流 (R_{PULLUP})	1 μ A 至 4mA
输入过驱电压	100mV
基准电压	2.5V
负载电容 (C_L)	15pF

7.2.2 详细设计过程

在一般比较器应用中使用该器件时，请确定以下参数：

- 输入电压范围
- 最小过驱电压
- 输出和驱动电流
- 响应时间

7.2.2.1 输入电压范围

选择输入电压范围时，必须将输入共模电压范围 (V_{ICR}) 考虑在内。如果温度低于 25°C，则 V_{ICR} 范围为 0V 至 $V_{CC} - 2.0V$ 。这样将输入电压范围限制为最高 $V_{CC} - 2.0V$ ，最低 0V。超出此范围的操作可能会导致比较出错。

以下是输入电压情况及其输出列表：

1. 当 IN- 和 IN+ 都处于共模范围内时：
 - a. 如果 IN- 高于 IN+ 和失调电压，则输出为低电平，而且输出晶体管会灌入电流
 - b. 如果 IN- 低于 IN+ 和失调电压，则输出为高阻抗，输出晶体管不导通
2. 当 IN- 高于共模且 IN+ 处于共模范围内时，输出为低电平，输出晶体管灌入电流
3. 当 IN+ 高于共模且 IN- 处于共模范围内时，输出为高阻抗，输出晶体管不导通
4. 当 IN- 和 IN+ 都高于共模时，请参阅 [LM339](#)、[LM393](#)、[TL331](#) 系列比较器 (包括全新 B 版本) 应用设计指南的第 2 部分。

7.2.2.2 最小过驱电压

过驱电压是在失调电压 (V_{IO}) 上比较器正负输入之间产生的差分电压。若要进行准确的比较，过驱电压 (V_{OD}) 必须高于输入失调电压 (V_{IO})。过驱电压还可以决定比较器的响应时间，响应时间随着过驱的增加而缩短。[图 7-2](#) 和 [图 7-3](#) 显示了相对于过驱电压的正负响应时间。

7.2.2.3 输出和驱动电流

输出电流由负载/上拉电阻和逻辑/上拉电压决定。输出电流从比较器中产生输出低电压 (V_{OL})。其中 V_{OL} 与输出电流成正比。参阅部分的 [LMx93x](#) 和 [LM2903x](#) 的典型特性 输出低电平与灌电流间的关系图，按照输出电流确定 V_{OL} 。

输出电流也会影响瞬态响应。有关更多信息，请参阅 [节 7.2.2.4](#)。

7.2.2.4 响应时间

响应时间是输入过驱的函数。请参阅 [应用曲线](#) 以了解典型的响应时间。上升和下降时间可以由负载电容 (C_L)、负载/上拉电阻 (R_{PULLUP}) 和等效集电极-发射极电阻 (R_{CE}) 确定。

- 上升时间 (τ_R) 约为 $\tau_R = R_{PULLUP} \times C_L$
- 下降时间 (τ_F) 约为 $\tau_F = R_{CE} \times C_L$
 - R_{CE} 可通过以下方式确定，即在所需温度下 [图 5-20](#) 获得线性区域的斜率或者将 V_{OL} 除以 I_{out}

7.2.3 应用曲线

以下曲线是在 V_{CC} 和 V_{Logic} 为 5V、 $R_{PULLUP} = 5.1k\Omega$ 和 50pF 观测仪器探头条件下生成的。



图 7-2. 各种过驱的响应时间 (正转换)



图 7-3. 各种过驱的响应时间 (负转换)

7.2.4 电源相关建议

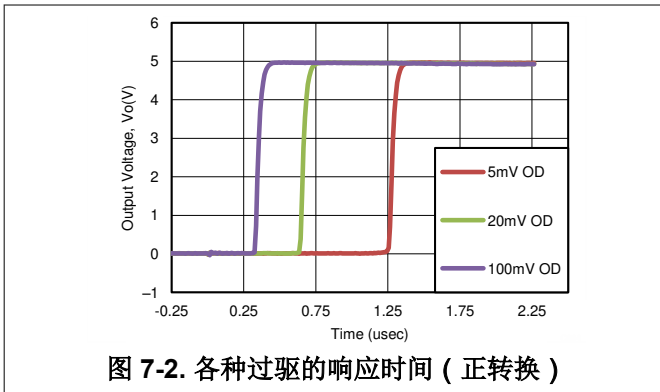
对于具有噪声或交流输入的快速响应和比较应用，TI 建议在电源引脚上使用旁路电容器来抑制电源电压的任何变化。这种变化会侵蚀比较器的输入共模范围，并产生不准确的比较结果。

7.2.5 布局

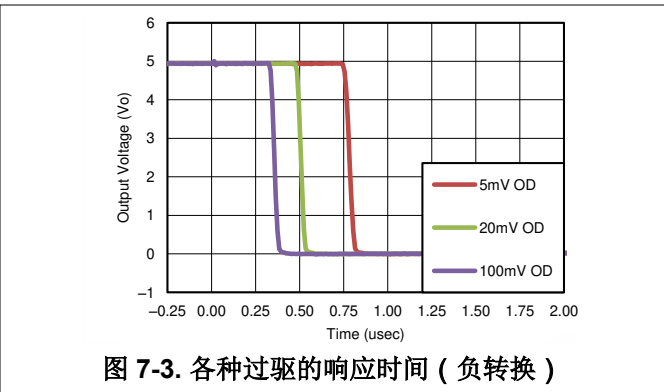
7.2.5.1 布局指南

在没有迟滞的精确比较器应用中，务必保持电源稳定，并将噪声和短时脉冲波干扰降至最低，这一点十分重要。最佳做法是在电源电压和接地之间添加一个旁路电容器。这可以在正电源和负电源（如果可用）上实现。如果未使用负电源，则不要在 IC 的 GND 引脚和系统接地之间放置电容器。

尽量减少输出和反相输入之间的耦合，以防止输出振荡。除非输出和反相输入引线之间存在 V_{CC} 或 GND 引线，否则请勿并行布置输出和反相输入引线，以减少耦合。向输入端添加串联电阻时，将电阻器放在靠近器件的位置。

7.2.5.2 布局示例



图 7-4. LM2903 布局示例

8 器件和文档支持

8.1 接收文档更新通知

要接收文档更新通知，请导航至 ti.com 上的器件产品文件夹。点击 [通知](#) 进行注册，即可每周接收产品信息更改摘要。有关更改的详细信息，请查看任何已修订文档中包含的修订历史记录。

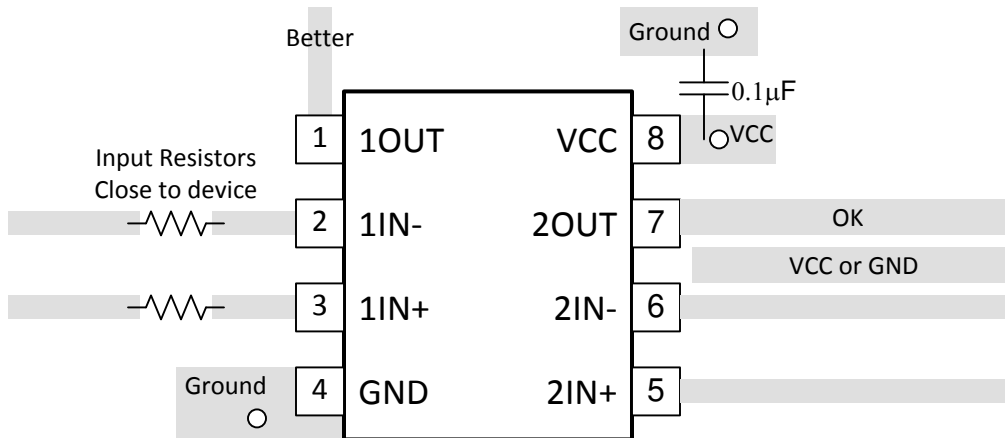
8.2 支持资源

[TI E2E™ 中文支持论坛](#) 是工程师的重要参考资料，可直接从专家处获得快速、经过验证的解答和设计帮助。搜索现有解答或提出自己的问题，获得所需的快速设计帮助。

链接的内容由各个贡献者“按原样”提供。这些内容并不构成 TI 技术规范，并且不一定反映 TI 的观点；请参阅 TI 的 [使用条款](#)。

8.3 商标

TI E2E™ is a trademark of Texas Instruments.

所有商标均为其各自所有者的财产。

8.4 静电放电警告



静电放电 (ESD) 会损坏这个集成电路。德州仪器 (TI) 建议通过适当的预防措施处理所有集成电路。如果不遵守正确的处理和安装程序，可能会损坏集成电路。

ESD 的损坏小至导致微小的性能降级，大至整个器件故障。精密的集成电路可能更容易受到损坏，这是因为非常细微的参数更改都可能会导致器件与其发布的规格不相符。

8.5 术语表

[TI 术语表](#) 本术语表列出并解释了术语、首字母缩略词和定义。

9 修订历史记录

注：以前版本的页码可能与当前版本的页码不同

Changes from Revision AF (August 2023) to Revision AG (January 2025)	Page
• 删除了旧器件图.....	11
• 更新了内部 <i>原理图</i>	17

Changes from Revision AE (November 2020) to Revision AF (August 2023)	Page
• 添加了对应用手册的引用.....	18

Changes from Revision AD (October 2020) to Revision AE (November 2020)	Page
• 将系列比较表失调电压单位更正为 mV.....	1
• 通篇将 LM393B 和 LM2903B 的建议最小电源电压更改为 2V.....	1
• 为 LM393B 和 LM2903B (DGK 封装) 添加了单独的失调电压行.....	1
• 将“B”器件的建议最小电源电压更改为 2V.....	4
• 更新了适用于 2V 电压的“B”器件电源电流与电源电压间的关系图.....	11

Changes from Revision AC (February 2020) to Revision AD (October 2020) Page

- 更新了整个文档中的表、图和交叉参考的编号格式..... 1
-

Changes from Revision AB (December 2019) to Revision AC (February 2020) Page

- 更改了首页的“特性”、“应用”和“说明”文本，以突出 B 版本。..... 1
 - 添加了 WSON 和 SOT-23-8 封装..... 1
 - 向系列比较表添加了链接..... 1
 - 向热性能表添加了 DDF 和 DSG 封装..... 5
-

Changes from Revision AA (September 2019) to Revision AB (December 2019) Page

- 将 LM393B 和 LM2903B 的状态从“预发布”更改为“正在供货” 1
 - 添加了系列比较表..... 1
-

Changes from Revision Z (October 2017) to Revision AA (September 2019) Page

- 在整个数据表中添加了“B”器件并更改了多处文本。..... 1
 - 删除了“器件信息”中旧的 LM193 CDIP 和 LCCC 封装参考和图，这些内容包含在 LM139-MIL 数据表中..... 1
 - 添加了"B"器件热性能信息表。..... 5
 - 添加了"B"器件电气表..... 5
 - 添加了“B”器件图..... 11
-

10 机械、封装和可订购信息

以下页面包含机械、封装和可订购信息。这些信息是指定器件的最新可用数据。数据如有变更，恕不另行通知，且不会对此文档进行修订。如需获取此数据表的浏览器版本，请查阅左侧的导航栏。

PACKAGING INFORMATION

Orderable part number	Status (1)	Material type (2)	Package Pins	Package qty Carrier	RoHS (3)	Lead finish/ Ball material (4)	MSL rating/ Peak reflow (5)	Op temp (°C)	Part marking (6)
LM193DR	Active	Production	SOIC (D) 8	2500 LARGE T&R	Yes	NIPDAU	Level-1-260C-UNLIM	-55 to 125	LM193
LM193DRG4	Active	Production	SOIC (D) 8	2500 LARGE T&R	Yes	NIPDAU	Level-1-260C-UNLIM	-55 to 125	LM193
LM2903AVQDR	Active	Production	SOIC (D) 8	2500 LARGE T&R	Yes	NIPDAU	Level-1-260C-UNLIM	-40 to 125	L2903AV
LM2903AVQDRG4	Active	Production	SOIC (D) 8	2500 LARGE T&R	Yes	NIPDAU	Level-1-260C-UNLIM	-40 to 125	L2903AV
LM2903AVQPWR	Active	Production	TSSOP (PW) 8	2000 LARGE T&R	Yes	NIPDAU	Level-1-260C-UNLIM	-40 to 125	(2903AV, L2903AV)
LM2903AVQPWR.Z	Active	Production	TSSOP (PW) 8	2000 LARGE T&R	Yes	NIPDAU	Level-1-260C-UNLIM	-40 to 125	(2903AV, L2903AV)
LM2903AVQPWRG4	Active	Production	TSSOP (PW) 8	2000 LARGE T&R	Yes	NIPDAU	Level-1-260C-UNLIM	-40 to 125	(2903AV, L2903AV)
LM2903AVQPWRG4.Z	Active	Production	TSSOP (PW) 8	2000 LARGE T&R	Yes	NIPDAU	Level-1-260C-UNLIM	-40 to 125	(2903AV, L2903AV)
LM2903BIDDFR	Active	Production	SOT-23-THIN (DDF) 8	3000 LARGE T&R	Yes	NIPDAU	Level-1-260C-UNLIM	-40 to 125	2903B
LM2903BIDDFR.Z	Active	Production	SOT-23-THIN (DDF) 8	3000 LARGE T&R	Yes	NIPDAU	Level-1-260C-UNLIM	-40 to 125	2903B
LM2903BIDDFRG4.Z	Active	Production	SOT-23-THIN (DDF) 8	3000 LARGE T&R	Yes	NIPDAU	Level-1-260C-UNLIM	-40 to 125	2903B
LM2903BIDGKR	Active	Production	VSSOP (DGK) 8	2500 LARGE T&R	Yes	NIPDAU	Level-1-260C-UNLIM	-40 to 125	903B
LM2903BIDGKR.Z	Active	Production	VSSOP (DGK) 8	2500 LARGE T&R	Yes	NIPDAU	Level-1-260C-UNLIM	-40 to 125	903B
LM2903BIDGKRG4.Z	Active	Production	VSSOP (DGK) 8	2500 LARGE T&R	Yes	NIPDAU	Level-1-260C-UNLIM	-40 to 125	903B
LM2903BIDR	Active	Production	SOIC (D) 8	2500 LARGE T&R	Yes	NIPDAU	Level-1-260C-UNLIM	-40 to 125	L2903B
LM2903BIDR.Z	Active	Production	SOIC (D) 8	2500 LARGE T&R	Yes	NIPDAU	Level-1-260C-UNLIM	-40 to 125	L2903B
LM2903BIDRG4.Z	Active	Production	SOIC (D) 8	2500 LARGE T&R	Yes	NIPDAU	Level-1-260C-UNLIM	-40 to 125	L2903B
LM2903BIDSGR	Active	Production	WSON (DSG) 8	3000 LARGE T&R	Yes	NIPDAU	Level-1-260C-UNLIM	-40 to 125	903B
LM2903BIDSGR.Z	Active	Production	WSON (DSG) 8	3000 LARGE T&R	Yes	NIPDAU	Level-1-260C-UNLIM	-40 to 125	903B
LM2903BIDSGRG4.Z	Active	Production	WSON (DSG) 8	3000 LARGE T&R	Yes	NIPDAU	Level-1-260C-UNLIM	-40 to 125	903B
LM2903BIPWR	Active	Production	TSSOP (PW) 8	2000 LARGE T&R	Yes	NIPDAU	Level-1-260C-UNLIM	-40 to 125	L2903B
LM2903BIPWR.Z	Active	Production	TSSOP (PW) 8	2000 LARGE T&R	Yes	NIPDAU	Level-1-260C-UNLIM	-40 to 125	L2903B
LM2903DGKR	Active	Production	VSSOP (DGK) 8	2500 LARGE T&R	Yes	NIPDAU SN NIPDAUAG	Level-1-260C-UNLIM	-40 to 125	(MAP, MAS, MAU)
LM2903DR	Active	Production	SOIC (D) 8	2500 LARGE T&R	Yes	NIPDAU SN	Level-1-260C-UNLIM	-40 to 125	LM2903
LM2903DRG3	Active	Production	SOIC (D) 8	2500 LARGE T&R	Yes	SN	Level-1-260C-UNLIM	-40 to 125	LM2903
LM2903P	Active	Production	PDIP (P) 8	50 TUBE	Yes	NIPDAU	N/A for Pkg Type	-40 to 125	LM2903P
LM2903P.Z	Active	Production	PDIP (P) 8	50 TUBE	Yes	NIPDAU	N/A for Pkg Type	-40 to 125	LM2903P
LM2903PSR	Active	Production	SO (PS) 8	2000 LARGE T&R	Yes	NIPDAU	Level-1-260C-UNLIM	-40 to 125	L2903

Orderable part number	Status (1)	Material type (2)	Package Pins	Package qty Carrier	RoHS (3)	Lead finish/ Ball material (4)	MSL rating/ Peak reflow (5)	Op temp (°C)	Part marking (6)
LM2903PWR	Active	Production	TSSOP (PW) 8	2000 LARGE T&R	Yes	NIPDAU SN	Level-1-260C-UNLIM	-40 to 125	L2903
LM2903PWR.Z	Active	Production	TSSOP (PW) 8	2000 LARGE T&R	Yes	NIPDAU	Level-1-260C-UNLIM	-40 to 125	L2903
LM2903PWRG3	Active	Production	TSSOP (PW) 8	2000 LARGE T&R	Yes	SN	Level-1-260C-UNLIM	-40 to 125	L2903
LM2903PWRG4	Active	Production	TSSOP (PW) 8	2000 LARGE T&R	Yes	NIPDAU	Level-1-260C-UNLIM	-40 to 125	L2903
LM2903PWRG4.Z	Active	Production	TSSOP (PW) 8	2000 LARGE T&R	Yes	NIPDAU	Level-1-260C-UNLIM	-40 to 125	L2903
LM2903QD	Active	Production	SOIC (D) 8	75 TUBE	Yes	NIPDAU	Level-1-260C-UNLIM	-40 to 125	2903Q
LM2903QDRG4	Obsolete	Production	SOIC (D) 8	-	-	Call TI	Call TI	-40 to 125	2903Q
LM2903VQDR	Active	Production	SOIC (D) 8	2500 LARGE T&R	Yes	NIPDAU	Level-1-260C-UNLIM	-40 to 125	L2903V
LM2903VQDRG4	Obsolete	Production	SOIC (D) 8	-	-	Call TI	Call TI	-40 to 125	L2903V
LM2903VQPWR	Active	Production	TSSOP (PW) 8	2000 LARGE T&R	Yes	NIPDAU	Level-1-260C-UNLIM	-40 to 125	L2903V
LM2903VQPWR.Z	Active	Production	TSSOP (PW) 8	2000 LARGE T&R	Yes	NIPDAU	Level-1-260C-UNLIM	-40 to 125	L2903V
LM2903VQPWRG4	Obsolete	Production	TSSOP (PW) 8	-	-	Call TI	Call TI	-40 to 125	L2903V
LM293ADGKR	Active	Production	VSSOP (DGK) 8	2500 LARGE T&R	Yes	NIPDAU SN NIPDAU	Level-1-260C-UNLIM	-25 to 85	(MDP, MDS, MDU)
LM293ADGKR.G4	Active	Production	VSSOP (DGK) 8	2500 LARGE T&R	-	Call TI	Call TI	-25 to 85	
LM293ADR	Active	Production	SOIC (D) 8	2500 LARGE T&R	Yes	NIPDAU	Level-1-260C-UNLIM	-25 to 85	LM293A
LM293D	Obsolete	Production	SOIC (D) 8	-	-	Call TI	Call TI	-25 to 85	LM293
LM293DGKR	Active	Production	VSSOP (DGK) 8	2500 LARGE T&R	Yes	NIPDAU SN NIPDAU	Level-1-260C-UNLIM	-25 to 85	(MCP, MCS, MCU)
LM293DGKR.Z	Active	Production	VSSOP (DGK) 8	2500 LARGE T&R	Yes	NIPDAU	Level-1-260C-UNLIM	-25 to 85	(MCP, MCS, MCU)
LM293DGKR.G4	Active	Production	VSSOP (DGK) 8	2500 LARGE T&R	-	Call TI	Call TI	-25 to 85	
LM293DR	Active	Production	SOIC (D) 8	2500 LARGE T&R	Yes	NIPDAU	Level-1-260C-UNLIM	-25 to 85	LM293
LM293DRG3	Active	Production	SOIC (D) 8	2500 LARGE T&R	Yes	SN	Level-1-260C-UNLIM	-25 to 85	LM293
LM293P	Active	Production	PDIP (P) 8	50 TUBE	Yes	NIPDAU	N/A for Pkg Type	-25 to 85	LM293P
LM293P.Z	Active	Production	PDIP (P) 8	50 TUBE	Yes	NIPDAU	N/A for Pkg Type	-25 to 85	LM293P
LM293PE4	Active	Production	PDIP (P) 8	50 TUBE	-	Call TI	Call TI	-25 to 85	
LM393ADGKR	Active	Production	VSSOP (DGK) 8	2500 LARGE T&R	Yes	NIPDAU NIPDAUAG NIPDAU	Level-1-260C-UNLIM	0 to 70	(M8P, M8S, M8U)
LM393ADGKR.G4	Active	Production	VSSOP (DGK) 8	2500 LARGE T&R	-	Call TI	Call TI	0 to 70	
LM393ADR	Active	Production	SOIC (D) 8	2500 LARGE T&R	Yes	NIPDAU SN	Level-1-260C-UNLIM	0 to 70	LM393A
LM393ADRG4	Obsolete	Production	SOIC (D) 8	-	-	Call TI	Call TI	0 to 70	LM393A
LM393AP	Active	Production	PDIP (P) 8	50 TUBE	Yes	NIPDAU SN	N/A for Pkg Type	0 to 70	LM393AP
LM393AP.Z	Active	Production	PDIP (P) 8	50 TUBE	Yes	NIPDAU	N/A for Pkg Type	0 to 70	LM393AP

Orderable part number	Status (1)	Material type (2)	Package Pins	Package qty Carrier	RoHS (3)	Lead finish/ Ball material (4)	MSL rating/ Peak reflow (5)	Op temp (°C)	Part marking (6)
LM393APE4	Active	Production	PDIP (P) 8	50 TUBE	-	Call TI	Call TI	0 to 70	
LM393APSR	Active	Production	SO (PS) 8	2000 LARGE T&R	Yes	NIPDAU	Level-1-260C-UNLIM	0 to 70	L393A
LM393APWR	Active	Production	TSSOP (PW) 8	2000 LARGE T&R	Yes	NIPDAU SN	Level-1-260C-UNLIM	0 to 70	L393A
LM393APWR.Z	Active	Production	TSSOP (PW) 8	2000 LARGE T&R	Yes	NIPDAU	Level-1-260C-UNLIM	0 to 70	L393A
LM393APWRG4	Obsolete	Production	TSSOP (PW) 8	-	-	Call TI	Call TI	0 to 70	L393A
LM393BIDDFR	Active	Production	SOT-23-THIN (DDF) 8	3000 LARGE T&R	Yes	NIPDAU	Level-1-260C-UNLIM	-40 to 85	393B
LM393BIDDFR.Z	Active	Production	SOT-23-THIN (DDF) 8	3000 LARGE T&R	Yes	NIPDAU	Level-1-260C-UNLIM	-40 to 85	393B
LM393BIDDFRG4.Z	Active	Production	SOT-23-THIN (DDF) 8	3000 LARGE T&R	Yes	NIPDAU	Level-1-260C-UNLIM	-40 to 85	393B
LM393BIDGKR	Active	Production	VSSOP (DGK) 8	2500 LARGE T&R	Yes	NIPDAU	Level-1-260C-UNLIM	-40 to 85	393B
LM393BIDGKR.Z	Active	Production	VSSOP (DGK) 8	2500 LARGE T&R	Yes	NIPDAU	Level-1-260C-UNLIM	-40 to 85	393B
LM393BIDR	Active	Production	SOIC (D) 8	2500 LARGE T&R	Yes	NIPDAU	Level-1-260C-UNLIM	-40 to 85	LM393B
LM393BIDR.Z	Active	Production	SOIC (D) 8	2500 LARGE T&R	Yes	NIPDAU	Level-1-260C-UNLIM	-40 to 85	LM393B
LM393BIDRG4.Z	Active	Production	SOIC (D) 8	2500 LARGE T&R	Yes	NIPDAU	Level-1-260C-UNLIM	-40 to 85	LM393B
LM393BIDSGR	Active	Production	WSON (DSG) 8	3000 LARGE T&R	Yes	NIPDAU	Level-1-260C-UNLIM	-40 to 85	393B
LM393BIDSGR.Z	Active	Production	WSON (DSG) 8	3000 LARGE T&R	Yes	NIPDAU	Level-1-260C-UNLIM	-40 to 85	393B
LM393BIDSGRG4.Z	Active	Production	WSON (DSG) 8	3000 LARGE T&R	Yes	NIPDAU	Level-1-260C-UNLIM	-40 to 85	393B
LM393BIPWR	Active	Production	TSSOP (PW) 8	2000 LARGE T&R	Yes	NIPDAU	Level-1-260C-UNLIM	-40 to 85	LM393B
LM393BIPWR.Z	Active	Production	TSSOP (PW) 8	2000 LARGE T&R	Yes	NIPDAU	Level-1-260C-UNLIM	-40 to 85	LM393B
LM393D	Obsolete	Production	SOIC (D) 8	-	-	Call TI	Call TI	0 to 70	LM393
LM393DGKR	Active	Production	VSSOP (DGK) 8	2500 LARGE T&R	Yes	NIPDAU SN	Level-1-260C-UNLIM	0 to 70	(M9P, M9S, M9U)
LM393DGKRG4	Active	Production	VSSOP (DGK) 8	2500 LARGE T&R	-	Call TI	Call TI	0 to 70	
LM393DR	Active	Production	SOIC (D) 8	2500 LARGE T&R	Yes	NIPDAU	Level-1-260C-UNLIM	0 to 70	LM393
LM393DRG3	Active	Production	SOIC (D) 8	2500 LARGE T&R	Yes	SN	Level-1-260C-UNLIM	0 to 70	LM393
LM393DRG4	Obsolete	Production	SOIC (D) 8	-	-	Call TI	Call TI	0 to 70	LM393
LM393P	Active	Production	PDIP (P) 8	50 TUBE	Yes	NIPDAU SN	N/A for Pkg Type	0 to 70	LM393P
LM393P.Z	Active	Production	PDIP (P) 8	50 TUBE	Yes	NIPDAU	N/A for Pkg Type	0 to 70	LM393P
LM393PE3	Active	Production	PDIP (P) 8	50 TUBE	Yes	SN	N/A for Pkg Type	0 to 70	LM393P
LM393PE4	Active	Production	PDIP (P) 8	50 TUBE	Yes	NIPDAU	N/A for Pkg Type	0 to 70	LM393P
LM393PE4.Z	Active	Production	PDIP (P) 8	50 TUBE	Yes	NIPDAU	N/A for Pkg Type	0 to 70	LM393P
LM393PS	Active	Production	SO (PS) 8	80 TUBE	Yes	NIPDAU	Level-1-260C-UNLIM	0 to 70	L393
LM393PSR	Active	Production	SO (PS) 8	2000 LARGE T&R	Yes	NIPDAU	Level-1-260C-UNLIM	0 to 70	L393

Orderable part number	Status (1)	Material type (2)	Package Pins	Package qty Carrier	RoHS (3)	Lead finish/ Ball material (4)	MSL rating/ Peak reflow (5)	Op temp (°C)	Part marking (6)
LM393PSRG4	Active	Production	SO (PS) 8	2000 LARGE T&R	Yes	NIPDAU	Level-1-260C-UNLIM	0 to 70	L393
LM393PWR	Active	Production	TSSOP (PW) 8	2000 LARGE T&R	Yes	NIPDAU SN	Level-1-260C-UNLIM	0 to 70	L393
LM393PWR.Z	Active	Production	TSSOP (PW) 8	2000 LARGE T&R	Yes	NIPDAU	Level-1-260C-UNLIM	0 to 70	L393
LM393PWRG3	Active	Production	TSSOP (PW) 8	2000 LARGE T&R	Yes	SN	Level-1-260C-UNLIM	0 to 70	L393
LM393PWRG4	Active	Production	TSSOP (PW) 8	2000 LARGE T&R	Yes	NIPDAU	Level-1-260C-UNLIM	0 to 70	L393
LM393PWRG4.Z	Active	Production	TSSOP (PW) 8	2000 LARGE T&R	Yes	NIPDAU	Level-1-260C-UNLIM	0 to 70	L393

(1) **Status:** For more details on status, see our [product life cycle](#).

(2) **Material type:** When designated, preproduction parts are prototypes/experimental devices, and are not yet approved or released for full production. Testing and final process, including without limitation quality assurance, reliability performance testing, and/or process qualification, may not yet be complete, and this item is subject to further changes or possible discontinuation. If available for ordering, purchases will be subject to an additional waiver at checkout, and are intended for early internal evaluation purposes only. These items are sold without warranties of any kind.

(3) **RoHS values:** Yes, No, RoHS Exempt. See the [TI RoHS Statement](#) for additional information and value definition.

(4) **Lead finish/Ball material:** Parts may have multiple material finish options. Finish options are separated by a vertical ruled line. Lead finish/Ball material values may wrap to two lines if the finish value exceeds the maximum column width.

(5) **MSL rating/Peak reflow:** The moisture sensitivity level ratings and peak solder (reflow) temperatures. In the event that a part has multiple moisture sensitivity ratings, only the lowest level per JEDEC standards is shown. Refer to the shipping label for the actual reflow temperature that will be used to mount the part to the printed circuit board.

(6) **Part marking:** There may be an additional marking, which relates to the logo, the lot trace code information, or the environmental category of the part.

Multiple part markings will be inside parentheses. Only one part marking contained in parentheses and separated by a "~" will appear on a part. If a line is indented then it is a continuation of the previous line and the two combined represent the entire part marking for that device.

Important Information and Disclaimer: The information provided on this page represents TI's knowledge and belief as of the date that it is provided. TI bases its knowledge and belief on information provided by third parties, and makes no representation or warranty as to the accuracy of such information. Efforts are underway to better integrate information from third parties. TI has taken and continues to take reasonable steps to provide representative and accurate information but may not have conducted destructive testing or chemical analysis on incoming materials and chemicals. TI and TI suppliers consider certain information to be proprietary, and thus CAS numbers and other limited information may not be available for release.

In no event shall TI's liability arising out of such information exceed the total purchase price of the TI part(s) at issue in this document sold by TI to Customer on an annual basis.

OTHER QUALIFIED VERSIONS OF LM2903, LM2903B, LM293 :

- Automotive : [LM2903-Q1](#), [LM2903B-Q1](#)
- Enhanced Product : [LM293-EP](#)

NOTE: Qualified Version Definitions:

- Automotive - Q100 devices qualified for high-reliability automotive applications targeting zero defects
- Enhanced Product - Supports Defense, Aerospace and Medical Applications

TAPE AND REEL INFORMATION

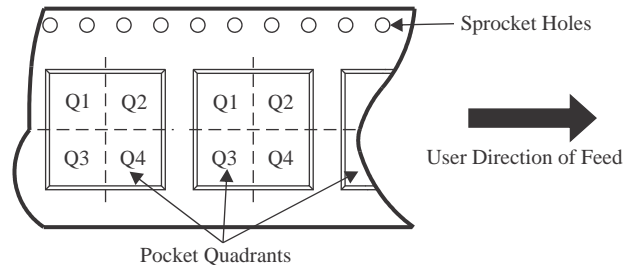
QUADRANT ASSIGNMENTS FOR PIN 1 ORIENTATION IN TAPE

*All dimensions are nominal

Device	Package Type	Package Drawing	Pins	SPQ	Reel Diameter (mm)	Reel Width W1 (mm)	A0 (mm)	B0 (mm)	K0 (mm)	P1 (mm)	W (mm)	Pin1 Quadrant
LM193DR	SOIC	D	8	2500	330.0	12.4	6.4	5.2	2.1	8.0	12.0	Q1
LM193DRG4	SOIC	D	8	2500	330.0	12.4	6.4	5.2	2.1	8.0	12.0	Q1
LM2903AVQDR	SOIC	D	8	2500	330.0	12.4	6.4	5.2	2.1	8.0	12.0	Q1
LM2903AVQDRG4	SOIC	D	8	2500	330.0	12.4	6.4	5.2	2.1	8.0	12.0	Q1
LM2903AVQPWR	TSSOP	PW	8	2000	330.0	12.4	7.0	3.6	1.6	8.0	12.0	Q1
LM2903AVQPWR	TSSOP	PW	8	2000	330.0	12.4	7.0	3.6	1.6	8.0	12.0	Q1
LM2903AVQPWR	TSSOP	PW	8	2000	330.0	12.4	7.0	3.6	1.6	8.0	12.0	Q1
LM2903AVQPWRG4	TSSOP	PW	8	2000	330.0	12.4	7.0	3.6	1.6	8.0	12.0	Q1
LM2903AVQPWRG4	TSSOP	PW	8	2000	330.0	12.4	7.0	3.6	1.6	8.0	12.0	Q1
LM2903AVQPWRG4	TSSOP	PW	8	2000	330.0	12.4	7.0	3.6	1.6	8.0	12.0	Q1
LM2903BIDDFR	SOT-23-THIN	DDF	8	3000	180.0	8.4	3.2	3.2	1.4	4.0	8.0	Q3
LM2903BIDGKR	VSSOP	DGK	8	2500	330.0	12.4	6.4	5.2	2.1	8.0	12.0	Q1
LM2903BIDGKR	VSSOP	DGK	8	2500	330.0	12.4	5.3	3.4	1.4	8.0	12.0	Q1
LM2903BIDR	SOIC	D	8	2500	330.0	12.4	6.4	5.2	2.1	8.0	12.0	Q1
LM2903BIDSGR	WSO	DSG	8	3000	180.0	8.4	2.3	2.3	1.15	4.0	8.0	Q2

Device	Package Type	Package Drawing	Pins	SPQ	Reel Diameter (mm)	Reel Width W1 (mm)	A0 (mm)	B0 (mm)	K0 (mm)	P1 (mm)	W (mm)	Pin1 Quadrant
LM2903BIPWR	TSSOP	PW	8	2000	330.0	12.4	7.0	3.6	1.6	8.0	12.0	Q1
LM2903BIPWR	TSSOP	PW	8	2000	330.0	12.4	7.0	3.6	1.6	8.0	12.0	Q1
LM2903DGKR	VSSOP	DGK	8	2500	330.0	12.4	6.4	5.2	2.1	8.0	12.0	Q1
LM2903DR	SOIC	D	8	2500	330.0	12.4	6.4	5.2	2.1	8.0	12.0	Q1
LM2903DR	SOIC	D	8	2500	330.0	12.4	6.4	5.2	2.1	8.0	12.0	Q1
LM2903DRG3	SOIC	D	8	2500	330.0	12.8	6.4	5.2	2.1	8.0	12.0	Q1
LM2903PSR	SO	PS	8	2000	330.0	16.4	8.35	6.6	2.4	12.0	16.0	Q1
LM2903PWR	TSSOP	PW	8	2000	330.0	12.4	7.0	3.6	1.6	8.0	12.0	Q1
LM2903PWR	TSSOP	PW	8	2000	330.0	12.4	7.0	3.6	1.6	8.0	12.0	Q1
LM2903PWR	TSSOP	PW	8	2000	330.0	12.4	7.0	3.6	1.6	8.0	12.0	Q1
LM2903PWRG3	TSSOP	PW	8	2000	330.0	12.4	7.0	3.6	1.6	8.0	12.0	Q1
LM2903PWRG4	TSSOP	PW	8	2000	330.0	12.4	7.0	3.6	1.6	8.0	12.0	Q1
LM2903PWRG4	TSSOP	PW	8	2000	330.0	12.4	7.0	3.6	1.6	8.0	12.0	Q1
LM2903PWRG4	TSSOP	PW	8	2000	330.0	12.4	7.0	3.6	1.6	8.0	12.0	Q1
LM2903VQDR	SOIC	D	8	2500	330.0	12.4	6.4	5.2	2.1	8.0	12.0	Q1
LM2903VQPWR	TSSOP	PW	8	2000	330.0	12.4	7.0	3.6	1.6	8.0	12.0	Q1
LM2903VQPWR	TSSOP	PW	8	2000	330.0	12.4	7.0	3.6	1.6	8.0	12.0	Q1
LM2903VQPWR	TSSOP	PW	8	2000	330.0	12.4	7.0	3.6	1.6	8.0	12.0	Q1
LM293ADGKR	VSSOP	DGK	8	2500	330.0	12.4	5.3	3.4	1.4	8.0	12.0	Q1
LM293ADR	SOIC	D	8	2500	330.0	12.4	6.4	5.2	2.1	8.0	12.0	Q1
LM293ADR	SOIC	D	8	2500	330.0	12.4	6.4	5.2	2.1	8.0	12.0	Q1
LM293DGKR	VSSOP	DGK	8	2500	330.0	12.4	5.3	3.4	1.4	8.0	12.0	Q1
LM293DR	SOIC	D	8	2500	330.0	12.4	6.4	5.2	2.1	8.0	12.0	Q1
LM293DR	SOIC	D	8	2500	330.0	12.4	6.4	5.2	2.1	8.0	12.0	Q1
LM293DRG3	SOIC	D	8	2500	330.0	12.8	6.4	5.2	2.1	8.0	12.0	Q1
LM393ADGKR	VSSOP	DGK	8	2500	330.0	12.4	5.3	3.4	1.4	8.0	12.0	Q1
LM393ADR	SOIC	D	8	2500	330.0	12.4	6.4	5.2	2.1	8.0	12.0	Q1
LM393ADR	SOIC	D	8	2500	330.0	12.4	6.4	5.2	2.1	8.0	12.0	Q1
LM393APSR	SO	PS	8	2000	330.0	16.4	8.35	6.6	2.4	12.0	16.0	Q1
LM393APWR	TSSOP	PW	8	2000	330.0	12.4	7.0	3.6	1.6	8.0	12.0	Q1
LM393APWR	TSSOP	PW	8	2000	330.0	12.4	7.0	3.6	1.6	8.0	12.0	Q1
LM393APWR	TSSOP	PW	8	2000	330.0	12.4	7.0	3.6	1.6	8.0	12.0	Q1
LM393BIDDFR	SOT-23-THIN	DDF	8	3000	180.0	8.4	3.2	3.2	1.4	4.0	8.0	Q3
LM393BIDGKR	VSSOP	DGK	8	2500	330.0	12.4	6.4	5.2	2.1	8.0	12.0	Q1
LM393BIDR	SOIC	D	8	2500	330.0	12.4	6.4	5.2	2.1	8.0	12.0	Q1
LM393BIDSGR	WSON	DSG	8	3000	180.0	8.4	2.3	2.3	1.15	4.0	8.0	Q2
LM393BIPWR	TSSOP	PW	8	2000	330.0	12.4	7.0	3.6	1.6	8.0	12.0	Q1
LM393BIPWR	TSSOP	PW	8	2000	330.0	12.4	7.0	3.6	1.6	8.0	12.0	Q1
LM393DGKR	VSSOP	DGK	8	2500	330.0	12.4	5.3	3.4	1.4	8.0	12.0	Q1
LM393DGKR	VSSOP	DGK	8	2500	330.0	12.4	6.4	5.2	2.1	8.0	12.0	Q1
LM393DR	SOIC	D	8	2500	330.0	12.4	6.4	5.2	2.1	8.0	12.0	Q1

Device	Package Type	Package Drawing	Pins	SPQ	Reel Diameter (mm)	Reel Width W1 (mm)	A0 (mm)	B0 (mm)	K0 (mm)	P1 (mm)	W (mm)	Pin1 Quadrant
LM393DR	SOIC	D	8	2500	330.0	12.4	6.4	5.2	2.1	8.0	12.0	Q1
LM393DRG3	SOIC	D	8	2500	330.0	12.8	6.4	5.2	2.1	8.0	12.0	Q1
LM393PSR	SO	PS	8	2000	330.0	16.4	8.35	6.6	2.4	12.0	16.0	Q1
LM393PWR	TSSOP	PW	8	2000	330.0	12.4	7.0	3.6	1.6	8.0	12.0	Q1
LM393PWR	TSSOP	PW	8	2000	330.0	12.4	7.0	3.6	1.6	8.0	12.0	Q1
LM393PWR	TSSOP	PW	8	2000	330.0	12.4	7.0	3.6	1.6	8.0	12.0	Q1
LM393PWRG3	TSSOP	PW	8	2000	330.0	12.4	7.0	3.6	1.6	8.0	12.0	Q1
LM393PWRG4	TSSOP	PW	8	2000	330.0	12.4	7.0	3.6	1.6	8.0	12.0	Q1
LM393PWRG4	TSSOP	PW	8	2000	330.0	12.4	7.0	3.6	1.6	8.0	12.0	Q1
LM393PWRG4	TSSOP	PW	8	2000	330.0	12.4	7.0	3.6	1.6	8.0	12.0	Q1

TAPE AND REEL BOX DIMENSIONS

*All dimensions are nominal

Device	Package Type	Package Drawing	Pins	SPQ	Length (mm)	Width (mm)	Height (mm)
LM193DR	SOIC	D	8	2500	353.0	353.0	32.0
LM193DRG4	SOIC	D	8	2500	353.0	353.0	32.0
LM2903AVQDR	SOIC	D	8	2500	353.0	353.0	32.0
LM2903AVQDRG4	SOIC	D	8	2500	353.0	353.0	32.0
LM2903AVQPWR	TSSOP	PW	8	2000	353.0	353.0	32.0
LM2903AVQPWR	TSSOP	PW	8	2000	356.0	356.0	35.0
LM2903AVQPWR	TSSOP	PW	8	2000	356.0	356.0	35.0
LM2903AVQPWRG4	TSSOP	PW	8	2000	353.0	353.0	32.0
LM2903AVQPWRG4	TSSOP	PW	8	2000	356.0	356.0	35.0
LM2903AVQPWRG4	TSSOP	PW	8	2000	356.0	356.0	35.0
LM2903BIDDFR	SOT-23-THIN	DDF	8	3000	210.0	185.0	35.0
LM2903BIDGKR	VSSOP	DGK	8	2500	353.0	353.0	32.0
LM2903BIDGKR	VSSOP	DGK	8	2500	353.0	353.0	32.0
LM2903BIDR	SOIC	D	8	2500	353.0	353.0	32.0
LM2903BIDSGR	WSON	DSG	8	3000	210.0	185.0	35.0
LM2903BIPWR	TSSOP	PW	8	2000	353.0	353.0	32.0
LM2903BIPWR	TSSOP	PW	8	2000	356.0	356.0	35.0
LM2903DGKR	VSSOP	DGK	8	2500	353.0	353.0	32.0

Device	Package Type	Package Drawing	Pins	SPQ	Length (mm)	Width (mm)	Height (mm)
LM2903DR	SOIC	D	8	2500	356.0	356.0	35.0
LM2903DR	SOIC	D	8	2500	353.0	353.0	32.0
LM2903DRG3	SOIC	D	8	2500	364.0	364.0	27.0
LM2903PSR	SO	PS	8	2000	356.0	356.0	35.0
LM2903PWR	TSSOP	PW	8	2000	356.0	356.0	35.0
LM2903PWR	TSSOP	PW	8	2000	353.0	353.0	32.0
LM2903PWR	TSSOP	PW	8	2000	356.0	356.0	35.0
LM2903PWRG3	TSSOP	PW	8	2000	364.0	364.0	27.0
LM2903PWRG4	TSSOP	PW	8	2000	353.0	353.0	32.0
LM2903PWRG4	TSSOP	PW	8	2000	356.0	356.0	35.0
LM2903PWRG4	TSSOP	PW	8	2000	356.0	356.0	35.0
LM2903VQDR	SOIC	D	8	2500	353.0	353.0	32.0
LM2903VQPWR	TSSOP	PW	8	2000	356.0	356.0	35.0
LM2903VQPWR	TSSOP	PW	8	2000	356.0	356.0	35.0
LM2903VQPWR	TSSOP	PW	8	2000	353.0	353.0	32.0
LM293ADGKR	VSSOP	DGK	8	2500	353.0	353.0	32.0
LM293ADR	SOIC	D	8	2500	353.0	353.0	32.0
LM293ADR	SOIC	D	8	2500	356.0	356.0	35.0
LM293DGKR	VSSOP	DGK	8	2500	356.0	356.0	35.0
LM293DR	SOIC	D	8	2500	353.0	353.0	32.0
LM293DR	SOIC	D	8	2500	356.0	356.0	35.0
LM293DRG3	SOIC	D	8	2500	364.0	364.0	27.0
LM393ADGKR	VSSOP	DGK	8	2500	353.0	353.0	32.0
LM393ADR	SOIC	D	8	2500	353.0	353.0	32.0
LM393ADR	SOIC	D	8	2500	356.0	356.0	35.0
LM393APSR	SO	PS	8	2000	356.0	356.0	35.0
LM393APWR	TSSOP	PW	8	2000	356.0	356.0	35.0
LM393APWR	TSSOP	PW	8	2000	356.0	356.0	35.0
LM393APWR	TSSOP	PW	8	2000	353.0	353.0	32.0
LM393BIDDFR	SOT-23-THIN	DDF	8	3000	210.0	185.0	35.0
LM393BIDGKR	VSSOP	DGK	8	2500	353.0	353.0	32.0
LM393BIDR	SOIC	D	8	2500	353.0	353.0	32.0
LM393BIDSGR	WSON	DSG	8	3000	210.0	185.0	35.0
LM393BIPWR	TSSOP	PW	8	2000	356.0	356.0	35.0
LM393BIPWR	TSSOP	PW	8	2000	353.0	353.0	32.0
LM393DGKR	VSSOP	DGK	8	2500	353.0	353.0	32.0
LM393DGKR	VSSOP	DGK	8	2500	353.0	353.0	32.0
LM393DR	SOIC	D	8	2500	353.0	353.0	32.0
LM393DR	SOIC	D	8	2500	356.0	356.0	35.0
LM393DRG3	SOIC	D	8	2500	364.0	364.0	27.0
LM393PSR	SO	PS	8	2000	356.0	356.0	35.0
LM393PWR	TSSOP	PW	8	2000	356.0	356.0	35.0
LM393PWR	TSSOP	PW	8	2000	353.0	353.0	32.0

Device	Package Type	Package Drawing	Pins	SPQ	Length (mm)	Width (mm)	Height (mm)
LM393PWR	TSSOP	PW	8	2000	356.0	356.0	35.0
LM393PWRG3	TSSOP	PW	8	2000	364.0	364.0	27.0
LM393PWRG4	TSSOP	PW	8	2000	356.0	356.0	35.0
LM393PWRG4	TSSOP	PW	8	2000	356.0	356.0	35.0
LM393PWRG4	TSSOP	PW	8	2000	353.0	353.0	32.0

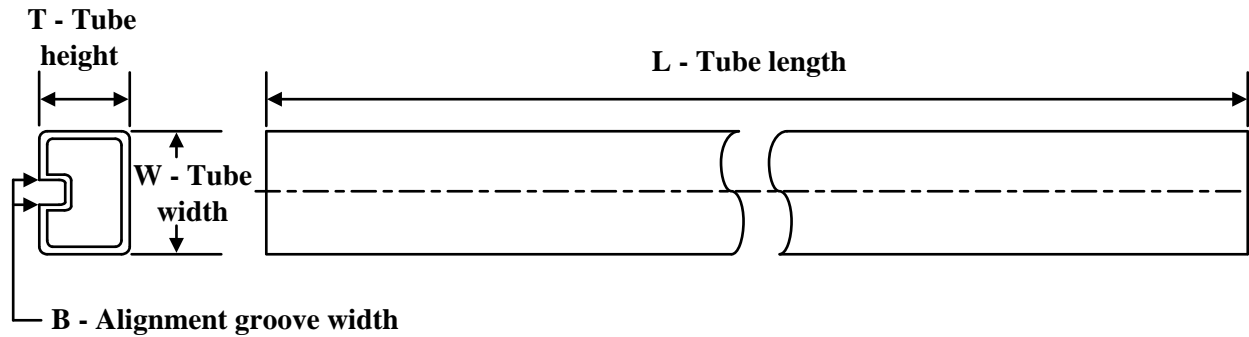
TUBE

*All dimensions are nominal

Device	Package Name	Package Type	Pins	SPQ	L (mm)	W (mm)	T (μm)	B (mm)
LM2903P	P	PDIP	8	50	506	13.97	11230	4.32
LM2903P.Z	P	PDIP	8	50	506	13.97	11230	4.32
LM2903QD	D	SOIC	8	75	505.46	6.76	3810	4
LM293P	P	PDIP	8	50	506	13.97	11230	4.32
LM293P.Z	P	PDIP	8	50	506	13.97	11230	4.32
LM393AP	P	PDIP	8	50	506.1	9	600	5.4
LM393AP	P	PDIP	8	50	506	13.97	11230	4.32
LM393AP.Z	P	PDIP	8	50	506.1	9	600	5.4
LM393AP.Z	P	PDIP	8	50	506	13.97	11230	4.32
LM393P	P	PDIP	8	50	506.1	9	600	5.4
LM393P	P	PDIP	8	50	506	13.97	11230	4.32
LM393P.Z	P	PDIP	8	50	506	13.97	11230	4.32
LM393P.Z	P	PDIP	8	50	506.1	9	600	5.4
LM393PE3	P	PDIP	8	50	506.1	9	600	5.4
LM393PE4	P	PDIP	8	50	506	13.97	11230	4.32
LM393PE4.Z	P	PDIP	8	50	506	13.97	11230	4.32
LM393PS	PS	SOP	8	80	530	10.5	4000	4.1

P (R-PDIP-T8)

PLASTIC DUAL-IN-LINE PACKAGE



- NOTES:
- A. All linear dimensions are in inches (millimeters).
 - B. This drawing is subject to change without notice.
 - C. Falls within JEDEC MS-001 variation BA.

GENERIC PACKAGE VIEW

DSG 8

WSON - 0.8 mm max height

2 x 2, 0.5 mm pitch

PLASTIC SMALL OUTLINE - NO LEAD

This image is a representation of the package family, actual package may vary.
Refer to the product data sheet for package details.

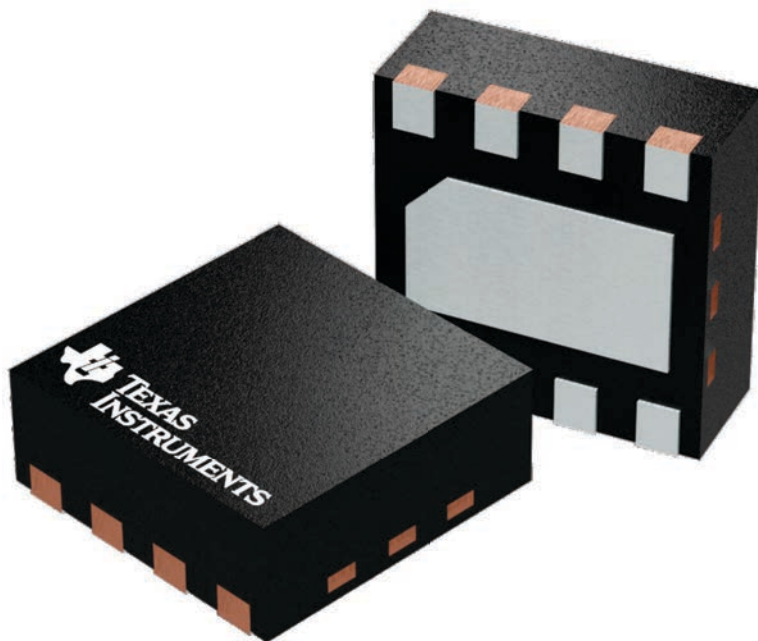

4224783/A

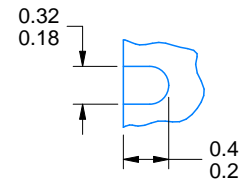
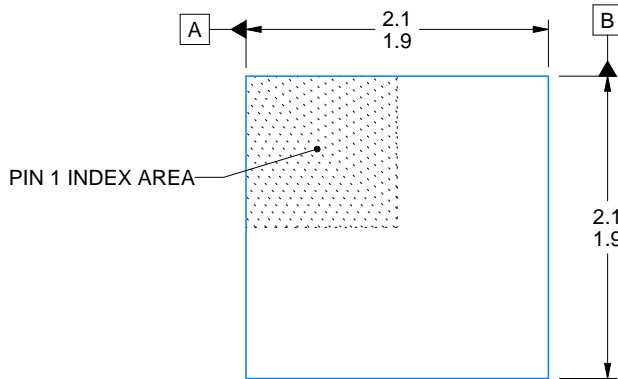

ALTERNATIVE TERMINAL SHAPE TYPICAL

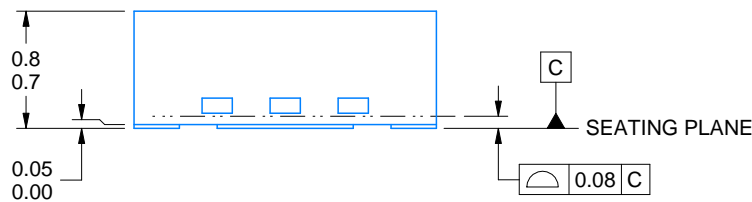

SIDE WALL METAL THICKNESS DIM A	
OPTION 1	OPTION 2
0.1	0.2

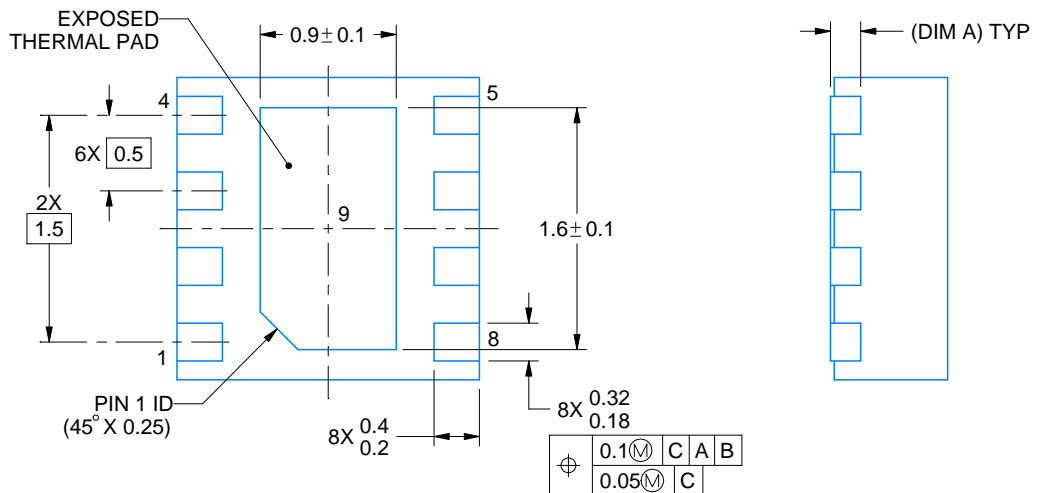

4218900/E 08/2022

NOTES:

1. All linear dimensions are in millimeters. Any dimensions in parenthesis are for reference only. Dimensioning and tolerancing per ASME Y14.5M.
2. This drawing is subject to change without notice.
3. The package thermal pad must be soldered to the printed circuit board for thermal and mechanical performance.

EXAMPLE BOARD LAYOUT

DSG0008A

WSON - 0.8 mm max height

PLASTIC SMALL OUTLINE - NO LEAD

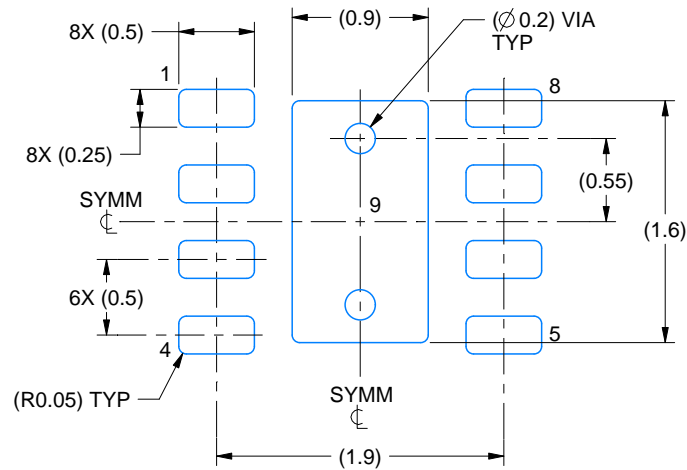

LAND PATTERN EXAMPLE
SCALE:20X

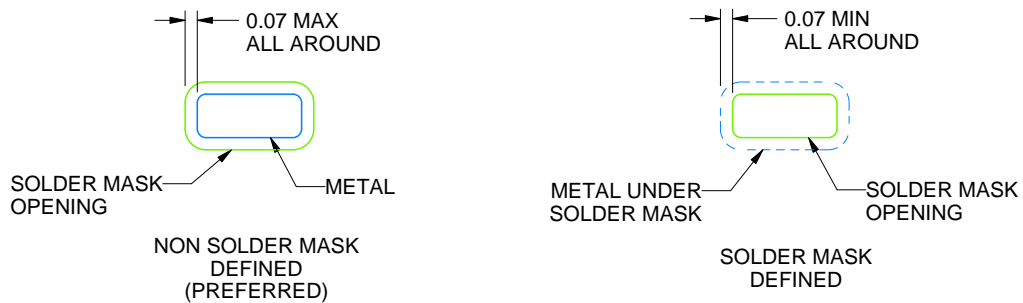

SOLDER MASK DETAILS

4218900/E 08/2022

NOTES: (continued)

4. This package is designed to be soldered to a thermal pad on the board. For more information, see Texas Instruments literature number SLUA271 (www.ti.com/lit/slua271).
5. Vias are optional depending on application, refer to device data sheet. If any vias are implemented, refer to their locations shown on this view. It is recommended that vias under paste be filled, plugged or tented.

EXAMPLE STENCIL DESIGN

DSG0008A

WSON - 0.8 mm max height

PLASTIC SMALL OUTLINE - NO LEAD

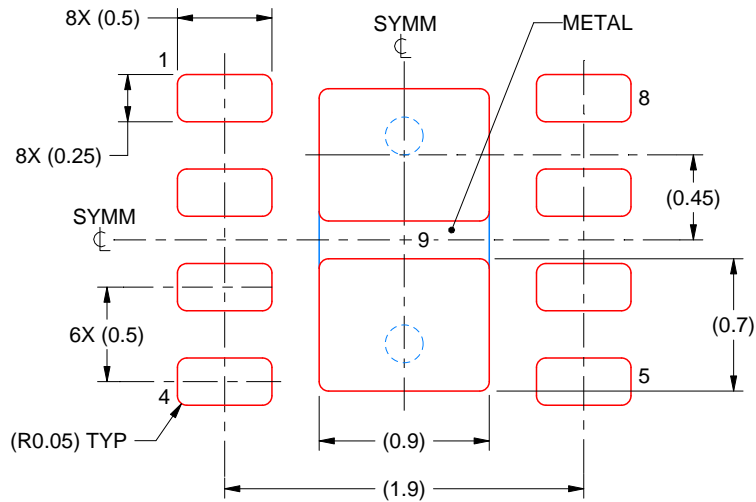

SOLDER PASTE EXAMPLE
BASED ON 0.125 mm THICK STENCIL

EXPOSED PAD 9:
87% PRINTED SOLDER COVERAGE BY AREA UNDER PACKAGE
SCALE:25X

4218900/E 08/2022

NOTES: (continued)

6. Laser cutting apertures with trapezoidal walls and rounded corners may offer better paste release. IPC-7525 may have alternate design recommendations.

PW0008A



PACKAGE OUTLINE
TSSOP - 1.2 mm max height

SMALL OUTLINE PACKAGE

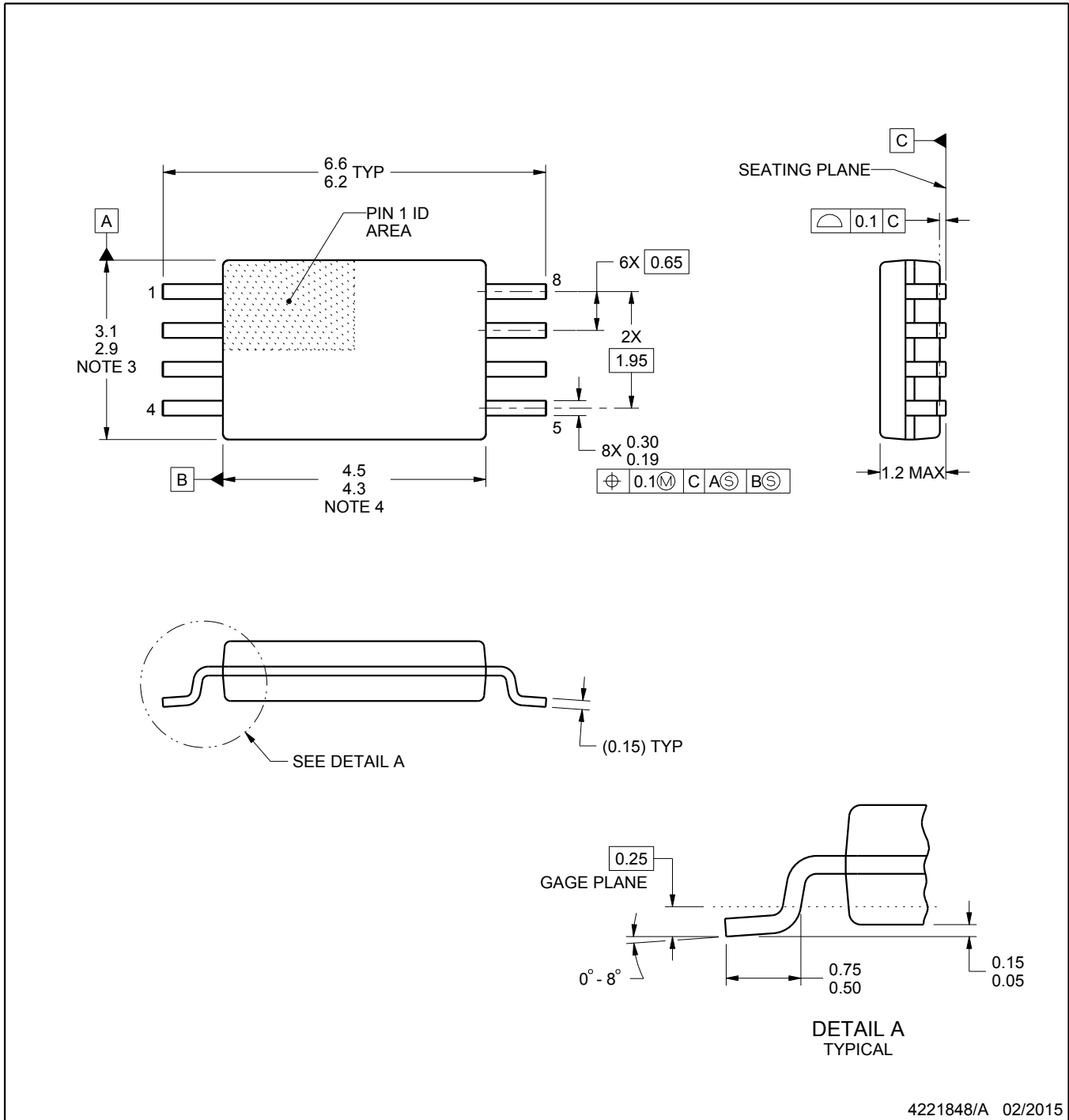

4221848/A 02/2015

NOTES:

1. All linear dimensions are in millimeters. Any dimensions in parenthesis are for reference only. Dimensioning and tolerancing per ASME Y14.5M.
2. This drawing is subject to change without notice.
3. This dimension does not include mold flash, protrusions, or gate burrs. Mold flash, protrusions, or gate burrs shall not exceed 0.15 mm per side.
4. This dimension does not include interlead flash. Interlead flash shall not exceed 0.25 mm per side.
5. Reference JEDEC registration MO-153, variation AA.

EXAMPLE BOARD LAYOUT

PW0008A

TSSOP - 1.2 mm max height

SMALL OUTLINE PACKAGE



LAND PATTERN EXAMPLE
SCALE:10X



SOLDER MASK DETAILS
NOT TO SCALE

4221848/A 02/2015

NOTES: (continued)

- 6. Publication IPC-7351 may have alternate designs.
- 7. Solder mask tolerances between and around signal pads can vary based on board fabrication site.

EXAMPLE STENCIL DESIGN

PW0008A

TSSOP - 1.2 mm max height

SMALL OUTLINE PACKAGE



SOLDER PASTE EXAMPLE
BASED ON 0.125 mm THICK STENCIL
SCALE:10X

4221848/A 02/2015

NOTES: (continued)

8. Laser cutting apertures with trapezoidal walls and rounded corners may offer better paste release. IPC-7525 may have alternate design recommendations.
9. Board assembly site may have different recommendations for stencil design.

DGK0008A



PACKAGE OUTLINE

VSSOP - 1.1 mm max height

SMALL OUTLINE PACKAGE



4214862/A 04/2023

NOTES:

PowerPAD is a trademark of Texas Instruments.

1. All linear dimensions are in millimeters. Any dimensions in parenthesis are for reference only. Dimensioning and tolerancing per ASME Y14.5M.
2. This drawing is subject to change without notice.
3. This dimension does not include mold flash, protrusions, or gate burrs. Mold flash, protrusions, or gate burrs shall not exceed 0.15 mm per side.
4. This dimension does not include interlead flash. Interlead flash shall not exceed 0.25 mm per side.
5. Reference JEDEC registration MO-187.

EXAMPLE BOARD LAYOUT

DGK0008A

™ VSSOP - 1.1 mm max height

SMALL OUTLINE PACKAGE

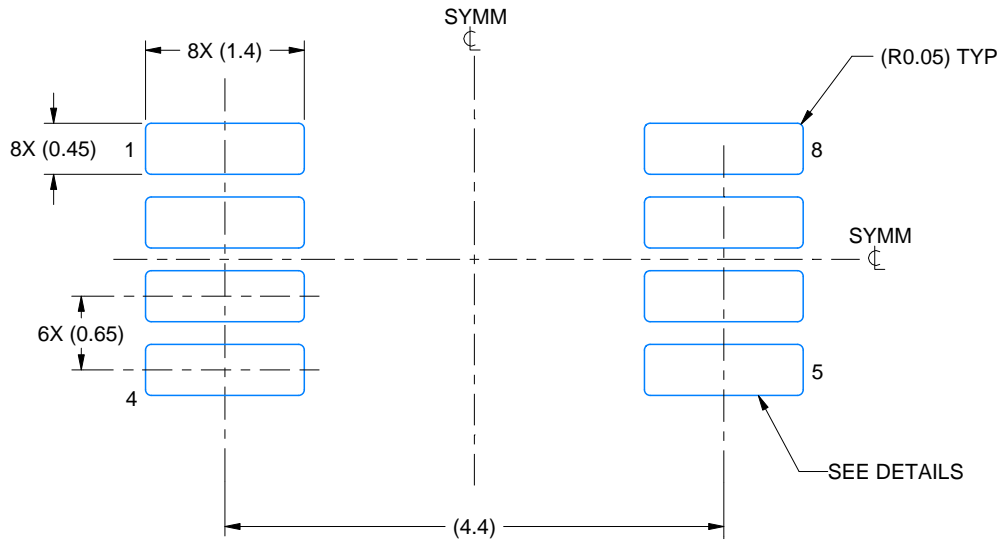

LAND PATTERN EXAMPLE
EXPOSED METAL SHOWN
SCALE: 15X

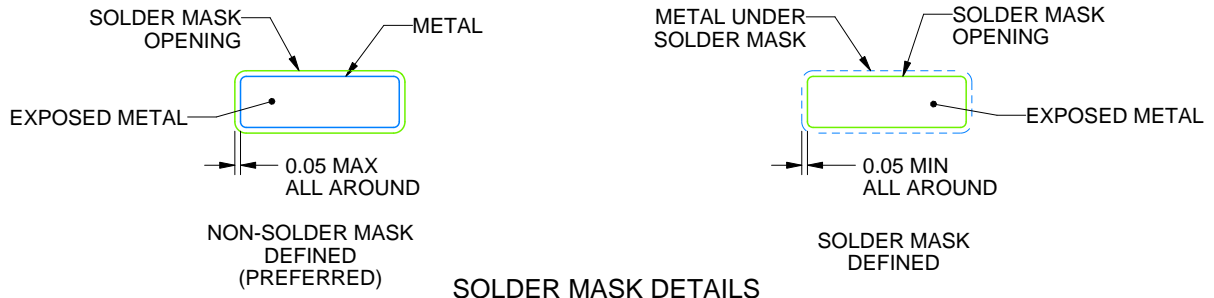

SOLDER MASK DETAILS

4214862/A 04/2023

NOTES: (continued)

6. Publication IPC-7351 may have alternate designs.
7. Solder mask tolerances between and around signal pads can vary based on board fabrication site.
8. Vias are optional depending on application, refer to device data sheet. If any vias are implemented, refer to their locations shown on this view. It is recommended that vias under paste be filled, plugged or tented.
9. Size of metal pad may vary due to creepage requirement.

EXAMPLE STENCIL DESIGN

DGK0008A

TM VSSOP - 1.1 mm max height

SMALL OUTLINE PACKAGE



SOLDER PASTE EXAMPLE
SCALE: 15X

4214862/A 04/2023

NOTES: (continued)

11. Laser cutting apertures with trapezoidal walls and rounded corners may offer better paste release. IPC-7525 may have alternate design recommendations.
12. Board assembly site may have different recommendations for stencil design.

DDF0008A



PACKAGE OUTLINE

SOT-23-THIN - 1.1 mm max height

PLASTIC SMALL OUTLINE

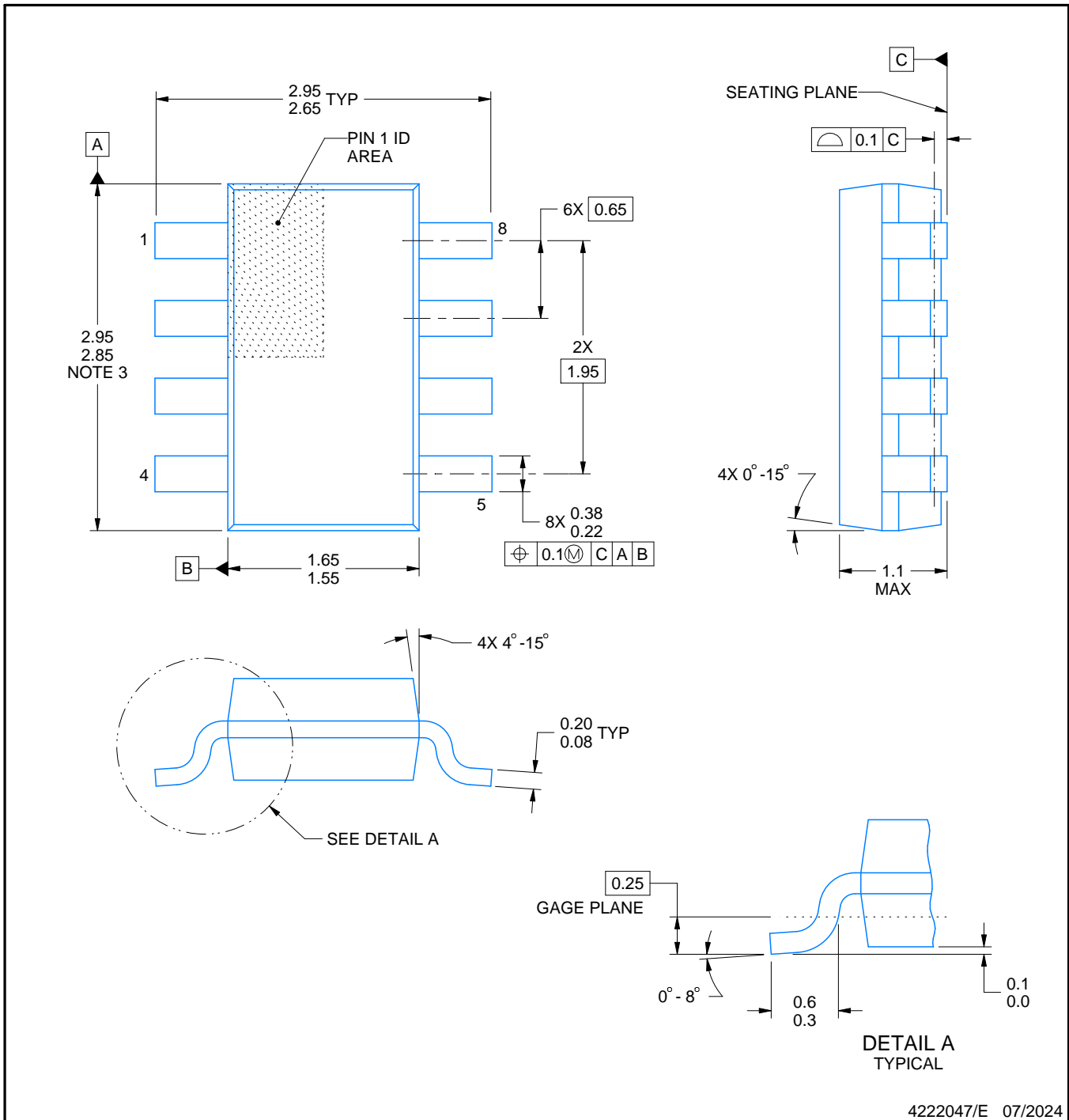

NOTES:

1. All linear dimensions are in millimeters. Any dimensions in parenthesis are for reference only. Dimensioning and tolerancing per ASME Y14.5M.
2. This drawing is subject to change without notice.
3. This dimension does not include mold flash, protrusions, or gate burrs. Mold flash, protrusions, or gate burrs shall not exceed 0.15 mm per side.

EXAMPLE BOARD LAYOUT

DDF0008A

SOT-23-THIN - 1.1 mm max height

PLASTIC SMALL OUTLINE

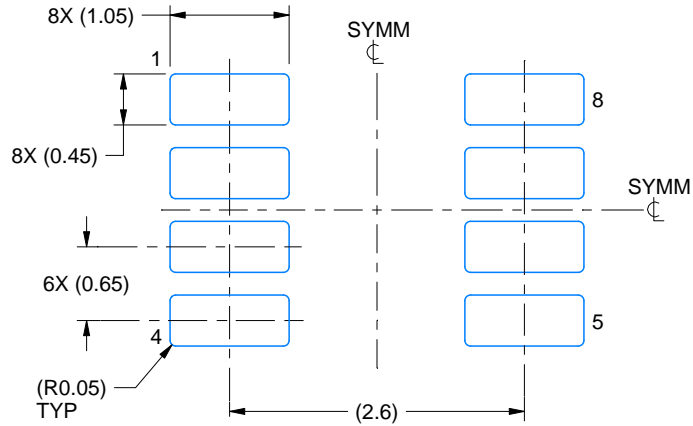

LAND PATTERN EXAMPLE
EXPOSED METAL SHOWN
SCALE:15X

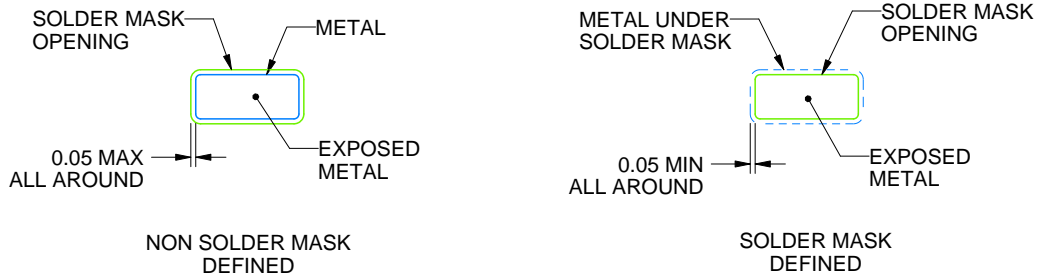

SOLDER MASK DETAILS

4222047/E 07/2024

NOTES: (continued)

- 4. Publication IPC-7351 may have alternate designs.
- 5. Solder mask tolerances between and around signal pads can vary based on board fabrication site.

EXAMPLE STENCIL DESIGN

DDF0008A

SOT-23-THIN - 1.1 mm max height

PLASTIC SMALL OUTLINE

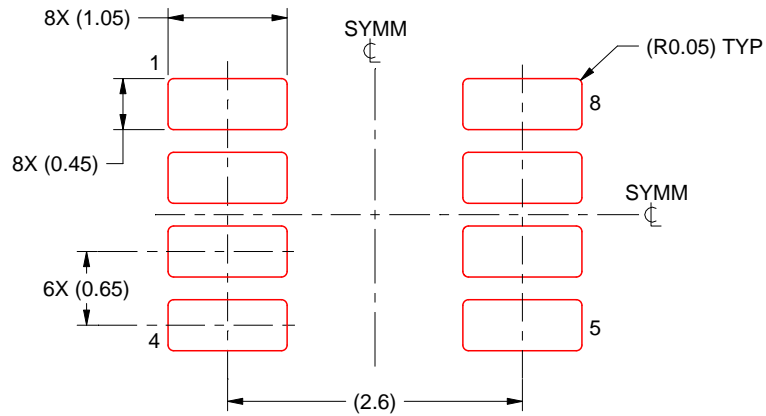

SOLDER PASTE EXAMPLE
BASED ON 0.125 mm THICK STENCIL
SCALE:15X

4222047/E 07/2024

NOTES: (continued)

6. Laser cutting apertures with trapezoidal walls and rounded corners may offer better paste release. IPC-7525 may have alternate design recommendations.
7. Board assembly site may have different recommendations for stencil design.



D0008A

PACKAGE OUTLINE

SOIC - 1.75 mm max height

SMALL OUTLINE INTEGRATED CIRCUIT



4214825/C 02/2019

NOTES:

1. Linear dimensions are in inches [millimeters]. Dimensions in parenthesis are for reference only. Controlling dimensions are in inches. Dimensioning and tolerancing per ASME Y14.5M.
2. This drawing is subject to change without notice.
3. This dimension does not include mold flash, protrusions, or gate burrs. Mold flash, protrusions, or gate burrs shall not exceed .006 [0.15] per side.
4. This dimension does not include interlead flash.
5. Reference JEDEC registration MS-012, variation AA.

EXAMPLE BOARD LAYOUT

D0008A

SOIC - 1.75 mm max height

SMALL OUTLINE INTEGRATED CIRCUIT



LAND PATTERN EXAMPLE
 EXPOSED METAL SHOWN
 SCALE:8X



SOLDER MASK DETAILS

4214825/C 02/2019

NOTES: (continued)

- 6. Publication IPC-7351 may have alternate designs.
- 7. Solder mask tolerances between and around signal pads can vary based on board fabrication site.

EXAMPLE STENCIL DESIGN

D0008A

SOIC - 1.75 mm max height

SMALL OUTLINE INTEGRATED CIRCUIT



SOLDER PASTE EXAMPLE
BASED ON .005 INCH [0.125 MM] THICK STENCIL
SCALE:8X

4214825/C 02/2019

NOTES: (continued)

8. Laser cutting apertures with trapezoidal walls and rounded corners may offer better paste release. IPC-7525 may have alternate design recommendations.
9. Board assembly site may have different recommendations for stencil design.

MECHANICAL DATA

PS (R-PDSO-G8)

PLASTIC SMALL-OUTLINE PACKAGE

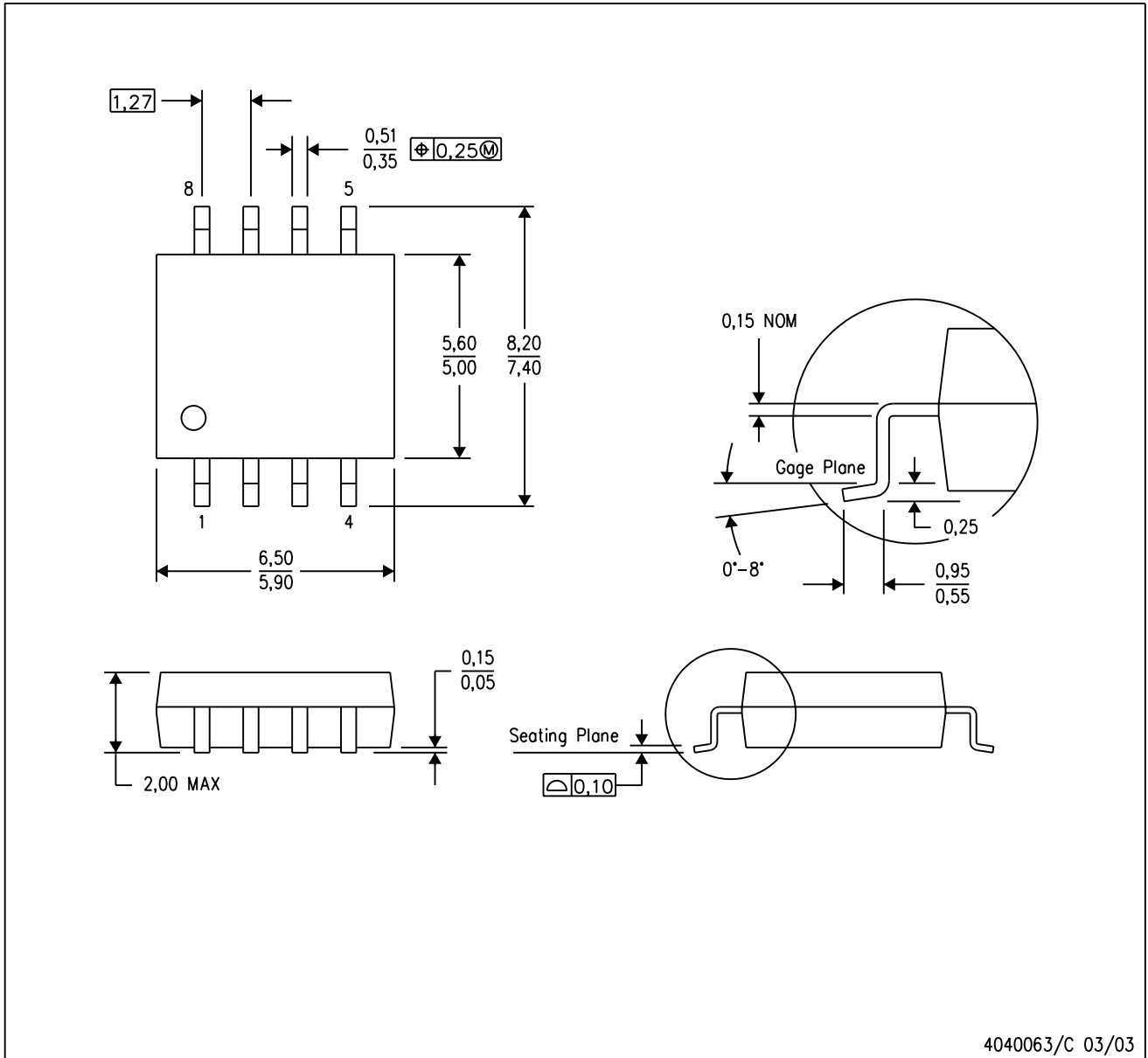

- NOTES:
- A. All linear dimensions are in millimeters.
 - B. This drawing is subject to change without notice.
 - C. Body dimensions do not include mold flash or protrusion, not to exceed 0,15.

PS (R-PDSO-G8)

PLASTIC SMALL OUTLINE

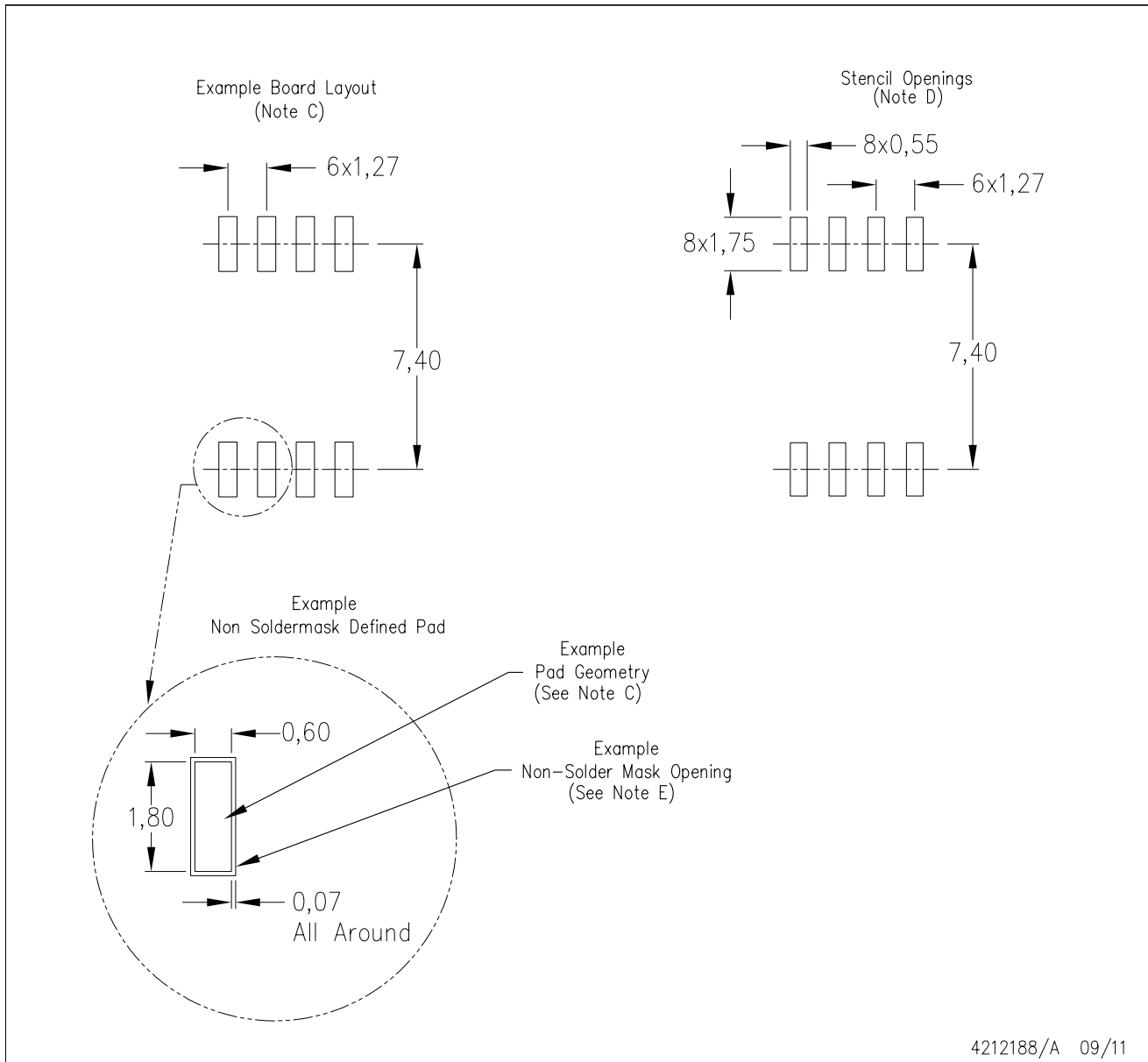

- NOTES:
- A. All linear dimensions are in millimeters.
 - B. This drawing is subject to change without notice.
 - C. Publication IPC-7351 is recommended for alternate designs.
 - D. Laser cutting apertures with trapezoidal walls and also rounding corners will offer better paste release. Customers should contact their board assembly site for stencil design recommendations. Refer to IPC-7525 for other stencil recommendations.
 - E. Customers should contact their board fabrication site for solder mask tolerances between and around signal pads.

重要通知和免责声明

TI“按原样”提供技术和可靠性数据（包括数据表）、设计资源（包括参考设计）、应用或其他设计建议、网络工具、安全信息和其他资源，不保证没有瑕疵且不做任何明示或暗示的担保，包括但不限于对适销性、某特定用途方面的适用性或不侵犯任何第三方知识产权的暗示担保。

这些资源可供使用 TI 产品进行设计的熟练开发人员使用。您将自行承担以下全部责任：(1) 针对您的应用选择合适的 TI 产品，(2) 设计、验证并测试您的应用，(3) 确保您的应用满足相应标准以及任何其他功能安全、信息安全、监管或其他要求。

这些资源如有变更，恕不另行通知。TI 授权您仅可将这些资源用于研发本资源所述的 TI 产品的相关应用。严禁以其他方式对这些资源进行复制或展示。您无权使用任何其他 TI 知识产权或任何第三方知识产权。您应全额赔偿因在这些资源的使用中对 TI 及其代表造成的任何索赔、损害、成本、损失和债务，TI 对此概不负责。

TI 提供的产品受 [TI 的销售条款](#) 或 [ti.com](#) 上其他适用条款/TI 产品随附的其他适用条款的约束。TI 提供这些资源并不会扩展或以其他方式更改 TI 针对 TI 产品发布的适用的担保或担保免责声明。

TI 反对并拒绝您可能提出的任何其他或不同的条款。

邮寄地址：Texas Instruments, Post Office Box 655303, Dallas, Texas 75265
版权所有 © 2025，德州仪器 (TI) 公司