

DS1776QML PI 总线收发器

1 特性

- 类似于桥接负载 (BTL)
- 低功耗 $I_{CC1} = 41\text{mA}$ (最大值)
- B 输出控制的斜率
- B 输入抗扰度: 4ns (典型值)
- 与 Signetics 54F776 引脚和功能兼容

2 说明

DS1776 是一款八路 PI 总线收发器。A 到 B 的路径被锁存。B 输出是串联肖特基二极管的集电极开路输出，可确保将 B 输出负载降至最低。B 输出还具有斜升和斜降时间 (典型值为 2.5ns)，可确保将 PI 总线振铃最小化。B 输入具有毛刺脉冲抑制电路，典型值为 4ns。

该器件采用德州仪器 (TI) 的双极互补金属氧化物半导体 (Bi-CMOS) 工艺设计，在工作和禁用状态下均可实现低功耗。其交流性能针对 PI 总线的互操作性要求进行了优化。

DS1776 是一款八路锁存收发器，旨在为高性能线或总线提供电气接口。该总线的负载特性阻抗范围为 20Ω 至 50Ω，两端采用 30Ω 至 40Ω 范围内的电阻进行端接。

DS1776 是一款具有集电极开路 B 和三态 A 端口输出驱动器的八路双向收发器。该器件为 A 端口信号提供了锁存功能。B 端口输出驱动器设计为在 2V 电压时具有 100mA 灌电流，并且特有受控线性斜坡，能够最大限度降低总线上的串扰和振铃。

该器件提供了独立的高电平控制电压 (V_X)，以防止 A 侧输出高电平超过未来高密度处理器的电源电压。对于 5V 系统， V_X 连接至 V_{CC} 。

器件信息(1)

| 器件型号 | 封装 | 封装尺寸 (标称值) |
|-----------|-----------|-------------------|
| DS1776QML | LCCC (FK) | 11.43mm x 11.43mm |

(1) 如需了解所有可用封装，请见数据表末尾的可订购产品附录。

逻辑符号

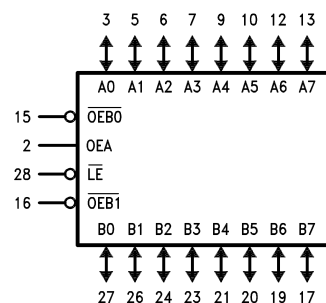

目录

| | |
|---|--|
| <p>1 特性 1</p> <p>2 说明 1</p> <p>3 修订历史记录 2</p> <p>4 Pin Configuration and Functions 3</p> <p>5 Specifications 4</p> <p style="padding-left: 20px;">5.1 Absolute Maximum Ratings 4</p> <p style="padding-left: 20px;">5.2 ESD Ratings 4</p> <p style="padding-left: 20px;">5.3 Recommend Operating Conditions 4</p> <p style="padding-left: 20px;">5.4 Thermal Information 4</p> <p style="padding-left: 20px;">5.5 Quality Conformance Inspection 5</p> <p style="padding-left: 20px;">5.6 Pi Bus Transceiver DS1776 DC Parameters 5</p> <p style="padding-left: 20px;">5.7 Pi Bus Transceiver DS1776 AC Parameters: B To A Path 6</p> | <p>5.8 Pi Bus Transceiver DS1776 AC Parameters: A To B Path 7</p> <p>5.9 Pi Bus Transceiver DS1776 AC Parameters: Setup / Hold / Pulse Width Specifications 7</p> <p>5.10 Test Circuit And Waveforms 8</p> <p>6 Detailed Description 10</p> <p style="padding-left: 20px;">6.1 Controller Power Sequencing Operation 11</p> <p>7 器件和文档支持 12</p> <p style="padding-left: 20px;">7.1 社区资源 12</p> <p style="padding-left: 20px;">7.2 商标 12</p> <p style="padding-left: 20px;">7.3 静电放电警告 12</p> <p style="padding-left: 20px;">7.4 Glossary 12</p> <p>8 机械、封装和可订购信息 12</p> |
|---|--|

3 修订历史记录

NOTE: Page numbers for previous revisions may differ from page numbers in the current version.

| Changes from Revision A (April 2013) to Revision B | Page |
|--|------|
| • 已删除 产品预览..... | 1 |
| • 已更改 布局以符合新的 TI 格式 | 1 |

| 发布时间 | 修订版本 | 部分 | 更改 |
|-----------------|------|-----------|---|
| 2012 年 7 月 30 日 | A1 | 新版本, 公司格式 | 已将 MDS 数据表转换为一种公司数据表格式。MNDS1776-X 版本 2A0. 将被归档。 |
| 2013 年 4 月 12 日 | A | 全部 | 已将国家半导体数据表的版面布局更改为 TI 格式。 |

4 Pin Configuration and Functions

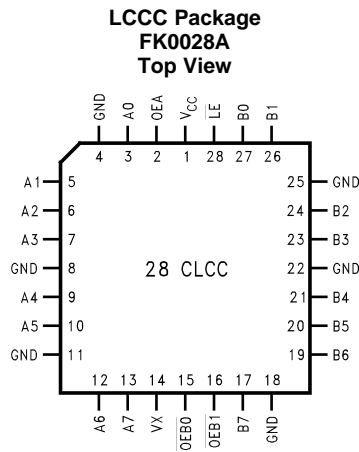

Pin Descriptions

| PIN | | I/O | DESCRIPTION |
|--------------------|-----|-----|---|
| NAME | NO. | | |
| A0 | 3 | I/O | TTL Level, latched input/TRI-STATE output (with V_X control option) |
| A1 | 5 | I/O | |
| A2 | 6 | I/O | |
| A3 | 7 | I/O | |
| A4 | 9 | I/O | |
| A5 | 10 | I/O | |
| A6 | 12 | I/O | |
| A7 | 13 | I/O | Data input with special threshold circuitry to reject noise/Open Collector output, High current drive |
| B0 | 27 | I/O | |
| B1 | 26 | I/O | |
| B2 | 24 | I/O | |
| B3 | 23 | I/O | |
| B4 | 21 | I/O | |
| B5 | 20 | I/O | |
| B6 | 19 | I/O | Enables the B outputs when both pins are low |
| $\overline{OEB} 0$ | 15 | I | |
| $\overline{OEB} 1$ | 16 | I | Enables the A outputs when High |
| OEA | 2 | I | |
| \overline{LE} | 28 | I | Latched when High (a special delay feature is built in for proper enabling times) |
| V_X | 14 | I | Clamping voltage keeping V_{OH} from rising above V_X ($V_X = V_{CC}$ for normal use) |

5 Specifications

5.1 Absolute Maximum Ratings⁽¹⁾

| | MIN | MAX | UNIT | |
|---|-----------|------------|------|----|
| Supply Voltage (V_{CC}) | -0.5 | 7.0 | V | |
| V_X , V_{OH} Output Level Control Voltage (A Outputs) | -0.5 | 7.0 | V | |
| $\overline{OE}B_n$, OEA, \overline{LE} Input Voltage (V_I) | -0.5 | 7.0 | V | |
| A0–A7, B0–B7 Input Voltage (V_I) | -0.5 | 5.5 | V | |
| Input Current (I_I) | -40 | 5 | mA | |
| Voltage Applied to Output in High Output State (V_O) | -0.5V | + V_{CC} | | |
| A0–A7 Current Applied to Output in Low Output State (I_O) | 40 | 40 | mA | |
| B0–B7 Current Applied to Output in Low Output State (I_O) | 200 | 200 | mA | |
| Lead Temperature (Soldering 10 Sec.) | | 260 | °C | |
| Power Dissipation ⁽²⁾ | | 740 | mW | |
| Storage temperature | T_{stg} | -65 | +150 | °C |

- (1) Absolute Maximum Ratings indicate limits beyond which damage to the device may occur. Operating Ratings indicate conditions for which the device is functional, but do not guarantee specific performance limits. For specified specifications and test conditions, see the Electrical Characteristics. The specified specifications apply only for the test conditions listed. Some performance characteristics may degrade when the device is not operated under the listed test conditions.
- (2) The maximum power dissipation must be derated at elevated temperatures and is dictated by T_{Jmax} (maximum junction temperature), θ_{JA} (package junction to ambient thermal resistance), and T_A (ambient temperature). The maximum allowable power dissipation at any temperature is $P_{Dmax} = (T_{Jmax} - T_A)/\theta_{JA}$ or the number given in the Absolute Maximum Ratings, whichever is lower.

5.2 ESD Ratings

| | MIN | MAX | UNIT |
|---|-----|-----|------|
| $V_{(ESD)}$ Electrostatic discharge Human body model (HBM), per ANSI/ESDA/JEDEC JS-001, all pins ^{(1) (2)} | 500 | | V |

(1) JEDEC document JEP155 states that 500-V HBM allows safe manufacturing with a standard ESD control process.

(2) $C_{Zap} = 120$ pF, $R_{Zap} = 1500\Omega$

5.3 Recommend Operating Conditions

| | MIN | MAX | UNIT |
|---------------------------------|-----|------|------|
| Supply Voltage (V_{CC}) | 4.5 | 5.5 | V |
| Operating Temp. Range (T_A) | -55 | +125 | °C |

5.4 Thermal Information

| THERMAL METRIC ⁽¹⁾ | | DS1776QML | UNIT |
|-------------------------------|---|------------------|------|
| | | FK0028A | |
| | | 28 PINS | |
| $R_{\theta JA}$ | Junction-to-ambient thermal resistance | +67.5 | °C/W |
| $R_{\theta JC(top)}$ | Junction-to-case (top) thermal resistance | See MIL-STD-1835 | °C/W |

(1) For more information about traditional and new thermal metrics, see the *IC Package Thermal Metrics* application report, [SPRA953](#).

5.5 Quality Conformance Inspection

Table 1. Mil-Std-883, Method 5005 - Group A

| Subgroup | Description | Temp (°C) |
|----------|---------------------|-----------|
| 1 | Static tests at | +25 |
| 2 | Static tests at | +125 |
| 3 | Static tests at | -55 |
| 4 | Dynamic tests at | +25 |
| 5 | Dynamic tests at | +125 |
| 6 | Dynamic tests at | -55 |
| 7 | Functional tests at | +25 |
| 8A | Functional tests at | +125 |
| 8B | Functional tests at | -55 |
| 9 | Switching tests at | +25 |
| 10 | Switching tests at | +125 |
| 11 | Switching tests at | -55 |
| 12 | Settling time at | +25 |
| 13 | Settling time at | +125 |
| 14 | Settling time at | -55 |

5.6 Pi Bus Transceiver DS1776 DC Parameters

The following conditions apply, unless otherwise specified. $V_{CC} = 5.5V$

| SYMBOL | PARAMETER | CONDITIONS | NOTES | MIN | MAX | UNIT | SUB-GROUPS |
|-----------|--|--|--------------------|------|-------|---------|------------|
| V_{IL2} | Low Level In Voltage Bn | $V_{CC} = 4.5$ | See ⁽¹⁾ | 1.45 | | V | 1, 2, 3 |
| V_{IL1} | All Other Inputs | $V_{CC} = 4.5$ | | .8 | | V | 1, 2, 3 |
| V_{IH1} | Hi Level Input Voltage \overline{OEBn} , OEA, An, LE | | See ⁽¹⁾ | 2.0 | | V | 1, 2, 3 |
| V_{IH2} | High Level In Voltage B0-B7 | | | 1.6 | | V | 1, 2, 3 |
| I_{OH1} | High Level Output Current An | $V_{CC} = 4.5$, $V_{IN} = V_{IH}$ or V_{IL} , $V_{OH} = 2.5V$ | See ⁽²⁾ | | -3.0 | mA | 1, 2, 3 |
| I_{OH2} | High Level Output Current Bn | $V_{CC} = 5.5$, $V_{IL} = 0.8V$, $V_{IH} = 2.0V$, $V_{OH} = 2.1V$ | | 100 | | μA | 1, 2, 3 |
| I_{OL1} | Low Level Output Current An | $V_{CC} = 4.5$, $V_{IN} = V_{IH}$ or V_{IL} , $V_{OL} = 0.5V$ | See ⁽³⁾ | 20 | | mA | 1, 2, 3 |
| I_{OL2} | Low Level Output Current Bn | $V_{CC} = 4.5$, $V_{IN} = V_{IH}$ or V_{IL} , $V_{OL} = 1.15V$ | | 100 | | mA | 1, 2, 3 |
| V_{OH} | High Level Output Voltage An | $V_{CC} = 4.5$, $V_{IN} = V_{IL}$ or V_{IH} , $I_{OH} = -3$ mA, $V_X = 4.5V$ | | 2.5 | 4.5 | V | 1, 2, 3 |
| | | $V_{CC} = 4.5$, $V_{IN} = V_{IL}$ or V_{IH} , $I_{OH} = -0.4$ mA, $V_X = 3.13$ to $3.47V$ | | 2.5 | V_X | V | 1, 2, 3 |
| V_{OL} | Low Level Output Voltage An | $V_{CC} = 4.5$, $V_{IL} = \text{Max}$, $V_{IH} = \text{Min}$, $I_{OL} = 20\text{mA}$, $V_X = V_{CC}$ | | 0.5 | | V | 1, 2, 3 |
| V_{OLB} | Low Level Output Voltage Bn | $V_{CC} = 4.5$, $V_{IL} = \text{Max}$, $V_{IH} = \text{Min}$, $I_{OL} = 100\text{mA}$ | | 1.15 | | V | 1, 2, 3 |
| | | $V_{CC} = 4.5$, $V_{IL} = \text{Max}$, $V_{IH} = \text{Min}$, $I_{OL} = 4\text{mA}$ | | 0.4 | | V | 1, 2, 3 |
| V_{IK} | Input Clamp Voltage An | $V_{CC} = 4.5$, $I_I = -40\text{mA}$ | | | -0.5 | V | 1, 2, 3 |
| V_{IK} | Input Clamp Voltage Other Inputs | $V_{CC} = 4.5$, $I_I = -18\text{mA}$ | | | -1.2 | V | 1, 2, 3 |

(1) Tested Go-No-Go

(2) Same as V_{OH} test.

(3) Same as V_{OL} test.

Pi Bus Transceiver DS1776 DC Parameters (continued)

 The following conditions apply, unless otherwise specified. $V_{CC} = 5.5V$

| SYMBOL | PARAMETER | CONDITIONS | NOTES | MIN | MAX | UNIT | SUB-GROUPS | |
|--------------------|--|---|--------------------|-----|------|---------|------------|---------|
| I_{IH1} | Input Current Max Input Voltage $\overline{OE}Bn$, OEA, \overline{LE} | $V_{CC} = 5.5, V_I = 7.0V$ | | | 100 | μA | 1, 2, 3 | |
| I_{IH2} | Input Current Max Input Voltage An, Bn | $V_{CC} = 5.5, V_I = 5.5V$ | | | 1.0 | mA | 1, 2, 3 | |
| I_{IH3} | High Level Input Current $\overline{OE}Bn$, OEA, \overline{LE} | $V_{CC} = 5.5, V_I = 2.7V$ | | | 20 | μA | 1, 2, 3 | |
| I_{IH4} | High Level Input Current Bn | $V_{CC} = 5.5, V_I = 2.1V$ | | | 100 | μA | 1, 2, 3 | |
| I_{IL1} | Low Level Input Current $\overline{OE}Bn$, OEA, Except $\overline{OE}Bn$ or OEA | $V_{CC} = 5.5, V_I = 0.5V$ | | | -20 | μA | 1, 2, 3 | |
| I_{IL2} | Low Level Input Current \overline{LE} | $V_{CC} = 5.5, V_I = 0.5V$ | | | -20 | μA | 1 | |
| | | | | | -40 | μA | 2, 3 | |
| I_{IL3} | Low Level Input Current Bn | $V_{CC} = 5.5, V_I = 0.3V$ | | | -100 | μA | 1, 2, 3 | |
| $I_{OZH} + I_{IH}$ | TRI-STATE Output Current, High Level Voltage Applied An | $V_{CC} = 5.5, V_O = 2.7V$ | | | 70 | μA | 1, 2, 3 | |
| $I_{OZL} + I_{IL}$ | TRI-STATE Output Current, Low Level Voltage Applied An | $V_{CC} = 5.5, V_O = 0.5V$ | | | -70 | μA | 1, 2, 3 | |
| I_X | High Level Control Current | $V_{CC} = 5.5, V_X = 5.5V,$ $\overline{LE} = OEA = \overline{OE}Bn = 2.7V,$ $A0-A7 = 2.7, B0-B7 = 2V$ | | | -100 | 100 | μA | 1, 2, 3 |
| | | | | | -10 | 10 | mA | 1, 2, 3 |
| I_{OS} | Short Circuit Output Current A0-A7 only | $V_{CC} = 5.5, Bn = 1.9V,$ $OEA = 2.0V, \overline{OE}Bn = 2.7V,$ $V_O = 0V$ | See ⁽⁴⁾ | -60 | -150 | mA | 1, 2, 3 | |
| I_{CCH} | Supply Current (Total) I_{CCH} | $V_{CC} = 5.5, V_{IN} (An) = 5.0V$ | | | 37 | mA | 1, 2 | |
| | | | | | 41 | mA | 3 | |
| I_{CCL} | Supply Current (Total) I_{CCL} | $V_{CC} = 5.5, V_{IN} (An) = 0.5V$ | | | 38 | mA | 1, 3 | |
| | | | | | 34 | mA | 2 | |
| I_{CCZ} | Supply Current (Total) I_{CCZ} | $V_{CC} = 5.5, V_{IN} (An) = 0.5V$ | | | 35 | mA | 1, 2, 3 | |
| I_{Off} | Power Off Output Current B0-B7 | $V_{CC} = 0, Bn = 2.1V, V_{IL} = Max,$ $V_{IH} = Min$ | | | 100 | μA | 1, 2, 3 | |

(4) Not more than one output should be shorted at a time. For testing I_{OS} , the use of high speed test apparatus and/or sample-and-hold techniques are preferable in order to minimize internal heating and more accurately reflect operational values. Otherwise, prolonged shorting of a High output may raise the chip temperature above normal and thereby cause invalid readings in other parameter tests. In any sequence of parameter test, I_{OS} tests should be performed last.

5.7 Pi Bus Transceiver DS1776 AC Parameters: B To A Path

 The following conditions apply, unless otherwise specified. $V_{CC} = 5V \pm 10\%$, $C_L = 50pF$, $R_L = 500\Omega$

| SYMBOL | PARAMETER | CONDITIONS | NOTES | MIN | MAX | UNIT | SUB-GROUPS |
|-----------|--------------------------|---------------|-------|-----|-----|------|------------|
| t_{PLH} | Propagation Delay B to A | Waveform 1, 2 | | 4.5 | 17 | ns | 9, 10, 11 |
| t_{PHL} | Propagation Delay B to A | Waveform 1, 2 | | 6.0 | 17 | ns | 9, 10, 11 |
| t_{PZH} | Output Enable OEA To A | Waveform 3, 4 | | 4.0 | 17 | ns | 9, 10, 11 |
| t_{PZL} | Output Enable OEA To A | Waveform 3, 4 | | 4.0 | 21 | ns | 9, 10, 11 |
| t_{PHZ} | Output Disable OEA to A | Waveform 3, 4 | | 2.0 | 12 | ns | 9, 10, 11 |
| t_{PLZ} | Output Disable OEA to A | Waveform 3, 4 | | 2.0 | 13 | ns | 9, 10, 11 |

5.8 Pi Bus Transceiver DS1776 AC Parameters: A To B Path

The following conditions apply, unless otherwise specified. $V_{CC} = 5V \pm 10\%$, $C_L = 30pF$, $R_L = 9\Omega$

| SYMBOL | PARAMETER | CONDITIONS | NOTES | MIN | MAX | UNIT | SUB-GROUPS |
|-----------|--|---------------|-------|-----|-----|------|------------|
| t_{PLH} | Propagation Delay A to B | Waveform 1, 2 | | 2.0 | 13 | ns | 9, 11 |
| | | | | 2.0 | 17 | ns | 10 |
| t_{PHL} | Propagation Delay A to B | Waveform 1, 2 | | 2.5 | 13 | ns | 9, 10, 11 |
| t_{PLH} | Propagation Delay \overline{LE} to B | Waveform 1, 2 | | 2.0 | 16 | ns | 9, 11 |
| | | | | 2.0 | 22 | ns | 10 |
| t_{PHL} | Propagation Delay \overline{LE} to B | Waveform 1, 2 | | 2.0 | 16 | ns | 9, 10, 11 |
| t_{PLH} | Enable / Disable Time \overline{OEBn} to B | Waveform 1, 2 | | 2.0 | 13 | ns | 9, 11 |
| | | | | 2.0 | 16 | ns | 10 |
| t_{PHL} | Enable / Disable Time \overline{OEBn} to B | Waveform 1, 2 | | 3.5 | 14 | ns | 9 |
| | | | | 3.5 | 13 | ns | 10 |
| | | | | 3.5 | 16 | ns | 11 |

5.9 Pi Bus Transceiver DS1776 AC Parameters: Setup / Hold / Pulse Width Specifications

The following conditions apply, unless otherwise specified. $V_{CC} = 5V \pm 10\%$

| SYMBOL | PARAMETER | CONDITIONS | NOTES | MIN | MAX | UNIT | SUB-GROUPS |
|--------|---------------------------------|------------|-------|-----|-----|------|------------|
| t_S | A to \overline{LE} Setup | Waveform 5 | | 7.0 | | ns | 9, 10, 11 |
| t_H | A to \overline{LE} Hold | Waveform 5 | | 0.0 | | ns | 9, 10, 11 |
| t_W | \overline{LE} Pulse Width Low | Waveform 5 | | 12 | | ns | 9, 10, 11 |

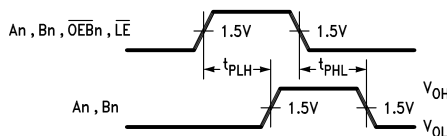

Figure 1. Propagation Delay For Data To Output

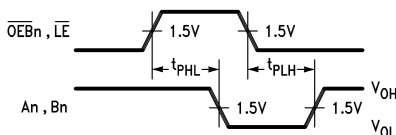

Figure 2. Propagation Delay For Data To Output

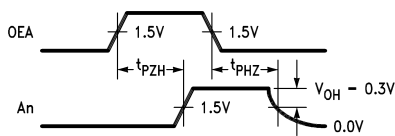

Figure 3. TRI-STATE Output Enable Time To High Level And Output Disable Time From High Level

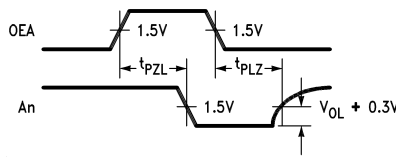
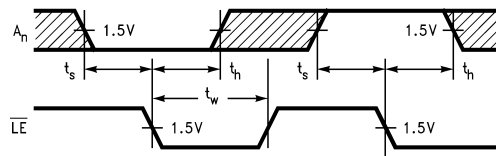

Figure 4. TRI-STATE Output Enable Time To Low Level And Output Disable Time From Low Level



The shaded areas indicate when the input is permitted to change for predictable output performance.

Figure 5. Data Setup And Hold Times And Le Pulse Widths

5.10 Test Circuit And Waveforms

Figure 6. Test Circuit For TRI-STATE Outputs On A Side

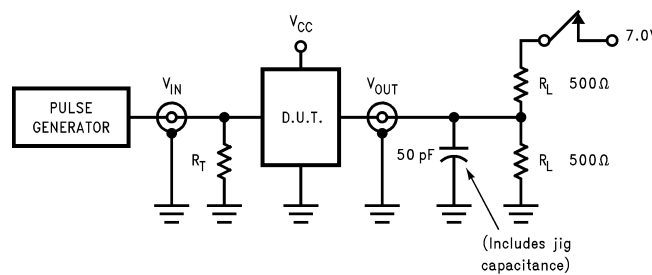
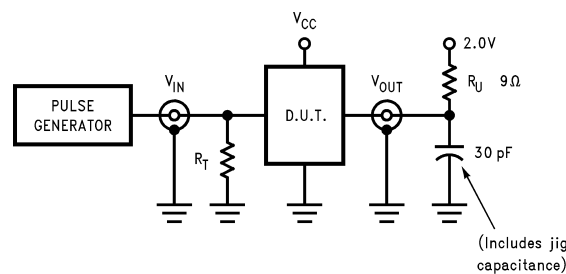

Table 2. Switch Position

| Test | Switch |
|-----------------------|--------|
| t_{pLZ} , t_{pZL} | Closed |
| All Other | Open |

Figure 7. Test Circuit For TRI-STATE Outputs On B Side



DEFINITIONS

- R_L = Load resistor 500Ω
- C_L = Load capacitance includes jig and probe capacitance
- R_T = Termination resistance should be equal to Z_O of pulse generators.
- R_U = Pull up resistor

Figure 8. Input Pulse Definition

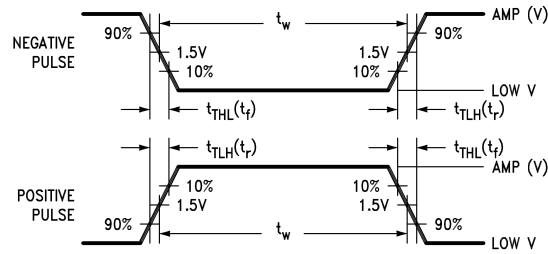

| Input Pulse Characteristics | | | | | | |
|-----------------------------|-----------|-------|-----------|--------|-----------|-----------|
| | Amplitude | Low V | Rep. Rate | t_w | t_{TLH} | t_{THL} |
| A Side | 3.0V | 0.0V | 1 MHz | 500 ns | 2 ns | 2 ns |
| B Side | 2.0V | 1.0V | 1 MHz | 500 ns | 2 ns | 2 ns |

6 Detailed Description

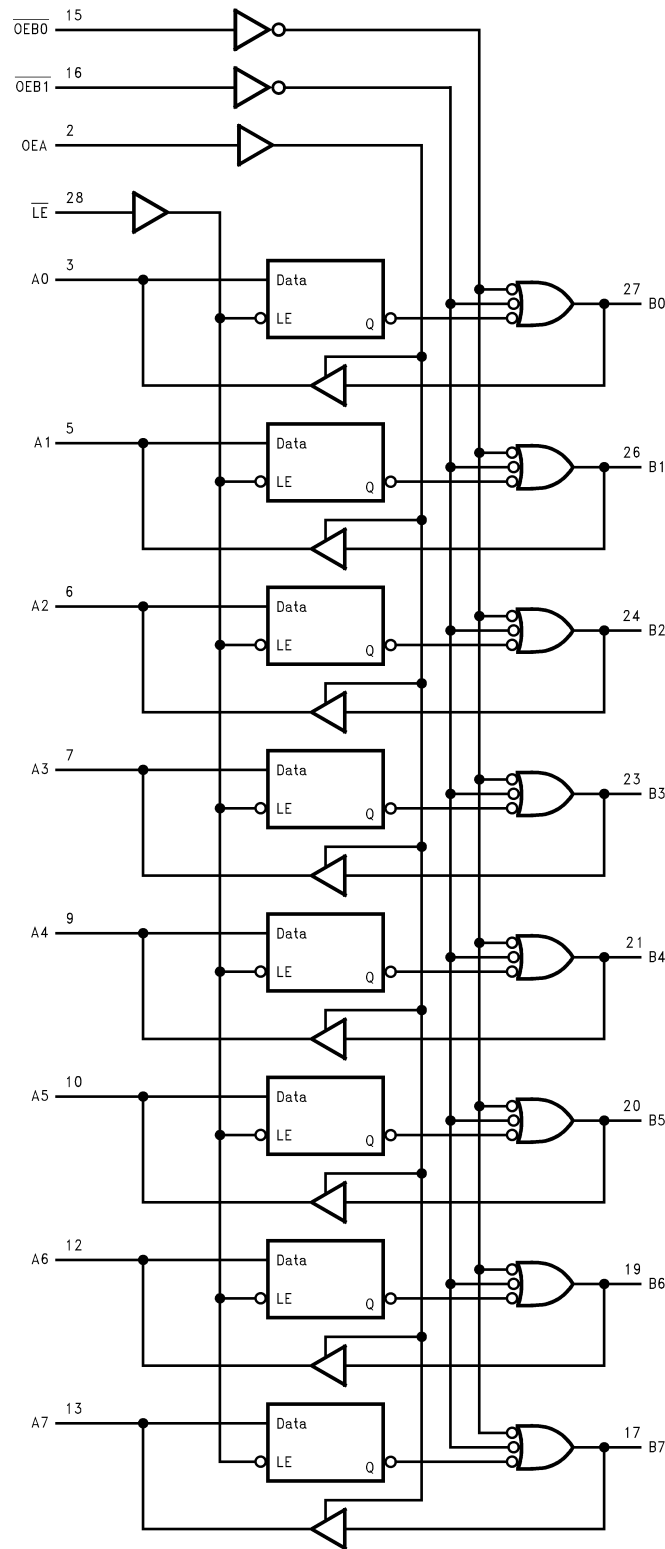

V_{CC} = Pin 1
V_X = Pin 14
Gnd = Pins 4, 8, 11, 18, 22, 25

Figure 9. Functional Logic Diagram

Table 3. Function Table⁽¹⁾

| Inputs | | | | | | Latch | Outputs | | Mode |
|--------|-------------------|-----------------|-----|---------------------|---------------------|--------------------|--------------------|--------------------|--------------------------------|
| An | Bn ⁽²⁾ | \overline{LE} | OEA | $\overline{OEB\ 0}$ | $\overline{OEB\ 1}$ | State | An | Bn | |
| H | X | L | L | L | L | H | Z | H | A TRI-STATE, Data from A to B |
| L | X | L | L | L | L | L | Z | L | |
| X | X | H | L | L | L | Qn | Z | Qn | A TRI-STATE, Latched Data to B |
| — | — | L | H | L | L | See ⁽³⁾ | See ⁽²⁾ | See ⁽²⁾ | Feedback: A to B, B to A |
| — | H | H | H | L | L | H ⁽⁴⁾ | H | off ⁽⁴⁾ | Preconditioned Latch Enabling |
| — | L | H | H | L | L | H ⁽⁴⁾ | L | off ⁽⁴⁾ | Data Transfer from B to A |
| — | — | H | H | L | L | Qn | Qn | Qn | Latch State to A and B |
| H | X | L | L | H | X | H | Z | off | |
| L | X | L | L | H | X | L | Z | off | B off and A TRI-STATE |
| X | X | H | L | H | X | Qn | Z | off | |
| — | H | L | H | H | X | H | H | off | |
| — | L | L | H | H | X | L | L | off | |
| — | H | H | H | H | X | Qn | H | off | B off, Data from B to A |
| — | L | H | H | H | X | Qn | L | off | |
| H | X | L | L | X | H | H | Z | off | |
| L | X | L | L | X | H | L | Z | off | B off and A TRI-STATE |
| X | X | H | L | X | H | Qn | Z | off | |
| — | H | L | H | X | H | H | H | off | |
| — | L | L | H | X | H | L | L | off | B off, Data from B to A |
| — | H | H | H | X | H | Qn | H | off | |
| — | L | H | H | X | H | Qn | L | off | |

(1) H = High Voltage Level

L = Low Voltage Level

X = Don't Care

— = Input not externally driven

Z = High Impedance (off) state

Qn = High or Low voltage level one setup time prior to the Low-to-High \overline{LE} transition

(2) Condition will cause a feedback loop path; A to B and B to A.

(3) Precaution should be taken to ensure that the B inputs do not float. If they do, they are equal to a Low state.

(4) The latch must be preconditioned such that B inputs may assume a High or Low level while $\overline{OEB\ 0}$ and $\overline{OEB\ 1}$, are Low and \overline{LE} is high.

6.1 Controller Power Sequencing Operation

The DS1776 has a design feature which controls the output transitions during power up (or down). There are two possible conditions that occur.

- When $\overline{LE} = \text{Low}$ and $\overline{OEBn} = \text{Low}$, the B outputs are disabled until the \overline{LE} circuit can take control. This feature ensures that the B outputs will follow the A inputs and allow only one transition during power up (or down).
- If $\overline{LE} = \text{High}$ or $\overline{OEBn} = \text{High}$, then the B outputs still remain disabled during power up (or down).

7 器件和文档支持

7.1 社区资源

The following links connect to TI community resources. Linked contents are provided "AS IS" by the respective contributors. They do not constitute TI specifications and do not necessarily reflect TI's views; see TI's [Terms of Use](#).

TI E2E™ Online Community *TI's Engineer-to-Engineer (E2E) Community*. Created to foster collaboration among engineers. At e2e.ti.com, you can ask questions, share knowledge, explore ideas and help solve problems with fellow engineers.

Design Support *TI's Design Support* Quickly find helpful E2E forums along with design support tools and contact information for technical support.

7.2 商标

E2E is a trademark of Texas Instruments.
All other trademarks are the property of their respective owners.

7.3 静电放电警告



这些装置包含有限的内置 ESD 保护。存储或装卸时，应将导线一起截短或将装置放置于导电泡棉中，以防止 MOS 门极遭受静电损伤。

7.4 Glossary



[SLYZ022](#) — *TI Glossary*.

This glossary lists and explains terms, acronyms, and definitions.

8 机械、封装和可订购信息

以下页中包括机械、封装和可订购信息。 这些信息是针对指定器件可提供的最新数据。 这些数据会在无通知且不对本文档进行修订的情况下发生改变。 欲获得该数据表的浏览器版本，请查阅左侧的导航栏。

PACKAGING INFORMATION

| Orderable Device | Status (1) | Package Type | Package Drawing | Pins | Package Qty | Eco Plan (2) | Lead finish/ Ball material (6) | MSL Peak Temp (3) | Op Temp (°C) | Device Marking (4/5) | Samples |
|------------------|---------------|--------------|-----------------|------|-------------|-----------------|--------------------------------------|----------------------|--------------|--|---|
| 5962-9231701M3A | ACTIVE | LCCC | FK | 28 | 25 | RoHS & Green | Call TI | Level-1-NA-UNLIM | -55 to 125 | DS1776E /883 Q 5962-92317 01M3A ACO 01M3A >T |  |
| DS1776E/883 | ACTIVE | LCCC | FK | 28 | 25 | RoHS & Green | Call TI | Level-1-NA-UNLIM | -55 to 125 | DS1776E /883 Q 5962-92317 01M3A ACO 01M3A >T |  |

(1) The marketing status values are defined as follows:

ACTIVE: Product device recommended for new designs.

LIFEBUY: TI has announced that the device will be discontinued, and a lifetime-buy period is in effect.

NRND: Not recommended for new designs. Device is in production to support existing customers, but TI does not recommend using this part in a new design.

PREVIEW: Device has been announced but is not in production. Samples may or may not be available.

OBSOLETE: TI has discontinued the production of the device.

(2) **RoHS:** TI defines "RoHS" to mean semiconductor products that are compliant with the current EU RoHS requirements for all 10 RoHS substances, including the requirement that RoHS substance do not exceed 0.1% by weight in homogeneous materials. Where designed to be soldered at high temperatures, "RoHS" products are suitable for use in specified lead-free processes. TI may reference these types of products as "Pb-Free".

RoHS Exempt: TI defines "RoHS Exempt" to mean products that contain lead but are compliant with EU RoHS pursuant to a specific EU RoHS exemption.

Green: TI defines "Green" to mean the content of Chlorine (Cl) and Bromine (Br) based flame retardants meet JS709B low halogen requirements of <=1000ppm threshold. Antimony trioxide based flame retardants must also meet the <=1000ppm threshold requirement.

(3) MSL, Peak Temp. - The Moisture Sensitivity Level rating according to the JEDEC industry standard classifications, and peak solder temperature.

(4) There may be additional marking, which relates to the logo, the lot trace code information, or the environmental category on the device.

(5) Multiple Device Markings will be inside parentheses. Only one Device Marking contained in parentheses and separated by a "~" will appear on a device. If a line is indented then it is a continuation of the previous line and the two combined represent the entire Device Marking for that device.

(6) Lead finish/Ball material - Orderable Devices may have multiple material finish options. Finish options are separated by a vertical ruled line. Lead finish/Ball material values may wrap to two lines if the finish value exceeds the maximum column width.

Important Information and Disclaimer: The information provided on this page represents TI's knowledge and belief as of the date that it is provided. TI bases its knowledge and belief on information provided by third parties, and makes no representation or warranty as to the accuracy of such information. Efforts are underway to better integrate information from third parties. TI has taken and continues to take reasonable steps to provide representative and accurate information but may not have conducted destructive testing or chemical analysis on incoming materials and chemicals. TI and TI suppliers consider certain information to be proprietary, and thus CAS numbers and other limited information may not be available for release.

In no event shall TI's liability arising out of such information exceed the total purchase price of the TI part(s) at issue in this document sold by TI to Customer on an annual basis.

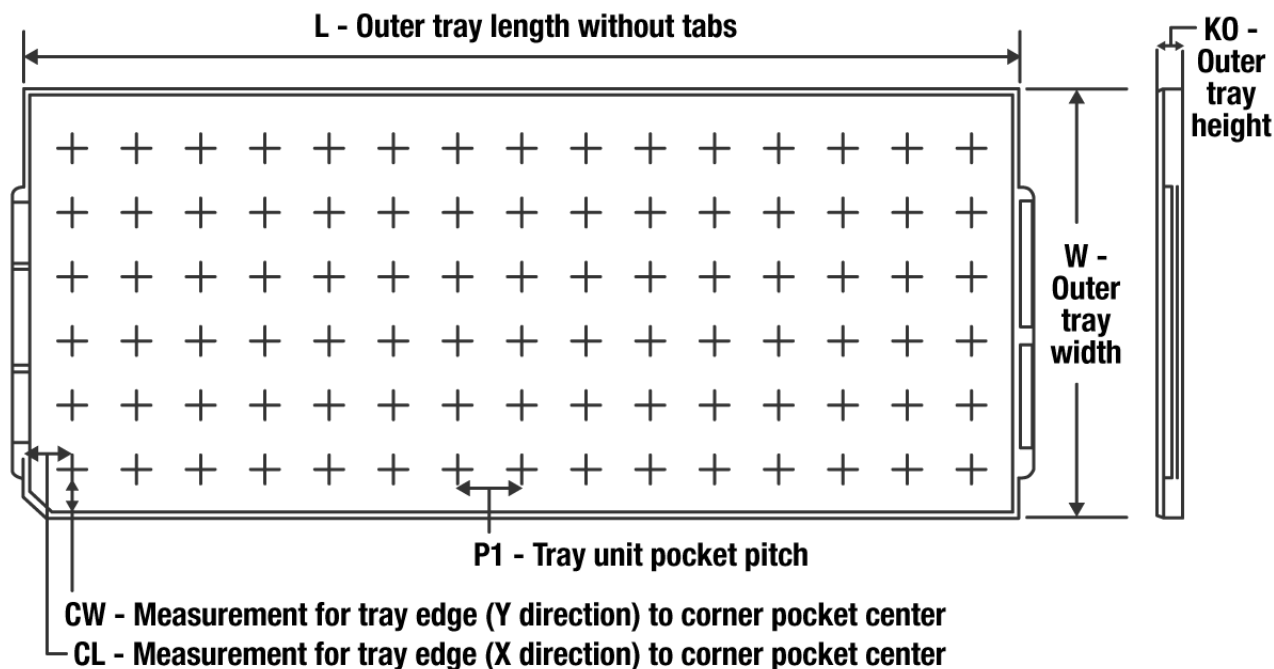
TRAY

Chamfer on Tray corner indicates Pin 1 orientation of packed units.

*All dimensions are nominal

| Device | Package Name | Package Type | Pins | SPQ | Unit array matrix | Max temperature (°C) | L (mm) | W (mm) | K0 (µm) | P1 (mm) | CL (mm) | CW (mm) |
|-----------------|--------------|--------------|------|-----|-------------------|----------------------|--------|--------|---------|---------|---------|---------|
| 5962-9231701M3A | FK | LCCC | 28 | 25 | NA | NA | 109.22 | 109.22 | 7620 | 12.7 | 26.01 | 26.01 |
| DS1776E/883 | FK | LCCC | 28 | 25 | NA | NA | 109.22 | 109.22 | 7620 | 12.7 | 26.01 | 26.01 |

FK (S-CQCC-N**)

LEADLESS CERAMIC CHIP CARRIER

28 TERMINAL SHOWN



| NO. OF TERMINALS ** | A | | B | |
|---------------------|------------------|------------------|------------------|------------------|
| | MIN | MAX | MIN | MAX |
| 20 | 0.342 (8,69) | 0.358 (9,09) | 0.307 (7,80) | 0.358 (9,09) |
| 28 | 0.442 (11,23) | 0.458 (11,63) | 0.406 (10,31) | 0.458 (11,63) |
| 44 | 0.640 (16,26) | 0.660 (16,76) | 0.495 (12,58) | 0.560 (14,22) |
| 52 | 0.740 (18,78) | 0.761 (19,32) | 0.495 (12,58) | 0.560 (14,22) |
| 68 | 0.938 (23,83) | 0.962 (24,43) | 0.850 (21,6) | 0.858 (21,8) |
| 84 | 1.141 (28,99) | 1.165 (29,59) | 1.047 (26,6) | 1.063 (27,0) |



4040140/D 01/11

- NOTES:
- All linear dimensions are in inches (millimeters).
 - This drawing is subject to change without notice.
 - This package can be hermetically sealed with a metal lid.
 - Falls within JEDEC MS-004

重要声明和免责声明

TI“按原样”提供技术和可靠性数据（包括数据表）、设计资源（包括参考设计）、应用或其他设计建议、网络工具、安全信息和其他资源，不保证没有瑕疵且不做任何明示或暗示的担保，包括但不限于对适销性、某特定用途方面的适用性或不侵犯任何第三方知识产权的暗示担保。

这些资源可供使用 TI 产品进行设计的熟练开发人员使用。您将自行承担以下全部责任：(1) 针对您的应用选择合适的 TI 产品，(2) 设计、验证并测试您的应用，(3) 确保您的应用满足相应标准以及任何其他功能安全、信息安全、监管或其他要求。

这些资源如有变更，恕不另行通知。TI 授权您仅可将这些资源用于研发本资源所述的 TI 产品的应用。严禁对这些资源进行其他复制或展示。您无权使用任何其他 TI 知识产权或任何第三方知识产权。您应全额赔偿因在这些资源的使用中对 TI 及其代表造成的任何索赔、损害、成本、损失和债务，TI 对此概不负责。

TI 提供的产品受 [TI 的销售条款](#) 或 [ti.com](#) 上其他适用条款/TI 产品随附的其他适用条款的约束。TI 提供这些资源并不会扩展或以其他方式更改 TI 针对 TI 产品发布的适用的担保或担保免责声明。

TI 反对并拒绝您可能提出的任何其他或不同的条款。

邮寄地址：Texas Instruments, Post Office Box 655303, Dallas, Texas 75265

Copyright © 2023，德州仪器 (TI) 公司