

DACx3701-Q1 具有非易失性存储器和兼容 PMBus™ 且具有 GPI 控制功能的 I²C 接口的汽车类 10 位和 8 位电压输出智能 DAC

1 特性

- 符合面向汽车应用的 AEC-Q100 标准：
 - 温度等级 1：-40°C 至 +125°C，T_A
- 1 LSB INL 和 DNL (10 位和 8 位)
- 宽工作范围
 - 电源：1.8V 至 5.5V
- 基于通用输入 (GPI) 的功能触发
- 兼容 PMBus™ 的 I²C 接口
 - 标准模式、快速模式和快速模式+
 - 四个目标地址选项配置为使用广播地址
 - 1.62V V_{IH} (V_{DD} = 5.5V)
- 用户可编程的非易失性存储器 (NVM/EEPROM)
 - 保存和撤销所有寄存器设置
- 可编程波形生成：方形、三角形和锯齿形
- 使用三角波形和 FB 引脚的脉宽调制 (PWM) 输出
- 数字压摆率控制
- 内部基准
- 功耗极低：在 1.8V 时为 0.2mA
- 灵活启动：高阻抗或 10K-GND
- 微型封装：8 引脚 WSON (2mm × 2mm)

2 应用

- 后灯
- 前灯
- 车内灯

3 说明

汽车级 10 位 DAC53701-Q1 和 8 位 DAC43701-Q1 (DACx3701-Q1) 是具有引脚兼容性的缓冲电压输出智能数模转换器 (DAC) 系列产品。这些器件功耗极低且均可采用微型 8 引脚 WSON 封装。凭借全套功能、微型封装和低功耗，DACx3701-Q1 非常适合用于汽车应用，如改变汽车尾灯、制动灯、车牌灯的淡入淡出效果和扩展 PWM 用于车内照明等。

这些器件具有非易失性存储器 (NVM)、一个内部基准、一个兼容 PMBus 的 I²C 接口和一个通用输入。DACx3701-Q1 使用内部基准或以电源作为基准运行，并提供 1.8 V 至 5.5 V 的满量程输出。

DACx3701-Q1 是智能 DAC 器件，因为它们具有高级集成特性。凭借强制检测输出、基于 GPI 的功能触发、PWM 输出和 NVM 功能，智能 DAC 无需使用软件即可实现系统性能和控制。

器件信息

器件型号	分辨率	封装 ^{(1) (2)}
DAC53701-Q1	10 位	DSG (WSON, 8)
DAC43701-Q1	8 位	2mm × 2mm

(1) 如需了解所有可用封装，请参阅数据表末尾的封装选项附录。

(2) 封装尺寸 (长 × 宽) 为标称值，并包括引脚 (如适用)。

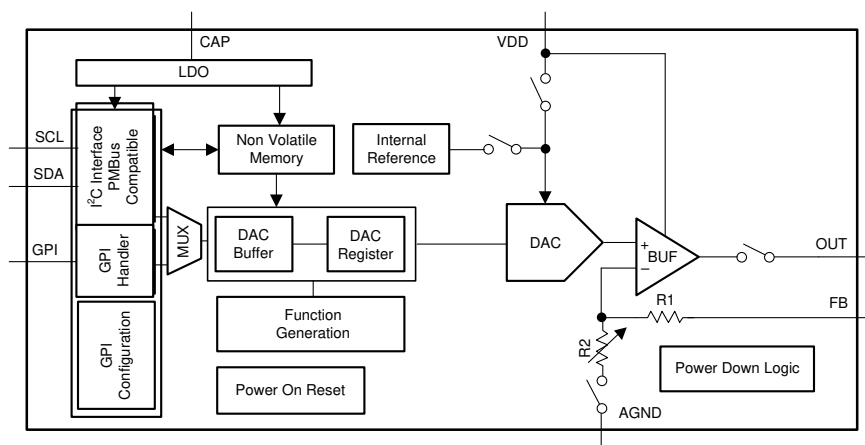

功能方框图



Table of Contents

1 特性	1	7 Detailed Description	19
2 应用	1	7.1 Overview.....	19
3 说明	1	7.2 Functional Block Diagram.....	19
4 Revision History	2	7.3 Feature Description.....	20
5 Pin Configuration and Functions	3	7.4 Device Functional Modes.....	27
6 Specifications	4	7.5 Programming.....	29
6.1 Absolute Maximum Ratings.....	4	7.6 Register Map.....	34
6.2 ESD Ratings.....	4	8 Application and Implementation	43
6.3 Recommended Operating Conditions.....	4	8.1 Application Information.....	43
6.4 Thermal Information.....	4	8.2 Typical Applications.....	43
6.5 Electrical Characteristics.....	5	8.3 Power Supply Recommendations.....	47
6.6 Timing Requirements: I ² C Standard Mode.....	8	8.4 Layout.....	47
6.7 Timing Requirements: I ² C Fast Mode.....	8	9 Device and Documentation Support	48
6.8 Timing Requirements: I ² C Fast-Mode Plus.....	9	9.1 Documentation Support.....	48
6.9 Timing Requirements: GPI.....	9	9.2 接收文档更新通知.....	48
6.10 Timing Diagram.....	9	9.3 支持资源.....	48
6.11 Typical Characteristics: V _{DD} = 5.5 V (Reference = V _{DD}) or V _{DD} = 5 V (Internal Reference).....	10	9.4 Trademarks.....	48
6.12 Typical Characteristics: V _{DD} = 1.8 V (Reference = V _{DD}) or V _{DD} = 2 V (Internal Reference).....	12	9.5 静电放电警告.....	48
6.13 Typical Characteristics.....	14	9.6 术语表.....	48
		10 Mechanical, Packaging, and Orderable Information	48

4 Revision History

注：以前版本的页码可能与当前版本的页码不同

Changes from Revision * (October 2020) to Revision A (September 2023)

Page

- | | |
|--|---|
| • 将 DACx3701-Q1 器件状态从预告信息 (预发布) 更改为量产数据 (正在供货) | 1 |
| • 将提到 I ² C 和 PMBus 的旧术语实例通篇更改为控制器和目标..... | 1 |

5 Pin Configuration and Functions



图 5-1. DSG Package, 8-Pin WSON (Top View)

表 5-1. Pin Functions

PIN		TYPE	DESCRIPTION
NO.	NAME		
1	GPI	Input	General-purpose input.
2	SCL	Input	Serial interface clock. This pin must be connected to the supply voltage with an external pullup resistor.
3	SDA	Input/Output	Data are clocked into or out of the input register. This pin is a bidirectional, and must be connected to the supply voltage with an external pullup resistor.
4	CAP	Input	External capacitor for the internal LDO. Connect a capacitor (approximately 1.5 μ F) between CAP and AGND.
5	AGND	Ground	Ground reference point for all circuitry on the device.
6	VDD	Power	Analog supply voltage: 1.8 V to 5.5 V
7	FB	Input	Voltage-feedback pin.
8	OUT	Output	Analog output voltage from DAC.
—	Thermal Pad	Ground	Connect the thermal pad to AGND.

6 Specifications

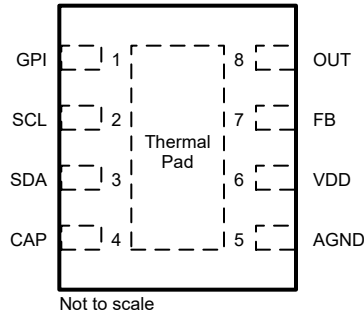
6.1 Absolute Maximum Ratings

over operating free-air temperature range (unless otherwise noted)⁽¹⁾

		MIN	MAX	UNIT
V _{DD}	Supply voltage, V _{DD} to AGND	- 0.3	6	V
	Digital inputs to AGND	- 0.3	V _{DD} + 0.3	V
	V _{FB} to AGND	- 0.3	V _{DD} + 0.3	V
	V _{OUT} to AGND	- 0.3	V _{DD} + 0.3	V
	Current into any pin except the OUT, VDD, and AGND pins	- 10	10	mA
T _J	Junction temperature	- 40	150	°C
T _{stg}	Storage temperature	- 65	150	°C

- (1) Operation outside the Absolute Maximum Ratings may cause permanent device damage. Absolute Maximum Ratings do not imply functional operation of the device at these or any other conditions beyond those listed under Recommended Operating Conditions. If used outside the Recommended Operating Conditions but within the Absolute Maximum Ratings, the device may not be fully functional, and this may affect device reliability, functionality, performance, and shorten the device lifetime.

6.2 ESD Ratings

			VALUE	UNIT
V _(ESD)	Electrostatic discharge	Human body model (HBM), per AEC Q100-002 ⁽¹⁾ HBM ESD classification level 2	±2000	V
		Charged device model (CDM), per AEC Q100-011 CDM ESD classification level C4B	±750	

- (1) AEC Q100-002 indicates that HBM stressing shall be in accordance with the ANSI/ESDA/JEDEC JS-001 specification.

6.3 Recommended Operating Conditions

over operating free-air temperature range (unless otherwise noted)

		MIN	NOM	MAX	UNIT
V _{DD}	Positive supply voltage to ground (AGND)	1.71		5.5	V
V _{IH}	Digital input high voltage, 1.7 V < V _{DD} ≤ 5.5 V	1.62			V
V _{IL}	Digital input low voltage			0.4	V
T _A	Ambient temperature	- 40		125	°C

6.4 Thermal Information

THERMAL METRIC ⁽¹⁾		DACx3701-Q1		UNIT
		DSG (WSON)		
		8 PINS		
R _{θJA}	Junction-to-ambient thermal resistance	49		°C/W
R _{θJC(top)}	Junction-to-case (top) thermal resistance	50		°C/W
R _{θJB}	Junction-to-board thermal resistance	24.1		°C/W
Ψ _{JT}	Junction-to-top characterization parameter	1.1		°C/W
Ψ _{JB}	Junction-to-board characterization parameter	24.1		°C/W
R _{θJC(bot)}	Junction-to-case (bottom) thermal resistance	8.7		°C/W

- (1) For more information about traditional and new thermal metrics, see the [Semiconductor and IC Package Thermal Metrics application report](#).

6.5 Electrical Characteristics

all minimum and maximum specifications at $-40^{\circ}\text{C} \leq T_A \leq +125^{\circ}\text{C}$; typical specifications at $T_A = 25^{\circ}\text{C}$, $1.8\text{ V} \leq V_{\text{DD}} \leq 5.5\text{ V}$, DAC reference tied to VDD, gain = 1 ×, DAC output pin (OUT) loaded with resistive load ($R_L = 5\text{ k}\Omega$ to AGND) and capacitive load ($C_L = 200\text{ pF}$ to AGND), and digital inputs at VDD or AGND (unless otherwise noted)

PARAMETER		TEST CONDITIONS	MIN	TYP	MAX	UNIT
STATIC PERFORMANCE						
	Resolution	DAC53701-Q1	10			Bits
		DAC43701-Q1	8			
INL	Relative accuracy ⁽¹⁾		-1		1	LSB
DNL	Differential nonlinearity ⁽¹⁾		-1		1	LSB
	Zero-code error	Code 0d into DAC, external reference, $V_{\text{DD}} = 5.5\text{ V}$		6	12	mV
		Code 0d into DAC, internal reference, gain = 4 ×, $V_{\text{DD}} = 5.5\text{ V}$		6	15	
	Zero-code-error temperature coefficient			±10		μV/°C
	Offset error ⁽²⁾		-0.6	0.25	0.6	%FSR
	Offset-error temperature coefficient ⁽²⁾			±0.0003		%FSR/°C
	Gain error ⁽²⁾		-0.5	0.25	0.5	%FSR
	Gain-error temperature coefficient ⁽²⁾			±0.0008		%FSR/°C
	Full-scale error	$1.8\text{ V} \leq V_{\text{DD}} < 2.7\text{ V}$, code 1023d into DAC for 10-bit resolution, code 255d into DAC for 8-bit resolution, no headroom	-1	0.5	1	%FSR
		$2.7\text{ V} \leq V_{\text{DD}} \leq 5.5\text{ V}$, code 1023d into DAC for 10-bit resolution, code 255d into DAC for 8-bit resolution, no headroom	-0.5	0.25	0.5	
	Full-scale-error temperature coefficient			±0.0008		%FSR/°C
OUTPUT CHARACTERISTICS						
	Output voltage	Reference tied to V_{DD}	0		5.5	V
C_L	Capacitive load ⁽³⁾	$R_L = \text{Infinite}$, phase margin = 30°			1	nF
		$R_L = 5\text{ k}\Omega$, phase margin = 30°			2	
	Load regulation	DAC at midscale, $-10\text{ mA} \leq I_{\text{OUT}} \leq 10\text{ mA}$, $V_{\text{DD}} = 5.5\text{ V}$		0.4		mV/mA
	Short circuit current	$V_{\text{DD}} = 1.8\text{ V}$, full-scale output shorted to AGND or zero-scale output shorted to V_{DD}		10		mA
		$V_{\text{DD}} = 2.7\text{ V}$, full-scale output shorted to AGND or zero-scale output shorted to V_{DD}		25		
		$V_{\text{DD}} = 5.5\text{ V}$, full-scale output shorted to AGND or zero-scale output shorted to V_{DD}		50		
	Output voltage headroom ⁽¹⁾	To V_{DD} , DAC output unloaded, internal reference = 1.21 V, $V_{\text{DD}} \geq 1.21 \times \text{gain} + 0.2\text{ V}$	0.2			V
		To V_{DD} , DAC output unloaded, reference tied to V_{DD}	0.8			%FSR
		To V_{DD} , $I_{\text{LOAD}} = 10\text{ mA}$ at $V_{\text{DD}} = 5.5\text{ V}$, $I_{\text{LOAD}} = 3\text{ mA}$ at $V_{\text{DD}} = 2.7\text{ V}$, $I_{\text{LOAD}} = 1\text{ mA}$ at $V_{\text{DD}} = 1.8\text{ V}$, DAC code = full scale	10			
	V_{OUT} dc output impedance	DAC output enabled and DAC code = midscale		0.25		Ω
		DAC output enabled and DAC code = 8d for 10-bit resolution and code = 2d for 8-bit resolution		0.25		
		DAC output enabled and DAC code = 1016d for 10-bit resolution and code = 254d for 8-bit resolution		0.26		

6.5 Electrical Characteristics (continued)

all minimum and maximum specifications at $-40^{\circ}\text{C} \leq T_A \leq +125^{\circ}\text{C}$; typical specifications at $T_A = 25^{\circ}\text{C}$, $1.8\text{ V} \leq V_{\text{DD}} \leq 5.5\text{ V}$, DAC reference tied to VDD, gain = 1 ×, DAC output pin (OUT) loaded with resistive load ($R_L = 5\text{ k}\Omega$ to AGND) and capacitive load ($C_L = 200\text{ pF}$ to AGND), and digital inputs at VDD or AGND (unless otherwise noted)

PARAMETER		TEST CONDITIONS	MIN	TYP	MAX	UNIT
Z _O	V _{FB} dc output impedance ⁽⁴⁾	DAC output enabled, DAC reference tied to VDD (gain = 1 ×) or internal reference (gain = 1.5 × or 2 ×)	160	200	240	kΩ
		DAC output enabled, internal V _{REF} , gain = 3 × or 4 ×	192	240	288	
	V _{OUT} + V _{FB} dc output leakage ⁽³⁾	At start up, measured when DAC output is disabled and held at V _{DD} / 2 for V _{DD} = 5.5 V			7	nA
	Power supply rejection ratio (dc)	Internal V _{REF} , gain = 2 ×, DAC at midscale; V _{DD} = 5 V ±10%		0.25		mV/V
DYNAMIC PERFORMANCE						
t _{sett}	Output voltage settling time	1/4 to 3/4 scale and 3/4 to 1/4 scale settling to 10%FSR, V _{DD} = 5.5 V		8		μs
		1/4 to 3/4 scale and 3/4 to 1/4 scale settling to 10%FSR, V _{DD} = 5.5 V, internal V _{REF} , gain = 4 ×		12		
	Slew rate	V _{DD} = 5.5 V		1		V/μs
	Power-on glitch magnitude	At start-up, DAC output disabled, R _L = 5 kΩ, C _L = 200 pF		75		mV
		At start-up, DAC output disabled, R _L = 100 kΩ		200		
	Output enable glitch magnitude	DAC output disabled to enabled, DAC registers at zero scale, R _L = 100 kΩ		250		mV
V _n	Output noise voltage (peak to peak)	0.1 Hz to 10 Hz, DAC at midscale, V _{DD} = 5.5 V		34		μV _{PP}
		Internal V _{REF} , gain = 4 ×, 0.1 Hz to 10 Hz, DAC at midscale, V _{DD} = 5.5 V		70		
	Output noise density	Measured at 1 kHz, DAC at midscale, V _{DD} = 5.5 V		0.2		μV/√Hz
		Internal V _{REF} , gain = 4 ×, measured at 1 kHz, DAC at midscale, V _{DD} = 5.5 V		0.7		
	Power supply rejection ratio (ac) ⁽⁴⁾	Internal V _{REF} , gain = 4 ×, 200-mV 50-Hz or 60-Hz sine wave superimposed on power supply voltage, DAC at midscale		-71		dB
	Code change glitch impulse	±1-LSB change around midcode (including feedthrough)		10		nV-s
	Code change glitch impulse magnitude	±1-LSB change around midcode (including feedthrough)		15		mV
	Function generator TIME-STEP accuracy			±6.25		%
VOLTAGE REFERENCE						
	Initial accuracy			1.212		V
	Reference output temperature coefficient ⁽³⁾				65	ppm/°C
EEPROM						
	Endurance ⁽³⁾	-40°C ≤ T _A ≤ +85°C		20000		Cycles
		T _A > 85°C		1000		
	Data retention ⁽³⁾			50		Years
		T _A = 125°C		20		
	EEPROM programming write cycle time ⁽³⁾		10		20	ms
DIGITAL INPUTS						
	Digital feedthrough	DAC output static at midscale, fast-mode plus, SCL toggling		20		nV-s

6.5 Electrical Characteristics (continued)

all minimum and maximum specifications at $-40^{\circ}\text{C} \leq T_A \leq +125^{\circ}\text{C}$; typical specifications at $T_A = 25^{\circ}\text{C}$, $1.8\text{ V} \leq V_{DD} \leq 5.5\text{ V}$, DAC reference tied to VDD, gain = 1 ×, DAC output pin (OUT) loaded with resistive load ($R_L = 5\text{ k}\Omega$ to AGND) and capacitive load ($C_L = 200\text{ pF}$ to AGND), and digital inputs at VDD or AGND (unless otherwise noted)

PARAMETER		TEST CONDITIONS	MIN	TYP	MAX	UNIT
	Pin capacitance	Per pin		10		pF

6.5 Electrical Characteristics (continued)

all minimum and maximum specifications at $-40^{\circ}\text{C} \leq T_A \leq +125^{\circ}\text{C}$; typical specifications at $T_A = 25^{\circ}\text{C}$, $1.8\text{ V} \leq V_{DD} \leq 5.5\text{ V}$, DAC reference tied to VDD, gain = 1 ×, DAC output pin (OUT) loaded with resistive load ($R_L = 5\text{ k}\Omega$ to AGND) and capacitive load ($C_L = 200\text{ pF}$ to AGND), and digital inputs at VDD or AGND (unless otherwise noted)

PARAMETER		TEST CONDITIONS	MIN	TYP	MAX	UNIT
POWER						
	Load capacitor - CAP pin ⁽³⁾		0.5		15	μF
I_{DD}	Current flowing into VDD	Normal mode, DACs at full scale, digital pins static		0.225	0.55	mA
		DAC power down, internal reference power down		80		μA

- Measured with DAC output unloaded. For external reference between end-point codes: 8d to 1016d for 10-bit resolution, 2d to 254d for 8-bit resolution. For internal reference $V_{DD} \geq 1.21 \times \text{gain} + 0.2\text{ V}$, between end-point codes: 8d to 1016d for 10-bit resolution, 2d to 254d for 8-bit resolution.
- Measured with DAC output unloaded. For 10-bit resolution, between end-point codes: 8d to 1016d and for 8-bit resolution, between end-point codes: 2d to 254d.
- Specified by design and characterization, not production tested.
- Specified with 200-mV headroom with respect to reference value when internal reference is used.

6.6 Timing Requirements: I²C Standard Mode

all input signals are timed from VIL to 70% of V_{DD} , $1.8\text{ V} \leq V_{DD} \leq 5.5\text{ V}$, $-40^{\circ}\text{C} \leq T_A \leq +125^{\circ}\text{C}$, and $1.8\text{ V} \leq V_{\text{pull-up}} \leq V_{DD}\text{ V}$ (unless otherwise noted)

		MIN	NOM	MAX	UNIT
f_{SCLK}	SCL frequency			0.1	MHz
t_{BUF}	Bus free time between stop and start conditions	4.7			μs
t_{HDSTA}	Hold time after repeated start	4			μs
t_{SUSTA}	Repeated start setup time	4.7			μs
t_{SUSTO}	Stop condition setup time	4			μs
t_{HDDAT}	Data hold time	0			ns
t_{SUDAT}	Data setup time	250			ns
t_{LOW}	SCL clock low period	4700			ns
t_{HIGH}	SCL clock high period	4000			ns
t_{F}	Clock and data fall time			300	ns
t_{R}	Clock and data rise time			1000	ns

6.7 Timing Requirements: I²C Fast Mode

all input signals are timed from VIL to 70% of V_{DD} , $1.8\text{ V} \leq V_{DD} \leq 5.5\text{ V}$, $-40^{\circ}\text{C} \leq T_A \leq +125^{\circ}\text{C}$, and $1.8\text{ V} \leq V_{\text{pull-up}} \leq V_{DD}\text{ V}$ (unless otherwise noted)

		MIN	NOM	MAX	UNIT
f_{SCLK}	SCL frequency			0.4	MHz
t_{BUF}	Bus free time between stop and start conditions	1.3			μs
t_{HDSTA}	Hold time after repeated start	0.6			μs
t_{SUSTA}	Repeated start setup time	0.6			μs
t_{SUSTO}	Stop condition setup time	0.6			μs
t_{HDDAT}	Data hold time	0			ns
t_{SUDAT}	Data setup time	100			ns
t_{LOW}	SCL clock low period	1300			ns
t_{HIGH}	SCL clock high period	600			ns
t_{F}	Clock and data fall time			300	ns
t_{R}	Clock and data rise time			300	ns

6.8 Timing Requirements: I²C Fast-Mode Plus

all input signals are timed from VIL to 70% of V_{DD}, 1.8 V ≤ V_{DD} ≤ 5.5 V, -40°C ≤ T_A ≤ +125°C, and 1.8 V ≤ V_{pull-up} ≤ V_{DD} V (unless otherwise noted)

		MIN	NOM	MAX	UNIT
f _{SCLK}	SCL frequency			1	MHz
t _{BUF}	Bus free time between stop and start conditions	0.5			μs
t _{HDSTA}	Hold time after repeated start	0.26			μs
t _{SUSTA}	Repeated start setup time	0.26			μs
t _{SUSTO}	Stop condition setup time	0.26			μs
t _{HDDAT}	Data hold time	0			ns
t _{SUDAT}	Data setup time	50			ns
t _{LOW}	SCL clock low period	0.5			μs
t _{HIGH}	SCL clock high period	0.26			μs
t _F	Clock and data fall time			120	ns
t _R	Clock and data rise time			120	ns

6.9 Timing Requirements: GPI

all input signals are timed from VIL to 70% of V_{DD}. 1.8 V ≤ V_{DD} ≤ 5.5 V and -40°C ≤ T_A ≤ +125°C (unless otherwise noted)

		MIN	NOM	MAX	UNIT
t _{GPIDELAY}	GPI edge to start of operation delay, 1.7 V ≤ V _{DD} ≤ 5.5 V ⁽¹⁾		2		μs

- (1) The maximum value specified for t_{GPIDELAY} in the timing table is in addition to 2x SLEW_RATE for margin-high, low and function generation operations. The maximum value for the total delay is (2xSLEW_RATE + t_{GPIDELAY}).

6.10 Timing Diagram



图 6-1. I²C Timing Diagram

6.11 Typical Characteristics: $V_{DD} = 5.5\text{ V}$ (Reference = V_{DD}) or $V_{DD} = 5\text{ V}$ (Internal Reference)

at $T_A = 25^\circ\text{C}$, 10-bit DAC, and DAC outputs unloaded (unless otherwise noted)

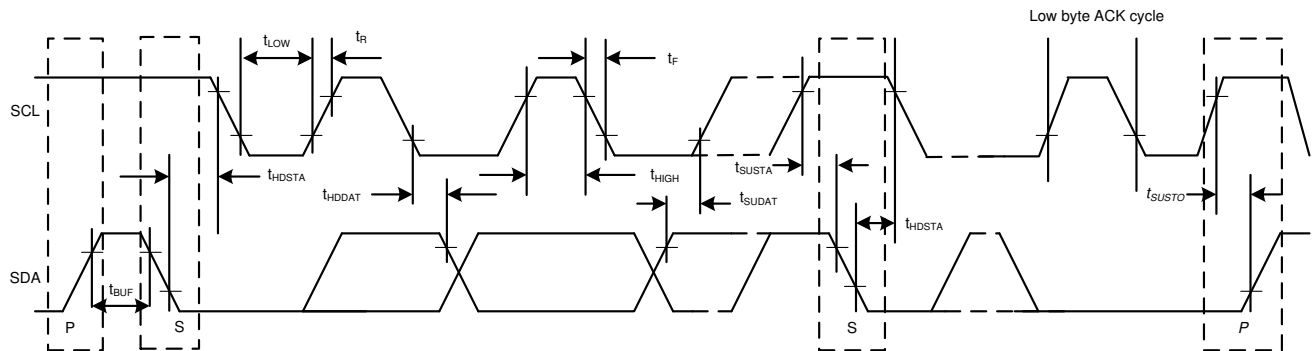

图 6-2. Integral Linearity Error vs Digital Input Code



图 6-3. Integral Linearity Error vs Temperature

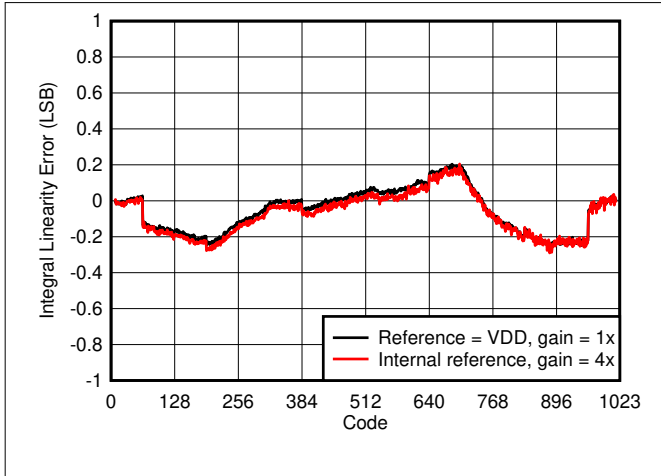

图 6-4. Differential Linearity Error vs Digital Input Code

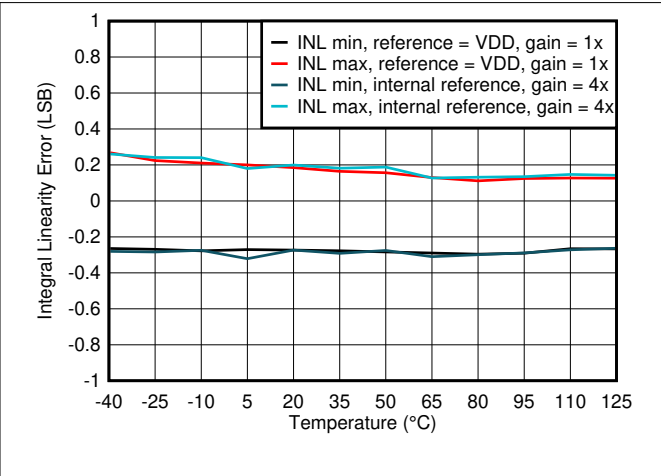

图 6-5. Differential Linearity Error vs Temperature

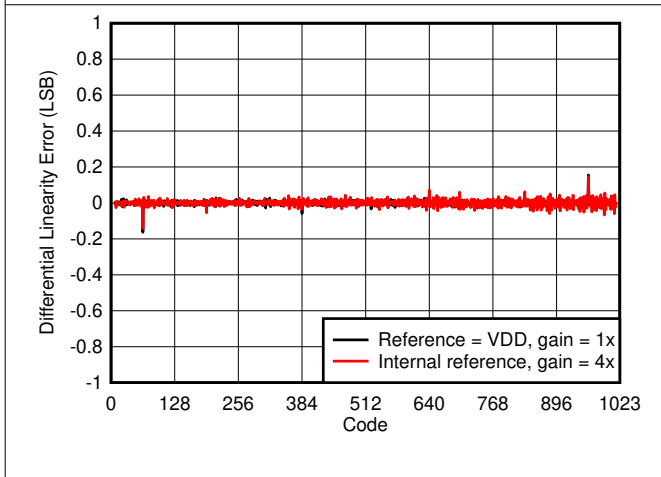

图 6-6. Total Unadjusted Error vs Digital Input Code

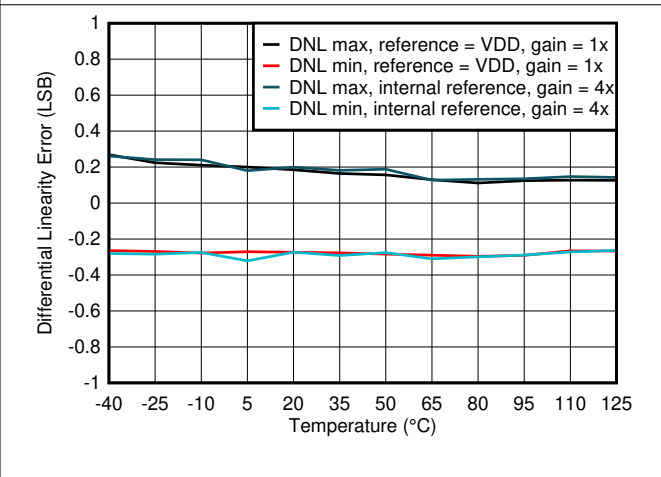

图 6-7. Total Unadjusted Error vs Temperature

6.11 Typical Characteristics: $V_{DD} = 5.5\text{ V}$ (Reference = V_{DD}) or $V_{DD} = 5\text{ V}$ (Internal Reference) (continued)

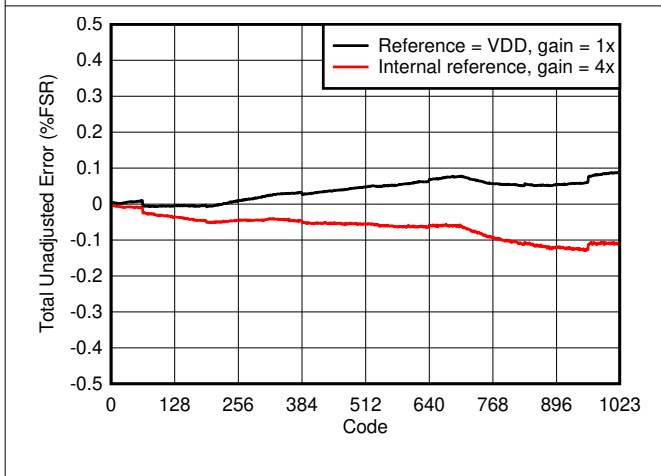
at $T_A = 25^\circ\text{C}$, 10-bit DAC, and DAC outputs unloaded (unless otherwise noted)

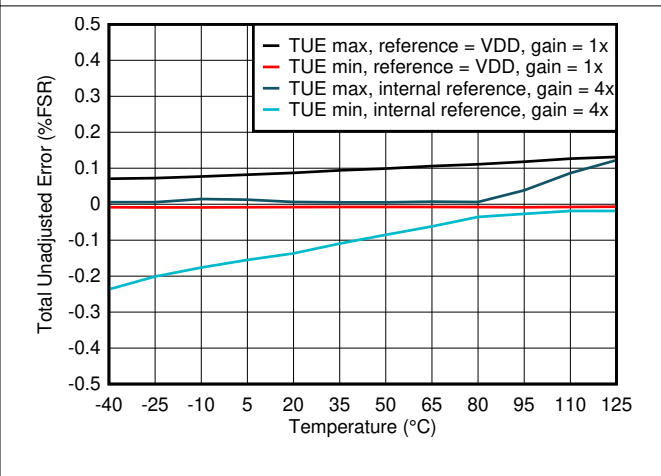

图 6-8. Zero Code Error vs Temperature



图 6-9. Offset Error vs Temperature

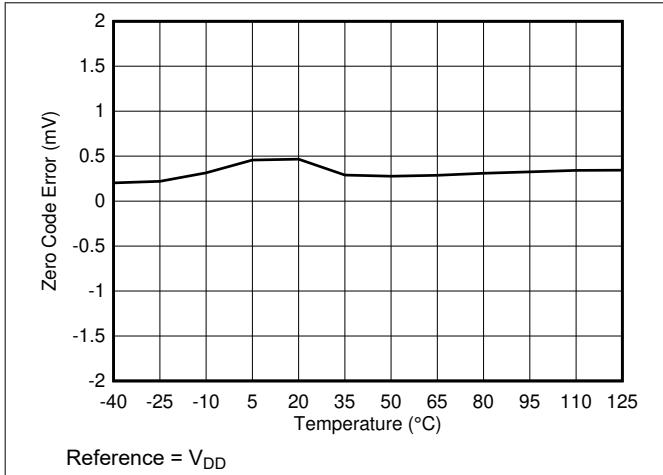

图 6-10. Gain Error vs Temperature

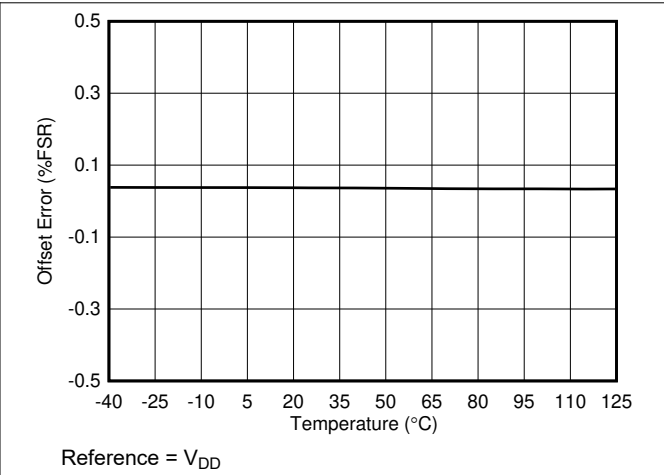

图 6-11. Full-Scale Error vs Temperature

6.12 Typical Characteristics: $V_{DD} = 1.8\text{ V}$ (Reference = V_{DD}) or $V_{DD} = 2\text{ V}$ (Internal Reference)

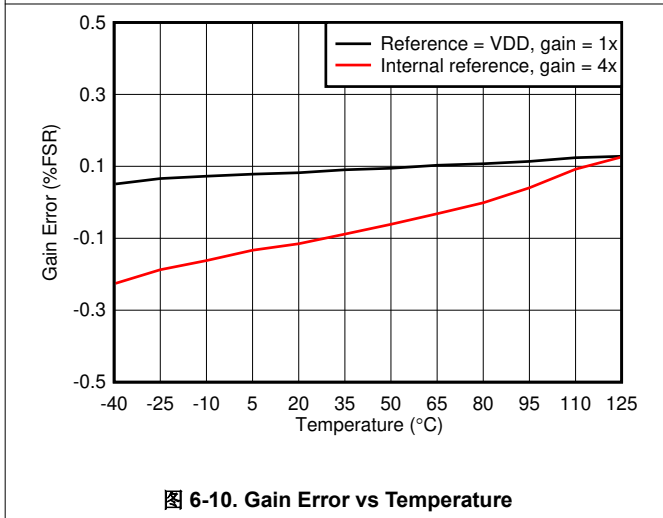
at $T_A = 25^\circ\text{C}$, 10-bit DAC, and DAC outputs unloaded (unless otherwise noted)

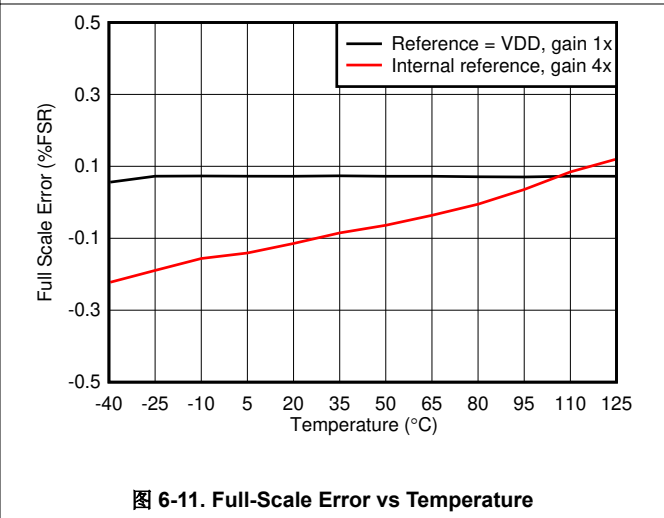

图 6-12. Integral Linearity Error vs Digital Input Code



图 6-13. Integral Linearity Error vs Temperature

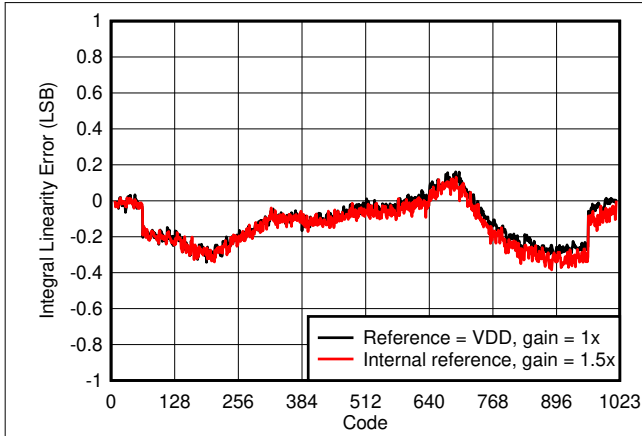

图 6-14. Differential Linearity Error vs Digital Input Code

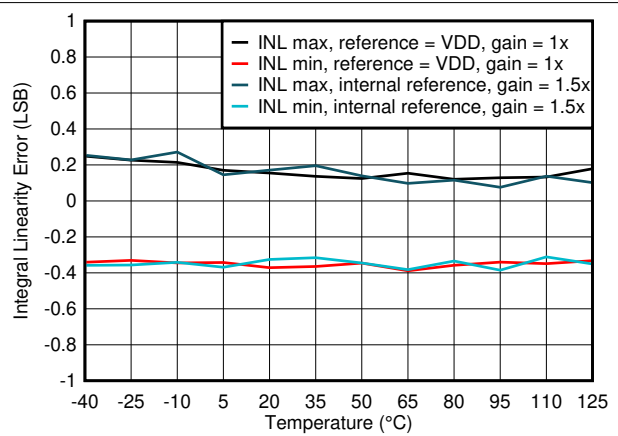

图 6-15. Differential Linearity Error vs Temperature

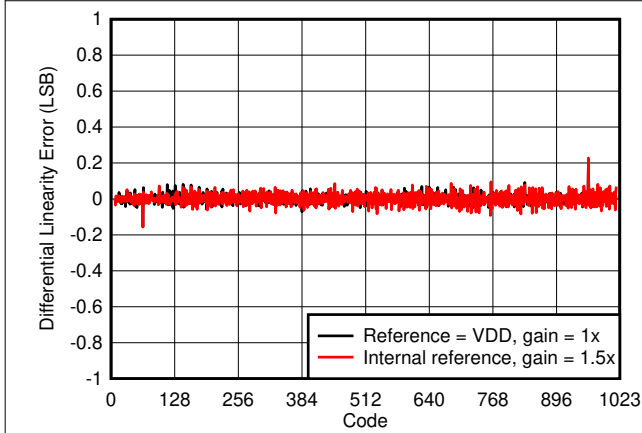

图 6-16. Total Unadjusted Error vs Digital Input Code

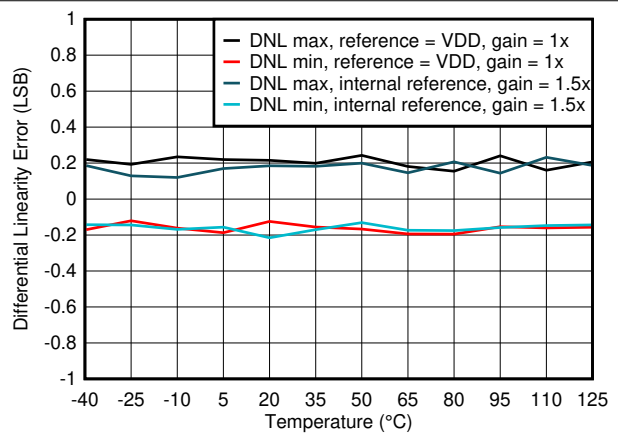

图 6-17. Total Unadjusted Error vs Temperature

6.12 Typical Characteristics: $V_{DD} = 1.8\text{ V}$ (Reference = V_{DD}) or $V_{DD} = 2\text{ V}$ (Internal Reference) (continued)

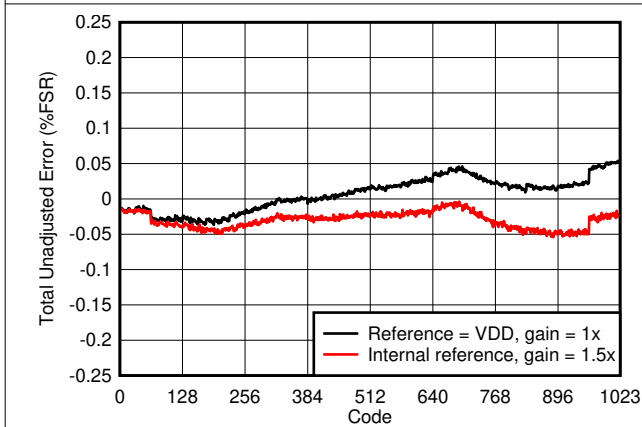
at $T_A = 25^\circ\text{C}$, 10-bit DAC, and DAC outputs unloaded (unless otherwise noted)

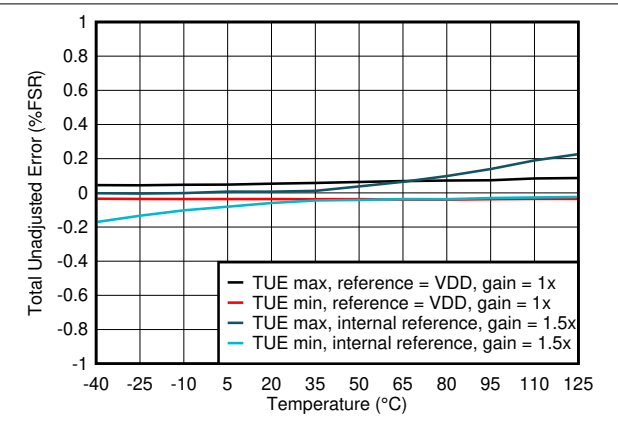
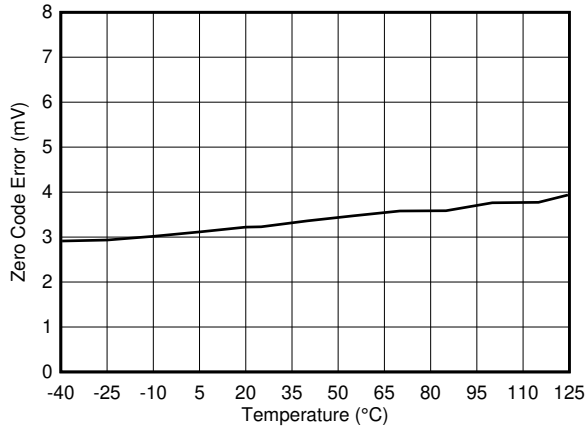

Reference = V_{DD}

图 6-18. Zero Code Error vs Temperature

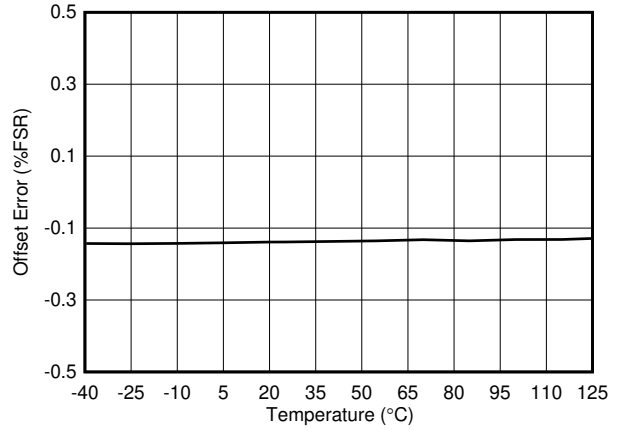

Reference = V_{DD}

图 6-19. Offset Error vs Temperature



图 6-20. Gain Error vs Temperature



图 6-21. Full-Scale Error vs Temperature

6.13 Typical Characteristics

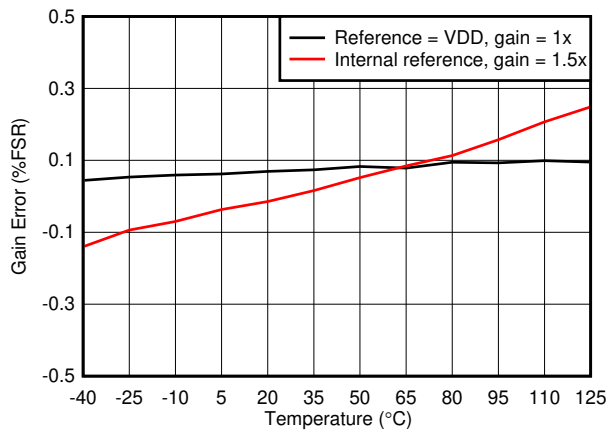
at $T_A = 25^\circ\text{C}$, 10-bit DAC, and DAC outputs unloaded (unless otherwise noted)

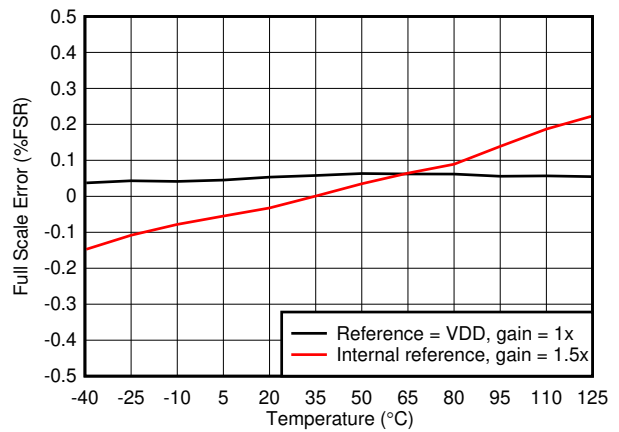
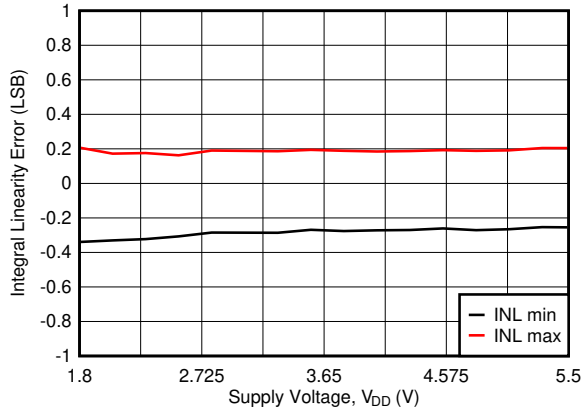

Reference = V_{DD}

图 6-22. Integral Linearity Error vs Supply Voltage

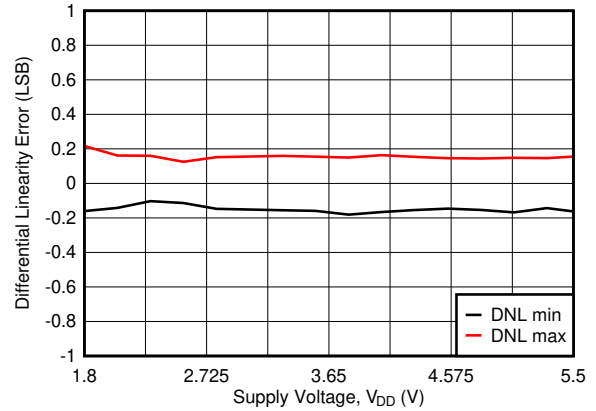

Reference = V_{DD}

图 6-23. Differential Linearity Error vs Supply Voltage

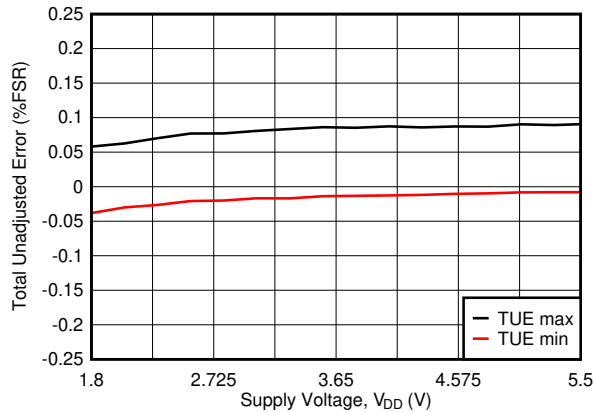

Reference = V_{DD}

图 6-24. Total Unadjusted Error vs Supply Voltage

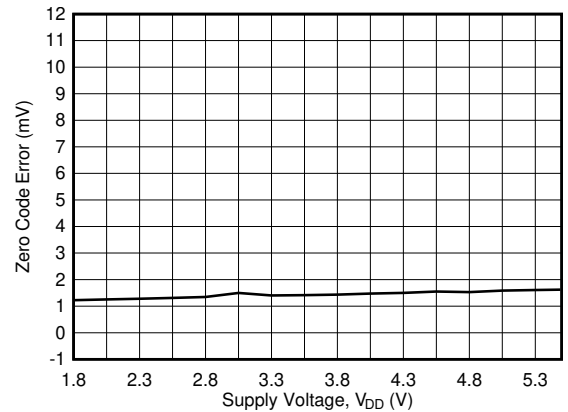

Reference = V_{DD}

图 6-25. Zero-Code Error vs Supply Voltage

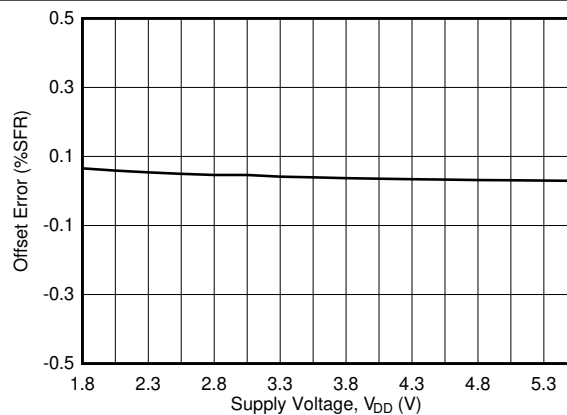

Reference = V_{DD}

图 6-26. Offset Error vs Supply Voltage

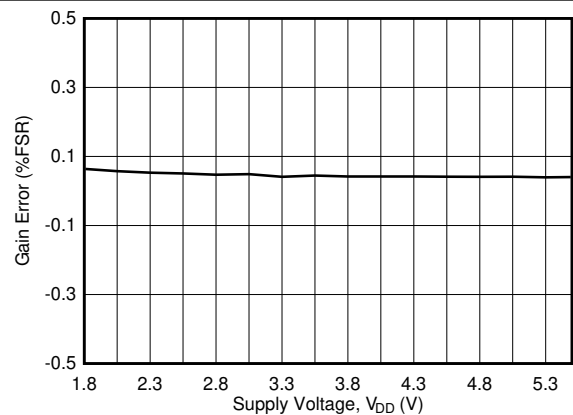

Reference = V_{DD}

图 6-27. Gain Error vs Supply Voltage

6.13 Typical Characteristics (continued)

at $T_A = 25^\circ\text{C}$, 10-bit DAC, and DAC outputs unloaded (unless otherwise noted)

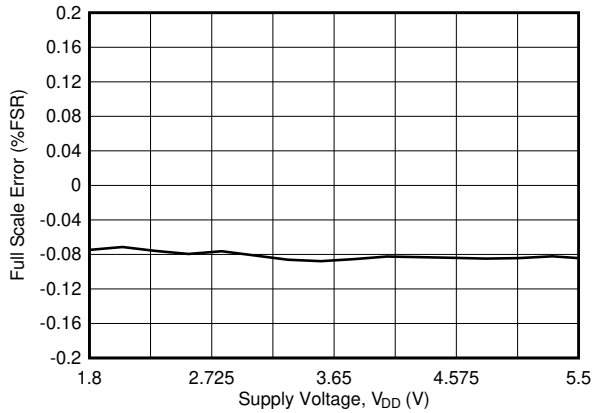

Reference = V_{DD}

图 6-28. Full-Scale Error vs Supply Voltage

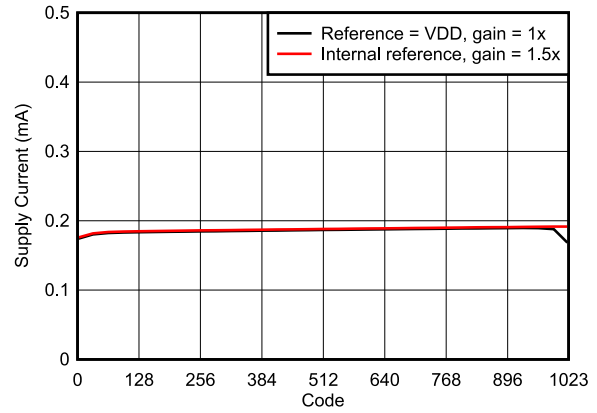

$V_{DD} = 1.8\text{ V}$

图 6-29. Supply Current vs Digital Input Code

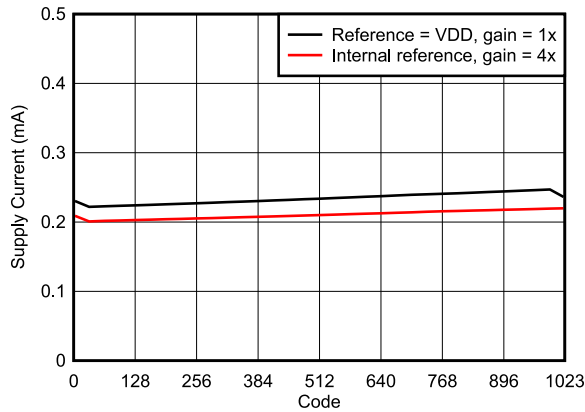

$V_{DD} = 5.5\text{ V}$

图 6-30. Supply Current vs Digital Input Code

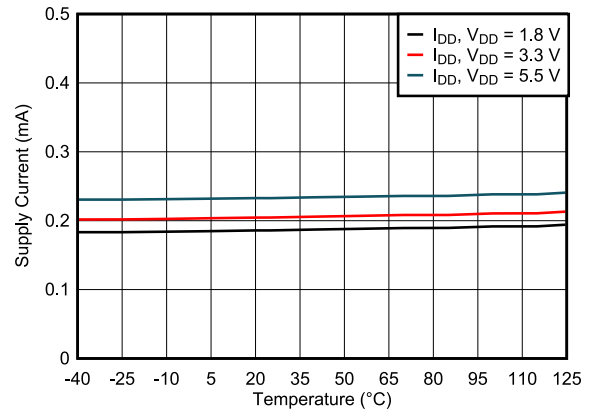

Reference = V_{DD} , DAC at midscale

图 6-31. Supply Current vs Temperature

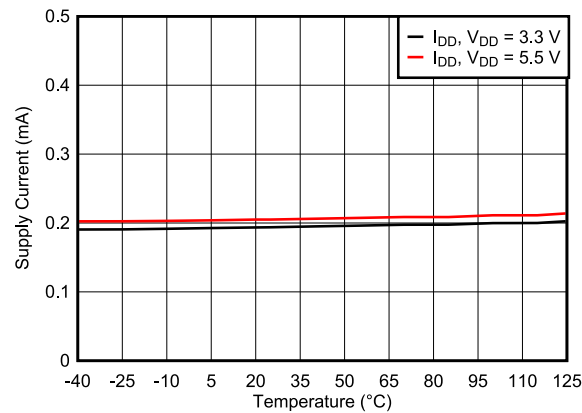

Internal reference (gain = 4 ×), DAC at midscale

图 6-32. Supply Current vs Temperature

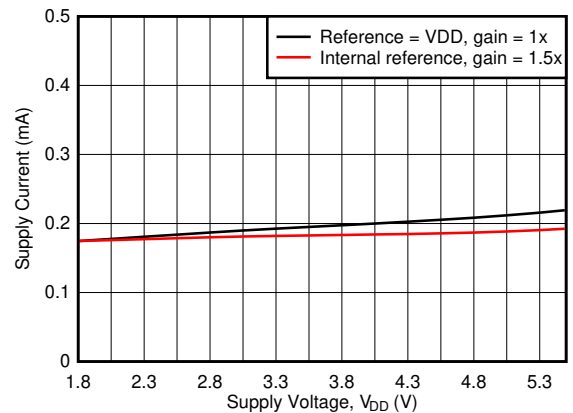

DAC at midscale

图 6-33. Supply Current vs Supply Voltage

6.13 Typical Characteristics (continued)

at $T_A = 25^\circ\text{C}$, 10-bit DAC, and DAC outputs unloaded (unless otherwise noted)

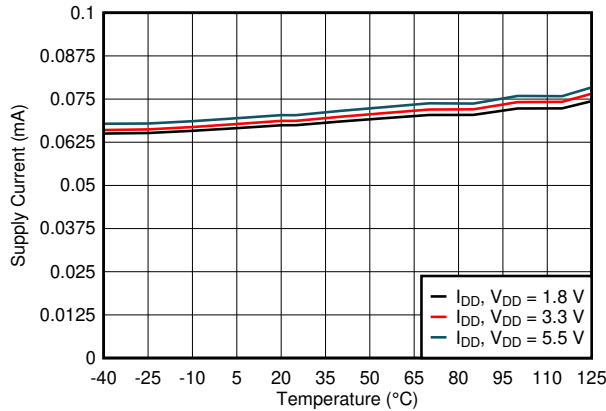

Reference = V_{DD} , DAC powered down

图 6-34. Power-Down Current vs Temperature



图 6-35. Source and Sink Capability



Reference = $V_{DD} = 5.5\text{ V}$, DAC code transition from midscale to midscale + 1 LSB, DAC load = $5\text{ k}\Omega \parallel 200\text{ pF}$

图 6-36. Glitch Impulse, Rising Edge, 1-LSB Step

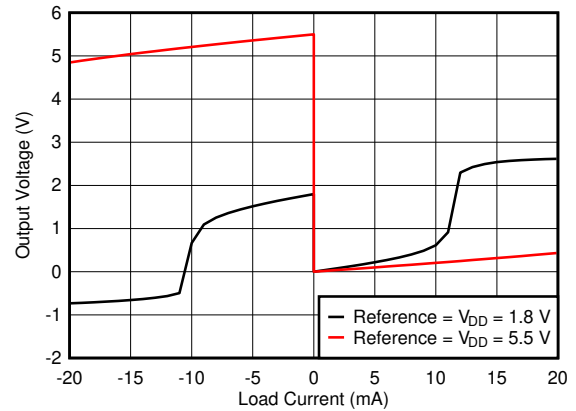
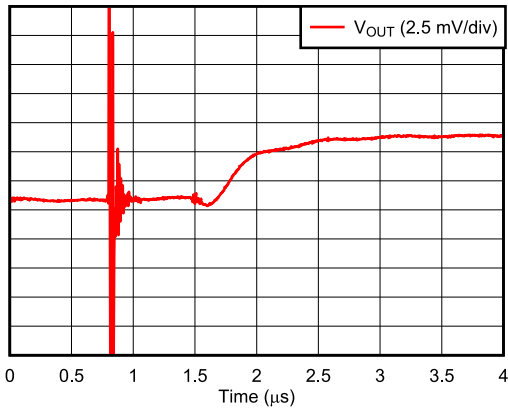
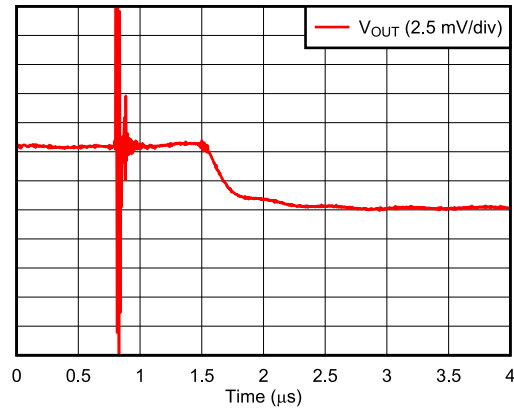

Reference = $V_{DD} = 5.5\text{ V}$, DAC code transition from midscale to midscale - 1 LSB, DAC load = $5\text{ k}\Omega \parallel 200\text{ pF}$

图 6-37. Glitch Impulse, Falling Edge, 1-LSB Step

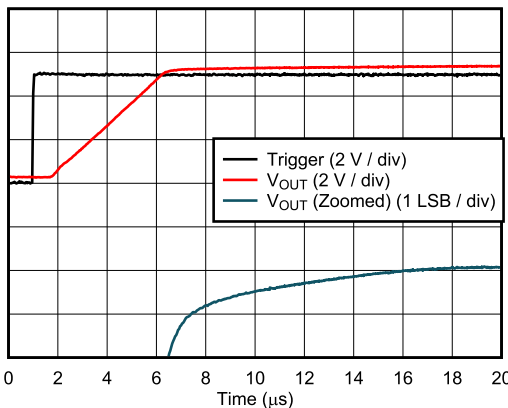

Reference = $V_{DD} = 5.5\text{ V}$, DAC load = $5\text{ k}\Omega \parallel 200\text{ pF}$

图 6-38. Full-Scale Settling Time, Rising Edge

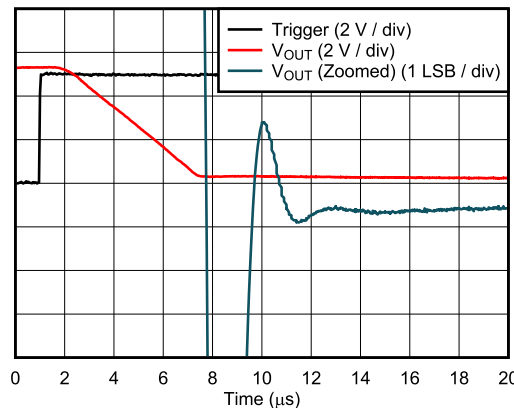

Reference = $V_{DD} = 5.5\text{ V}$, DAC load = $5\text{ k}\Omega \parallel 200\text{ pF}$

图 6-39. Full-Scale Settling Time, Falling Edge

6.13 Typical Characteristics (continued)

at $T_A = 25^\circ\text{C}$, 10-bit DAC, and DAC outputs unloaded (unless otherwise noted)

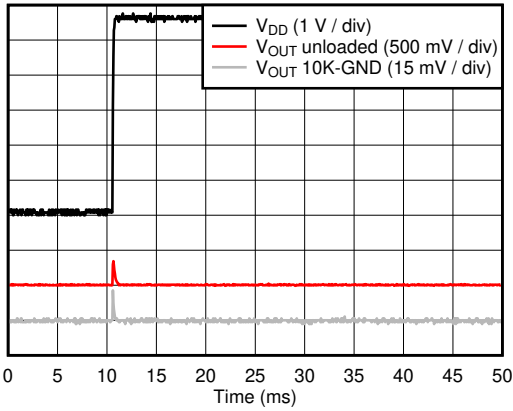

Reference = $V_{DD} = 5.5\text{ V}$

图 6-40. Power-on Glitch

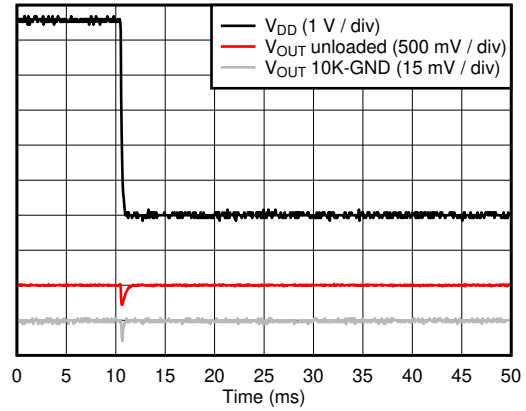

Reference = $V_{DD} = 5.5\text{ V}$

图 6-41. Power-off Glitch

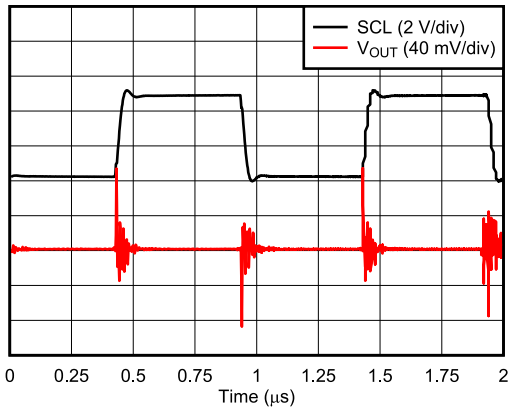

Reference = $V_{DD} = 5.5\text{ V}$, fast-mode plus, DAC at midscale,
DAC load = $5\text{ k}\Omega \parallel 200\text{ pF}$

图 6-42. Clock Feedthrough

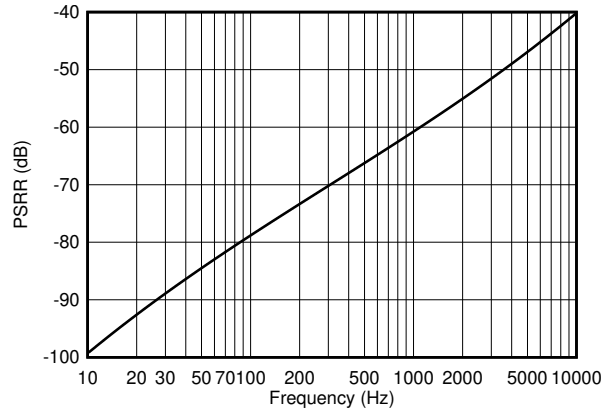

Internal reference (gain = 4 ×), $V_{DD} = 5.25\text{ V} + 0.25\text{ V}_{PP}$, DAC
at midscale, DAC load = $5\text{ k}\Omega \parallel 200\text{ pF}$

图 6-43. DAC Output AC PSRR vs Frequency

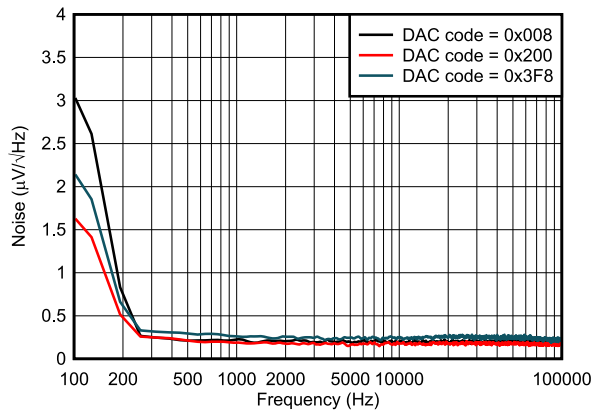

Reference = $V_{DD} = 5.5\text{ V}$

图 6-44. DAC Output Noise Spectral Density

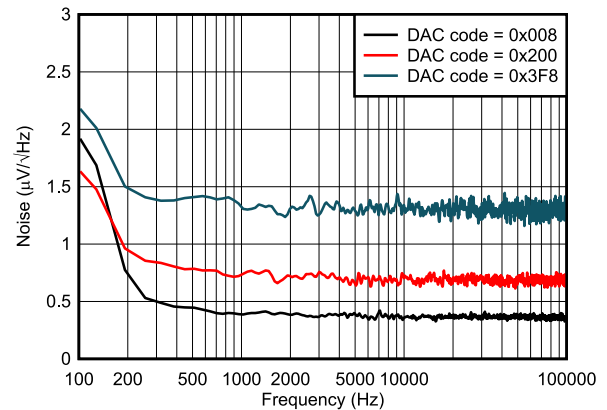

Internal reference (gain = 4 ×), $V_{DD} = 5.5\text{ V}$

图 6-45. DAC Output Noise Spectral Density

6.13 Typical Characteristics (continued)

at $T_A = 25^\circ\text{C}$, 10-bit DAC, and DAC outputs unloaded (unless otherwise noted)

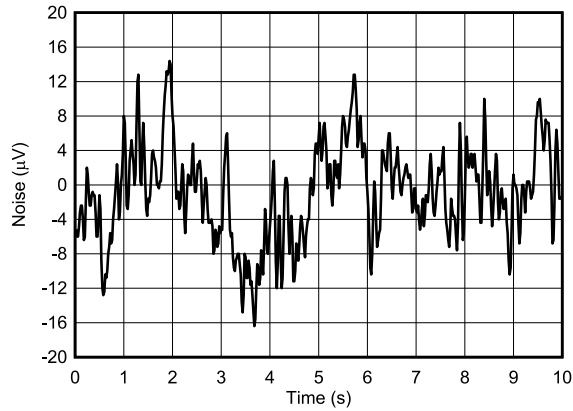

Reference = $V_{DD} = 5.5\text{ V}$, DAC at midscale

图 6-46. DAC Output Noise: 0.1 Hz to 10 Hz

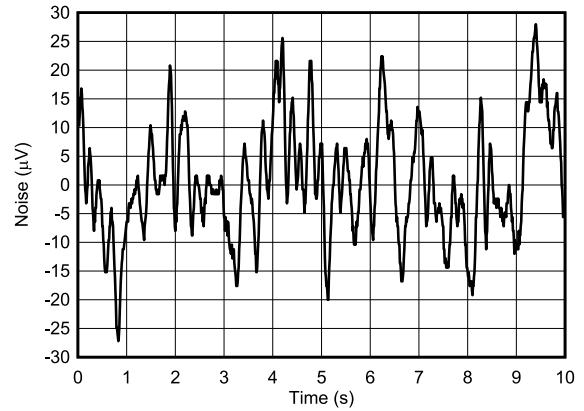

Internal reference (gain = $4 \times$), $V_{DD} = 5.5\text{ V}$, DAC at midscale

图 6-47. DAC Output Noise: 0.1 Hz to 10 Hz

7 Detailed Description

7.1 Overview

The 10-bit DAC53701-Q1 and 8-bit DAC43701-Q1 (DACx3701-Q1) are a pin-compatible family of automotive, buffered voltage-output, smart digital-to-analog converters (DACs). These smart DACs contain nonvolatile memory (NVM), an internal reference, a PMBus-compatible I²C interface, force-sense output, and a general-purpose input. The DACx3701-Q1 operate with either an internal reference or with a power supply as the reference, and provide a full-scale output of 1.8 V to 5.5 V.

These devices communicate through an I²C interface, and support I²C standard mode (100Kbps), fast mode (400Kbps), and fast-mode plus (1Mbps). These devices also support specific PMBus commands such as *turn on/off*, *margin high or low*, and more. The GPI input can be configured as a power-down trigger, margin-high-low, and function trigger. The DACx3701-Q1 also include digital slew rate control, and support basic signal generation such as *square*, *ramp*, and *sawtooth* waveforms. These devices can generate pulse-width modulation (PWM) output with the combination of the triangular or sawtooth waveform and the FB pin. These features enable the DACx3701-Q1 to go beyond the limitations of a conventional DAC that depends on a processor to function. Because of processor-less operation and the *smart* feature set, the DACx3701-Q1 are called smart DACs.

The DACx3701-Q1 have a power-on-reset (POR) circuit that makes sure all the registers start with default or user-programmed settings using NVM. The DAC output powers on in high-impedance mode (default); this setting can be programmed to 10kΩ-GND using NVM.

7.2 Functional Block Diagram

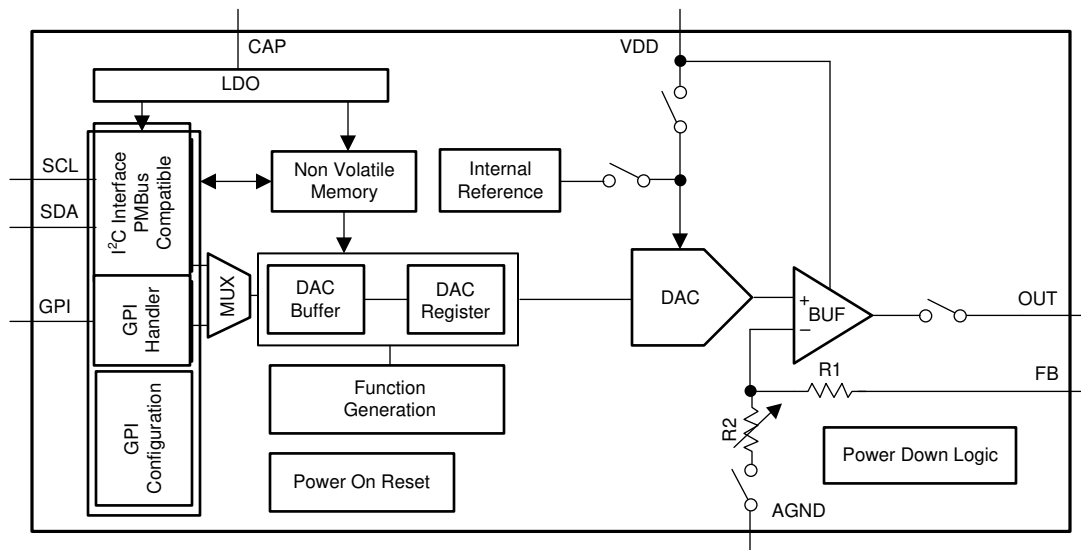

7.3 Feature Description

7.3.1 Digital-to-Analog Converter (DAC) Architecture

The DACx3701-Q1 family of devices consists of string architecture with an output buffer amplifier. [# 7.2](#) shows the DAC architecture within the block diagram. This DAC architecture operates from a 1.8-V to 5.5-V power supply. These devices consume only 0.2 mA of current when using a 1.8-V power supply. The DAC output pin starts up in high-impedance mode, making these devices an excellent choice for power-supply control applications. To change the power-up mode to 10kΩ-GND, program the DAC_PDN bit (address: D1h), and load these bits in the device NVM. The DACx3701-Q1 devices include a *smart* feature set to enable processor-less operation and high-integration. The NVM enables a predictable start up. The GPI triggers the DAC output without the I²C interface in the absence of a processor or when the processor or software fails. The integrated functions and the FB pin enable PWM output for control applications. The FB pin enables this device to be used as a programmable comparator. The digital slew rate control and the Hi-Z power-down modes enable a hassle-free voltage margining and function.

7.3.1.1 Reference Selection and DAC Transfer Function

The device writes the input data to the DAC data registers in straight-binary format. After a power-on or a reset event, the device sets all DAC registers to the values set in the NVM.

7.3.1.1.1 Power Supply as Reference

By default, the DACx3701-Q1 operate with the power-supply pin (V_{DD}) as a reference. [方程式 1](#) shows DAC transfer function when the power-supply pin is used as reference. The gain at the output stage is always 1x.

$$V_{\text{OUT}} = \frac{\text{DAC_DATA}}{2^N} \times V_{\text{DD}} \quad (1)$$

where:

- N is the resolution in bits, either 8 (DAC43701-Q1) or 10 (DAC53701-Q1).
- DAC_DATA is the decimal equivalent of the binary code that is loaded to the DAC register.
- DAC_DATA ranges from 0 to 2^N - 1.
- V_{DD} is used as the DAC reference voltage.

7.3.1.1.2 Internal Reference

The DACx3701-Q1 also contain an internal reference that is disabled by default. Enable the internal reference by writing 1 to REF_EN (address D1h). The internal reference generates a fixed 1.21-V voltage (typical). Using DAC_SPAN (address D1h) bits, gain of 1.5 ×, 2 ×, 3 ×, 4 × can be achieved for the DAC output voltage (V_{OUT}) [方程式 2](#) shows DAC transfer function when the internal reference is used.

$$V_{\text{OUT}} = \frac{\text{DAC_DATA}}{2^N} \times V_{\text{REF}} \times \text{GAIN} \quad (2)$$

where:

- N is the resolution in bits, either 8 (DAC43701-Q1) or 10 (DAC53701-Q1).
- DAC_DATA is the decimal equivalent of the binary code that is loaded to the DAC register
- DAC_DATA ranges from 0 to 2^N - 1.
- V_{REF} is the internal reference voltage = 1.21 V.
- GAIN = 1.5 ×, 2 ×, 3 ×, or 4 × based on DAC_SPAN (address D1h) bits.

7.3.2 General-Purpose Input (GPI)

The GPI pin of DACx3701-Q1 enables *processorless* operation. 表 7-1 shows that the GPI pin can be configured to trigger various functions. The GPI_EN bit in the TRIGGER (节 7.6.4) register enables or disables the GPI input. The GPI_CONFIG field in the CONFIG2 (节 7.6.3) register maps the GPI pin to various functions. The GPI operations are edge-triggered after the device boots up. After the power supply ramps up, the device registers the GPI level and executes the associated command. Use this feature configure the initial output state at power on. By default, the GPI pin is not mapped to any operation. Pull the GPI pin to high or low when not used. When the GPI pin is mapped to a specific function, the corresponding software bit functionality is disabled to avoid a race condition. When the GPI is mapped to margin-high or low trigger function, the output changes dynamically, unlike the behavior with I²C-based programming. All other constraints of the functions are applied to the GPI-based trigger.

表 7-1. GPI Configuration

REGISTER NAME	GPI_EN	GPI_CONFIG	PIN FUNCTION	PIN EDGE	COMMAND
D2h, CONFIG2 and D3h, TRIGGER	0	X	None	X	No Operation (Default)
	1	000	Power-Up, Down (Hi-Z)	Rising	Power-Up
				Falling	Hi-Z Power-Down
	1	001	Power-Up, Down (10-k Ω)	Rising	Power-Up
				Falling	10-k Ω Power-Down
	1	010	Margin-High, Low	Rising	Margin High Trigger
				Falling	Margin Low Trigger
	1	011	Function Generation	Rising	Start Function Generation
				Falling	Stop Function Generation
	1	100	High-Priority Medical Alarm	Rising	Start High-Priority Medical Alarm
				Falling	Stop High-Priority Medical Alarm
	1	101	Medium-Priority Medical Alarm	Rising	Start Medium-Priority Medical Alarm
				Falling	Stop Medium-Priority Medical Alarm
	1	110	Low-Priority Medical Alarm	Rising	Start Low-Priority Medical Alarm
				Falling	Stop Low-Priority Medical Alarm
	1	111	I ² C Target Address	Rising	Enable I ² C Target Address Update
Falling				Disable I ² C Target Address Update	

7.3.3 DAC Update

The DAC output pin (OUT) is updated at the end of I²C DAC write frame.

7.3.3.1 DAC Update Busy

The DAC_UPDATE_BUSY bit (address D0h) is set to 1 by the device when certain DAC update operations, such as *function generation*, *transition to margin high or low*, or any of the medical alarms are in progress. When the DAC_UPDATE_BUSY bit is set to 1, do not write to any of the DAC registers. After the DAC update operation is completed (DAC_UPDATE_BUSY = 0), any of the DAC registers can be written.

7.3.4 Nonvolatile Memory (EEPROM or NVM)

The DACx3701-Q1 contain nonvolatile memory (NVM) bits. These memory bits are user-programmable and erasable, and retain the set values in the absence of a power supply. All the register bits shown in 表 7-2 can be stored in the device NVM by setting NVM_PROG = 1 (address D3h). The NVM_BUSY bit (address D0h) is set to 1 by device when a NVM write or reload operation is ongoing. During this time, the device blocks all write operations to the device. The NVM_BUSY bit is set to 0 after the write or reload operation is complete; at this point, all write operations to the device are allowed. The default value for all the registers in the DACx3701-Q1 is loaded from NVM as soon as a POR event is issued. Do not perform a read operation from the DAC register while NVM_BUSY = 1.

The DACx3701-Q1 also implement NVM_RELOAD bit (address D3h). Set this bit to 1 for the device to start an NVM reload operation. After the operation is complete, the device autoresets this bit to 0. During the NVM_RELOAD operation, the NVM_BUSY bit is set to 1.

表 7-2. NVM Programmable Registers

REGISTER ADDRESS	REGISTER NAME	BIT ADDRESS	BIT NAME
D1h	GENERAL_CONFIG	13	DEVICE_LOCK
		11:9	CODE_STEP
		8:5	SLEW_RATE
		4:3	DAC_PDN
		2	REF_EN
		1:0	DAC_SPAN
D2h	CONFIG2	15:14	TARGET_ADDRESS
		13:11	GPI_CONFIG
		5:4	INTERBURST_TIME
		3:2	PULSE_OFF_TIME
		1:0	PULSE_ON_TIME
D3h	TRIGGER	10	GPI_EN
21h	DAC_DATA	11:2	DAC_DATA
25h	DAC_MARGIN_HIGH	11:4	MARGIN_HIGH (8 most significant bits)
26h	DAC_MARGIN_LOW	11:4	MARGIN_LOW (8 most significant bits)

7.3.4.1 NVM Cyclic Redundancy Check

The DACx3701-Q1 implement a cyclic redundancy check (CRC) feature for the device NVM to make sure that the data stored in the device NVM is uncorrupted. There are two types of CRC alarm bits implemented in DACx3701-Q1:

- NVM_CRC_ALARM_USER
- NVM_CRC_ALARM_INTERNAL

The NVM_CRC_ALARM_USER bit indicates the status of user-programmable NVM bits, and the NVM_CRC_ALARM_INTERNAL bit indicates the status of internal NVM bits. The CRC feature is implemented by storing a 10-Bit CRC (CRC-10-ATM) along with the NVM data each time NVM program operation (write or reload) is performed and during the device start up. The device reads the NVM data and validates the data with the stored CRC. The CRC alarm bits (NVM_CRC_ALARM_USER and NVM_CRC_ALARM_INTERNAL address 00h) report any errors after the data are read from the device NVM.

7.3.4.2 NVM_CRC_ALARM_USER Bit

A logic 1 on NVM_CRC_ALARM_USER bit indicates that the user-programmable NVM data are corrupt. During this condition, all registers in the DAC are initialized with factory reset values, and any DAC registers can be written to or read from. To reset the alarm bits to 0, issue a software reset (see [§ 7.3.7](#)) command, or cycle power to the DAC. A power cycle also reloads the user-programmable NVM bits. In case of NVM data corruption, program the NVM again.

7.3.4.3 NVM_CRC_ALARM_INTERNAL Bit

A logic 1 on NVM_CRC_ALARM_INTERNAL bit indicates that the internal NVM data are corrupt. During this condition, all registers in the DAC are initialized with factory reset values, and any DAC registers can be written to or read from. In case of a temporary failure, to reset the alarm bits to 0, issue a software reset (see [§ 7.3.7](#)) command or cycle power to the DAC.

7.3.5 Programmable Slew Rate

When the DAC data registers are written, the voltage on DAC output (V_{OUT}) immediately transitions to the new code following the slew rate and settling time specified in the *Electrical Characteristics*. The slew rate control feature controls the rate at which the output voltage (V_{OUT}) changes. When this feature is enabled (using SLEW_RATE[3:0] bits), the DAC output changes from the current code to the code in MARGIN_HIGH (address 25h) or MARGIN_LOW (address 26h) registers (when margin high or low commands are issued to the DAC) using the step and rate set in CODE_STEP and SLEW_RATE bits. With the default slew rate control setting (CODE_STEP and SLEW_RATE bits, address D1h), the output changes smoothly at a rate limited by the output drive circuitry and the attached load. Using this feature, the output steps digitally at a rate defined by bits CODE_STEP and SLEW_RATE on address D1h. SLEW_RATE defines the rate at which the digital slew updates; CODE_STEP defines the amount by which the output value changes at each update. 表 7-3 and 表 7-4 show different settings for CODE_STEP and SLEW_RATE.

表 7-3. Code Step

REGISTER ADDRESS AND NAME	CODE_STEP[2]	CODE_STEP[1]	CODE_STEP[0]	COMMENT
D1h, GENERAL_CONFIG	0	0	0	Code step size = 1 LSB (default)
	0	0	1	Code step size = 2 LSB
	0	1	0	Code step size = 3 LSB
	0	1	1	Code step size = 4 LSB
	1	0	0	Code step size = 6 LSB
	1	0	1	Code step size = 8 LSB
	1	1	0	Code step size = 16 LSB
	1	1	1	Code step size = 32 LSB

表 7-4. Slew Rate

REGISTER ADDRESS AND NAME	SLEW_RATE[3]	SLEW_RATE[2]	SLEW_RATE[1]	SLEW_RATE[0]	TIME PERIOD (PER STEP)
D1h, GENERAL_CONFIG	0	0	0	0	25.6 μ s
	0	0	0	1	32 μ s
	0	0	1	0	38.4 μ s
	0	0	1	1	44.8 μ s
	0	1	0	0	204.8 μ s
	0	1	0	1	256 μ s
	0	1	1	0	307.2 μ s
	0	1	1	1	819.2 μ s
	1	0	0	0	1638.4 μ s
	1	0	0	1	2457.6 μ s
	1	0	1	0	3276.8 μ s
	1	0	1	1	4915.2 μ s
	1	1	0	0	12 μ s
	1	1	0	1	8 μ s
	1	1	1	0	4 μ s
	1	1	1	1	0 μ s, no slew (default)

When the slew rate control feature is used, the output changes happen at the programmed slew rate. This configuration results in a staircase formation at the output. Do not write to CODE_STEP, SLEW_RATE, or DAC_DATA during the output slew.

7.3.6 Power-On Reset (POR)

The DACx3701-Q1 family of devices includes a power-on reset (POR) function that controls the output voltage at power up. After the V_{DD} supply has been established, a POR event is issued. The POR causes all registers to initialize to default values, and communication with the device is valid only after a 30-ms, POR delay. The default value for all the registers in the DACx3701-Q1 is loaded from NVM as soon as the POR event is issued.

When the device powers up, a POR circuit sets the device to the default mode. The POR circuit requires specific V_{DD} levels, as indicated in [Figure 7-1](#), to make sure that the internal capacitors discharge and reset the device on power up. To make sure that a POR occurs, V_{DD} must be less than 0.7 V for at least 1 ms. When V_{DD} drops to less than 1.65 V, but remains greater than 0.7 V (shown as the undefined region), the device may or may not reset under all specified temperature and power-supply conditions. In this case, initiate a POR. When V_{DD} remains greater than 1.65 V, a POR does not occur.



图 7-1. Threshold Levels for the V_{DD} POR Circuit

7.3.7 Software Reset

To initiate a device software reset event, write the reserved code 1010 to the SW_RESET (address D3h). A software reset initiates a POR event.

7.3.8 Device Lock Feature

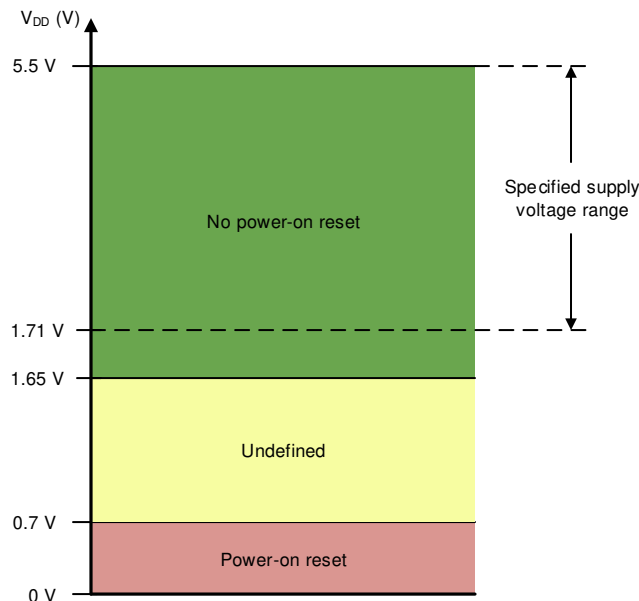
The DACx3701-Q1 implement a device lock feature that prevents an accidental or unintended write to the DAC registers. The device locks all the registers when the DEVICE_LOCK bit (address D1h) is set to 1. To bypass the DEVICE_LOCK setting, write 0101 to the DEVICE_UNLOCK_CODE bits (address D3h).

7.3.9 PMBus Compatibility

The PMBus protocol is an I²C-based communication standard for power-supply management. PMBus contains standard command codes tailored to power-supply applications. The DACx3701-Q1 implement some PMBus commands such as *Turn Off*, *Turn On*, *Margin Low*, *Margin High*, *Communication Failure Alert Bit (CML)*, as well as *PMBUS revision*. 图 7-2 shows typical PMBus connections. The EN_PMBUS bit (Bit 12, address D1h) must be set to 1 to enable the PMBus protocol.



图 7-2. PMBus Connections

Similar to I²C, PMBus is a variable length packet of 8-bit data bytes, each with a receiver acknowledge, wrapped between a start bit and a stop bit. The first byte is always a 7-bit *target address* followed by a *write bit*, sometimes called the *even address* that identifies the intended receiver of the packet. The second byte is an 8-bit *command* byte, identifying the PMBus command being transmitted using the respective command code. After the command byte, the transmitter either sends data associated with the command to write to the receiver command register (from most significant byte to least significant byte), or sends a new start bit indicating the desire to read the data associated with the command register from the receiver. Then the receiver transmits the data following the same most significant byte first format (see 表 7-8).

7.4 Device Functional Modes

7.4.1 Power Down Mode

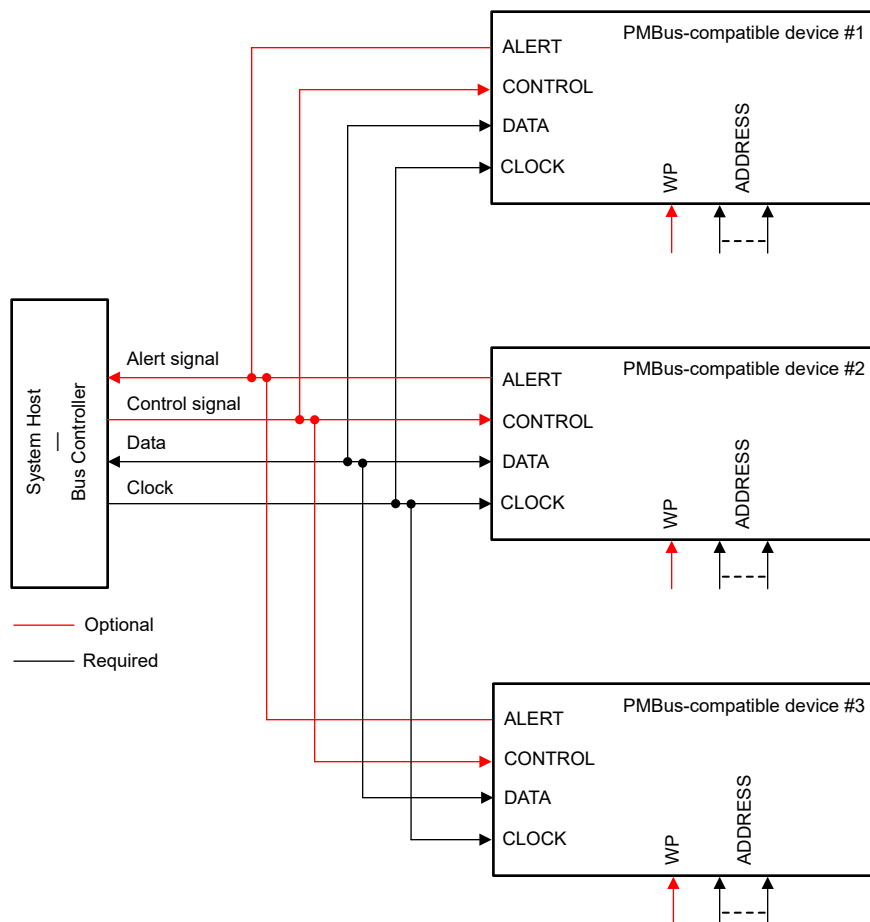
The DACx3701-Q1 output amplifier and internal reference can be independently powered down through the DAC_PDN bits (address D1h). At power up, the DAC output and the internal reference are disabled by default. In power-down mode, the DAC output (OUT pin) is in a high-impedance state. To change this state to 10kΩ- A_{GND} (at power up), use the DAC_PDN bits (address D1h).

The DAC power-up state can be programmed to any state (power-down or normal mode) using the NVM. 表 7-5 shows the DAC power-down bits.

表 7-5. DAC Power-Down Bits

REGISTER ADDRESS AND NAME	DAC_PDN[1]	DAC_PDN[0]	DESCRIPTION
D1h, GENERAL_CONFIG	0	0	Power up
	0	1	Power down to 10 kΩ
	1	0	Power down to high impedance (HiZ) (default)
	1	1	Power down to 10 kΩ

7.4.2 Continuous Waveform Generation (CWG) Mode

The DACx3701-Q1 implement a continuous waveform generation feature. To set the device to this mode, set the START_FUNC_GEN (address D3h) to 1. In this mode, the DAC output pin (OUT) generates a continuous waveform based on the FUNC_CONFIG bits (address D1h). 表 7-6 shows the continuous waveforms that can be generated in this mode. The following equations show the frequency of the waveform depends on the resistive and capacitive load on the OUT pin, high and low codes, and slew rate settings.

$$f_{SQUARE} = \frac{1}{2 \times SLEW_RATE} \quad (3)$$

$$f_{SAWTOOTH} = \frac{1}{SLEW_RATE \times CEILING\left(\frac{MARGIN_HIGH - MARGIN_LOW}{CODE_STEP} + 1\right)} \quad (4)$$

$$f_{TRIANGLE} = \frac{1}{2 \times SLEW_RATE \times CEILING\left(\frac{MARGIN_HIGH - MARGIN_LOW}{CODE_STEP}\right)} \quad (5)$$

where:

- SLEW_RATE is the programmable DAC slew rate specified in 表 7-4.
- MARGIN_HIGH and MARGIN_LOW are the programmable DAC codes.
- CODE_STEP is the programmable DAC step code in 表 7-3.
- CEILING is a function that returns the smallest integer value which is greater than or equal to the specified number.

The accuracy of the waveform frequencies depend on the accuracy of the internal oscillator. The DACx3701-Q1 support a calibration option to get the best oscillator frequency accuracy. The DAC-MARGIN-HIGH[11:4] register bits store the oscillator accuracy in the NVM in 2's compliment format. Any overwrite to these NVM bits clears this information permanently. The stored error resolution is 0.15% per LSB. 方程式 6 calculates the percentage frequency error.

$$f_{ERROR}(\%) = DAC_MARGIN_HIGH[11:4] \times 0.15 \quad (6)$$

表 7-6. FUNC_CONFIG bits

REGISTER ADDRESS AND NAME	FUNC_CONFIG[1]	FUNC_CONFIG[0]	DESCRIPTION
D1h, GENERAL_CONFIG	0	0	Generates a triangle wave between MARGIN_HIGH (address 25h) code to MARGIN_LOW (address 26h) code with the slope defined by the SLEW_RATE and CODE_STEP (address D1h) bits.
	0	1	Generates a sawtooth wave between MARGIN_HIGH (address 25h) code to MARGIN_LOW (address 26h) code, with the rising slope defined by the SLEW_RATE and CODE_STEP (address D1h) bits and immediate falling edge.
	1	0	Generates a sawtooth wave between MARGIN_HIGH (address 25h) code to MARGIN_LOW (address 26h) code, with the falling slope defined by the SLEW_RATE and CODE_STEP (address D1h) bits and immediate rising edge.
	1	1	Generates a square wave between MARGIN_HIGH (address 25h) code to MARGIN_LOW (address 26h) code with the pulse high and low period defined by the SLEW_RATE (address D1h) bits.

7.4.3 PMBus Compatibility Mode

The DACx3701-Q1 I²C interface implements some of the PMBus commands. 表 7-7 shows the supported PMBus commands that are implemented in DACx3701-Q1. The DAC uses MARGIN_LOW (address 26h), MARGIN_HIGH (address 25h) bits, SLEW_RATE, and CODE_STEP bits (address D1h) for PMBUS_OPERATION_CMD. The EN_PMBUS bit (Bit 12, address D1h) must be set to 1 to enable the PMBus protocol.

表 7-7. PMBus Operation Commands

REGISTER ADDRESS AND NAME	PMBUS_OPERATION_CMD[15:8]	DESCRIPTION
01h, PMBUS_OPERATION	00h	Turn off
	80h	Turn on
	94h	Margin low
	A4h	Margin high

The DACx3701-Q1 also implement PMBus features such as group command protocol and communication time-out failure. The CML bit (address 78h) indicates a communication fault in the PMBus. This bit is reset by writing 1.

To get the PMBus version, read the PMBUS_VERSION bits (address 98h).

7.5 Programming

The DACx3701-Q1 devices have a 2-wire serial interface, SCL and SDA (see the pin diagram in [# 5](#)). The I²C bus consists of a data line (SDA) and a clock line (SCL) with pullup structures. When the bus is idle, both SDA and SCL lines are pulled high. All the I²C-compatible devices connect to the I²C bus through the open drain I/O pins, SDA and SCL.

The I²C specification states that the device that controls communication is called a *controller*, and the devices that are controlled by the controller are called *targets*. The controller device generates the SCL signal. The controller device also generates special timing conditions (start condition, repeated start condition, and stop condition) on the bus to indicate the start or stop of a data transfer. Device addressing is completed by the controller. The controller device on an I²C bus is typically a microcontroller or digital signal processor (DSP). The DACx3701-Q1 family operates as a target device on the I²C bus. A target device acknowledges controller commands, and upon controller control, receives or transmits data.

Typically, the DACx3701-Q1 family operates as a target receiver. A controller device writes to the DACx3701-Q1, a target receiver. However, if a controller device requires the DACx3701-Q1 internal register data, the DACx3701-Q1 operate as a target transmitter. In this case, the controller device reads from the DACx3701-Q1. According to I²C terminology, read and write refer to the controller device.

The DACx3701-Q1 family is a target and supports the following data transfer modes:

- Standard mode (100Kbps)
- Fast mode (400Kbps)
- Fast-mode plus (1.0Mbps)

The data transfer protocol for standard and fast modes is exactly the same; therefore, both modes are referred to as *F/S-mode* in this document. The fast-mode plus protocol is supported in terms of data transfer speed, but not output current. The low-level output current is 3 mA; similar to the case of standard and fast modes. The DACx3701-Q1 family supports 7-bit addressing. The 10-bit addressing mode is not supported. The device supports the general call reset function. Sending the following sequence initiates a software reset within the device: start or repeated start, 0x00, 0x06, stop. The reset is asserted within the device on the rising edge of the ACK bit, following the second byte.

Other than specific timing signals, the I²C interface works with serial bytes. At the end of each byte, a ninth clock cycle generates and detects an acknowledge signal. An acknowledge is when the SDA line is pulled low during the high period of the ninth clock cycle. [图 7-3](#) shows that a not-acknowledge is when the SDA line is left high during the high period of the ninth clock cycle.



图 7-3. Acknowledge and Not Acknowledge on the I²C Bus

7.5.1 F/S Mode Protocol

The following steps explain a complete transaction in F/S mode.

1. The controller initiates data transfer by generating a start condition. 图 7-4 shows that the start condition is when a high-to-low transition occurs on the SDA line while SCL is high. All I²C-compatible devices recognize a start condition.
2. The controller then generates the SCL pulses, and transmits the 7-bit address and the read/write direction bit (R/\overline{W}) on the SDA line. During all transmissions, the controller makes sure that data are valid. 图 7-5 shows that a valid data condition requires the SDA line to be stable during the entire high period of the clock pulse. All devices recognize the address sent by the controller and compare the address to the respective internal fixed address. Only the target device with a matching address generates an acknowledge by pulling the SDA line low during the entire high period of the 9th SCL cycle (see 图 7-3). When the controller detects this acknowledge, the communication link with a target has been established.
3. The controller generates further SCL cycles to transmit (R/\overline{W} bit 0) or receive (R/\overline{W} bit 1) data to the target. In either case, the receiver must acknowledge the data sent by the transmitter. The acknowledge signal can be generated by the controller or by the target, depending on which is the receiver. The 9-bit valid data sequences consists of 8-data bits and 1 acknowledge-bit, and can continue as long as necessary.
4. 图 7-4 shows that to signal the end of the data transfer, the controller generates a stop condition by pulling the SDA line from low-to-high while the SCL line is high. This action releases the bus and stops the communication link with the addressed target. All I²C-compatible devices recognize the stop condition. Upon receipt of a stop condition, the bus is released, and all target devices then wait for a start condition followed by a matching address.

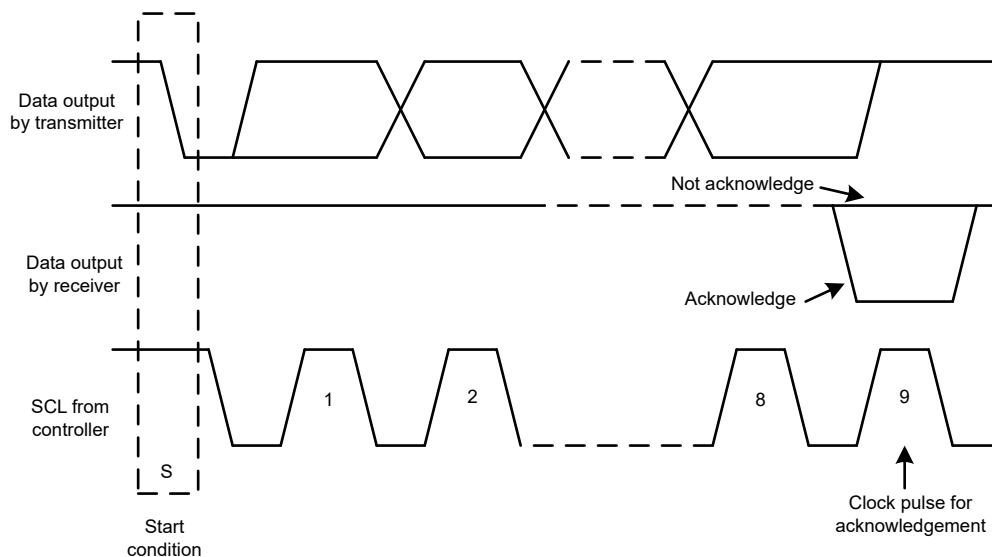

图 7-4. Start and Stop Conditions



图 7-5. Bit Transfer on the I²C Bus

7.5.2 I²C Update Sequence

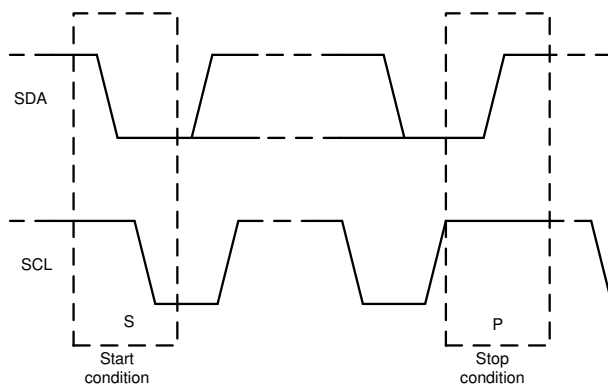
For a single update, the DACx3701-Q1 require a start condition, a valid I²C address byte, a command byte, and two data bytes. 表 7-8 lists the update sequence.

表 7-8. Update Sequence

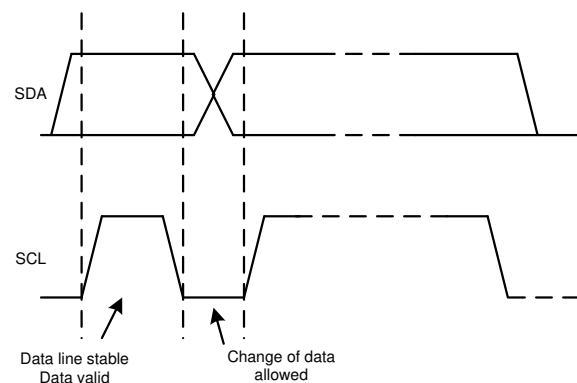
MSB	LSB	ACK	MSB	...	LSB	ACK	MSB	...	LSB	ACK	MSB	...	LSB	ACK
Address (A) byte 节 7.5.2.1				Command byte 节 7.5.2.2				Data byte - MSDB				Data byte - LSDB			
DB [31:24]				DB [23:16]				DB [15:8]				DB [7:0]			

After each byte is received, the DACx3701-Q1 family acknowledges the byte by pulling the SDA line low during the high period of a single clock pulse. 图 7-6 shows the I²C bus protocol. These four bytes and acknowledge cycles make up the 36 clock cycles required for a single update to occur. A valid I²C address byte selects the DACx3701-Q1 devices.



图 7-6. I²C Bus Protocol

The command byte sets the operating mode of the selected DACx3701-Q1 device. For a data update to occur when the operating mode is selected by this byte, the DACx3701-Q1 device must receive two data bytes: the most significant data byte (MSDB) and least significant data byte (LSDB). The DACx3701-Q1 device performs an update on the falling edge of the acknowledge signal that follows the LSDB.

When using fast mode (clock = 400 kHz), the maximum DAC update rate is limited to 10 kSPS. Using the fast-mode plus (clock = 1 MHz), the maximum DAC update rate is limited to 25 kSPS. When a stop condition is received, the DACx3701-Q1 device releases the I²C bus and awaits a new start condition.

7.5.2.1 Address Byte

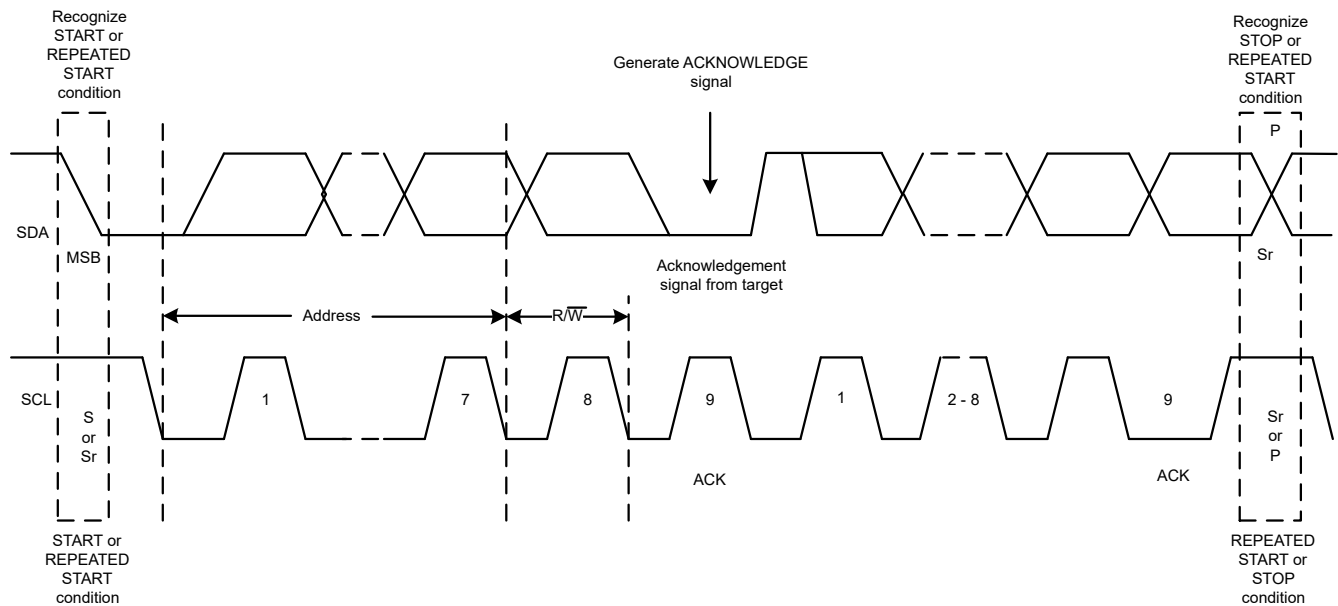
The following tables shows the address byte, which is the first byte received following the start condition from the controller device. The first five bits (MSBs) of the address are factory preset to 10010. The next two bits of the address are controlled by the TARGET_ADDRESS field in the CONFIG2 register. Follow the procedure described in the next section to configure the target address. The possible target addresses using these bits are also shown in the next section.

表 7-9. Address Byte

COMMENT	MSB						LSB	
	AD6	AD5	AD4	AD3	AD2	AD1	AD0	R/ W
—								
General address	1	0	0	1	0	See 表 7-10 (target address column)		0 or 1
Broadcast address	1	0	0	0	1	1	1	0

The DACx3701-Q1 family supports broadcast addressing, which can be used for synchronously updating or powering down multiple DACx3701-Q1 devices. The DACx3701-Q1 family is designed to work with other members of the family to support multichip synchronous updates. Using the broadcast address, the DACx3701-Q1 devices respond regardless of the states of the TARGET_ADDRESS bits. Broadcast is only supported in write mode.

7.5.2.1.1 Target Address Configuration

This section provides the step by step procedure to configure the I²C target addresses for up to four DACs. Use the broadcast address for all the steps.

1. Set GPI pin to 0b for all devices.
2. Set GPI_CONFIG in the CONFIG2 register to 111b.
3. Set GPI_EN in the TRIGGER register to 1b.
4. Set the GPI pin to logic high for the device to be configured.
5. Write data to TARGET_ADDRESS bit field in the CONFIG2 register. Only the device with GPI pin logic high updates the TARGET_ADDRESS setting passed in the command. Make sure that the rest of the devices on the same I²C bus have the respective GPI pins set to logic low during this process.
6. Toggle the GPI pin of the device bring programmed to logic low.
7. Repeat steps (1) through (6) above to program the I²C target addresses to all the devices on the bus.
8. Set GPI_EN to 0b.
9. Change GPI_CONFIG to 000b.
10. Trigger NVM write operation.

The devices are now ready for use.

表 7-10. Address Format

TARGET ADDRESS	TARGET_ADDRESS FIELD IN CONFIG2 REGISTER
1001000	00 (default)
1001001	01
1001010	10
1001011	11

7.5.2.2 Command Byte

表 7-11 lists the command byte addresses.

表 7-11. Command Byte (Register Names)

ADDRESS	REGISTER NAME
D0h	STATUS
D1h	GENERAL_CONFIG
D2h	CONFIG2
D3h	TRIGGER
21h	DAC_DATA
25h	DAC_MARGIN_HIGH
26h	DAC_MARGIN_LOW
01h	PMBUS_OPERATION
78h	PMBUS_STATUS_BYTE
98h	PMBUS_VERSION

7.5.3 I²C Read Sequence

To read any register the following command sequence must be used:

1. Send a start or repeated start command with a target address and the R/ \overline{W} bit set to 0 for writing. The device acknowledges this event.
2. Send a command byte for the register to be read. The device acknowledges this event again.
3. Send a repeated start with the target address and the R/ \overline{W} bit set to 1 for reading. The device acknowledges this event.
4. The device writes the MSDB byte of the addressed register. The controller must acknowledge this byte.
5. Finally, the device writes out the LSDB of the register.

An alternative reading method allows for reading back the value of the last register written. The sequence is a start or repeated start with the target address and the R/ \overline{W} bit set to 1, and the two bytes of the last register are read out.

The broadcast address cannot be used for reading.

表 7-12. Read Sequence

S	MSB	...	R/ \overline{W} (0)	ACK	MSB	...	LSB	ACK	Sr	MSB	...	R/ \overline{W} (1)	ACK	MSB	...	LSB	ACK	MSB	...	LSB	ACK
	Address Byte 节 7.5.2.1				Command Byte 节 7.5.2.2				Sr	Address Byte 节 7.5.2.1				MSDB				LSDB			
	From controller			Target	From controller			Target		From controller			Target	From target			Controller	From target			Controller

7.6 Register Map

表 7-13. Register Map

ADDRESS	MOST SIGNIFICANT DATA BYTE (MSDB)								LEAST SIGNIFICANT DATA BYTE (LSDB)							
	BIT15	BIT14	BIT13	BIT12	BIT11	BIT10	BIT9	BIT8	BIT7	BIT6	BIT5	BIT4	BIT3	BIT2	BIT1	BIT0
D0h	NVM_CRC_ALARM_USER	NVM_CRC_ALARM_INTERNAL	NVM_BUSY	DAC_UPDATE_BUSY	X ⁽¹⁾				DEVICE_ID				VERSION_ID			
D1h	FUNC_CONFIG		DEVICE_LOCK	EN_PMBUS	CODE_STEP			SLEW_RATE			DAC_PDN		REF_EN	DAC_SPAN		
D2h	TARGET_ADDRESS		GPI_CONFIG			RESERVED				FB_IMP						
D3h	DEVICE_UNLOCK_CODE				X	GPI_EN	DEVICE_CONFIG_RESET	START_FUNC_GEN	PMBUS_MARGIN_HIGH	PMBUS_MARGIN_LOW	NVM_RELOAD	NVM_PROG	SW_RESET			
21h	X				DAC_DATA[9:0] (10-Bit) or DAC_DATA[7:0] (8-Bit)											X
25h	X				MARGIN_HIGH[9:0] (10-Bit) or MARGIN_HIGH[7:0] (8-Bit)											X
26h	X				MARGIN_LOW[9:0] (10-Bit) or MARGIN_LOW[7:0] (8-Bit)											X
01h	PMBUS_OPERATION_CMD								Not available							
78h	X						CML	X	Not available							
98h	PMBUS_VERSION								Not available							

(1) X = Don't care.

表 7-14. Register Names

ADDRESS	REGISTER NAME	SECTION
D0h	STATUS	节 7.6.1
D1h	GENERAL_CONFIG	节 7.6.2
D2h	CONFIG2	节 7.6.3
D3h	TRIGGER	节 7.6.4
21h	DAC_DATA	节 7.6.5
25h	DAC_MARGIN_HIGH	节 7.6.6
26h	DAC_MARGIN_LOW	节 7.6.7
01h	PMBUS_OPERATION	节 7.6.8
78h	PMBUS_STATUS_BYTE	节 7.6.9
98h	PMBUS_VERSION	节 7.6.10

表 7-15. Access Type Codes

Access Type	Code	Description
X	X	Don't care
Read Type		
R	R	Read
Write Type		
W	W	Write
Reset or Default Value		
-n		Value after reset or the default value

7.6.1 STATUS Register (address = D0h) [reset = 000Ch or 0014h]

图 7-7. STATUS Register

15	14	13	12	11	10	9	8	7	6	5	4	3	2	1	0
NVM_CRC_ALARM_USER	NVM_CRC_ALARM_INTERNAL	NVM_BUSY	DAC_UPDATE_BUSY	X			DEVICE_ID			VERSION_ID					
R-0	R-0	R-0	R-0	X-00h			10-bit: R-3h 8-bit: R-5h			R-00					

表 7-16. STATUS Register Field Descriptions

Bit	Field	Type	Reset	Description
15	NVM_CRC_ALARM_USER	R	0	0: No CRC error in user NVM bits 1: CRC error in user NVM bits
14	NVM_CRC_ALARM_INTERNAL	R	0	0: No CRC error in internal NVM 1: CRC error in internal NVM bits
13	NVM_BUSY	R	0	0: NVM write or load completed, Write to DAC registers allowed 1: NVM write or load in progress, Write to DAC register map not allowed
12	DAC_UPDATE_BUSY	R	0	0: DAC outputs updated, Write to DAC registers allowed 1: DAC outputs update in progress, Write to DAC register map not allowed
11:6	X	X	00h	Don't care
5:2	DEVICE_ID	R	DAC53701-Q1: 3h DAC43701-Q1: 5h	Device identifier: DAC53701-Q1: 3h DAC43701-Q1: 5h
1:0	VERSION_ID	R	00	Silicon version identifier. This field can have a different value based on the silicon revision.

7.6.2 GENERAL_CONFIG Register (address = D1h) [reset = 01F0h]

图 7-8. GENERAL_CONFIG Register

15	14	13	12	11	10	9	8	7	6	5	4	3	2	1	0
FUNC_CONFIG		DEVICE_LOCK	EN_PMBUS	CODE_STEP			SLEW_RATE			DAC_PDN	REF_EN	DAC_SPAN			
R/W-00		R/W-0	R/W-0	R/W-000			R/W-Fh			R/W-10h	R/W-0	R/W-00			

表 7-17. GENERAL_CONFIG Register Field Descriptions

Bit	Field	Type	Reset	Description
15:14	FUNC_CONFIG	R/W	00	00: Generates a triangle wave between MARGIN_HIGH (address 25h) code to MARGIN_LOW (address 26h) code with slope defined by SLEW_RATE and CODE_STEP bits. 01: Generates Saw-Tooth wave between MARGIN_HIGH (address 25h) code to MARGIN_LOW (address 26h) code, with rising slope defined by SLEW_RATE and CODE_STEP bits and immediate falling edge. 10: Generates Saw-Tooth wave between MARGIN_HIGH (address 25h) code to MARGIN_LOW (address 26h) code, with falling slope defined by SLEW_RATE and CODE_STEP bits and immediate rising edge. 11: Generates a square wave between MARGIN_HIGH (address 25h) code to MARGIN_LOW (address 26h) code with pulse high and low period defined by SLEW_RATE bits.
13	DEVICE_LOCK	R/W	0	0: Device not locked 1: Device locked, the device locks all the registers. This bit can be overwritten (unlock device) by writing 0101 to the DEVICE_UNLOCK_CODE bits (address D3h)

表 7-17. GENERAL_CONFIG Register Field Descriptions (continued)

Bit	Field	Type	Reset	Description
12	EN_PMBUS	R/W	0	0: PMBus mode disabled 1: PMBus mode enabled
11:9	CODE_STEP	R/W	000	Code step for programmable slew rate control. 000: Code step size = 1 LSB (default) 001: Code step size = 2 LSB 010: Code step size = 3 LSB 011: Code step size = 4 LSB 100: Code step size = 6 LSB 101: Code step size = 8 LSB 110: Code step size = 16 LSB 111: Code step size = 32 LSB
8:5	SLEW_RATE	R/W	Fh	Slew rate for programmable slew rate control. 0000: 25.6 μ s (per step) 0001: 32 μ s (per step) 0010: 38.4 μ s (per step) 0011: 44.8 μ s (per step) 0100: 204.8 μ s (per step) 0101: 256 μ s (per step) 0110: 307.2 μ s (per step) 0111: 819.2 μ s (per step) 1000: 1.6384 ms (per step) 1001: 2.4576 ms (per step) 1010: 3.2768 ms (per step) 1011: 4.9152 ms (per step) 1100: 12 μ s (per step) 1101: 8 μ s (per step) 1110: 4 μ s (per step) 1111: No slew (default)
4:3	DAC_PDN	R/W	10	00: Power up 01: Power down to 10 k Ω 10: Power down to high impedance (default) 11: Power down to 10 k Ω
2	REF_EN	R/W	0	0: Internal reference disabled, V_{DD} is DAC reference voltage, DAC output range from 0 V to V_{DD} . 1: Internal reference enabled, DAC reference = 1.21 V, DAC output range is a function of DAC_SPAN.
1:0	DAC_SPAN	R/W	00	Only applicable when internal reference is enabled. 00: Reference to V_{OUT} gain = 1.5 \times 01: Reference to V_{OUT} gain = 2 \times 10: Reference to V_{OUT} gain = 3 \times 11: Reference to V_{OUT} gain = 4 \times

7.6.3 CONFIG2 Register (address = D2h) [reset = device-specific]

图 7-9. CONFIG2 Register

15	14	13	12	11	10	9	8	7	6	5	4	3	2	1	0
TARGET_ADDRESS		GPI_CONFIG			RESERVED					FB_IMP					
R/W-00		R/W-000			R/W-00h					R/W-device-specific					

表 7-18. CONFIG2 Register Field Descriptions

Bit	Field	Type	Reset	Description
15:14	TARGET_ADDRESS	R/W	00	AD1-AD0 of target address as per 表 7-10
13:11	GPI_CONFIG	R/W	000	Refer to 表 7-1 for the GPI configuration
10:6	RESERVED	R/W	00h	Reserved.
5:0	FB_IMP	R/W	Device-specific	These register bits store the measured error of the dc impedance from the FB pin to ground with respect to the typical value, for internal reference with gains 3 × and 4 ×. This value is stored in the NVM. An overwrite to these NVM bits clears this information permanently. The error resolution is 1% and the measurement accuracy is ±2%.

7.6.4 TRIGGER Register (address = D3h) [reset = 0008h]

图 7-10. TRIGGER Register

15	14	13	12	11	10	9	8	7	6	5	4	3	2	1	0	
DEVICE_UNLOCK_CODE				X	GPI_EN	DEVICE_CONFIG_RESET	START_FUNC_GEN	PMBUS_MARGIN_HIGH	PMBUS_MARGIN_LOW	NVM_RELOAD	NVM_PROG	SW_RESET				
W-0h				X-0	R/W-0	W-0	R/W-0	R/W-0	R/W-0	R/W-0	R/W-0	R/W-0	W-8h			

表 7-19. TRIGGER Register Field Descriptions

Bit	Field	Type	Reset	Description
15:12	DEVICE_UNLOCK_CODE	W	0h	Write 0101 to unlock the device to bypass DEVICE_LOCK bit.
11	X	X	0	Don't care
10	GPI_EN	R/W	0	0: GPI disabled 1: GPI enabled
9	DEVICE_CONFIG_RESET	W	0	0: Device configuration reset not initiated 1: Device configuration reset initiated. All registers loaded with factory reset values.
8	START_FUNC_GEN	R/W	0	0: Continuous waveform generation mode disabled 1: Continuous waveform generation mode enabled, device generates continuous waveform based on FUNC_CONFIG (address D1h), MARGIN_LOW (address 26h), MARGIN_HIGH (address 25h), and SLEW_RATE and CODE_STEP (address D1h) bits.
7	PMBUS_MARGIN_HIGH	R/W	0	0: PMBus margin high command not initiated 1: PMBus margin high command initiated, DAC output margins high to MARGIN_HIGH code (address 25h). This bit automatically resets to 0 after the DAC code reaches MARGIN_HIGH value.
6	PMBUS_MARGIN_LOW	R/W	0	0: PMBus margin low command not initiated 1: PMBus margin low command initiated, DAC output margins low to MARGIN_LOW code (address 26h). This bit automatically resets to 0 after the DAC code reaches MARGIN_LOW value.
5	NVM_RELOAD	R/W	0	0: NVM reload not initiated 1: NVM reload initiated, applicable DAC registers loaded with corresponding NVM. NVM_BUSY bit set to 1 which this operation is in progress.. This bit self-resets.
4	NVM_PROG	R/W	0	0: NVM write not initiated 1: NVM write initiated, NVM corresponding to applicable DAC registers loaded with existing register settings. NVM_BUSY bit set to 1 which this operation is in progress. This bit self-resets.
3:0	SW_RESET	W	8h	1000: Software reset not initiated 1010: Software reset initiated, DAC registers loaded with corresponding NVMs, all other registers loaded with default settings.

7.6.5 DAC_DATA Register (address = 21h) [reset = 0000h]

图 7-11. DAC_DATA Register

15	14	13	12	11	10	9	8	7	6	5	4	3	2	1	0
X				DAC_DATA[9:0] / DAC_DATA[7:0] - MSB Left aligned											X
X-0h				R/W-000h											X-00

表 7-20. DAC_DATA Register Field Descriptions

Bit	Field	Type	Reset	Description
15:12	X	X	0h	Don't care
11:2	DAC_DATA[9:0] / DAC_DATA[7:0]	R/W	000h	Writing to the DAC_DATA register forces the respective DAC channel to update the active register data to the DAC_DATA. Data are in straight binary format and use the following format: DACx3701-Q1: {DATA[9:0]} DACx3701-Q1: {DATA[7:0], X, X} X = Don't care bits
1:0	X	X	00	Don't care

7.6.6 DAC_MARGIN_HIGH Register (address = 25h) [reset = device-specific]

图 7-12. DAC_MARGIN_HIGH Register

15	14	13	12	11	10	9	8	7	6	5	4	3	2	1	0
X			MARGIN_HIGH[9:0] / MARGIN_HIGH[7:0] - MSB Left aligned												X
X-0h			R/W-device-specific												X-00

表 7-21. DAC_MARGIN_HIGH Register Field Descriptions

Bit	Field	Type	Reset	Description
15:12	X	X	0h	Don't care
11:2	MARGIN_HIGH[9:0] / MARGIN_HIGH[7:0] - MSB Left aligned	R/W	Device-specific	Margin high code for DAC output. Data are in straight binary format and use the following format: DACx3701-Q1: {MARGIN_HIGH[[9:0]]} DACx3701-Q1: {MARGIN_HIGH[[7:0], X, X]} X = Don't care bits The MARGIN_HIGH[7:0] bits store the oscillator frequency error for every device with 0.15%/LSB resolution in the NVM. An overwrite to this NVM field clears the error information permanently. See 节 7.4.2 for the error calculation.
1:0	X	X	00	Don't care

7.6.7 DAC_MARGIN_LOW Register (address = 26h) [reset = device-specific]

图 7-13. DAC_MARGIN_LOW Register

15	14	13	12	11	10	9	8	7	6	5	4	3	2	1	0
X			MARGIN_LOW[9:0] / MARGIN_LOW[7:0] - MSB Left aligned												X
X-0h			R/W-device-specific												X-00

表 7-22. DAC_MARGIN_LOW Register Field Descriptions

Bit	Field	Type	Reset	Description
15:12	X	X	0h	Don't care
11:2	MARGIN_LOW[9:0] / MARGIN_LOW[7:0] - MSB Left aligned	R/W	Device-specific	Margin low code for DAC output. Data are in straight binary format and follows the format below: DACx3701-Q1: {MARGIN_LOW[[9:0]]} DACx3701-Q1: {MARGIN_LOW[[7:0], X, X]} X = Don't care bits Register bits 7:2 store the measured error of the dc impedance from the FB pin to ground with respect to the typical value, for external reference or internal reference with gains 1 × and 2 ×. This value is stored in the NVM. An overwrite to these NVM bits clears this information permanently. The error resolution is 1% and the measurement accuracy is ±2%.
1:0	X	X	00	Don't care

7.6.8 PMBUS_OPERATION Register (address = 01h) [reset = 0000h]

图 7-14. PMBUS_OPERATION Register

15	14	13	12	11	10	9	8	7	6	5	4	3	2	1	0
PMBUS_OPERATION_CMD											X				
R/ W-00h											X-00h				

表 7-23. PMBUS_OPERATION Register Field Descriptions

Bit	Field	Type	Reset	Description
15:8	PMBUS_OPERATION_CMD	R/W	00h	PMBus operation commands 00h: Turn off 80h: Turn on A4h: Margin high, DAC output margins high to MARGIN_HIGH code (address 25h) 94h: Margin low, DAC output margins low to MARGIN_LOW code (address 26h)
7:0	X	X	00h	Not applicable

7.6.9 PMBUS_STATUS_BYTE Register (address = 78h) [reset = 0000h]

图 7-15. PMBUS_STATUS_BYTE Register

15	14	13	12	11	10	9	8	7	6	5	4	3	2	1	0
X						CML	X	N/A							
X-00h						R/W-0	X-0	X-00h							

表 7-24. PMBUS_STATUS_BYTE Register Field Descriptions

Bit	Field	Type	Reset	Description
15:10	X	X	00h	Don't care
9	CML	R/W	0	0: No communication Fault 1: PMBus communication fault for write with incorrect number of clocks, read before write command, invalid command address, and invalid or unsupported data value; reset this bit by writing 1.
8	X	X	0	Don't care
7:0	X	X	00h	Not applicable

7.6.10 PMBUS_VERSION Register (address = 98h) [reset = 2200h]

图 7-16. PMBUS_VERSION Register

15	14	13	12	11	10	9	8	7	6	5	4	3	2	1	0
PMBUS_VERSION											X				
R-22h											X-00h				

表 7-25. PMBUS_VERSION Register Field Descriptions

Bit	Field	Type	Reset	Description
15:8	PMBUS_VERSION	R	22h	PMBus version
7:0	X	X	00h	Not applicable

8 Application and Implementation

备注

以下应用部分中的信息不属于 TI 器件规格的范围，TI 不担保其准确性和完整性。TI 的客户应负责确定器件是否适用于其应用。客户应验证并测试其设计，以确保系统功能。

8.1 Application Information

The DACx3701 are buffered, force-sense output, single-channel, DACs that include an NVM and internal reference and are available in a tiny 3-mm × 3-mm package. These DACs are designed for general-purpose applications in a wide range of end equipment. Some of the most common applications for these devices are power-supply margining and control, adaptive voltage scaling (AVS), *set-and-forget* LED biasing in automotive applications and mobile projectors, general-purpose function generation, medical alarm generation, and programmable comparator applications (such as smoke detectors, standalone PWM control loops, and offset and gain trimming in precision circuits).

8.2 Typical Applications

This section explains the design details of two primary applications of DACx3701-Q1: power-supply margining and LED thermal foldback.

8.2.1 Power-Supply Margining

A power-supply margining or scaling circuit is used to test and trim the output of a power converter. This example circuit is used to test a system by margining the power supplies, for adaptive voltage scaling, or to program a desired value at the output. Adjustable power supplies, such as LDOs and DC/DC converters provide a feedback or adjust input that is used to set the desired output. A precision voltage-output DAC is the best choice for controlling the power-supply output linearly. 图 8-1 shows a control circuit for a switch-mode power supply (SMPS) using the DACx3701-Q1. Typical applications of power-supply margining are communications equipment, enterprise servers, test and measurement, automotive processor modules, and general-purpose power-supply modules.



图 8-1. Power-Supply Margining

8.2.1.1 Design Requirements

- Power-supply nominal output: 3.3 V
- Reference voltage of the converter (V_{FB}): 0.6 V
- Margin: $\pm 10\%$ (that is, 2.97 V to 3.63 V)
- DAC output range: 1.8 V
- Nominal current through R_1 and R_2 : 100 μA

8.2.1.2 Detailed Design Procedure

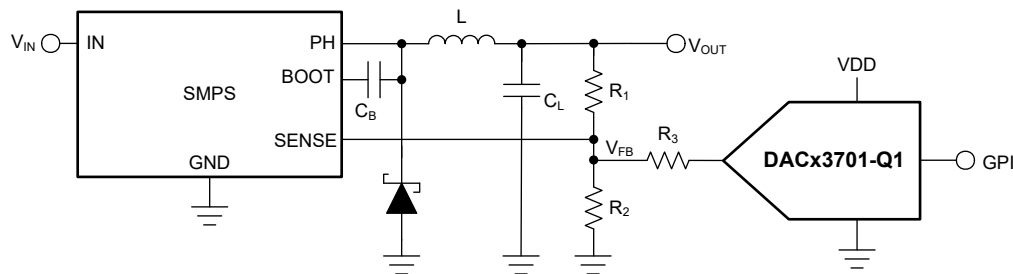
The DACx3701-Q1 features a Hi-Z power-down mode that is set by default at power up, unless the device is programmed otherwise using the NVM. When the DAC output is at Hi-Z, the current through R_3 is zero and the SMPS is set at the nominal output voltage of 3.3 V. To have the same nominal condition when the DAC powers up, bring up the device at the same output as V_{FB} (that is 0.6 V). This configuration makes sure there is no current through R_3 even at power-up. Calculate R_1 as $(V_{OUT} - V_{FB}) / 100 \mu\text{A} = 27 \text{ k}\Omega$.

To achieve $\pm 10\%$ margin-high and margin-low conditions, the DAC must sink or source additional current through R_1 . Calculate the current from the DAC (I_{MARGIN}) using [方程式 7](#) as 12 μA .

$$I_{MARGIN} = \left(\frac{V_{OUT} \times (1 + \text{MARGIN}) - V_{FB}}{R_1} \right) - I_{NOMINAL} \quad (7)$$

where

- I_{MARGIN} is the margin current sourced or sunk from the DAC.
- MARGIN is the percentage margin value divided by 100.
- $I_{NOMINAL}$ is the nominal current through R_1 and R_2 .

To calculate the value of R_3 , first decide the DAC output range, and make sure to avoid the codes near zero-scale and full-scale for safe operation in the linear region. A DAC output of 20 mV is a safe consideration as the minimum output, and $(1.8 \text{ V} - 0.6 \text{ V} - 20 \text{ mV} = 1.18 \text{ V})$ as the maximum output. When the DAC output is at 20 mV, the power supply goes to margin high, and when the DAC output is at 1.18 V, the power supply goes to margin low. Calculate the value of R_3 using [方程式 8](#) as 48.3 $\text{k}\Omega$. Choose a standard resistor value and adjust the DAC outputs. Choosing $R_3 = 47 \text{ k}\Omega$ makes the DAC margin high code as 1.164 V and the DAC margin low code as 36 mV.

$$R_3 = \frac{|V_{DAC} - V_{FB}|}{I_{MARGIN}} \quad (8)$$

The DACx3701-Q1 have a slew rate feature that is used to toggle between margin high, margin low, and nominal outputs with a defined slew rate. See the [表 7-17](#) for the slew rate setting details.

备注

The MARGIN HIGH register value in DACx3701-Q1 results in the MARGIN LOW value at the power supply output. Similarly, the MARGIN LOW register value in DACx3701-Q1 results in the MARGIN HIGH value at the power-supply output.

The pseudocode for getting started with a power-supply control application is as follows:

```
//SYNTAX: WRITE <REGISTER NAME (Hex code)>, <MSB DATA>, <LSB DATA>
//Write DAC code (12-bit aligned) for nominal output
//For a 1.8-V output range, the 10-bit hex code for 0.6 V is 0x0155.
//With 12-bit alignment, the hex code is 0x0554
WRITE DAC_DATA(0x21), 0x05, 0x54
//Write DAC code (12-bit aligned) for margin-low output at the power supply
//For a 1.8-V output range, the 10-bit hex code for 1.164 V is 0x0296.
//With 12-bit alignment, the hex code is 0x0A58
WRITE DAC_MARGIN_HIGH(0x25), 0x0A, 0x58
//write DAC code (12-bit aligned) for margin-high output at the power supply
//For a 1.8-V output range, the 10-bit hex code for 36 mV is 0x14.
//With 12-bit alignment, the hex code is 0x50
WRITE DAC_MARGIN_LOW(0x26), 0x00, 0x50
//Power-up the device with enable internal reference with 1.5x output span.
//This configuration outputs the nominal voltage (0.6 V)
//CODE_STEP: 2 LSB, SLEW_RATE: 25.6 μs
WRITE GENERAL_CONFIG(0xD1), 0x12, 0x14
//Trigger margin-low output at the power supply
WRITE TRIGGER(0xD3), 0x00, 0x80
//Trigger margin-high output at the power supply
WRITE TRIGGER(0xD3), 0x00, 0x40
//write back DAC code (12-bit aligned) for nominal output
WRITE DAC_DATA(0x21), 0x05, 0x54
```

8.2.1.3 Application Curves

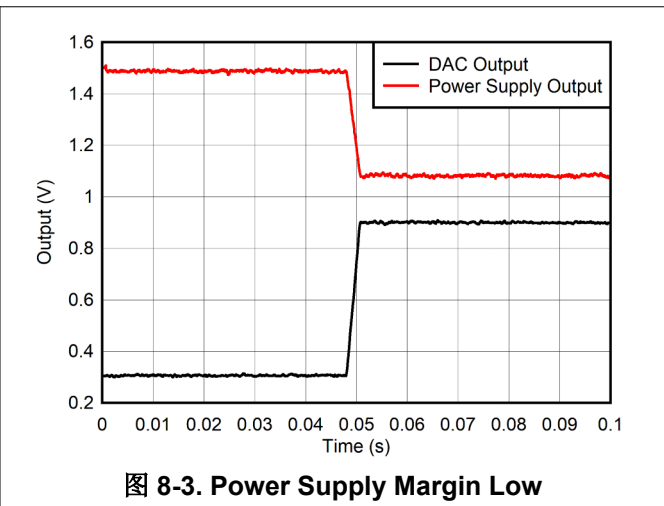
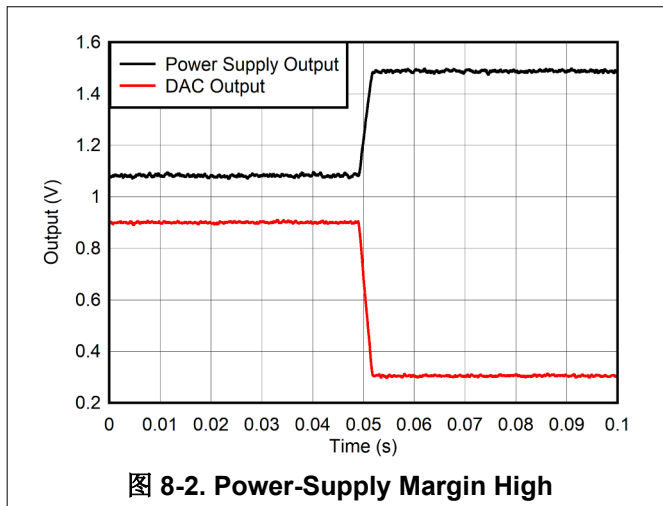

8.2.2 LED Thermal Foldback

The reliability of LED lights is inversely proportional to the operating temperature. Most LED lighting designs implement a heat sink for thermal management. However, to improve the life of the LEDs, an active thermal-foldback loop is needed to avoid over-design of the thermal management components. The daytime running light (DRL) in automotive lighting remains always on and is exposed to sunlight during daytime. Thermal foldback is a necessity in DRLs to maximize the LED life. DACx3701-Q1 provides a thermal-foldback loop using the force-sense output of the DAC. 图 8-4 shows a simplified circuit diagram of the LED thermal foldback.



图 8-4. LED Thermal Foldback

8.2.2.1 Design Requirements

- LED supply voltage: 12 V
- DAC supply voltage: 5 V
- Temperature range: -20°C to $+105^{\circ}\text{C}$
- Foldback point: 30°C
- Cut-off temperature: 105°C
- Output type: PWM
- PWM frequency: approximately 200 Hz

8.2.2.2 Detailed Design Procedure

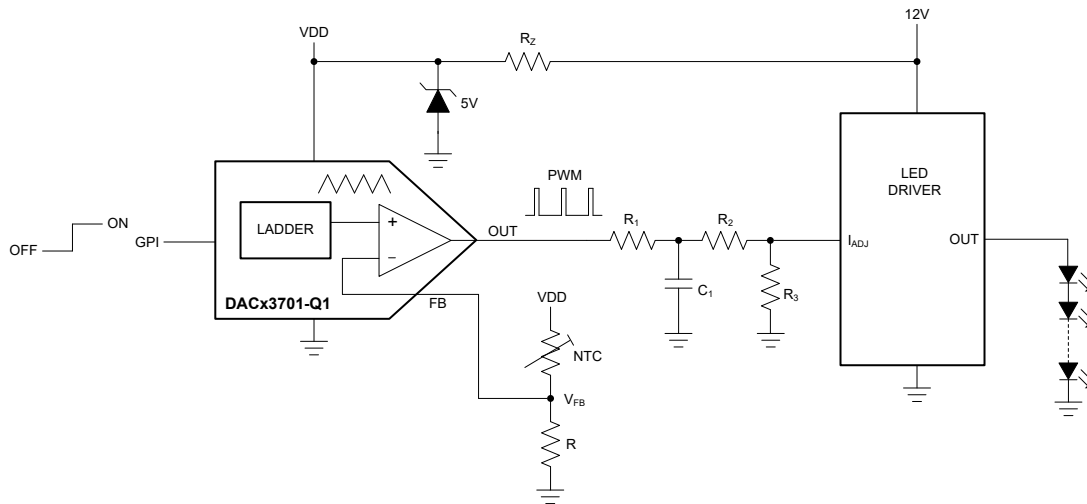
Choose a 5-V Zener diode of less than $50\ \mu\text{A}$ of reverse current. The DACx3701-Q1 consumes a quiescent current of around $200\ \mu\text{A}$. Assume the load current of the DAC to be maximum $500\ \mu\text{A}$. Thus, the total current needed for the DAC and the Zener diode is $750\ \mu\text{A}$. Considering a $2\times$ derating factor, design the circuit for $1.5\ \text{mA}$. Hence, the value of the current limiting resistor R_Z is $(12\ \text{V} - 5\ \text{V}) / 1.5\ \text{mA} = 4.7\ \text{k}\Omega$. The worst-case power dissipation across the Zener diode is $(5\ \text{V} \times 1.5\ \text{mA}) = 7.5\ \text{mW}$. Any standard Zener diode can be used with this power rating.

Choose a negative temperature coefficient (NTC) thermistor with nominal resistance of $10\ \text{k}\Omega$ at 25°C . At the foldback point of 30°C , the resistance of the NTC, R_{NTC} is approximately $7\ \text{k}\Omega$. At 105°C , the resistance of the NTC is approximately $800\ \Omega$. Choose the value of R after simulating the linearity plot along with the correct NTC part number. For the sake of calculation, take R as $5\ \text{k}\Omega$. In this case, V_{FB} is $2.08\ \text{V}$ at 25°C ($R_{\text{NTC}} = 7\ \text{k}\Omega$). For 10-bit resolution and a full-scale output of $5\ \text{V}$, $2.08\ \text{V}$ corresponds to the DAC code $(2.08 \times 1024 / 5) = 426$. Similarly, the LED must be cut off at 105°C , which refers to an R_{NTC} of $800\ \Omega$ and a corresponding V_{FB} of $4.31\ \text{V}$, or the DAC code 883. Thus, the margin-high value is 883, or $0x373$, and the margin-low value is 426, or $0x1AA$.

Configure the FUNC_CONFIG bits to 00b in the GENERAL_CONFIG register to select triangular waveform. Use [方程式 5](#) for calculating the frequency of the triangular waveform. By choosing a CODE_STEP of 6 LSB and SLEW_RATE of $(25.6 \mu\text{s} \times 1.25)$, the frequency of the triangular waveform is 205 Hz.

For voltage output, use an RC filter as shown in [图 8-4](#). The resistor divider comprised of R1, R2, and R3 define the voltage below the foldback temperature. This voltage divider is useful in case the maximum LED current is set below the 100% value.

8.2.2.3 Application Curves



图 8-5. LED Thermal Foldback

8.3 Power Supply Recommendations

The DACx3701-Q1 family of devices does not require specific supply sequencing. These devices require a single power supply, V_{DD} . Use a $0.1\text{-}\mu\text{F}$ decoupling capacitor for the V_{DD} pin. Use a bypass capacitor with a value approximately $1.5 \mu\text{F}$ for the CAP pin.

8.4 Layout

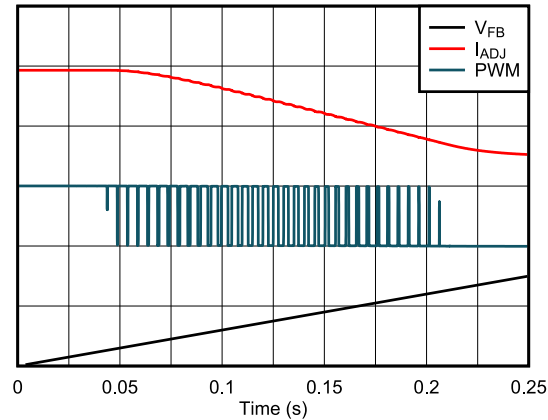
8.4.1 Layout Guidelines

The DACx3701-Q1 pin configuration separates the analog, digital, and power pins for an optimized layout. For signal integrity, separate the digital and analog traces, and place decoupling capacitors close to the device pins.

8.4.2 Layout Example

[图 8-6](#) shows an example layout drawing with decoupling capacitors and pullup resistors.



图 8-6. Layout Example

9 Device and Documentation Support

9.1 Documentation Support

9.1.1 Related Documentation

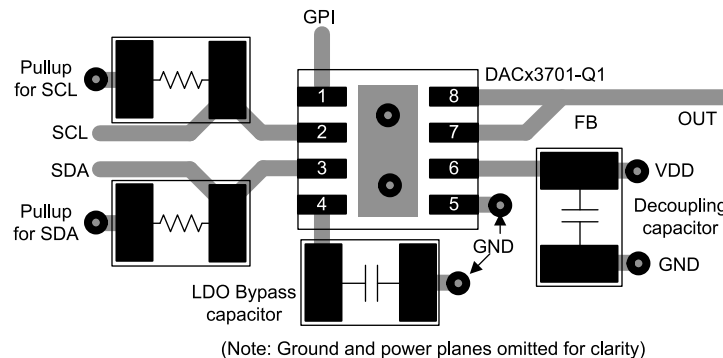
For related documentation see the following:

Texas, Instruments [DAC53701EVM user's guide](#)

9.2 接收文档更新通知

要接收文档更新通知，请导航至 [ti.com](https://www.ti.com) 上的器件产品文件夹。点击 [订阅更新](#) 进行注册，即可每周接收产品信息更改摘要。有关更改的详细信息，请查看任何已修订文档中包含的修订历史记录。

9.3 支持资源

[TI E2E™ 支持论坛](#) 是工程师的重要参考资料，可直接从专家获得快速、经过验证的解答和设计帮助。搜索现有解答或提出自己的问题可获得所需的快速设计帮助。

链接的内容由各个贡献者“按原样”提供。这些内容并不构成 TI 技术规范，并且不一定反映 TI 的观点；请参阅 TI 的 [《使用条款》](#)。

9.4 Trademarks

PMBus™ is a trademark of SMIF, Inc.

TI E2E™ is a trademark of Texas Instruments.

所有商标均为其各自所有者的财产。

9.5 静电放电警告



静电放电 (ESD) 会损坏这个集成电路。德州仪器 (TI) 建议通过适当的预防措施处理所有集成电路。如果不遵守正确的处理和安装程序，可能会损坏集成电路。

ESD 的损坏小至导致微小的性能降级，大至整个器件故障。精密的集成电路可能更容易受到损坏，这是因为非常细微的参数更改都可能会导致器件与其发布的规格不相符。

9.6 术语表

[TI 术语表](#) 本术语表列出并解释了术语、首字母缩略词和定义。

10 Mechanical, Packaging, and Orderable Information

The following pages include mechanical, packaging, and orderable information. This information is the most current data available for the designated devices. This data is subject to change without notice and revision of this document. For browser-based versions of this data sheet, refer to the left-hand navigation.

PACKAGING INFORMATION

Orderable part number	Status (1)	Material type (2)	Package Pins	Package qty Carrier	RoHS (3)	Lead finish/ Ball material (4)	MSL rating/ Peak reflow (5)	Op temp (°C)	Part marking (6)
DAC43701DSGRQ1	Active	Production	WSON (DSG) 8	3000 LARGE T&R	Yes	NIPDAU	Level-2-260C-1 YEAR	-40 to 125	47Q1
DAC53701DSGRQ1	Active	Production	WSON (DSG) 8	3000 LARGE T&R	Yes	NIPDAU	Level-2-260C-1 YEAR	-40 to 125	57Q1

(1) **Status:** For more details on status, see our [product life cycle](#).

(2) **Material type:** When designated, preproduction parts are prototypes/experimental devices, and are not yet approved or released for full production. Testing and final process, including without limitation quality assurance, reliability performance testing, and/or process qualification, may not yet be complete, and this item is subject to further changes or possible discontinuation. If available for ordering, purchases will be subject to an additional waiver at checkout, and are intended for early internal evaluation purposes only. These items are sold without warranties of any kind.

(3) **RoHS values:** Yes, No, RoHS Exempt. See the [TI RoHS Statement](#) for additional information and value definition.

(4) **Lead finish/Ball material:** Parts may have multiple material finish options. Finish options are separated by a vertical ruled line. Lead finish/Ball material values may wrap to two lines if the finish value exceeds the maximum column width.

(5) **MSL rating/Peak reflow:** The moisture sensitivity level ratings and peak solder (reflow) temperatures. In the event that a part has multiple moisture sensitivity ratings, only the lowest level per JEDEC standards is shown. Refer to the shipping label for the actual reflow temperature that will be used to mount the part to the printed circuit board.

(6) **Part marking:** There may be an additional marking, which relates to the logo, the lot trace code information, or the environmental category of the part.

Multiple part markings will be inside parentheses. Only one part marking contained in parentheses and separated by a "~" will appear on a part. If a line is indented then it is a continuation of the previous line and the two combined represent the entire part marking for that device.

Important Information and Disclaimer:The information provided on this page represents TI's knowledge and belief as of the date that it is provided. TI bases its knowledge and belief on information provided by third parties, and makes no representation or warranty as to the accuracy of such information. Efforts are underway to better integrate information from third parties. TI has taken and continues to take reasonable steps to provide representative and accurate information but may not have conducted destructive testing or chemical analysis on incoming materials and chemicals. TI and TI suppliers consider certain information to be proprietary, and thus CAS numbers and other limited information may not be available for release.

In no event shall TI's liability arising out of such information exceed the total purchase price of the TI part(s) at issue in this document sold by TI to Customer on an annual basis.

OTHER QUALIFIED VERSIONS OF DAC43701-Q1, DAC53701-Q1 :

- Catalog : [DAC43701](#), [DAC53701](#)

NOTE: Qualified Version Definitions:

- Catalog - TI's standard catalog product

GENERIC PACKAGE VIEW

DSG 8

WSON - 0.8 mm max height

2 x 2, 0.5 mm pitch

PLASTIC SMALL OUTLINE - NO LEAD

This image is a representation of the package family, actual package may vary.
Refer to the product data sheet for package details.



4224783/A

DSG0008A



PACKAGE OUTLINE

WSON - 0.8 mm max height

PLASTIC SMALL OUTLINE - NO LEAD

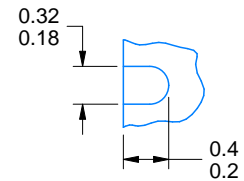
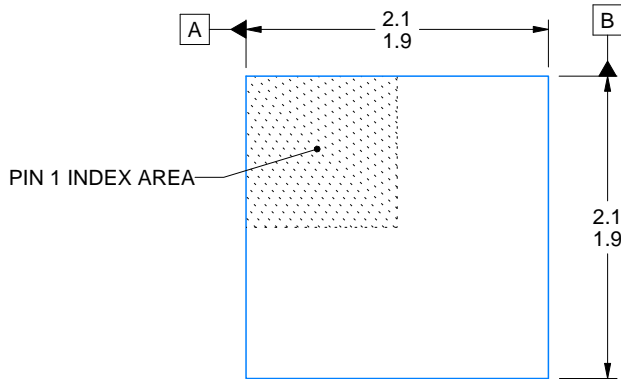

ALTERNATIVE TERMINAL SHAPE TYPICAL

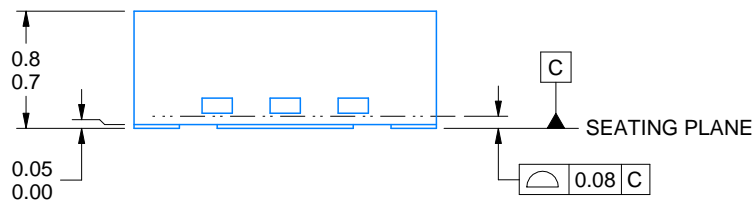

SIDE WALL METAL THICKNESS DIM A	
OPTION 1	OPTION 2
0.1	0.2

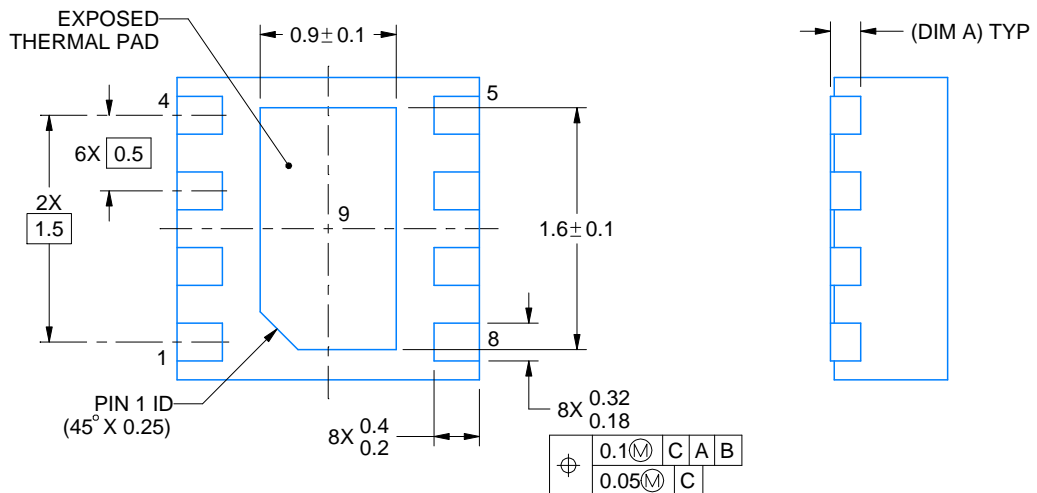

4218900/E 08/2022

NOTES:

1. All linear dimensions are in millimeters. Any dimensions in parenthesis are for reference only. Dimensioning and tolerancing per ASME Y14.5M.
2. This drawing is subject to change without notice.
3. The package thermal pad must be soldered to the printed circuit board for thermal and mechanical performance.

EXAMPLE BOARD LAYOUT

DSG0008A

WSON - 0.8 mm max height

PLASTIC SMALL OUTLINE - NO LEAD

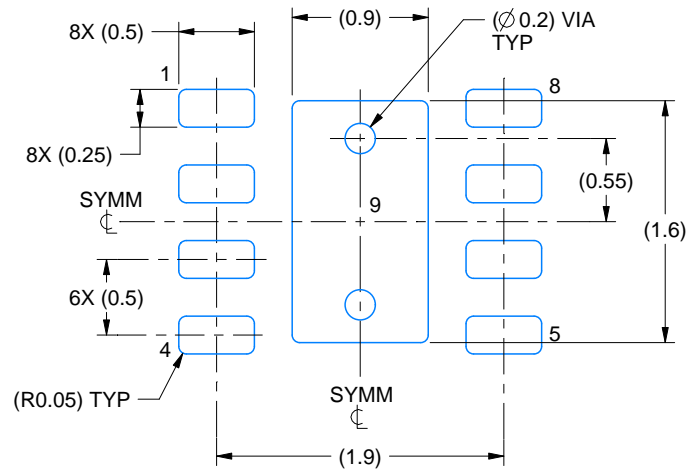

LAND PATTERN EXAMPLE
SCALE:20X

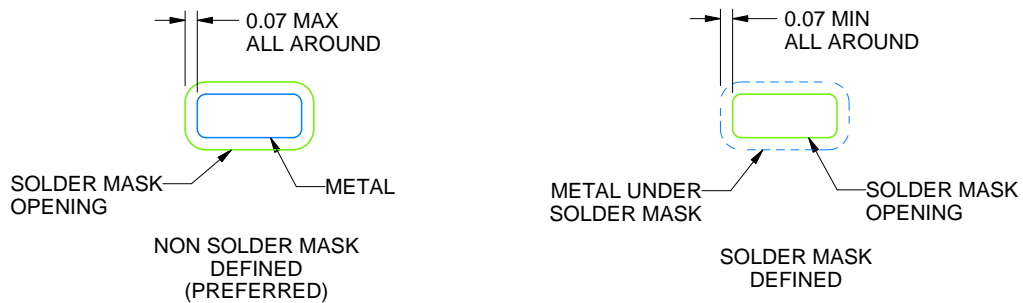

SOLDER MASK DETAILS

4218900/E 08/2022

NOTES: (continued)

4. This package is designed to be soldered to a thermal pad on the board. For more information, see Texas Instruments literature number SLUA271 (www.ti.com/lit/slua271).
5. Vias are optional depending on application, refer to device data sheet. If any vias are implemented, refer to their locations shown on this view. It is recommended that vias under paste be filled, plugged or tented.

重要通知和免责声明

TI“按原样”提供技术和可靠性数据（包括数据表）、设计资源（包括参考设计）、应用或其他设计建议、网络工具、安全信息和其他资源，不保证没有瑕疵且不做任何明示或暗示的担保，包括但不限于对适销性、某特定用途方面的适用性或不侵犯任何第三方知识产权的暗示担保。

这些资源可供使用 TI 产品进行设计的熟练开发人员使用。您将自行承担以下全部责任：(1) 针对您的应用选择合适的 TI 产品，(2) 设计、验证并测试您的应用，(3) 确保您的应用满足相应标准以及任何其他功能安全、信息安全、监管或其他要求。

这些资源如有变更，恕不另行通知。TI 授权您仅可将这些资源用于研发本资源所述的 TI 产品的相关应用。严禁以其他方式对这些资源进行复制或展示。您无权使用任何其他 TI 知识产权或任何第三方知识产权。您应全额赔偿因在这些资源的使用中对 TI 及其代表造成的任何索赔、损害、成本、损失和债务，TI 对此概不负责。

TI 提供的产品受 [TI 的销售条款](#) 或 [ti.com](#) 上其他适用条款/TI 产品随附的其他适用条款的约束。TI 提供这些资源并不会扩展或以其他方式更改 TI 针对 TI 产品发布的适用的担保或担保免责声明。

TI 反对并拒绝您可能提出的任何其他或不同的条款。

邮寄地址：Texas Instruments, Post Office Box 655303, Dallas, Texas 75265
版权所有 © 2025，德州仪器 (TI) 公司