

CY54FCT574T, CY74FCT574T 8-BIT REGISTERS WITH 3-STATE OUTPUTS

SCCS073 – OCTOBER 2001

- Function, Pinout, and Drive Compatible With FCT and F Logic
- Reduced V_{OH} (Typically = 3.3 V) Versions of Equivalent FCT Functions
- Edge-Rate Control Circuitry for Significantly Improved Noise Characteristics
- I_{off} Supports Partial-Power-Down Mode Operation
- Matched Rise and Fall Times
- Fully Compatible With TTL Input and Output Logic Levels
- ESD Protection Exceeds JESD 22
 - 2000-V Human-Body Model (A114-A)
 - 200-V Machine Model (A115-A)
 - 1000-V Charged-Device Model (C101)
- Edge-Triggered D-Type Inputs
- 250-MHz Typical Switching Rate
- CY54FCT574T
 - 32-mA Output Sink Current
 - 12-mA Output Source Current
- CY74FCT574T
 - 64-mA Output Sink Current
 - 32-mA Output Source Current
- 3-State Outputs

CY54FCT574T . . . D PACKAGE
CY74FCT574T . . . Q OR SO PACKAGE
(TOP VIEW)

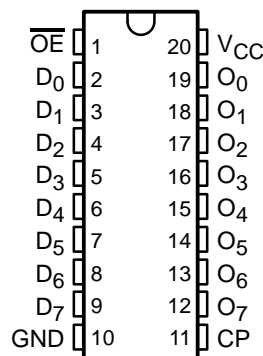

CY54FCT574T . . . L PACKAGE
(TOP VIEW)

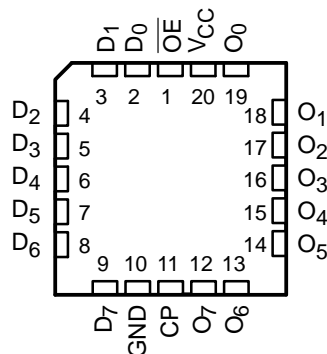

description

The 'FCT574T devices are high-speed, low-power, octal D-type flip-flops, featuring separate D-type inputs for each flip-flop. These devices have 3-state outputs for bus-oriented applications. A buffered clock (CP) and output-enable (\overline{OE}) inputs are common to all flip-flops. The 'FCT574T are identical to 'FCT374T, except for a flow-through pinout to simplify board design. The eight flip-flops in the 'FCT574T store the state of their individual D inputs that meet the setup-time and hold-time requirements on the low-to-high CP transition. When \overline{OE} is low, the contents of the eight flip-flops are available at the outputs. When \overline{OE} is high, the outputs are in the high-impedance state. The state of \overline{OE} does not affect the state of the flip-flops.

These devices are fully specified for partial-power-down applications using I_{off} . The I_{off} circuitry disables the outputs, preventing damaging current backflow through the device when it is powered down.



Please be aware that an important notice concerning availability, standard warranty, and use in critical applications of Texas Instruments semiconductor products and disclaimers thereto appears at the end of this data sheet.

PRODUCTION DATA information is current as of publication date. Products conform to specifications per the terms of Texas Instruments standard warranty. Production processing does not necessarily include testing of all parameters.

 **TEXAS
INSTRUMENTS**

POST OFFICE BOX 655303 • DALLAS, TEXAS 75265

Copyright © 2001, Texas Instruments Incorporated
On products compliant to MIL-PRF-38535, all parameters are tested unless otherwise noted. On all other products, production processing does not necessarily include testing of all parameters.

CY54FCT574T, CY74FCT574T
8-BIT REGISTERS
WITH 3-STATE OUTPUTS

SCCS073 – OCTOBER 2001

ORDERING INFORMATION

TA	PACKAGE†		SPEED (ns)	ORDERABLE PART NUMBER	TOP-SIDE MARKING	
-40°C to 85°C	QSOP – Q	Tape and reel	5.2	CY74FCT574CTQCT	FCT574C	
	SOIC – SO	Tube	5.2	CY74FCT574CTSOC	FCT574C	
		Tape and reel	5.2	CY74FCT574CTSOCT		
	QSOP – Q	Tape and reel	6.5	CY74FCT574ATQCT	FCT574A	
	SOIC – SO	Tube	6.5	CY74FCT574ATSOC	FCT574A	
		Tape and reel	6.5	CY74FCT574ATSOCT		
	-55°C to 125°C	QSOP – Q	Tape and reel	10	CY74FCT574TQCT	FCT574
		SOIC – SO	Tube	10	CY74FCT574TSOC	FCT574
Tape and reel			10	CY74FCT574TSOCT		
CDIP – D		Tube	6.2	CY54FCT574CTDMB		
CDIP – D	Tube	7.2	CY54FCT574ATDMB			
LCC – L	Tube	7.2	CY54FCT574ATLMB			

† Package drawings, standard packing quantities, thermal data, symbolization, and PCB design guidelines are available at www.ti.com/sc/package.

FUNCTION TABLE

INPUTS			OUTPUT
D	CP	\overline{OE}	O
H	↑	L	H
L	↑	L	L
X	X	H	Z

H = High logic level, L = Low logic level,
X = Don't care, Z = High-impedance state,
↑ = Low-to-high clock transition

logic diagram (positive logic)



absolute maximum ratings over operating free-air temperature range (unless otherwise noted)†

Supply voltage range to ground potential	–0.5 V to 7 V
DC input voltage range	–0.5 V to 7 V
DC output voltage range	–0.5 V to 7 V
DC output current (maximum sink current/pin)	120 mA
Package thermal impedance, θ_{JA} (see Note 1): Q package	68°C/W
SO package	58°C/W
Ambient temperature range with power applied, T_A	–65°C to 135°C
Storage temperature range, T_{stg}	–65°C to 150°C

† Stresses beyond those listed under “absolute maximum ratings” may cause permanent damage to the device. These are stress ratings only, and functional operation of the device at these or any other conditions beyond those indicated under “recommended operating conditions” is not implied. Exposure to absolute-maximum-rated conditions for extended periods may affect device reliability.

NOTE 1: The package thermal impedance is calculated in accordance with JESD 51-7.

recommended operating conditions (see Note 2)

	CY54FCT574T			CY74FCT574T			UNIT
	MIN	NOM	MAX	MIN	NOM	MAX	
V_{CC} Supply voltage	4.5	5	5.5	4.75	5	5.25	V
V_{IH} High-level input voltage	2			2			V
V_{IL} Low-level input voltage	0.8			0.8			V
I_{OH} High-level output current	–12			–32			mA
I_{OL} Low-level output current	32			64			mA
T_A Operating free-air temperature	–55		125	–40		85	°C

NOTE 2: All unused inputs of the device must be held at V_{CC} or GND to ensure proper device operation.

CY54FCT574T, CY74FCT574T
8-BIT REGISTERS
WITH 3-STATE OUTPUTS

SCCS073 – OCTOBER 2001

electrical characteristics over recommended operating free-air temperature range (unless otherwise noted)

PARAMETER	TEST CONDITIONS	CY54FCT574T			CY74FCT574T			UNIT
		MIN	TYP†	MAX	MIN	TYP†	MAX	
V _{IK}	V _{CC} = 4.5 V, I _{IN} = -18 mA		-0.7	-1.2				V
	V _{CC} = 4.75 V, I _{IN} = -18 mA					-0.7	-1.2	
V _{OH}	V _{CC} = 4.5 V, I _{OH} = -12 mA	2.4	3.3					V
	V _{CC} = 4.75 V	I _{OH} = -32 mA			2			
		I _{OH} = -15 mA				2.4	3.3	
V _{OL}	V _{CC} = 4.5 V, I _{OL} = 32 mA		0.3	0.55				V
	V _{CC} = 4.75 V, I _{OL} = 64 mA					0.3	0.55	
V _{hys}	All inputs		0.2			0.2		V
I _I	V _{CC} = 5.5 V, V _{IN} = V _{CC}			5				μA
	V _{CC} = 5.25 V, V _{IN} = V _{CC}						5	
I _{IH}	V _{CC} = 5.5 V, V _{IN} = 2.7 V			±1				μA
	V _{CC} = 5.25 V, V _{IN} = 2.7 V						±1	
I _{IL}	V _{CC} = 5.5 V, V _{IN} = 0.5 V			±1				μA
	V _{CC} = 5.25 V, V _{IN} = 0.5 V						±1	
I _{off}	V _{CC} = 0 V, V _{OUT} = 4.5 V			±1			±1	μA
I _{OS} ‡	V _{CC} = 5.5 V, V _{OUT} = 0 V	-60	-120	-225				mA
	V _{CC} = 5.25 V, V _{OUT} = 0 V				-60	-120	-225	
I _{OZH}	V _{CC} = 5.5 V, V _{IN} = 2.7 V			10				μA
	V _{CC} = 5.25 V, V _{IN} = 2.7 V						10	
I _{OZL}	V _{CC} = 5.5 V, V _{IN} = 0.5 V			-10				μA
	V _{CC} = 5.25 V, V _{IN} = 0.5 V						-10	
I _{CC}	V _{CC} = 5.5 V, V _{IN} ≤ 0.2 V, V _{IN} ≥ V _{CC} - 0.2 V		0.1	0.2				mA
	V _{CC} = 5.25 V, V _{IN} ≤ 0.2 V, V _{IN} ≥ V _{CC} - 0.2 V					0.1	0.2	
ΔI _{CC}	V _{CC} = 5.5 V, V _{IN} = 3.4 V§, f ₁ = 0, Outputs open		0.5	2				mA
	V _{CC} = 5.25 V, V _{IN} = 3.4 V§, f ₁ = 0, Outputs open					0.5	2	

† Typical values are at V_{CC} = 5 V, T_A = 25°C.

‡ Not more than one output should be shorted at a time. Duration of short should not exceed one second. The use of high-speed test apparatus and/or sample-and-hold techniques are preferable to minimize internal chip heating and more accurately reflect operational values. Otherwise, prolonged shorting of a high output can raise the chip temperature well above normal and cause invalid readings in other parametric tests. In any sequence of parameter tests, I_{OS} tests should be performed last.

§ Per TTL-driven input (V_{IN} = 3.4 V); all other inputs at V_{CC} or GND



electrical characteristics over recommended operating free-air temperature range (unless otherwise noted) (continued)

PARAMETER	TEST CONDITIONS		CY54FCT574T		CY74FCT574T		UNIT	
			MIN	TYP†	MAX	MIN		TYP†
I_{CCD}^{\ddagger}	$V_{CC} = 5.5\text{ V}$, Outputs open, One bit switching at 50% duty cycle, $\overline{OE} = \text{GND}$, $V_{IN} \leq 0.2\text{ V}$ or $V_{IN} \geq V_{CC} - 0.2\text{ V}$		0.06	0.12			mA/ MHz	
	$V_{CC} = 5.25\text{ V}$, Outputs open, One bit switching at 50% duty cycle, $\overline{OE} = \text{GND}$, $V_{IN} \leq 0.2\text{ V}$ or $V_{IN} \geq V_{CC} - 0.2\text{ V}$				0.06	0.12		
I_C	$V_{CC} = 5.5\text{ V}$, $f_0 = 10\text{ MHz}$, Outputs open, $\overline{OE} = \text{GND}$	One bit switching at $f_1 = 5\text{ MHz}$ at 50% duty cycle	$V_{IN} \leq 0.2\text{ V}$ or $V_{IN} \geq V_{CC} - 0.2\text{ V}$	0.7	1.4		mA	
			$V_{IN} = 3.4\text{ V}$ or GND	1.2	3.4			
		Eight bits switching at $f_1 = 2.5\text{ MHz}$ at 50% duty cycle	$V_{IN} \leq 0.2\text{ V}$ or $V_{IN} \geq V_{CC} - 0.2\text{ V}$	1.6	3.2			
			$V_{IN} = 3.4\text{ V}$ or GND	3.9	12.2			
	$V_{CC} = 5.25\text{ V}$, $f_0 = 10\text{ MHz}$, Outputs open, $\overline{OE} = \text{GND}$	One bit switching at $f_1 = 5\text{ MHz}$ at 50% duty cycle	$V_{IN} \leq 0.2\text{ V}$ or $V_{IN} \geq V_{CC} - 0.2\text{ V}$			0.7		1.4
			$V_{IN} = 3.4\text{ V}$ or GND			1.2		3.4
		Eight bits switching at $f_1 = 2.5\text{ MHz}$ at 50% duty cycle	$V_{IN} \leq 0.2\text{ V}$ or $V_{IN} \geq V_{CC} - 0.2\text{ V}$			1.6		3.2
			$V_{IN} = 3.4\text{ V}$ or GND			3.9		12.2
C_i			5	10	5	10	pF	
C_o			9	12	9	12	pF	

† Typical values are at $V_{CC} = 5\text{ V}$, $T_A = 25^\circ\text{C}$.

‡ This parameter is derived for use in total power-supply calculations.

$I_C = I_{CC} + \Delta I_{CC} \times D_H \times N_T + I_{CCD} (f_0/2 + f_1 \times N_1)$

Where:

I_C = Total supply current

I_{CC} = Power-supply current with CMOS input levels

ΔI_{CC} = Power-supply current for a TTL high input ($V_{IN} = 3.4\text{ V}$)

D_H = Duty cycle for TTL inputs high

N_T = Number of TTL inputs at D_H

I_{CCD} = Dynamic current caused by an input transition pair (HLH or LHL)

f_0 = Clock frequency for registered devices, otherwise zero

f_1 = Input signal frequency

N_1 = Number of inputs changing at f_1

All currents are in milliamperes and all frequencies are in megahertz.

|| Values for these conditions are examples of the I_{CC} formula.

CY54FCT574T, CY74FCT574T

8-BIT REGISTERS

WITH 3-STATE OUTPUTS

SCCS073 – OCTOBER 2001

timing requirements over recommended operating free-air temperature range (unless otherwise noted) (see Figure 1)

		CY54FCT574T		CY54FCT574AT		CY54FCT574CT		UNIT
		MIN	MAX	MIN	MAX	MIN	MAX	
t _w	Pulse duration, CP high or low	7		6		6		ns
t _{su}	Setup time, data before CP↑	2		2		2		ns
t _h	Hold time, data after CP↑	1.5		1.5		1.5		ns

timing requirements over recommended operating free-air temperature range (unless otherwise noted) (see Figure 1)

		CY74FCT574T		CY74FCT574AT		CY74FCT574CT		UNIT
		MIN	MAX	MIN	MAX	MIN	MAX	
t _w	Pulse duration, CP high or low	7		5		5		ns
t _{su}	Setup time, data before CP↑	2		2		2		ns
t _h	Hold time, data after CP↑	1.5		1.5		1.5		ns

switching characteristics over operating free-air temperature range (see Figure 1)

PARAMETER	FROM (INPUT)	TO (OUTPUT)	CY54FCT574T		CY54FCT574AT		CY54FCT574CT		UNIT
			MIN	MAX	MIN	MAX	MIN	MAX	
t _{PLH}	CP	O	2	11	2	7.2	2	6.2	ns
t _{PHL}			2	11	2	7.2	2	6.2	
t _{PZH}	\overline{OE}	O	1.5	14	1.5	7.5	1.5	6.2	ns
t _{PZL}			1.5	14	1.5	7.5	1.5	6.2	
t _{PHZ}	\overline{OE}	O	1.5	8	1.5	6.5	1.5	5.7	ns
t _{PLZ}			1.5	8	1.5	6.5	1.5	5.7	

switching characteristics over operating free-air temperature range (see Figure 1)

PARAMETER	FROM (INPUT)	TO (OUTPUT)	CY74FCT574T		CY74FCT574AT		CY74FCT574CT		UNIT
			MIN	MAX	MIN	MAX	MIN	MAX	
t _{PLH}	CP	O	2	10	2	6.5	2	5.2	ns
t _{PHL}			2	10	2	6.5	2	5.2	
t _{PZH}	\overline{OE}	O	1.5	12.5	1.5	6.5	1.5	5.5	ns
t _{PZL}			1.5	12.5	1.5	6.5	1.5	5.5	
t _{PHZ}	\overline{OE}	O	1.5	8	1.5	5.5	1.5	5	ns
t _{PLZ}			1.5	8	1.5	5.5	1.5	5	



PARAMETER MEASUREMENT INFORMATION

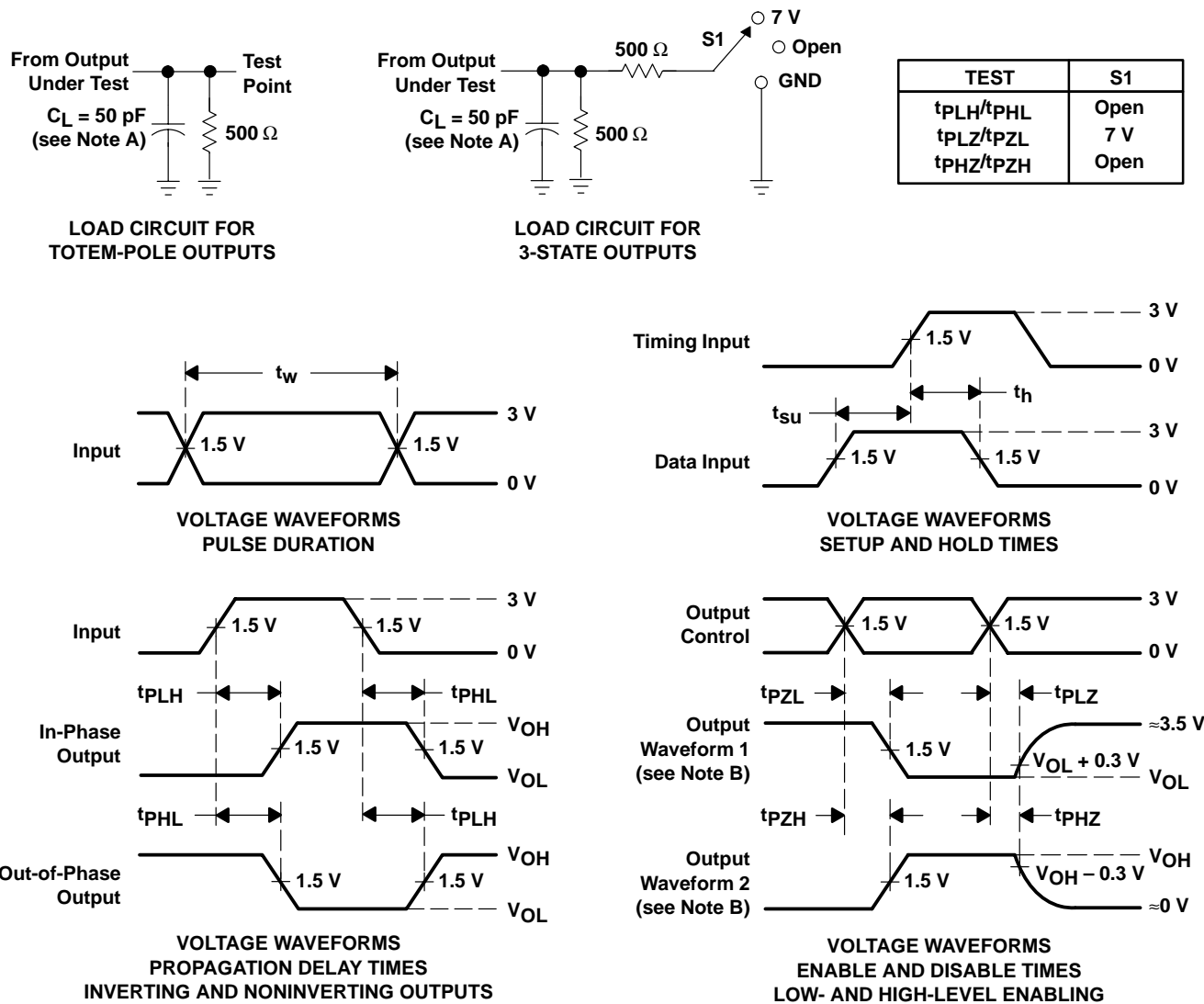

- NOTES: A. C_L includes probe and jig capacitance.
 B. Waveform 1 is for an output with internal conditions such that the output is low except when disabled by the output control. Waveform 2 is for an output with internal conditions such that the output is high except when disabled by the output control.
 C. The outputs are measured one at a time with one input transition per measurement.

Figure 1. Load Circuit and Voltage Waveforms

PACKAGING INFORMATION

Orderable Device	Status (1)	Package Type	Package Drawing	Pins	Package Qty	Eco Plan (2)	Lead finish/ Ball material (6)	MSL Peak Temp (3)	Op Temp (°C)	Device Marking (4/5)	Samples
5962-9222203M2A	ACTIVE	LCCC	FK	20	55	Non-RoHS & Green	SNPB	N / A for Pkg Type	-55 to 125	5962-9222203M2A CY54FCT 574ATLMB	Samples
5962-9222203MRA	ACTIVE	CDIP	J	20	20	Non-RoHS & Non-Green	SNPB	N / A for Pkg Type	-55 to 125	5962-9222203MRA	Samples
5962-9222205MRA	ACTIVE	CDIP	J	20	20	Non-RoHS & Green	SNPB	N / A for Pkg Type	-55 to 125	5962-9222205MRA	Samples
CY54FCT574ATLMB	ACTIVE	LCCC	FK	20	55	Non-RoHS & Green	SNPB	N / A for Pkg Type	-55 to 125	5962-9222203M2A CY54FCT 574ATLMB	Samples
CY74FCT574ATQCT	ACTIVE	SSOP	DBQ	20	2500	RoHS & Green	NIPDAU	Level-2-260C-1 YEAR	-40 to 85	FCT574A	Samples
CY74FCT574ATSOC	ACTIVE	SOIC	DW	20	25	RoHS & Green	NIPDAU	Level-1-260C-UNLIM	-40 to 85	FCT574A	Samples
CY74FCT574CTQCT	ACTIVE	SSOP	DBQ	20	2500	RoHS & Green	NIPDAU	Level-2-260C-1 YEAR	-40 to 85	FCT574C	Samples
CY74FCT574CTSOC	ACTIVE	SOIC	DW	20	25	RoHS & Green	NIPDAU	Level-1-260C-UNLIM	-40 to 85	FCT574C	Samples
CY74FCT574TQCT	ACTIVE	SSOP	DBQ	20	2500	RoHS & Green	NIPDAU	Level-2-260C-1 YEAR	-40 to 85	FCT574	Samples
CY74FCT574TSOC	ACTIVE	SOIC	DW	20	25	RoHS & Green	NIPDAU	Level-1-260C-UNLIM	-40 to 85	FCT574	Samples

(1) The marketing status values are defined as follows:

ACTIVE: Product device recommended for new designs.

LIFEBUY: TI has announced that the device will be discontinued, and a lifetime-buy period is in effect.

NRND: Not recommended for new designs. Device is in production to support existing customers, but TI does not recommend using this part in a new design.

PREVIEW: Device has been announced but is not in production. Samples may or may not be available.

OBSELETE: TI has discontinued the production of the device.

(2) **RoHS:** TI defines "RoHS" to mean semiconductor products that are compliant with the current EU RoHS requirements for all 10 RoHS substances, including the requirement that RoHS substance do not exceed 0.1% by weight in homogeneous materials. Where designed to be soldered at high temperatures, "RoHS" products are suitable for use in specified lead-free processes. TI may reference these types of products as "Pb-Free".

RoHS Exempt: TI defines "RoHS Exempt" to mean products that contain lead but are compliant with EU RoHS pursuant to a specific EU RoHS exemption.

Green: TI defines "Green" to mean the content of Chlorine (Cl) and Bromine (Br) based flame retardants meet JS709B low halogen requirements of <=1000ppm threshold. Antimony trioxide based flame retardants must also meet the <=1000ppm threshold requirement.

- (3) MSL, Peak Temp. - The Moisture Sensitivity Level rating according to the JEDEC industry standard classifications, and peak solder temperature.
- (4) There may be additional marking, which relates to the logo, the lot trace code information, or the environmental category on the device.
- (5) Multiple Device Markings will be inside parentheses. Only one Device Marking contained in parentheses and separated by a "~" will appear on a device. If a line is indented then it is a continuation of the previous line and the two combined represent the entire Device Marking for that device.
- (6) Lead finish/Ball material - Orderable Devices may have multiple material finish options. Finish options are separated by a vertical ruled line. Lead finish/Ball material values may wrap to two lines if the finish value exceeds the maximum column width.

Important Information and Disclaimer:The information provided on this page represents TI's knowledge and belief as of the date that it is provided. TI bases its knowledge and belief on information provided by third parties, and makes no representation or warranty as to the accuracy of such information. Efforts are underway to better integrate information from third parties. TI has taken and continues to take reasonable steps to provide representative and accurate information but may not have conducted destructive testing or chemical analysis on incoming materials and chemicals. TI and TI suppliers consider certain information to be proprietary, and thus CAS numbers and other limited information may not be available for release.

In no event shall TI's liability arising out of such information exceed the total purchase price of the TI part(s) at issue in this document sold by TI to Customer on an annual basis.

TAPE AND REEL INFORMATION

QUADRANT ASSIGNMENTS FOR PIN 1 ORIENTATION IN TAPE

*All dimensions are nominal

Device	Package Type	Package Drawing	Pins	SPQ	Reel Diameter (mm)	Reel Width W1 (mm)	A0 (mm)	B0 (mm)	K0 (mm)	P1 (mm)	W (mm)	Pin1 Quadrant
CY74FCT574ATQCT	SSOP	DBQ	20	2500	330.0	16.4	6.5	9.0	2.1	8.0	16.0	Q1
CY74FCT574CTQCT	SSOP	DBQ	20	2500	330.0	16.4	6.5	9.0	2.1	8.0	16.0	Q1
CY74FCT574TQCT	SSOP	DBQ	20	2500	330.0	16.4	6.5	9.0	2.1	8.0	16.0	Q1

TAPE AND REEL BOX DIMENSIONS



*All dimensions are nominal

Device	Package Type	Package Drawing	Pins	SPQ	Length (mm)	Width (mm)	Height (mm)
CY74FCT574ATQCT	SSOP	DBQ	20	2500	356.0	356.0	35.0
CY74FCT574CTQCT	SSOP	DBQ	20	2500	356.0	356.0	35.0
CY74FCT574TQCT	SSOP	DBQ	20	2500	356.0	356.0	35.0

TUBE

*All dimensions are nominal

Device	Package Name	Package Type	Pins	SPQ	L (mm)	W (mm)	T (μm)	B (mm)
5962-9222203M2A	FK	LCCC	20	55	506.98	12.06	2030	NA
CY54FCT574ATLMB	FK	LCCC	20	55	506.98	12.06	2030	NA
CY74FCT574ATSOC	DW	SOIC	20	25	507	12.83	5080	6.6
CY74FCT574CTSOC	DW	SOIC	20	25	507	12.83	5080	6.6
CY74FCT574TSOC	DW	SOIC	20	25	507	12.83	5080	6.6

IMPORTANT NOTICE AND DISCLAIMER

TI PROVIDES TECHNICAL AND RELIABILITY DATA (INCLUDING DATA SHEETS), DESIGN RESOURCES (INCLUDING REFERENCE DESIGNS), APPLICATION OR OTHER DESIGN ADVICE, WEB TOOLS, SAFETY INFORMATION, AND OTHER RESOURCES "AS IS" AND WITH ALL FAULTS, AND DISCLAIMS ALL WARRANTIES, EXPRESS AND IMPLIED, INCLUDING WITHOUT LIMITATION ANY IMPLIED WARRANTIES OF MERCHANTABILITY, FITNESS FOR A PARTICULAR PURPOSE OR NON-INFRINGEMENT OF THIRD PARTY INTELLECTUAL PROPERTY RIGHTS.

These resources are intended for skilled developers designing with TI products. You are solely responsible for (1) selecting the appropriate TI products for your application, (2) designing, validating and testing your application, and (3) ensuring your application meets applicable standards, and any other safety, security, regulatory or other requirements.

These resources are subject to change without notice. TI grants you permission to use these resources only for development of an application that uses the TI products described in the resource. Other reproduction and display of these resources is prohibited. No license is granted to any other TI intellectual property right or to any third party intellectual property right. TI disclaims responsibility for, and you will fully indemnify TI and its representatives against, any claims, damages, costs, losses, and liabilities arising out of your use of these resources.

TI's products are provided subject to [TI's Terms of Sale](#) or other applicable terms available either on [ti.com](https://www.ti.com) or provided in conjunction with such TI products. TI's provision of these resources does not expand or otherwise alter TI's applicable warranties or warranty disclaimers for TI products.

TI objects to and rejects any additional or different terms you may have proposed.

Mailing Address: Texas Instruments, Post Office Box 655303, Dallas, Texas 75265
Copyright © 2023, Texas Instruments Incorporated