

# CSD87502Q2 30V 双路 N 沟道 NexFET™ 功率 MOSFET

## 1 特性

- 低导通电阻
- 两个独立的金属氧化物半导体场效应晶体管 (MOSFET)
- 节省空间的小外形尺寸无引线 (SON) 2mm x 2mm 塑料封装
- 针对 5V 栅极驱动器而优化
- 雪崩级
- 无铅且无卤素
- 符合 RoHS 环保标准

## 2 应用范围

- 用于网络互联、电信和计算系统的负载点同步降压转换器
- 针对笔记本个人电脑 (PC) 和平板电脑的适配器或 USB 输入保护
- 电池保护

## 3 说明

CSD87502Q2 是一款 30V、27mΩ N 沟道器件。它具有两个独立的 MOSFET，采用 2mm x 2mm SON 塑料封装。这两个场效应管 (FET) 采用半桥配置，适用于同步降压等电源应用。此外，这些 NexFET™ 功率 MOSFET 还可用于适配器、USB 输入保护和电池充电应用。两个 FET 的漏源导通电阻均较低，可最大限度地降低损耗并减少元件数，非常适合空间受限型应用。

顶视图和电路图

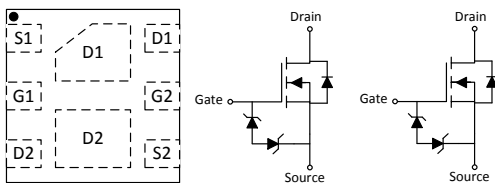

$R_{DS(on)}$  与  $V_{GS}$  间的关系

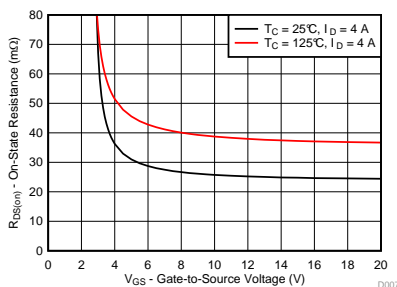

产品概要

$T_A = 25^\circ\text{C}$		典型值		单位
$V_{DS}$	漏源电压	30		V
$Q_g$	栅极电荷总量 (4.5V)	2.2		nC
$Q_{gd}$	栅极电荷 栅极到漏极	0.5		nC
$R_{DS(on)}$	漏源导通电阻	$V_{GS} = 3.8\text{V}$	42.0	mΩ
		$V_{GS} = 4.5\text{V}$	35.5	mΩ
		$V_{GS} = 10\text{V}$	27.0	mΩ
$V_{GS(th)}$	阈值电压	1.6		V

订购信息<sup>(1)</sup>

器件	包装介质	数量	封装	运输
CSD87502Q2	7 英寸卷带	3000	SON 2mm x 2mm	卷带封装
CSD87502Q2T	7 英寸卷带	250	塑料封装	

(1) 要了解所有可用封装，请见数据表末尾的可订购产品附录。

绝对最大额定值

$T_A = 25^\circ\text{C}$		值	单位
$V_{DS}$	漏源电压	30	V
$V_{GS}$	栅源电压	$\pm 20$	V
$I_D$	持续漏极电流 (受封装限制)	5.0	A
$I_{DM}$	脉冲漏极电流 <sup>(1)</sup>	23	A
$P_D$	功率耗散 <sup>(2)</sup>	2.3	W
$T_J, T_{stg}$	工作结温, 储存温度	-55 至 150	$^\circ\text{C}$
$E_{AS}$	雪崩能量, 单一脉冲 $I_D = 7.9\text{A}, L = 0.1\text{mH}, R_G = 25\Omega$	3.1	mJ

(1) 最大  $R_{\theta JA} = 185^\circ\text{C/W}$ , 脉冲持续时间  $\leq 100\mu\text{s}$ , 占空比  $\leq 1\%$ 。

(2)  $R_{\theta JA} = 55^\circ\text{C/W}$ , 这是在厚度为 0.06 英寸的环氧板 (FR4) 印刷电路板 (PCB) 上的 1 英寸<sup>2</sup> 2 盎司的铜过渡垫片上测得的典型值。

栅极电荷

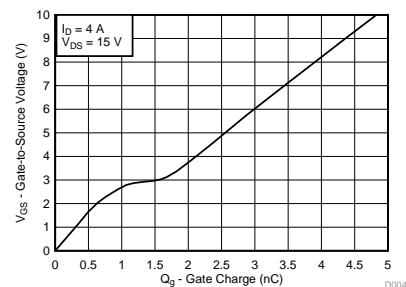

## 目录

<p><b>1</b> 特性 ..... 1</p> <p><b>2</b> 应用范围 ..... 1</p> <p><b>3</b> 说明 ..... 1</p> <p><b>4</b> 修订历史记录 ..... 2</p> <p><b>5</b> <b>Specifications</b> ..... 3</p> <p style="padding-left: 20px;">5.1 Electrical Characteristics ..... 3</p> <p style="padding-left: 20px;">5.2 Thermal Information ..... 3</p> <p style="padding-left: 20px;">5.3 Typical MOSFET Characteristics ..... 4</p> <p><b>6</b> 器件和文档支持 ..... 7</p>	<p>6.1 社区资源 ..... 7</p> <p>6.2 商标 ..... 7</p> <p>6.3 静电放电警告 ..... 7</p> <p>6.4 Glossary ..... 7</p> <p><b>7</b> <b>机械、封装和可订购信息</b> ..... 8</p> <p style="padding-left: 20px;">7.1 封装尺寸 ..... 8</p> <p style="padding-left: 20px;">7.2 印刷电路板 (PCB) 焊盘图案 ..... 9</p> <p style="padding-left: 20px;">7.3 建议模板开口 ..... 9</p> <p style="padding-left: 20px;">7.4 Q2 卷带信息 ..... 10</p>
--	--

## 4 修订历史记录

日期	修订版本	注释
2015 年 12 月	*	最初发布。

## 5 Specifications

### 5.1 Electrical Characteristics

( $T_A = 25^\circ\text{C}$  unless otherwise stated)

PARAMETER		TEST CONDITIONS	MIN	TYP	MAX	UNIT
<b>STATIC CHARACTERISTICS</b>						
$V_{DSS}$	Drain-to-source voltage	$V_{GS} = 0\text{ V}, I_D = 250\ \mu\text{A}$	30			V
$I_{DSS}$	Drain-to-source leakage current	$V_{GS} = 0\text{ V}, V_{DS} = 24\text{ V}$			1	$\mu\text{A}$
$I_{GSS}$	Gate-to-source leakage current	$V_{DS} = 0\text{ V}, V_{GS} = 20\text{ V}$			4	$\mu\text{A}$
$V_{GS(th)}$	Gate-to-source threshold voltage	$V_{DS} = V_{GS}, I_D = 250\ \mu\text{A}$	1.2	1.6	2.0	V
$R_{DS(on)}$	Drain-to-source on-resistance	$V_{GS} = 3.8\text{ V}, I_D = 4\text{ A}$		42.0	60.0	m $\Omega$
		$V_{GS} = 4.5\text{ V}, I_D = 4\text{ A}$		35.5	42.0	m $\Omega$
		$V_{GS} = 10\text{ V}, I_D = 4\text{ A}$		27.0	32.4	m $\Omega$
$g_{fs}$	Transconductance	$V_{DS} = 3\text{ V}, I_D = 4\text{ A}$		75		S
<b>DYNAMIC CHARACTERISTICS</b>						
$C_{iss}$	Input capacitance	$V_{GS} = 0\text{ V}, V_{DS} = 15\text{ V}, f = 1\text{ MHz}$		272	353	pF
$C_{oss}$	Output capacitance			42	55	pF
$C_{rss}$	Reverse transfer capacitance			22	29	pF
$R_G$	Series gate resistance			6.9		$\Omega$
$Q_g$	Gate charge total (4.5 V)	$V_{DS} = 15\text{ V}, I_D = 4\text{ A}$		2.2	2.9	nC
$Q_g$	Gate charge total (10 V)			4.6	6.0	nC
$Q_{gd}$	Gate charge gate to drain			0.5		nC
$Q_{gs}$	Gate charge gate to source			1.0		nC
$Q_{g(th)}$	Gate charge at $V_{th}$			0.5		nC
$Q_{oss}$	Output charge		$V_{DS} = 15\text{ V}, V_{GS} = 0\text{ V}$		1.4	
$t_{d(on)}$	Turn on delay time	$V_{DS} = 15\text{ V}, V_{GS} = 5\text{ V}, I_{DS} = 4\text{ A}, R_G = 0\ \Omega$		3		ns
$t_r$	Rise time			11		ns
$t_{d(off)}$	Turn off delay time			12		ns
$t_f$	Fall time			3		ns
<b>DIODE CHARACTERISTICS</b>						
$V_{SD}$	Diode forward voltage	$I_{SD} = 4\text{ A}, V_{GS} = 0\text{ V}$		0.85	1.0	V
$Q_{rr}$	Reverse recovery charge	$V_{DS} = 15\text{ V}, I_F = 4\text{ A}, di/dt = 300\text{ A}/\mu\text{s}$		4.0		nC
$t_{rr}$	Reverse recovery time			6.4		ns

### 5.2 Thermal Information

( $T_A = 25^\circ\text{C}$  unless otherwise stated)

THERMAL METRIC		MIN	TYP	MAX	UNIT
$R_{\theta JA}$	Junction-to-ambient thermal resistance <sup>(1)</sup>			70	$^\circ\text{C}/\text{W}$
	Junction-to-ambient thermal resistance <sup>(2)</sup>			185	

(1) Device mounted on FR4 material with 1 inch<sup>2</sup> (6.45 cm<sup>2</sup>), 2 oz. (0.071 mm thick) Cu.

(2) Device mounted on FR4 material with minimum Cu mounting area.

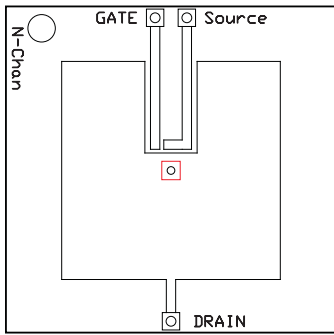

Max  $R_{\theta JA} = 70$  when mounted on 1 inch<sup>2</sup> (6.45 cm<sup>2</sup>) of 2 oz. (0.071 mm thick) Cu.

M0164-01

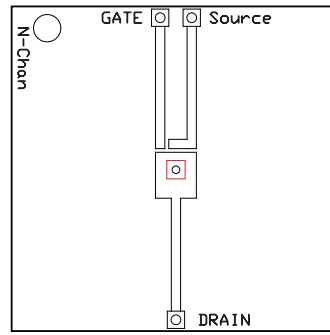

Max  $R_{\theta JA} = 185$  when mounted on minimum pad area of 2 oz. (0.071 mm thick) Cu.

M0164-02

### 5.3 Typical MOSFET Characteristics

( $T_A = 25^\circ\text{C}$  unless otherwise stated)

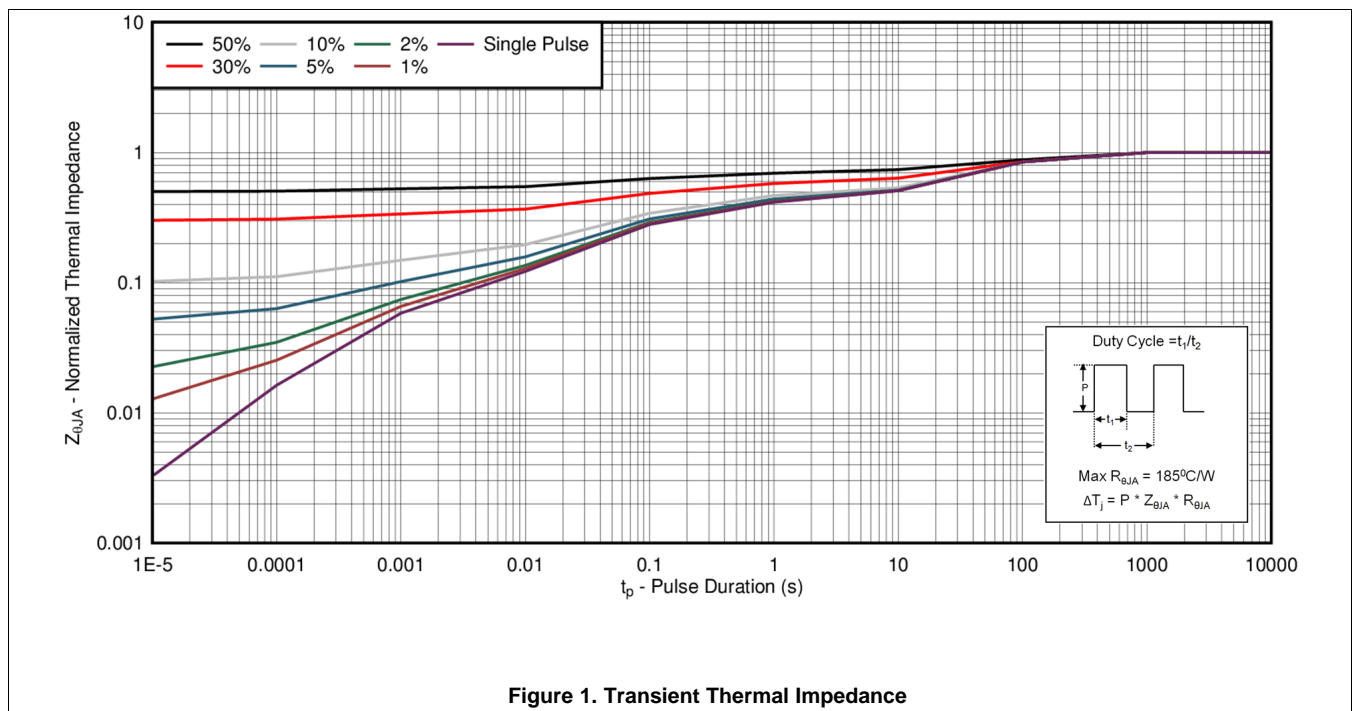

Typical MOSFET Characteristics (continued)

( $T_A = 25^\circ\text{C}$  unless otherwise stated)

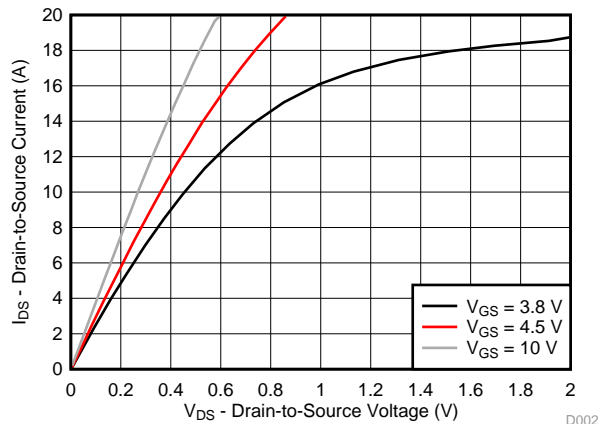

Figure 2. Saturation Characteristics

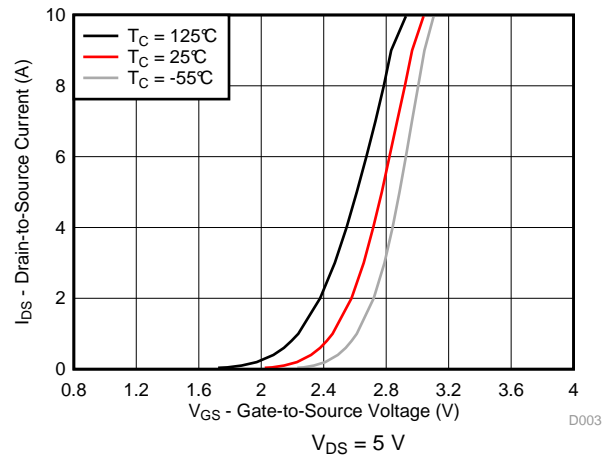

Figure 3. Transfer Characteristics

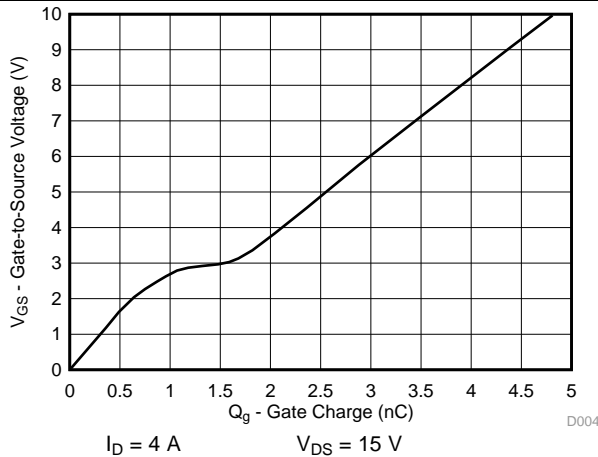

Figure 4. Gate Charge

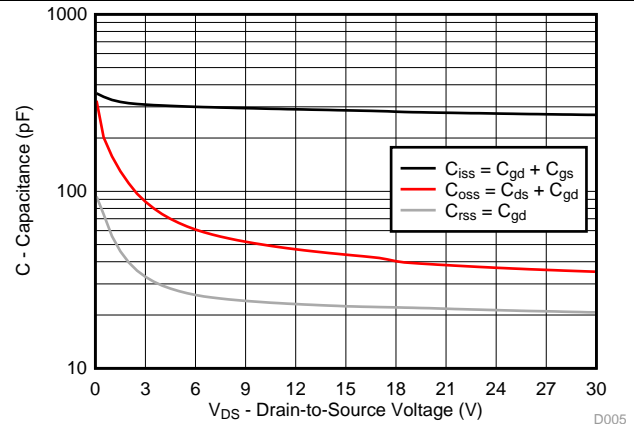

Figure 5. Capacitance

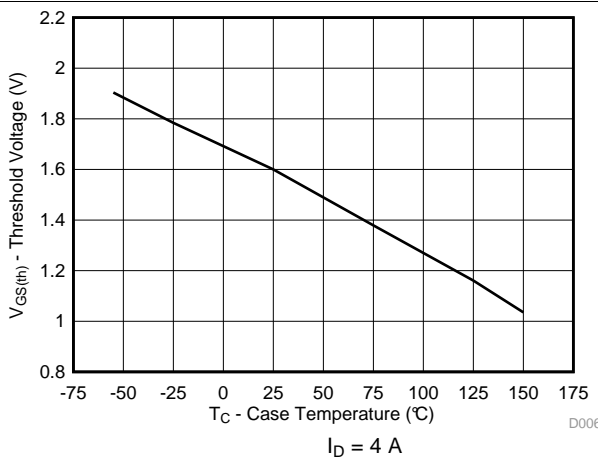

Figure 6. Threshold Voltage vs Temperature

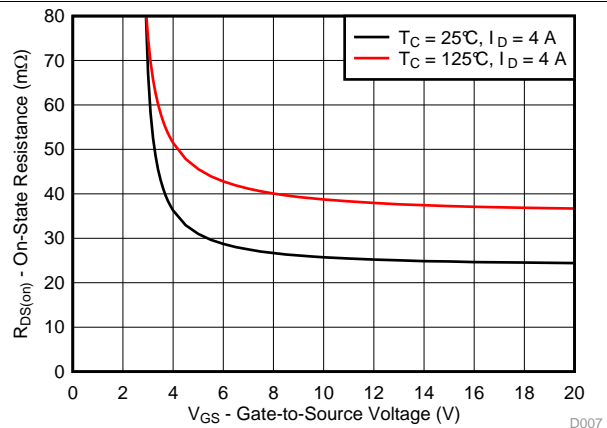

Figure 7. On-State Resistance vs Gate-to-Source Voltage

Typical MOSFET Characteristics (continued)

( $T_A = 25^\circ\text{C}$  unless otherwise stated)

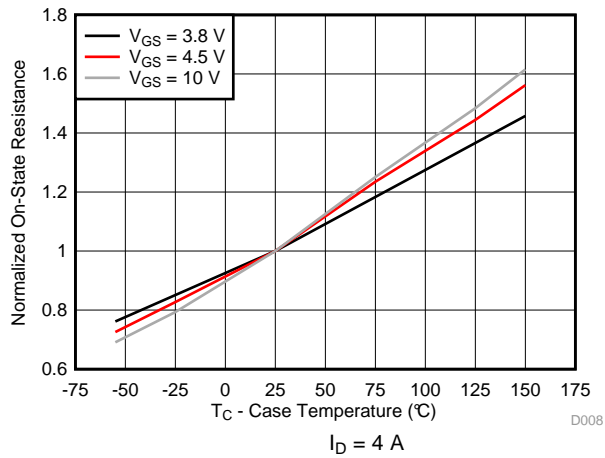

Figure 8. Normalized On-State Resistance vs Temperature

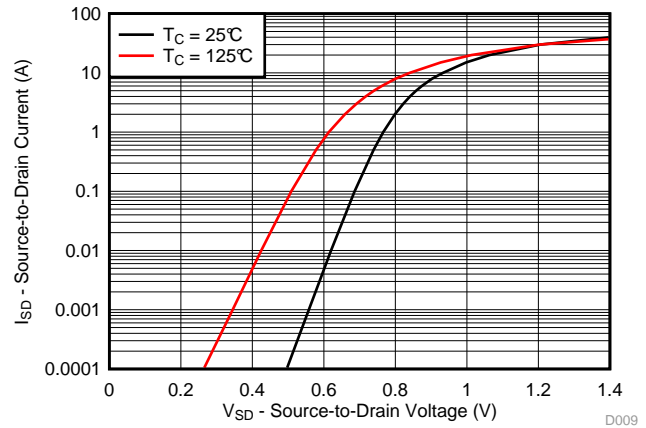

Figure 9. Typical Diode Forward Voltage

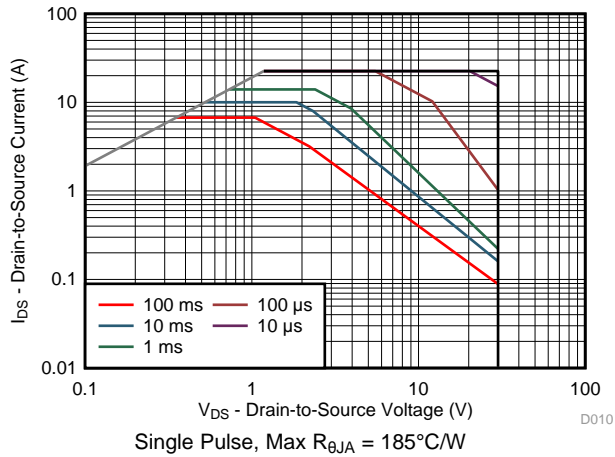

Figure 10. Maximum Safe Operating Area

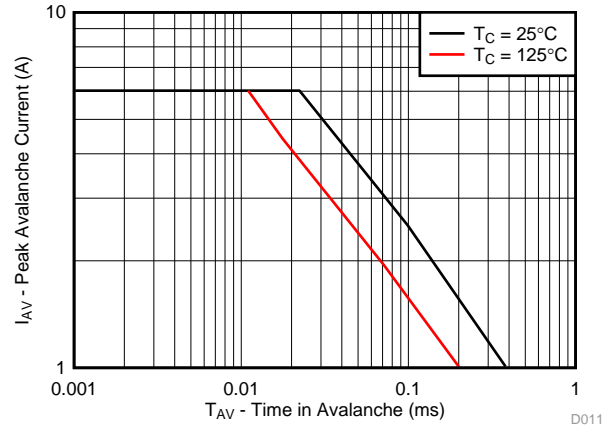

Figure 11. Single Pulse Unclamped Inductive Switching

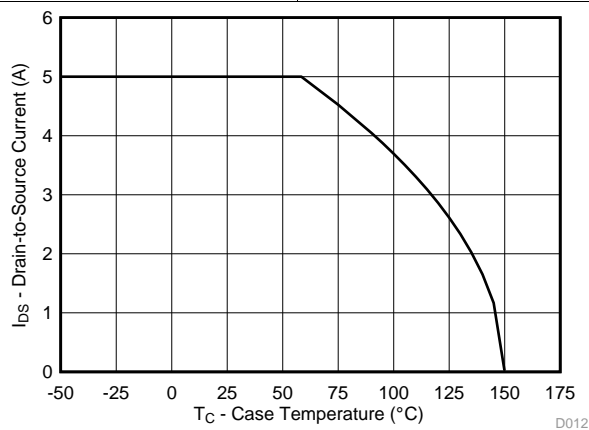

Figure 12. Maximum Drain Current vs Temperature

## 6 器件和文档支持

### 6.1 社区资源

The following links connect to TI community resources. Linked contents are provided "AS IS" by the respective contributors. They do not constitute TI specifications and do not necessarily reflect TI's views; see TI's [Terms of Use](#).

**TI E2E™ Online Community *TI's Engineer-to-Engineer (E2E) Community***. Created to foster collaboration among engineers. At [e2e.ti.com](http://e2e.ti.com), you can ask questions, share knowledge, explore ideas and help solve problems with fellow engineers.

**Design Support *TI's Design Support*** Quickly find helpful E2E forums along with design support tools and contact information for technical support.

### 6.2 商标

NexFET, E2E are trademarks of Texas Instruments.  
All other trademarks are the property of their respective owners.

### 6.3 静电放电警告



这些装置包含有限的内置 ESD 保护。存储或装卸时，应将导线一起截短或将装置放置于导电泡棉中，以防止 MOS 门极遭受静电损伤。

### 6.4 Glossary

[SLYZ022](#) — *TI Glossary*.

This glossary lists and explains terms, acronyms, and definitions.

## 7 机械、封装和可订购信息

以下页中包括机械、封装和可订购信息。这些信息是针对指定器件可提供的最新数据。这些数据会在无通知且不对本文档进行修订的情况下发生改变。要获得这份数据表的浏览器版本，请查阅左侧的导航栏。

### 7.1 封装尺寸

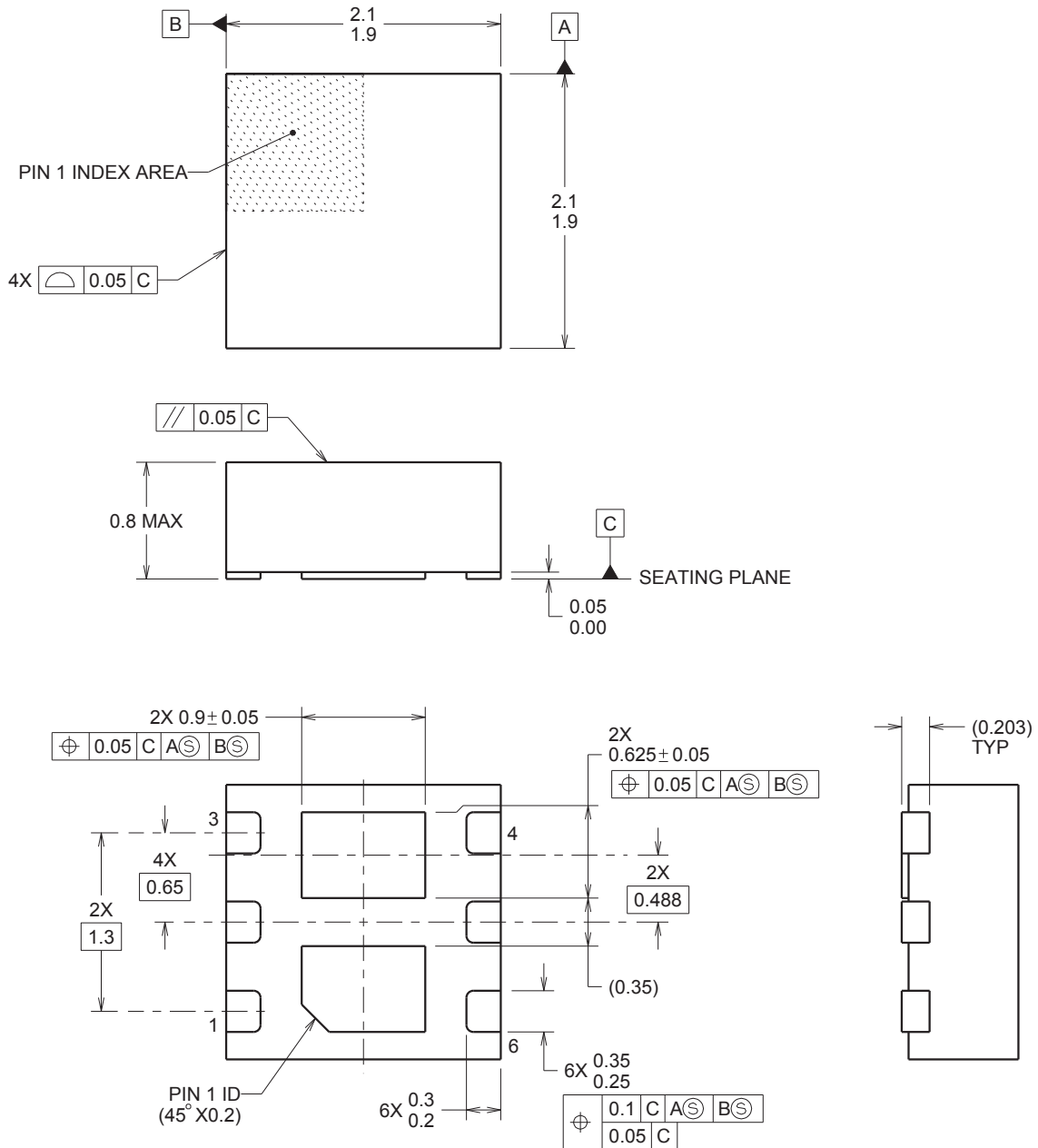

除非另外注明，否则全部尺寸单位均为 mm。



## 7.2 印刷电路板 (PCB) 焊盘图案

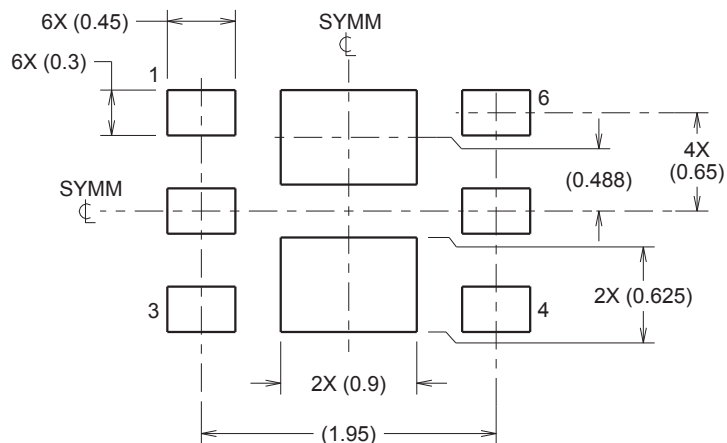

要获得与印刷电路板 (PCB) 设计相关的建议电路布局布线, 请参见《应用说明》[文献编号: SLPA005 - 通过 PCB 布局布线技巧来减少振铃](#)。

## 7.3 建议模板开口

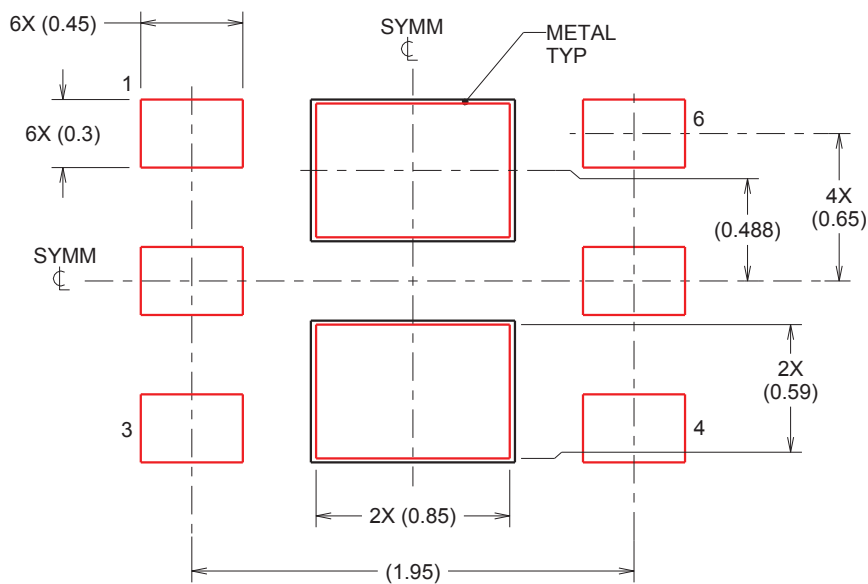

除非另外注明, 否则全部尺寸单位均为 mm。

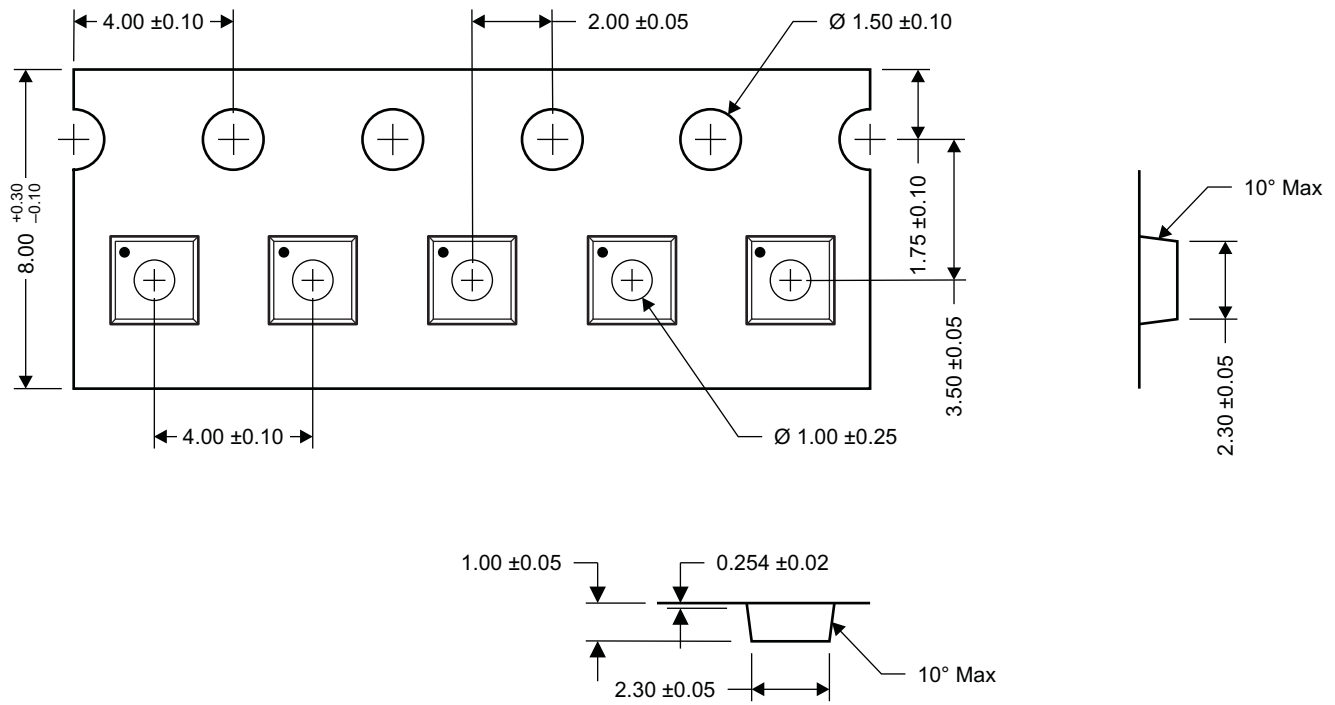
**7.4 Q2 卷带信息**

- Notes:
1. 测自链齿孔中心线到孔眼中心线
  2. 10 个链齿孔的累积容差为  $\pm 0.20$
  3. 其他材料可用
  4. 卷带的 SR 典型值最大为  $10^9$  OHM/SQ
  5. 全部尺寸单位为 mm，除非另外注明。

M0168-01

**PACKAGING INFORMATION**

Orderable Device	Status (1)	Package Type	Package Drawing	Pins	Package Qty	Eco Plan (2)	Lead finish/ Ball material (6)	MSL Peak Temp (3)	Op Temp (°C)	Device Marking (4/5)	Samples
CSD87502Q2	ACTIVE	WSON	DLV	6	3000	RoHS & Green	NIPDAU   SN	Level-1-260C-UNLIM	-55 to 150	8752	<a href="#">Samples</a>
CSD87502Q2T	ACTIVE	WSON	DLV	6	250	RoHS & Green	NIPDAU   SN	Level-1-260C-UNLIM	-55 to 150	8752	<a href="#">Samples</a>

(1) The marketing status values are defined as follows:

**ACTIVE:** Product device recommended for new designs.

**LIFEBUY:** TI has announced that the device will be discontinued, and a lifetime-buy period is in effect.

**NRND:** Not recommended for new designs. Device is in production to support existing customers, but TI does not recommend using this part in a new design.

**PREVIEW:** Device has been announced but is not in production. Samples may or may not be available.

**OBSOLETE:** TI has discontinued the production of the device.

(2) **RoHS:** TI defines "RoHS" to mean semiconductor products that are compliant with the current EU RoHS requirements for all 10 RoHS substances, including the requirement that RoHS substance do not exceed 0.1% by weight in homogeneous materials. Where designed to be soldered at high temperatures, "RoHS" products are suitable for use in specified lead-free processes. TI may reference these types of products as "Pb-Free".

**RoHS Exempt:** TI defines "RoHS Exempt" to mean products that contain lead but are compliant with EU RoHS pursuant to a specific EU RoHS exemption.

**Green:** TI defines "Green" to mean the content of Chlorine (Cl) and Bromine (Br) based flame retardants meet JS709B low halogen requirements of <=1000ppm threshold. Antimony trioxide based flame retardants must also meet the <=1000ppm threshold requirement.

(3) MSL, Peak Temp. - The Moisture Sensitivity Level rating according to the JEDEC industry standard classifications, and peak solder temperature.

(4) There may be additional marking, which relates to the logo, the lot trace code information, or the environmental category on the device.

(5) Multiple Device Markings will be inside parentheses. Only one Device Marking contained in parentheses and separated by a "~" will appear on a device. If a line is indented then it is a continuation of the previous line and the two combined represent the entire Device Marking for that device.

(6) Lead finish/Ball material - Orderable Devices may have multiple material finish options. Finish options are separated by a vertical ruled line. Lead finish/Ball material values may wrap to two lines if the finish value exceeds the maximum column width.

**Important Information and Disclaimer:**The information provided on this page represents TI's knowledge and belief as of the date that it is provided. TI bases its knowledge and belief on information provided by third parties, and makes no representation or warranty as to the accuracy of such information. Efforts are underway to better integrate information from third parties. TI has taken and continues to take reasonable steps to provide representative and accurate information but may not have conducted destructive testing or chemical analysis on incoming materials and chemicals. TI and TI suppliers consider certain information to be proprietary, and thus CAS numbers and other limited information may not be available for release.

In no event shall TI's liability arising out of such information exceed the total purchase price of the TI part(s) at issue in this document sold by TI to Customer on an annual basis.



## 重要声明和免责声明

TI“按原样”提供技术和可靠性数据（包括数据表）、设计资源（包括参考设计）、应用或其他设计建议、网络工具、安全信息和其他资源，不保证没有瑕疵且不做任何明示或暗示的担保，包括但不限于对适销性、某特定用途方面的适用性或不侵犯任何第三方知识产权的暗示担保。

这些资源可供使用 TI 产品进行设计的熟练开发人员使用。您将自行承担以下全部责任：(1) 针对您的应用选择合适的 TI 产品，(2) 设计、验证并测试您的应用，(3) 确保您的应用满足相应标准以及任何其他功能安全、信息安全、监管或其他要求。

这些资源如有变更，恕不另行通知。TI 授权您仅可将这些资源用于研发本资源所述的 TI 产品的应用。严禁对这些资源进行其他复制或展示。您无权使用任何其他 TI 知识产权或任何第三方知识产权。您应全额赔偿因在这些资源的使用中对 TI 及其代表造成的任何索赔、损害、成本、损失和债务，TI 对此概不负责。

TI 提供的产品受 [TI 的销售条款](#) 或 [ti.com](#) 上其他适用条款/TI 产品随附的其他适用条款的约束。TI 提供这些资源并不会扩展或以其他方式更改 TI 针对 TI 产品发布的适用的担保或担保免责声明。

TI 反对并拒绝您可能提出的任何其他或不同的条款。

邮寄地址：Texas Instruments, Post Office Box 655303, Dallas, Texas 75265

Copyright © 2024，德州仪器 (TI) 公司