

# CSD83325L 12V 双路 N 通道 NexFET™ 功率 MOSFET

## 1 特性

- 共漏极配置
- 低导通电阻
- 2.2mm x 1.15mm 的小尺寸
- 无铅
- 符合 RoHS
- 无卤素
- 栅极 ESD 保护

## 2 应用

- 电池管理
- 电池保护

## 3 说明

这款 12V、9.9mΩ、2.2mm x 1.15mm LGA 双路 NexFET™ 功率 MOSFET 旨在以小巧封装更大程度地降低电阻和栅极电荷。该器件尺寸小巧并采用共漏极配置，非常适合小型手持设备的电池包应用。

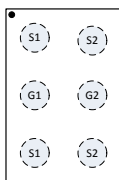

顶视图

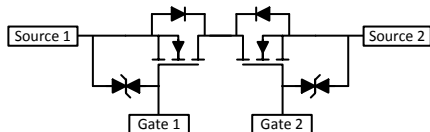

配置

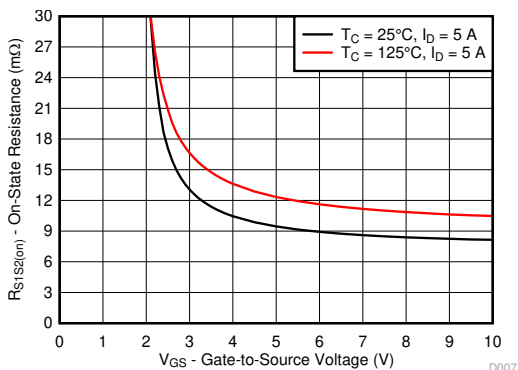

$R_{DS(on)}$  与  $V_{GS}$  之间的关系

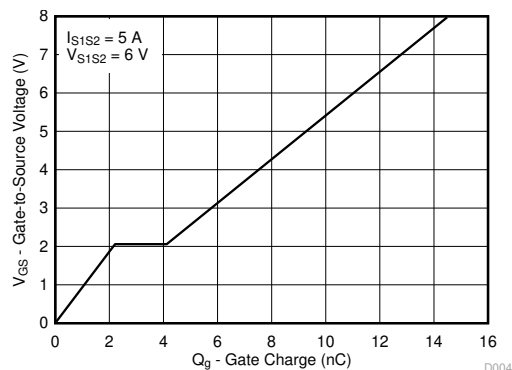

栅极电荷

## 产品概要

$T_A = 25^\circ\text{C}$		典型值		单位
$V_{S1S2}$	源源电压	12		V
$Q_g$	栅极电荷总量 (4.5V)	8.4		nC
$Q_{gd}$	栅极电荷 (栅极到漏极)	1.9		nC
$R_{S1S2(on)}$	源极至源极导通电阻	$V_{GS} = 2.5\text{V}$	17.5	mΩ
		$V_{GS} = 3.8\text{V}$	10.9	mΩ
		$V_{GS} = 4.5\text{V}$	9.9	mΩ
$V_{GS(th)}$	阈值电压	1.0		V

## 器件信息(1)

器件	数量	介质	封装	出货
CSD83325L	3000	7 英寸卷带	2.20mm x 1.15mm Land Grid Array (LGA) 封装	卷带包装
CSD83325LT	250			

- (1) 如需了解所有可用封装，请参阅数据表末尾的可订购产品附录。

## 绝对最大额定值

$T_A = 25^\circ\text{C}$		值	单位
$V_{S1S2}$	源源电压	12	V
$V_{GS}$	栅源电压	$\pm 10$	V
$I_S$	持续源极电流 <sup>(1)</sup>	8	A
$I_{SM}$	脉冲源极电流 <sup>(2)</sup>	52	A
$P_D$	功率耗散	2.3	W
$V_{(ESD)}$	人体放电模型 (HBM)	2000	V
$T_J$ , $T_{stg}$	工作结温， 贮存温度	-55 至 150	$^\circ\text{C}$

- (1) 器件在  $105^\circ\text{C}$  温度下运行。  
 (2)  $R_{\theta JA} = 150^\circ\text{C/W}$  (覆铜面积最小时的典型值)，脉冲持续时间  $\leq 100\mu\text{s}$ ，占空比  $\leq 1\%$ 。



## Table of Contents

<b>1 特性</b> .....	1	5.1 第三方产品免责声明.....	6
<b>2 应用</b> .....	1	5.2 接收文档更新通知.....	6
<b>3 说明</b> .....	1	5.3 支持资源.....	6
<b>4 Specifications</b> .....	3	5.4 Trademarks.....	6
4.1 Electrical Characteristics.....	3	5.5 静电放电警告.....	6
4.2 Thermal Information.....	3	5.6 术语表.....	6
4.3 Typical MOSFET Characteristics.....	4	<b>6 Revision History</b> .....	6
<b>5 Device and Documentation Support</b> .....	6	<b>7 Mechanical, Packaging, and Orderable Information</b> ....	7

## 4 Specifications

### 4.1 Electrical Characteristics

$T_A = 25^\circ\text{C}$  (unless otherwise stated)

PARAMETER		TEST CONDITIONS	MIN	TYP	MAX	UNIT
<b>STATIC CHARACTERISTICS</b>						
$BV_{S1S2}$	Source-to-source voltage	$V_{GS} = 0\text{ V}, I_S = 250\ \mu\text{A}$	12			V
$I_{S1S2}$	Source-to-source leakage current	$V_{GS} = 0\text{ V}, V_{S1S2} = 9.6\text{ V}$			1.0	$\mu\text{A}$
$I_{GSS}$	Gate-to-source leakage current	$V_{S1S2} = 0\text{ V}, V_{GS} = 10\text{ V}$			10	$\mu\text{A}$
$V_{GS(th)}$	Gate-to-source threshold voltage	$V_{S1S2} = V_{GS}, I_S = 250\ \mu\text{A}$	0.7	1.0	1.4	V
$R_{S1S2(on)}$	Source-to-source on resistance	$V_{GS} = 2.5\text{ V}, I_S = 5\text{ A}$	12.0	17.5	23.0	m $\Omega$
		$V_{GS} = 3.8\text{ V}, I_S = 5\text{ A}$	8.8	10.9	13.0	m $\Omega$
		$V_{GS} = 4.5\text{ V}, I_S = 5\text{ A}$	7.9	9.9	11.9	m $\Omega$
$g_{fs}$	Transconductance	$V_{S1S2} = 1.2\text{ V}, I_S = 5\text{ A}$		36		S
<b>DYNAMIC CHARACTERISTICS<sup>(1)</sup></b>						
$C_{iss}$	Input capacitance	$V_{GS} = 0\text{ V}, V_{S1S2} = 6\text{ V}, f = 1\text{ MHz}$		902	1170	pF
$C_{oss}$	Output capacitance			187	243	pF
$C_{riss}$	Reverse transfer capacitance			111	144	pF
$Q_g$	Gate charge total (4.5 V)	$V_{S1S2} = 6\text{ V}, I_S = 5\text{ A}$		8.4	10.9	nC
$Q_{gd}$	Gate charge gate-to-drain			1.9		nC
$Q_{gs}$	Gate charge gate-to-source			2.2		nC
$Q_{g(th)}$	Gate charge at $V_{th}$			0.6		nC
$Q_{oss}$	Output charge		$V_{S1S2} = 6\text{ V}, V_{GS} = 0\text{ V}$		2.9	
$t_{d(on)}$	Turnon delay time	$V_{S1S2} = 6\text{ V}, V_{GS} = 4.5\text{ V}, I_{S1S2} = 5\text{ A}, R_G = 0\ \Omega$		205		ns
$t_r$	Rise time			353		ns
$t_{d(off)}$	Turnoff delay time			711		ns
$t_f$	Fall time			589		ns
<b>DIODE CHARACTERISTICS</b>						
$V_{F(S-S)}$	Source-to-source diode forward voltage	$I_{SS} = 5\text{ A}, V_{G1S1} = 0\text{ V}, V_{G2S2} = 4.5\text{ V}$		0.79	1.0	V

(1) Dynamic characteristics values specified are per single FET.

### 4.2 Thermal Information

$T_A = 25^\circ\text{C}$  (unless otherwise stated)

THERMAL METRIC		MIN	TYP	MAX	UNIT
$R_{\theta JA}$	Junction-to-ambient thermal resistance <sup>(1)</sup>		150		$^\circ\text{C/W}$
	Junction-to-ambient thermal resistance <sup>(2)</sup>		55		

(1) Device mounted on FR4 material with minimum Cu mounting area.

(2) Device mounted on FR4 material with 1-in<sup>2</sup> (6.45-cm<sup>2</sup>), 2-oz (0.071-mm) thick Cu.

### 4.3 Typical MOSFET Characteristics

$T_A = 25^\circ\text{C}$  (unless otherwise stated)

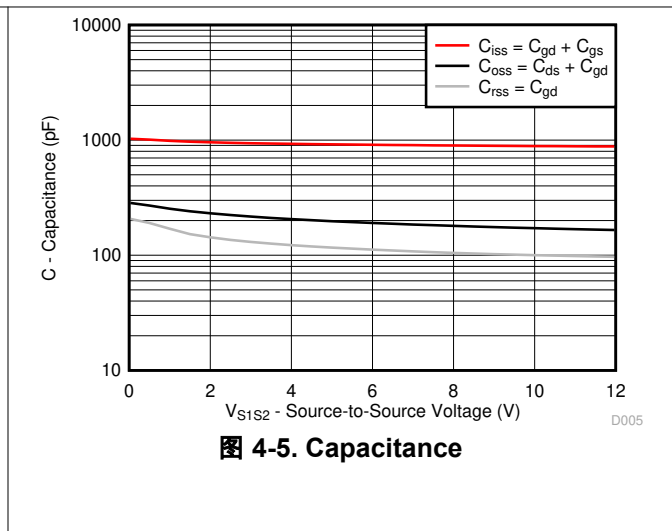
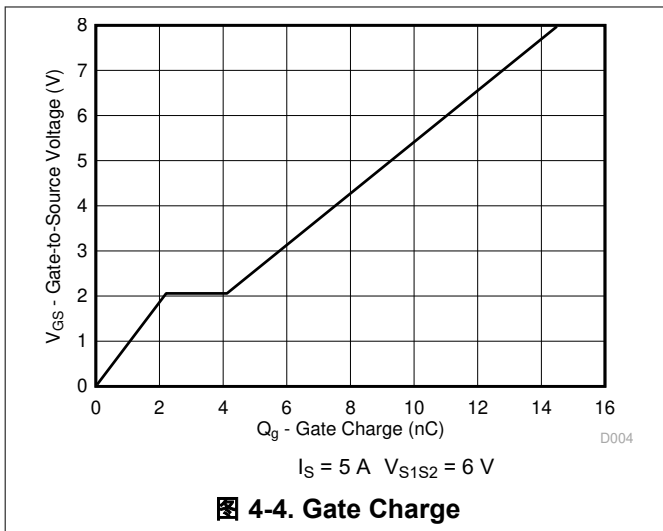
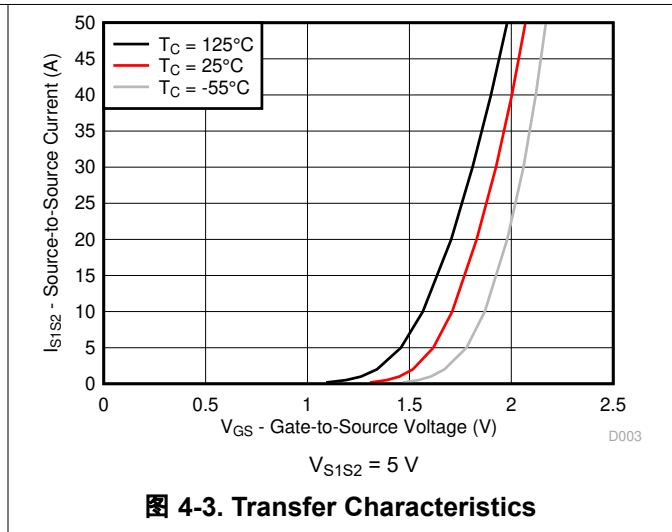
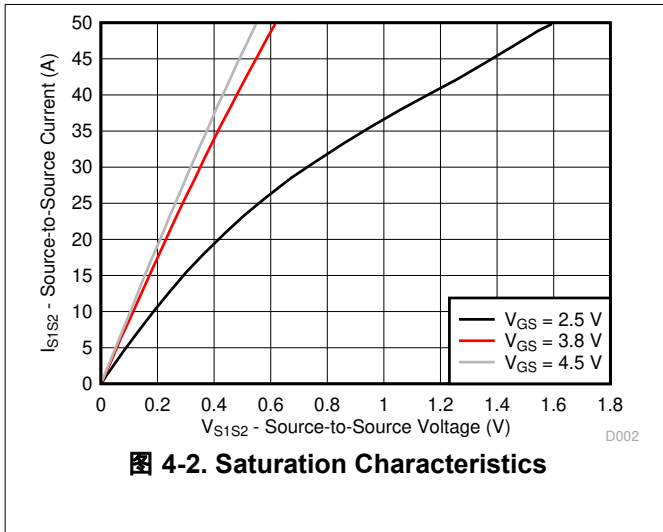
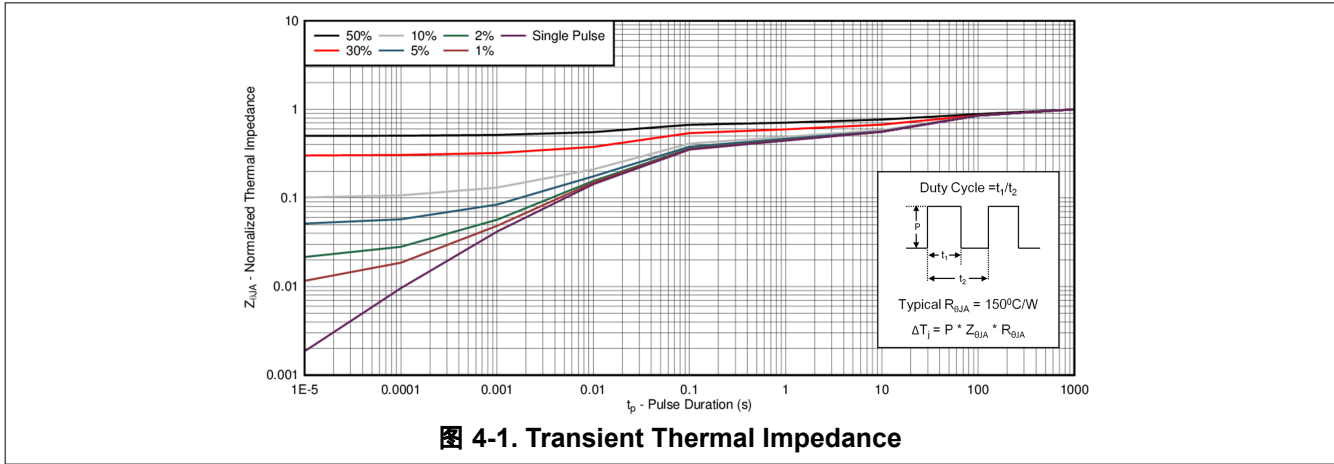



图 4-6. Threshold Voltage vs Temperature



图 4-7. On-State Source-to-Source Resistance vs Gate-to-Source Voltage

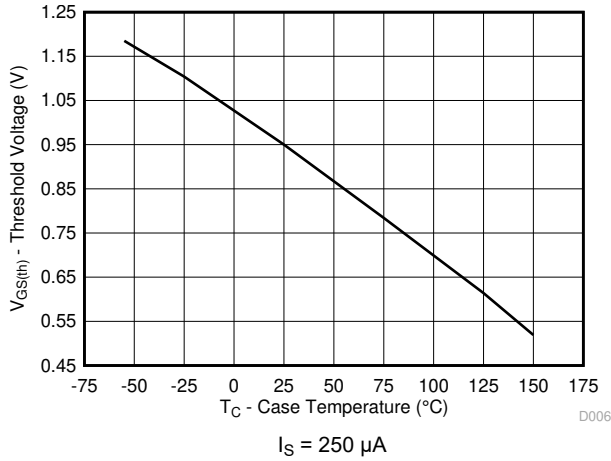

图 4-8. Normalized On-State Resistance vs Temperature

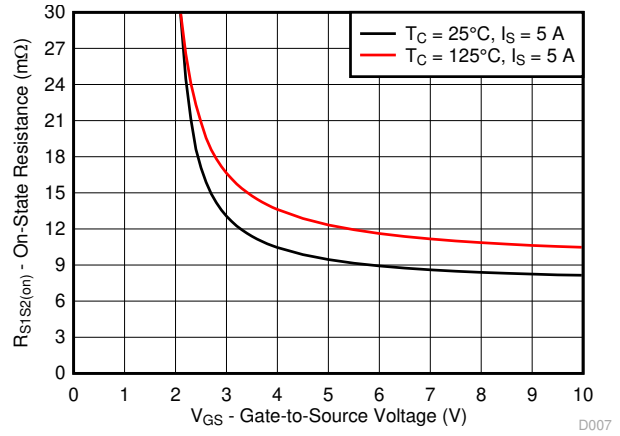

图 4-9. Typical Diode Forward Voltage

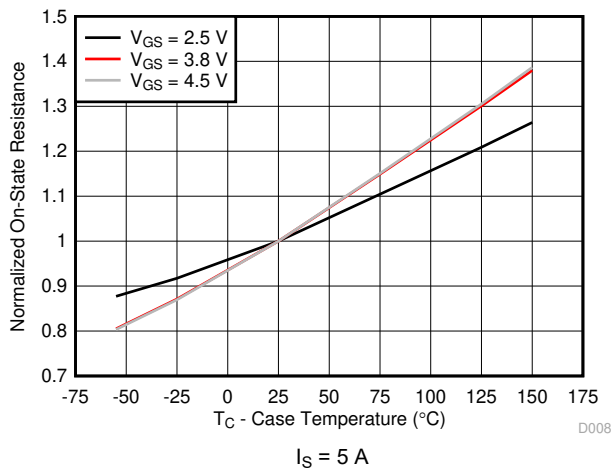

图 4-10. Maximum Safe Operating Area

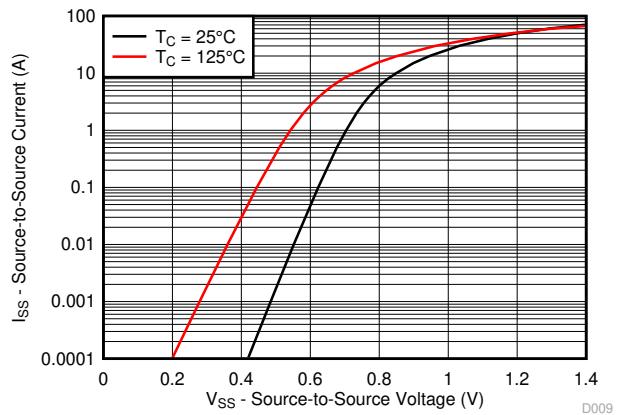

图 4-11. Maximum Source Current vs Temperature

## 5 Device and Documentation Support

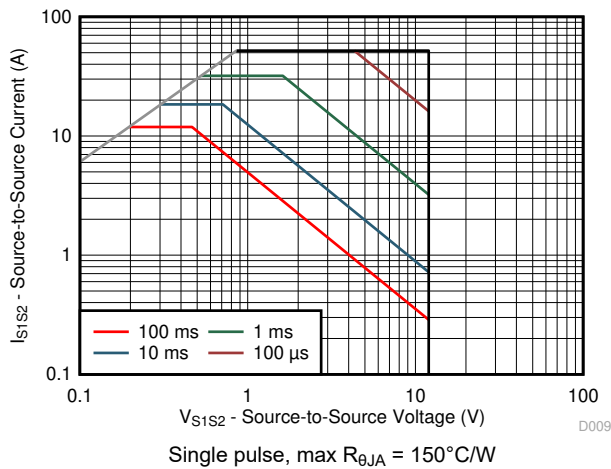
### 5.1 第三方产品免责声明

TI 发布的与第三方产品或服务有关的信息，不能构成与此类产品或服务或保修的适用性有关的认可，不能构成此类产品或服务单独或与任何 TI 产品或服务一起的表示或认可。

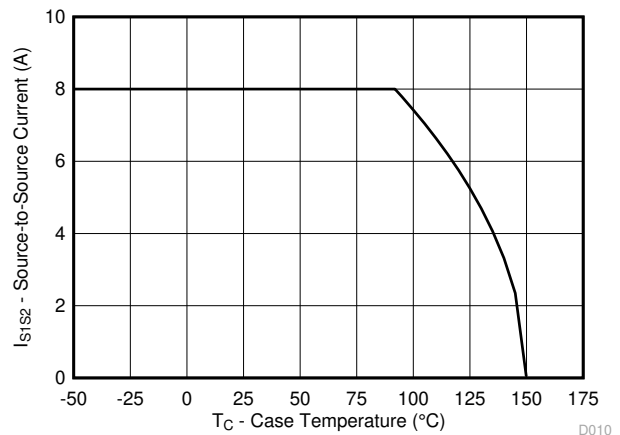
### 5.2 接收文档更新通知

要接收文档更新通知，请导航至 [ti.com](http://ti.com) 上的器件产品文件夹。点击 [通知](#) 进行注册，即可每周接收产品信息更改摘要。有关更改的详细信息，请查看任何已修订文档中包含的修订历史记录。

### 5.3 支持资源

TI E2E™ [中文支持论坛](#) 是工程师的重要参考资料，可直接从专家处获得快速、经过验证的解答和设计帮助。搜索现有解答或提出自己的问题，获得所需的快速设计帮助。

链接的内容由各个贡献者“按原样”提供。这些内容并不构成 TI 技术规范，并且不一定反映 TI 的观点；请参阅 TI 的 [使用条款](#)。

### 5.4 Trademarks

NexFET™ and TI E2E™ are trademarks of Texas Instruments.

所有商标均为其各自所有者的财产。

### 5.5 静电放电警告



静电放电 (ESD) 会损坏这个集成电路。德州仪器 (TI) 建议通过适当的预防措施处理所有集成电路。如果不遵守正确的处理和安装程序，可能会损坏集成电路。

ESD 的损坏小至导致微小的性能降级，大至整个器件故障。精密的集成电路可能更容易受到损坏，这是因为非常细微的参数更改都可能会导致器件与其发布的规格不相符。

### 5.6 术语表

[TI 术语表](#) 本术语表列出并解释了术语、首字母缩略词和定义。

## 6 Revision History

注：以前版本的页码可能与当前版本的页码不同

Changes from Revision B (February 2017) to Revision C (November 2023)	Page
• 将阈值电压 $G_S(th)$ 从 0.95V 更新为 1.0V.....	1
• 更新了整个文档中的表格、图和交叉参考的编号格式.....	1
• Updated Source-to-source on resistance $V_{GS} = 2.5\text{ V}$ from 14 mΩ to 12 mΩ.....	3
• Updated Gate-to-source threshold voltage from 0.75 V min, 0.95 V typ, 1.25 V max to 0.7 V min, 1.0 V typ, 1.4 V max.....	3
Changes from Revision A (January 2016) to Revision B (February 2017)	Page
• Added Diode Characteristics ( $V_{F(S-S)}$ ) in the <i>Electrical Characteristics</i> table.....	3
• Added <a href="#">图 4-9</a> to <i>Typical MOSFET Characteristics</i> section.....	4
Changes from Revision * (November 2014) to Revision A (January 2016)	Page
• Improved graph setup for readability.....	4

## 7 Mechanical, Packaging, and Orderable Information

The following pages include mechanical, packaging, and orderable information. This information is the most current data available for the designated devices. This data is subject to change without notice and revision of this document. For browser-based versions of this data sheet, refer to the left-hand navigation.

**PACKAGING INFORMATION**

Orderable part number	Status (1)	Material type (2)	Package   Pins	Package qty   Carrier	RoHS (3)	Lead finish/ Ball material (4)	MSL rating/ Peak reflow (5)	Op temp (°C)	Part marking (6)
<a href="#">CSD83325L</a>	Active	Production	PICOSTAR (YJE)   6	3000   LARGE T&R	Yes	NIAU	Level-1-260C-UNLIM	-	83325L
CSD83325L.Z	Active	Production	PICOSTAR (YJE)   6	3000   LARGE T&R	Yes	NIAU	Level-1-260C-UNLIM	-55 to 150	83325L
<a href="#">CSD83325LT</a>	Active	Production	PICOSTAR (YJE)   6	250   SMALL T&R	Yes	NIAU	Level-1-260C-UNLIM	-55 to 150	83325L
CSD83325LT.Z	Active	Production	PICOSTAR (YJE)   6	250   SMALL T&R	Yes	NIAU	Level-1-260C-UNLIM	-55 to 150	83325L

(1) **Status:** For more details on status, see our [product life cycle](#).

(2) **Material type:** When designated, preproduction parts are prototypes/experimental devices, and are not yet approved or released for full production. Testing and final process, including without limitation quality assurance, reliability performance testing, and/or process qualification, may not yet be complete, and this item is subject to further changes or possible discontinuation. If available for ordering, purchases will be subject to an additional waiver at checkout, and are intended for early internal evaluation purposes only. These items are sold without warranties of any kind.

(3) **RoHS values:** Yes, No, RoHS Exempt. See the [TI RoHS Statement](#) for additional information and value definition.

(4) **Lead finish/Ball material:** Parts may have multiple material finish options. Finish options are separated by a vertical ruled line. Lead finish/Ball material values may wrap to two lines if the finish value exceeds the maximum column width.

(5) **MSL rating/Peak reflow:** The moisture sensitivity level ratings and peak solder (reflow) temperatures. In the event that a part has multiple moisture sensitivity ratings, only the lowest level per JEDEC standards is shown. Refer to the shipping label for the actual reflow temperature that will be used to mount the part to the printed circuit board.

(6) **Part marking:** There may be an additional marking, which relates to the logo, the lot trace code information, or the environmental category of the part.

Multiple part markings will be inside parentheses. Only one part marking contained in parentheses and separated by a "~" will appear on a part. If a line is indented then it is a continuation of the previous line and the two combined represent the entire part marking for that device.

**Important Information and Disclaimer:** The information provided on this page represents TI's knowledge and belief as of the date that it is provided. TI bases its knowledge and belief on information provided by third parties, and makes no representation or warranty as to the accuracy of such information. Efforts are underway to better integrate information from third parties. TI has taken and continues to take reasonable steps to provide representative and accurate information but may not have conducted destructive testing or chemical analysis on incoming materials and chemicals. TI and TI suppliers consider certain information to be proprietary, and thus CAS numbers and other limited information may not be available for release.

In no event shall TI's liability arising out of such information exceed the total purchase price of the TI part(s) at issue in this document sold by TI to Customer on an annual basis.



**TAPE AND REEL INFORMATION**

**QUADRANT ASSIGNMENTS FOR PIN 1 ORIENTATION IN TAPE**

\*All dimensions are nominal

Device	Package Type	Package Drawing	Pins	SPQ	Reel Diameter (mm)	Reel Width W1 (mm)	A0 (mm)	B0 (mm)	K0 (mm)	P1 (mm)	W (mm)	Pin1 Quadrant
CSD83325L	PICOSTAR	YJE	6	3000	180.0	8.4	1.25	2.34	0.32	4.0	8.0	Q1
CSD83325LT	PICOSTAR	YJE	6	250	180.0	8.4	1.25	2.34	0.32	4.0	8.0	Q1

## TAPE AND REEL BOX DIMENSIONS



\*All dimensions are nominal

Device	Package Type	Package Drawing	Pins	SPQ	Length (mm)	Width (mm)	Height (mm)
CSD83325L	PICOSTAR	YJE	6	3000	182.0	182.0	20.0
CSD83325LT	PICOSTAR	YJE	6	250	182.0	182.0	20.0

# YJE0006A



# PACKAGE OUTLINE

PicoStar™ - 0.22 mm max height

PicoStar

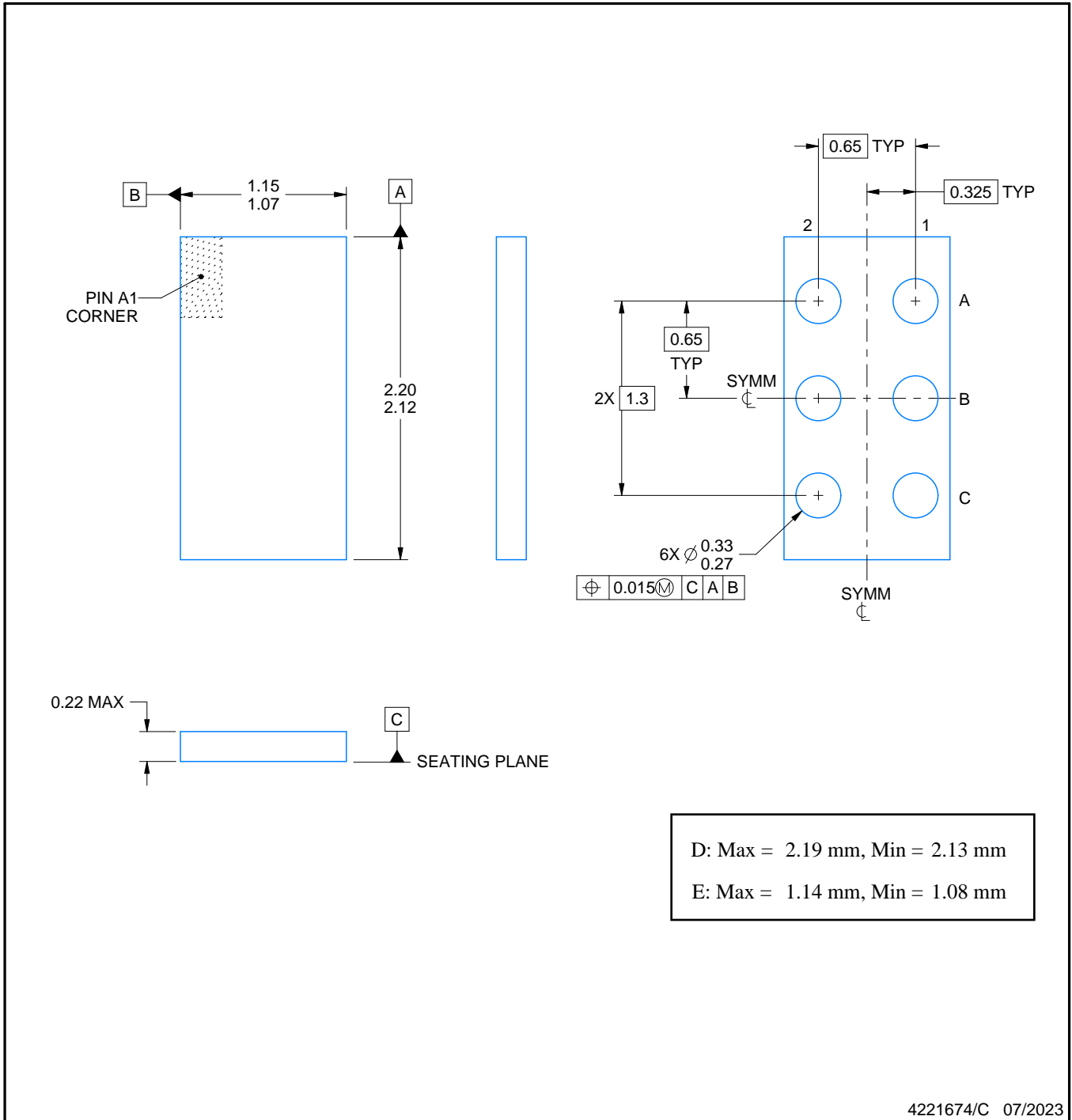

**NOTES:**

PicoStar is a trademark of Texas Instruments.

1. All linear dimensions are in millimeters. Any dimensions in parenthesis are for reference only. Dimensioning and tolerancing per ASME Y14.5M.
2. This drawing is subject to change without notice.

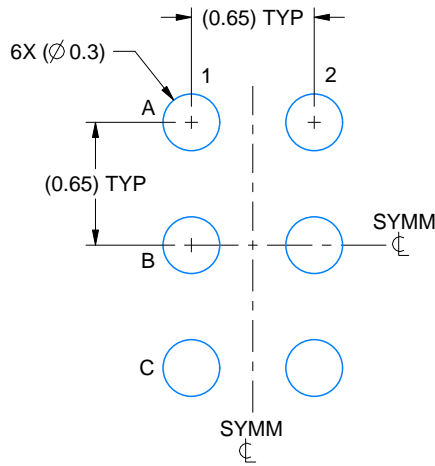

LAND PATTERN EXAMPLE  
EXPOSED METAL SHOWN  
SCALE:25X

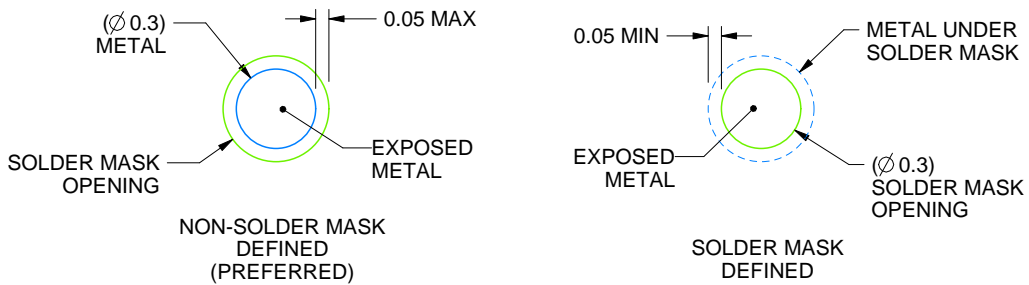

SOLDER MASK DETAILS  
NOT TO SCALE

NOTES: (continued)

- Final dimensions may vary due to manufacturing tolerance considerations and also routing constraints. For more information, see Texas Instruments literature number SLUA271 ([www.ti.com/lit/slua271](http://www.ti.com/lit/slua271)).

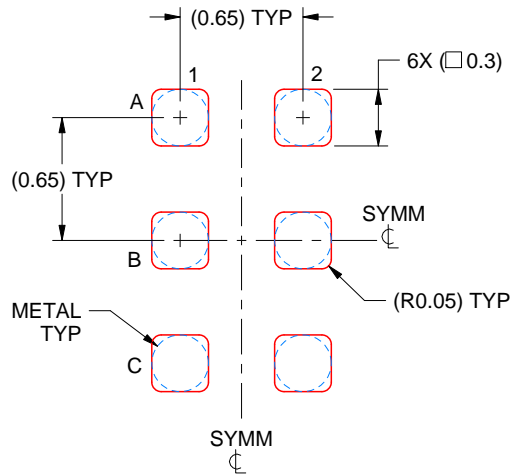

SOLDER PASTE EXAMPLE  
BASED ON 0.1 mm THICK STENCIL  
SCALE:25X

NOTES: (continued)

- 4. Laser cutting apertures with trapezoidal walls and rounded corners may offer better paste release.

## 重要通知和免责声明

TI“按原样”提供技术和可靠性数据（包括数据表）、设计资源（包括参考设计）、应用或其他设计建议、网络工具、安全信息和其他资源，不保证没有瑕疵且不做任何明示或暗示的担保，包括但不限于对适销性、某特定用途方面的适用性或不侵犯任何第三方知识产权的暗示担保。

这些资源可供使用 TI 产品进行设计的熟练开发人员使用。您将自行承担以下全部责任：(1) 针对您的应用选择合适的 TI 产品，(2) 设计、验证并测试您的应用，(3) 确保您的应用满足相应标准以及任何其他功能安全、信息安全、监管或其他要求。

这些资源如有变更，恕不另行通知。TI 授权您仅可将这些资源用于研发本资源所述的 TI 产品的相关应用。严禁以其他方式对这些资源进行复制或展示。您无权使用任何其他 TI 知识产权或任何第三方知识产权。您应全额赔偿因在这些资源的使用中对 TI 及其代表造成的任何索赔、损害、成本、损失和债务，TI 对此概不负责。

TI 提供的产品受 [TI 的销售条款](#) 或 [ti.com](#) 上其他适用条款/TI 产品随附的其他适用条款的约束。TI 提供这些资源并不会扩展或以其他方式更改 TI 针对 TI 产品发布的适用的担保或担保免责声明。

TI 反对并拒绝您可能提出的任何其他或不同的条款。

邮寄地址：Texas Instruments, Post Office Box 655303, Dallas, Texas 75265  
版权所有 © 2025，德州仪器 (TI) 公司