

30V, N 通道 NexFET™ 功率金属氧化物半导体场效应晶体管 (MOSFET)

1 特性

- 超低 Q_g 和 Q_{gd}
- 低热阻
- 具有雪崩能力
- 无铅引脚镀层
- 符合 RoHS
- 无卤素
- SON 5mm × 6mm 塑料封装

2 应用

- 网络、电信和计算系统的负载点同步降压
- 针对控制和同步 FET 应用进行了优化

3 说明

NexFET™ 功率 MOSFET 旨在更大幅度地降低功率转换应用中的损耗。

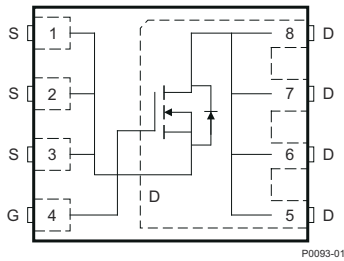

顶视图

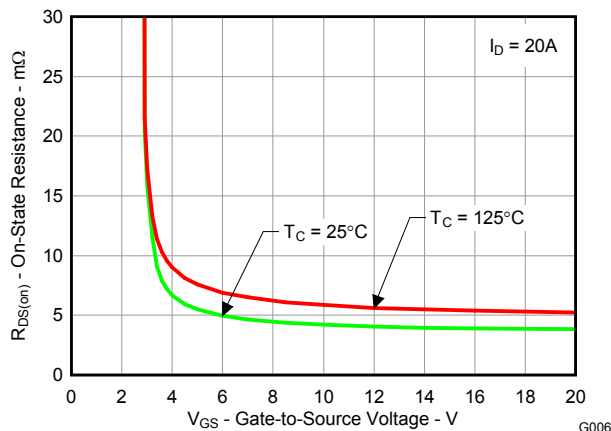

$R_{DS(on)}$ 与 V_{GS} 间的关系

产品概要

V_{DS}	漏源极电压	30	V
Q_g	栅极电荷总量 (4.5V)	6.4	nC
Q_{gd}	栅漏极电荷	1.9	nC
$R_{DS(on)}$	漏源导通电阻	$V_{GS} = 4.5V$	5.4 mΩ
		$V_{GS} = 10V$	4.1 mΩ
$V_{GS(th)}$	阈值电压	1.5	V

订购信息

器件	封装	介质	数量	运输
CSD17510Q5A	SON 5mm × 6mm 塑料封装	13 英寸卷带	2500	卷带包装

绝对最大额定值

$T_A = 25^\circ C$ 时测得, 除非另有说明		值	单位
V_{DS}	漏源极电压	30	V
V_{GS}	栅源电压	±20	V
I_D	持续漏极电流, $T_C = 25^\circ C$	55	A
	持续漏极电流 ⁽¹⁾	20	A
I_{DM}	脉冲漏极电流, $T_A = 25^\circ C$ ⁽²⁾	129	A
P_D	功率耗散 ⁽¹⁾	3	W
T_J, T_{STG}	运行结温和储存温度范围	-55 至 150	°C
E_{AS}	雪崩能量, 单脉冲 $I_D = 54A, L = 0.1mH, R_G = 25\Omega$	146	mJ

- (1) $R_{\theta JA} = 41^\circ C/W$, 这是在一块厚度为 0.06 英寸 (1.52mm) 的环氧树脂 (FR4) 印刷电路板 (PCB) 上的 1 英寸² (6.45cm²), 2 盎司 (厚度为 0.071mm) 的覆铜焊盘上测得的典型值。
- (2) 脉冲持续时间 $\leq 300 \mu s$, 占空比 $\leq 2\%$

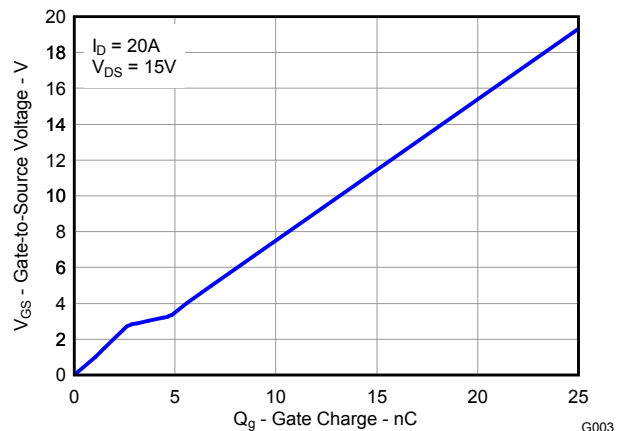

栅极电荷



内容

1 特性.....	1	7.2 文档支持.....	8
2 应用.....	1	7.3 接收文档更新通知.....	8
3 说明.....	1	7.4 支持资源.....	8
4 电气特性.....	3	7.5 商标.....	8
5 热特性.....	3	7.6 静电放电警告.....	8
6 典型 MOSFET 特性.....	5	7.7 术语表.....	8
7 器件和文档支持.....	8	9 机械数据.....	10
7.1 第三方产品免责声明.....	8		

4 电气特性

($T_A = 25^\circ\text{C}$ 时测得, 除非另有说明)

参数		测试条件	最小值	典型值	最大值	单位
静态特性						
BV_{DSS}	漏源极电压	$V_{GS} = 0V, I_{DS} = 250 \mu A$	30			V
I_{DSS}	漏源漏电流	$V_{GS} = 0V, V_{DS} = 24V$			1	μA
I_{GSS}	栅源漏电流	$V_{DS} = 0V, V_{GS} = 20V$			100	nA
$V_{GS(th)}$	栅源阈值电压	$V_{DS} = V_{GS}, I_{DS} = 250 \mu A$	1	1.5	2.1	V
$R_{DS(on)}$	漏源导通电阻	$V_{GS} = 4.5V, I_{DS} = 20A$		5.4	7.3	$m\Omega$
		$V_{GS} = 10V, I_{DS} = 20A$		4.1	5.2	$m\Omega$
g_{fs}	跨导	$V_{DS} = 15V, I_{DS} = 20A$		59		S
动态特性						
C_{iss}	输入电容	$V_{GS} = 0V, V_{DS} = 15V, f = 1MHz$		960	1250	pF
C_{oss}	输出电容			630	820	pF
C_{rss}	反向传输电容			51	66	pF
R_G	串联栅极电阻		0.85	1.7		Ω
Q_g	栅极电荷总量 (4.5V)	$V_{DS} = 15V, I_{DS} = 20A$		6.4	8.3	nC
Q_{gd}	栅漏栅极电荷			1.9		nC
Q_{gs}	栅源栅极电荷			2.7		nC
$Q_{g(th)}$	V_{th} 下的栅极电荷			1.5		nC
Q_{oss}	输出电荷		$V_{DS} = 13.5V, V_{GS} = 0V$		16	
$t_{d(on)}$	导通延长时间	$V_{DS} = 15V, V_{GS} = 4.5V, I_{DS} = 20A, R_G = 2\Omega$		7		ns
t_r	上升时间			11		ns
$t_{d(off)}$	关断延迟时间			9		ns
t_f	下降时间			4.1		ns
二极管特性						
V_{SD}	二极管正向电压	$I_{SD} = 20A, V_{GS} = 0V$		0.85	1	V
Q_{rr}	反向恢复电荷	$V_{DD} = 13.5V, I_F = 20A, di/dt = 300A/\mu s$		25		nC
t_{rr}	反向恢复时间			24		ns

5 热特性

($T_A = 25^\circ\text{C}$ 时测得, 除非另有说明)

参数		最小值	典型值	最大值	单位
$R_{\theta JC}$	结至外壳热阻 ⁽¹⁾			1.6	$^\circ\text{C}/\text{W}$
$R_{\theta JA}$	结至环境热阻 ⁽¹⁾⁽²⁾			51	$^\circ\text{C}/\text{W}$

- (1) $R_{\theta JC}$ 是在器件安装在 1.5 英寸 × 1.5 英寸 (3.81cm × 3.81cm)、厚度为 0.06 英寸 (1.52mm) 的 FR4 PCB 上的 1 英寸² (6.45cm²)、2 盎司 (厚度为 0.071mm) 的覆铜焊盘上测得的典型值。 $R_{\theta JC}$ 由设计指定, 而 $R_{\theta JA}$ 由用户的电路板设计确定。
- (2) 器件安装在具有 1 英寸² (6.45cm²)、2 盎司 (厚度为 0.071mm) 的覆铜焊盘的 FR4 材料上。

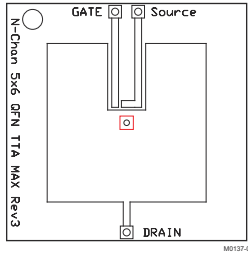

$R_{\theta JA}$ 最大值 = 51°C/W ，安装在 1 英寸^2 (6.45cm^2)、2 盎司 (厚度为 0.071mm) 的覆铜焊盘上时。

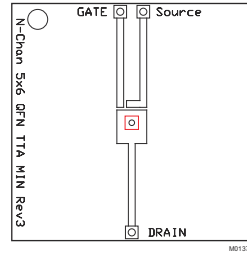

$R_{\theta JA}$ 最大值 = 125°C/W ，安装在最小面积的 2 盎司 (厚度为 0.071mm) 覆铜焊盘上时。

6 典型 MOSFET 特性

($T_A = 25^\circ\text{C}$ 时测得，除非另有说明)

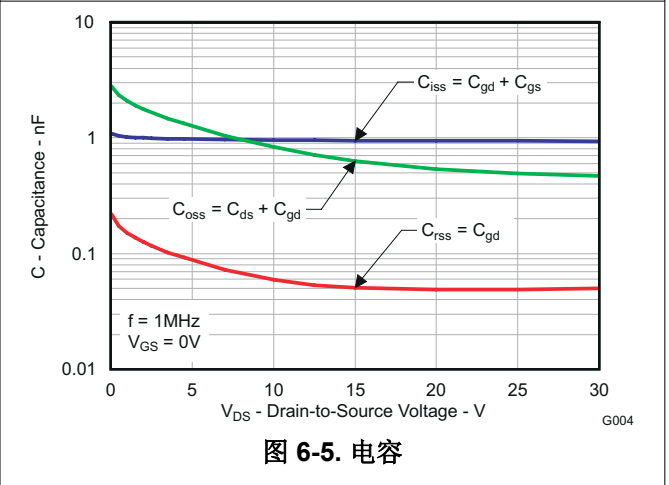
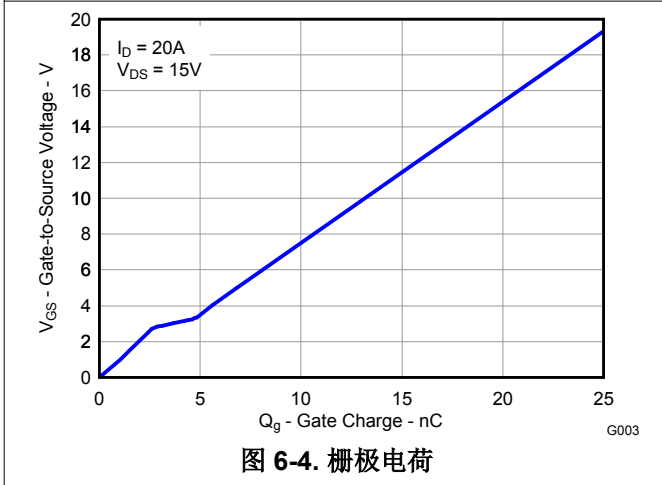
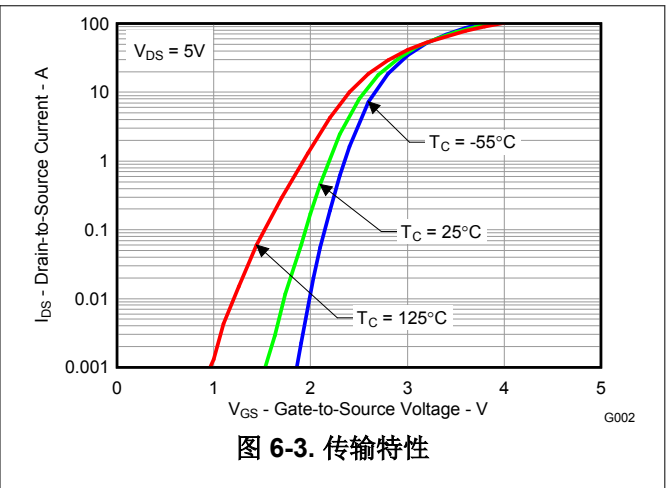
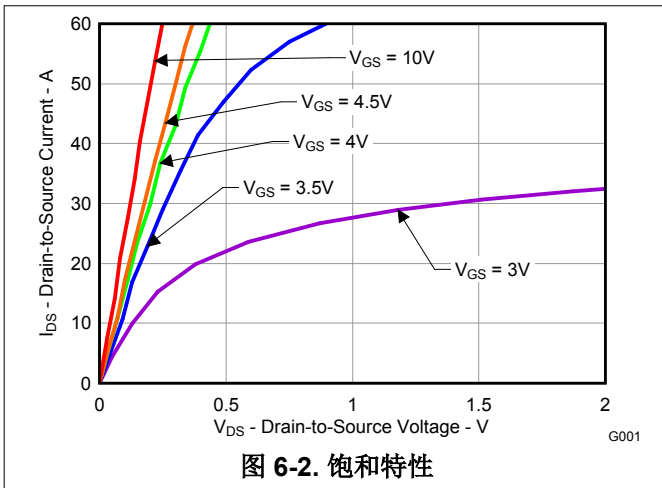
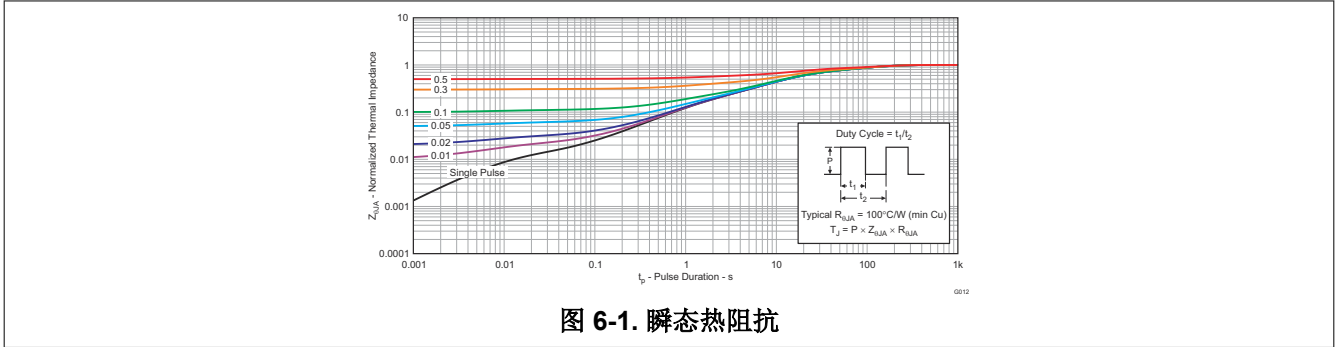



图 6-6. 阈值电压与温度间的关系



图 6-7. 通态电阻与栅源电压间的关系

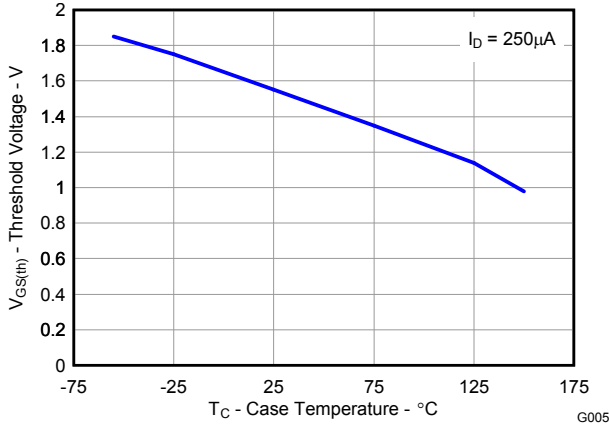

图 6-8. 标准化通态电阻与温度间的关系

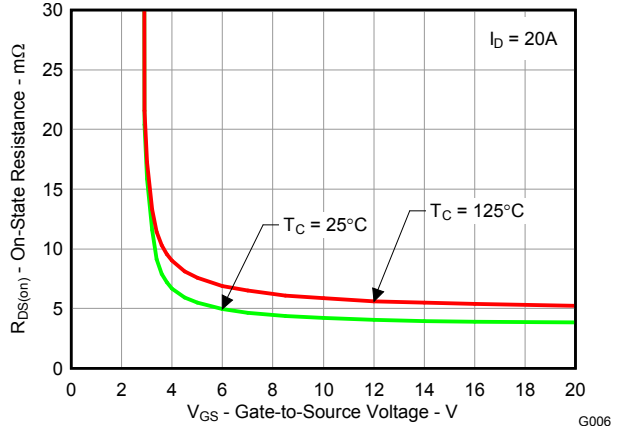

图 6-9. 典型二极管正向电压

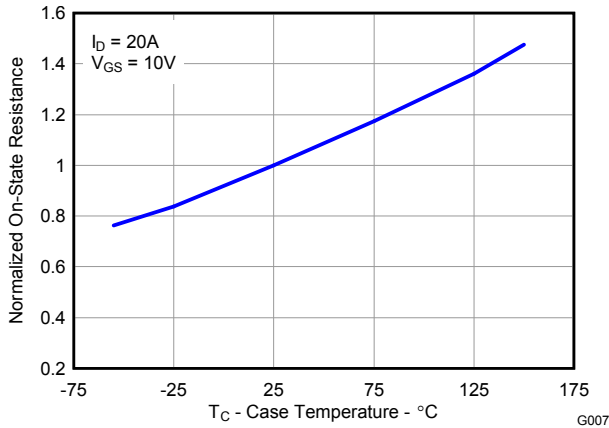

图 6-10. 最大安全工作区

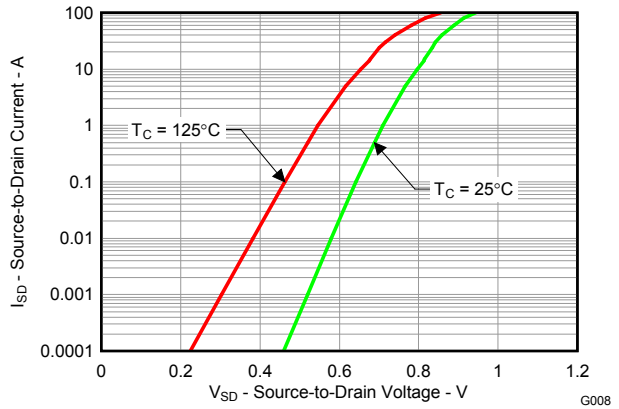

图 6-11. 单脉冲非钳位电感式开关

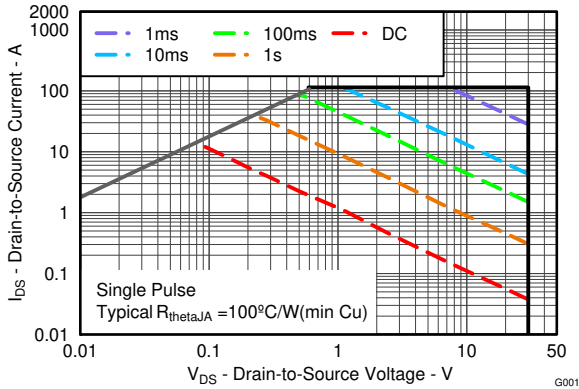

图 6-12. 最大漏极电流与温度间的关系

7 器件和文档支持

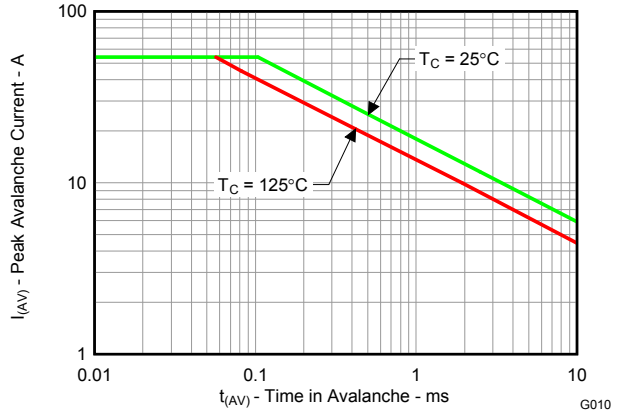
TI 提供大量的开发工具。下面列出了用于评估器件性能、生成代码和开发解决方案的工具和软件。

7.1 第三方产品免责声明

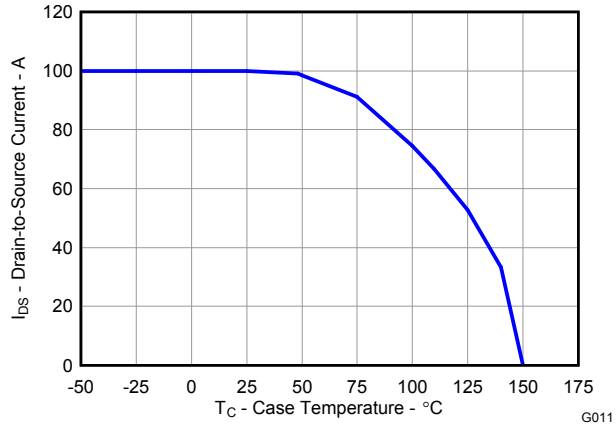
TI 发布的与第三方产品或服务有关的信息，不能构成与此类产品或服务或保修的适用性有关的认可，不能构成此类产品或服务单独或与任何 TI 产品或服务一起的表示或认可。

7.2 文档支持

7.2.1 相关文档

7.3 接收文档更新通知

要接收文档更新通知，请导航至 ti.com 上的器件产品文件夹。点击 [通知](#) 进行注册，即可每周接收产品信息更改摘要。有关更改的详细信息，请查看任何已修订文档中包含的修订历史记录。

7.4 支持资源

[TI E2E™ 中文支持论坛](#) 是工程师的重要参考资料，可直接从专家处获得快速、经过验证的解答和设计帮助。搜索现有解答或提出自己的问题，获得所需的快速设计帮助。

链接的内容由各个贡献者“按原样”提供。这些内容并不构成 TI 技术规范，并且不一定反映 TI 的观点；请参阅 TI 的 [使用条款](#)。

7.5 商标

NexFET™ and TI E2E™ are trademarks of Texas Instruments.

所有商标均为其各自所有者的财产。

7.6 静电放电警告



静电放电 (ESD) 会损坏这个集成电路。德州仪器 (TI) 建议通过适当的预防措施处理所有集成电路。如果不遵守正确的处理和安装程序，可能会损坏集成电路。

ESD 的损坏小至导致微小的性能降级，大至整个器件故障。精密的集成电路可能更容易受到损坏，这是因为非常细微的参数更改都可能会导致器件与其发布的规格不相符。

7.7 术语表

TI 术语表

本术语表列出并解释了术语、首字母缩略词和定义。

8

注：以前版本的页码可能与当前版本的页码不同

Changes from Revision G (September 2012) to Revision H (December 2024) Page

- 更新了整个文档中的表格、图和交叉参考的编号格式..... 1

Changes from Revision * (July 2010) to Revision A () Page

- 更改了 [图 6-5](#) 的 Y 轴标度..... 5

Changes from Revision F (October 2011) to Revision G (September 2012) Page

- 更改了 [图 6-10](#) 5

Changes from Revision E (July 2011) to Revision F (October 2011)	Page
• 将 $T_C = 25^\circ\text{C}$ 时的持续漏极电流 I_D 值从 100A 更改为 55A。.....	1
• 更改了图 6-10	5

Changes from Revision A (August 2010) to Revision B ()	Page
• 将 $R_{DS(on)}$ 测试条件从 $V_{GS} = 8\text{V}$ 更改为 : $V_{GS} = 10\text{V}$	3

Changes from Revision B (September 2010) to Revision C ()	Page
• 绝对最大额定值，将 E_{AS} 值从 45mJ 更改为 146mJ.....	1

Changes from Revision C (September 2010) to Revision D ()	Page
--	-------------

Changes from Revision D (November 2010) to Revision E ()	Page
• 将绝对最大额定值表中的 V_{GS} 从 +20/-12V 更改为 $\pm 20\text{V}$	1
• 从 +20/-12V 更改为 20V.....	3

9 机械数据

PACKAGING INFORMATION

Orderable part number	Status (1)	Material type (2)	Package Pins	Package qty Carrier	RoHS (3)	Lead finish/ Ball material (4)	MSL rating/ Peak reflow (5)	Op temp (°C)	Part marking (6)
CSD17510Q5A	Active	Production	VSONP (DQJ) 8	2500 LARGE T&R	ROHS Exempt	SN	Level-1-260C-UNLIM	-55 to 150	CSD17510

(1) **Status:** For more details on status, see our [product life cycle](#).

(2) **Material type:** When designated, preproduction parts are prototypes/experimental devices, and are not yet approved or released for full production. Testing and final process, including without limitation quality assurance, reliability performance testing, and/or process qualification, may not yet be complete, and this item is subject to further changes or possible discontinuation. If available for ordering, purchases will be subject to an additional waiver at checkout, and are intended for early internal evaluation purposes only. These items are sold without warranties of any kind.

(3) **RoHS values:** Yes, No, RoHS Exempt. See the [TI RoHS Statement](#) for additional information and value definition.

(4) **Lead finish/Ball material:** Parts may have multiple material finish options. Finish options are separated by a vertical ruled line. Lead finish/Ball material values may wrap to two lines if the finish value exceeds the maximum column width.

(5) **MSL rating/Peak reflow:** The moisture sensitivity level ratings and peak solder (reflow) temperatures. In the event that a part has multiple moisture sensitivity ratings, only the lowest level per JEDEC standards is shown. Refer to the shipping label for the actual reflow temperature that will be used to mount the part to the printed circuit board.

(6) **Part marking:** There may be an additional marking, which relates to the logo, the lot trace code information, or the environmental category of the part.

Multiple part markings will be inside parentheses. Only one part marking contained in parentheses and separated by a "-" will appear on a part. If a line is indented then it is a continuation of the previous line and the two combined represent the entire part marking for that device.

Important Information and Disclaimer:The information provided on this page represents TI's knowledge and belief as of the date that it is provided. TI bases its knowledge and belief on information provided by third parties, and makes no representation or warranty as to the accuracy of such information. Efforts are underway to better integrate information from third parties. TI has taken and continues to take reasonable steps to provide representative and accurate information but may not have conducted destructive testing or chemical analysis on incoming materials and chemicals. TI and TI suppliers consider certain information to be proprietary, and thus CAS numbers and other limited information may not be available for release.

In no event shall TI's liability arising out of such information exceed the total purchase price of the TI part(s) at issue in this document sold by TI to Customer on an annual basis.

TAPE AND REEL INFORMATION

QUADRANT ASSIGNMENTS FOR PIN 1 ORIENTATION IN TAPE



*All dimensions are nominal

Device	Package Type	Package Drawing	Pins	SPQ	Reel Diameter (mm)	Reel Width W1 (mm)	A0 (mm)	B0 (mm)	K0 (mm)	P1 (mm)	W (mm)	Pin1 Quadrant
CSD17510Q5A	VSONP	DQJ	8	2500	330.0	12.4	6.3	5.3	1.2	8.0	12.0	Q1

TAPE AND REEL BOX DIMENSIONS

*All dimensions are nominal

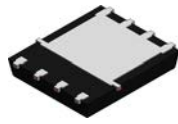
Device	Package Type	Package Drawing	Pins	SPQ	Length (mm)	Width (mm)	Height (mm)
CSD17510Q5A	VSONP	DQJ	8	2500	340.0	340.0	38.0



DQJ0008A

PACKAGE OUTLINE

VSONP - 1.1 mm max height

PLASTIC SMALL OUTLINE - NO LEAD

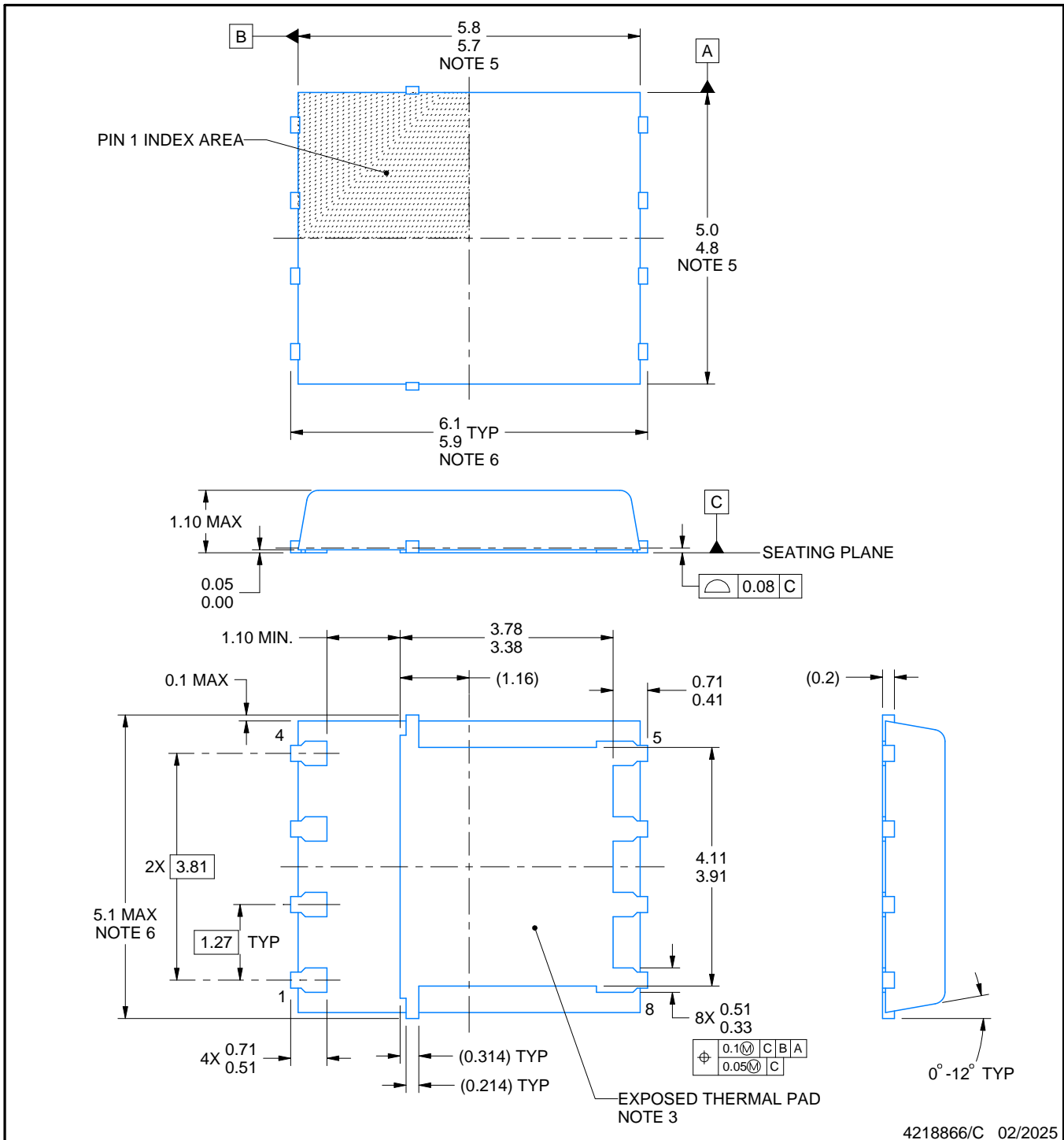

NOTES:

1. All linear dimensions are in millimeters. Any dimensions in parenthesis are for reference only. Dimensioning and tolerancing per ASME Y14.5M.
2. This drawing is subject to change without notice.
3. The package thermal pad must be soldered to the printed circuit board for thermal and mechanical performance.
4. Metalized features are supplier options and may not be on the package.
5. These dimensions do not include mold flash protrusions or gate burrs.
6. These dimensions include interterminal flash or protrusion. Interterminal flash or protrusion shall not exceed 0.25 mm per side.

EXAMPLE BOARD LAYOUT

DQJ0008A

VSONP - 1.1 mm max height

PLASTIC SMALL OUTLINE - NO LEAD

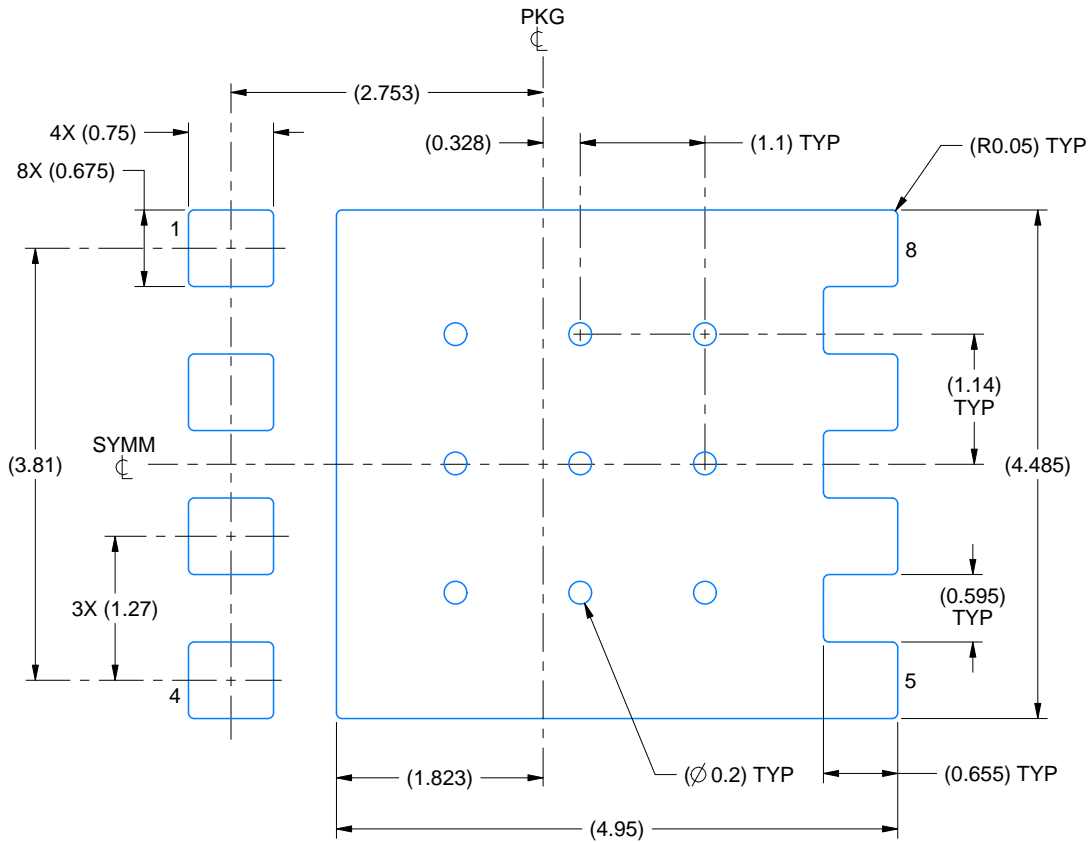

LAND PATTERN EXAMPLE
SOLDER MASK DEFINED
SCALE: 15X

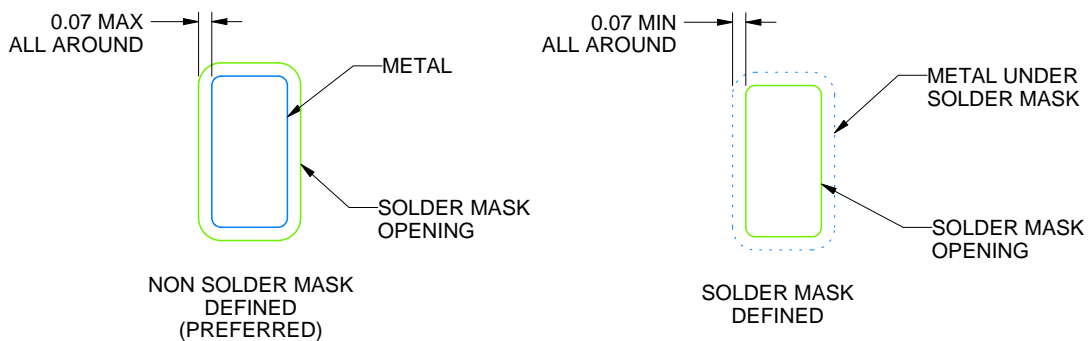

SOLDER MASK DETAILS

4218866/C 02/2025

NOTES: (continued)

7. This package is designed to be soldered to a thermal pad on the board. For more information, see Texas Instruments literature number SLUA271 (www.ti.com/lit/slua271).
8. Vias are optional depending on application, refer to device data sheet. If some or all are implemented, recommended via locations are shown.

EXAMPLE STENCIL DESIGN

DQJ0008A

VSONP - 1.1 mm max height

PLASTIC SMALL OUTLINE - NO LEAD

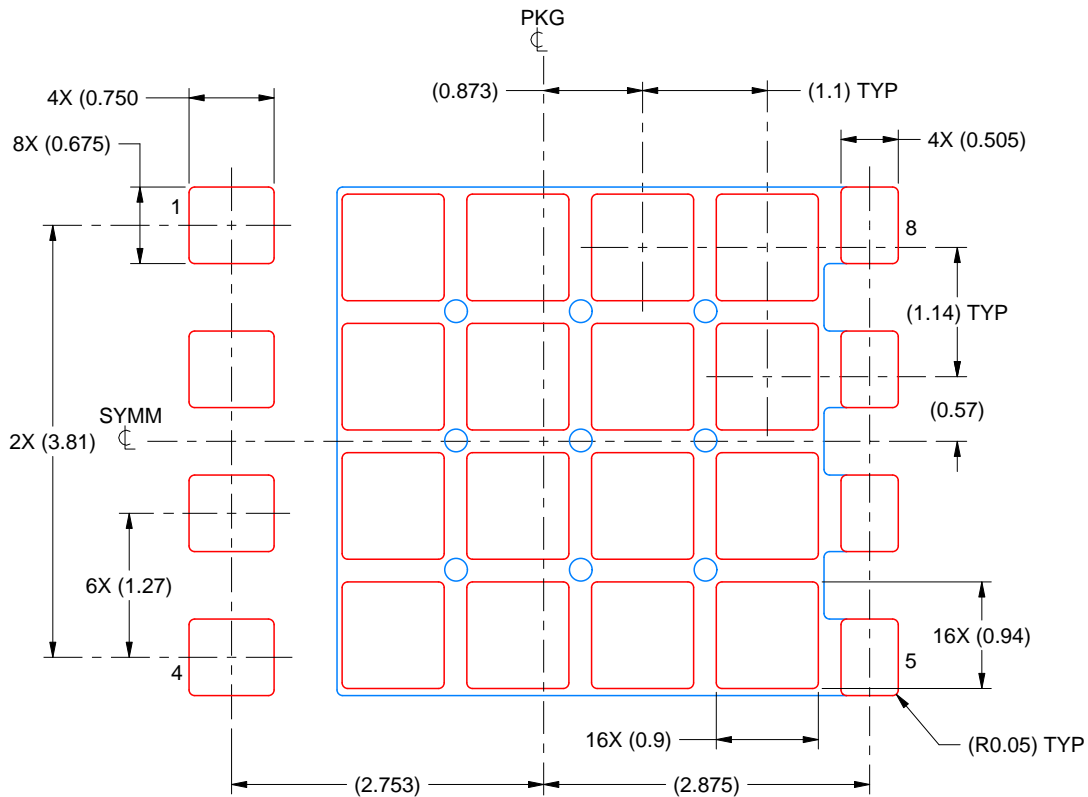

SOLDER PASTE EXAMPLE
BASED ON 0.125 mm THICK STENCIL

EXPOSED PAD:
70% PRINTED SOLDER COVERAGE BY AREA UNDER PACKAGE
SCALE: 15X

4218866/C 02/2025

NOTES: (continued)

9. Laser cutting apertures with trapezoidal walls and rounded corners may offer better paste release. IPC-7525 may have alternate design recommendations.

重要通知和免责声明

TI“按原样”提供技术和可靠性数据（包括数据表）、设计资源（包括参考设计）、应用或其他设计建议、网络工具、安全信息和其他资源，不保证没有瑕疵且不做任何明示或暗示的担保，包括但不限于对适销性、某特定用途方面的适用性或不侵犯任何第三方知识产权的暗示担保。

这些资源可供使用 TI 产品进行设计的熟练开发人员使用。您将自行承担以下全部责任：(1) 针对您的应用选择合适的 TI 产品，(2) 设计、验证并测试您的应用，(3) 确保您的应用满足相应标准以及任何其他功能安全、信息安全、监管或其他要求。

这些资源如有变更，恕不另行通知。TI 授权您仅可将这些资源用于研发本资源所述的 TI 产品的相关应用。严禁以其他方式对这些资源进行复制或展示。您无权使用任何其他 TI 知识产权或任何第三方知识产权。您应全额赔偿因在这些资源的使用中对 TI 及其代表造成的任何索赔、损害、成本、损失和债务，TI 对此概不负责。

TI 提供的产品受 [TI 的销售条款](#) 或 [ti.com](#) 上其他适用条款/TI 产品随附的其他适用条款的约束。TI 提供这些资源并不会扩展或以其他方式更改 TI 针对 TI 产品发布的适用的担保或担保免责声明。

TI 反对并拒绝您可能提出的任何其他或不同的条款。

邮寄地址：Texas Instruments, Post Office Box 655303, Dallas, Texas 75265
版权所有 © 2025，德州仪器 (TI) 公司