

# CSD17507Q5A 30-V N-Channel NexFET™ Power MOSFET

## 1 Features

- Ultra-Low  $Q_g$  and  $Q_{gd}$
- Low-Thermal Resistance
- Avalanche Rated
- Lead-Free Terminal Plating
- RoHS Compliant
- Halogen Free
- SON 5-mm x 6-mm Plastic Package

## 2 Applications

- Point-of-Load Synchronous Buck in Networking, Telecom and Computing Systems
- Optimized for Control FET Applications

## 3 Description

This 30-V, 9-m $\Omega$ , SON 5-mm x 6-mm NexFET™ power MOSFET has been designed to minimize losses in power conversion applications.

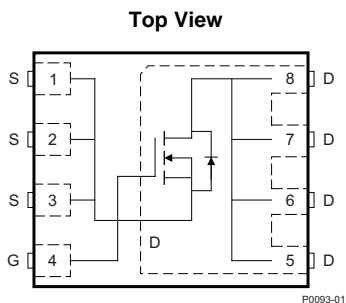

### Product Summary

$T_A = 25^\circ\text{C}$		TYPICAL VALUE		UNIT
$V_{DS}$	Drain-to-Source Voltage	30		V
$Q_g$	Gate Charge Total (4.5 V)	2.8		nC
$Q_{gd}$	Gate Charge Gate-to-Drain	0.7		nC
$R_{DS(on)}$	Drain-to-Source On Resistance	$V_{GS} = 4.5\text{ V}$	11.8	m $\Omega$
		$V_{GS} = 10\text{ V}$	9	
$V_{GS(th)}$	Threshold Voltage	1.6		V

### Device Information<sup>(1)</sup>

DEVICE	MEDIA	QTY	PACKAGE	SHIP
CSD17507Q5A	13-Inch Reel	2500	SON 5.00-mm x 6.00-mm Plastic Package	Tape and Reel
CSD17507Q5AT	7-Inch Reel	250		

(1) For all available packages, see the orderable addendum at the end of the data sheet.

### Absolute Maximum Ratings

$T_A = 25^\circ\text{C}$ (unless otherwise stated)		VALUE	UNIT
$V_{DS}$	Drain-to-Source Voltage	30	V
$V_{GS}$	Gate-to-Source Voltage	$\pm 20$	V
$I_D$	Continuous Drain Current	65	A
	Continuous Drain Current (Silicon Limited), $T_C = 25^\circ\text{C}$	61	
	Continuous Drain Current <sup>(1)</sup>	14	
$I_{DM}$	Pulsed Drain Current, $T_C = 25^\circ\text{C}$ <sup>(2)</sup>	163	A
$P_D$	Power Dissipation <sup>(1)</sup>	3.1	W
	Power Dissipation, $T_C = 25^\circ\text{C}$	39	
$T_J, T_{STG}$	Operating Junction, Storage Temperature	-55 to 150	$^\circ\text{C}$
$E_{AS}$	Avalanche Energy, Single Pulse $I_D = 30\text{ A}, L = 0.1\text{ mH}, R_G = 25\ \Omega$	45	mJ

- (1) Typical  $R_{\theta JA} = 40^\circ\text{C/W}$  on a 1-in<sup>2</sup>, 2-oz Cu pad on a 0.06-in thick FR4 PCB.
- (2) Max  $R_{\theta JC} = 2^\circ\text{C/W}$ , pulse duration  $\leq 100\ \mu\text{s}$ , duty cycle  $\leq 1\%$ .

$R_{DS(on)}$  vs  $V_{GS}$

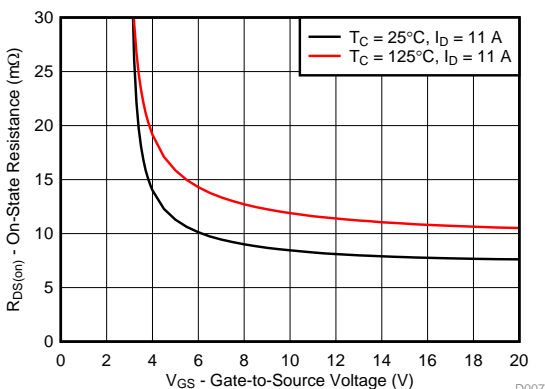

Gate Charge

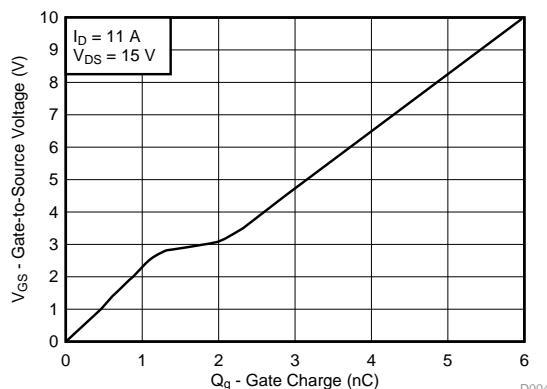

## Table of Contents

<b>1 Features</b> ..... 1 <b>2 Applications</b> ..... 1 <b>3 Description</b> ..... 1 <b>4 Revision History</b> ..... 2 <b>5 Specifications</b> ..... 4 5.1 Electrical Characteristics ..... 4 5.2 Thermal Information ..... 4 5.3 Typical MOSFET Characteristics ..... 5 <b>6 Device and Documentation Support</b> ..... 8 6.1 Receiving Notification of Documentation Updates... 8	6.2 Community Resources ..... 8 6.3 Trademarks ..... 8 6.4 Electrostatic Discharge Caution ..... 8 6.5 Glossary ..... 8 <b>7 Mechanical, Packaging, and Orderable Information</b> ..... 9 7.1 Q5A Package Dimensions ..... 9 7.2 Recommended PCB Pattern ..... 10 7.3 Recommended Stencil Opening ..... 11 7.4 Q5A Tape and Reel Information ..... 11
--	---

## 4 Revision History

NOTE: Page numbers for previous revisions may differ from page numbers in the current version.

### Changes from Revision F (November 2016) to Revision G Page

- Corrected package size in the *Description* section ..... 1

### Changes from Revision E (July 2011) to Revision F Page

- Changed *Description* text. .... 1
- Added silicon limited continuous drain current to *Absolute Maximum Ratings* table. .... 1
- Changed Note 2 in *Absolute Maximum Ratings* table. .... 1
- Changed *THERMAL CHARACTERISTICS* table to *Thermal Information* table. .... 4
- Changed  $R_{\theta JC}$  from 1.9°C/W : to 2.1°C/W. .... 4
- Changed  $R_{\theta JA}$  from 51°C/W : to 50°C/W. .... 4
- Added *Device and Documentation Support* section. .... 8
- Changed *MECHANICAL DATA* section to *Mechanical, Packaging, and Orderable Information* section. .... 9

### Changes from Revision D (December 2010) to Revision E Page

- Changed  $V_{GS}$  in the Abs Max Ratings table From: +20/-12 V To:  $\pm 20$  V. .... 1
- Changed  $I_{GSS}$  Test Conditions from  $V_{GS} = 20$  V +20/-12 V : to  $V_{GS} = 20$  V. .... 4

### Changes from Revision C (November 2010) to Revision D Page

- Changed  $g_{fs}$  Transconductance TYP value From: 16 S To: 44 S. .... 4

### Changes from Revision B (September 2010) to Revision C Page

- Added Stencil Recommendation illustration. .... 11

### Changes from Revision A (August 2010) to Revision B Page

- Absolute Maximum Ratings, changed the  $E_{AS}$  value from 145 to 45 mJ. .... 1

---

**Changes from Original (July 2010) to Revision A****Page**

- 
- Changed the Y axis scale for [Figure 5](#). ..... **5**
-

## 5 Specifications

### 5.1 Electrical Characteristics

 $T_A = 25^\circ\text{C}$  (unless otherwise stated)

PARAMETER		TEST CONDITIONS	MIN	TYP	MAX	UNIT
<b>STATIC CHARACTERISTICS</b>						
$BV_{DSS}$	Drain-to-source voltage	$V_{GS} = 0\text{ V}, I_{DS} = 250\ \mu\text{A}$	30			V
$I_{DSS}$	Drain-to-source leakage current	$V_{GS} = 0\text{ V}, V_{DS} = 24\text{ V}$			1	$\mu\text{A}$
$I_{GSS}$	Gate-to-source leakage current	$V_{DS} = 0\text{ V}, V_{GS} = 20\text{ V}$			100	nA
$V_{GS(th)}$	Gate-to-source threshold voltage	$V_{DS} = V_{GS}, I_{DS} = 250\ \mu\text{A}$	1.1	1.6	2.1	V
$R_{DS(on)}$	Drain-to-source on resistance	$V_{GS} = 4.5\text{ V}, I_{DS} = 11\text{ A}$		11.8	16.1	m $\Omega$
		$V_{GS} = 10\text{ V}, I_{DS} = 11\text{ A}$		9.0	10.8	
$g_{fs}$	Transconductance	$V_{DS} = 15\text{ V}, I_{DS} = 11\text{ A}$		44		S
<b>DYNAMIC CHARACTERISTICS</b>						
$C_{iss}$	Input capacitance	$V_{GS} = 0\text{ V}, V_{DS} = 15\text{ V},$ $f = 1\text{ MHz}$		410	530	pF
$C_{oss}$	Output capacitance			270	350	pF
$C_{rss}$	Reverse transfer capacitance			23	30	pF
$R_G$	Series gate resistance			0.7	1.4	$\Omega$
$Q_g$	Gate charge total (4.5 V)	$V_{DS} = 15\text{ V}, I_{DS} = 11\text{ A}$		2.8	3.6	nC
$Q_{gd}$	Gate charge gate-to-drain			0.7		nC
$Q_{gs}$	Gate charge gate-to-source			1.3		nC
$Q_{g(th)}$	Gate charge at $V_{th}$			0.7		nC
$Q_{oss}$	Output charge	$V_{DS} = 13\text{ V}, V_{GS} = 0\text{ V}$		7.2		nC
$t_{d(on)}$	Turnon delay time	$V_{DS} = 15\text{ V}, V_{GS} = 4.5\text{ V},$ $I_{DS} = 11\text{ A}, R_G = 2\ \Omega$		4.7		ns
$t_r$	Rise time			5.2		ns
$t_{d(off)}$	Turnoff delay time			5.7		ns
$t_f$	Fall time			2.3		ns
<b>DIODE CHARACTERISTICS</b>						
$V_{SD}$	Diode forward voltage	$I_{SD} = 11\text{ A}, V_{GS} = 0\text{ V}$		0.85	1	V
$Q_{rr}$	Reverse recovery charge	$V_{DS} = 13\text{ V}, I_F = 11\text{ A}, di/dt = 300\text{ A}/\mu\text{s}$		11		nC
$t_{rr}$	Reverse recovery time			16		ns

### 5.2 Thermal Information

 $T_A = 25^\circ\text{C}$  (unless otherwise stated)

PARAMETER		MIN	TYP	MAX	UNIT
$R_{\theta JC}$	Thermal resistance junction-to-case <sup>(1)</sup>			2.1	$^\circ\text{C}/\text{W}$
$R_{\theta JA}$	Thermal resistance junction-to-ambient <sup>(1)(2)</sup>			50	$^\circ\text{C}/\text{W}$

- (1)  $R_{\theta JC}$  is determined with the device mounted on a 1-in<sup>2</sup> (6.45-cm<sup>2</sup>), 2-oz (0.071-mm) thick Cu pad on a 1.5-in × 1.5-in (3.81-cm × 3.81-cm), 0.06-in (1.52-mm) thick FR4 PCB.  $R_{\theta JC}$  is specified by design, whereas  $R_{\theta JA}$  is determined by the user's board design.
- (2) Device mounted on FR4 material with 1-in<sup>2</sup> (6.45-cm<sup>2</sup>), 2-oz (0.071-mm) thick Cu.

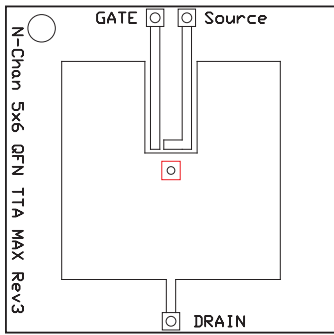

M0137-01

Max  $R_{\theta JA} = 50^{\circ}\text{C/W}$   
when mounted on 1 in<sup>2</sup>  
(6.45 cm<sup>2</sup>) of 2-oz  
(0.071-mm) thick Cu.

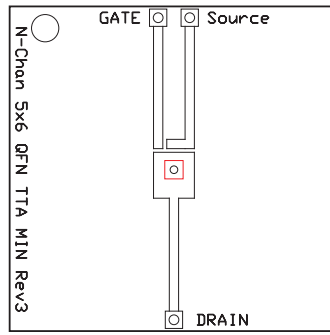

M0137-02

Max  $R_{\theta JA} = 125^{\circ}\text{C/W}$   
when mounted on a  
minimum pad area of  
2-oz (0.071-mm) thick  
Cu.

### 5.3 Typical MOSFET Characteristics

$T_A = 25^{\circ}\text{C}$  (unless otherwise stated)

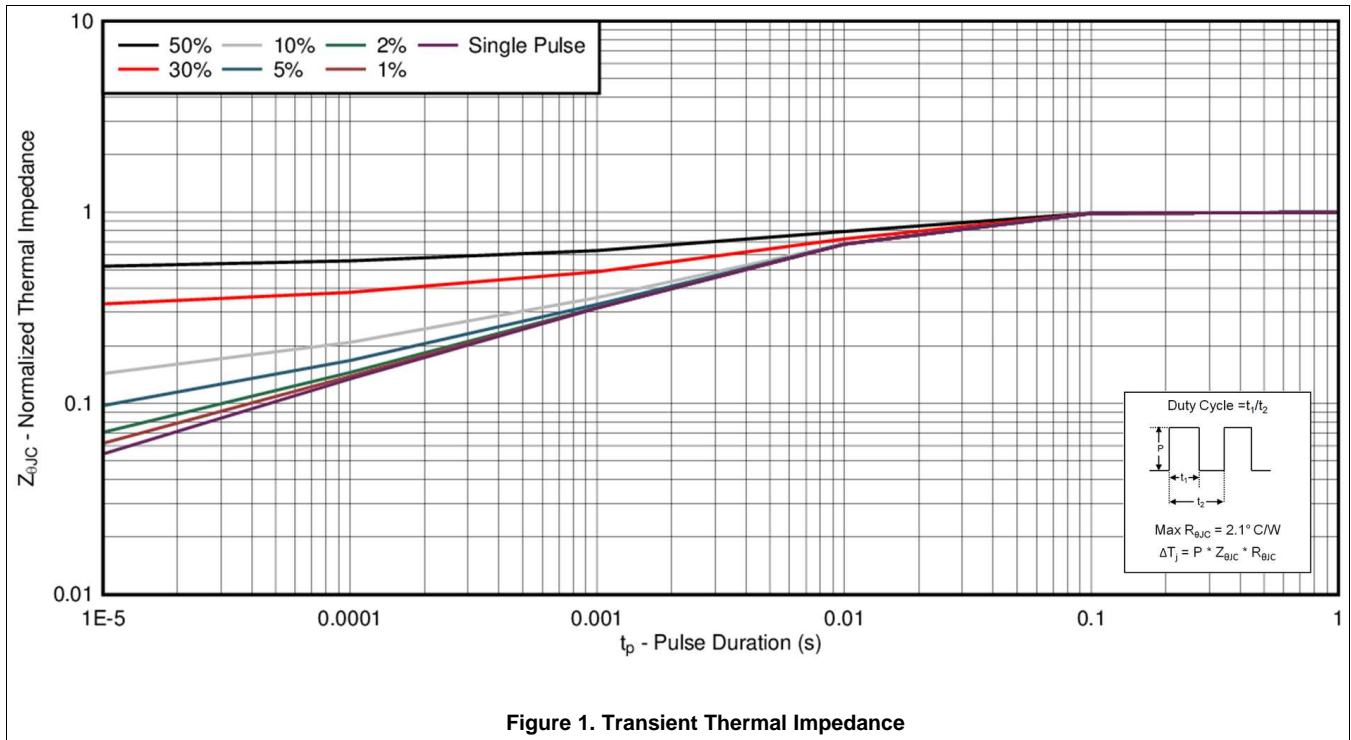
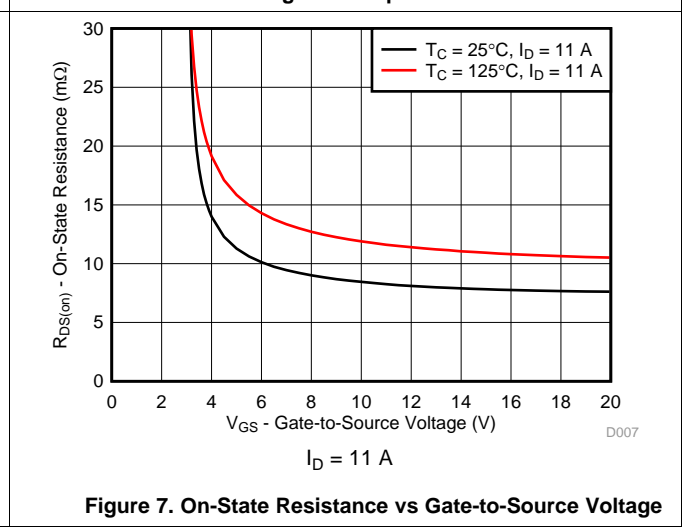
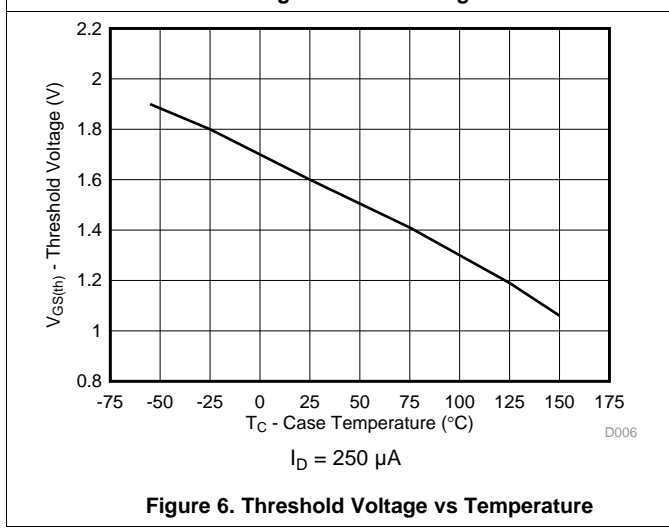
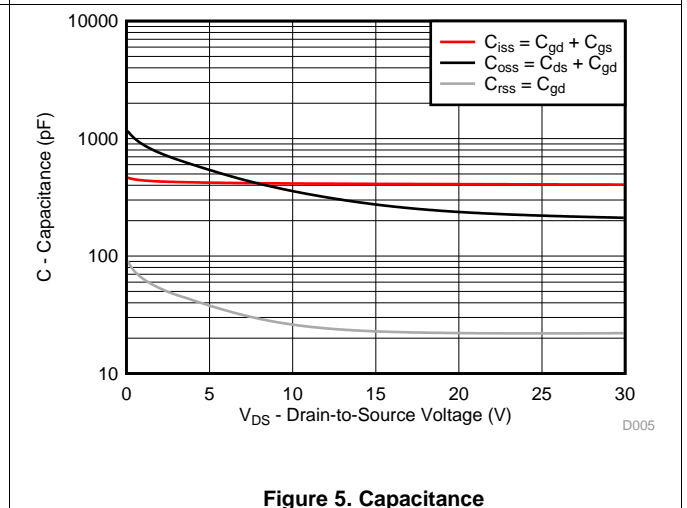
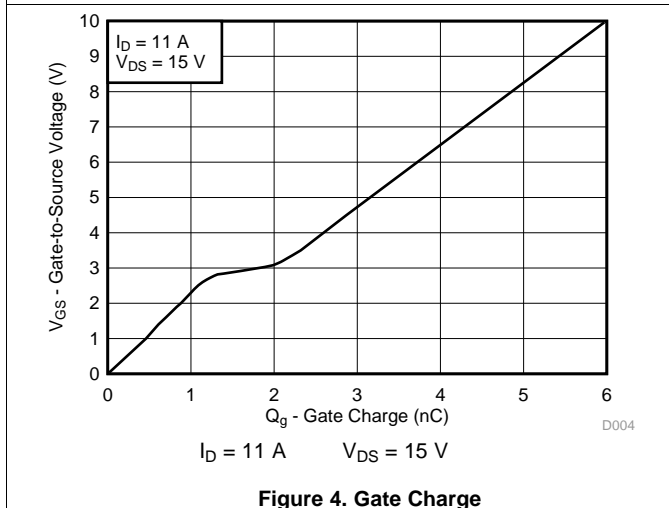
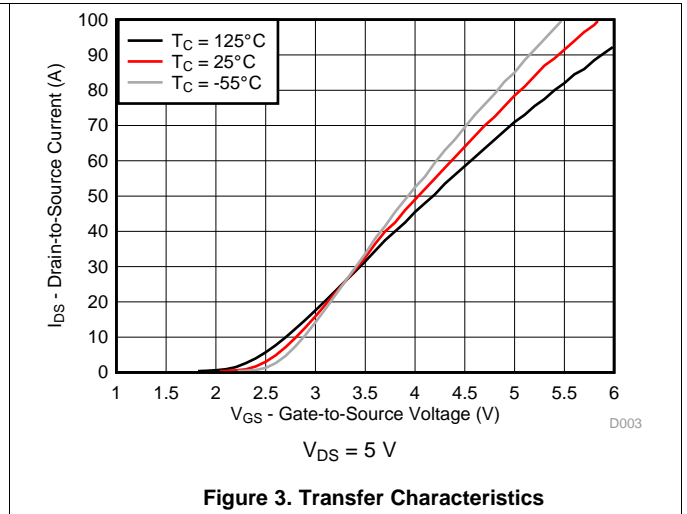
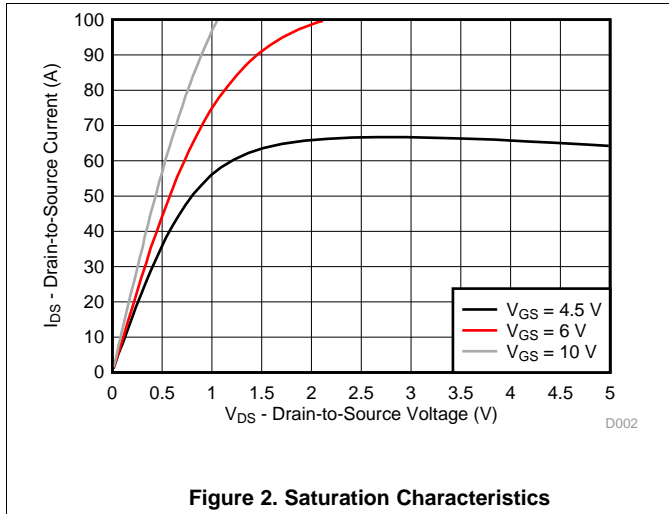

Figure 1. Transient Thermal Impedance

Typical MOSFET Characteristics (continued)

T<sub>A</sub> = 25°C (unless otherwise stated)



Typical MOSFET Characteristics (continued)

T<sub>A</sub> = 25°C (unless otherwise stated)

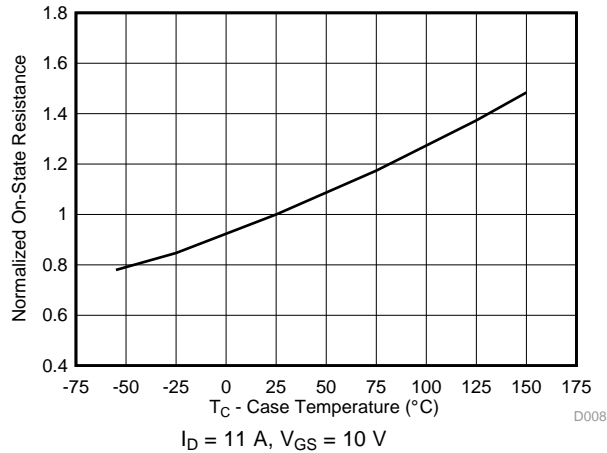

Figure 8. Normalized On-State Resistance vs Temperature

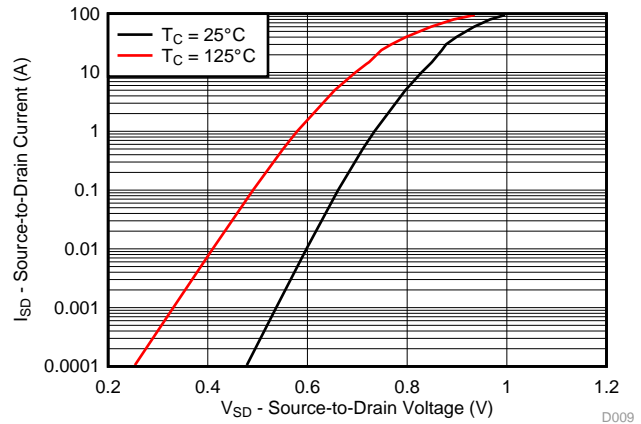

Figure 9. Typical Diode Forward Voltage

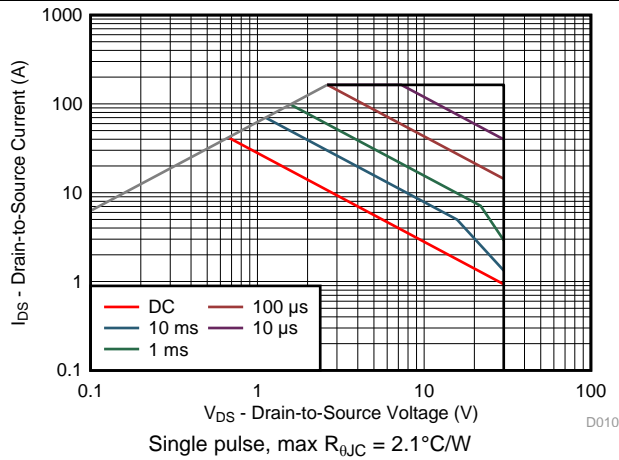

Figure 10. Maximum Safe Operating Area

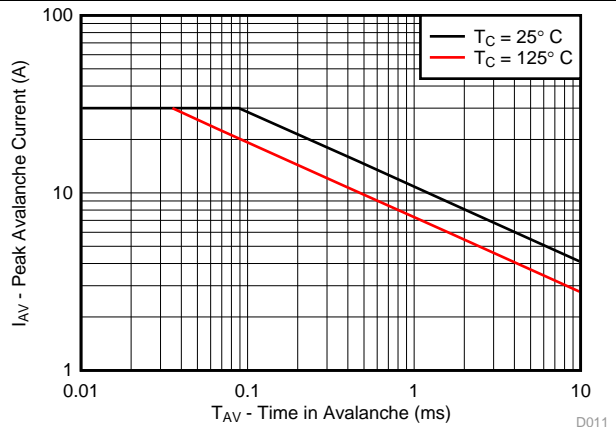

Figure 11. Single Pulse Unclamped Inductive Switching

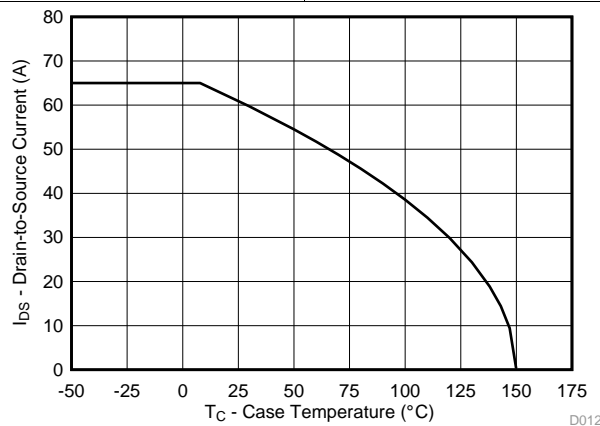

Figure 12. Maximum Drain Current vs Temperature

## 6 Device and Documentation Support

### 6.1 Receiving Notification of Documentation Updates

To receive notification of documentation updates, navigate to the device product folder on ti.com. In the upper right corner, click on *Alert me* to register and receive a weekly digest of any product information that has changed. For change details, review the revision history included in any revised document.

### 6.2 Community Resources

The following links connect to TI community resources. Linked contents are provided "AS IS" by the respective contributors. They do not constitute TI specifications and do not necessarily reflect TI's views; see TI's [Terms of Use](#).

**TI E2E™ Online Community** *TI's Engineer-to-Engineer (E2E) Community*. Created to foster collaboration among engineers. At e2e.ti.com, you can ask questions, share knowledge, explore ideas and help solve problems with fellow engineers.

**Design Support** *TI's Design Support* Quickly find helpful E2E forums along with design support tools and contact information for technical support.

### 6.3 Trademarks

NexFET, E2E are trademarks of Texas Instruments.  
All other trademarks are the property of their respective owners.

### 6.4 Electrostatic Discharge Caution



These devices have limited built-in ESD protection. The leads should be shorted together or the device placed in conductive foam during storage or handling to prevent electrostatic damage to the MOS gates.

### 6.5 Glossary

[SLYZ022](#) — *TI Glossary*.

This glossary lists and explains terms, acronyms, and definitions.



## 7 Mechanical, Packaging, and Orderable Information

The following pages include mechanical, packaging, and orderable information. This information is the most current data available for the designated devices. This data is subject to change without notice and revision of this document. For browser-based versions of this data sheet, refer to the left-hand navigation.

### 7.1 Q5A Package Dimensions

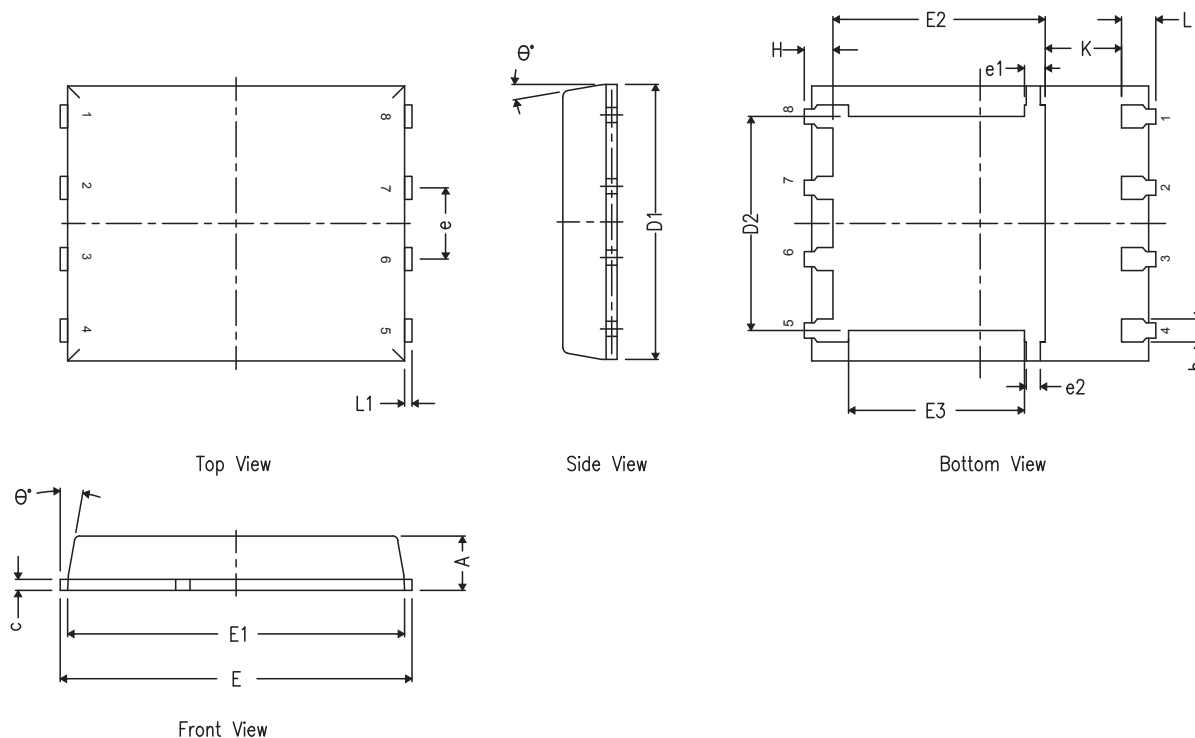

DIM	MILLIMETERS		
	MIN	NOM	MAX
A	0.90	1.00	1.10
b	0.33	0.41	0.51
c	0.20	0.25	0.34
D1	4.80	4.90	5.00
D2	3.61	3.81	4.02
E	5.90	6.00	6.10
E1	5.70	5.75	5.80
E2	3.38	3.58	3.78
E3	3.03	3.13	3.23
e	1.17	1.27	1.37
e1	0.27	0.37	0.47
e2	0.15	0.25	0.35
H	0.41	0.56	0.71
K	1.10	—	—
L	0.51	0.61	0.71
L1	0.06	0.13	0.20
$\theta$	0°	—	12°

## 7.2 Recommended PCB Pattern

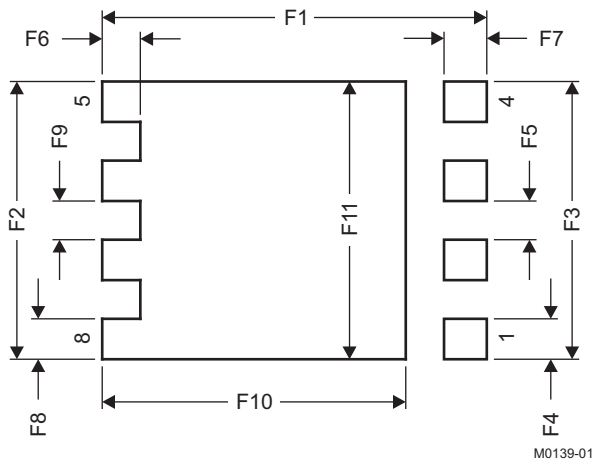

DIM	MILLIMETERS		INCHES	
	MIN	MAX	MIN	MAX
F1	6.205	6.305	0.244	0.248
F2	4.46	4.56	0.176	0.18
F3	4.46	4.56	0.176	0.18
F4	0.65	0.7	0.026	0.028
F5	0.62	0.67	0.024	0.026
F6	0.63	0.68	0.025	0.027
F7	0.7	0.8	0.028	0.031
F8	0.65	0.7	0.026	0.028
F9	0.62	0.67	0.024	0.026
F10	4.9	5	0.193	0.197
F11	4.46	4.56	0.176	0.18

For recommended circuit layout for PCB designs, see [Reducing Ringing Through PCB Layout Techniques \(SLPA005\)](#).

### 7.3 Recommended Stencil Opening

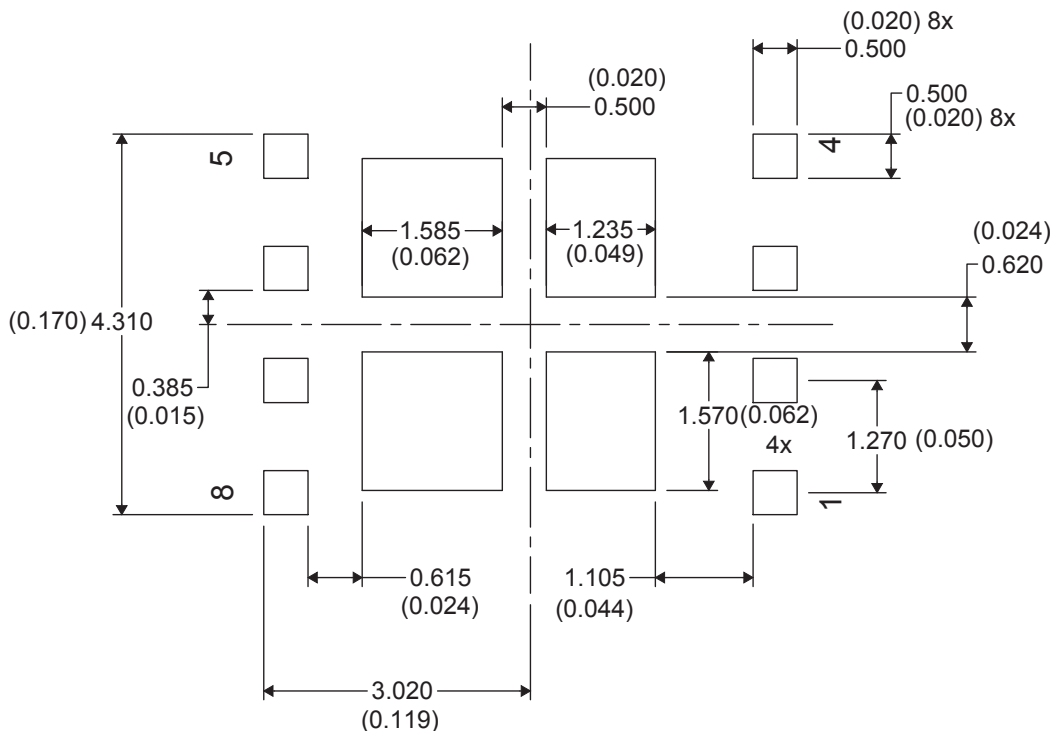

### 7.4 Q5A Tape and Reel Information

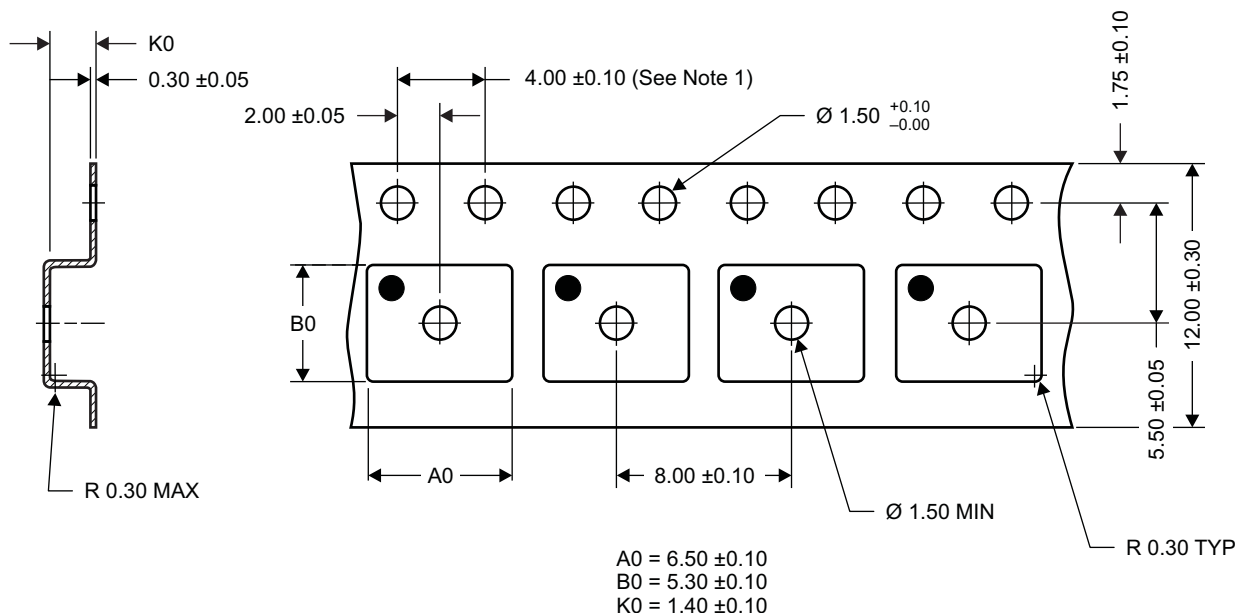

M0138-01

**Notes:**

1. 10-sprocket hole-pitch cumulative tolerance  $\pm 0.2$ .
2. Camber not to exceed 1 mm in 100 mm, noncumulative over 250 mm.
3. Material: black static-dissipative polystyrene.
4. All dimensions are in mm (unless otherwise specified).
5. A0 and B0 measured on a plane 0.3 mm above the bottom of the pocket.

**PACKAGING INFORMATION**

Orderable part number	Status (1)	Material type (2)	Package   Pins	Package qty   Carrier	RoHS (3)	Lead finish/ Ball material (4)	MSL rating/ Peak reflow (5)	Op temp (°C)	Part marking (6)
<a href="#">CSD17507Q5A</a>	Active	Production	VSONP (DQJ)   8	2500   LARGE T&R	ROHS Exempt	SN	Level-1-260C-UNLIM	-55 to 150	CSD17507
CSD17507Q5A.Z	Active	Production	VSONP (DQJ)   8	2500   LARGE T&R	ROHS Exempt	SN	Level-1-260C-UNLIM	-55 to 150	CSD17507
<a href="#">CSD17507Q5AT</a>	Active	Production	VSONP (DQJ)   8	250   SMALL T&R	ROHS Exempt	SN	Level-1-260C-UNLIM	-55 to 150	CSD17507
CSD17507Q5AT.Z	Active	Production	VSONP (DQJ)   8	250   SMALL T&R	ROHS Exempt	SN	Level-1-260C-UNLIM	-55 to 150	CSD17507

(1) **Status:** For more details on status, see our [product life cycle](#).

(2) **Material type:** When designated, preproduction parts are prototypes/experimental devices, and are not yet approved or released for full production. Testing and final process, including without limitation quality assurance, reliability performance testing, and/or process qualification, may not yet be complete, and this item is subject to further changes or possible discontinuation. If available for ordering, purchases will be subject to an additional waiver at checkout, and are intended for early internal evaluation purposes only. These items are sold without warranties of any kind.

(3) **RoHS values:** Yes, No, RoHS Exempt. See the [TI RoHS Statement](#) for additional information and value definition.

(4) **Lead finish/Ball material:** Parts may have multiple material finish options. Finish options are separated by a vertical ruled line. Lead finish/Ball material values may wrap to two lines if the finish value exceeds the maximum column width.

(5) **MSL rating/Peak reflow:** The moisture sensitivity level ratings and peak solder (reflow) temperatures. In the event that a part has multiple moisture sensitivity ratings, only the lowest level per JEDEC standards is shown. Refer to the shipping label for the actual reflow temperature that will be used to mount the part to the printed circuit board.

(6) **Part marking:** There may be an additional marking, which relates to the logo, the lot trace code information, or the environmental category of the part.

Multiple part markings will be inside parentheses. Only one part marking contained in parentheses and separated by a "~" will appear on a part. If a line is indented then it is a continuation of the previous line and the two combined represent the entire part marking for that device.

**Important Information and Disclaimer:** The information provided on this page represents TI's knowledge and belief as of the date that it is provided. TI bases its knowledge and belief on information provided by third parties, and makes no representation or warranty as to the accuracy of such information. Efforts are underway to better integrate information from third parties. TI has taken and continues to take reasonable steps to provide representative and accurate information but may not have conducted destructive testing or chemical analysis on incoming materials and chemicals. TI and TI suppliers consider certain information to be proprietary, and thus CAS numbers and other limited information may not be available for release.

In no event shall TI's liability arising out of such information exceed the total purchase price of the TI part(s) at issue in this document sold by TI to Customer on an annual basis.

## IMPORTANT NOTICE AND DISCLAIMER

TI PROVIDES TECHNICAL AND RELIABILITY DATA (INCLUDING DATA SHEETS), DESIGN RESOURCES (INCLUDING REFERENCE DESIGNS), APPLICATION OR OTHER DESIGN ADVICE, WEB TOOLS, SAFETY INFORMATION, AND OTHER RESOURCES "AS IS" AND WITH ALL FAULTS, AND DISCLAIMS ALL WARRANTIES, EXPRESS AND IMPLIED, INCLUDING WITHOUT LIMITATION ANY IMPLIED WARRANTIES OF MERCHANTABILITY, FITNESS FOR A PARTICULAR PURPOSE OR NON-INFRINGEMENT OF THIRD PARTY INTELLECTUAL PROPERTY RIGHTS.

These resources are intended for skilled developers designing with TI products. You are solely responsible for (1) selecting the appropriate TI products for your application, (2) designing, validating and testing your application, and (3) ensuring your application meets applicable standards, and any other safety, security, regulatory or other requirements.

These resources are subject to change without notice. TI grants you permission to use these resources only for development of an application that uses the TI products described in the resource. Other reproduction and display of these resources is prohibited. No license is granted to any other TI intellectual property right or to any third party intellectual property right. TI disclaims responsibility for, and you will fully indemnify TI and its representatives against, any claims, damages, costs, losses, and liabilities arising out of your use of these resources.

TI's products are provided subject to [TI's Terms of Sale](#) or other applicable terms available either on [ti.com](https://www.ti.com) or provided in conjunction with such TI products. TI's provision of these resources does not expand or otherwise alter TI's applicable warranties or warranty disclaimers for TI products.

TI objects to and rejects any additional or different terms you may have proposed.

Mailing Address: Texas Instruments, Post Office Box 655303, Dallas, Texas 75265

Copyright © 2025, Texas Instruments Incorporated