

# CD4011A, CD4012A, CD4023A Types

## CMOS NAND Gates

- Quad 2 Input – CD4011A
- Dual 4 Input – CD4012A
- Triple 3 Input – CD4023A

The TI-CD4011A, CD4012A, and CD-4023A NAND gates provide the system designer with direct implementation of the NAND function and supplement the existing family of CMOS gates.

These types are supplied in 14-lead hermetic dual-in-line ceramic packages (D and F suffixes), 14-lead dual-in-line plastic packages (E suffix), 14-lead ceramic flat packages (K suffix), and in chip form (H suffix).

### Features:

- Quiescent current specified to 15  $\mu$ A
- Maximum input leakage of 1  $\mu$ A at 15 V (full package-temperature range)
- 1-V noise margin (full package-temperature range)

### RECOMMENDED OPERATING CONDITIONS

For maximum reliability, nominal operating conditions should be selected so that operation is always within the following ranges:

Characteristic	Min.	Max.	Units
Supply Voltage Range (over full package temperature range)	3	12	V

### MAXIMUM RATINGS, Absolute-Maximum Values:

- STORAGE-TEMPERATURE RANGE ( $T_{stg}$ ) ..... -65 to +150°C
- OPERATING-TEMPERATURE RANGE ( $T_A$ ):
  - PACKAGE TYPES D, F, K, H ..... -55 to +125°C
  - PACKAGE TYPE E ..... -40 to +85°C
- DC SUPPLY-VOLTAGE RANGE, ( $V_{DD}$ ) (Voltages referenced to  $V_{SS}$  Terminal) ..... -0.5 to +15 V
- POWER DISSIPATION PER PACKAGE ( $P_D$ ):
  - FOR  $T_A = -40$  to +60°C (PACKAGE TYPE E) ..... 500 mW
  - FOR  $T_A = +60$  to +85°C (PACKAGE TYPE E) ..... Derate Linearly at 12 mW/°C to 200 mW
  - FOR  $T_A = -55$  to +100°C (PACKAGE TYPES D, F, K) ..... 500 mW
  - FOR  $T_A = +100$  to +125°C (PACKAGE TYPES D, F, K) ..... Derate Linearly at 12 mW/°C to 200 mW
- DEVICE DISSIPATION PER OUTPUT TRANSISTOR
  - FOR  $T_A =$  FULL PACKAGE-TEMPERATURE RANGE (ALL PACKAGE TYPES) ..... 100 mW
- INPUT VOLTAGE RANGE, ALL INPUTS ..... -0.5 to  $V_{DD} + 0.5$  V
- LEAD TEMPERATURE (DURING SOLDERING):
  - At distance 1/16  $\pm$  1/32 inch (1.59  $\pm$  0.79 mm) from case for 10 s max. .... +265°C

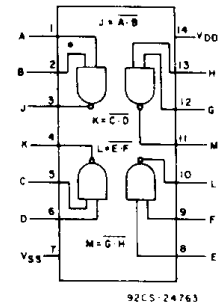

CD4011A

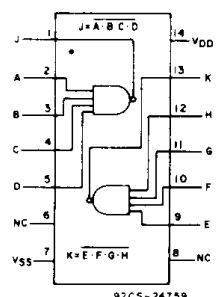

CD4012A

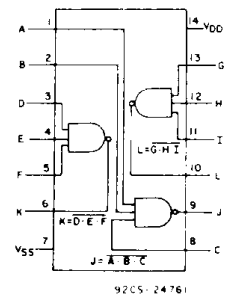

CD4023AH

Fig. 1 – Functional diagrams.

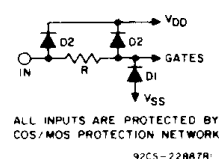

92CS-22887R

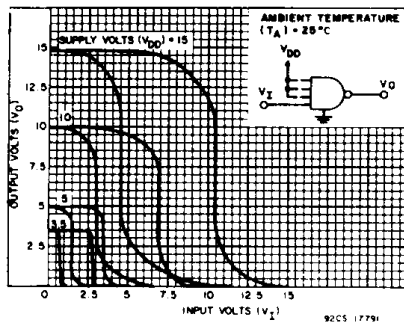

Fig. 2 – Minimum & maximum voltage transfer characteristics.

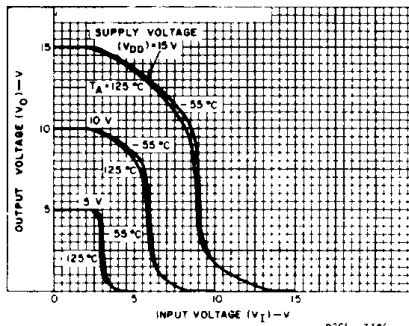

Fig. 3 – Typical voltage transfer characteristics as a function of temperature.

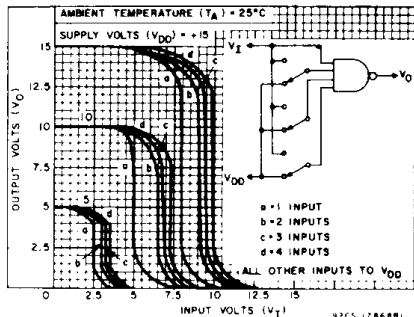

Fig. 4 – Typical multiple input switching transfer characteristics for CD4012A.

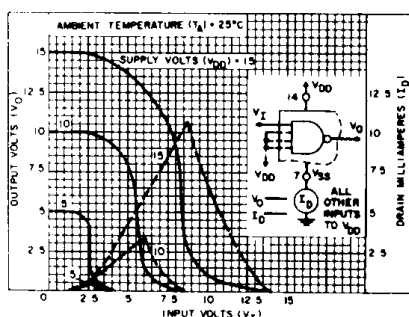

Fig. 5 – Typical current & voltage transfer characteristics.

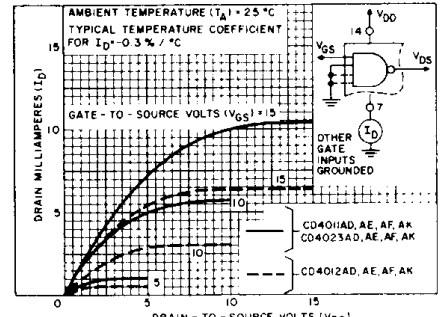

Fig. 6 – Typical n-channel drain characteristics.

# CD4011A, CD4012A, CD4023A Types

## STATIC ELECTRICAL CHARACTERISTICS

Characteristic	Conditions			Limits at Indicated Temperatures (°C)								Units
	V <sub>O</sub> (V)	V <sub>IN</sub> (V)	V <sub>DD</sub> (V)	D, F, K, H Packages				E Package				
				-55	+25		+125	-40	+25		+85	
				Typ.	Limit			Typ.	Limit			
Quiescent Device Current, I <sub>L</sub> Max.	-	-	5	0.05	0.001	0.05	3	0.5	0.005	0.5	15	μA
	-	-	10	0.1	0.001	0.1	6	5	0.005	5	30	
	-	-	15	2	0.02	2	40	50	0.5	50	500	
Output Voltage: Low-Level V <sub>OL</sub>	-	0, 5	5	0 Typ.; 0.05 Max.								V
High Level, V <sub>OH</sub>	-	0, 10	10	4.95 Min.; 5 Typ.								
	-	0, 10	10	9.95 Min.; 10 Typ.								
Noise Immunity: Inputs Low, V <sub>NL</sub>	3.6	-	5	1.5 Min.; 2.25 Typ.								V
	7.2	-	10	3 Min.; 4.5 Typ.								
Inputs High, V <sub>NH</sub>	1.4	-	5	1.5 Min.; 2.25 Typ.;								
	2.8	-	10	3 Min.; 4.5 Typ.								
Noise Margin: Inputs Low, V <sub>NML</sub>	4.5	-	5	1 Min.								V
	9	-	10	1 Min.								
Inputs High, V <sub>NMH</sub>	0.5	-	5	1 Min.								
	1	-	10	1 Min.								
Output Drive Current: N-Channel (Sink) I <sub>DN</sub> Min.												mA
CD4011A	0.5	-	5	0.31	0.5	0.25	0.175	0.145	0.5	0.12	0.095	
CD4023A	0.5	-	10	0.62	0.6	0.5	0.35	0.3	0.6	0.25	0.2	
CD4012A	0.5	-	5	0.15	0.25	0.12	0.085	0.072	0.25	0.06	0.05	
	0.5	-	10	0.31	0.6	0.25	0.175	0.155	0.6	0.13	0.105	
P-Channel (Source) I <sub>DP</sub> Min.												mA
All Types	4.5	-	5	-0.31	-0.5	-0.25	-0.175	-0.145	-0.5	-0.12	-0.095	
	9.5	-	10	-0.75	-1.2	-0.6	-0.4	-0.35	-1.2	-0.3	-0.24	
Input Leakage Current, I <sub>L</sub> , I <sub>IH</sub>	Any Input		15	±10 <sup>-5</sup> Typ.; ±1 Max.								μA

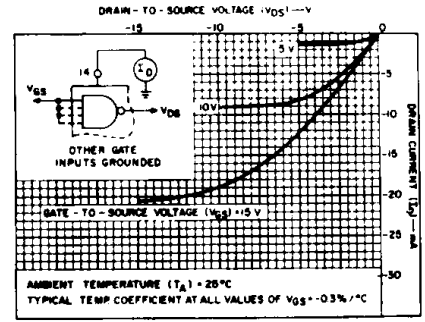

Fig. 7 - Typical p-channel drain characteristics.

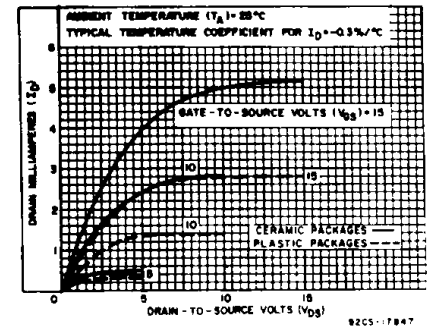

Fig. 8 - Minimum n-channel drain characteristics - CD4011A & CD4023A.

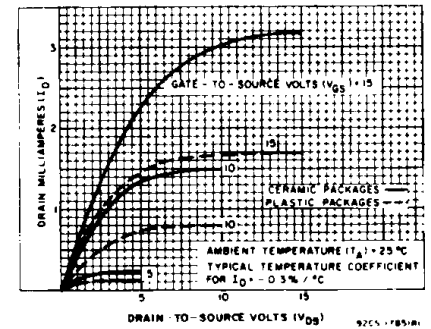

Fig. 9 - Minimum n-channel drain characteristics.

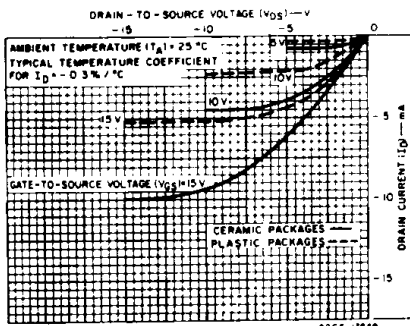

Fig. 10 - Minimum p-channel drain characteristics.

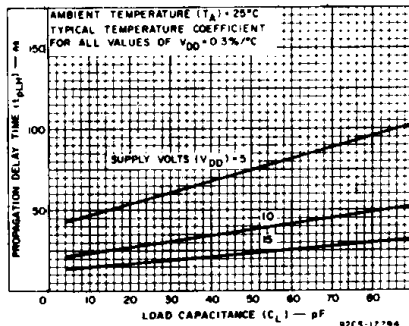

Fig. 11 - Typical low-to-high level propagation delay time vs. C<sub>L</sub>.

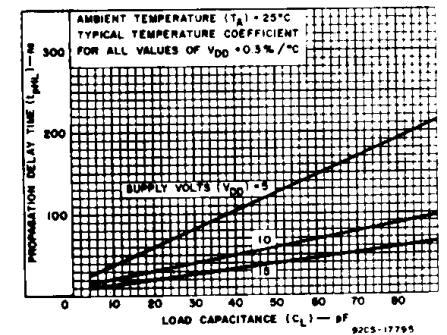

Fig. 12 - Typical high-to-low level propagation delay time vs. C<sub>L</sub> - CD4011A, & CD4023A.

# CD4011A, CD4012A, CD4023A Types

DYNAMIC ELECTRICAL CHARACTERISTICS at  $T_A = 25^\circ\text{C}$ ,  $C_L = 15\text{ pF}$ , Input  $t_r, t_f = 20\text{ ns}$ ,  $R_L = 200\text{ k}\Omega$

CHARACTERISTICS	TEST CONDITIONS	LIMITS				UNITS	
		D, F, K, H Packages		E Package			
		V <sub>DD</sub> (V)	Typ.	Max.	Typ.		Max.
Propagation Delay Time: Low-to-High Level, $t_{PLH}$		5	50	75	50	100	ns
		10	25	40	25	50	
High-to-Low Level, $t_{PHL}$ CD4011A and CD4023A		5	50	75	50	100	ns
		10	25	40	25	50	
CD4012A		5	100	150	100	200	ns
		10	50	75	50	100	
Transition Time: Low-to-High Level, $t_{TLH}$		5	75	100	75	125	ns
		10	40	60	40	75	
High-to-Low Level, $t_{THL}$ CD4011A and CD4023A		5	75	125	75	150	ns
		10	50	75	50	100	
CD4012A		5	250	375	250	500	ns
		10	125	200	125	250	
Input Capacitance, $C_i$	Any Input	5	—	5	—	—	pF

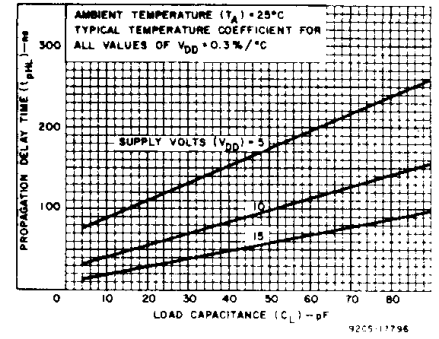

Fig. 13 — Typical high-to-low level propagation delay time vs.  $C_L$  — CD4012A.

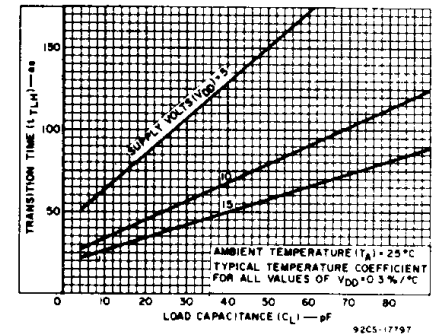

Fig. 14 — Typical low-to-high transition time vs.  $C_L$ .

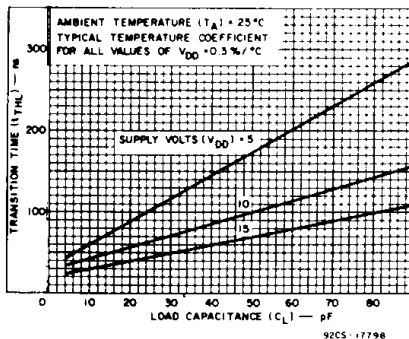

Fig. 15 — Typical high-to-low level transition time vs.  $C_L$  — CD4011A & CD4023A.

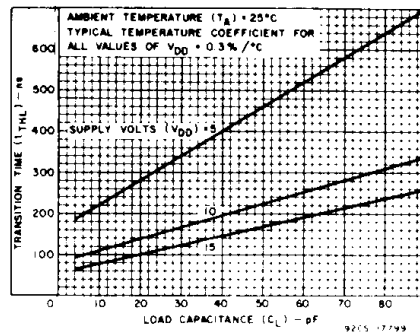

Fig. 16 — Typical high-to-low level transition time vs.  $C_L$  — CD4012A.

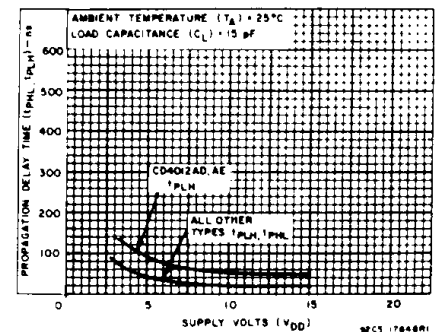

Fig. 17 — Minimum propagation delay time vs.  $V_{DD}$ .

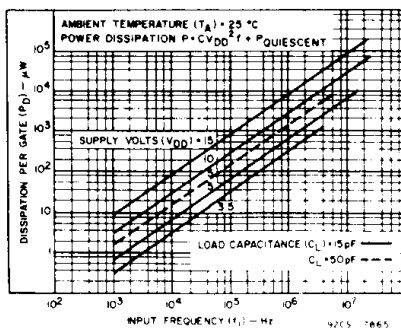

Fig. 18 — Typical dissipation characteristics.

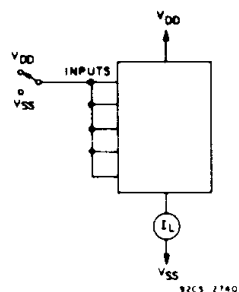

Fig. 19 — Quiescent device current test circuit.

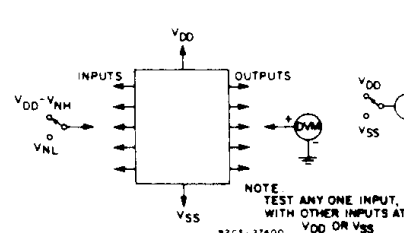

Fig. 20 — Noise immunity test circuit.

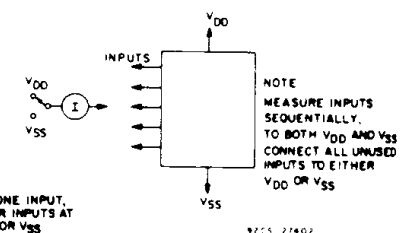

Fig. 21 — Input leakage current test circuit.

**PACKAGING INFORMATION**

Orderable Device	Status (1)	Package Type	Package Drawing	Pins	Package Qty	Eco Plan (2)	Lead finish/ Ball material (6)	MSL Peak Temp (3)	Op Temp (°C)	Device Marking (4/5)	Samples
CD4011AD3	ACTIVE	CDIP SB	JD	14	24	Non-RoHS & Non-Green	AU	N / A for Pkg Type	-55 to 125	CD4011AD3	<a href="#">Samples</a>
JM38510/05001BCA	ACTIVE	CDIP	J	14	25	Non-RoHS & Green	SNPB	N / A for Pkg Type	-55 to 125	JM38510/ 05001BCA	<a href="#">Samples</a>
M38510/05001BCA	ACTIVE	CDIP	J	14	25	Non-RoHS & Green	SNPB	N / A for Pkg Type	-55 to 125	JM38510/ 05001BCA	<a href="#">Samples</a>

(1) The marketing status values are defined as follows:

**ACTIVE:** Product device recommended for new designs.

**LIFEBUY:** TI has announced that the device will be discontinued, and a lifetime-buy period is in effect.

**NRND:** Not recommended for new designs. Device is in production to support existing customers, but TI does not recommend using this part in a new design.

**PREVIEW:** Device has been announced but is not in production. Samples may or may not be available.

**OBSOLETE:** TI has discontinued the production of the device.

(2) **RoHS:** TI defines "RoHS" to mean semiconductor products that are compliant with the current EU RoHS requirements for all 10 RoHS substances, including the requirement that RoHS substance do not exceed 0.1% by weight in homogeneous materials. Where designed to be soldered at high temperatures, "RoHS" products are suitable for use in specified lead-free processes. TI may reference these types of products as "Pb-Free".

**RoHS Exempt:** TI defines "RoHS Exempt" to mean products that contain lead but are compliant with EU RoHS pursuant to a specific EU RoHS exemption.

**Green:** TI defines "Green" to mean the content of Chlorine (Cl) and Bromine (Br) based flame retardants meet JS709B low halogen requirements of <=1000ppm threshold. Antimony trioxide based flame retardants must also meet the <=1000ppm threshold requirement.

(3) MSL, Peak Temp. - The Moisture Sensitivity Level rating according to the JEDEC industry standard classifications, and peak solder temperature.

(4) There may be additional marking, which relates to the logo, the lot trace code information, or the environmental category on the device.

(5) Multiple Device Markings will be inside parentheses. Only one Device Marking contained in parentheses and separated by a "~" will appear on a device. If a line is indented then it is a continuation of the previous line and the two combined represent the entire Device Marking for that device.

(6) Lead finish/Ball material - Orderable Devices may have multiple material finish options. Finish options are separated by a vertical ruled line. Lead finish/Ball material values may wrap to two lines if the finish value exceeds the maximum column width.

**Important Information and Disclaimer:**The information provided on this page represents TI's knowledge and belief as of the date that it is provided. TI bases its knowledge and belief on information provided by third parties, and makes no representation or warranty as to the accuracy of such information. Efforts are underway to better integrate information from third parties. TI has taken and continues to take reasonable steps to provide representative and accurate information but may not have conducted destructive testing or chemical analysis on incoming materials and chemicals. TI and TI suppliers consider certain information to be proprietary, and thus CAS numbers and other limited information may not be available for release.

In no event shall TI's liability arising out of such information exceed the total purchase price of the TI part(s) at issue in this document sold by TI to Customer on an annual basis.

JD (R-CDIP-T14)

CERAMIC SIDE-BRAZE DUAL-IN-LINE

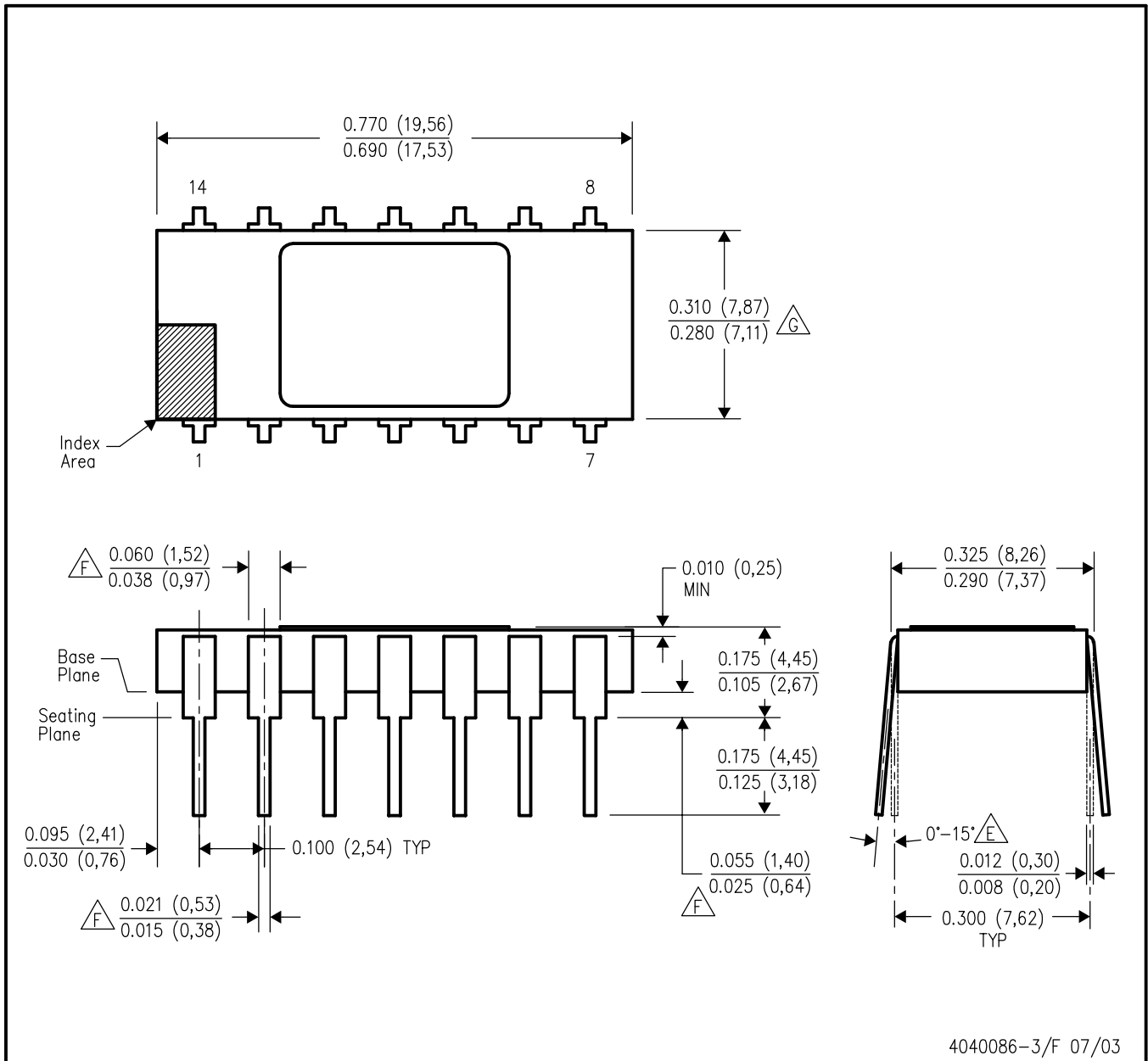

- NOTES:
- A. All linear dimensions are in inches (millimeters).
  - B. This drawing is subject to change without notice.
  - C. Controlling dimension: inch.
  - D. Leads within 0.005 (0,13) radius of true position (TP) at gage plane with maximum material condition and unit installed.
  - E. Angle applies to spread leads prior to installation.
  - F. Outlines on which the seating plane is coincident with the plane (standoff = 0), terminals lead standoffs are not required, and lead shoulder may equal lead width along any part of the lead above the seating/base plane.
  - G. Body width does not include particles of packing materials.
  - H. A visual index feature must be located within the cross-hatched area.

J 14

**GENERIC PACKAGE VIEW**  
**CDIP - 5.08 mm max height**  
CERAMIC DUAL IN LINE PACKAGE



Images above are just a representation of the package family, actual package may vary.  
Refer to the product data sheet for package details.

4040083-5/G

J0014A



# PACKAGE OUTLINE

CDIP - 5.08 mm max height

CERAMIC DUAL IN LINE PACKAGE



4214771/A 05/2017

**NOTES:**

1. All controlling linear dimensions are in inches. Dimensions in brackets are in millimeters. Any dimension in brackets or parenthesis are for reference only. Dimensioning and tolerancing per ASME Y14.5M.
2. This drawing is subject to change without notice.
3. This package is hermetically sealed with a ceramic lid using glass frit.
4. Index point is provided on cap for terminal identification only and on press ceramic glass frit seal only.
5. Falls within MIL-STD-1835 and GDIP1-T14.



# EXAMPLE BOARD LAYOUT

J0014A

CDIP - 5.08 mm max height

CERAMIC DUAL IN LINE PACKAGE



LAND PATTERN EXAMPLE  
NON-SOLDER MASK DEFINED  
SCALE: 5X



4214771/A 05/2017

## IMPORTANT NOTICE AND DISCLAIMER

TI PROVIDES TECHNICAL AND RELIABILITY DATA (INCLUDING DATA SHEETS), DESIGN RESOURCES (INCLUDING REFERENCE DESIGNS), APPLICATION OR OTHER DESIGN ADVICE, WEB TOOLS, SAFETY INFORMATION, AND OTHER RESOURCES "AS IS" AND WITH ALL FAULTS, AND DISCLAIMS ALL WARRANTIES, EXPRESS AND IMPLIED, INCLUDING WITHOUT LIMITATION ANY IMPLIED WARRANTIES OF MERCHANTABILITY, FITNESS FOR A PARTICULAR PURPOSE OR NON-INFRINGEMENT OF THIRD PARTY INTELLECTUAL PROPERTY RIGHTS.

These resources are intended for skilled developers designing with TI products. You are solely responsible for (1) selecting the appropriate TI products for your application, (2) designing, validating and testing your application, and (3) ensuring your application meets applicable standards, and any other safety, security, regulatory or other requirements.

These resources are subject to change without notice. TI grants you permission to use these resources only for development of an application that uses the TI products described in the resource. Other reproduction and display of these resources is prohibited. No license is granted to any other TI intellectual property right or to any third party intellectual property right. TI disclaims responsibility for, and you will fully indemnify TI and its representatives against, any claims, damages, costs, losses, and liabilities arising out of your use of these resources.

TI's products are provided subject to [TI's Terms of Sale](#) or other applicable terms available either on [ti.com](https://www.ti.com) or provided in conjunction with such TI products. TI's provision of these resources does not expand or otherwise alter TI's applicable warranties or warranty disclaimers for TI products.

TI objects to and rejects any additional or different terms you may have proposed.

Mailing Address: Texas Instruments, Post Office Box 655303, Dallas, Texas 75265  
Copyright © 2024, Texas Instruments Incorporated