

bq27621-G1 系统侧电量计，支持动态电压关联

1 特性

- 单节串联锂离子电池电量计
 - 驻留在系统主板上
 - 支持嵌入式或可拆除电池
 - 由具有集成低压降稳压器 (LDO) 的电池直接供电
- 根据动态电压关联算法轻松配置电量计量
 - 用平滑滤波器报告剩余电量和充电状态 (SOC)
 - 针对自放电、温度和速率变化进行自动调节
- 微控制器外设支持：
 - 400kHz I²C 串口
 - 可配置 SOC 中断或电池低数字输出报警
 - 内部温度传感器或主机报告的温度
- 支持 4.2V, 4.3V 和 4.35V 化学成分电池
- 9 引脚 1.62mm x 1.58mm, 焊球间距 0.5mm YZF 封装

2 应用范围

- 智能手机、功能型手机和平板电脑
- 数码相机与数码摄像机
- 手持终端设备
- MP3 或多媒体播放器

3 说明

德州仪器 (TI) bq27621-G1 是一款易于配置的微控制器外设，此外设提供针对单节锂离子电池的系统侧电量计量。此器件要求最小用户配置和系统微控制器固件开发。

bq27621-G1 使用动态电压关联算法实现电量计量。这一过程在计算剩余电量 (mAh)，充电状态 (%), 电池电压 (mV) 和温度 (°C) 时无需感测电阻器。

使用 bq27621-G1 进行电池电量计量只需将 PACK+ (P+) 与 PACK- (P-) 连接至可拆卸电池组或嵌入式电池电路。微型 9 引脚, 1.62mm x 1.58mm, 0.5mm 焊球间距 YZF 封装非常适合于空间受限应用。

器件信息 (1)

器件名称	封装	封装尺寸
BQ27621-G1	YZF	1.62mm x 1.58mm

(1) 要了解所有可用封装，请见数据表末尾的可订购产品附录。

4 典型应用

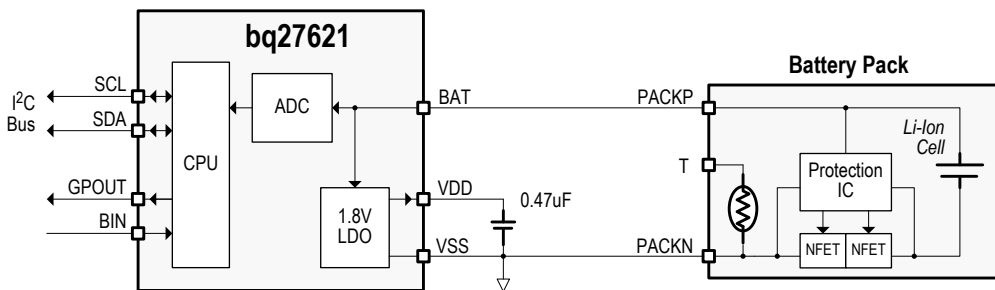

目录

1	特性	1	7.8	ADC (Temperature and Cell Measurement) Characteristics	5
2	应用范围	1	7.9	I ² C-Compatible Interface Communication Timing Characteristics	6
3	说明	1	8	Detailed Description	7
4	典型应用	1	8.1	Overview	7
5	修订历史记录	2	8.2	Feature Description	8
6	Pin Configurations and Functions	3	8.3	Reference (EVM) Schematic	12
7	Electrical Specifications	4	9	Device and Documentation Support	13
7.1	Absolute Maximum Ratings	4	9.1	Documentation Support	13
7.2	Handling Ratings	4	9.2	Trademarks	13
7.3	Recommended Operating Conditions	4	9.3	Electrostatic Discharge Caution	13
7.4	Thermal Information	4	9.4	Glossary	13
7.5	Supply Current	5	10	Mechanical, Packaging, and Orderable Information	13
7.6	Digital Input and Output DC Characteristics	5			
7.7	LDO Regulator, Wake-up, and Auto-Shutdown DC Characteristics	5			

5 修订历史记录

Changes from Revision B (January 2014) to Revision C	Page
• 已更新命令列表和算法说明。	1
• Updated BIN pin description	3
• Updated GPOUT pin description	3

Changes from Revision A (January 2014) to Revision B	Page
• Changed the I _{IKG} Parameters.Split out the GPOUT pin	5

Changes from Original (November 2013) to Revision A	Page
• 已将器件状态从：产品预览改为：生产	1
• 已将特性从：。。。芯片级封装 (CSP) 更改为：YZF 封装	1
• 已将说明从：CSP 封装更改为：。。。YZF 封装	1
• Deleted Note 2 From the SUPPLY CURRENT table - "Wake Comparator Disabled"	4

Device Comparison Table

PART NUMBER	BATTERY TYPE	CHEM_ID ⁽¹⁾	FIRMWARE VERSION ⁽²⁾	PACKAGE ⁽³⁾	COMMUNICATION FORMAT
bq27621YZFR-G1	LiCoO ₂ (4.2 V maximum charge)	0x1202	1.05 (0x0105)	CSP-9	I ² C
	LiCoO ₂ (4.3 V maximum charge)	0x1210			
	LiCoO ₂ (4.35 V maximum charge)	0x354			

- (1) See the CHEM_ID subcommand to confirm the battery chemistry type. See [Alternate Chemistry Selection](#) to select different chemistries.
(2) See the FW_VERSION subcommand to confirm the firmware version.
(3) For the most current package and ordering information see the Package Option Addendum at the end of this document; or, see the TI website at www.ti.com.

6 Pin Configurations and Functions

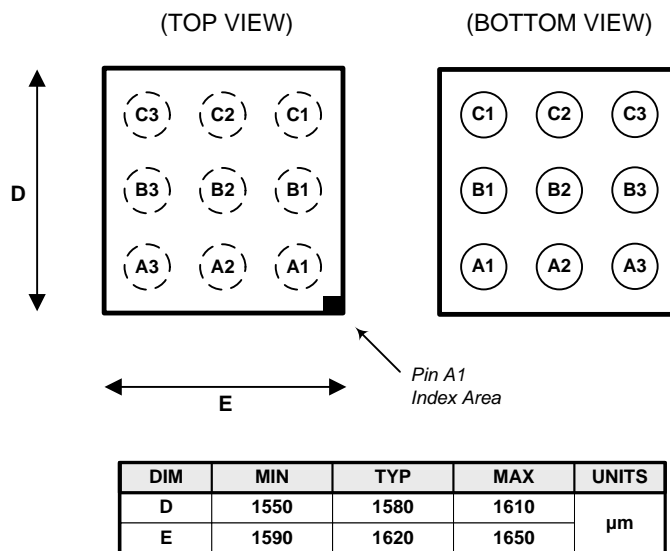

Pin Functions

PIN		TYPE ⁽¹⁾	DESCRIPTION
NAME	NO.		
BAT	C2, C3	PI, AI	LDO regulator input and battery voltage input. Connect to positive battery connector. For highest accuracy, use a Kelvin connection by directly routing to the PACK+ pin and minimizing current flow through the trace.
BIN	B1	DI	Battery insertion detection input. If Operation Configuration bit [BIE] = 1 (default), a logic low on the pin is detected as battery insertion. For a removable pack, the BIN pin can be connected to V _{SS} through a pulldown resistor on the pack, typically the 10-kΩ thermistor; the system board should use a 1.8-MΩ pullup resistor to V _{DD} to ensure the BIN pin is high when a battery is removed. If the battery is embedded in the system, it is recommended to leave [BIE] = 1 and use a 10-kΩ pulldown resistor from BIN to V _{SS} . If [BIE] = 0, then the host must inform the gauge of battery insertion and removal with the BAT_INSERT and BAT_REMOVE subcommands. A 10-kΩ pulldown resistor should be placed between BIN and V _{SS} , even if this pin is unused. NOTE: The BIN pin must not be shorted directly to V _{CC} or V _{SS} and any pullup resistor on the BIN pin must be connected only to the bq27621 V _{DD} and not an external voltage rail.
GPOUT	A1	DO	This open-drain output can be configured to indicate BAT_LOW when the Operation Configuration [BATLOWEN] bit is set. By default [BATLOWEN] is cleared and this pin performs an interrupt function (SOC_INT) by pulsing for specific events, such as a change in State of Charge. Signal polarity for these functions is controlled by the [GPIOPOL] configuration bit. This pin should not be left floating, even if unused, so a 10-kΩ pullup resistor is recommended.
SCL	A3	DIO	Slave I ² C serial communications clock input line for communication with system (Master). Use with 10-kΩ pullup resistor (typical).
SDA	A2	DIO	Slave I ² C serial communications data line for communication with system (Master). Open-drain I/O. Use with 10-kΩ pullup resistor (typical).
VDD	B3	PO	1.8-V Regulator Output. Decouple with 0.47-μF ceramic capacitor to V _{SS} .

- (1) IO = Digital input-output, IA = Analog input, P = Power connection

Pin Functions (continued)

PIN		TYPE ⁽¹⁾	DESCRIPTION
NAME	NO.		
VSS	B2, C1	PI	Ground pins. B2 is the actual device ground pin while C1 is floating internally. Therefore, C1 may be used as a bridge to connect to the board ground plane without requiring a via under the device package. Recommend routing B2 to C1 using a top-layer metal trace on the board. Connect to negative battery connector. For highest accuracy, use a Kelvin connection by directly routing to the PACK– pin and minimizing current flow through the trace.

7 Electrical Specifications

7.1 Absolute Maximum Ratings

over operating free-air temperature range (unless otherwise noted)⁽¹⁾

PARAMETER		MIN	MAX	UNIT
V _{BAT}	BAT pin input voltage range	–0.3	6	V
V _{DD}	V _{DD} pin supply voltage range (LDO output)	–0.3	2	V
V _{IOD}	Open-drain I/O pins (SDA, SCL, GPOUT)	–0.3	6	V
V _{IOPP}	Push-Pull I/O pins (BIN)	–0.3	[V _{DD} + 0.3]	V
T _A	Operating free-air temperature range	–40	85	°C

(1) Stresses beyond those listed under "absolute maximum ratings" may cause permanent damage to the device. These are stress ratings only, and functional operation of the device at these or any other conditions beyond those indicated under "recommended operating conditions" is not implied. Exposure to absolute-maximum-rated conditions for extended periods may affect device reliability.

7.2 Handling Ratings

		MIN	MAX	UNIT	
T _{stg}	Storage temperature range	–65	150	°C	
V _(ESD)	Electrostatic discharge	Human body model (HBM), per ANSI/ESDA/JEDEC JS-001, all pins ⁽¹⁾	–1	1	kV
		Charged device model (CDM), per JEDEC specification JESD22-C101, all pins ⁽²⁾	–250	250	V

(1) JEDEC document JEP155 states that 500-V HBM allows safe manufacturing with a standard ESD control process.

(2) JEDEC document JEP157 states that 250-V CDM allows safe manufacturing with a standard ESD control process.

7.3 Recommended Operating Conditions

T_A = 30°C and V_{REGIN} = V_{BAT} = 3.6 V (unless otherwise noted)

PARAMETER		TEST CONDITIONS	MIN	TYP	MAX	UNIT
C _{BAT} ⁽¹⁾	Optional external input capacitor for internal LDO between BAT and V _{SS}	Nominal capacitor values specified. Recommend a 5% ceramic X5R type capacitor located close to the device.		0.1		μF
C _{LDO18} ⁽¹⁾	External output capacitor for internal LDO between V _{DD} and V _{SS}			0.47		μF
V _{PU} ⁽¹⁾	External pullup voltage for open-drain pins (SDA, SCL, GPOUT)		1.62		3.6	V

(1) Specified by design. Not production tested.

7.4 Thermal Information

over operating free-air temperature range (unless otherwise noted)

THERMAL METRIC ⁽¹⁾		bq27621-G1	UNIT
		YZF (9 PINS)	
R _{θJA}	Junction-to-ambient thermal resistance	107.8	°C/W
R _{θJC(top)}	Junction-to-case (top) thermal resistance	0.7	
R _{θJB}	Junction-to-board thermal resistance	60.4	
Ψ _{JT}	Junction-to-top characterization parameter	3.5	
Ψ _{JB}	Junction-to-board characterization parameter	60.4	
R _{θJC(bot)}	Junction-to-case (bottom) thermal resistance	n/a	

(1) For more information about traditional and new thermal metrics, see the IC Package Thermal Metrics application report, [SPRA953](#)

7.5 Supply Current

 $T_A = 30^\circ\text{C}$ and $V_{\text{REGIN}} = V_{\text{BAT}} = 3.6\text{ V}$ (unless otherwise noted)

PARAMETER	TEST CONDITIONS	MIN	TYP	MAX	UNIT
I_{CC} ⁽¹⁾	NORMAL mode current		27		μA
I_{SLP} ⁽¹⁾	SLEEP mode current		21		μA
I_{HIB} ⁽¹⁾	HIBERNATE mode current		9		μA
I_{SD} ⁽¹⁾	SHUTDOWN mode current	Fuel gauge in host commanded SHUTDOWN mode. (LDO Regulator Output Disabled)		0.6	μA

(1) Specified by design. Not production tested.

7.6 Digital Input and Output DC Characteristics

 $T_A = -40^\circ\text{C}$ to 85°C , typical values at $T_A = 30^\circ\text{C}$ and $V_{\text{REGIN}} = 3.6\text{ V}$ (unless otherwise noted)

PARAMETER	TEST CONDITIONS	MIN	TYP	MAX	UNIT
$V_{\text{IH(OD)}}$	Input voltage, high ⁽²⁾	External pullup resistor to V_{PU}		$V_{\text{PU}} \times 0.7$	V
V_{IL}	Input voltage, low ⁽²⁾ ⁽³⁾			0.6	V
V_{OL}	Output voltage, low ⁽²⁾			0.6	V
I_{OH}	Output source current, high ⁽²⁾			0.5	mA
$I_{\text{OL(OD)}}$	Output sink current, low ⁽²⁾			-3	mA
C_{IN} ⁽¹⁾	Input capacitance ⁽²⁾ ⁽³⁾			5	pF
I_{Ikg}	Input leakage current (SCL, SDA, BIN)			0.1	μA
	Input leakage current (GPOUT)			1	

(1) Specified by design. Not production tested.

(2) Open drain pins: (SCL, SDA, GPOUT)

(3) Push-pull pin: (BIN)

7.7 LDO Regulator, Wake-up, and Auto-Shutdown DC Characteristics

 $T_A = -40^\circ\text{C}$ to 85°C , typical values at $T_A = 30^\circ\text{C}$ and $V_{\text{REGIN}} = 3.6\text{ V}$ (unless otherwise noted)

PARAMETER	TEST CONDITIONS	MIN	TYP	MAX	UNIT
V_{BAT}	BAT pin regulator input	2.45		4.5	V
V_{DD}	Regulator output voltage		1.8		V
$UVLO_{\text{IT+}}$	V_{BAT} Under Voltage Lock Out LDO Wake-Up Rising Threshold		2		V
$UVLO_{\text{IT-}}$	V_{BAT} Under Voltage Lock Out LDO Auto-Shutdown Falling Threshold		1.95		V

(1) Specified by design. Not production tested.

7.8 ADC (Temperature and Cell Measurement) Characteristics

 $T_A = -40^\circ\text{C}$ to 85°C ; typical values at $T_A = 30^\circ\text{C}$ and $V_{\text{REGIN}} = 3.6\text{ V}$ (unless otherwise noted)

PARAMETER	TEST CONDITIONS	MIN	TYP	MAX	UNIT	
$V_{\text{IN(BAT)}}$	BAT pin voltage measurement range.	Voltage divider enabled.		2.45	4.5	V
$t_{\text{ADC_CONV}}$	Conversion time		125		ms	
	Effective Resolution		15		bits	

(1) Specified by design. Not tested in production.

7.9 I²C-Compatible Interface Communication Timing Characteristics

T_A = -40°C to 85°C; typical values at T_A = 30°C and V_{REGIN} = 3.6 V (unless otherwise noted)

PARAMETER	TEST CONDITIONS	MIN	TYP	MAX	UNIT
Standard Mode (100 kHz)					
t _{d(STA)}	Start to first falling edge of SCL	4			μs
t _{w(L)}	SCL pulse duration (low)	4.7			μs
t _{w(H)}	SCL pulse duration (high)	4			μs
t _{su(STA)}	Setup for repeated start	4.7			μs
t _{su(DAT)}	Data setup time	Host drives SDA			ns
t _{h(DAT)}	Data hold time	Host drives SDA			ns
t _{su(STOP)}	Setup time for stop	4			μs
t _(BUF)	Bus free time between stop and start	Includes Command Waiting Time		66	μs
t _f	SCL/SDA fall time ⁽¹⁾			300	ns
t _r	SCL/SDA rise time ⁽¹⁾			300	ns
f _{SCL}	Clock frequency ⁽²⁾			100	kHz
Fast Mode (400 kHz)					
t _{d(STA)}	Start to first falling edge of SCL	600			ns
t _{w(L)}	SCL pulse duration (low)	1300			ns
t _{w(H)}	SCL pulse duration (high)	600			ns
t _{su(STA)}	Setup for repeated start	600			ns
t _{su(DAT)}	Data setup time	Host drives SDA		100	ns
t _{h(DAT)}	Data hold time	Host drives SDA		0	ns
t _{su(STOP)}	Setup time for stop	600			ns
t _(BUF)	Bus free time between stop and start	Includes Command Waiting Time		66	μs
t _f	SCL/SDA fall time ⁽¹⁾			300	ns
t _r	SCL/SDA rise time ⁽¹⁾			300	ns
f _{SCL}	Clock frequency ⁽²⁾			400	kHz

- (1) Specified by design. Not production tested.
- (2) If the clock frequency (f_{SCL}) is > 100 kHz, use 1-byte write commands for proper operation. All other transactions types are supported at 400 kHz. (Refer to I²C Interface and I²C Command Waiting Time)

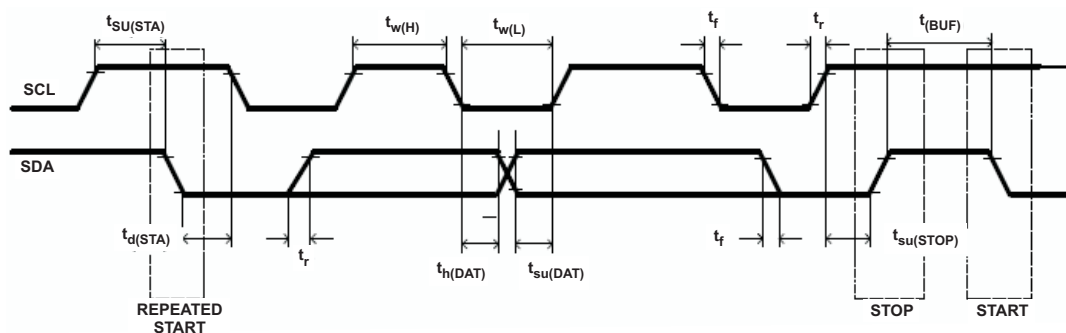

Figure 1. I²C-Compatible Interface Timing Diagrams

8 Detailed Description

8.1 Overview

The bq27621-G1 battery fuel gauge accurately predicts the battery capacity and other operational characteristics of a single Li-based rechargeable cell. It can be interrogated by a system processor to provide cell information such as **State of Charge** (%) and **Remaining Capacity** (mAh). The device is preconfigured with three battery profiles. The default profile is for standard LiCoO₂-based batteries with a maximum charge voltage of 4.2 V. The other two profiles that can be selected via I²C commands are for batteries with charging voltages of 4.3 V and 4.35 V.

Unlike some other fuel gauges, the bq27621-G1 fuel gauge can not be programmed with specific battery chemistry profiles. For many battery types and applications, the predefined standard chemistry profiles available in the bq27621-G1 fuel gauge are sufficient matches from a gauging perspective.

Information is accessed through a series of commands, called *Standard Commands*. Further capabilities are provided by the additional *Extended Commands* set. Both sets of commands, indicated by the general format *Command*(), are used to read and write information contained within the control and status registers, as well as its data locations. Commands are sent from system to gauge using the I²C serial communications engine, and can be executed during application development, system manufacture, or end-equipment operation.

The key to the fuel gauging prediction of the bq27621-G1 fuel gauge is Texas Instruments proprietary Dynamic Voltage Correlation algorithm. This algorithm eliminates the need for a sense resistor when calculating remaining battery capacity (mAh) and state-of-charge (%). This algorithm uses cell voltage measurements and cell characteristics to create state-of-charge predictions that can achieve high accuracy across a wide variety of operating conditions.

The fuel gauge estimates charge and discharge activity by monitoring the cell voltage. Cell impedance is computed based on estimated current, open-circuit voltage (OCV), and cell voltage under loaded conditions.

The fuel gauge uses an integrated temperature sensor for estimating cell temperature. Alternatively, the system processor can provide temperature data for the fuel gauge.

To minimize power consumption, the fuel gauge has several power modes: INITIALIZATION, NORMAL, SLEEP, HIBERNATE, and SHUTDOWN. The fuel gauge passes automatically between these modes, depending upon the occurrence of specific events, though a system processor can initiate some of these modes directly.

The gauge can be configured and used in a matter of minutes by following the *Quickstart Guide for bq27621-G1* (SLUUAP5). The information in that document is sufficient for most applications. For further customization and options, more exhaustive details can be found in the *bq27621-G1 Technical Reference Manual* (SLUUAD4).

NOTE

Formatting conventions used in this document:

Commands: *italics* with *parentheses* and no breaking spaces, for example: *RemainingCapacity*()

Data Memory Configuration Parameter: *italics*, **bold**, and *breaking spaces*, for example: **Design Capacity**

Register bits and flags: brackets and *italics*, for example: [ITPOR]

Data Memory Configuration Parameter bits: brackets, *italics* and **bold**, for example: [**BIE**]

Modes and states: ALL CAPITALS, for example: UNSEALED mode

8.2 Feature Description

8.2.1 Data Commands

8.2.1.1 Standard Data Commands

The bq27621-G1 uses a series of 2-byte standard commands to enable system reading and writing of battery information. Each standard command has an associated command-code pair, as indicated in [Table 1](#). Because each command consists of two bytes of data, two consecutive I²C transmissions must be executed both to initiate the command function, and to read or write the corresponding two bytes of data. Additional details are found in the [bq27621-G1 Technical Reference Manual \(SLUUAD4\)](#).

NOTE

Data values read by the host may be invalid during initialization for a period of up to 3 seconds.

Table 1. Standard Commands

NAME		COMMAND CODE	UNIT	SEALED ACCESS
<i>Control()</i>	CNTL	0x00 and 0x01	NA	R/W
<i>Temperature()</i>	TEMP	0x02 and 0x03	0.1°K	R/W
<i>Voltage()</i>	VOLT	0x04 and 0x05	mV	R
<i>Flags()</i>	FLAGS	0x06 and 0x07	NA	R
<i>NominalAvailableCapacity()</i>		0x08 and 0x09	mAh	R
<i>FullAvailableCapacity()</i>		0x0A and 0x0B	mAh	R
<i>RemainingCapacity()</i>	RM	0x0C and 0x0D	mAh	R
<i>FullChargeCapacity()</i>	FCC	0x0E and 0x0F	mAh	R
<i>EffectiveCurrent()</i>		0x10 and 0x11	mA	R
<i>AveragePower()</i>		0x18 and 0x19	mW	R
<i>StateOfCharge()</i>	SOC	0x1C and 0x1D	%	R
<i>InternalTemperature()</i>		0x1E and 0x1F	0.1°K	R
<i>RemainingCapacityUnfiltered()</i>		0x28 and 0x29	mAh	R
<i>RemainingCapacityFiltered()</i>		0x2A and 0x2B	mAh	R
<i>FullChargeCapacityUnfiltered()</i>		0x2C and 0x2D	mAh	R
<i>FullChargeCapacityFiltered()</i>		0x2E and 0x2F	mAh	R
<i>StateOfChargeUnfiltered()</i>		0x30 and 0x31	mAh	R
<i>OperationConfiguration()</i>		0x3A and 0x3B	NA	R

8.2.1.2 Control(): 0x00 and 0x01

Issuing a *Control()* command requires a subsequent 2-byte subcommand. These additional bytes specify the particular control function desired. The *Control()* command allows the system to control specific features of the fuel gauge during normal operation and additional features when the device is in different access modes. Additional details are found in the [bq27621-G1 Technical Reference Manual \(SLUUAD4\)](#).

Table 2. Control() Subcommands

CNTL FUNCTION	CNTL DATA	SEALED ACCESS	DESCRIPTION
CONTROL_STATUS	0x0000	Yes	Reports the status of device.
DEVICE_TYPE	0x0001	Yes	Reports the device type (0x0621).
FW_VERSION	0x0002	Yes	Reports the firmware version of the device.
PREV_MACWRITE	0x0007	Yes	Returns previous MAC command code.
CHEM_ID	0x0008	Yes	Reports the chemical identifier of the battery profile currently used by the fuel gauging algorithm
BAT_INSERT	0x000C	Yes	Forces the [BAT_DET] bit set when the [BIE] bit is 0.
BAT_REMOVE	0x000D	Yes	Forces the [BAT_DET] bit clear when the [BIE] bit is 0.
TOGGLE_POWERMIN	0x0010	Yes	Set CONTROL_STATUS [POWERMIN] to 1.
SET_HIBERNATE	0x0011	Yes	Forces CONTROL_STATUS [HIBERNATE] to 1.
CLEAR_HIBERNATE	0x0012	Yes	Forces CONTROL_STATUS [HIBERNATE] to 0.
SET_CFGUPDATE	0x0013	No	Force CONTROL_STATUS [CFGUPMODE] to 1 and gauge enters CONFIG UPDATE mode.
SHUTDOWN_ENABLE	0x001B	No	Enables device SHUTDOWN mode.
SHUTDOWN	0x001C	No	Commands the device to enter SHUTDOWN mode.
SEALED	0x0020	No	Places the device in SEALED access mode.
TOGGLE_GPOUT	0x0023	Yes	Test the GPIO pin by sending a pulse signal
ALT_CHEM1	0x0031	No	Selects alternate chemistry 1 (0x1210)
ALT_CHEM2	0x0032	No	Selects alternate chemistry 2 (0x354)
RESET	0x0041	No	Performs a full device reset.
SOFT_RESET	0x0042	No	Gauge exits CONFIG UPDATE mode.
EXIT_CFGUPDATE	0x0043	No	Exits CONFIG UPDATE mode without an OCV measurement and without resimulating to update <i>StateOfCharge()</i> .
EXIT_RESIM	0x0044	No	Exits CONFIG UPDATE mode without an OCV measurement and resimulates with the updated configuration data to update <i>StateOfCharge()</i> .

8.2.2 Alternate Chemistry Selection

The fuel gauge allows the user to change the chemistry settings using I²C commands. The default chemistry has a CHEM_ID of 0x1202. The two other CHEM_IDs supported by this device includes CHEM_ID 0x1210 and CHEM_ID 0x354. The detailed procedure to change the chemistry is available in the [bq27621-G1 Technical Reference Manual \(SLUUAD4\)](#).

8.2.3 I²C Interface

The bq27621-G1 fuel gauge supports the standard I²C read, incremental read, quick read, one-byte write, and incremental write functions. The 7-bit device address (ADDR) is the most significant 7 bits of the hex address and is fixed as 1010101. The first 8 bits of the I²C protocol are, therefore, 0xAA or 0xAB for write or read, respectively.

Host generated Gauge generated

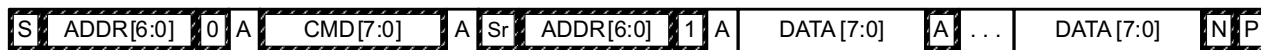
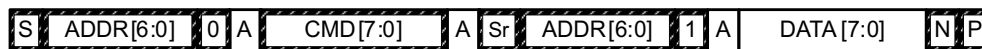

(S = Start, Sr = Repeated Start, A = Acknowledge, N = No Acknowledge, and P = Stop).

The quick read returns data at the address indicated by the address pointer. The address pointer, a register internal to the I²C communication engine, increments whenever data is acknowledged by the fuel gauge or the I²C master. The quick writes function in the same manner and are a convenient means of sending multiple bytes to consecutive command locations (such as two-byte commands that require two bytes of data).

The following command sequences are not supported:

Attempt to write a read-only address (NACK after data sent by master):

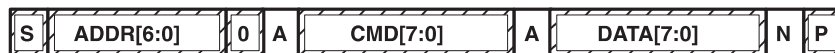

Attempt to read an address above 0x6B (NACK command):



8.2.4 I²C Time Out

The I²C engine releases both SDA and SCL if the I²C bus is held low for 2 seconds. If the fuel gauge is holding the lines, releasing them frees them for the master to drive the lines.

8.2.5 I²C Command Waiting Time

To ensure proper operation at 400 kHz, a $t_{(BUF)} \geq 66 \mu s$ bus-free waiting time must be inserted between all packets addressed to the fuel gauge. In addition, if the SCL clock frequency (f_{SCL}) is > 100 kHz, use individual 1-byte write commands for proper data flow control. The following diagram shows the standard waiting time required between issuing the control subcommand the reading the status result. For read-write standard command, a minimum of 2 seconds is required to get the result updated. For read-only standard commands, there is no waiting time required, but the host must not issue any standard command more than two times per second. Otherwise, the gauge could result in a reset issue due to the expiration of the watchdog timer.

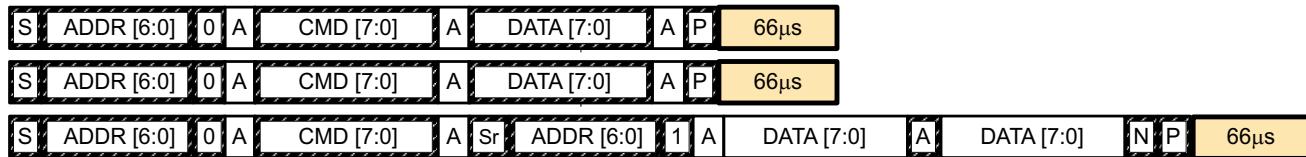

Waiting time inserted between two 1-byte write packets for a subcommand and reading results
(required for $100 \text{ kHz} < f_{SCL} \leq 400 \text{ kHz}$)

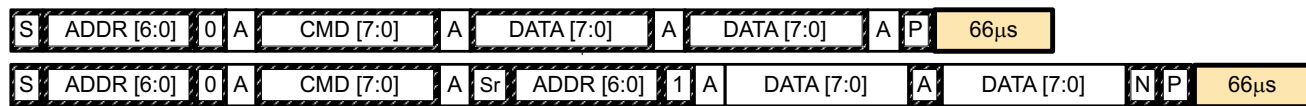

Waiting time inserted between incremental 2-byte write packet for a subcommand and reading results
(acceptable for $f_{SCL} \leq 100 \text{ kHz}$)

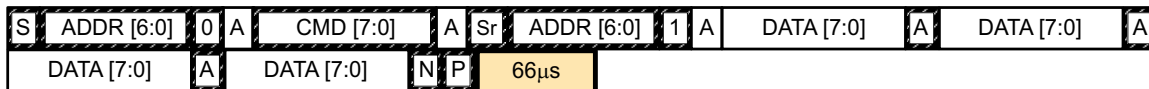

Waiting time inserted after incremental read

8.2.6 I²C Clock Stretching

A clock stretch of up to 4 ms can occur during all modes of fuel gauge operation. In SLEEP and HIBERNATE modes, a short clock stretch occurs on all I²C traffic as the device must wake-up to process the packet. In the other modes (INITIALIZATION, NORMAL) clock stretching only occurs for packets addressed for the fuel gauge. The majority of clock stretch periods are small as the I²C interface performs normal data flow control.

bq27621-G1

ZHCSCF1C – DECEMBER 2013 – REVISED APRIL 2014

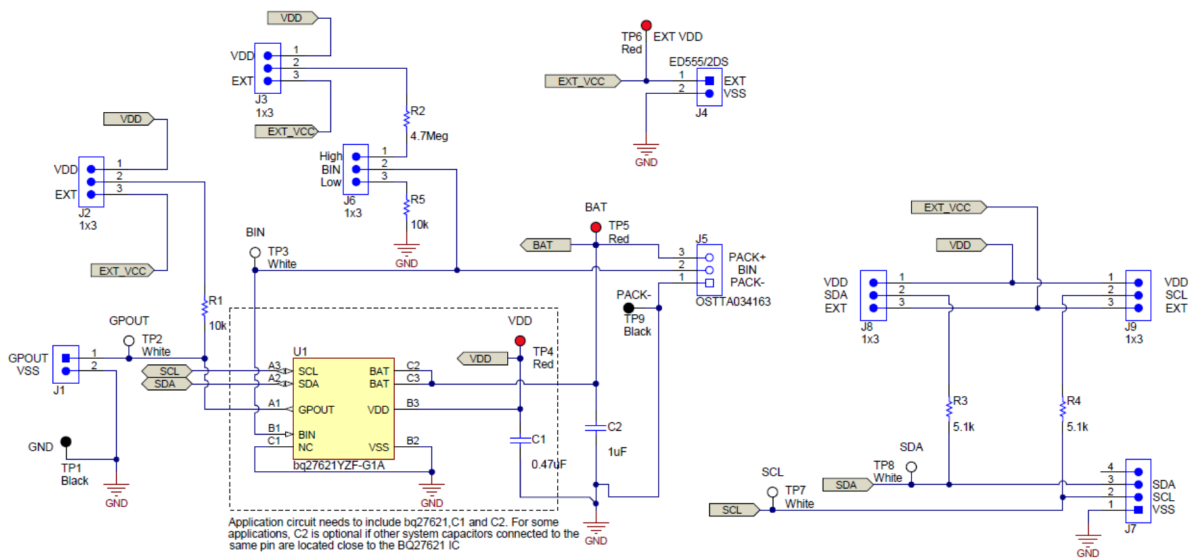
www.ti.com.cn
8.3 Reference (EVM) Schematic

9 Device and Documentation Support

9.1 Documentation Support

9.1.1 Related Documentation from Texas Instruments

To obtain a copy of any of the following TI documents, call the Texas Instruments Literature Response Center at (800) 477-8924 or the Product Information Center (PIC) at (972) 644-5580. When ordering, identify this document by its title and literature number. Updated documents also can be obtained through the TI Web site at www.ti.com.

1. *bq27621-G1 Technical Reference User's Guide* ([SLUUAD4](#))
2. *bq27621 EVM: Single-Cell Technology User's Guide* ([SLUUM6](#))
3. *Quickstart Guide for bq27621-G1* ([SLUUP5](#))

9.2 Trademarks

All trademarks are the property of their respective owners.

9.3 Electrostatic Discharge Caution



This integrated circuit can be damaged by ESD. Texas Instruments recommends that all integrated circuits be handled with appropriate precautions. Failure to observe proper handling and installation procedures can cause damage.

ESD damage can range from subtle performance degradation to complete device failure. Precision integrated circuits may be more susceptible to damage because very small parametric changes could cause the device not to meet its published specifications.

9.4 Glossary



[SLYZ022](#) — *TI Glossary*.

This glossary lists and explains terms, acronyms and definitions.

10 Mechanical, Packaging, and Orderable Information

The following pages include mechanical packaging and orderable information. This information is the most current data available for the designated devices. This data is subject to change without notice and revision of this document. For browser-based versions of this data sheet, refer to the left-hand navigation.

PACKAGING INFORMATION

Orderable Device	Status (1)	Package Type	Package Drawing	Pins	Package Qty	Eco Plan (2)	Lead finish/ Ball material (6)	MSL Peak Temp (3)	Op Temp (°C)	Device Marking (4/5)	Samples
BQ27621YZFR-G1A	ACTIVE	DSBGA	YZF	9	3000	RoHS & Green	SNAGCU	Level-1-260C-UNLIM	-40 to 85	BQ27621 G1A	
BQ27621YZFT-G1A	ACTIVE	DSBGA	YZF	9	250	RoHS & Green	SNAGCU	Level-1-260C-UNLIM	-40 to 85	BQ27621 G1A	

(1) The marketing status values are defined as follows:

ACTIVE: Product device recommended for new designs.

LIFEBUY: TI has announced that the device will be discontinued, and a lifetime-buy period is in effect.

NRND: Not recommended for new designs. Device is in production to support existing customers, but TI does not recommend using this part in a new design.

PREVIEW: Device has been announced but is not in production. Samples may or may not be available.

OBSOLETE: TI has discontinued the production of the device.

(2) **RoHS:** TI defines "RoHS" to mean semiconductor products that are compliant with the current EU RoHS requirements for all 10 RoHS substances, including the requirement that RoHS substance do not exceed 0.1% by weight in homogeneous materials. Where designed to be soldered at high temperatures, "RoHS" products are suitable for use in specified lead-free processes. TI may reference these types of products as "Pb-Free".

RoHS Exempt: TI defines "RoHS Exempt" to mean products that contain lead but are compliant with EU RoHS pursuant to a specific EU RoHS exemption.

Green: TI defines "Green" to mean the content of Chlorine (Cl) and Bromine (Br) based flame retardants meet JS709B low halogen requirements of <=1000ppm threshold. Antimony trioxide based flame retardants must also meet the <=1000ppm threshold requirement.

(3) MSL, Peak Temp. - The Moisture Sensitivity Level rating according to the JEDEC industry standard classifications, and peak solder temperature.

(4) There may be additional marking, which relates to the logo, the lot trace code information, or the environmental category on the device.

(5) Multiple Device Markings will be inside parentheses. Only one Device Marking contained in parentheses and separated by a "~" will appear on a device. If a line is indented then it is a continuation of the previous line and the two combined represent the entire Device Marking for that device.

(6) Lead finish/Ball material - Orderable Devices may have multiple material finish options. Finish options are separated by a vertical ruled line. Lead finish/Ball material values may wrap to two lines if the finish value exceeds the maximum column width.

Important Information and Disclaimer:The information provided on this page represents TI's knowledge and belief as of the date that it is provided. TI bases its knowledge and belief on information provided by third parties, and makes no representation or warranty as to the accuracy of such information. Efforts are underway to better integrate information from third parties. TI has taken and continues to take reasonable steps to provide representative and accurate information but may not have conducted destructive testing or chemical analysis on incoming materials and chemicals. TI and TI suppliers consider certain information to be proprietary, and thus CAS numbers and other limited information may not be available for release.

In no event shall TI's liability arising out of such information exceed the total purchase price of the TI part(s) at issue in this document sold by TI to Customer on an annual basis.

TAPE AND REEL INFORMATION

QUADRANT ASSIGNMENTS FOR PIN 1 ORIENTATION IN TAPE

*All dimensions are nominal

Device	Package Type	Package Drawing	Pins	SPQ	Reel Diameter (mm)	Reel Width W1 (mm)	A0 (mm)	B0 (mm)	K0 (mm)	P1 (mm)	W (mm)	Pin1 Quadrant
BQ27621YZFR-G1A	DSBGA	YZF	9	3000	180.0	8.4	1.78	1.78	0.69	4.0	8.0	Q1
BQ27621YZFT-G1A	DSBGA	YZF	9	250	180.0	8.4	1.78	1.78	0.69	4.0	8.0	Q1

TAPE AND REEL BOX DIMENSIONS

*All dimensions are nominal

Device	Package Type	Package Drawing	Pins	SPQ	Length (mm)	Width (mm)	Height (mm)
BQ27621YZFR-G1A	DSBGA	YZF	9	3000	182.0	182.0	20.0
BQ27621YZFT-G1A	DSBGA	YZF	9	250	182.0	182.0	20.0

EXAMPLE BOARD LAYOUT

YZF0009

DSBGA - 0.625 mm max height

DIE SIZE BALL GRID ARRAY

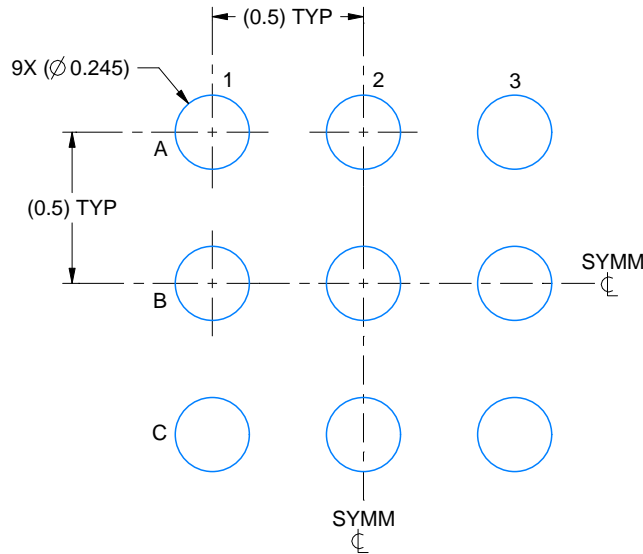

LAND PATTERN EXAMPLE
EXPOSED METAL SHOWN
SCALE: 40X

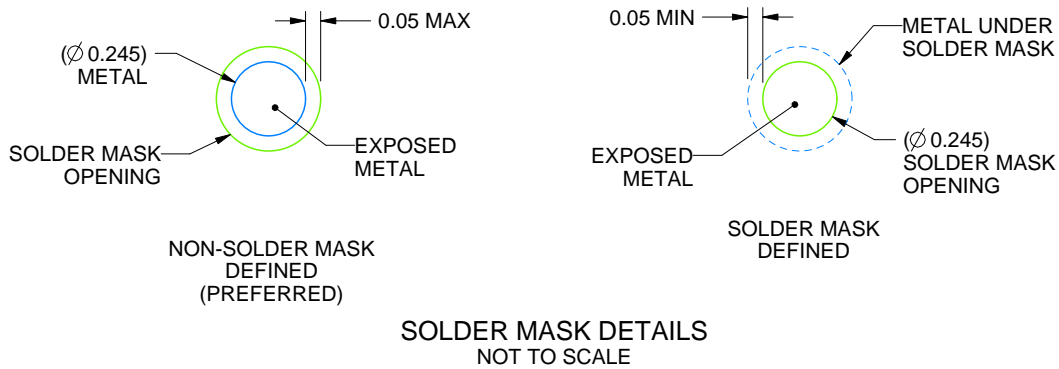

4219558/A 10/2018

NOTES: (continued)

- 3. Final dimensions may vary due to manufacturing tolerance considerations and also routing constraints. See Texas Instruments Literature No. SNVA009 (www.ti.com/lit/snva009).

EXAMPLE STENCIL DESIGN

YZF0009

DSBGA - 0.625 mm max height

DIE SIZE BALL GRID ARRAY

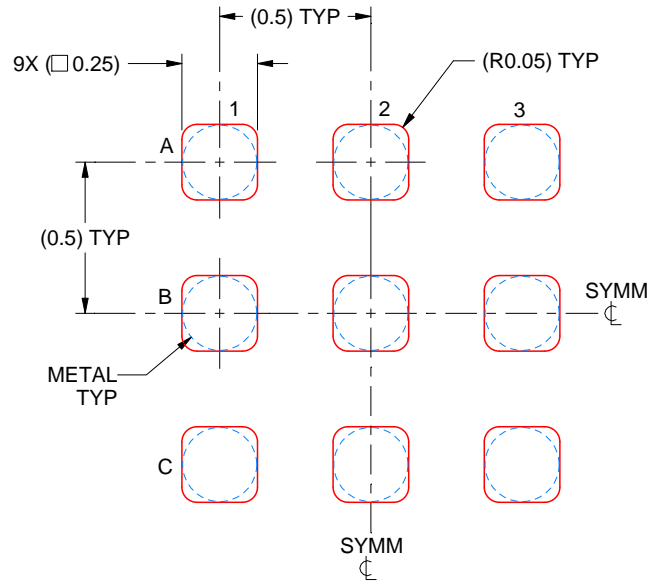

SOLDER PASTE EXAMPLE
BASED ON 0.1 mm THICK STENCIL
SCALE: 40X

4219558/A 10/2018

NOTES: (continued)

4. Laser cutting apertures with trapezoidal walls and rounded corners may offer better paste release.

重要声明和免责声明

TI“按原样”提供技术和可靠性数据（包括数据表）、设计资源（包括参考设计）、应用或其他设计建议、网络工具、安全信息和其他资源，不保证没有瑕疵且不做任何明示或暗示的担保，包括但不限于对适销性、某特定用途方面的适用性或不侵犯任何第三方知识产权的暗示担保。

这些资源可供使用 TI 产品进行设计的熟练开发人员使用。您将自行承担以下全部责任：(1) 针对您的应用选择合适的 TI 产品，(2) 设计、验证并测试您的应用，(3) 确保您的应用满足相应标准以及任何其他功能安全、信息安全、监管或其他要求。

这些资源如有变更，恕不另行通知。TI 授权您仅可将这些资源用于研发本资源所述的 TI 产品的应用。严禁对这些资源进行其他复制或展示。您无权使用任何其他 TI 知识产权或任何第三方知识产权。您应全额赔偿因在这些资源的使用中对 TI 及其代表造成的任何索赔、损害、成本、损失和债务，TI 对此概不负责。

TI 提供的产品受 [TI 的销售条款](#) 或 [ti.com](#) 上其他适用条款/TI 产品随附的其他适用条款的约束。TI 提供这些资源并不会扩展或以其他方式更改 TI 针对 TI 产品发布的适用的担保或担保免责声明。

TI 反对并拒绝您可能提出的任何其他或不同的条款。

邮寄地址：Texas Instruments, Post Office Box 655303, Dallas, Texas 75265

Copyright © 2023，德州仪器 (TI) 公司