

# bq2512x 700nA 适用于可穿戴设备和物联网的低 I<sub>Q</sub> 高度集成式电池充电管理解决方案

## 1 特性

- 延长了系统在充电之后的运行时间
  - 可配置的 300mA 降压稳压器（默认电压为 1.8V）
  - 使能降压稳压器（无负载）时的 I<sub>Q</sub> 为 700nA（典型值）
  - 可配置的负载开关或 100mA 低压降 (LDO) 输出（默认采用负载开关）
  - 快速充电电流高达 300mA
  - 电池稳压精度为 0.5%（可配置电压范围为 3.6V 至 4.65V，阶跃为 10mV）
  - 可配置的终止电流低至 500μA
  - 基于电压的简单电池监视器
- 采用小型封装的高度集成解决方案
  - 2.5mm x 2.5mm WCSP 封装，采用 6 个外部组件以实现最小尺寸的解决方案
  - 通过可调节计时器实现按钮唤醒和复位
  - 电源路径管理可用于系统供电和电池充电
  - 电源路径管理功能可实现低于 50nA 的运输模式电池静态电流，以最大程度延长货架存放期
  - 电池充电器的工作电压为 3.4V – 5.5 V<sub>IN</sub>（5.5V 过压保护 (OVP)/20V 耐压）
  - 提供专用于输入电流限制、充电电流、终止电流和状态输出的引脚
- I<sup>2</sup>C 通信控制
  - 充电电压和电流
  - 终止阈值
  - 输入电流限制
  - VINDPM 阈值
  - 定时器选项
  - 负载开关控制
  - 控制故障中断和状态
  - 系统输出电压调节
  - LDO 输出电压调节

## 2 应用

- 智能手表及其他可穿戴设备
- 健身配件
- 健康状况监控医疗配件
- 可再充电玩具

## 3 说明

bq2512x 是一款高度集成的电池充电管理 IC，集成了可穿戴设备的最常用功能：线性充电器、稳压输出、负载开关、通过计时器手动复位以及电池电压监测。该集成降压转换器是一款具有低 I<sub>Q</sub> 的高效率开关，其采用 DCS 控制技术，可进一步提升轻载效率，负载电流可低至 10μA。运行和关断期间的低静态电流有助于延长电池寿命。该器件支持 5mA 至 300mA 的充电电流。输入电流限制、充电电流、降压转换器输出电压、LDO 输出电压等参数均可通过 I<sup>2</sup>C 接口进行编程。

### 器件信息(1)

| 器件型号    | 封装         | 封装尺寸（标称值）       |
|---------|------------|-----------------|
| BQ2512x | DSBGA (25) | 2.50mm x 2.50mm |

(1) 要了解所有可用封装，请参见数据表末尾的可订购产品附录。

### 简化原理图

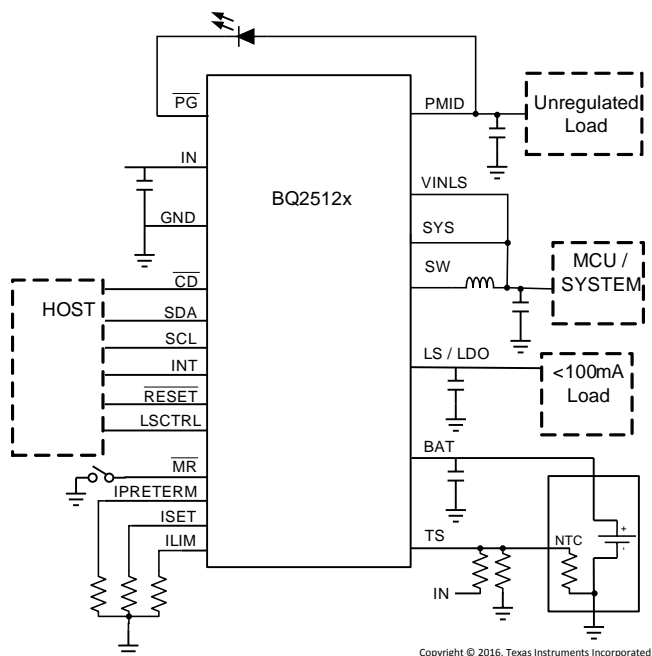

Copyright © 2016, Texas Instruments Incorporated



## 目录

|          |  |    |           |   |    |
|----------|--|----|-----------|---|----|
| 1        | 特性 .....                                     | 1  | 9.4       | Device Functional Modes .....               | 31 |
| 2        | 应用 .....                                     | 1  | 9.5       | Programming .....                           | 33 |
| 3        | 说明 .....                                     | 1  | 9.6       | Register Maps .....                         | 36 |
| 4        | 修订历史记录 .....                                 | 2  | <b>10</b> | <b>Application and Implementation</b> ..... | 47 |
| 5        | 说明 (续) .....                                 | 4  | 10.1      | Application Information .....               | 47 |
| 6        | <b>Device Comparison Table</b> .....         | 4  | 10.2      | Typical Application .....                   | 47 |
| 7        | <b>Pin Configuration and Functions</b> ..... | 5  | <b>11</b> | <b>Power Supply Recommendations</b> .....   | 62 |
| 8        | <b>Specifications</b> .....                  | 7  | <b>12</b> | <b>Layout</b> .....                         | 63 |
|          | 8.1 Absolute Maximum Ratings .....           | 7  | 12.1      | Layout Guidelines .....                     | 63 |
|          | 8.2 ESD Ratings .....                        | 7  | 12.2      | Layout Example .....                        | 63 |
|          | 8.3 Recommended Operating Conditions .....   | 7  | <b>13</b> | <b>器件和文档支持</b> .....                        | 64 |
|          | 8.4 Thermal Information .....                | 8  | 13.1      | 器件支持 .....                                  | 64 |
|          | 8.5 Electrical Characteristics .....         | 9  | 13.2      | 相关链接 .....                                  | 64 |
|          | 8.6 Timing Requirements .....                | 14 | 13.3      | 接收文档更新通知 .....                              | 64 |
|          | 8.7 Typical Characteristics .....            | 17 | 13.4      | 社区资源 .....                                  | 64 |
| <b>9</b> | <b>Detailed Description</b> .....            | 19 | 13.5      | 商标 .....                                    | 64 |
|          | 9.1 Overview .....                           | 19 | 13.6      | 静电放电警告 .....                                | 64 |
|          | 9.2 Functional Block Diagram .....           | 19 | 13.7      | Glossary .....                              | 64 |
|          | 9.3 Feature Description .....                | 20 | <b>14</b> | <b>机械、封装和可订购信息</b> .....                    | 64 |

## 4 修订历史记录

注：之前版本的页码可能与当前版本有所不同。

| Changes from Revision B (May 2016) to Revision C  | Page |
|---|------|
| • Changed or expanded descriptive text in the <i>Pin Functions</i> table for several pin names. ....  | 5    |
| • Deleted sentence: "For proper operation of the device....." from the BAT pin Description in the Pin Functions table. ....   | 6    |
| • 已更改 Conditions statement for <i>Typical Start-Up Timing and Operation</i> timing diagram. ....  | 15   |
| • 已更改 Conditions statement for <i>Battery Operation and Sleep Mode</i> timing diagram. ....   | 16   |
| • 已更改 Q3, Q4, and Q5 symbols in the <i>Functional Block Diagram</i> to PFET devices. ....   | 19   |
| • 已更改 text in <i>Ship Mode</i> section for clarity. ....  | 20   |
| • 已更改 text in <i>Active Battery Only Connected</i> for clarity. ....  | 20   |
| • Subscripted V <sub>BATUVLO</sub> signal name in <i>Active Battery Only Connected</i> section. ....  | 20   |
| • 已更改 the description for <i>Input Overvoltage Protection and Undervoltage Status Indication</i> section for clarification. ....  | 22   |
| • 已更改 text in <i>Battery Charging Process and Charge Profile</i> section for clarity. ....  | 22   |
| • 已更改 I <sub>PRETERM</sub> and IPRE_TERM names to IPRETERM in <i>Termination and Pre-Charge Current Programming by External Components (IPRETERM)</i> section for clarification. .... | 23   |
| • 已更改 terms in <i>公式 5</i> for clarification. ....  | 27   |
| • 已更改 and added text in <i>Status Indicators (PG and INT)</i> section for clarification. ....   | 27   |
| • 已更改 text in <i>Buck (PWM) Output</i> section. ....  | 28   |
| • 已删除 "(TO BE TESTED)" from the COMMENT column of <i>表 8</i> . ....   | 29   |
| • 已更改 first sentence of <i>Manual Reset Timer and Reset Output (MR and RESET)</i> description. ....   | 30   |
| • 已更改 text in <i>Manual Reset Timer and Reset Output (MR and RESET)</i> section for clarification. ....   | 30   |
| • 已更改 text in <i>Modes and Functions</i> for clarification. ....  | 31   |
| • 已更改 text in <i>Fault and Status Condition Responses</i> for clarification. ....   | 32   |
| • 已更改 text in <i>表 12</i> . ....  | 36   |
| • 已添加 text in <i>Fast Charge Control Register</i> description. ....   | 39   |

**Changes from Revision A (August 2015) to Revision B**
**Page**

|  |    |
|--|----|
| • Added BQ25121 device to data sheet .....   | 4  |
| • Added BQ25121 device to BATTERY-PACK NTC MONITOR specs in the Electrical Characteristics table.....  | 11 |
| • 已更改 图 1 .....  | 15 |
| • 已添加 图 14 typical characteristics graph .....   | 17 |
| • 已更改 text From: "... current out of ISET is 1/400 (±10%)..." To: "...current out of ISET is 1/100 (±10%)..." in <a href="#">Charge Current Programming by External Components (ISET)</a> section.....     | 24 |
| • 已添加 sentence "This bit is for testing and debug only and not intended to be used in the final system." to the <a href="#">Buck (PWM) Output</a> for clarification of the EN_SYS_OUT bit description..... | 28 |
| • 已添加 text to Bit B3 Description in 表 14 .....   | 38 |

**Changes from Original (August 2015) to Revision A**
**Page**

|                           |   |
|---------------------------|---|
| • 已从“产品预览”更改为“量产数据” ..... | 1 |
|---------------------------|---|

## 5 说明（续）

该器件采用标准锂离子充电曲线分三个阶段对电池进行充电：预充电、恒流和恒压。该器件包含一个基于电压的 JEITA 兼容电池组热敏电阻监视输入 (TS)，可监视电池温度并自动更改充电参数，从而防止电池在超出其安全温度范围的温度下充电。该充电器针对 5V USB 输入进行了优化，可承受 20V 线路瞬态电压。降压转换器由输入或电池供电。当处于仅电池模式时，器件可由电压最高达 4.65V 的电池供电运行。

利用可配置负载开关，器件可断开与不常用器件的连接，从而优化系统。通过定时器手动复位可实现多种优化唤醒和复位的不同配置选项。基于电压的简单监视器为主机提供电池电量信息，在已编程  $V_{(BATREG)}$  的 60% 至 100% 电量范围内单位增量为 2%。

## 6 Device Comparison Table

| PART NUMBER | VINDPM  | DEFAULT SYS OUTPUT | DEFAULT LDO OUTPUT | DEFAULT VBERG | DEFAULT CHARGE CURRENT | DEFAULT TERMINATION CURRENT | DEFAULT SHIP MODE |
|-------------|---------|--------------------|--------------------|---------------|------------------------|-----------------------------|-------------------|
| BQ25120     | Enabled | 1.8 V              | Load Switch        | 4.2 V         | 10 mA                  | 2 mA                        | Off               |
| BQ25121     | Enabled | 2.5 V              | Load Switch        | 4.2 V         | 10 mA                  | 2 mA                        | Off               |

## 7 Pin Configuration and Functions

**YFP Package  
25-Pin (DSBGA)  
Top View**

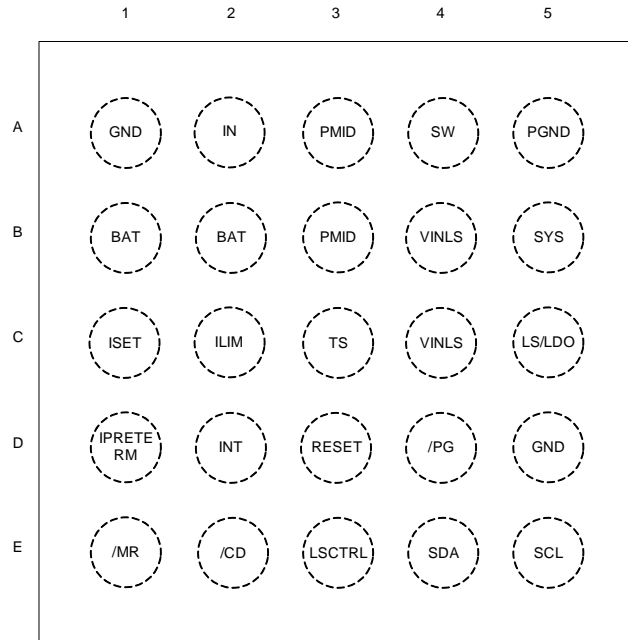

**Pin Functions**

| PIN                    |        | I/O | DESCRIPTION  |
|------------------------|--------|-----|--|
| NAME                   | NO.    |     |  |
| IN                     | A2     | I   | DC Input Power Supply. IN is connected to the external DC supply. Bypass IN to GND with at least 1 $\mu\text{F}$ of capacitance using a ceramic capacitor.   |
| PMID                   | A3, B3 | I/O | High Side Bypass Connection. Connect at least 3 $\mu\text{F}$ of ceramic capacitance with DC bias derating from PMID to GND as close to the PMID and GND pins as possible.   |
| GND                    | A1, D5 |     | Ground connection. Connect to the ground plane of the circuit.   |
| PGND                   | A5     |     | Power ground connection. Connect to the ground plane of the circuit. Connect the output filter cap from the buck converter to this ground as shown in the layout example.  |
| $\overline{\text{CD}}$ | E2     | I   | Chip Disable. Drive $\overline{\text{CD}}$ low to place the part in High-Z mode with battery only present, or enable charging when $V_{\text{IN}}$ is valid. Drive $\overline{\text{CD}}$ high for Active Battery mode when battery only is present, and disable charge when $V_{\text{IN}}$ is present. $\overline{\text{CD}}$ is pulled low internally with 900 k $\Omega$ .   |
| SDA                    | E4     | I/O | I <sup>2</sup> C Interface Data. Connect SDA to the logic rail through a 10-k $\Omega$ resistor.   |
| SCL                    | E5     | I   | I <sup>2</sup> C Interface Clock. Connect SCL to the logic rail through a 10-k $\Omega$ resistor.  |
| ILIM                   | C2     | I   | Adjustable Input Current Limit Programming. Connect a resistor from ILIM to GND to program the input current limit. The input current includes the system load and the battery charge current. Connect ILIM to GND to set the input current limit to the internal default threshold. ILIM can also be updated through I <sup>2</sup> C.  |
| LSCTRL                 | E3     | I   | Load Switch and LDO Control Input. Pull high to enable the LS/LDO output, pull low to disable the LS/LDO output.   |
| ISET                   | C1     | I   | Fast-Charge Current Programming Input. Connect a resistor from ISET to GND to program the fast-charge current level. Connect a resistor from ISET to GND to set the charge current to the internal default. ISET can also be updated through I <sup>2</sup> C. While charging, the voltage at ISET reflects the actual charging current and can be used to monitor charge current if an ISET resistor is present and the device is not in host mode. |
| IPRETERM               | D1     | I   | Termination current programming input. Connect a 0- $\Omega$ to 10-k $\Omega$ resistor from IPRETERM to GND to program the termination current between 5% and 20% of the charge current. The pre-charge current is the same as the termination current setting. Connect IPRETERM to GND to set the termination current to the internal default threshold. IPRETERM can also be updated through I <sup>2</sup> C.                                     |

**Pin Functions (continued)**

| PIN                       |        | I/O | DESCRIPTION   |
|---------------------------|--------|-----|---|
| NAME                      | NO.    |     |   |
| INT                       | D2     | O   | Status Output. INT is an open-drain output that signals charging status and fault interrupts. INT pulls low during charging. INT is high impedance when charging is complete, disabled, or the charger is in high impedance mode. When a fault occurs, a 128μs pulse is sent out as an interrupt for the host. INT charge indicator function is enabled/disabled using the EN_INT bit in the control register. Connect INT to a logic rail using an LED for visual indication of charge status or through a 100kΩ resistor to communicate with the host processor.  |
| $\overline{\text{PG}}$    | D4     | O   | Open-drain Power Good status indication output. $\overline{\text{PG}}$ pulls to GND when $V_{\text{IN}}$ is above $V_{(\text{BAT})} + V_{\text{SLP}}$ and less than $V_{\text{OVP}}$ . $\overline{\text{PG}}$ is high-impedance when the input power is not within specified limits. Connect $\overline{\text{PG}}$ to the desired logic voltage rail using a 1kΩ to 100kΩ resistor, or use with an LED for visual indication. $\overline{\text{PG}}$ can also be configured as a push-button voltage shifted output (MRS) in the registers, where the output of the $\overline{\text{PG}}$ pin reflects the status of the MR input, but pulled up to the desired logic voltage rail using a 1kΩ to 100kΩ resistor. |
| $\overline{\text{RESET}}$ | D3     | O   | Reset Output. $\overline{\text{RESET}}$ is an open drain active low output that goes low when $\overline{\text{MR}}$ is held low for longer than $t_{\text{RESET}}$ , which is configurable by the MRRESET registers. $\overline{\text{RESET}}$ is deasserted after the $t_{\text{RESET\_D}}$ , typically 400ms.  |
| $\overline{\text{MR}}$    | E1     | I   | Manual Reset Input. $\overline{\text{MR}}$ is a push-button input that must be held low for greater than $t_{\text{RESET}}$ to assert the reset output. If $\overline{\text{MR}}$ is pressed for a shorter period, there are two programmable timer events, $t_{\text{WAKE1}}$ and $t_{\text{WAKE2}}$ , that trigger an interrupt to the host. The $\overline{\text{MR}}$ input can also be used to bring the device out of Ship mode.  |
| SW                        | A4     | O   | Inductor Connection. Connect to the switched side of the external inductor.   |
| SYS                       | B5     | I   | System Voltage Sense Connection. Connect SYS to the system output at the output bulk capacitors. Bypass SYS locally with at least 4.7 μF of effective ceramic capacitance.  |
| LS/LDO                    | C5     | O   | Load Switch or LDO output. Connect 1 μF of effective ceramic capacitance to this pin to assure stability. Be sure to account for capacitance bias voltage derating when selecting the capacitor.  |
| VINLS                     | B4, C4 | I   | Input to the Load Switch / LDO output. Connect 1 μF of effective ceramic capacitance from this pin to GND.  |
| BAT                       | B1, B2 | I/O | Battery Connection. Connect to the positive terminal of the battery. Bypass BAT to GND with at least 1 μF of ceramic capacitance.   |
| TS                        | C3     | I   | Battery Pack NTC Monitor. Connect TS to the center tap of a resistor divider from VIN to GND. The NTC is connected from TS to GND. The TS function provides four thresholds for JEITA compatibility. TS faults are reported by the I <sup>2</sup> C interface during charge mode.   |

## 8 Specifications

### 8.1 Absolute Maximum Ratings

over operating free-air temperature range (unless otherwise noted) <sup>(1)</sup>

|                                       |  |         | MIN  | MAX | UNIT |
|---------------------------------------|--|---------|------|-----|------|
| Input voltage                         | IN   | wrt GND | -0.3 | 20  | V    |
|                                       | PMID, VINLS  | wrt GND | -0.3 | 7.7 | V    |
|                                       | CD, SDA, SCL, ILIM, ISET, IPRETERM, LSCTRL, INT, RESET, TS | wrt GND | -0.3 | 5.5 | V    |
| Output voltage                        | SYS  |         | 3.6  | V   |      |
| Input current                         | IN   |         | 400  | mA  |      |
| Sink current                          | INT  |         | 10   | mA  |      |
| Sink/Source Current                   | RESET  |         | 10   | mA  |      |
| Output Voltage Continuous             | SW   |         | -0.7 | 7.7 | V    |
| Output Current Continuous             | SW   |         | 400  | mA  |      |
|                                       | SYS, BAT   |         | 300  | mA  |      |
| Current                               | LS/LDO   |         | 150  | mA  |      |
| BAT Operating Voltage                 | VBAT, MR,  |         | 6.6  | V   |      |
| Junction Temperature                  |  |         | -40  | 125 | °C   |
| Storage Temperature, T <sub>stg</sub> |  |         |      | 300 | °C   |

- (1) Stresses beyond those listed under *Absolute Maximum Ratings* may cause permanent damage to the device. These are stress ratings only, which do not imply functional operation of the device at these or any other conditions beyond those indicated under *Recommended Operating Conditions*. Exposure to absolute-maximum-rated conditions for extended periods may affect device reliability.

### 8.2 ESD Ratings

|                    |                         |  | VALUE | UNIT |
|--------------------|-------------------------|--|-------|------|
| V <sub>(ESD)</sub> | Electrostatic discharge | Human body model (HBM), per ANSI/ESDA/JEDEC JS-001 <sup>(1)</sup>              | ±2000 | V    |
|                    |                         | Charged device model (CDM), per JEDEC specification JESD22-C101 <sup>(2)</sup> | ±500  |      |

- (1) JEDEC document JEP155 states that 500-V HBM allows safe manufacturing with a standard ESD control process.  
(2) JEDEC document JEP157 states that 250-V CDM allows safe manufacturing with a standard ESD control process.

### 8.3 Recommended Operating Conditions

over operating free-air temperature range (unless otherwise noted)

|   |   | MIN | NOM | MAX                | UNIT |
|---|---|-----|-----|--------------------|------|
| V <sub>IN</sub>                         | IN voltage range                                    | 3.4 | 5   | 20                 | V    |
|   | IN operating voltage range, recommended             | 3.4 | 5   | 5.5                |      |
| V <sub>(BAT)</sub>                      | V <sub>(BAT)</sub> operating voltage range          |     |     | 5.5 <sup>(1)</sup> | V    |
| V <sub>(VINLS)</sub>                    | VINLS voltage range for Load Switch                 | 0.8 |     | 5.5 <sup>(2)</sup> | V    |
| V <sub>(VINLS)</sub>                    | VINLS voltage range for LDO                         | 2.2 |     | 5.5                | V    |
| I <sub>IN</sub>                         | Input Current, IN input                             |     |     | 400                | mA   |
| I <sub>(SW)</sub>                       | Output Current from SW, DC                          |     |     | 300                | mA   |
| I <sub>(PMID)</sub>                     | Output Current from PMID, DC                        |     |     | 300                | mA   |
| ILS/LDO                                 | Output Current from LS/LDO                          |     |     | 100                | mA   |
| I <sub>(BAT)</sub> , I <sub>(SYS)</sub> | Charging and discharging using internal battery FET |     |     | 300                | mA   |
| T <sub>J</sub>                          | Operating junction temperature range                | -40 |     | 125                | °C   |

- (1) Any voltage greater than shown should be a transient event.  
(2) These inputs will support 6.6 V for less than 10% of the lifetime at V<sub>(BAT)</sub> or V<sub>IN</sub>, with a reduced current and/or performance.

## 8.4 Thermal Information

| THERMAL METRIC <sup>(1)</sup> |  | bq2512x     |      |
|-------------------------------|--|-------------|------|
|                               |  | YFP (DSBGA) |      |
|                               |  | 25 PINS     |      |
|                               |  |             | UNIT |
| $R_{\theta JA}$               | Junction-to-ambient thermal resistance       | 60          | °C/W |
| $R_{\theta JC(top)}$          | Junction-to-case (top) thermal resistance    | 0.3         | °C/W |
| $R_{\theta JB}$               | Junction-to-board thermal resistance         | 12.0        | °C/W |
| $\psi_{JT}$                   | Junction-to-top characterization parameter   | 1.2         | °C/W |
| $\psi_{JB}$                   | Junction-to-board characterization parameter | 12.0        | °C/W |
| $R_{\theta JC(bot)}$          | Junction-to-case (bottom) thermal resistance | N/A         | °C/W |

(1) For more information about traditional and new thermal metrics, see the [Semiconductor and IC Package Thermal Metrics](#) application report.



## 8.5 Electrical Characteristics

Circuit of [Figure 1](#),  $V_{(UVLO)} < V_{IN} < V_{(OVP)}$  and  $V_{IN} > V_{(BAT)} + V_{(SLP)}$ ,  $T_J = -40^\circ\text{C}$  to  $85^\circ\text{C}$  and  $T_J = 25^\circ\text{C}$  for typical values (unless otherwise noted)

| PARAMETERS   |   | TEST CONDITIONS  | MIN             | TYP                                     | MAX  | UNIT             |
|--|---|--|-----------------|---|------|------------------|
| <b>INPUT CURRENTS</b>                                |   |  |                 |   |      |                  |
| $I_{IN}$   | Supply Current for Control                            | $V_{(UVLO)} < V_{IN} < V_{(OVP)}$ and $V_{IN} > V_{(BAT)} + V_{(SLP)}$ PWM Switching, $-40^\circ\text{C} < T_J < 85^\circ\text{C}$   |                 | 1                                       |      | mA               |
|  |   | $V_{(UVLO)} < V_{IN} < V_{(OVP)}$ and $V_{IN} > V_{(BAT)} + V_{(SLP)}$ PWM NOT Switching   |                 |   | 3    | mA               |
|  |   | $0^\circ\text{C} < T_J < 85^\circ\text{C}$ , $V_{IN} = 5\text{ V}$ , Charge Disabled   |                 |   | 1.5  | mA               |
| $I_{(BAT\_HIZ)}$                                     | Battery discharge current in High Impedance Mode      | $0^\circ\text{C} < T_J < 60^\circ\text{C}$ , $V_{IN} = 0\text{ V}$ , High-Z Mode, PWM Not Switching, $V_{(BUVLO)} < V_{(BAT)} < 4.65\text{ V}$   |                 | 0.7                                     | 1.2  | $\mu\text{A}$    |
|  |   | $0^\circ\text{C} < T_J < 60^\circ\text{C}$ , $V_{IN} = 0\text{ V}$ , High-Z Mode, PWM Not Switching, $V_{(BUVLO)} < V_{(BAT)} < 6.6\text{ V}$  |                 | 0.9                                     | 1.5  | $\mu\text{A}$    |
|  |   | $0^\circ\text{C} < T_J < 60^\circ\text{C}$ , $V_{IN} = 0\text{ V}$ or floating, High-Z Mode, PWM Switching, No Load  |                 | 0.75                                    | 3.5  | $\mu\text{A}$    |
|  |   | $0^\circ\text{C} < T_J < 85^\circ\text{C}$ , $V_{IN} = 0\text{ V}$ , High-Z Mode, PWM Switching, LSLDO enabled   |                 | 1.35                                    | 4.25 | $\mu\text{A}$    |
| $I_{(BAT\_ACTIVE)}$                                  | Battery discharge current in Active Battery Mode      | $0^\circ\text{C} < T_J < 85^\circ\text{C}$ , $V_{IN} = 0\text{ V}$ , Active Battery Mode, PWM Switching, LSLDO enabled, I2C Enabled, $V_{(BUVLO)} < V_{(BAT)} < 4.65\text{ V}$                                     |                 | 6.8                                     | 12   | $\mu\text{A}$    |
|  |   | $0^\circ\text{C} < T_J < 85^\circ\text{C}$ , $0 < V_{IN} < V_{(UVLO)}$ , Active Battery Mode, PWM Switching, LSLDO disabled, I2C Enabled, $\overline{CD} = \text{Low}$ , $V_{(BUVLO)} < V_{(BAT)} < 4.65\text{ V}$ |                 | 6.2                                     | 11   | $\mu\text{A}$    |
| $I_{(BAT\_SHIP)}$                                    | Battery discharge current in Ship Mode                | $0^\circ\text{C} < T_J < 85^\circ\text{C}$ , $V_{IN} = 0\text{ V}$ , Ship Mode   |                 | 2                                       | 150  | nA               |
| <b>POWER-PATH MANAGEMENT and INPUT CURRENT LIMIT</b> |   |  |                 |   |      |                  |
| $V_{DO(IN-PMID)}$                                    | $V_{IN} - V_{(PMID)}$                                 | $V_{IN} = 5\text{ V}$ , $I_{IN} = 300\text{ mA}$   |                 | 125                                     | 170  | mV               |
| $V_{DO(BAT-PMID)}$                                   | $V_{(BAT)} - V_{(PMID)}$                              | $V_{IN} = 0\text{ V}$ , $V_{(BAT)} > 3\text{ V}$ , $I_{IF} = 400\text{ mA}$  |                 | 120                                     | 160  | mV               |
| $V_{(BSUP1)}$  | Enter supplement mode threshold                       | $V_{(BAT)} > V_{(BUVLO)}$  |                 | $V_{(PMID)} < V_{(BAT)} - 25\text{ mV}$ |      | V                |
| $V_{(BSUP2)}$  | Exit supplement mode threshold                        | $V_{(BAT)} > V_{(BUVLO)}$  |                 | $V_{(PMID)} < V_{(BAT)} - 5\text{ mV}$  |      | V                |
| $I_{(BAT\_OCP)}$                                     | Current Limit, Discharge Mode                         | $V_{(BAT)} > V_{(BUVLO)}$  | 0.85            | 1.15                                    | 1.35 | A                |
| $I_{(ILIM)}$   | Input Current Limit                                   | Programmable Range, 50-mA steps  | 50              |   | 400  | mA               |
|  | Maximum Input Current using ILIM                      |  |                 | $K_{(ILIM)} / R_{(ILIM)}$               |      |                  |
|  | $I_{(ILIM)}$ accuracy                                 | $I_{(ILIM)}$ accuracy  | 50 mA to 100 mA | -12%                                    |      | 12%              |
| $K_{(ILIM)}$   | Maximum input current factor                          | $I_{(ILIM)} = 50\text{ mA}$ to $100\text{ mA}$   | 175             | 200                                     | 225  | $\text{A}\Omega$ |
|  |   | $I_{(ILIM)} = 100\text{ mA}$ to $400\text{ mA}$  | 190             | 200                                     | 210  | $\text{A}\Omega$ |
| $V_{(IN\_DPM)}$                                      | Input voltage threshold when input current is reduced | Programmable Range using $V_{(IN\_DPM)}$ Registers. Can be disabled using $V_{(IN\_DPM\_ON)}$  | 4.2             |   | 4.9  | V                |
|  | $V_{(IN\_DPM)}$ threshold accuracy                    |  | -3%             |   | 3%   |                  |
| <b>BATTERY CHARGER</b>                               |   |  |                 |   |      |                  |
| $V_{D(PPM)}$   | PMID voltage threshold when charge current is reduced | Above $V_{(BATREG)}$   |                 | 0.2                                     |      | V                |
| $R_{ON(BAT-PMID)}$                                   | Internal Battery Charger MOSFET on-resistance         | Measured from BAT to PMID, $V_{(BAT)} = 4.35\text{ V}$ , High-Z mode   |                 | 300                                     | 400  | $\text{m}\Omega$ |
| $V_{(BATREG)}$                                       | Charge Voltage  | Operating in voltage regulation, Programmable Range, 10-mV steps   | 3.6             |   | 4.65 | V                |
|  | Voltage Regulation Accuracy                           | $T_J = 25^\circ\text{C}$   | -0.5%           |   | 0.5% |                  |
|  |   | $T_J = 0^\circ\text{C}$ to $85^\circ\text{C}$  | -0.5%           |   | 0.5% |                  |

## Electrical Characteristics (continued)

Circuit of [Figure 1](#),  $V_{(UVLO)} < V_{IN} < V_{(OVP)}$  and  $V_{IN} > V_{(BAT)} + V_{(SLP)}$ ,  $T_J = -40^{\circ}\text{C}$  to  $85^{\circ}\text{C}$  and  $T_J = 25^{\circ}\text{C}$  for typical values (unless otherwise noted)

| PARAMETERS                       |   | TEST CONDITIONS  | MIN   | TYP                       | MAX  | UNIT           |
|----------------------------------|---|--|-------|---------------------------|------|----------------|
| $I_{(CHARGE)}$                   | Fast Charge Current Range                     | $V_{(BATUVLO)} < V_{(BAT)} < V_{(BATREG)}$   | 5     |                           | 300  | mA             |
|                                  | Fast Charge Current using ISET                |  |       | $K_{(ISET)} / R_{(ISET)}$ |      | A              |
|                                  | Fast Charge Current Accuracy                  |  | -5%   |                           | 5%   |                |
| $K_{(ISET)}$                     | Fast Charge Current Factor                    | $5 \text{ mA} > I_{(CHARGE)} > 300 \text{ mA}$   | 190   | 200                       | 210  | $A\Omega$      |
| $I_{(TERM)}$                     | Termination charge current                    | Termination current programmable range over $I^2C$   | 0.5   |                           | 37   | mA             |
|                                  | Termination Current using IPRETERM            | $I_{(CHARGE)} < 300 \text{ mA}$ , $R_{(ITERM)} = 15 \text{ k}\Omega$                       |       | 5                         |      | % of $I_{SET}$ |
|                                  |   | $I_{(CHARGE)} < 300 \text{ mA}$ , $R_{(ITERM)} = 4.99 \text{ k}\Omega$                     |       | 10                        |      | % of $I_{SET}$ |
|                                  |   | $I_{(CHARGE)} < 300 \text{ mA}$ , $R_{(ITERM)} = 1.65 \text{ k}\Omega$                     |       | 15                        |      | % of $I_{SET}$ |
|                                  |   | $I_{(CHARGE)} < 300 \text{ mA}$ , $R_{(ITERM)} = 549 \Omega$                               |       | 20                        |      | % of $I_{SET}$ |
| Accuracy                         | $I_{(TERM)} > 4 \text{ mA}$                   | -10%   |       | 10%                       |      |                |
| $t_{DGL(TERM)}$                  | TERM deglitch time                            | Both rising and falling, 2-mV over-drive, $t_{RISE}$ , $t_{FALL} = 100 \text{ ns}$         |       | 64                        |      | ms             |
| $I_{(PRE\_CHARGE)}$              | Pre-charge current                            | Pre-charge current programmable range over $I^2C$  | 0.5   |                           | 37   | mA             |
|                                  | Pre-charge Current using $I_{PRETERM}$        |  |       | $I_{(TERM)}$              |      | A              |
|                                  | Accuracy                                      |  | -10%  |                           | 10%  |                |
| $V_{(RCH)}$                      | Recharge threshold voltage                    | Below $V_{(BATREG)}$   | 100   | 120                       | 140  | mV             |
| $t_{DGL(RCHG)}$                  | Recharge threshold deglitch time              | $t_{FALL} = 100 \text{ ns typ}$ , $V_{(RCH)}$ falling                                      |       | 32                        |      | ms             |
| <b>SYS OUTPUT</b>                |   |  |       |                           |      |                |
| $R_{DS(ON\_HS)}$                 |   | PMID = 3.6 V, $I_{(SYS)} = 50 \text{ mA}$  |       | 675                       | 850  | $m\Omega$      |
| $R_{DS(ON\_LS)}$                 |   | PMID = 3.6 V, $I_{(SYS)} = 50 \text{ mA}$  |       | 300                       | 475  | $m\Omega$      |
| $R_{DS(CH\_SYS)}$                | MOSFET on-resistance for SYS discharge        | $V_{IN} = 3.6 \text{ V}$ , $I_{OUT} = -10 \text{ mA}$ into $V_{OUT}$ pin                   |       | 22                        | 40   | $\Omega$       |
| $I_{(LIMF)}$                     | SW Current limit HS                           | $2.2 \text{ V} < V_{(PMID)} < 5.5 \text{ V}$   | 525   | 600                       | 675  | mA             |
|                                  | SW Current limit LS                           | $2.2 \text{ V} < V_{(PMID)} < 5.5 \text{ V}$   | 525   | 700                       | 850  | mA             |
| $I_{(LIM\_SS)}$                  | PMOS switch current limit during softstart    | Current limit is reduced during softstart  | 80    | 130                       | 200  | mA             |
| $V_{SYS}$                        | SYS Output Voltage Range                      | Programmable range, 100 mV Steps   | 1.1   |                           | 3.3  | V              |
|                                  | Output Voltage Accuracy                       | $V_{IN} = 5 \text{ V}$ , PFM mode, $I_{OUT} = 10 \text{ mA}$ , $V_{(SYS)} = 1.8 \text{ V}$ | -2.5% | 0                         | 2.5% |                |
|                                  | DC Output Voltage Load Regulation in PWM mode | $V_{OUT} = 2 \text{ V}$ , over load range  |       | 0.01                      |      | %/mA           |
|                                  | DC Output Voltage Line Regulation in PWM mode | $V_{OUT} = 2 \text{ V}$ , $I_{OUT} = 100 \text{ mA}$ , over $V_{IN}$ range                 |       | 0.01                      |      | %/V            |
| <b>LS/LDO OUTPUT</b>             |   |  |       |                           |      |                |
| $V_{IN(LS)}$                     | Input voltage range for LS/LDO                | Load Switch Mode   | 0.8   |                           | 6.6  | V              |
|                                  | Input voltage range for LS/LDO                | LDO Mode   | 2.2   |                           | 6.6  | V              |
| $V_{OUT}$                        | DC output accuracy                            | $T_J = 25^{\circ}\text{C}$   | -2%   | $\pm 1\%$                 | 2%   |                |
|                                  |   | Over $V_{IN}$ , $I_{OUT}$ , temperature  | -3%   | $\pm 2\%$                 | 3%   |                |
| $V_{LDO}$                        | Output range for LS/LDO                       | Programmable Range, 0.1 V steps  | 0.8   |                           | 3.3  | V              |
| $\Delta V_{OUT} / \Delta V_{IN}$ | DC Line regulation                            | $V_{OUT(NOM)} + 0.5 \text{ V} < V_{IN} < 6.6 \text{ V}$ , $I_{OUT} = 5 \text{ mA}$         | -1%   |                           | 1%   |                |
|                                  | DC Load regulation                            | $0 \text{ mA} < I_{OUT} < 100 \text{ mA}$  | -1%   |                           | 1%   |                |
|                                  | Load Transient                                | $2 \mu\text{A}$ to $100 \text{ mA}$ , $V_{OUT} = 1.8 \text{ V}$                            | -120  |                           | 60   | mV             |
| $R_{DS(ON\_LDO)}$                | FET $R_{dson}$                                | $V_{(VINLS)} = 3.6 \text{ V}$  |       | 460                       | 600  | $m\Omega$      |
| $R_{(DSCH\_LSLDO)}$              | MOSFET on-resistance for LS/LDO discharge     | $1.7 \text{ V} < V_{(VINLS)} < 6.6 \text{ V}$ , $I_{LOAD} = -10 \text{ mA}$                |       | 30                        |      | $\Omega$       |

## Electrical Characteristics (continued)

Circuit of [Figure 1](#),  $V_{(UVLO)} < V_{IN} < V_{(OVP)}$  and  $V_{IN} > V_{(BAT)} + V_{(SLP)}$ ,  $T_J = -40^{\circ}\text{C}$  to  $85^{\circ}\text{C}$  and  $T_J = 25^{\circ}\text{C}$  for typical values (unless otherwise noted)

| PARAMETERS   |   | TEST CONDITIONS  | MIN                     | TYP             | MAX                     | UNIT               |            |
|--|---|--|-------------------------|-----------------|-------------------------|--------------------|------------|
| $I_{(OCL\_LDO)}$                                     | Output Current Limit – LDO                    | $V_{LS/LDO} = 0.9 \times V_{LS/LDO(NOM)}$                            | 275                     | 365             | 450                     | mA                 |            |
| $I_{(LS/LDO)}$                                       | Output Current                                | $V_{(VINLS)} = 3.6\text{ V}$ , $V_{LSLDO} = 3.3\text{ V}$            |                         |                 | 100                     | mA                 |            |
|  |   | $V_{(VINLS)} = 3.3\text{ V}$ , $V_{LSLDO} = 0.8\text{ V}$            |                         |                 | 100                     | mA                 |            |
|  |   | $V_{(VINLS)} = 2.2\text{ V}$ , $V_{LSLDO} = 0.8\text{ V}$            |                         |                 | 10                      | mA                 |            |
| $I_{IN(LDO)}$  | Quiescent current for VINLS in LDO mode       |  |                         | 0.9             |                         | $\mu\text{A}$      |            |
|  | OFF-state supply current                      |  |                         | 0.25            |                         | $\mu\text{A}$      |            |
| $V_{IH(LSCTRL)}$                                     | High-level input voltage for LSCTRL           | $1.15\text{ V} > V_{(VINLS)} > 6.6\text{ V}$                         | $0.75 \times V_{(SYS)}$ |                 | 6.6                     | V                  |            |
| $V_{IL(LSCTRL)}$                                     | Low-level input voltage for LSCTRL            | $1.15\text{ V} > V_{(VINLS)} > 6.6\text{ V}$                         |                         |                 | $0.25 \times V_{(SYS)}$ | V                  |            |
| <b>PUSHBUTTON TIMER (<math>\overline{MR}</math>)</b> |   |  |                         |                 |                         |                    |            |
| $V_{IL}$   | Low-level input voltage                       | $V_{BAT} > V_{BUVLO}$  |                         |                 | 0.3                     | V                  |            |
| $R_{PU}$   | Internal pull-up resistance                   |  |                         | 120             |                         | k $\Omega$         |            |
| <b>VBAT MONITOR</b>                                  |   |  |                         |                 |                         |                    |            |
| $V_{BMON}$   | Battery Voltage Monitor Accuracy              | $V_{(BAT)}$ Falling - Including 2% increment                         | -3.5                    |                 | 3.5                     | % $V_{(BATREG)}$   |            |
| <b>BATTERY-PACK NTC MONITOR</b>                      |   |  |                         |                 |                         |                    |            |
| $V_{HOT}$  | High temperature threshold                    | $V_{TS}$ falling, 1% $V_{IN}$ Hysteresis                             | bq25120                 | 14.5            | 15                      | 15.2               | % $V_{IN}$ |
|  |   |  | bq25121                 |                 |                         |                    |            |
| $V_{WARM}$   | Warm temperature threshold                    | $V_{TS}$ falling, 1% $V_{IN}$ Hysteresis                             | bq25120                 | 20.1            | 20.5                    | 20.8               | % $V_{IN}$ |
|  |   |  | bq25121                 | 20.2            | 20.6                    | 20.9               |            |
| $V_{COOL}$   | Cool temperature threshold                    | $V_{TS}$ rising, 1% $V_{IN}$ Hysteresis                              | bq25120                 | 35.4            | 36                      | 36.4               | % $V_{IN}$ |
|  |   |  | bq25121                 | 35.5            | 36.1                    | 36.5               |            |
| $V_{COLD}$   | Low temperature threshold                     | $V_{TS}$ rising, 1% $V_{IN}$ Hysteresis                              | bq25120                 | 39.3            | 39.8                    | 40.2               | % $V_{IN}$ |
|  |   |  | bq25121                 | 39.5            | 40                      | 40.3               |            |
| $TS_{OFF}$   | TS Disable threshold                          | $V_{TS}$ rising, 2% $V_{IN}$ Hysteresis                              | bq25120                 | 55              |                         | 60                 | % $V_{IN}$ |
|  |   |  | bq25121                 |                 |                         |                    |            |
| <b>PROTECTION</b>                                    |   |  |                         |                 |                         |                    |            |
| $V_{(UVLO)}$   | IC active threshold voltage                   | $V_{IN}$ rising  | 3.4                     | 3.6             | 3.8                     | V                  |            |
| $V_{(UVLO(HYS))}$                                    | IC active hysteresis                          | $V_{IN}$ falling from above $V_{(UVLO)}$                             |                         | 150             |                         | mV                 |            |
| $V_{(BUVLO)}$  | Battery Undervoltage Lockout threshold Range  | Programmable Range for $V_{(BUVLO)}$ VBAT falling, 150 mV Hysteresis | 2.2                     |                 | 3.0                     | V                  |            |
|  | Default Battery Undervoltage Lockout Accuracy | $V_{(BAT)}$ falling  | -2.5%                   |                 | 2.5%                    |                    |            |
| $V_{(BATSHORT)}$                                     | Battery short circuit threshold               | Battery voltage falling  |                         | 2               |                         | V                  |            |
| $V_{(BATSHORT\_HYS)}$                                | Hysteresis for $V_{(BATSHORT)}$               |  |                         | 100             |                         | mV                 |            |
| $I_{(BATSHORT)}$                                     | Battery short circuit charge current          |  |                         | $I_{(PRETERM)}$ |                         | mA                 |            |
| $V_{(SLP)}$  | Sleep entry threshold, $V_{IN} - V_{(BAT)}$   | $2\text{ V} < V_{BAT} < V_{(BATREG)}$ , $V_{IN}$ falling             |                         | 65              | 120                     | mV                 |            |
| $V_{(SLP\_HYS)}$                                     | Sleep-mode exit hysteresis                    | $V_{IN}$ rising above $V_{(SLP)}$                                    | 40                      | 65              | 100                     | mV                 |            |
| $V_{OVP}$  | Maximum Input Supply OVP threshold voltage    | $V_{IN}$ rising, 100 mV hysteresis                                   | 5.35                    | 5.55            | 5.75                    | V                  |            |
| $t_{DGL\_OVP}$                                       | Deglintch time, VIN OVP falling               | $V_{IN}$ falling below $V_{OVP}$ , 1V/us                             |                         | 32              |                         | ms                 |            |
| $T_{SHTDWN}$   | Thermal trip                                  | $V_{IN} > V_{(UVLO)}$  |                         | 114             |                         | $^{\circ}\text{C}$ |            |
| $T_{HYS}$  | Thermal hysteresis                            | $V_{IN} > V_{(UVLO)}$  |                         | 11              |                         | $^{\circ}\text{C}$ |            |

**Electrical Characteristics (continued)**

Circuit of [图 1](#),  $V_{(UVLO)} < V_{IN} < V_{(OVP)}$  and  $V_{IN} > V_{(BAT)} + V_{(SLP)}$ ,  $T_J = -40^{\circ}\text{C}$  to  $85^{\circ}\text{C}$  and  $T_J = 25^{\circ}\text{C}$  for typical values (unless otherwise noted)

| PARAMETERS        |                                 | TEST CONDITIONS                 | MIN | TYP | MAX | UNIT          |
|-------------------|---------------------------------|---------------------------------|-----|-----|-----|---------------|
| $t_{DGL\_SHTDWN}$ | Deglitch time, Thermal shutdown | $T_J$ rising above $T_{SHTDWN}$ |     | 4   |     | $\mu\text{s}$ |

## Electrical Characteristics (continued)

Circuit of [Figure 1](#),  $V_{(UVLO)} < V_{IN} < V_{(OVP)}$  and  $V_{IN} > V_{(BAT)} + V_{(SLP)}$ ,  $T_J = -40^{\circ}\text{C}$  to  $85^{\circ}\text{C}$  and  $T_J = 25^{\circ}\text{C}$  for typical values (unless otherwise noted)

| PARAMETERS                                    |  | TEST CONDITIONS  | MIN                       | TYP | MAX                       | UNIT |
|---|--|--|---------------------------|-----|---------------------------|------|
| <b>I<sup>2</sup>C INTERFACE</b>               |  |  |                           |     |                           |      |
|   | I <sup>2</sup> C Bus Specification standard and fast mode frequency support  |  | 100                       |     | 400                       | kHz  |
| V <sub>IL</sub>                               | Input low threshold level  | V <sub>PULLUP</sub> = 1.1 V, SDA and SCL                                       |                           |     | 0.275                     | V    |
| V <sub>IH</sub>                               | Input high threshold level   | V <sub>PULLUP</sub> = 1.1 V, SDA and SCL                                       | 0.825                     |     |                           | V    |
| V <sub>IH</sub>                               | Input high threshold level   | V <sub>PULLUP</sub> = 3.3 V, SDA and SCL                                       | 2.475                     |     |                           | V    |
| V <sub>OL</sub>                               | Output low threshold level   | IL = 5 mA, sink current, V <sub>PULLUP</sub> = 1.1 V                           |                           |     | 0.275                     | V    |
| I <sub>BIAS</sub>                             | High-Level leakage current   | V <sub>PULLUP</sub> = 1.8 V, SDA and SCL                                       |                           |     | 1                         | μA   |
| <b>INT, PG, and RESET OUTPUT (Open Drain)</b> |  |  |                           |     |                           |      |
| V <sub>OL</sub>                               | Low level output threshold   | Sinking current = 5 mA   |                           |     | 0.25 x V <sub>(SYS)</sub> | V    |
| I <sub>IN</sub>                               | Bias current into pin  | Pin is high impedance, I <sub>OUT</sub> = 0 mA; T <sub>J</sub> = -40°C to 60°C |                           |     | 12                        | nA   |
| V <sub>IN(BAT_DELTA)</sub>                    | Input voltage above V <sub>BAT</sub> where PG sends two 128 μs pulses each minute to signal the host of the input voltage status | V <sub>UVLO</sub> < V <sub>IN</sub> < V <sub>OVP</sub>                         | 0.825                     | 1   | 1.15                      | V    |
| <b>INPUT PIN (CD LSCTRL)</b>                  |  |  |                           |     |                           |      |
| V <sub>IL(CD_LSCTRL)</sub>                    | Input low threshold  | V <sub>(PULLUP)</sub> = V <sub>(SYS)</sub> = 3.3 V                             |                           |     | 0.25 * V <sub>(SYS)</sub> | V    |
| V <sub>IH(CD_LSCTRL)</sub>                    | Input high threshold   | V <sub>(PULLUP)</sub> = V <sub>(SYS)</sub> = 3.3 V                             | 0.75 * V <sub>(SYS)</sub> |     |                           | V    |
| R <sub>PULLDOWN/CD</sub>                      | Internal pull-down resistance  |  |                           | 900 |                           | kΩ   |
| R <sub>(LSCTRL)</sub>                         | Internal pull-down resistance  |  |                           | 2   |                           | MΩ   |

## 8.6 Timing Requirements

|  |  |   | MIN  | TYP                     | MAX  | UNIT    |
|--|--|---|------|-------------------------|------|---------|
| <b>POWER-PATH MANAGEMENT AND INPUT CURRENT LIMIT</b> |  |   |      |                         |      |         |
| $t_{DGL\_SC}$  | Deglintch Time, PMID or SW Short Circuit during Discharge Mode                           |   |      | 250                     |      | $\mu s$ |
| $t_{REC\_SC}$  | Recovery time, OUT Short Circuit during Discharge Mode                                   |   |      | 2                       |      | s       |
| <b>BATTERY CHARGER</b>                               |  |   |      |                         |      |         |
| $t_{DGL\_SHORT}$                                     | Deglintch time transition from ISET short to $I_{(CHARGE)}$ disable                      | Clear fault by disconnecting VIN  |      | 1                       |      | ms      |
| <b>BATTERY CHARGING TIMERS</b>                       |  |   |      |                         |      |         |
| $t_{MAXCHG}$   | Charge safety timer  | Programmable range  | 2    |                         | 540  | min     |
| $t_{PRECHG}$   | Precharge safety timer   |   |      | $0.1 \times t_{MAXCHG}$ |      |         |
| <b>SYS OUTPUT</b>                                    |  |   |      |                         |      |         |
| $t_{ONMIN}$  | Minimum ON time  | $V_{IN} = 3.6 V, V_{OUT} = 2 V, I_{OUT} = 0 mA$                         |      | 225                     |      | ns      |
| $t_{OFFMIN}$   | Minimum OFF time   | $V_{IN} = 4.2 V$  |      | 50                      |      | ns      |
| $t_{START\_SW}$                                      | SW start up time   | $V_{IN} = 5 V$ , from write on EN_SW_OUT until output starts to rise    |      | 5                       | 25   | ms      |
| $t_{START\_SYS}$                                     | SYS output time to start switching   | From insertion of $BAT > V_{(BUVLO)}$ or $V_{IN} > V_{(UVLO)}$          |      | 350                     |      | $\mu s$ |
| $t_{SOFTSTART}$                                      | Softstart time with reduced current limit  |   |      | 400                     | 1200 | $\mu s$ |
| <b>LS/LDO OUTPUT</b>                                 |  |   |      |                         |      |         |
| $t_{ON\_LDO}$  | Turn ON time   | 100-mA load   |      | 500                     |      | $\mu s$ |
| $t_{OFF\_LDO}$                                       | Turn OFF time  | 100-mA load   |      | 5                       |      | $\mu s$ |
| <b>PUSHBUTTON TIMER</b>                              |  |   |      |                         |      |         |
| $t_{WAKE1}$  | Push button timer wake 1   | Programmable Range for wake1 function                                   | 0.08 |                         | 1    | s       |
| $t_{WAKE2}$  | Push button timer wake 2   | Programmable Range for wake2 function                                   | 1    |                         | 2    | s       |
| $t_{RESET}$  | Push button timer reset  | Programmable Range for reset function                                   | 5    |                         | 15   | s       |
| $t_{RESET\_D}$                                       | Reset pulse duration   |   |      | 400                     |      | ms      |
| $t_{DD}$   | Detection delay (from MR, input to RESET)  | For 0s condition  |      | 6                       |      | $\mu s$ |
| <b>BATTERY-PACK NTC MONITOR</b>                      |  |   |      |                         |      |         |
| $t_{DGL(TS)}$  | Deglintch time on TS change  | Applies to $V_{(HOT)}$ , $V_{(WARM)}$ , $V_{(COOL)}$ , and $V_{(COLD)}$ |      | 50                      |      | ms      |
| <b>I2C INTERFACE</b>                                 |  |   |      |                         |      |         |
| $t_{WATCHDOG}$                                       | I <sup>2</sup> C interface reset timer for host  |   |      | 50                      |      | s       |
| $t_{I2CRESET}$                                       | I <sup>2</sup> C interface inactive reset timer  |   |      | 700                     |      | ms      |
| $t_{HI\_Z\_ACTIVEBAT}$                               | Transition time required to enable the I <sup>2</sup> C interface from HiZ to Active BAT |   |      |                         | 1    | ms      |
| <b>INPUT PIN</b>                                     |  |   |      |                         |      |         |
| $t_{CD\_DGL}$  | Deglintch for $\overline{CD}$  | $\overline{CD}$ rising/falling  |      | 100                     |      | $\mu s$ |

### Typical Start-Up Timing and Operation



图 1. Typical Start-Up Timing and Operation



图 2. Battery Operation and Sleep Mode

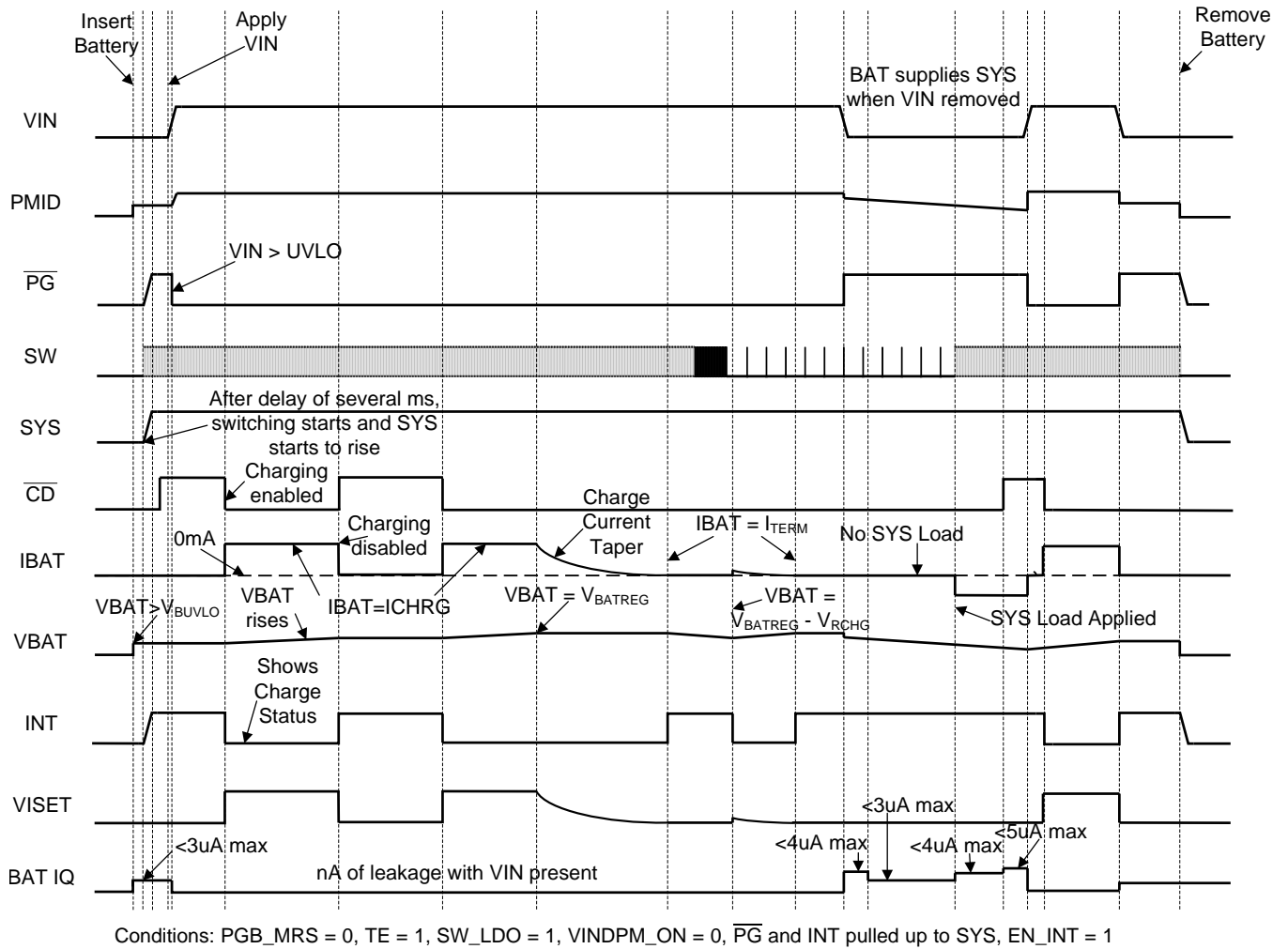

### 8.7 Typical Characteristics

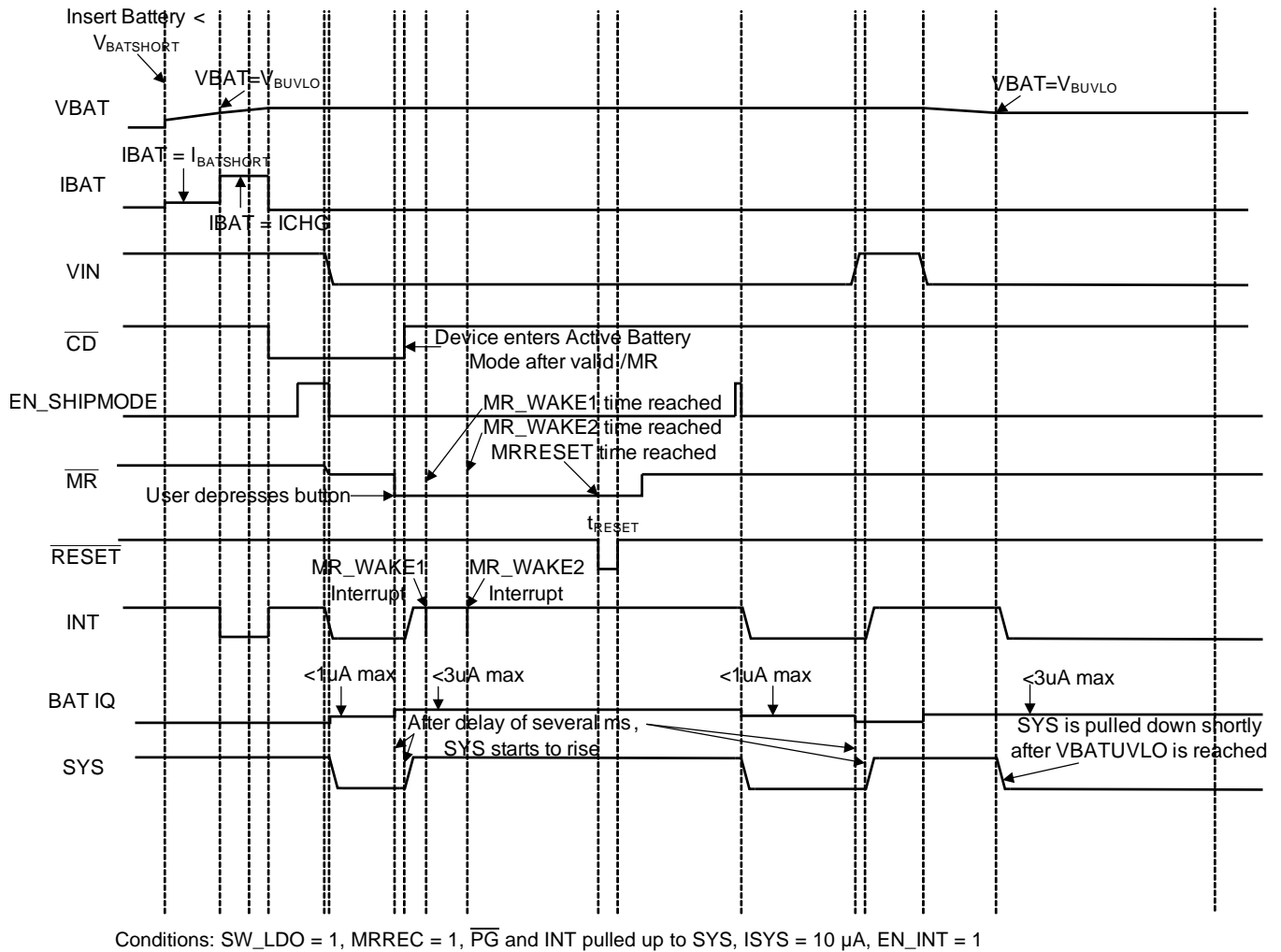
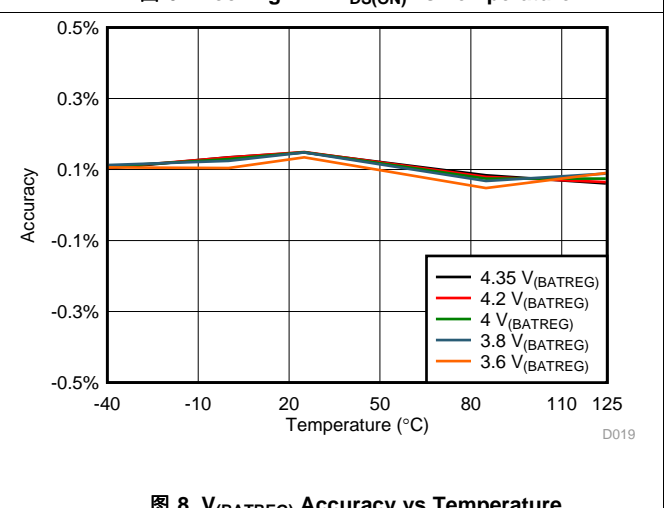
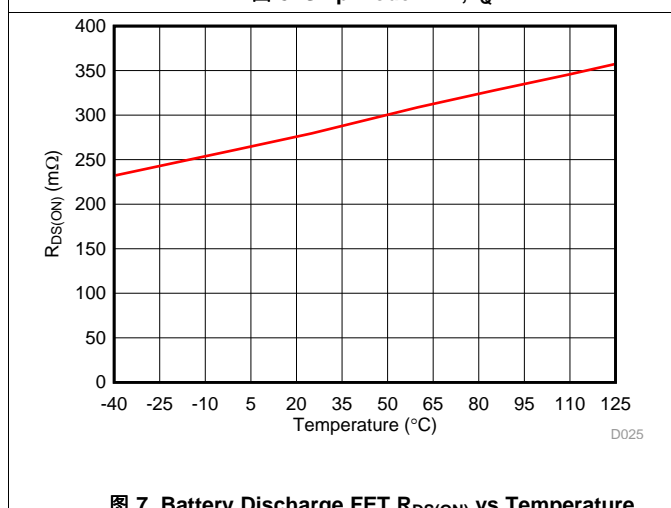
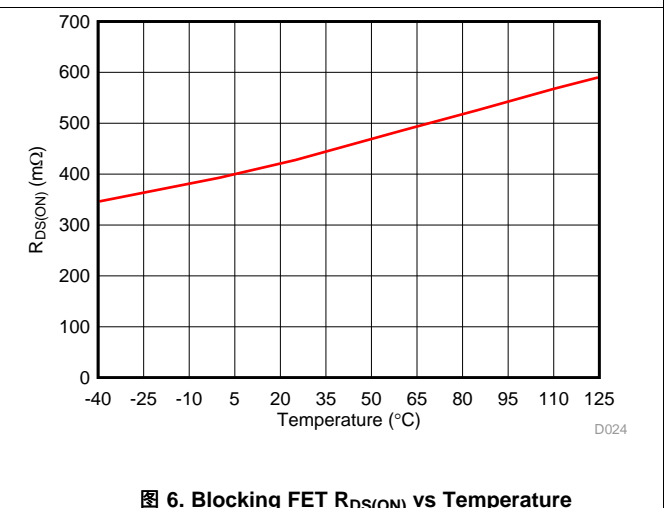
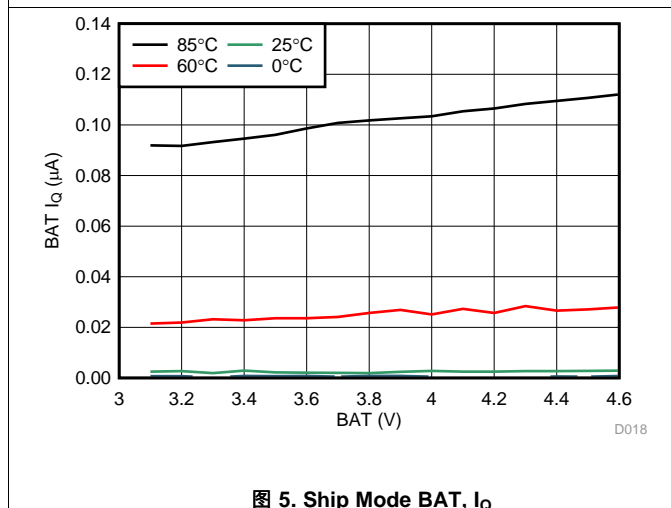
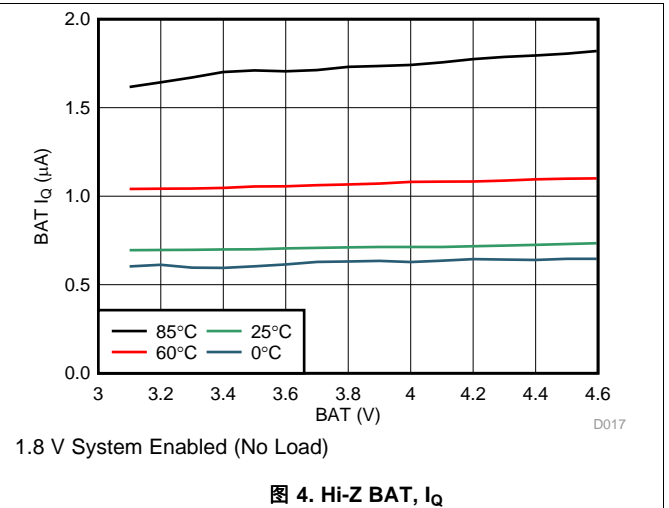
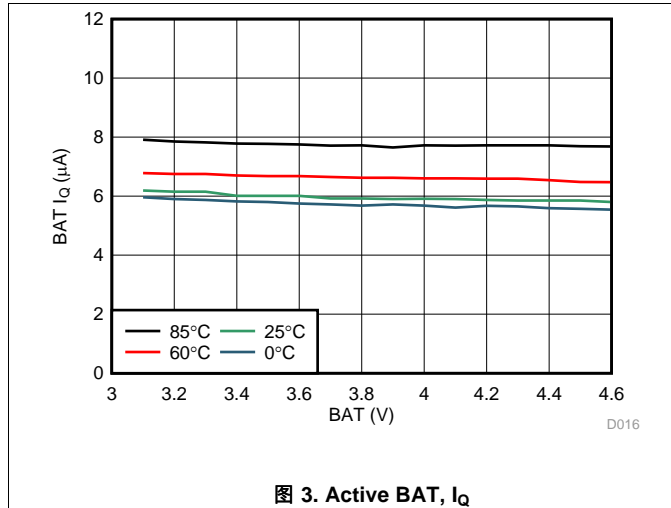

Typical Characteristics (接下页)



图 9. ILIM Accuracy vs Input Current



图 10. Charge Current Accuracy vs Charge Current

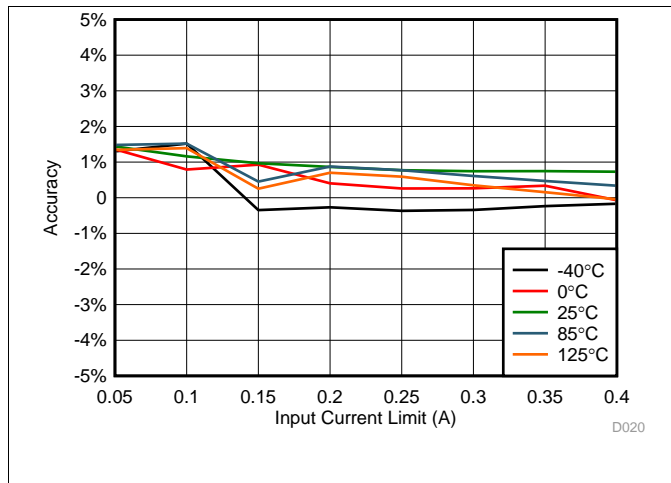

图 11. Pre-Charge Accuracy vs Pre-Charge Current

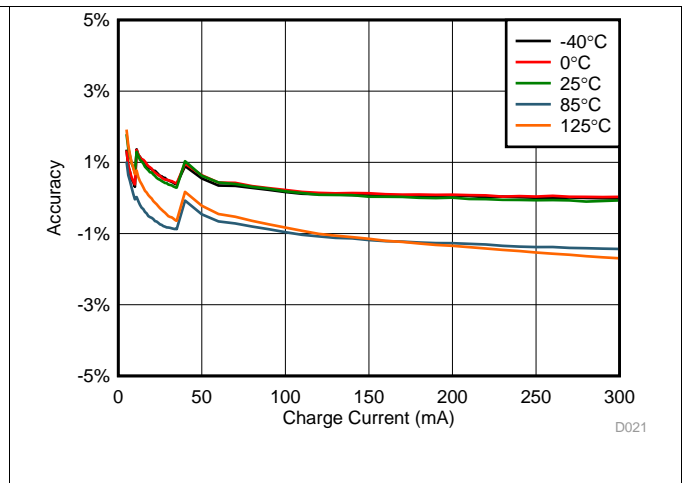

图 12.  $R_{DS(ON)}$  of High Side MOSFET vs Temperature

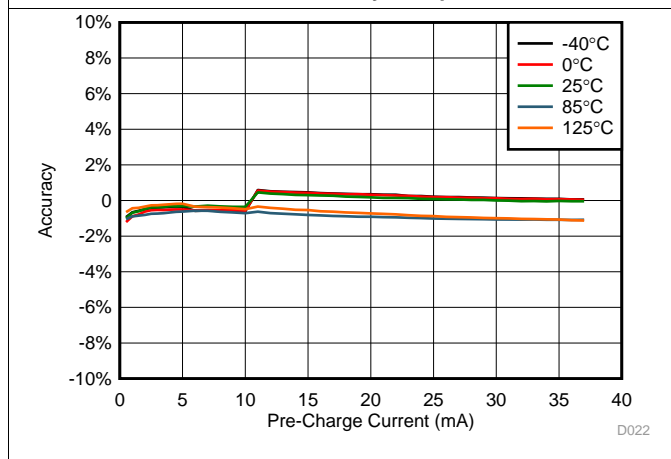

图 13.  $R_{DS(ON)}$  of Low Side MOSFET vs Temperature

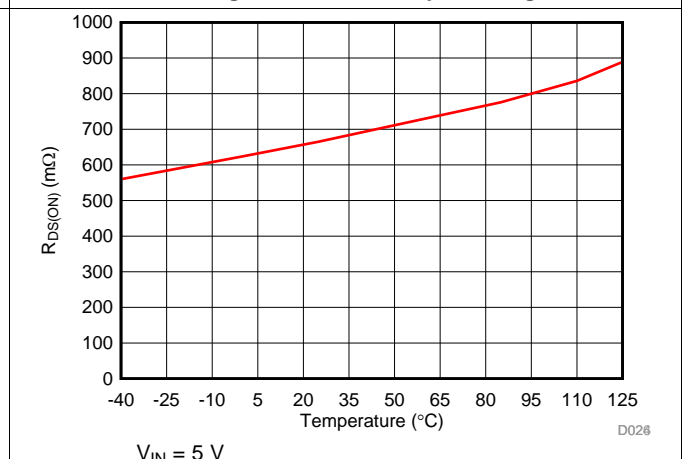

图 14. LS/LDO PSRR vs Frequency

## 9 Detailed Description

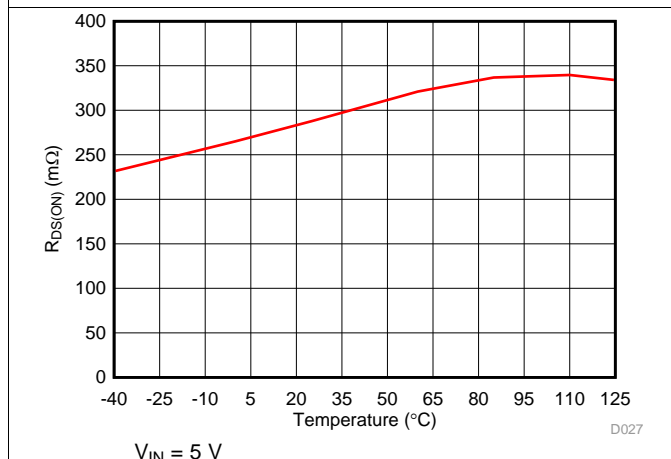
### 9.1 Overview

The following sections describe in detail the functions provided by the BQ25120. These include linear charger, PWM output, configurable LS/LDO output, Push-button input, reset timer, functional modes, battery monitor, I<sup>2</sup>C configurability and functions, and safety features.

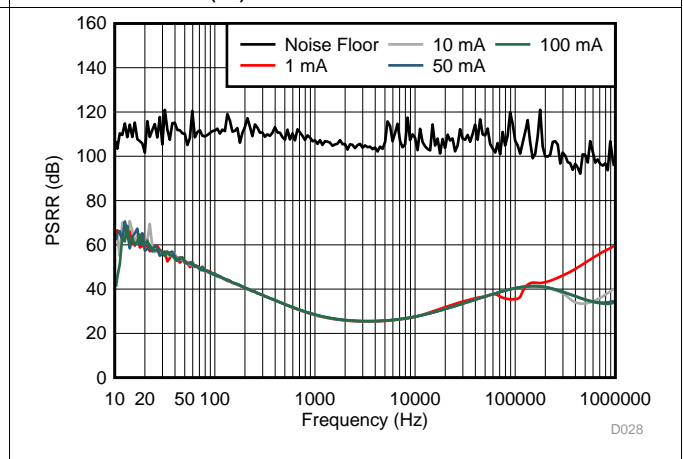
### 9.2 Functional Block Diagram

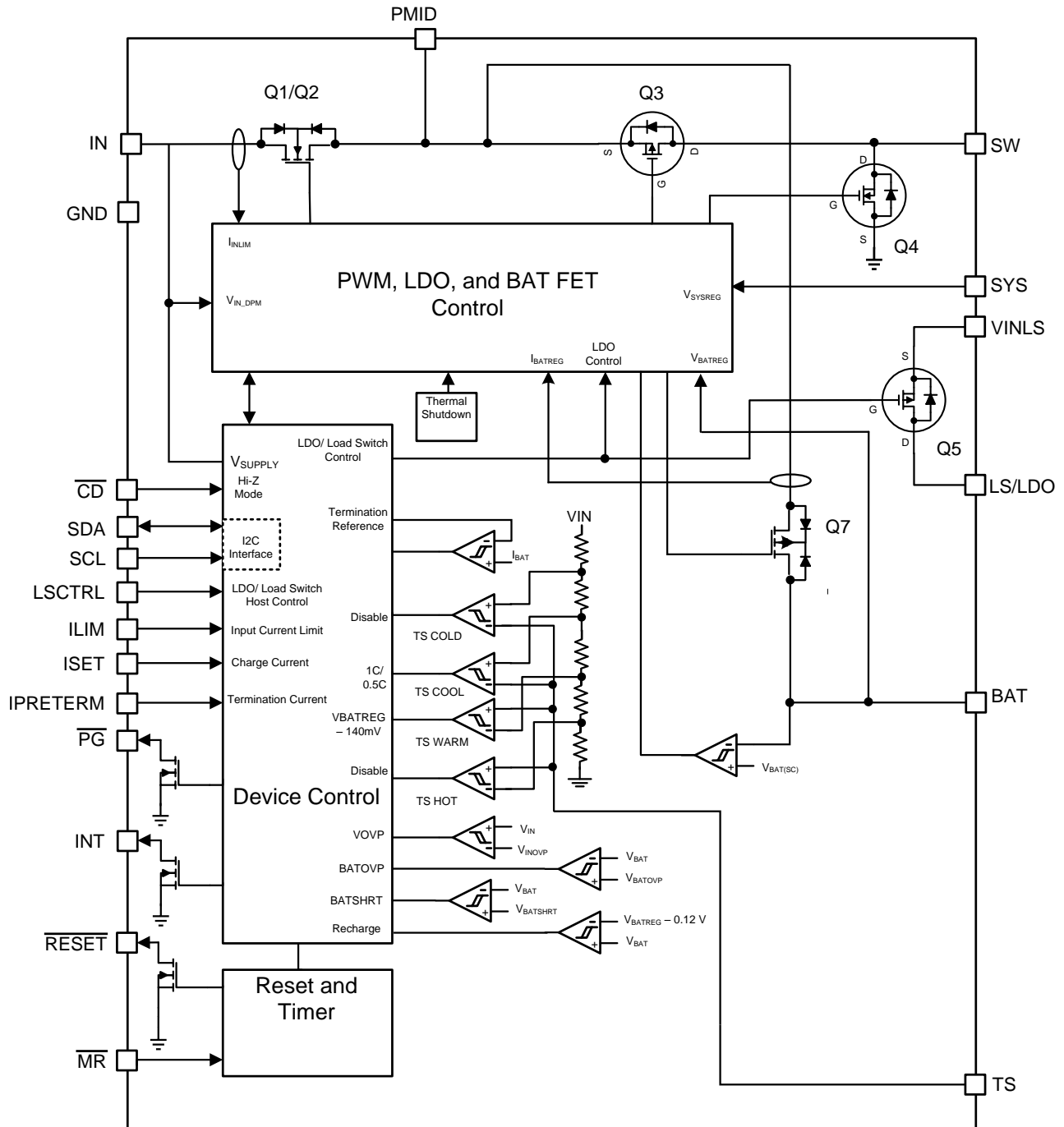

Copyright © 2016, Texas Instruments Incorporated

## 9.3 Feature Description

### 9.3.1 Ship Mode

Ship Mode is the lowest quiescent current state for the device. Ship Mode latches off the device and BAT FET until  $V_{IN} > V_{UVLO}$  or the  $\overline{MR}$  button is depressed for  $t_{WAKE1}$  and released. To enter Ship Mode,  $\overline{CD}$  must be pulled high. If the EN\_SHIPMODE is written to a 1 while the input is connected, it must first be removed to enter ship mode. This allows the end product with minimal load on the battery, and the end user can enable the device by plugging it into the adapter or by toggling the  $\overline{MR}$  button. The battery voltage must be above the maximum programmable BUVDLO threshold in order to exit Ship mode with a  $\overline{MR}$  button press when  $V_{IN}$  is not present.. The EN\_SHIPMODE bit can be cleared using the I<sup>2</sup>C interface as well while the input is valid. The following list shows the events that are active during Ship Mode:

1.  $V_{IN\_UV}$  Comparator
2.  $\overline{MR}$  Input (No clock or delay in this mode for lowest power consumption)

### 9.3.2 High Impedance Mode

High Impedance mode is the lowest quiescent current state while operating from the battery. During Hi-Z mode the SYS output is powered by BAT, the  $\overline{MR}$  input is active, and the LSCTRL input is active. All other circuits are in a low power or sleep state. The LS/LDO output can be enabled in Hi-Z mode with the LSCTRL input. If the LS/LDO output has been enabled through I<sup>2</sup>C prior to entering Hi-Z mode, it will stay enabled. The  $\overline{CD}$  pin is used to put the device in a high-impedance mode when battery is present and  $V_{IN} < V_{UVLO}$ . Drive  $\overline{CD}$  high to enable the device and enter active battery operation when  $V_{IN}$  is not valid. When the HZ\_MODE bit is written by the host, the I<sup>2</sup>C interface is disabled if only battery is present. To resume I<sup>2</sup>C, the  $\overline{CD}$  pin must be toggled. The functionality is shown in [表 1](#).

**表 1. CD, State Table**

| CD, State | $V_{IN} < V_{UVLO}$ | $V_{IN} > V_{UVLO}$ |
|-----------|---------------------|---------------------|
| L         | Hi-Z                | Charge Enabled      |
| H         | Active Battery      | Charge Disabled     |

### 9.3.3 Active Battery Only Connected

When the battery above  $V_{BATUVLO}$  is connected with no input source, the battery discharge FET is turned on. After the battery rises above  $V_{BATUVLO}$  and the deglitch time is reached, the SYS output starts to rise. The current from PMID and SYS is not regulated, but is protected by a short circuit current limit. If the short circuit limit is reached for the deglitch time ( $t_{DGL\_SC}$ ), the battery discharge FET is turned off for the recovery time ( $t_{REC\_SC}$ ). After the recovery time, the battery FET is turned on to test if the short has been removed. If it has not, the FET turns off and the process repeats until the short is removed. This process protects the internal FET from over current. During this event PMID will likely droop and cause SYS to go out of regulation.

To provide designers the most flexibility in optimizing their system, an adjustable BATUVLO is provided. When the voltage drops below the  $V_{BATUVLO}$  threshold, the battery discharge FET is turned off. Deeper discharge of the battery enables longer times between charging, but may shorten the battery life. The BATUVLO is adjustable with a fixed 100-mV hysteresis.

If a valid  $V_{IN}$  is connected during active battery mode,  $V_{IN} > V_{UVLO}$ , the supplement and battery discharge FET is turned on when the battery voltage is above the minimum  $V_{BATUVLO}$ .

Drive  $\overline{CD}$  high or write the CE register to disable charge when  $V_{IN} > V_{UVLO}$  is present.  $\overline{CD}$  is internally pulled down. When exiting this mode, charging resumes if  $V_{IN}$  is present,  $\overline{CD}$  is low and charging is enabled.

All HOST interfaces ( $\overline{CD}$ , SDA/SCL, INT,  $\overline{RESET}$  and LSCTRL) are active no later than 5 ms after SYS reaches the programmed level.

### 9.3.4 Voltage Based Battery Monitor

The device implements a simple voltage battery monitor which can be used to determine the depth of discharge. Prior to entering High-Z mode, the device will initiate a VBMON reading. The host can read the latched value for the no-load battery voltage, or initiate a reading using VBMON\_READ to see the battery voltage under a known load. The register will be updated and can be read 2ms after a read is initiated. The VBMON voltage threshold is readable with 2% increments with  $\pm 1.5\%$  accuracy between 60% and 100% of VBATREG using the VBMON\_TH registers. Reading the value during charge is possible, but for the most accurate battery voltage indication, it is recommended to disable charge, initiate a read, and then re-enable charge.

A typical discharge profile for a Li-Ion battery is shown in 表 2. The specific battery to be used in the application should be fully characterized to determine the thresholds that will indicate the appropriate battery status to the user. Two typical examples are shown below, assuming the VBMON reading is taken with no load on the battery.

This function enables a simple 5-bar status indicator with the following typical performance with different VBATREG settings:

表 2. Discharge Profile for a Li-Ion Battery

| VBATREG | BATTERY FULL | 95% to 65%<br>REMAINING CAPACITY | 65% to 35%<br>REMAINING CAPACITY | 35% to 5%<br>REMAINING CAPACITY | BATTERY EMPTY |
|---------|--------------|----------------------------------|----------------------------------|---------------------------------|---------------|
| 4.35 V  | VBMON > 90%  | VBMON = 88%                      | VBMON = 86%                      | VBMON = 84%                     | VBMON < 82%   |
| 4.2 V   | VBMON > 98%  | VBMON = 94% or 96%               | VBMON = 90% or 92%               | VBMON = 86% or 88%              | VBMON < 84%   |



图 15. Voltage Battery Monitor

### 9.3.5 Sleep Mode

The device enters the low-power sleep mode if the voltage  $V_{IN}$  falls below the sleep-mode entry threshold and  $V_{IN}$  is higher than the undervoltage lockout threshold. In sleep mode, the input is isolated from the battery. This feature prevents draining the battery during the absence of  $V_{IN}$ . When  $V_{IN} < V_{(BAT)} + V_{SLP}$ , the device turns the battery discharge FET on, sends a 128- $\mu$ s pulse on the INT output, and the FAULT bits of the register are updated over I<sup>2</sup>C. Once  $V_{IN} > V_{(BAT)} + V_{SLP}$ , the device initiates a new charge cycle. The FAULT bits are not cleared until they are read over I<sup>2</sup>C and the sleep condition no longer exists.

### 9.3.6 Input Voltage Based Dynamic Power Management ( $V_{IN(DPM)}$ )

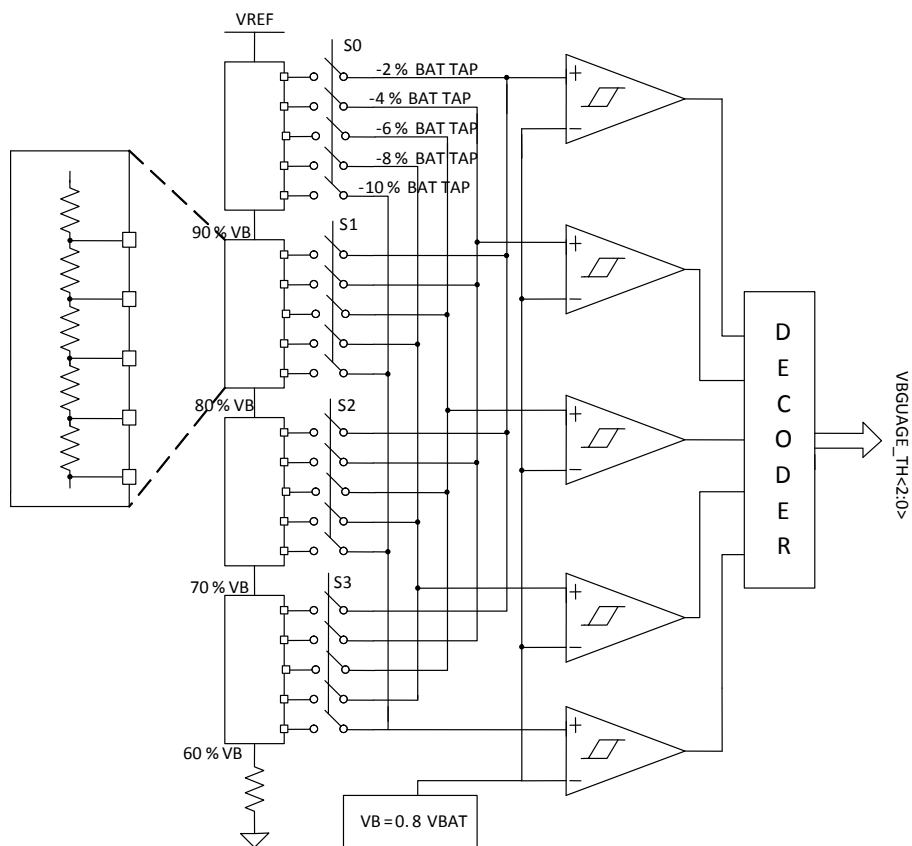
During the normal charging process, if the input power source is not able to support the programmed or default charging current and System load, the supply voltage decreases. Once the supply drops to  $V_{IN(DPM)}$ , the input DPM current and voltage loops will reduce the input current through the blocking FETs, to prevent the further drop of the supply. The  $V_{IN(DPM)}$  threshold is programmable through the I<sup>2</sup>C register from 4.2 V to 4.9 V in 100-mV steps. It can be disabled completely as well. When the device enters this mode, the charge current may be lower than the set value and the VINDPM\_STAT bit is set. If the 2X timer is set, the safety timer is extended while  $V_{IN(DPM)}$  is active. Additionally, termination is disabled.

### 9.3.7 Input Overvoltage Protection and Undervoltage Status Indication

The input overvoltage protection protects the device and downstream components connected to PMID, SYS, and BAT against damage from overvoltage on the input supply. When  $V_{IN} > V_{OVP}$  an OVP fault is determined to exist. During the OVP fault, the device turns the battery discharge FET on, sends a single 128- $\mu$ s pulse on INT, and the FAULT bits are updated over I<sup>2</sup>C. Once the OVP fault is removed, after the deglitch time,  $t_{DGL\_OVP}$ , STAT and FAULT bits are cleared and the device returns to normal operation. The FAULT bits are not cleared until they are read in from I<sup>2</sup>C after the OVP condition no longer exists. The OVP threshold for the device is set to operate from standard USB sources.

The input under-voltage status indication is used to notify the host or other device when the input voltage falls below a desired threshold. When  $V_{IN} < V_{UVLO}$ , after the deglitch time  $t_{DGL\_UVLO}$ , a UVLO fault is determined to exist. During the  $V_{IN}$  UVLO fault, the device sends a single 128- $\mu$ s pulse on INT, and the STAT and FAULT bits are updated over I<sup>2</sup>C. The FAULT bits are not cleared until they are read in from I<sup>2</sup>C after the UVLO condition no longer exists.

### 9.3.8 Battery Charging Process and Charge Profile

When a valid input source is connected ( $V_{IN} > V_{UVLO}$  and  $V_{(BAT)} + V_{SLP} \leq V_{IN} < V_{OVP}$ ), the  $\overline{CE}$  bit in the control register determines whether a charge cycle is initiated. When the  $\overline{CE}$  bit is 1 and a valid input source is connected, the battery discharge FET is turned off, and the output at SYS is regulated depending on the output configuration. A charge cycle is initiated when the  $\overline{CE}$  bit is written to a 0. Alternatively, the  $\overline{CD}$  input can be used to enable and disable charge.

The device supports multiple battery chemistries for single-cell applications. Charging is done through the internal battery MOSFET. There are several loops that influence the charge current: constant current loop (CC), constant voltage loop (CV), input current limit,  $V_{DPPM}$ , and  $V_{IN(DPM)}$ . During the charging process, all loops are enabled and the one that is dominant takes control.

The charge current is regulated to  $I_{CHARGE}$  until the voltage between BAT and GND reaches the regulation voltage. The voltage between BAT and GND is regulated to  $V_{BATREG}$  (CV Mode) while the charge current naturally tapers down. When termination is enabled, the device monitors the charging current during the CV mode, and once the charge current tapers down to the termination threshold,  $I_{TERM}$ , and the battery voltage is above the recharge threshold, the device terminates charge, and turns off the battery charging FET. Termination is disabled when any loop is active other than CV.

### 9.3.9 Dynamic Power Path Management Mode

With a valid input source connected, the power-path management circuitry monitors the input voltage and current continuously. The current into IN is shared at PMID between charging the battery and powering the system load at PMID, SYS, and LS/LDO. If the sum of the charging and load currents exceeds the preset maximum input current, the input DPM loop reduces input current. If PMID drops below the DPPM voltage threshold, the charging current is reduced by the DPPM loop through the BATFET. If PMID continues to drop after BATFET charging current is reduced to zero, the part enters supplement mode when PMID falls below the supplement mode threshold. Battery termination is disabled while in DPPM mode.

### 9.3.10 Battery Supplement Mode

While in DPPM mode, if the charging current falls to zero and the system load current increases beyond the programmed input current limit, the voltage at PMID reduces further. When the PMID voltage drops below the battery voltage by  $V_{(BSUP1)}$ , the battery supplements the system load. The battery stops supplementing the system load when the voltage on the PMID pin rises above the battery voltage by  $V_{(BSUP2)}$ . During supplement mode, the battery supplement current is not regulated, however, the short-circuit protection circuit is active. Battery termination is disabled while in supplement mode.

### 9.3.11 Default Mode

The default mode is used when there is no host, or I<sup>2</sup>C communication is not available. If the externally programmable pins, ILIM, ISET, and ITERM have resistors connected, that is considered the default mode. If they are tied to GND, the default register settings are used. The default mode can be entered by connecting a valid power source to V<sub>IN</sub> or the RESET bit is written. Default mode is exited by writing to the I<sup>2</sup>C interface.

### 9.3.12 Termination and Pre-Charge Current Programming by External Components (IPRETERM)

The termination current threshold is user programmable through an external resistor or through registers over I<sup>2</sup>C. Set the termination current using the IPRETERM pin by connecting a resistor from IPRETERM to GND. The termination can be set between 5% and 20% of the programmed output current set by ISET, using 表 3 for guidance:

**表 3. IPRETERM Resistor Settings**

| IPRE_CHARGE and ITERM |                    |     | KKIPRETERM |     |     | RIPRETERM<br>(STANDARD 1%<br>VALUES) | UNIT |
|-----------------------|--------------------|-----|------------|-----|-----|--------------------------------------|------|
| MIN                   | TYP<br>(% of ISET) | MAX | MIN        | TYP | MAX | RECOMMENDED<br>RIPRETERM             |      |
|                       | 5                  |     | 180        | 200 | 220 | 15000                                | Ω    |
|                       | 10                 |     | 180        | 200 | 220 | 4990                                 | Ω    |
|                       | 15                 |     | 180        | 200 | 220 | 1650                                 | Ω    |
|                       | 20                 |     | 180        | 200 | 220 | 549                                  | Ω    |

Using the I<sup>2</sup>C register, the termination current can be programmed with a minimum of 500 μA and a maximum of 37 mA.

The pre-charge current is not independently programmable through the external resistor, and is set at the termination current. The pre-charge and termination currents are programmable using the IPRETERM registers. If no IPRETERM resistor is connected and the pin is tied to GND, the default values in the IPRETERM registers are used. The external value can be used in host mode by configuring the IPRETERM registers. If the external ICHG setting will be used after being in Host mode, the IPRETERM registers should be set to match the desired external threshold for the highest ICHG accuracy.

Termination is disabled when any loop other than CV is active.

### 9.3.13 Input Current Limit Programming by External Components (ILIM)

The input current limit threshold is user programmable through an external resistor or through registers over I<sup>2</sup>C. Set the input current limit using the ILIM pin by connecting a resistor from ILIM to GND using 表 4 for guidance. If no ILIM resistor is connected and the pin is tied to GND, the default ILIM register value is used. The external value is not valid once the device enters host mode.

表 4. ILIM Resistor Settings

| ILIM        |             |             | KILIM |     |     | RILIM<br>(STANDARD 1%<br>VALUES) | UNIT |
|-------------|-------------|-------------|-------|-----|-----|----------------------------------|------|
| MIN         | TYP         | MAX         | MIN   | TYP | MAX |                                  |      |
| 0.048469388 | 0.051020408 | 0.053571429 | 190   | 200 | 210 | 3920                             | Ω    |
| 0.09047619  | 0.095238095 | 0.1         | 190   | 200 | 210 | 2100                             | Ω    |
| 0.146153846 | 0.153846154 | 0.161538462 | 190   | 200 | 210 | 1300                             | Ω    |
| 0.19        | 0.2         | 0.21        | 190   | 200 | 210 | 1000                             | Ω    |
| 0.285714286 | 0.30075188  | 0.315789474 | 190   | 200 | 210 | 665                              | Ω    |
| 0.380761523 | 0.400801603 | 0.420841683 | 190   | 200 | 210 | 499                              | Ω    |

The device has register programmable input current limits from 50 mA to 400 mA in 50-mA steps. The device is USB-IF compliant for inrush current testing, assuming that the input capacitance to the device is selected to be small enough to prevent a violation (<10 μF), as this current is not limited.

### 9.3.14 Charge Current Programming by External Components (ISET)

The fast charge current is user programmable through an external resistor or through registers over I<sup>2</sup>C. Set the fast charge current by connecting a resistor from ISET to GND. If no ISET resistor is connected and the pin is tied to GND, the default ISET register value is used. While charging, if the charge current is using the externally programmed value, the voltage at ISET reflects the actual charging current and can be used to monitor charge current. The current out of ISET is 1/100 (±10%) of the charge current. The charge current can be calculated by using 表 5 for guidance:

表 5. ISET Resistor Settings

| ISET        |             |             | KISET |     |     | RISET<br>(STANDARD 1%<br>VALUES) | UNIT |
|-------------|-------------|-------------|-------|-----|-----|----------------------------------|------|
| MIN         | TYP         | MAX         | MIN   | TYP | MAX |                                  |      |
| 0.285714286 | 0.30075188  | 0.315789474 | 190   | 200 | 210 | 665                              | Ω    |
| 0.19        | 0.2         | 0.21        | 190   | 200 | 210 | 1000                             | Ω    |
| 0.126666667 | 0.133333333 | 0.14        | 190   | 200 | 210 | 1500                             | Ω    |
| 0.095       | 0.1         | 0.105       | 190   | 200 | 210 | 2000                             | Ω    |
| 0.06462585  | 0.068027211 | 0.071428571 | 190   | 200 | 210 | 2940                             | Ω    |
| 0.048469388 | 0.051020408 | 0.053571429 | 190   | 200 | 210 | 3920                             | Ω    |
| 0.038076152 | 0.04008016  | 0.042084168 | 190   | 200 | 210 | 4990                             | Ω    |
| 0.031456954 | 0.033112583 | 0.034768212 | 190   | 200 | 210 | 6040                             | Ω    |
| 0.025956284 | 0.027322404 | 0.028688525 | 190   | 200 | 210 | 7320                             | Ω    |
| 0.019       | 0.02        | 0.021       | 190   | 200 | 210 | 10000                            | Ω    |
| 0.012666667 | 0.013333333 | 0.014       | 190   | 200 | 210 | 15000                            | Ω    |
| 0.0095      | 0.01        | 0.0105      | 190   | 200 | 210 | 20000                            | Ω    |
| 0.006462585 | 0.006802721 | 0.007142857 | 190   | 200 | 210 | 29400                            | Ω    |
| 0.004846939 | 0.005102041 | 0.005357143 | 190   | 200 | 210 | 39200                            | Ω    |



### 9.3.15 Safety Timer and Watchdog Timer

At the beginning of the charge cycle, the device starts the safety timer. If charging has not terminated before the programmed safety time,  $t_{MAXCHG}$ , expires, the device enters idle mode and charging is disabled. The pre-charge safety time,  $t_{PRECHG}$ , is 10% of  $t_{MAXCHG}$ . When a safety timer fault occurs, a single 128  $\mu s$  pulse is sent on the INT pin and the STAT and FAULT bits of the status registers are updated over I<sup>2</sup>C. The  $\overline{CD}$  pin or power must be toggled in order to clear the safety timer fault. The safety timer duration is programmable using the TMR bits. When the safety timer is active, changing the safety timer duration resets the safety timer. The device also contains a 2X\_TIMER bit that enables the 2X timer function to prevent premature safety timer expiration when the charge current is reduced by a load on PMID, SYS, LS/LDO or a NTC condition. When  $t_{2X\_TIMER}$  function is enabled, the timer is allowed to run at half speed when any loop is active other than CC or CV.

In addition to the safety timer, the device contains a 50-second watchdog timer that monitors the host through the I<sup>2</sup>C interface. Once any I<sup>2</sup>C transaction is performed on the I<sup>2</sup>C interface, a watchdog timer is started. The watchdog timer is reset by any transaction by the host using the I<sup>2</sup>C interface. If the watchdog timer expires without a reset from the I<sup>2</sup>C interface, all registers except MRRESET\_VIN and MRREC are reset to the default values.

### 9.3.16 External NTC Monitoring (TS)

The I<sup>2</sup>C interface allows the user to easily implement the JEITA standard for systems where the battery pack thermistor is monitored by the host. Additionally, the device provides a flexible voltage based TS input for monitoring the battery pack NTC thermistor. The voltage at TS is monitored to determine that the battery is at a safe temperature during charging.

To satisfy the JEITA requirements, four temperature thresholds are monitored: the cold battery threshold, the cool battery threshold, the warm battery threshold, and the hot battery threshold. These temperatures correspond to the  $V_{(COLD)}$ ,  $V_{(COOL)}$ ,  $V_{(WARM)}$ , and  $V_{(HOT)}$  threshold in the [Electrical Characteristics](#). Charging and timers are suspended when  $V_{(TS)} < V_{(HOT)}$  or  $> V_{(COLD)}$ . When  $V_{(COOL)} < V_{(TS)} < V_{(COLD)}$ , the charging current is reduced to half of the programmed charge current. When  $V_{(HOT)} < V_{(TS)} < V_{(WARM)}$ , the battery regulation voltage is reduced by 140 mV the programmed charge current.

The TS function is voltage based for maximum flexibility. Connect a resistor divider from  $V_{IN}$  to GND with TS connected to the center tap to set the threshold. The connections are shown in [Figure 16](#). The resistor values are calculated using [Equation 1](#) and [Equation 2](#). To disable the TS function, pull TS above  $TS_{OFF}$  threshold.

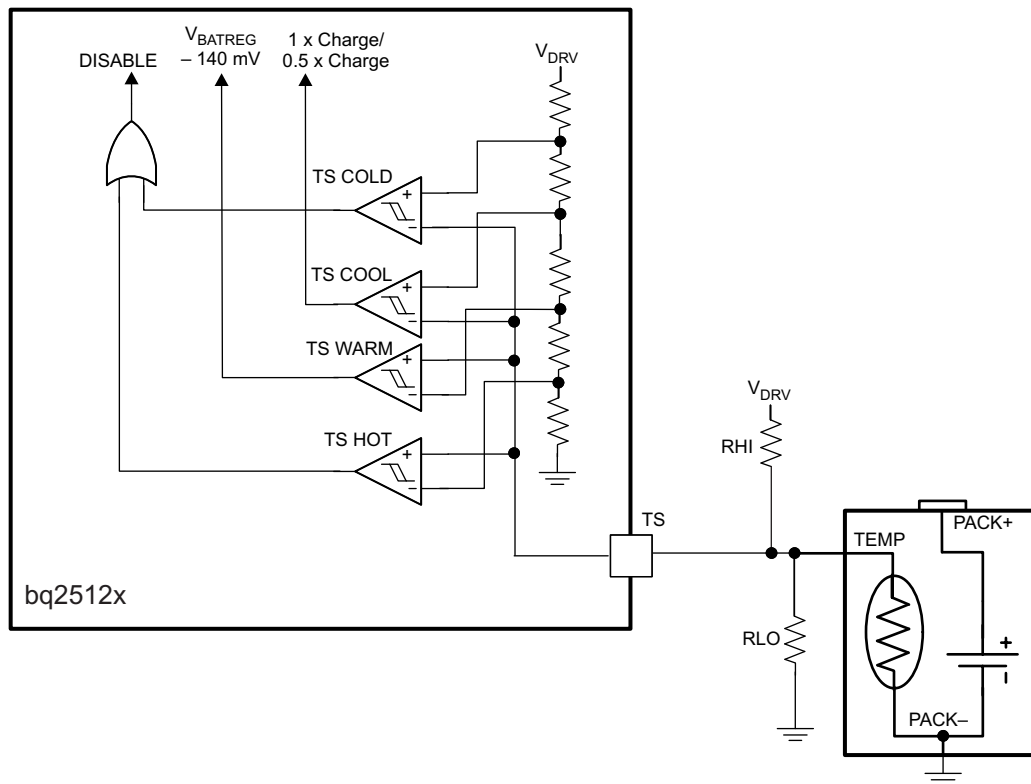

Copyright © 2016, Texas Instruments Incorporated

**图 16. TS Circuit**

$$R_{(LO)} = \frac{V_{IN} \times R_{(COLD)} \times R_{(HOT)} \times \left( \frac{1}{V_{(COLD)}} - \frac{1}{V_{(HOT)}} \right)}{R_{(HOT)} \times \left( \frac{V_{IN}}{V_{(HOT)}} - 1 \right) - R_{(COLD)} \times \left( \frac{V_{IN}}{V_{(COLD)}} - 1 \right)} \quad (1)$$

$$R_{(HI)} = \frac{\left( \frac{V_{IN}}{V_{(COLD)}} - 1 \right)}{\left( \frac{1}{R_{(LO)}} + \frac{1}{R_{(COLD)}} \right)} \quad (2)$$

Where

- $R_{(HOT)}$  = the NTC resistance at the hot temperature
- $R_{(COLD)}$  = the NTC resistance at the cold temperature

The warm and cool thresholds are not independently programmable. The cool and warm NTC resistances for a selected resistor divider are calculated using [公式 3](#) and [公式 4](#).

$$R_{(COOL)} = \frac{R_{(LO)} \times R_{(HI)} \times V_{COOL\%}}{R_{(LO)} - R_{(LO)} \times V_{COOL\%} - R_{(HI)} \times V_{COOL\%}} \quad (3)$$

$$R_{(WARM)} = \frac{R_{(LO)} \times R_{(HI)} \times V_{WARM\%}}{R_{(LO)}} - (R_{(LO)} \times V_{WARM\%} - R_{(HI)} \times V_{WARM\%}) \quad (4)$$

### 9.3.17 Thermal Protection

During the charging process, to prevent overheating in the device, the junction temperature of the die,  $T_J$ , is monitored. When  $T_J$  reaches  $T_{(SHUTDOWN)}$  the device stops charging, disables the PMID output, disables the SYS output, and disables the LS/LDO output. During the time that  $T_{(SHUTDOWN)}$  is exceeded, the safety timer is reset and the watchdog timer continues to operate if in host mode. The charge cycle resumes when  $T_J$  falls below  $T_{(SHUTDOWN)}$  by  $T_{(HYS)}$ .

To avoid reaching thermal shutdown, ensure that the system power dissipation is under the limits of the device. The power dissipated by the device can be calculated using [公式 5](#).

$$P_{DISS} = P_{(BLOCK)} + P_{(SYS)} + P_{(LS/LDO)} + P_{(BAT)} \quad (5)$$

Where

- $P_{(BLOCK)} = (V_{IN} - V_{(PMID)}) \times I_{IN}$
- $P_{(SYS)} = I_{SYS}^2 \times R_{DS(ON\_HS)}$
- $P_{(LS/LDO)} = (V_{(INLS)} - V_{(LS/LDO)}) \times I_{(LS/LDO)}$
- $P_{(BAT)} = (V_{(PMID)} - V_{(BAT)}) \times I_{(BAT)}$

### 9.3.18 Typical Application Power Dissipation

The die junction temperature,  $T_J$ , can be estimated based on the expected board performance using [公式 6](#).

$$T_J = T_A + \theta_{JA} \times P_{DISS} \quad (6)$$

The  $\theta_{JA}$  is largely driven by the board layout. For more information about traditional and new thermal metrics, see the IC Package Thermal Metrics application report [SPRA953](#). Under typical conditions, the time spent in this state is short.

### 9.3.19 Status Indicators ( $\overline{PG}$ and INT)

The device contains two open-drain outputs that signal its status and are valid only after the device has completed start-up into a valid state. If the part starts into a fault, interrupts will not be sent. The  $\overline{PG}$  output signals when a valid input source is connected.  $\overline{PG}$  pulls to GND when  $V_{IN}$  is above  $V_{UVLO}$ .  $\overline{PG}$  is high-impedance when the input power is not within specified limits. Connect  $\overline{PG}$  to the desired logic voltage rail using a 1-k $\Omega$  to 100-k $\Omega$  resistor, or use with an LED for visual indication.

The  $\overline{PG}$  pin can be configured as a  $\overline{MR}$  shifted (MRS) output when the  $\overline{PGB\_MRS}$  bit is set to 1.  $\overline{PG}$  is high-impedance when the  $\overline{MR}$  input is not low, and  $\overline{PG}$  pulls to GND when the  $\overline{MR}$  input is below  $V_{OL(TH\_MRS)}$ . Connect  $\overline{PG}$  to the desired logic voltage rail using a 1-k $\Omega$  to 100-k $\Omega$  resistor.

When enabled through OTP, the  $\overline{PG}$  pin also functions as an OVP/UVI indicator. When the device is below  $V_{SLP}$  or  $V_{IN(DPM)}$  (if enabled), a single 128 $\mu$ s pulse is sent on  $\overline{PG}$  to notify the host, repeating once per minute. When the device has an input voltage greater than  $V_{(BAT)} + 1$  V and  $V_{IN}$  is less than  $V_{OVP}$ , two consecutive 128 $\mu$ s pulses are sent on  $\overline{PG}$ , to notify the host, repeating once per minute. The  $\overline{PG}$  pin does not function as an input power good indicator in this mode.

The INT pin is pulled low during charging when the EN\_INT bit is set to 1 and interrupts are pulled high. When EN\_INT is set to 0, charging status is not indicated on the INT pin. When charge is complete or disabled, INT is high impedance. The charge status is valid whether it is the first charge or recharge. When a fault occurs, a 128  $\mu$ s pulse (interrupt) is sent on INT to notify the host.

### 9.3.20 Chip Disable ( $\overline{CD}$ )

The device contains a  $\overline{CD}$  input that is used to disable the device and place it into a high impedance mode when only battery is present. In this case, when  $\overline{CD}$  is low, PMID and SYS remain active, and the battery discharge FET is turned on. If the LS/LDO output has been enabled prior to pulling  $\overline{CD}$  low, it will stay on. The LSCTRL pin can also enable/disable the LS/LDO output when the  $\overline{CD}$  pin is pulled low. The  $\overline{CD}$  pin has an internal pull-down.

If  $V_{IN}$  is present and the  $\overline{CD}$  input is pulled low, charge is enabled and all other functions remain active. If  $V_{IN}$  is present and the  $\overline{CD}$  input is pulled high, charge is disabled.

### 9.3.21 Buck (PWM) Output

The device integrates a low quiescent current switching regulator with DCS control allowing high efficiency down to 10- $\mu$ A load currents. DCS control combines the advantages of hysteretic and voltage mode control. The internally compensated regulation network achieves fast and stable operation with small external components and low ESR capacitors. During PWM mode, it operates in continuous conduction mode, with a frequency up to 2 MHz. If the load current decreases, the converter enters a power save mode to maintain high efficiency down to light loads. In this mode, the device generates a single switching pulse to ramp up the inductor current and recharge the output capacitor, followed by a sleep period where most of the internal circuits are shut down to achieve a low quiescent current. The duration of the sleep period depends on the load current and the inductor peak current.

The output voltage is programmable using the SYS\_SEL and SYS\_VOUT bits in the SYS VOUT control register.

The SW output is enabled using the EN\_SYS\_OUT bit in the register. This bit is for testing and debug only and not intended to be used in the final system. When the device is enabled, the internal reference is powered up and the device enters softstart, starts switching, and ramps up the output voltage. When SW is disabled, the output is in shutdown mode in a low quiescent state. The device provides automatic output voltage discharge so the output voltage will ramp up from zero once the device is enabled again. Once SYS has been disabled, either  $V_{IN}$  needs to be connected or the  $\overline{MR}$  button must be held low for the  $t_{RESET}$  duration to re-enable SYS.

The output is optimized for operation with a 2.2- $\mu$ H inductor and 10- $\mu$ F output capacitor. 表 6 shows the recommended LC output filter combinations.

**表 6. Recommended Output Filter**

| INDUCTOR VALUE ( $\mu$ H) | OUTPUT CAPACITOR VALUE ( $\mu$ F) |             |          |
|---------------------------|-----------------------------------|-------------|----------|
|                           | 4.7                               | 10          | 22       |
| 2.2                       | Possible                          | Recommended | Possible |

The inductor value affects the peak-to-peak ripple current, the PWM-to-PFM transition point where the part enters and exits Pulse Frequency Modulation to lower the power consumed at low loads, the output voltage ripple and the efficiency. The selected inductor must be selected for its DC resistance and saturation current. The inductor ripple current ( $\Delta I_L$ ) can be estimated according to 公式 7.

$$\Delta I_L = V_{OUT} \times (1 - (V_{OUT}/V_{IN})) / (L \times f) \quad (7)$$

Use 公式 8 to calculate the maximum inductor current under static load conditions. The saturation current of the inductor should be rated higher than the maximum inductor current. As the size of the inductor decreases, the saturation “knee” must be carefully considered to ensure that the inductance does not decrease during higher load condition or transient. This is recommended because during a heavy load transient the inductor current rises above the calculated value. A more conservative way is to select the inductor saturation current above the high-side MOSFET switch current.

$$I_L(\max) = I_{OUT}(\max) + \Delta I_L / 2 \quad (8)$$

Where

- F = Switching Frequency
- L = Inductor Value
- $\Delta I_L$  = Peak to Peak inductor ripple current
- $I_L(\max)$  = Maximum Inductor current

In DC/DC converter applications, the efficiency is affected by the inductor AC resistance and by the inductor DCR value.

表 7 shows recommended inductor series from different suppliers.

**表 7. Inductor Series**

| INDUCTANCE ( $\mu$ H) | DCR ( $\Omega$ ) | DIMENSIONS ( $\text{mm}^3$ ) | INDUCTOR TYPE | SUPPLIER (1) | COMMENT                  |
|-----------------------|------------------|------------------------------|---------------|--------------|--------------------------|
| 2.2                   | 0.300            | 1.6 x 0.8 x 0.8              | MDT1608CH2R2N | TOKO         | Smallest size, 75mA max  |
| 2.2                   | 0.170            | 1.6 x 0.8 x 0.8              | GLFR1608T2R2M | TDK          | Smallest size, 150mA max |

(1) See [Third-party Products Disclaimer](#)

**表 7. Inductor Series (接下页)**

| INDUCTANCE (μH) | DCR (Ω) | DIMENSIONS (mm <sup>3</sup> ) | INDUCTOR TYPE | SUPPLIER <sup>(1)</sup> | COMMENT                     |
|-----------------|---------|-------------------------------|---------------|-------------------------|-----------------------------|
| 2.2             | 0.245   | 2.0 x 1.2 x 1.0               | MDT2012CH2R2N | TOKO                    | Small size, high efficiency |
| 2.2             | 0.23    | 2.0 x 1.2 x 1.0               | MIPSZ2012 2R2 | TDK                     |                             |
| 2.2             | 0.225   | 2.0 x 1.6 x 1.0               | 74438343022   | Würth                   |                             |
| 2.2             | 0.12    | 2.5 x 2.0 x 1.2               | MIPSA2520 2R2 | TDK                     |                             |
| 2.2             | 0.145   | 3.3 x 3.3 x 1.4               | LPS3314       | Coicraft                |                             |

The PWM allows the use of small ceramic capacitors. Ceramic capacitors with low ESR values have the lowest output voltage ripple and are recommended. The output capacitor requires either an X7R or X5R dielectric. At light load currents, the converter operates in Power Save Mode and the output voltage ripple is dependent on the output capacitor value and the PFM peak inductor current. Because the PWM converter has a pulsating input current, a low ESR input capacitor is required on PMID for the best voltage filtering to ensure proper function of the device and to minimize input voltage spikes. For most applications a 10-μF capacitor value is sufficient. The PMID capacitor can be increased to 22 μF for better input voltage filtering.

表 8 shows the recommended input/output capacitors.

**表 8. Capacitors**

| CAPACITANCE (μF) | SIZE | CAPACITOR TYPE    | SUPPLIER <sup>(1)</sup> | COMMENT       |
|------------------|------|-------------------|-------------------------|---------------|
| 10               | 0603 | GRM188R60J106ME84 | Murata                  | Recommended   |
| 10               | 0402 | CL05A106MP5NUNC   | Samsung EMA             | Smallest size |

(1) See [Third-party Products Disclaimer](#)

### 9.3.22 Load Switch / LDO Output and Control

The device integrates a low I<sub>q</sub> load switch which can also be used as a regulated output. The LSCTRL pin can be used to turn the load on or off. Activating LSCTRL continuously holds the switch in the on state so long as there is not a fault. The signal is active HI and has a low threshold making it capable of interfacing with low voltage signals. To limit voltage drop or voltage transients, a small ceramic capacitor must be placed close to VINLS. Due to the body diode of the PMOS switch, it is recommended to have the capacitor on VINLS ten times larger than the output capacitor on LS/LDO.

The output voltage is programmable using the LS\_LDO bits in the register. The LS/LDO voltage is calculated using [公式 9](#).

$$LS/LDO = 0.8 \text{ V} + LS\_LDOCODE \times 100 \text{ mV} \quad (9)$$

If a value greater than 3.3 V is written, the setting goes to pass-through mode where LS/LDO = VINLS - V<sub>(DROPOUT)</sub>. [表 9](#) summarizes the control of the LS/LDO output based on the I<sup>2</sup>C or LSCTRL pin setting:

**表 9. LS/LDO Output Control**

| I <sup>2</sup> C LS_LDO_EN | PIN LSCTRL | I <sup>2</sup> C V <sub>LDO</sub> > 3.3 | LS/LDO Output    |
|----------------------------|------------|---|------------------|
| 0                          | 0          | 0                                       | Pulldown         |
| 0                          | 0          | 1                                       | Pulldown         |
| 0                          | 1          | 0                                       | V <sub>LDO</sub> |
| 0                          | 1          | 1                                       | LSW              |
| 1                          | 0          | 0                                       | V <sub>LDO</sub> |
| 1                          | 0          | 1                                       | LSW              |
| 1                          | 1          | 0                                       | V <sub>LDO</sub> |
| 1                          | 1          | 1                                       | LSW              |

If the output of the LDO is less than the programmed  $V_{(SYS)}$  voltage, connect VINLS to SYS. If the output of the LDO is greater than the programmed  $V_{SYS}$  voltage, connect VINLS to PMID.

The current capability of the LDO depends on the VINLS input voltage and the programmed output voltage. The full 100-mA output current for 0.8-V output voltage can be achieved when  $V_{(VINLS)} > 3.25$  V. The full 100-mA output current for 3.3-V output voltage can be achieved when  $V_{(VINLS)} > 3.6$  V.

When the LSLDO output is disabled with LSCTRL or through the register, an internal pull-down discharges the output.

### 9.3.23 Manual Reset Timer and Reset Output ( $\overline{MR}$ and $\overline{RESET}$ )

The  $\overline{MR}$  input has an internal pull-up to  $\overline{BAT}$ , and  $\overline{MR}$  is functional only when BAT is present or when VIN is valid, stable, and charge is enabled. If  $\overline{MR}$  input is asserted during a transient condition while VIN ramps up the IC may incorrectly turn off the SYS buck output, therefore  $\overline{MR}$  should not be asserted during this condition in order to avoid unwanted shutdown of SYS output rail. The input conditions can be adjusted by using MRWAKE bits for the wake conditions and MRRESET bits for the reset conditions. When a wake condition is met, a 128- $\mu$ s pulse is sent on INT to notify the host, and the WAKE1 and/or WAKE2 bits are updated on I<sup>2</sup>C. The MR\_WAKE bits and RESET FAULT bits are not cleared until the Push-button Control Register is read from I<sup>2</sup>C.

When a  $\overline{MR}$  reset condition is met, a 128us pulse is sent on INT to notify the host and a  $\overline{RESET}$  signal is asserted. A reset pulse occurs with duration of  $t_{RESET\_D}$  only one time after each valid MRRESET condition. The  $\overline{MR}$  pin must be released (go high) and then driven low for the MRWAKE period before  $\overline{RESET}$  asserts again. After  $\overline{RESET}$  is asserted with battery only present, the device enters either Ship mode or Hi-Z mode depending on MRREC register settings. After  $\overline{RESET}$  is asserted with a valid  $V_{IN}$  present, the device resumes operation prior to the MR button press. If SYS was disabled prior to  $\overline{RESET}$ , the SYS output is re-enabled if recovering into Hi-Z or Active Battery.

The MRRESET\_VIN register can be configured to have  $\overline{RESET}$  asserted by a button press only, or by a button press and  $V_{IN}$  present ( $V_{UVLO} + V_{SLP} < V_{IN} < V_{OVP}$ ).

## 9.4 Device Functional Modes

**表 10. Modes and Functions**

| FUNCTION                      | READY (PRIOR TO I <sup>2</sup> C) AND AFTER RESET | HOST MODE READY (AFTER I <sup>2</sup> C) | CHARGE                      | SHIP MODE | HIGH_Z     | ACTIVE BATTERY |
|-------------------------------|---|--|-----------------------------|-----------|------------|----------------|
| VOVP                          | Yes   | Yes                                      | Yes                         | No        | No         | No             |
| VUVLO                         | Yes   | Yes                                      | Yes                         | Yes       | Yes        | Yes            |
| VBATUVLO                      | Yes   | Yes                                      | Yes                         | No        | Yes        | Yes            |
| VINDPM                        | OTP or registers                                  | OTP or registers                         | If enabled                  | No        | No         | No             |
| SYS                           | OTP or registers                                  | OTP or registers                         | If enabled                  | No        | If enabled | If enabled     |
| LS/LDO                        | OTP or registers                                  | OTP or registers                         | If enabled                  | No        | If enabled | If enabled     |
| BATFET                        | Yes   | Yes                                      | Yes                         | No        | Yes        | Yes            |
| TS                            | Yes (VIN Valid)                                   | Yes (VIN Valid)                          | Yes                         | No        | No         | No             |
| IPRETERM                      | External  | OTP, registers, or external              | OTP, registers, or external | No        | No         | No             |
| ISSET                         | External  | OTP, registers, or external              | OTP, registers, or external | No        | No         | No             |
| ILIM                          | External  | OTP, registers, or external              | OTP, registers, or external | No        | No         | No             |
| $\overline{\text{MR}}$ input  | Yes   | Yes                                      | Yes                         | Yes       | Yes        | Yes            |
| LSCTRL input                  | Yes   | Yes                                      | Yes                         | No        | Yes        | Yes            |
| RESET output                  | Yes   | Yes                                      | Yes                         | No        | Yes        | Yes            |
| INT output                    | Yes   | Yes                                      | Yes                         | No        | No         | Yes            |
| I <sup>2</sup> C interface    | Yes   | Yes                                      | Yes                         | No        | No         | Yes            |
| $\overline{\text{CD}}$ input  | Yes   | Yes                                      | Yes                         | No        | Yes        | Yes            |
| $\overline{\text{PG}}$ output | Yes   | Yes                                      | Yes                         | No        | No         | If enabled     |
| VBMON                         | No  | Yes                                      | No                          | No        | No         | Yes            |

**表 11. Fault and Status Condition Responses**

| FAULT or STATUS | ACTIONS   | CHARGER BEHAVIOR               | SYS BEHAVIOR                       | LS/LDO BEHAVIOR                    | TS BEHAVIOR          |
|-----------------|---|--------------------------------|------------------------------------|------------------------------------|----------------------|
| VIN_OV          | Update VIN_OV status, Update STAT to fault, interrupt on INT, PG shown not good | Disabled                       | Enabled through BAT                | Enabled through BAT                | Disabled             |
| VIN_UV          | Update VIN_UV status, Update STAT to fault, interrupt on INT, PG shown not good | Disabled                       | Enabled through BAT                | Enabled through BAT                | Disabled             |
| VIN_ILIM        | Update charge in progress status, interrupt on INT, input current is limited    | Enabled, input current limited | Enabled (if enabled)               | Enabled (if enabled)               | Enabled              |
| OVER_TEMP       |   | Disabled                       | Disabled                           | Disabled                           | Disabled             |
| BAT_UVLO        | Update BAT_UVLO status, Update STAT to fault, interrupt on INT                  | Pre-charge                     | Enabled (if enabled) and VIN Valid | Enabled (if enabled) and VIN Valid | Enabled if VIN Valid |
| SW_SYS_SHORT    |   | Enabled                        | Current Limit                      | Enabled (if enabled)               | Enabled              |
| LS_LDO_OCP      |   | Enabled                        | Enabled (if enabled)               | Current Limit                      | Enabled              |
| TIMER fault     | Update TIMER, Update STAT to fault, interrupt on INT                            | Disabled                       | Enabled (if enabled)               | Enabled (if enabled)               | Disabled             |
| VINDPM          | Update VINDPM_STAT, Update STAT to fault, interrupt on INT                      | Enabled, input current reduced | Enabled (if enabled)               | Enabled (if enabled)               | Enabled              |

表 11. Fault and Status Condition Responses (接下页)

| FAULT or STATUS      | ACTIONS  | CHARGER BEHAVIOR                               | SYS BEHAVIOR         | LS/LDO BEHAVIOR      | TS BEHAVIOR |
|----------------------|--|--|----------------------|----------------------|-------------|
| TS_FAULT COLD or HOT | Update TS_FAULT to COLD OR HOT, Update STAT to fault, interrupt on INT | Disabled                                       | Enabled (if enabled) | Enabled (if enabled) | Enabled     |
| TS_FAULT COOL        | Update TS_FAULT to COOL, Update STAT to fault, interrupt on INT        | Reduce ICHG to ½                               | Enabled (if enabled) | Enabled (if enabled) | Enabled     |
| TS_FAULT WARM        | Update TS_FAULT to WARM, Update STAT to fault, interrupt on INT        | Reduce VBATREG by 140 mV                       | Enabled (if enabled) | Enabled (if enabled) | Enabled     |
| Charge Done          | Update STAT to Charge Done, interrupt on INT                           | Disabled, monitor for VBAT falling below VRCHG | Enabled (if enabled) | Enabled (if enabled) | Enabled     |

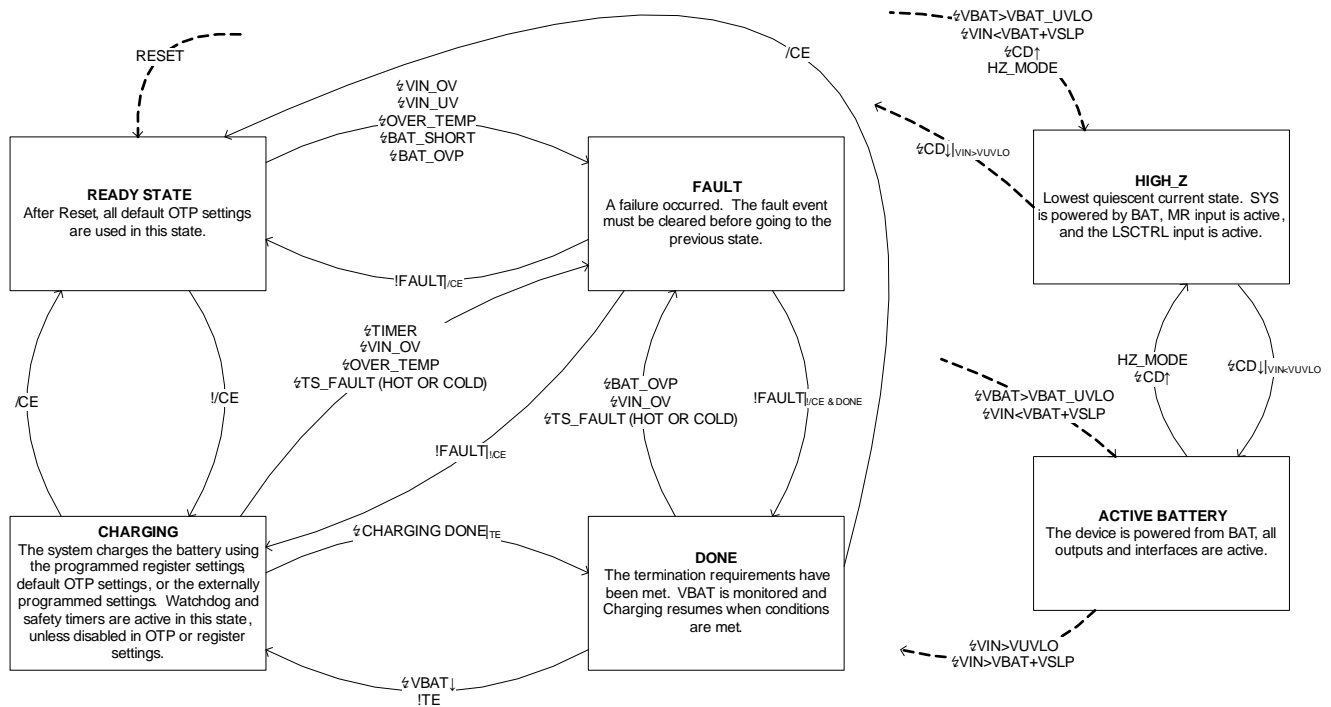

Comments about naming convention

- "/CE" or "HZ\_MODE" -> Register name: event caused by user / configuration
- "! " -> Not
- "/" -> Event caused by external influence
- "Event|condition" -> describes the event with a specific condition

图 17. State Diagram





图 18. Change State Diagram

## 9.5 Programming

### 9.5.1 Serial Interface Description

The device uses an I<sup>2</sup>C compatible interface to program and read many parameters. I<sup>2</sup>C is a 2-wire serial interface developed by NXP. The bus consists of a data line (SDA) and a clock line (SCL) with pull-up structures. When the bus is idle, both SDA and SCL lines are pulled high. All the I<sup>2</sup>C compatible devices connect to the I<sup>2</sup>C bus through open drain I/O terminals, SDA and SCL. A master device, usually a microcontroller or digital signal processor, controls the bus. The master is responsible for generating the SCL signal and device addresses. The master also generates specific conditions that indicate the START and STOP of data transfer. A slave device receives and/or transmits data on the bus under control of the master device.

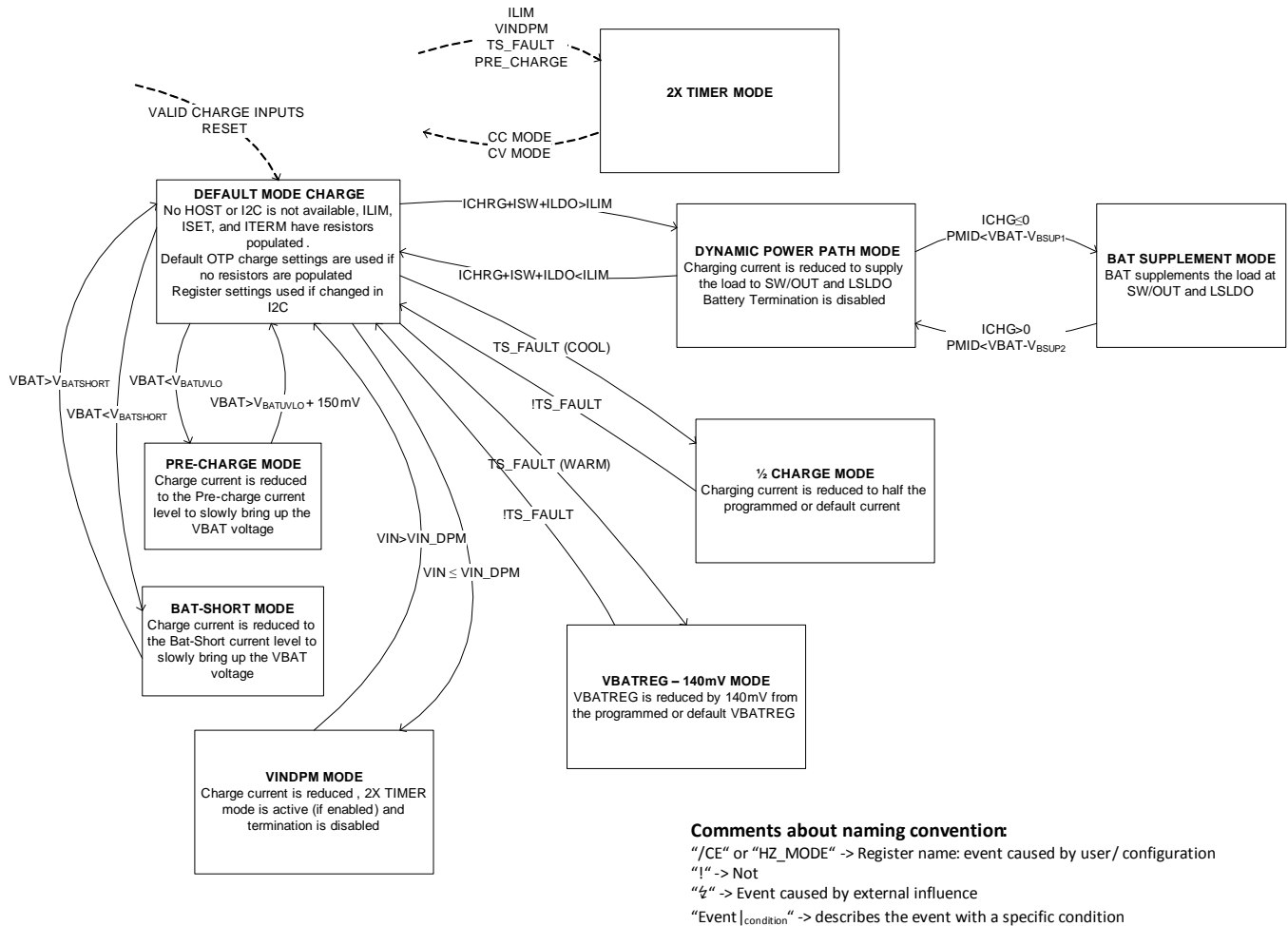
The device works as a slave and supports the following data transfer modes, as defined in the I<sup>2</sup>C BUS Specification: standard mode (100 kbps) and fast mode (400kbps). The interface adds flexibility to the battery management solution, enabling most functions to be programmed to new values depending on the instantaneous application requirements. The I<sup>2</sup>C circuitry is powered from the battery in active battery mode. The battery voltage must stay above  $V_{(BATUVLO)}$  when no  $V_{IN}$  is present to maintain proper operation.

The data transfer protocol for standard and fast modes is exactly the same; therefore, they are referred to as the F/S-mode in this document. The device only supports 7-bit addressing. The device 7-bit address is 6A (8-bit shifted address is D4).

## Programming (接下页)

To avoid I<sup>2</sup>C hang-ups, a timer ( $t_{I2C\text{RESET}}$ ) runs during I<sup>2</sup>C transactions. If the SDA line is held low longer than  $t_{I2C\text{RESET}}$ , any additional commands are ignored and the I<sup>2</sup>C engine is reset. The timeout is reset with START and repeated START conditions and stops when a valid STOP condition is sent.

### 9.5.2 F/S Mode Protocol

The master initiates data transfer by generating a start condition. The start condition is when a high-to-low transition occurs on the SDA line while SCL is high, as shown in 图 19. All I<sup>2</sup>C-compatible devices should recognize a start condition.



图 19. Start Stop Condition

The master then generates the SCL pulses, and transmits the address and the read/write direction bit R/W on the SDA line. During all transmissions, the master ensures that data is valid. A valid data condition requires the SDA line to be stable during the entire high period of the clock pulse (see 图 20). All devices recognize the address sent by the master and compare it to their internal fixed addresses. Only the slave device with a matching address generates and acknowledge (see 图 21) by pulling the SDA line low during the entire high period of the ninth SCL cycle. Upon detecting the acknowledge, the master knows that communication link with a slave has been established.

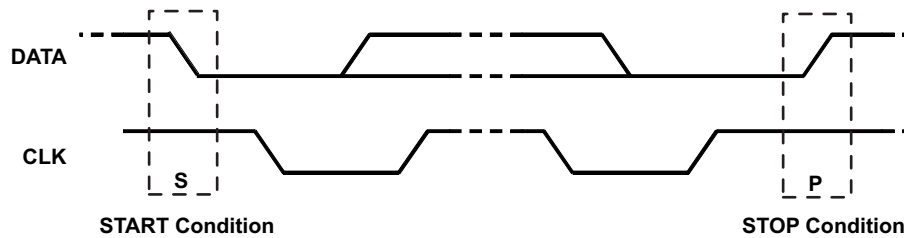

图 20. Bit Transfer on the Serial Interface

Programming (接下页)

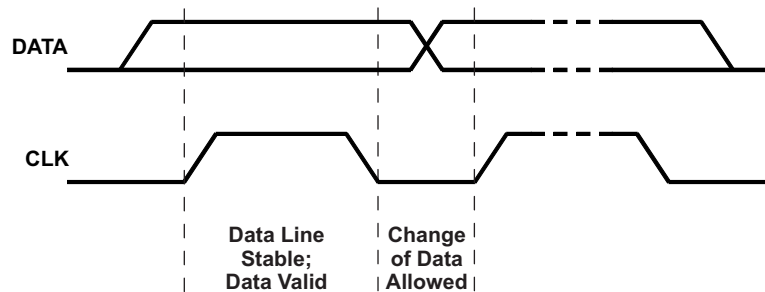

图 21. Acknowledge on the I<sup>2</sup>C Bus

The master generates further SCL cycles to either transmit data to the slave (R/W bit 0) or receive data from the slave (R/W bit 1). In either case, the receiver needs to acknowledge the data sent by the transmitter. An acknowledge signal can either be generated by the master or by the slave, depending on which one is the receiver. The 9-bit valid data sequences consisting of 8-bit data and 1-bit acknowledge can continue as long as necessary. To signal the end of the data transfer, the master generates a stop condition by pulling the SDA line from low to high while the SCL line is high (see 图 22). This releases the bus and stops the communication link with the addressed slave. All I<sup>2</sup>C compatible devices must recognize the STOP condition. Upon the receipt of a STOP condition, all devices know that the bus is released, and wait for a START condition followed by a matching address. If a transaction is terminated prematurely, the master needs to send a STOP condition to prevent the slave I<sup>2</sup>C logic from remaining in an incorrect state. Attempting to read data from register addresses not listed in this section results in 0xFFh being read out.

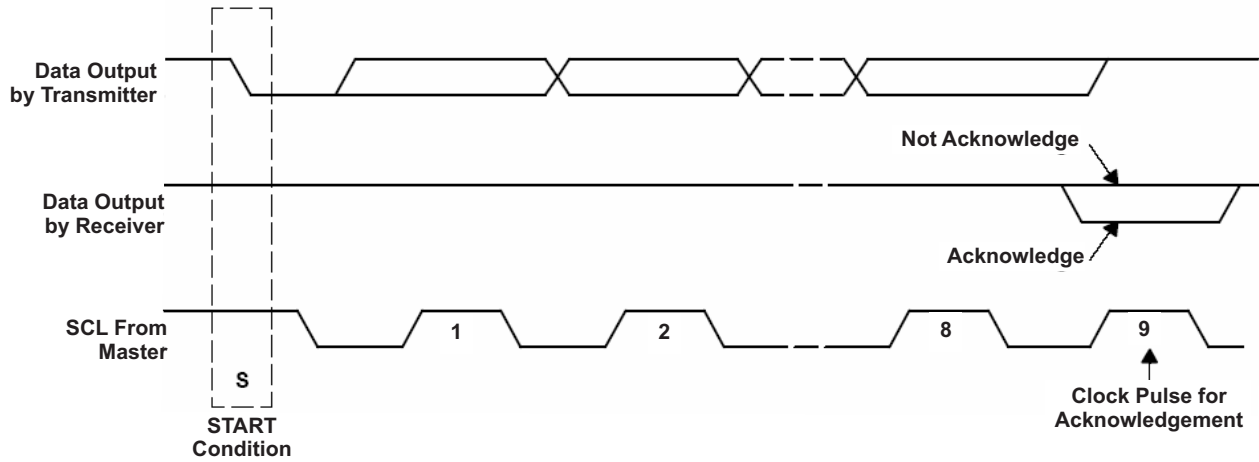

图 22. Bus Protocol

## 9.6 Register Maps

### 9.6.1 Status and Ship Mode Control Register

Memory location 0x00h, Reset State: xx0x xxx1 (bq25120)

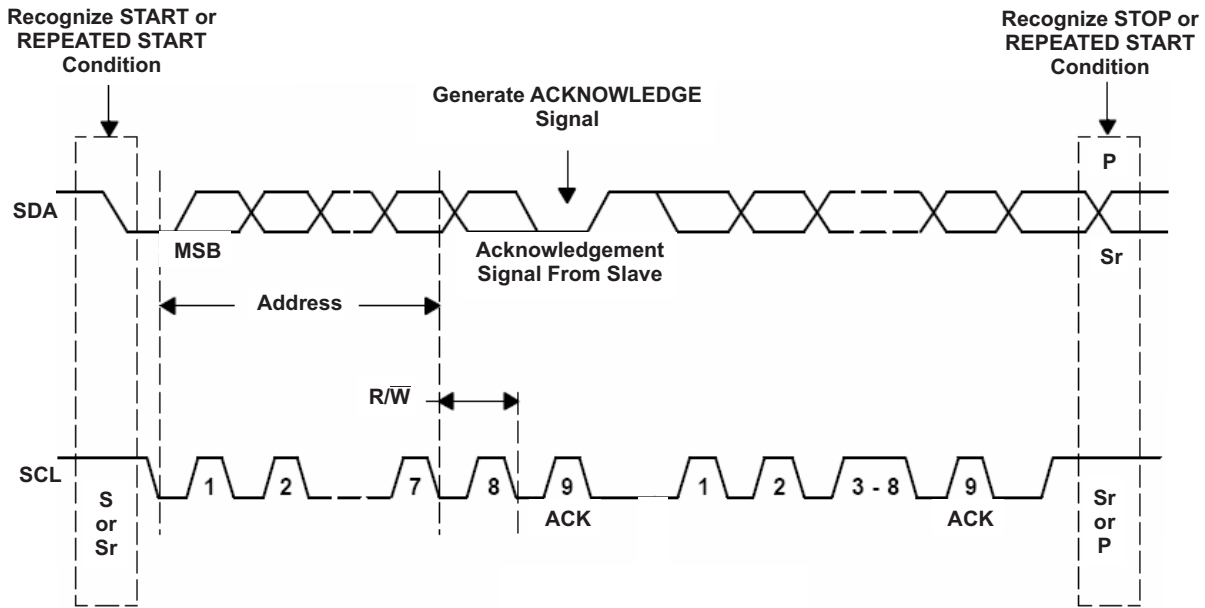
**图 23. Status and Ship Mode Control Register**

| 7 (MSB) | 6 | 5          | 4 | 3 | 2 | 1 | 0 (LSB) |
|---------|---|------------|---|---|---|---|---------|
| x       | x | 0          | x | x | x | x | 1       |
| R       | R | Write Only | R | R | R | R | R       |

LEGEND: R/W = Read/Write; R = Read only; -n = value after reset

**表 12. Status and Ship Mode Control Register**

| Bit      | Field                 | Type       | Reset | Description   |
|----------|-----------------------|------------|-------|---|
| B7 (MSB) | STAT_1                | R          | x     | 00 - Ready<br>01 - Charge in Progress<br>10 - Charge done<br>11 - Fault<br>Status is current status only.                                 |
| B6       | STAT_0                | R          | x     |   |
| B5       | EN_SHIPMODE           | Write Only | 0     | 0 – Normal Operation<br>1 – Ship Mode Enabled   |
| B4       | RESET_FAULT           | R          | x     | 1 – RESET fault. Indicates when the device meets the RESET conditions, and is cleared after I <sup>2</sup> C read.                        |
| B3       | TIMER                 | R          | x     | 1 – Safety timer fault. Continues to show fault after an I <sup>2</sup> C read unless the $\overline{CD}$ pin or power have been toggled. |
| B2       | VINDPM_STAT           | R          | x     | 0 – VIN_DPM is not active<br>1 – VIN_DPM is active  |
| B1       | $\overline{CD}$ _STAT | R          | x     | 0 – $\overline{CD}$ low, IC enabled<br>1 – $\overline{CD}$ high, IC disabled  |
| B0 (LSB) | SYS_EN_STAT           | R          | x     | 1 – SW enabled<br>0 – SW disabled   |

### 9.6.2 Faults and Faults Mask Register

Memory location 0x01h, Reset State: xxxx 0000 (bq25120)

**图 24. Faults and Faults Mask Register**

| 7 (MSB) | 6 | 5 | 4 | 3   | 2   | 1   | 0 (LSB) |
|---------|---|---|---|-----|-----|-----|---------|
| x       | x | x | x | 0   | 0   | 0   | 0       |
| R       | R | R | R | R/W | R/W | R/W | R/W     |

LEGEND: R/W = Read/Write; R = Read only; -n = value after reset

**表 13. Faults and Faults Mask Register**

| Bit      | Field      | Type | Reset | Description   |
|----------|------------|------|-------|---|
| B7 (MSB) | VIN_OV     | R    | x     | 1 - $V_{IN}$ overvoltage fault. VIN_OV continues to show fault after an I <sup>2</sup> C read as long as OV exists  |
| B6       | VIN_UV     | R    | x     | 1 - $V_{IN}$ undervoltage fault. VIN_UV is set when the input falls below $V_{SLP}$ . VIN_UV fault shows only one time. Once read, VIN_UV clears until the the UVLO event occurs. |
| B5       | BAT_UVLO   | R    | x     | 1 - BAT_UVLO fault. BAT_UVLO continues to show fault after an I <sup>2</sup> C read as long as BAT_UVLO conditions exist.   |
| B4       | BAT_OCP    | R    | x     | 1 - BAT_OCP fault. BAT_OCP is cleared after I <sup>2</sup> C read.  |
| B3       | VIN_OV_M   | R/W  | 0     | 1 - Mask $V_{IN}$ overvoltage fault   |
| B2       | VIN_UV_M   | R/W  | 0     | 1 - Mask $V_{IN}$ undervoltage fault  |
| B1       | BAT_UVLO_M | R/W  | 0     | 1 - Mask BAT UVLO fault   |
| B0 (LSB) | BAT_OCP_M  | R/W  | 0     | 1 - Mask BAT_OCP fault  |

### 9.6.3 TS Control and Faults Masks Register

Memory location 0x02h, Reset State: 1xxx 1000 (bq25120)

**图 25. TS Control and Faults Masks Register (02)**

| 7 (MSB) | 6 | 5 | 4 | 3   | 2   | 1   | 0 (LSB) |
|---------|---|---|---|-----|-----|-----|---------|
| 1       | x | x | x | 1   | 0   | 0   | 0       |
| R/W     | R | R | R | R/W | R/W | R/W | R/W     |

LEGEND: R/W = Read/Write; R = Read only; -n = value after reset

**表 14. TS Control and Faults Masks Register, Memory Location 0010**

| Bit      | Field         | Type | Reset | Description  |
|----------|---------------|------|-------|--|
| B7 (MSB) | TS_EN         | R/W  | 1     | 0 – TS function disabled<br>1 – TS function enabled  |
| B6       | TS_FAULT1     | R    | x     | TS Fault mode:<br>00 – Normal, No TS fault<br>01 – TS temp < T <sub>COLD</sub> or TS temp > T <sub>HOT</sub> (Charging suspended)<br>10 – T <sub>COOL</sub> > TS temp > T <sub>COLD</sub> (Charging current reduced by half)<br>11 – T <sub>WARM</sub> < TS temp < T <sub>HOT</sub> (Charging voltage reduced by 140 mV) |
| B5       | TS_FAULT0     | R    | x     |  |
| B4       | TS_FAULT_OPEN | R    | x     | 0 – No TS OFF fault<br>1 – TS OFF fault indicated, and charge has stopped (if enabled in OTP_EN_TS_OPEN)   |
| B3       | EN_INT        | R/W  | 1     | 0 – Disable INT function (INT only shows faults and does not show charge status)<br>1 – Enable INT function (INT shows faults and charge status)   |
| B2       | WAKE_M        | R/W  | 0     | 1 – Mask Wake Condition from $\overline{MR}$   |
| B1       | RESET_M       | R/W  | 0     | 1 – Mask RESET condition from $\overline{MR}$  |
| B0 (LSB) | TIMER_M       | R/W  | 0     | 1 – Mask Timer fault (safety)  |

### 9.6.4 Fast Charge Control Register

Memory location 0x03h, Reset State: 0001 0100 (bq25120)

**图 26. Fast Charge Control Register**

| 7 (MSB) | 6   | 5   | 4   | 3   | 2   | 1   | 0 (LSB) |
|---------|-----|-----|-----|-----|-----|-----|---------|
| 0       | 0   | 0   | 1   | 0   | 1   | 0   | 0       |
| R/W     | R/W | R/W | R/W | R/W | R/W | R/W | R/W     |

LEGEND: R/W = Read/Write; R = Read only; -n = value after reset

**表 15. Fast Charge Control Register**

| Bit      | Field                  | Type | Reset | Description   |
|----------|------------------------|------|-------|---|
| B7 (MSB) | ICHRG_RANGE            | R/W  | 0     | 0 – to select charge range from 5 mA to 35 mA, ICHRG bits are 1-mA steps<br>1 – to select charge range from 40 mA to 300 mA, ICHRG bits are 10-mA steps |
| B6       | ICHRG_4                | R/W  | 0     | Charge current 16 mA or 160 mA  |
| B5       | ICHRG_3                | R/W  | 0     | Charge current 8 mA or 80 mA  |
| B4       | ICHRG_2                | R/W  | 1     | Charge current 4 mA or 40 mA  |
| B3       | ICHRG_1                | R/W  | 0     | Charge current 2 mA or 20 mA  |
| B2       | ICHRG_0                | R/W  | 1     | Charge current 1 mA or 10 mA  |
| B1       | $\overline{\text{CE}}$ | R/W  | 0     | 0 – Charger enabled<br>1 – Charger is disabled  |
| B0 (LSB) | HZ_MODE                | R/W  | 0     | 0 – Not high impedance mode<br>1 – High impedance mode  |

ICHRG\_RANGE and ICHRG bits are used to set the charge current. The  $I_{\text{CHRG}}$  is calculated using the following equation: If ICHRG\_RANGE is 0, then  $I_{\text{CHRG}} = 5 \text{ mA} + I_{\text{CHRG}}\text{CODE} \times 1 \text{ mA}$ . If ICHRG\_RANGE is 1, then  $I_{\text{CHRG}} = 40 \text{ mA} + I_{\text{CHRG}}\text{CODE} \times 10 \text{ mA}$ . If a value greater than 35 mA (ICHRG\_RANGE = 0) or 300 mA (ICHRG\_RANGE = 1) is written, the setting goes to 35 mA or 300 mA respectively except if the ICHRG bits are all 1 (that is, 11111), then the externally programmed value is used. The PRETERM bits must also be set prior to writing all 1s to ensure the external ISET current is used as well as the proper termination and pre-charge values are used. For IPRETERM = 5%, set the IPRETERM bits to 000001, for IPRETERM = 10%, set the IPRETERM bits to 000010, for IPRETERM = 15%, set the IPRETERM bits to 000100, and for IPRETERM = 20%, set the IPRETERM bits to 001000. The default is programmed by the external resistor on ISET, or if not populated and tied to GND, by OTP.

### 9.6.5 Termination/Pre-Charge and I<sup>2</sup>C Address Register

Memory location 0x04h, Reset State: 0000 1110 (bq25120)

**图 27. Termination/Pre-Charge and I<sup>2</sup>C Address Register**

| 7 (MSB) | 6   | 5   | 4   | 3   | 2   | 1   | 0 (LSB) |
|---------|-----|-----|-----|-----|-----|-----|---------|
| 0       | 0   | 0   | 0   | 1   | 1   | 1   | 0       |
| R/W     | R/W | R/W | R/W | R/W | R/W | R/W | R/W     |

LEGEND: R/W = Read/Write; R = Read only; -n = value after reset

**表 16. Termination/Pre-Charge and I<sup>2</sup>C Address Register**

| Bit      | Field          | Type | Reset | Description   |
|----------|----------------|------|-------|---|
| B7 (MSB) | IPRETERM_RANGE | R/W  | 0     | 0 – to select termination range from 500 $\mu$ A to 5 mA, IPRETERM bits are 500- $\mu$ A steps<br>1 – to select charge range from 6 mA to 37 mA, IPRETERM bits are 1-mA steps |
| B6       | IPRETERM_4     | R/W  | 0     | Termination current 8 mA or 16 mA   |
| B5       | IPRETERM_3     | R/W  | 0     | Termination current 4 mA or 8 mA  |
| B4       | IPRETERM_2     | R/W  | 0     | Termination current 2 mA or 4 mA  |
| B3       | IPRETERM_1     | R/W  | 1     | Termination current 1 mA or 2 mA  |
| B2       | IPRETERM_0     | R/W  | 1     | Termination current 500 $\mu$ A or 1 mA   |
| B1       | TE             | R/W  | 1     | 0 – Disable charge current termination<br>1 – Enable charge current termination   |
| B0 (LSB) |                | R/W  | 0     |   |

IPRETERM\_RANGE and IPRETERM bits are used to set the termination and pre-charge current. The  $I_{TERM}$  is calculated using the following equation: If IPRETERM\_RANGE is 0, then  $I_{TERM} = 500 \mu A + I_{TERM}CODE \times 500 \mu A$ . If IPRETERM\_RANGE is 1, then  $I_{TERM} = 6 mA + I_{TERM}CODE \times 1 mA$ . If a value greater than 5 mA (IPRETERM\_RANGE = 0) is written, the setting goes to 5 mA. Termination is disabled if any loop other than CC or DV in control, such as VINDPM, and TS/Cool. The default is programmed by the external resistor on IPRETERM, or if not populated and tied to GND, by OTP.

### 9.6.6 Battery Voltage Control Register

Memory location 0x05h, Reset State: 0111 1000 (bq25120)

**图 28. Battery Voltage Control Register**

| 7 (MSB) | 6   | 5   | 4   | 3   | 2   | 1   | 0 (LSB) |
|---------|-----|-----|-----|-----|-----|-----|---------|
| 0       | 1   | 1   | 1   | 1   | 0   | 0   | 0       |
| R/W     | R/W | R/W | R/W | R/W | R/W | R/W | R/W     |

LEGEND: R/W = Read/Write; R = Read only; -n = value after reset

**表 17. Battery Voltage Control Register**

| Bit      | Field   | Type | Reset | Description                        |
|----------|---------|------|-------|------------------------------------|
| B7 (MSB) | VBREG_6 | R/W  | 0     | Battery Regulation Voltage: 640 mV |
| B6       | VBREG_5 | R/W  | 1     | Battery Regulation Voltage: 320 mV |
| B5       | VBREG_4 | R/W  | 1     | Battery Regulation Voltage: 160 mV |
| B4       | VBREG_3 | R/W  | 1     | Battery Regulation Voltage: 80 mV  |
| B3       | VBREG_2 | R/W  | 1     | Battery Regulation Voltage: 40 mV  |
| B2       | VBREG_1 | R/W  | 0     | Battery Regulation Voltage: 20 mV  |
| B1       | VBREG_0 | R/W  | 0     | Battery Regulation Voltage: 10 mV  |
| B0 (LSB) |         | R/W  | 0     |                                    |

VBREG Bits: Use VBREG bits to set the battery regulation threshold. The  $V_{BATREG}$  is calculated using the following equation:  $V_{BATREG} = 3.6 V + V_{BREG}CODE \times 10 mV$ . The charge voltage range is from 3.6 V to 4.65 V. If a value greater than 4.65 V is written, the setting goes to 4.65 V. Default is programmed by OTP.



### 9.6.7 SYS VOUT Control Register

Memory location 0x06h, Reset State: 1010 1010 (bq25120)

**图 29. SYS VOUT Control Register**

| 7 (MSB) | 6   | 5   | 4   | 3   | 2   | 1   | 0 (LSB) |
|---------|-----|-----|-----|-----|-----|-----|---------|
| 1       | 0   | 1   | 0   | 1   | 0   | 1   | 0       |
| R/W     | R/W | R/W | R/W | R/W | R/W | R/W | R/W     |

LEGEND: R/W = Read/Write; R = Read only; -n = value after reset

**表 18. SYS VOUT Control Register**

| Bit      | Field      | Type | Reset | Description   |
|----------|------------|------|-------|---|
| B7 (MSB) | EN_SYS_OUT | R/W  | 1     | 0 – Disable SW<br>1 – Enable SW<br>(When disabled, output is pulled low)                    |
| B6       | SYS_SEL1   | R/W  | 0     | 00 – 1.1 V and 1.2 V selection  |
| B5       | SYS_SEL0   | R/W  | 1     | 01 – 1.3 V through 2.8 V selection,<br>10 – Not Valid<br>11 – 1.8 V through 3.3 V selection |
| B4       | SYS_VOUT_3 | R/W  | 0     | OUT Voltage: 800 mV step if SYS_SEL is 01 or 11   |
| B3       | SYS_VOUT_2 | R/W  | 1     | OUT Voltage: 400 mV step if SYS_SEL is 01 or 11   |
| B2       | SYS_VOUT_1 | R/W  | 0     | OUT Voltage: 200 mV step if SYS_SEL is 01 or 11   |
| B1       | SYS_VOUT_0 | R/W  | 1     | OUT Voltage: 100 mV step if SYS_SEL is 01 or 11   |
| B0 (LSB) |            |      | 0     |   |

SW\_VOUT Bits: Use SYS\_SEL and SYS\_VOUT bits to set the output on SYS. The SYS voltage is calculated using the following equation:  
See table below for all VOUT values that can be programmed through SYS\_SEL and SYS\_VOUT.  
If SYS\_SEL = 01, then SYS = 1.30 V + SYS\_VOUTCODE x 100 mV.  
If SYS\_SEL = 11, then SYS = 1.80 V + SYS\_VOUTCODE x 100 mV.

**表 19. SYS\_SEL Codes**

| SYS_SEL | SYS_VOUT | TYP   | UNIT |
|---------|----------|-------|------|
| 00      | 0000     | 1.1   | V    |
| 00      | 0001     | 1.2   | V    |
| 00      | 0010     | 1.25  | V    |
| 00      | 0011     | 1.333 | V    |
| 00      | 0100     | 1.417 | V    |
| 00      | 0101     | 1.5   | V    |
| 00      | 0110     | 1.583 | V    |
| 00      | 0111     | 1.667 | V    |
| 00      | 1000     | 1.75  | V    |
| 00      | 1001     | 1.833 | V    |
| 00      | 1010     | 1.917 | V    |
| 00      | 1011     | 2     | V    |
| 00      | 1100     | 2.083 | V    |
| 00      | 1101     | 2.167 | V    |
| 00      | 1110     | 2.25  | V    |
| 00      | 1111     | 2.333 | V    |
| 01      | 0000     | 1.3   | V    |
| 01      | 0001     | 1.4   | V    |
| 01      | 0010     | 1.5   | V    |
| 01      | 0011     | 1.6   | V    |
| 01      | 0100     | 1.7   | V    |
| 01      | 0101     | 1.8   | V    |
| 01      | 0110     | 1.9   | V    |

**表 19. SYS\_SEL Codes (接下页)**

| SYS_SEL | SYS_VOUT | TYP   | UNIT |
|---------|----------|-------|------|
| 01      | 0111     | 2     | V    |
| 01      | 1000     | 2.1   | V    |
| 01      | 1001     | 2.2   | V    |
| 01      | 1010     | 2.3   | V    |
| 01      | 1011     | 2.4   | V    |
| 01      | 1100     | 2.5   | V    |
| 01      | 1101     | 2.6   | V    |
| 01      | 1110     | 2.7   | V    |
| 01      | 1111     | 2.8   | V    |
| 10      | 0000     | 1.5   | V    |
| 10      | 0001     | 1.583 | V    |
| 10      | 0010     | 1.667 | V    |
| 10      | 0011     | 1.75  | V    |
| 10      | 0100     | 1.833 | V    |
| 10      | 0101     | 1.917 | V    |
| 10      | 0110     | 2     | V    |
| 10      | 0111     | 2.083 | V    |
| 10      | 1000     | 2.167 | V    |
| 10      | 1001     | 2.25  | V    |
| 10      | 1010     | 2.333 | V    |
| 10      | 1011     | 2.417 | V    |
| 10      | 1100     | 2.5   | V    |
| 10      | 1101     | 2.583 | V    |
| 10      | 1110     | 2.667 | V    |
| 10      | 1111     | 2.75  | V    |
| 11      | 0000     | 1.8   | V    |
| 11      | 0001     | 1.9   | V    |
| 11      | 0010     | 2     | V    |
| 11      | 0011     | 2.1   | V    |
| 11      | 0100     | 2.2   | V    |
| 11      | 0101     | 2.3   | V    |
| 11      | 0110     | 2.4   | V    |
| 11      | 0111     | 2.5   | V    |
| 11      | 1000     | 2.6   | V    |
| 11      | 1001     | 2.7   | V    |
| 11      | 1010     | 2.8   | V    |
| 11      | 1011     | 2.9   | V    |
| 11      | 1100     | 3     | V    |
| 11      | 1101     | 3.1   | V    |
| 11      | 1110     | 3.2   | V    |
| 11      | 1111     | 3.3   | V    |

### 9.6.8 Load Switch and LDO Control Register

Memory location 0x07h, Reset State: 0111 110x (bq25120)

**图 30. Load Switch and LDO Control Register**

| 7 (MSB) | 6   | 5   | 4   | 3   | 2   | 1 | 0 (LSB) |
|---------|-----|-----|-----|-----|-----|---|---------|
| 0       | 1   | 1   | 1   | 1   | 1   | 0 | x       |
| R/W     | R/W | R/W | R/W | R/W | R/W | R | R       |

LEGEND: R/W = Read/Write; R = Read only; -n = value after reset

**表 20. Load Switch and LDO Control Register**

| Bit      | Field       | Type | Reset | Description  |
|----------|-------------|------|-------|--|
| B7 (MSB) | EN_LS_LDO   | R/W  | 0     | 0 – Disable LS/LDO<br>1 – Enable LS/LDO  |
| B6       | LS_LDO_4    | R/W  | 1     | LS/LDO Voltage: 1600 mV  |
| B5       | LS_LDO_3    | R/W  | 1     | LS/LDO Voltage: 800 mV   |
| B4       | LS_LDO_2    | R/W  | 1     | LS/LDO Voltage: 400 mV   |
| B3       | LS_LDO_1    | R/W  | 1     | LS/LDO Voltage: 200 mV   |
| B2       | LS_LDO_0    | R/W  | 1     | LS/LDO Voltage: 100 mV   |
| B1       |             |      | 0     |  |
| B0 (LSB) | MRRESET_VIN | R/W  | x     | 0 – Reset sent when $\overline{MR}$ Reset time is met<br>1 – Reset sent when $\overline{MR}$ Reset time is met and $V_{UVLO} + V_{SLP} < V_{IN} < V_{OVP}$ |

LS\_LDO Bits: Use LS\_LDO bits to set the LS/LDO output. The LS/LDO voltage is calculated using the following equation:  $LS/LDO = 0.8 V + LS\_LDOCODE \times 100 mV$ . If a value greater than 3.3 V is written, the setting goes to pass-through mode where  $LS/LDO = V_{INLS} - V_{DROPOUT}$ . The LS\_LDO output can only be changed when the EN\_LS\_LDO and LSCTRL pin has disabled the output.

### 9.6.9 Push-button Control Register

Memory location 0x08h, Reset State: 0110 10xx (bq25120)

**图 31. Push-button Control Register**

| 7 (MSB) | 6   | 5   | 4   | 3   | 2   | 1 | 0 (LSB) |
|---------|-----|-----|-----|-----|-----|---|---------|
| 0       | 1   | 1   | 0   | 1   | 0   | x | x       |
| R/W     | R/W | R/W | R/W | R/W | R/W | R | R       |

LEGEND: R/W = Read/Write; R = Read only; -n = value after reset

**表 21. Push-button Control Register**

| Bit      | Field     | Type | Reset | Description  |
|----------|-----------|------|-------|--|
| B7 (MSB) | MRWAKE1   | R/W  | 0     | $\overline{MR}$ Timer adjustment for WAKE1:<br>0 – 50 ms < $\overline{MR}$<br>1 – 500 ms < $\overline{MR}$               |
| B6       | MRWAKE2   | R/W  | 1     | $\overline{MR}$ Timer adjustment for WAKE2:<br>0 – 1000 ms < $\overline{MR}$<br>1 – 1500 ms < $\overline{MR}$            |
| B5       | MRREC     | R/W  | 1     | 0 – After Reset, device enters Ship mode<br>1 – After Reset, device enters Hi-Z Mode                                     |
| B4       | MRRESET_1 | R/W  | 0     | $\overline{MR}$ Timer adjustment for reset:<br>00 – 4 s ± 10%<br>01 – 8 s ± 10%<br>10 – 10 s ± 10%<br>11 – 14 s ± 10%    |
| B3       | MRRESET_0 | R/W  | 1     |  |
| B2       | PGB_MR    | R/W  | 0     | 0 – Output functions as $\overline{PG}$<br>1 – Output functions as voltage shifted push-button ( $\overline{MR}$ ) input |
| B1       | WAKE1     | R    | x     | 1 – WAKE1 status. Indicates when the device meets the WAKE1 conditions, and is cleared after I <sup>2</sup> C read.      |
| B0 (LSB) | WAKE2     | R    | x     | 1 – WAKE2 status. Indicates when the device meets the WAKE2 conditions, and is cleared after I <sup>2</sup> C read.      |

### 9.6.10 ILIM and Battery UVLO Control Register

Memory location 0x09h, Reset State: 0000 1010 (bq25120)

**图 32. ILIM and Battery UVLO Control Register**

| 7 (MSB) | 6   | 5   | 4   | 3   | 2   | 1   | 0 (LSB) |
|---------|-----|-----|-----|-----|-----|-----|---------|
| 0       | 0   | 0   | 0   | 1   | 0   | 1   | 0       |
| Write   | R/W | R/W | R/W | R/W | R/W | R/W | R/W     |

LEGEND: R/W = Read/Write; R = Read only; -n = value after reset

**表 22. ILIM and Battery UVLO Control Register, Memory Location 1001**

| Bit      | Field   | Type       | Reset | Description   |
|----------|---------|------------|-------|---|
| B7 (MSB) | RESET   | Write only | 0     | Write:<br>1- Reset all registers to default values<br>0 – No effect<br>Read: Always get 0 |
| B6       |         | R/W        | 0     | N/A   |
| B5       | INLIM_2 | R/W        | 0     | Input Current Limit: 200 mA   |
| B4       | INLIM_1 | R/W        | 0     | Input Current Limit: 100 mA   |
| B3       | INLIM_0 | R/W        | 1     | Input Current Limit: 50 mA  |
| B2       | BUVLO_2 | R/W        | 0     | 000, 001, 010: BUVLO = 3 V  |
| B1       | BUVLO_1 | R/W        | 1     | 011: BUVLO = 2.8 V<br>100: BUVLO = 2.6 V  |
| B0 (LSB) | BUVLO_0 | R/W        | 0     | 101: BULVO = 2.4 V<br>110: BUVLO = 2.2 V<br>111: BUVLO = Disabled                         |

INLIM Bits: Use INLIM bits to set the input current limit. The  $I_{(INLIM)}$  is calculated using the following equation:  $I_{(INLIM)} = 50 \text{ mA} + I_{(INLIM)CODE} \times 50 \text{ mA}$ . The default is programmed by the external resistor on ILIM, or if not populated and tied to GND, by OTP.

### 9.6.11 Voltage Based Battery Monitor Register

Memory location 0x0Ah, Reset State: 0xxx xxxx (bq25120)

**图 33. Voltage Based Battery Monitor Register**

| 7 (MSB) | 6 | 5 | 4 | 3 | 2 | 1 | 0 (LSB) |
|---------|---|---|---|---|---|---|---------|
| 0       | x | x | x | x | x | x | x       |
| R/W     | R | R | R | R | R | R | R       |

LEGEND: R/W = Read/Write; R = Read only; -n = value after reset

**表 23. Voltage Based Battery Monitor Register, Memory Location 1010**

| Bit      | Field         | Type | Reset | Description   |
|----------|---------------|------|-------|---|
| B7 (MSB) | VBMON_READ    | R/W  | 0     | Write 1 to initiate a new VBATREG reading. Read always 0.                                       |
| B6       | VBMON_RANGE_1 | R    | x     | 11 – 90% to 100% of VBATREG   |
| B5       | VBMON_RANGE_0 | R    | x     | 10 – 80% to 90% of VBATREG<br>01 – 70% to 80% of VBATREG<br>00 – 60% to 70% of VBATREG          |
| B4       | VBMON_TH_2    | R    | x     | 111 – Above 8% of VBMON_RANGE   |
| B3       | VBMON_TH_1    | R    | x     | 110 – Above 6% of VBMON_RANGE   |
| B2       | VBMON_TH_0    | R    | x     | 011 – Above 4% of VBMON_RANGE<br>010 – Above 2% of VBMON_RANGE<br>001 – Above 0% of VBMON_RANGE |
| B1       |               | R    | x     | N/A   |
| B0 (LSB) |               | R    | x     | N/A   |

The VBMON registers are used to determine the battery voltage. Before entering a low power state, the device will determine the voltage level by starting at VBMON\_RANGE 11 (90% to 100%), and if VBMON\_TH of 000 is read, then it will move to VBMON\_RANGE 10 (80% to 90%) and continue until a non 000 value of VBMON\_TH is found. If this does not happen, then VBMON\_RANGE and VBMON\_TH will be written with 00 000. The VBMON\_READ bit can be used to initiate a new reading by writing a 1 to it. Example: A reading of 10 011 indicated a VBAT voltage of between 84% and 86% of the VBATREG setting.

**9.6.12 VIN\_DPM and Timers Register**

Memory location 0x0Bh, Reset State: 0100 1010 (bq25120)

**图 34. VIN\_DPM and Timers Register**

| 7 (MSB) | 6   | 5   | 4   | 3   | 2   | 1   | 0 (LSB) |
|---------|-----|-----|-----|-----|-----|-----|---------|
| 0       | 1   | 0   | 0   | 1   | 0   | 1   | 0       |
| R/W     | R/W | R/W | R/W | R/W | R/W | R/W | R/W     |

LEGEND: R/W = Read/Write; R = Read only; -n = value after reset

**表 24. VIN\_DPM and Timers Register**

| Bit      | Field     | Type | Reset | Description   |
|----------|-----------|------|-------|---|
| B7 (MSB) | VINDPM_ON | R/W  | 0     | 0 - enable VINDPM<br>1 - disable VINDPM   |
| B6       | VINDPM_2  | R/W  | 1     | Input $V_{(IN\_DPM)}$ voltage: 400 mV   |
| B5       | VINDPM_1  | R/W  | 0     | Input $V_{(IN\_DPM)}$ voltage: 200 mV   |
| B4       | VINDPM_0  | R/W  | 0     | Input $V_{(IN\_DPM)}$ voltage: 100 mV   |
| B3       | 2XTMR_EN  | R/W  | 1     | 0 – Timer is not slowed at any time<br>1 – Timer is slowed by 2x when in any control other than CC or CV                                  |
| B2       | TMR_1     | R/W  | 0     | Safety Timer Time Limit<br>00 – 30 minute fast charge<br>01 – 3 hour fast charge<br>10 – 9 hour fast charge<br>11 – Disable safety timers |
| B1       | TMR_0     | R/W  | 1     |   |
| B0 (LSB) |           |      | 0     |   |

The VINDPM threshold is set using the following equation:  $VINDPM = 4.2 + VINDPM\_CODE \times 100 \text{ mV}$

## 10 Application and Implementation

### 注

Information in the following applications sections is not part of the TI component specification, and TI does not warrant its accuracy or completeness. TI's customers are responsible for determining suitability of components for their purposes. Customers should validate and test their design implementation to confirm system functionality.

### 10.1 Application Information

A typical design is shown in 图 35. This design uses the BQ25120 with external resistors for ILIM, IPRETERM, and ISET. These are not needed if these values are set with a host controller through I<sup>2</sup>C commands. This design also shows the TS resistors, which is also optional.

When powering up in default mode the battery voltage is the default for the part (4.2 V), the SYS output is the default (1.8 V). External resistors set the charge current to 40 mA, the termination current to 10% (4 mA), and the input current limit to 100 mA. If the I<sup>2</sup>C interface is used the part goes to the internal default settings until changed by the host.

### 10.2 Typical Application

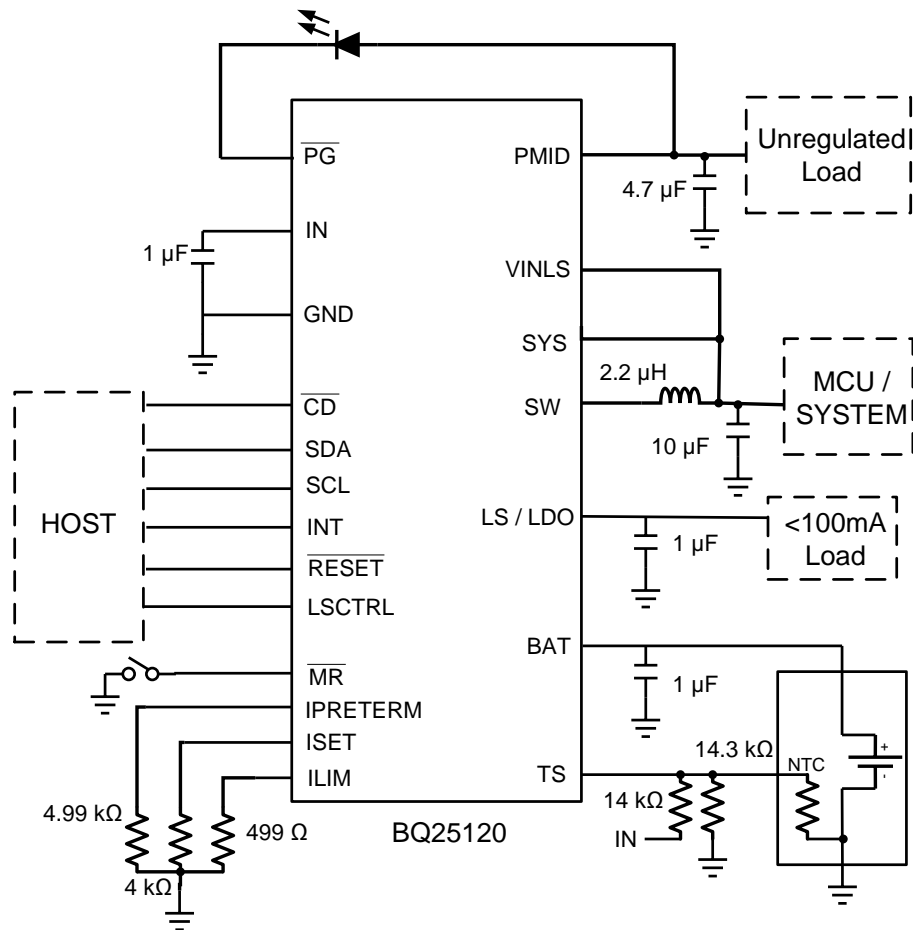

Copyright © 2016, Texas Instruments Incorporated

图 35. Typical Application Circuit

## Typical Application (接下页)

### 10.2.1 Design Requirements

This application is for a low power system that has varying loads from less than 10 mA up to 300 mA. It must work with a valid adaptor or USB power input. Below are some of the key components that are needed in normal operation. For this example, the fast charge current is 50 mA, input current limit is 400 mA and the pre-charge and termination current is 10% of the fast charge current.

- Supply voltage = 3.4 V to 20 V
- Fast charge current is default to 10 mA with ISET pin shorted to ground. To program the fast charge current, connect an external resistor from ISET to ground.
- Input current limit is default to 100 mA with ILIM pin shorted to ground. To program the input current limit, connect an external resistor from ILIM to ground.
- Termination current threshold is default to 2 mA with IPRETERM pin shorted to ground. To program the input current limit, connect an external resistor from IPRETERM to ground.
- A 2.2- $\mu$ H inductor is needed between SW pin and SYS pin for PWM output.
- TS- Battery temperature sense needs a NTC connected on TS pin.

### 10.2.2 Detailed Design Procedure

See [图 35](#) for an example of the application diagram.

#### 10.2.2.1 Default Settings

- Connect ISET, ILIM and IPRETERM pins to ground to program fast charge current to 10mA, input current limit to 100mA and pre-charge/termination current to 2 mA.
- BAT\_UVLO = 3 V.
- VSYS = 1.8 V
- LS/LDO is LS
- VBREG = 4.2 V
- VIN\_DPM is enabled and VIN\_DPM Threshold = 4.6 V.
- Safety Timer = 3 hr
- If the function is not needed, connect TS to the center tab of the resistor divider between  $V_{IN}$  and the ground. (pull up resistor = 14 k $\Omega$ , pull down resistor = 14.3 k $\Omega$ )

#### 10.2.2.2 Choose the Correct Inductance and Capacitance

Refer to the [Buck \(PWM\) Output](#) section for the detailed procedure to determine the optimal inductance and capacitance for the buck output.

#### 10.2.2.3 Calculations

##### 10.2.2.3.1 Program the Fast Charge Current (ISET)

$$R_{ISET} = K_{ISET} / I_{CHG} \quad (10)$$

$K_{ISET} = 200 \text{ A}\Omega$  from the [Specifications](#) table

$$R_{ISET} = 200 \text{ A}\Omega / 0.05\text{A} = 4 \text{ k}\Omega \quad (11)$$

Select the closest standard value, which in this case is 4.99 k $\Omega$ . Connect this resistor between ISET pin and GND.

##### 10.2.2.3.2 Program the Input Current Limit (ILIM)

$$R_{ILIM} = K_{ILIM} / I_{L\_MAX} \quad (12)$$

$K_{ILIM} = 200 \text{ A}\Omega$  from the [Specifications](#) table

$$R_{ILIM} = 200 \text{ A}\Omega / 0.4\text{A} = 500 \Omega \quad (13)$$

Select the closest standard value, which in this case is 499  $\Omega$ . Connect this resistor between ILIM pin and GND.



## Typical Application (接下页)

### 10.2.2.3.3 Program the Pre-charge/termination Threshold (IPRETERM)

According to [表 3](#), the RIPRETERM is 4990  $\Omega$  for 10% termination threshold. Therefore, connect a 4.99 k $\Omega$  resistor between IPRETERM pin and GND.

### 10.2.2.3.4 TS Resistors (TS)

The voltage at TS is monitored to determine that the battery is at a safe temperature during charging. This device uses JEITA temperature profile which has four temperature thresholds. Refer to [Specifications](#) for the detailed thresholds number.

The TS circuit is shown in [图 16](#). The resistor values can be calculated using [公式 1](#) and [公式 2](#).

Typical Application (接下页)

10.2.3 Application Performance Curves

10.2.3.1 Charger Curves

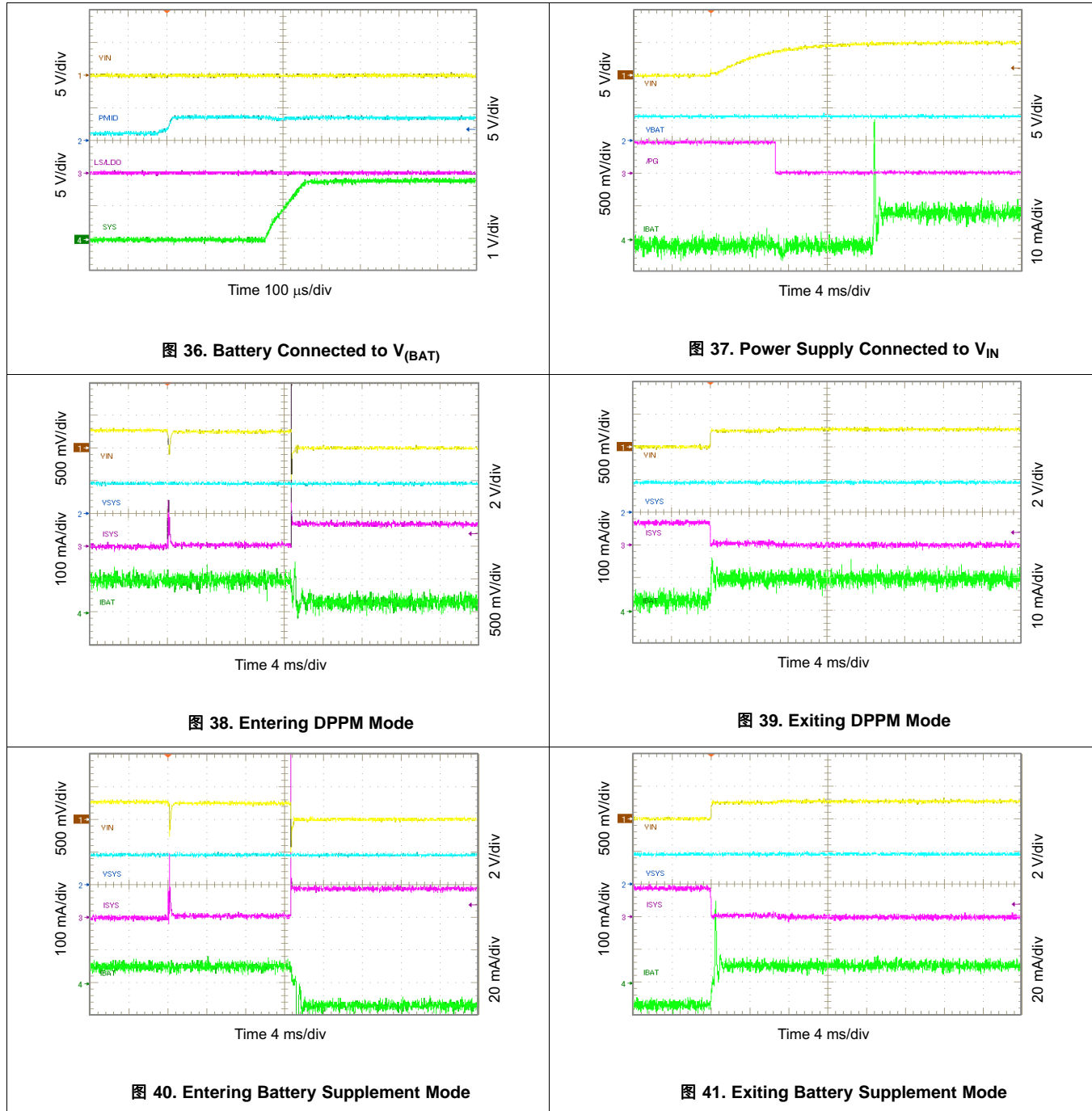

Typical Application (接下页)

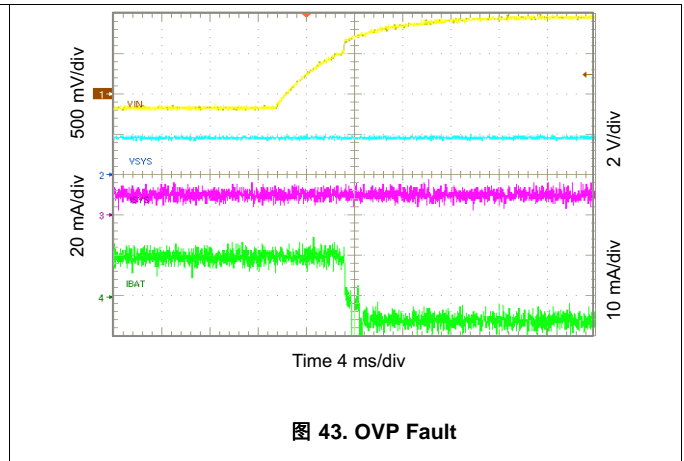
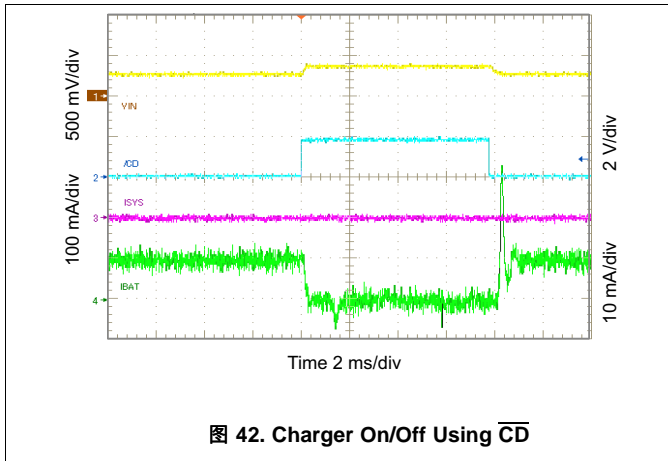

Typical Application (接下页)

10.2.3.2 SYS Output Curves

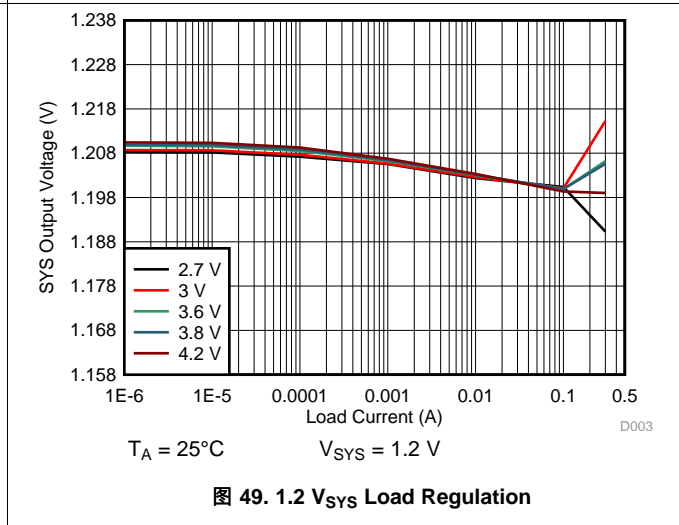
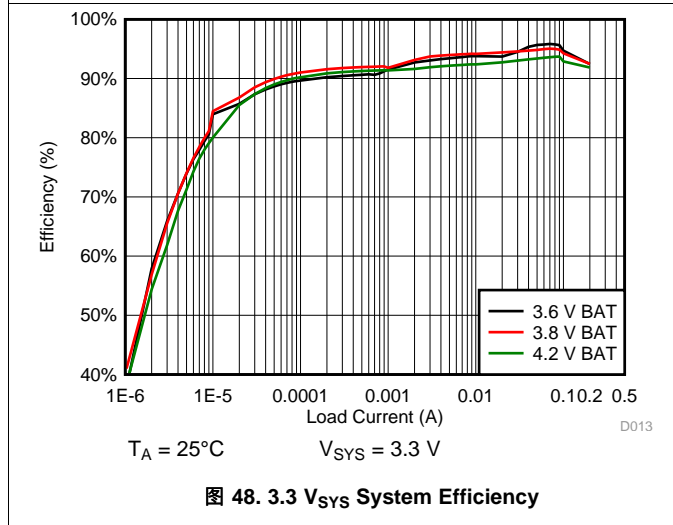
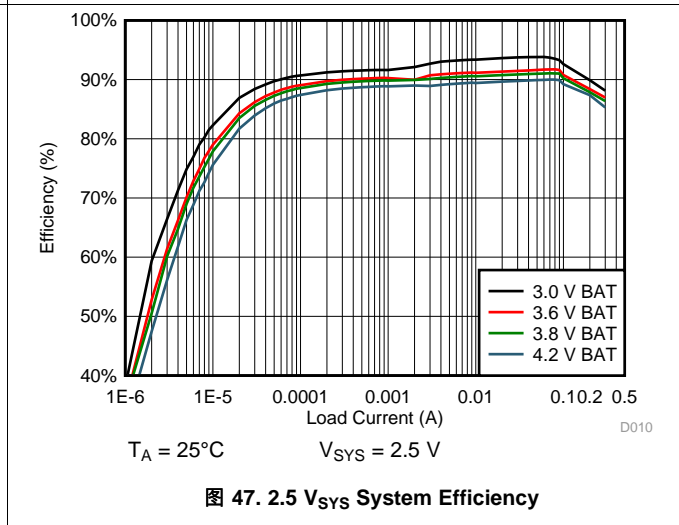
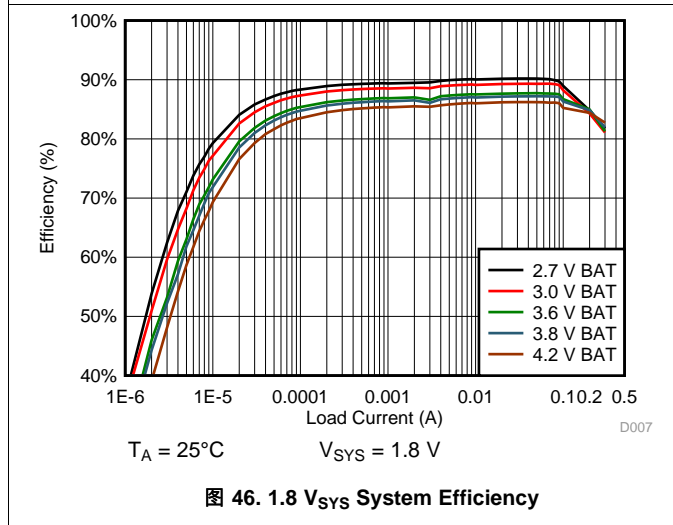
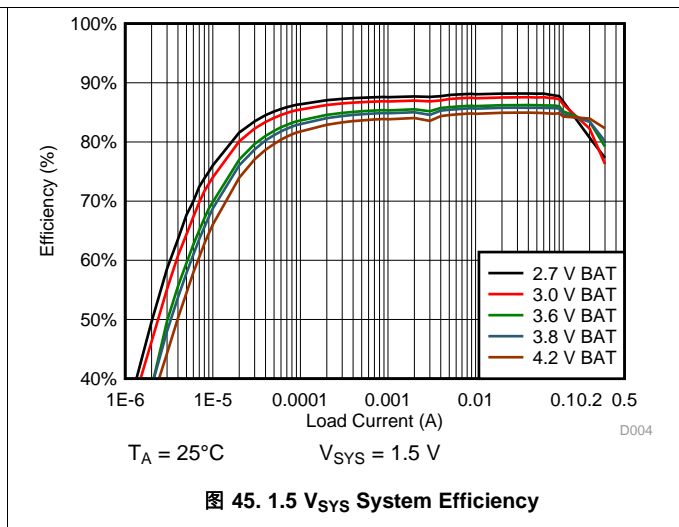
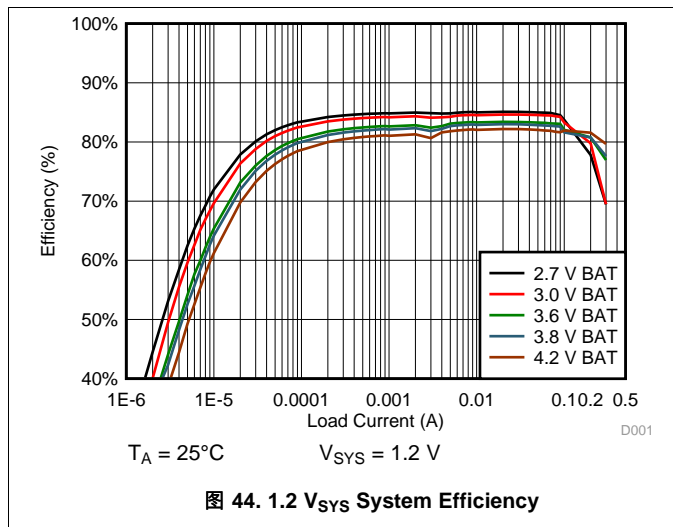

Typical Application (接下页)



图 50. 1.5 V<sub>sys</sub> Load Regulation



图 51. 1.8 V<sub>sys</sub> Load Regulation

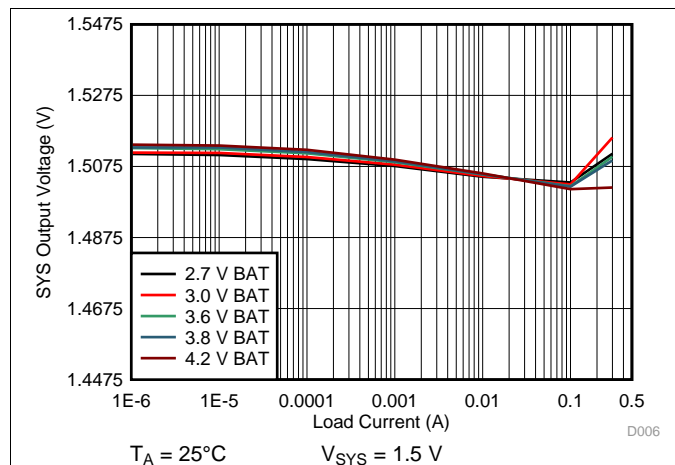

图 52. 2.5 V<sub>sys</sub> Load Regulation

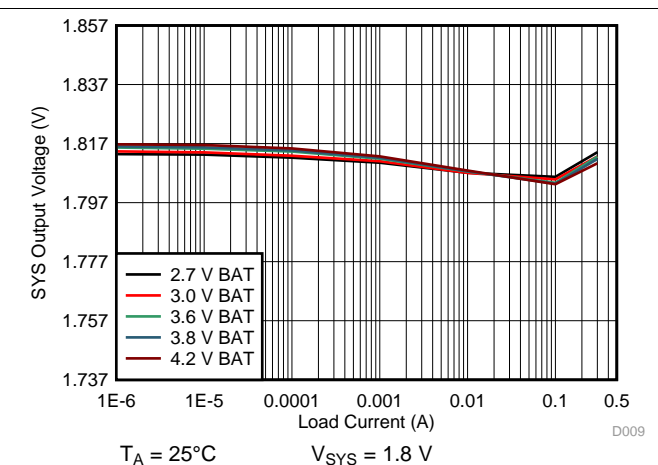

图 53. 3.3 V<sub>sys</sub> Load Regulation

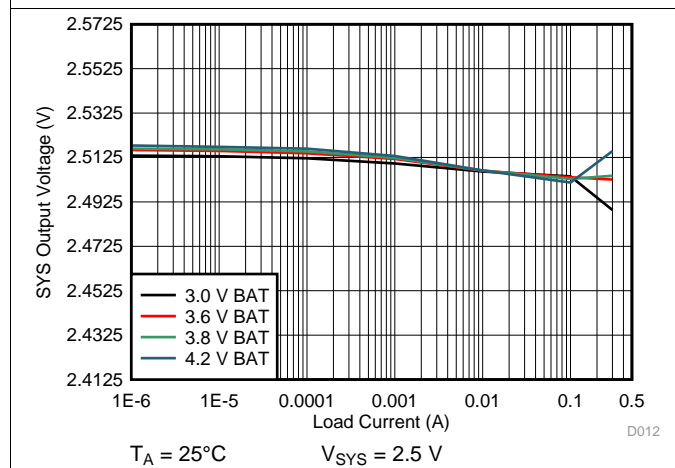

图 54. 1.2 V<sub>sys</sub> Line Regulation

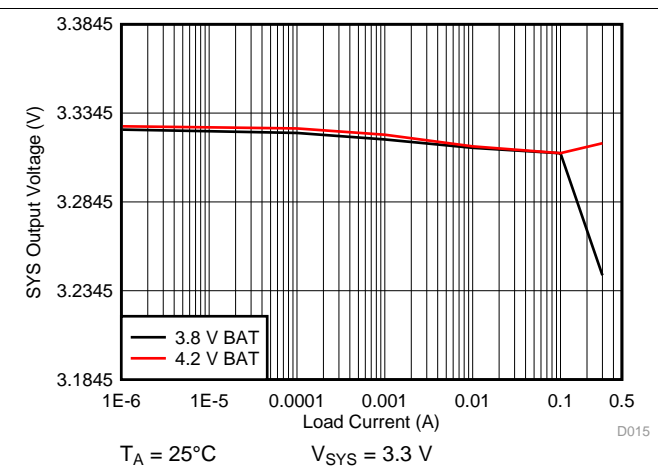

图 55. 1.5 V<sub>sys</sub> Line Regulation

Typical Application (接下页)

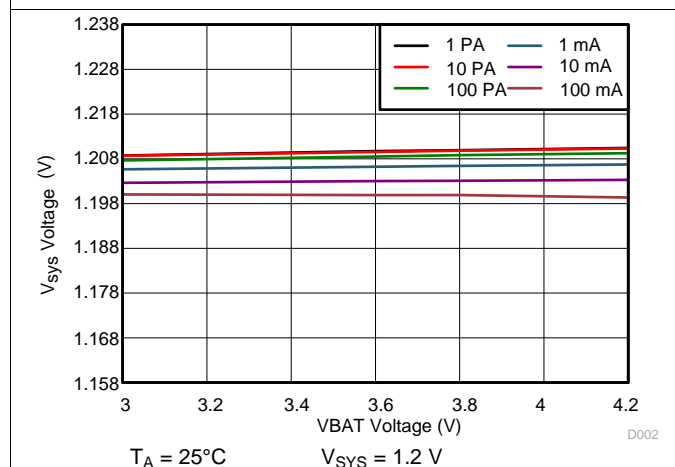

图 56. 1.8 V<sub>sys</sub> Line Regulation

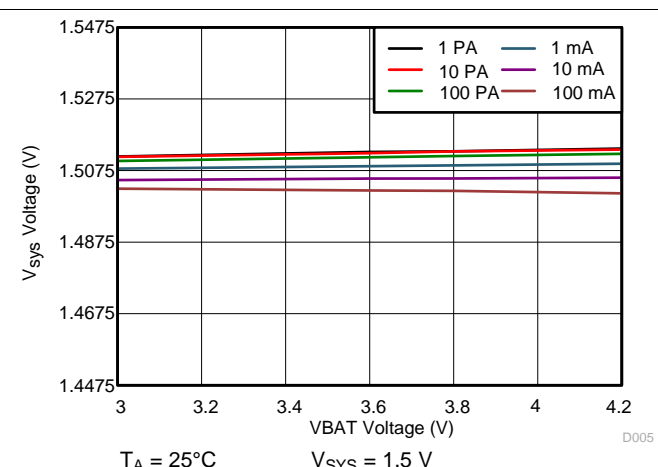

图 57. 2.1 V<sub>sys</sub> Line Regulation

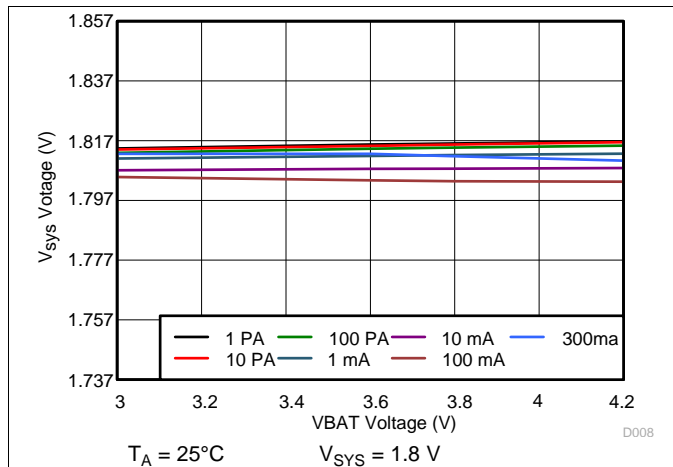

图 58. 3.3 V<sub>sys</sub> Line Regulation

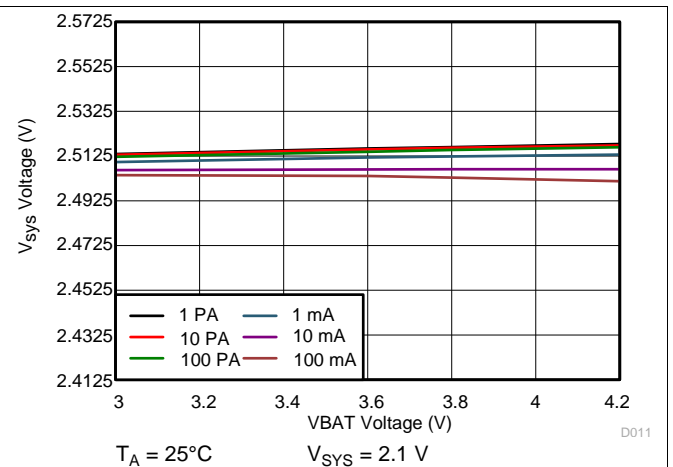

图 59. 1.8 V<sub>sys</sub> Switching Frequency vs Load Current

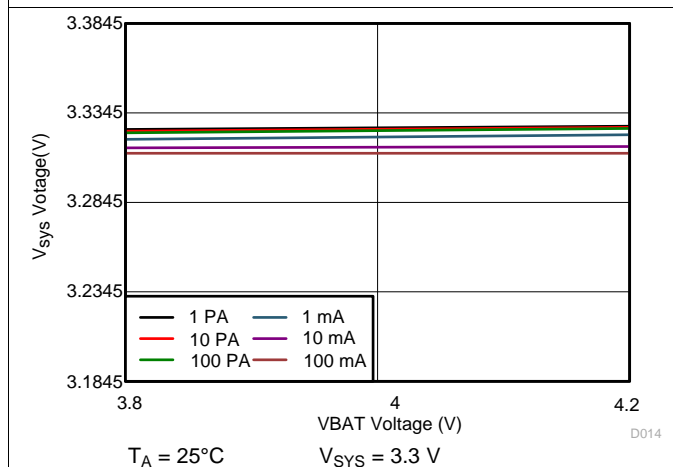

图 60. Light Load Operation Showing SW

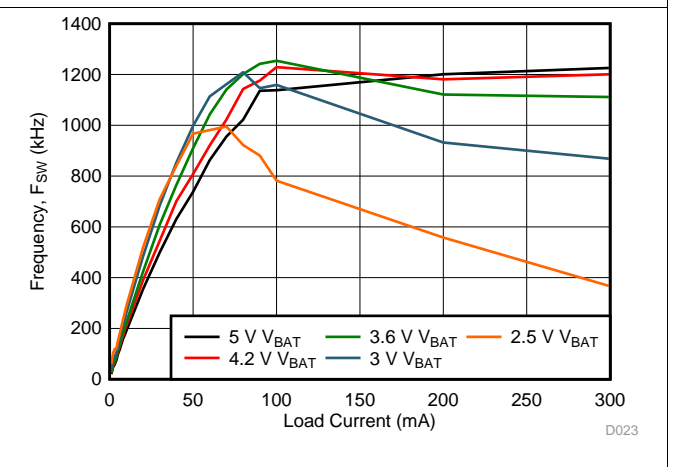

图 61. Light Load Operation Showing SW

Typical Application (接下页)

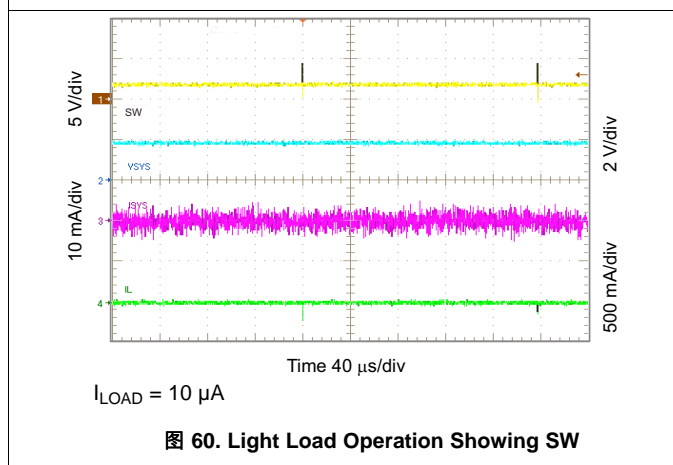

$I_{LOAD} = 1 \text{ mA}$

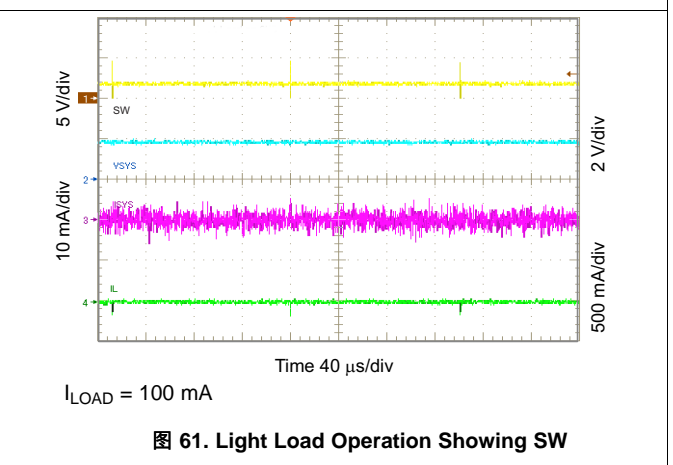
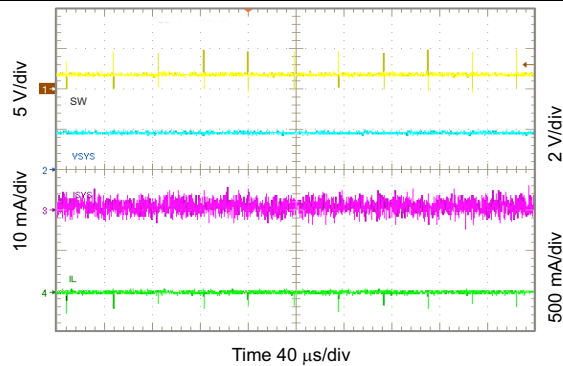
图 62. Light Load Operation Showing SW

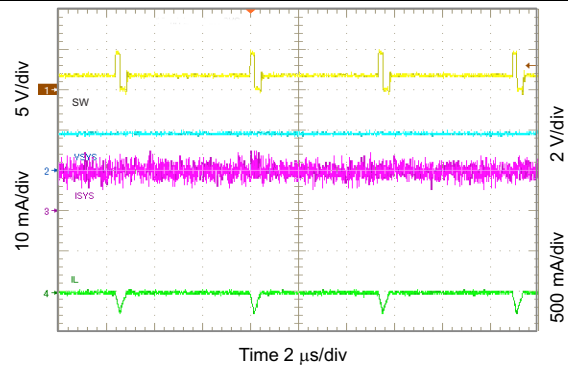

$I_{LOAD} = 10 \text{ mA}$

图 63. Light Load Operation Showing SW

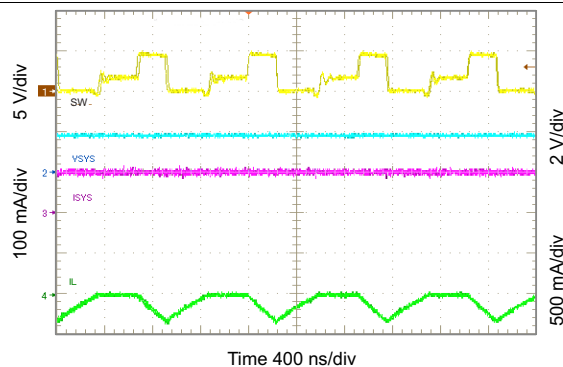

$I_{LOAD} = 100 \text{ mA}$

图 64. Light Load Operation Showing SW

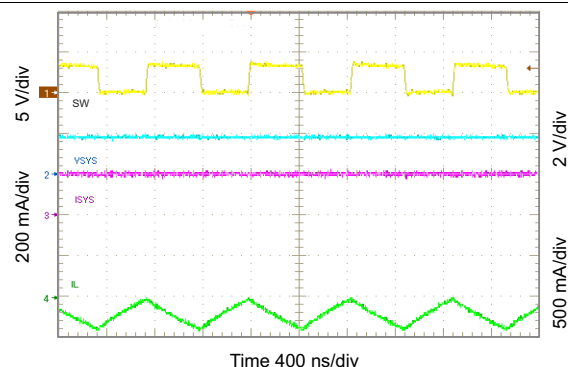

$I_{LOAD} = 200 \text{ mA}$

图 65. Light Load Operation Showing SW

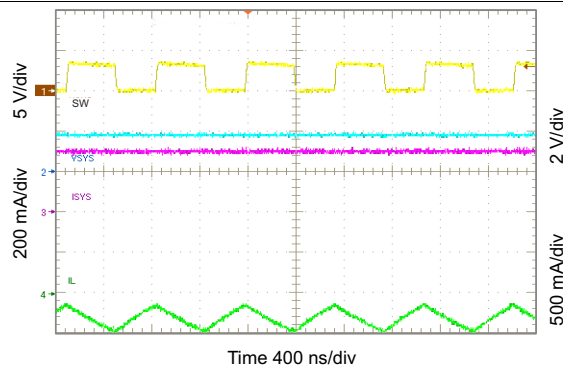

$I_{LOAD} = 300 \text{ mA}$

图 66. Light Load Operation Showing SW

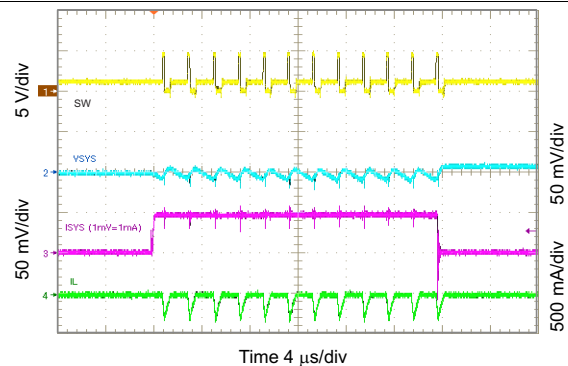

$V_{SYS} = 1.2 \text{ V}$

图 67. 1.2 V<sub>SYS</sub> Load Transient, 0 to 50 mA

Typical Application (接下页)

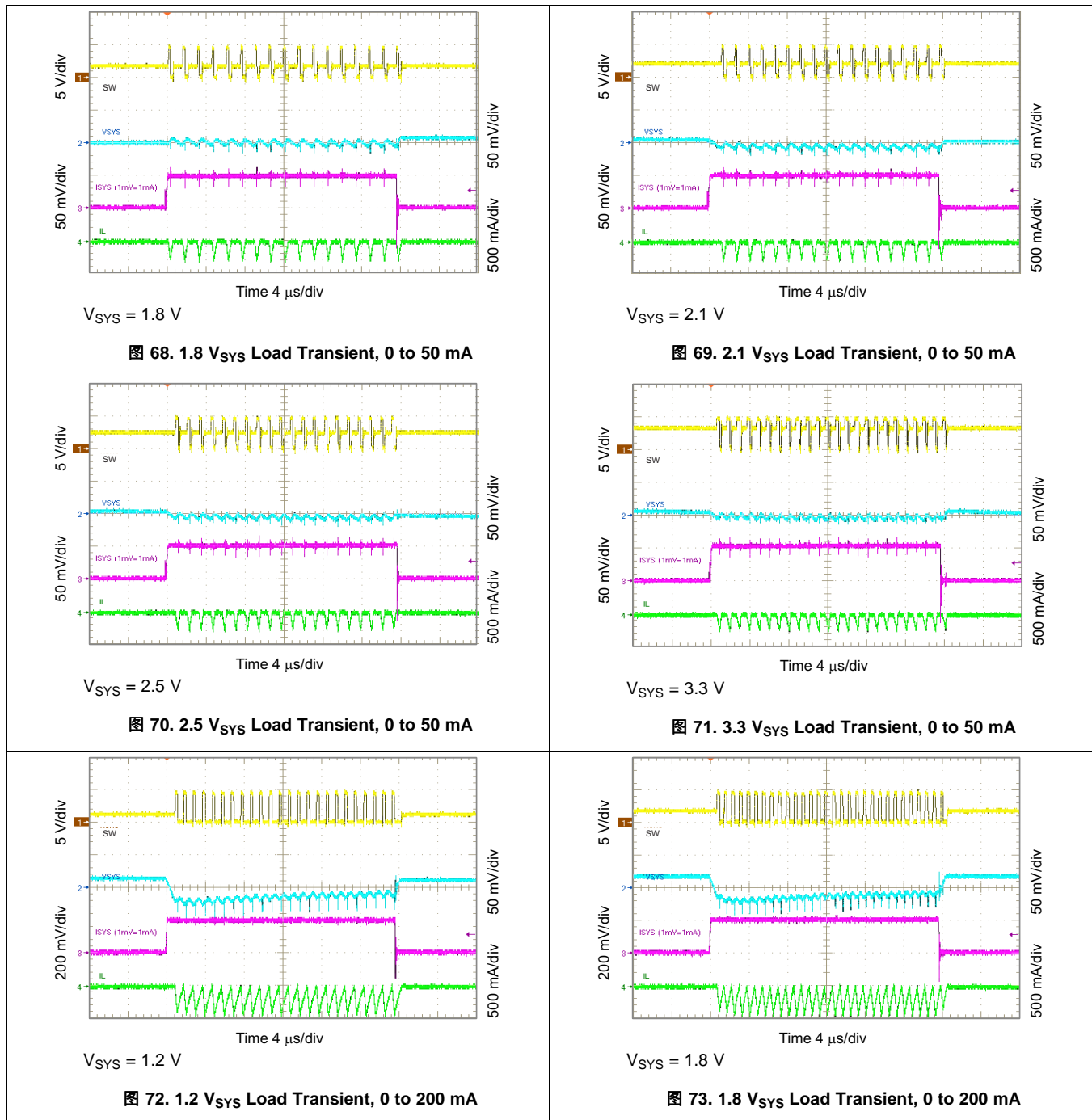



Typical Application (接下页)

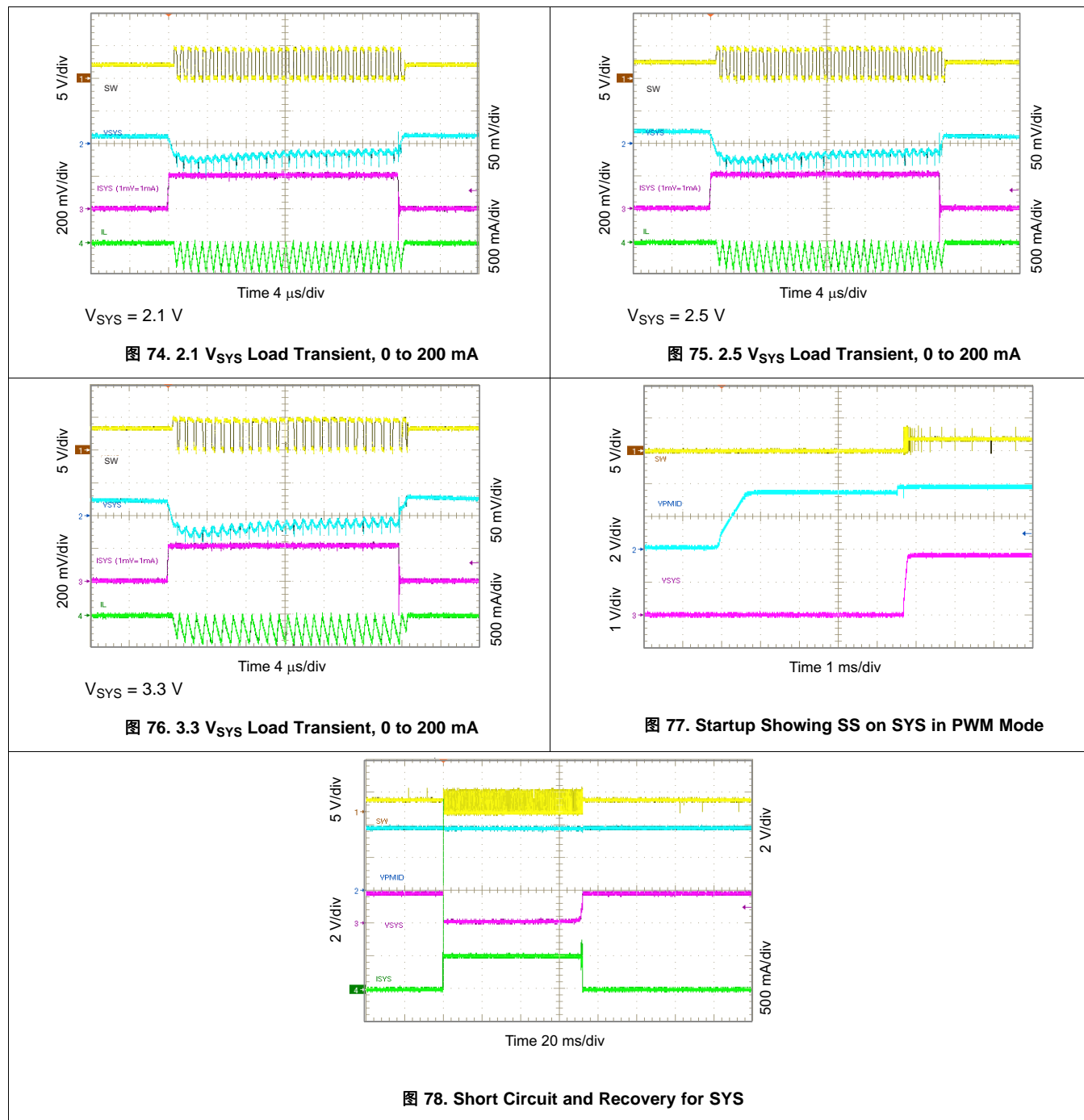

Typical Application (接下页)

10.2.3.3 Load Switch and LDO Curves



图 79. Short Circuit and Recovery for LS



图 80. Startup Showing SS on LS/LDO Output

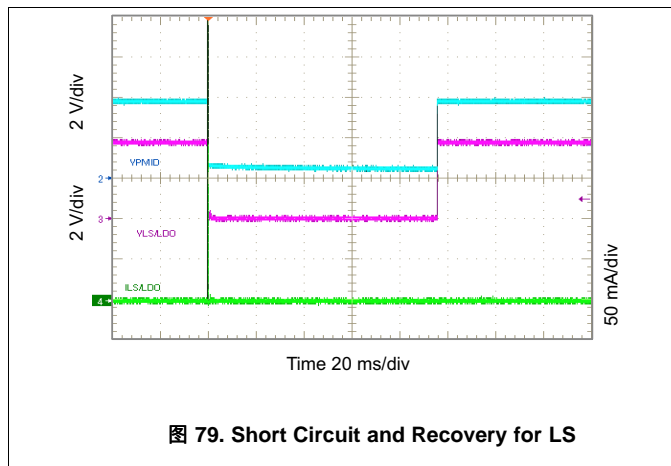

图 81. 0.8  $V_{LSLDO}$  Load Transient, 0 to 10 mA

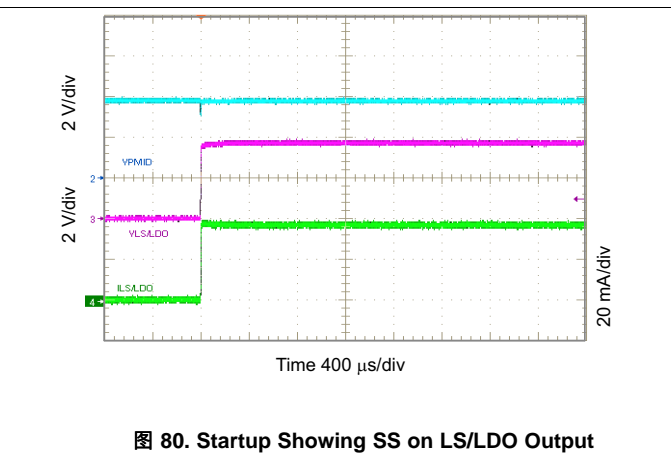

图 82. 1.2  $V_{LSLDO}$  Load Transient, 0 to 10 mA

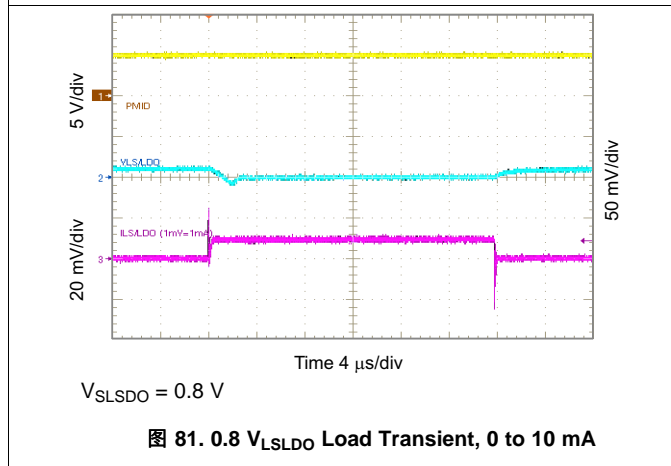

图 83. 1.8  $V_{LSLDO}$  Load Transient, 0 to 10 mA

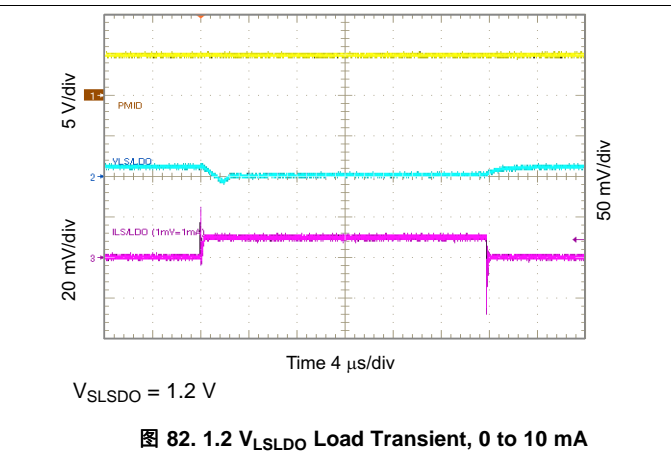

图 84. 2.5  $V_{LSLDO}$  Load Transient, 0 to 10 mA

Typical Application (接下页)

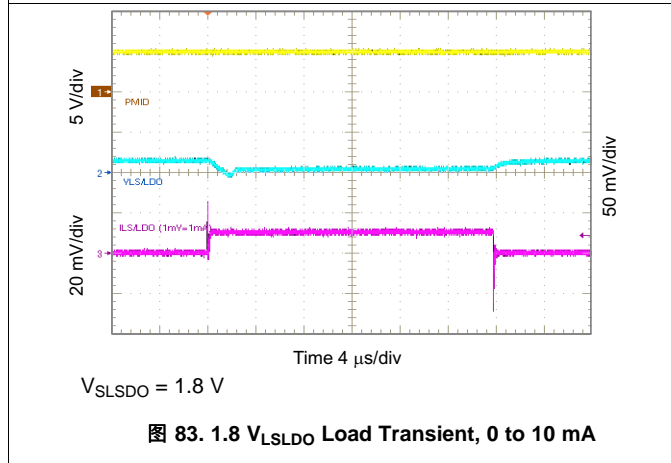

$V_{SLSDO} = 3.3\text{ V}$

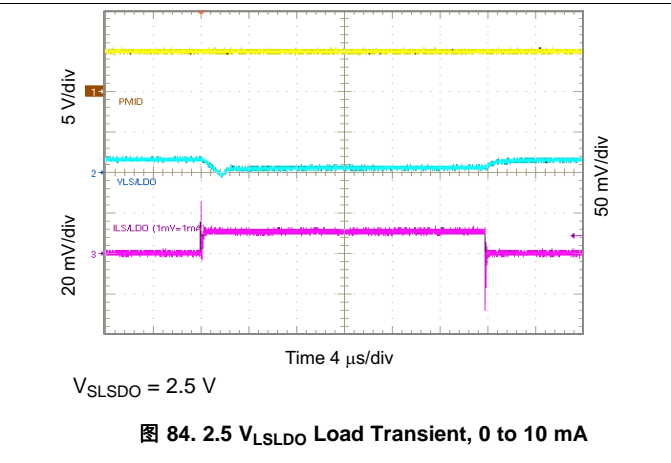
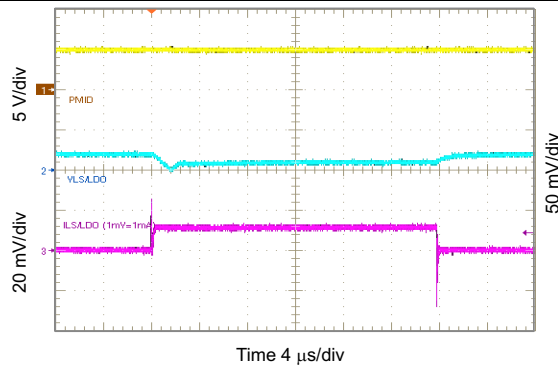
图 85. 3.3  $V_{LSLDO}$  Load Transient, 0 to 10 mA

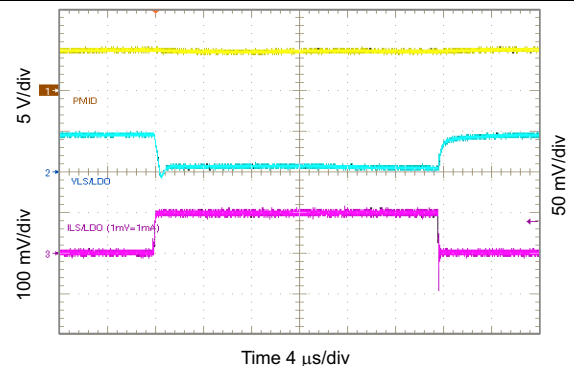

$V_{SLSDO} = 0.8\text{ V}$

图 86. 0.8  $V_{LSLDO}$  Load Transient, 0 to 100 mA

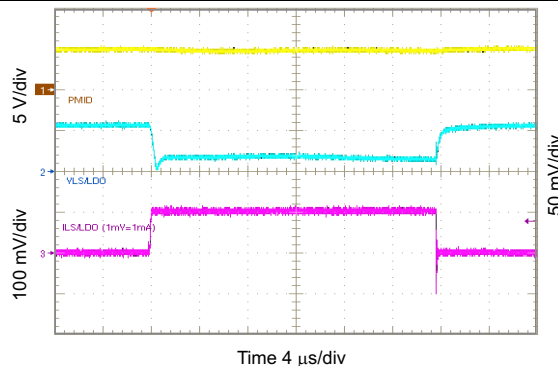

$V_{SLSDO} = 1.2\text{ V}$

图 87. 1.2  $V_{LSLDO}$  Load Transient, 0 to 100 mA

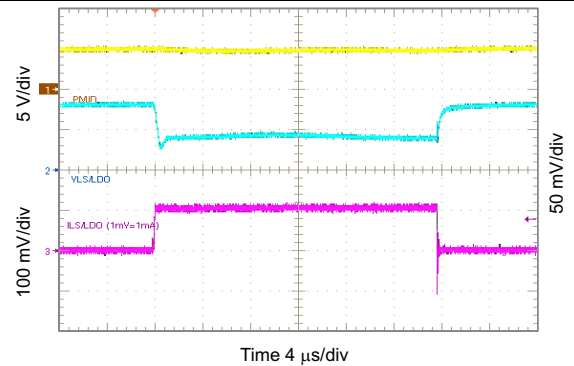

$V_{SLSDO} = 1.8\text{ V}$

图 88. 1.8  $V_{LSLDO}$  Load Transient, 0 to 100 mA

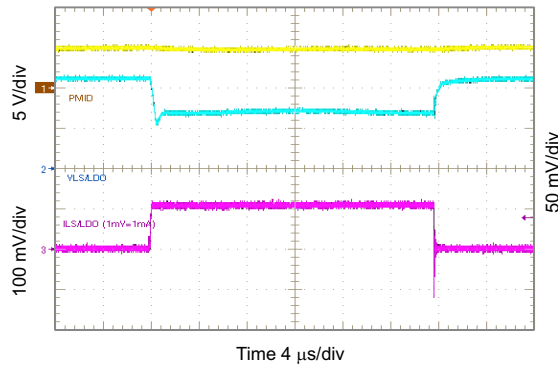

$V_{SLSDO} = 2.5\text{ V}$

图 89. 2.5  $V_{LSLDO}$  Load Transient, 0 to 100 mA

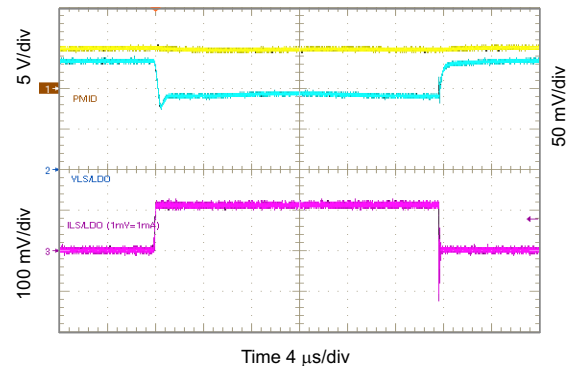

$V_{SLSDO} = 3.3\text{ V}$

图 90. 3.3  $V_{LSLDO}$  Load Transient, 0 to 100 mA

**Typical Application (接下页)**

**10.2.3.4 LS/LDO Output Curves**

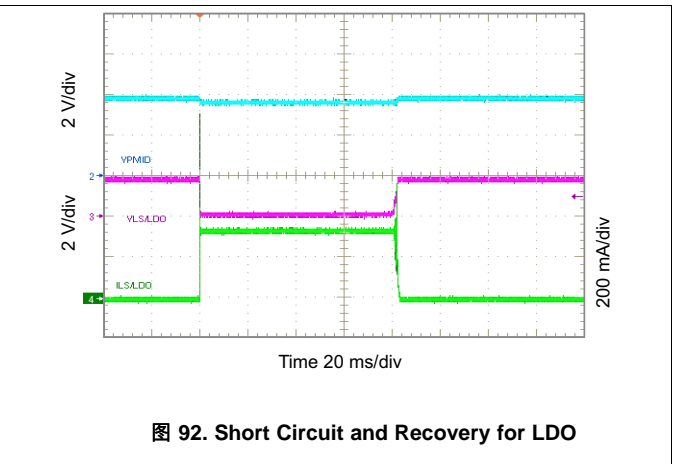
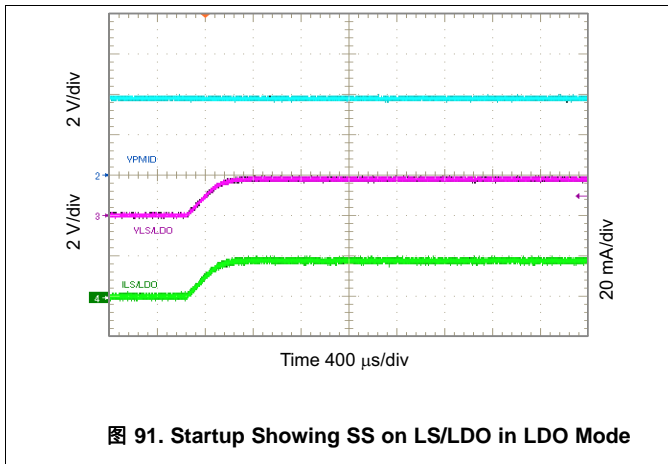

Typical Application (接下页)

10.2.3.5 Timing Waveforms Curves



图 93. Show  $\overline{PG}$  and  $\overline{INT}$  Timing ( $V_{IN}$  Insertion)



图 94. Show  $\overline{PG}$  and  $\overline{INT}$  Timing ( $V_{IN}$  Removal)

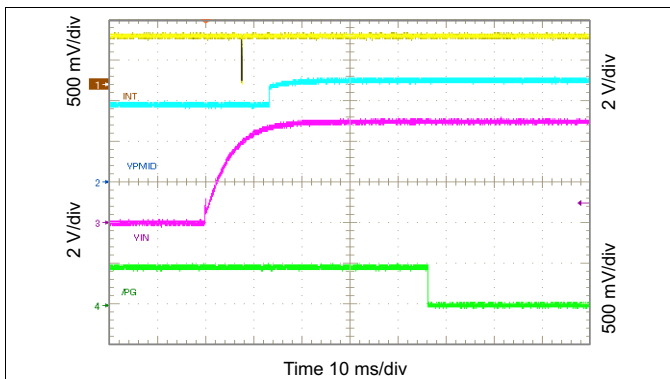

图 95.  $\overline{PG}$  Functions as Shifted  $\overline{MR}$  Output

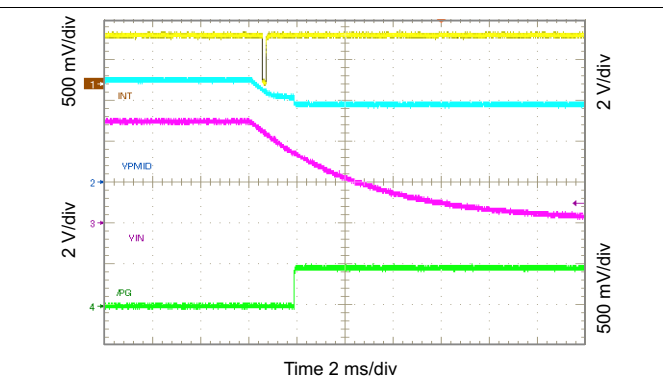

图 96.  $\overline{PG}$  Functions as Shifted  $\overline{MR}$  Output

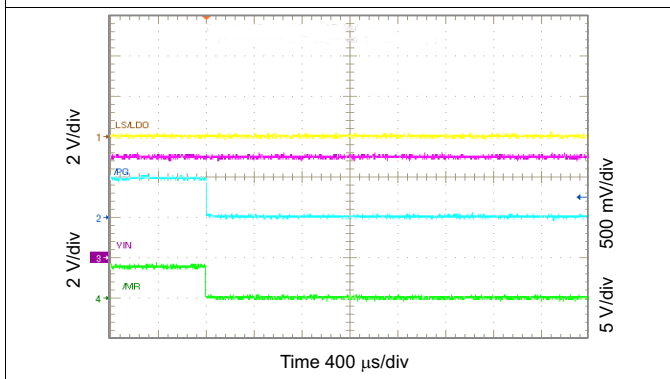

图 97. Show  $\overline{MR}$  Timing

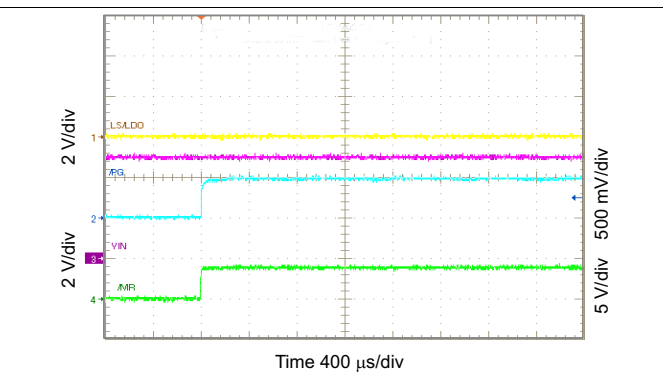

图 98. Show  $\overline{MR}$  Timing

Typical Application (接下页)

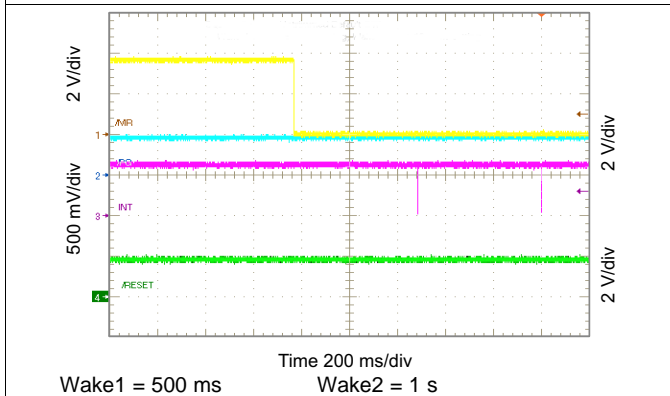

## 11 Power Supply Recommendations

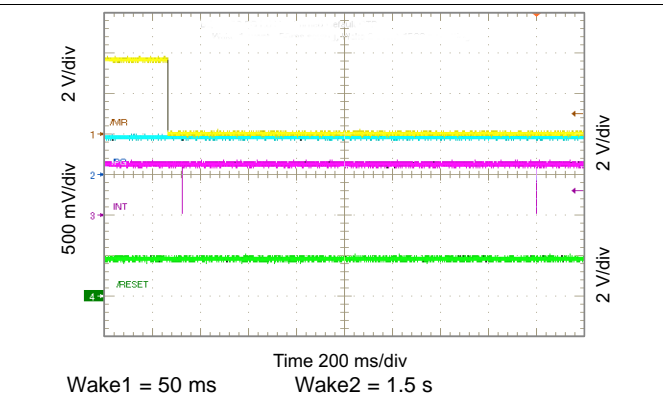
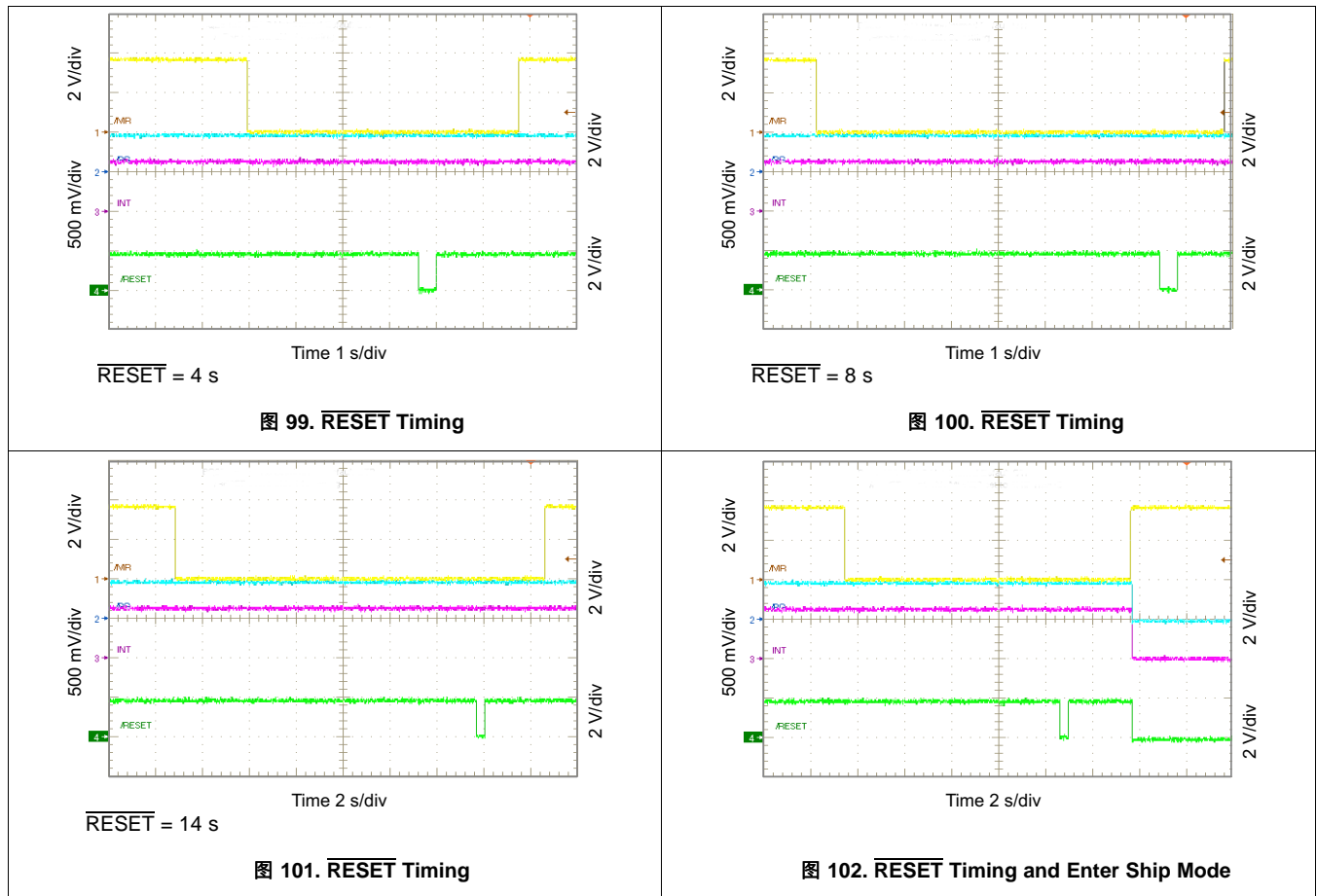
It is recommended to use a power supply that is capable of delivering 5 V at the input current limit set by the BQ25120.

## 12 Layout

### 12.1 Layout Guidelines

- Keep the core components of the system close to each other and the device.
- Keep the PMID, IN, and SYS caps as close to their respective pins as possible. Place the bypass caps for PMID, SYS, and LSLDO close to the pins.
- Place the GNDs of the PMID and IN caps close to each other.
- Don't route so the power planes are interrupted.

### 12.2 Layout Example



图 103. bq25120 Layout

## 13 器件和文档支持

### 13.1 器件支持

#### 13.1.1 第三方产品免责声明

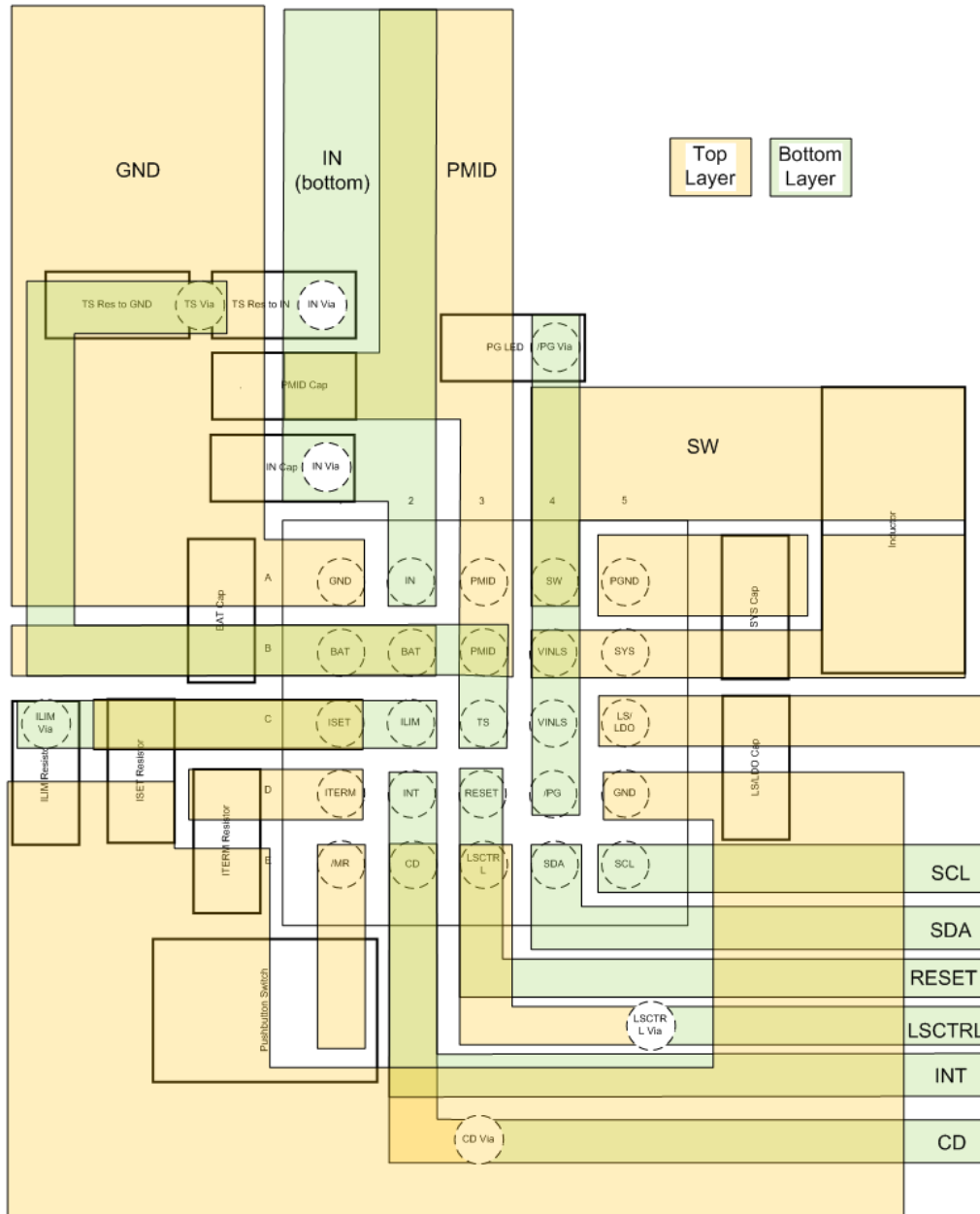
TI 发布的与第三方产品或服务有关的信息，不能构成与此类产品或服务或保修的适用性有关的认可，不能构成此类产品或服务单独或与任何 TI 产品或服务一起的表示或认可。

### 13.2 相关链接

下面的表格列出了快速访问链接。类别包括技术文档、支持与社区资源、工具和软件，以及申请样片或购买产品的快速链接。

表 25. 相关链接

| 器件      | 产品文件夹                 | 样片与购买                 | 技术文档                  | 工具和软件                 | 支持和社区                 |
|---------|-----------------------|-----------------------|-----------------------|-----------------------|-----------------------|
| BQ25120 | <a href="#">请单击此处</a> | <a href="#">请单击此处</a> | <a href="#">请单击此处</a> | <a href="#">请单击此处</a> | <a href="#">请单击此处</a> |
| BQ25121 | <a href="#">请单击此处</a> | <a href="#">请单击此处</a> | <a href="#">请单击此处</a> | <a href="#">请单击此处</a> | <a href="#">请单击此处</a> |

### 13.3 接收文档更新通知

要接收文档更新通知，请导航至 TI.com 上的器件产品文件夹。单击右上角的通知我进行注册，即可每周接收产品信息更改摘要。

### 13.4 社区资源

下列链接提供到 TI 社区资源的连接。链接的内容由各个分销商“按照原样”提供。这些内容并不构成 TI 技术规范，并且不一定反映 TI 的观点；请参阅 TI 的《使用条款》。

**TI E2E™ 在线社区** *TI 的工程师对工程师 (E2E) 社区*。此社区的创建目的在于促进工程师之间的协作。在 e2e.ti.com 中，您可以咨询问题、分享知识、拓展思路并与同行工程师一道帮助解决问题。

**设计支持** *TI 参考设计支持* 可帮助您快速查找有帮助的 E2E 论坛、设计支持工具以及技术支持的联系信息。

### 13.5 商标

E2E is a trademark of Texas Instruments.  
All other trademarks are the property of their respective owners.

### 13.6 静电放电警告



这些装置包含有限的内置 ESD 保护。存储或装卸时，应将导线一起截短或将装置放置于导电泡棉中，以防止 MOS 门极遭受静电损伤。

### 13.7 Glossary

**SLYZ022** — *TI Glossary*.

This glossary lists and explains terms, acronyms, and definitions.

## 14 机械、封装和可订购信息

以下页面包含机械、封装和可订购信息。这些信息是指定器件的最新可用数据。数据如有变更，恕不另行通知和修订此文档。如欲获取此数据表的浏览器版本，请参阅左侧的导航。



**PACKAGING INFORMATION**

| Orderable part number       | Status<br>(1) | Material type<br>(2) | Package   Pins   | Package qty   Carrier | RoHS<br>(3) | Lead finish/<br>Ball material<br>(4) | MSL rating/<br>Peak reflow<br>(5) | Op temp (°C) | Part marking<br>(6) |
|-----------------------------|---------------|----------------------|------------------|-----------------------|-------------|--------------------------------------|-----------------------------------|--------------|---------------------|
| BQ25120YFPR                 | NRND          | Production           | DSBGA (YFP)   25 | 3000   LARGE T&R      | Yes         | SNAGCU                               | Level-1-260C-UNLIM                | -40 to 85    | BQ25120             |
| BQ25120YFPT                 | NRND          | Production           | DSBGA (YFP)   25 | 250   SMALL T&R       | Yes         | SNAGCU                               | Level-1-260C-UNLIM                | -40 to 85    | BQ25120             |
| <a href="#">BQ25121YFPR</a> | NRND          | Production           | DSBGA (YFP)   25 | 3000   LARGE T&R      | Yes         | SNAGCU                               | Level-1-260C-UNLIM                | -40 to 85    | BQ25121             |
| BQ25121YFPT                 | NRND          | Production           | DSBGA (YFP)   25 | 250   SMALL T&R       | Yes         | SNAGCU                               | Level-1-260C-UNLIM                | -40 to 85    | BQ25121             |

<sup>(1)</sup> **Status:** For more details on status, see our [product life cycle](#).

<sup>(2)</sup> **Material type:** When designated, preproduction parts are prototypes/experimental devices, and are not yet approved or released for full production. Testing and final process, including without limitation quality assurance, reliability performance testing, and/or process qualification, may not yet be complete, and this item is subject to further changes or possible discontinuation. If available for ordering, purchases will be subject to an additional waiver at checkout, and are intended for early internal evaluation purposes only. These items are sold without warranties of any kind.

<sup>(3)</sup> **RoHS values:** Yes, No, RoHS Exempt. See the [TI RoHS Statement](#) for additional information and value definition.

<sup>(4)</sup> **Lead finish/Ball material:** Parts may have multiple material finish options. Finish options are separated by a vertical ruled line. Lead finish/Ball material values may wrap to two lines if the finish value exceeds the maximum column width.

<sup>(5)</sup> **MSL rating/Peak reflow:** The moisture sensitivity level ratings and peak solder (reflow) temperatures. In the event that a part has multiple moisture sensitivity ratings, only the lowest level per JEDEC standards is shown. Refer to the shipping label for the actual reflow temperature that will be used to mount the part to the printed circuit board.

<sup>(6)</sup> **Part marking:** There may be an additional marking, which relates to the logo, the lot trace code information, or the environmental category of the part.

Multiple part markings will be inside parentheses. Only one part marking contained in parentheses and separated by a "~" will appear on a part. If a line is indented then it is a continuation of the previous line and the two combined represent the entire part marking for that device.

**Important Information and Disclaimer:** The information provided on this page represents TI's knowledge and belief as of the date that it is provided. TI bases its knowledge and belief on information provided by third parties, and makes no representation or warranty as to the accuracy of such information. Efforts are underway to better integrate information from third parties. TI has taken and continues to take reasonable steps to provide representative and accurate information but may not have conducted destructive testing or chemical analysis on incoming materials and chemicals. TI and TI suppliers consider certain information to be proprietary, and thus CAS numbers and other limited information may not be available for release.

In no event shall TI's liability arising out of such information exceed the total purchase price of the TI part(s) at issue in this document sold by TI to Customer on an annual basis.

**TAPE AND REEL INFORMATION**

**QUADRANT ASSIGNMENTS FOR PIN 1 ORIENTATION IN TAPE**

\*All dimensions are nominal

| Device      | Package Type | Package Drawing | Pins | SPQ  | Reel Diameter (mm) | Reel Width W1 (mm) | A0 (mm) | B0 (mm) | K0 (mm) | P1 (mm) | W (mm) | Pin1 Quadrant |
|-------------|--------------|-----------------|------|------|--------------------|--------------------|---------|---------|---------|---------|--------|---------------|
| BQ25120YFPR | DSBGA        | YFP             | 25   | 3000 | 180.0              | 8.4                | 2.65    | 2.65    | 0.69    | 4.0     | 8.0    | Q1            |
| BQ25120YFPT | DSBGA        | YFP             | 25   | 250  | 180.0              | 8.4                | 2.65    | 2.65    | 0.69    | 4.0     | 8.0    | Q1            |
| BQ25121YFPR | DSBGA        | YFP             | 25   | 3000 | 180.0              | 8.4                | 2.65    | 2.65    | 0.69    | 4.0     | 8.0    | Q1            |
| BQ25121YFPT | DSBGA        | YFP             | 25   | 250  | 180.0              | 8.4                | 2.65    | 2.65    | 0.69    | 4.0     | 8.0    | Q1            |

## TAPE AND REEL BOX DIMENSIONS



\*All dimensions are nominal

| Device      | Package Type | Package Drawing | Pins | SPQ  | Length (mm) | Width (mm) | Height (mm) |
|-------------|--------------|-----------------|------|------|-------------|------------|-------------|
| BQ25120YFPR | DSBGA        | YFP             | 25   | 3000 | 182.0       | 182.0      | 20.0        |
| BQ25120YFPT | DSBGA        | YFP             | 25   | 250  | 182.0       | 182.0      | 20.0        |
| BQ25121YFPR | DSBGA        | YFP             | 25   | 3000 | 182.0       | 182.0      | 20.0        |
| BQ25121YFPT | DSBGA        | YFP             | 25   | 250  | 182.0       | 182.0      | 20.0        |

YFP0025

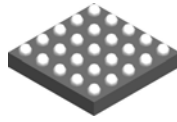

PACKAGE OUTLINE

DSBGA - 0.5 mm max height

DIE SIZE BALL GRID ARRAY

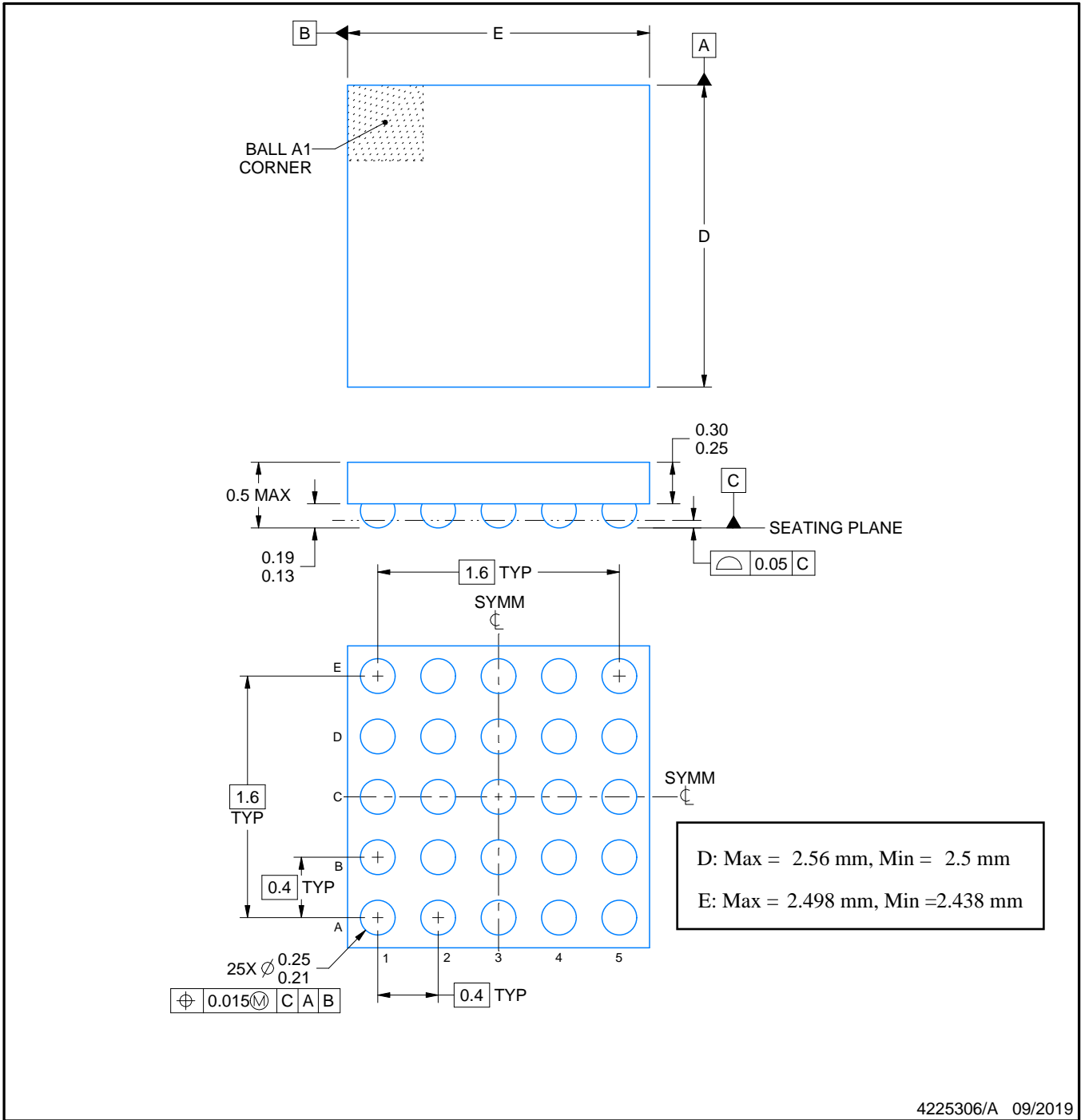

NOTES:

- 1. All linear dimensions are in millimeters. Any dimensions in parenthesis are for reference only. Dimensioning and tolerancing per ASME Y14.5M.
- 2. This drawing is subject to change without notice.

# EXAMPLE BOARD LAYOUT

YFP0025

DSBGA - 0.5 mm max height

DIE SIZE BALL GRID ARRAY

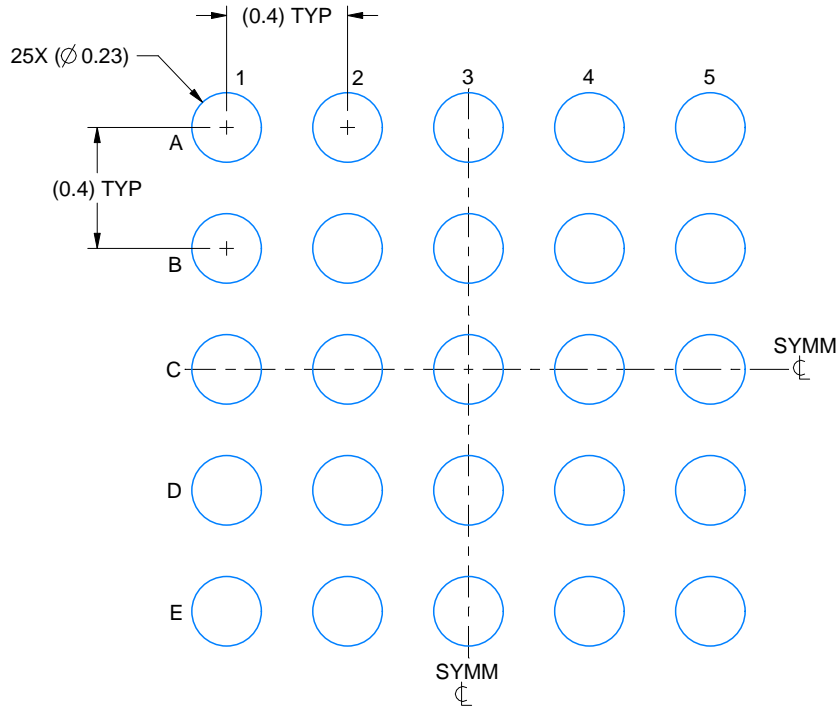

LAND PATTERN EXAMPLE  
EXPOSED METAL SHOWN  
SCALE: 40X

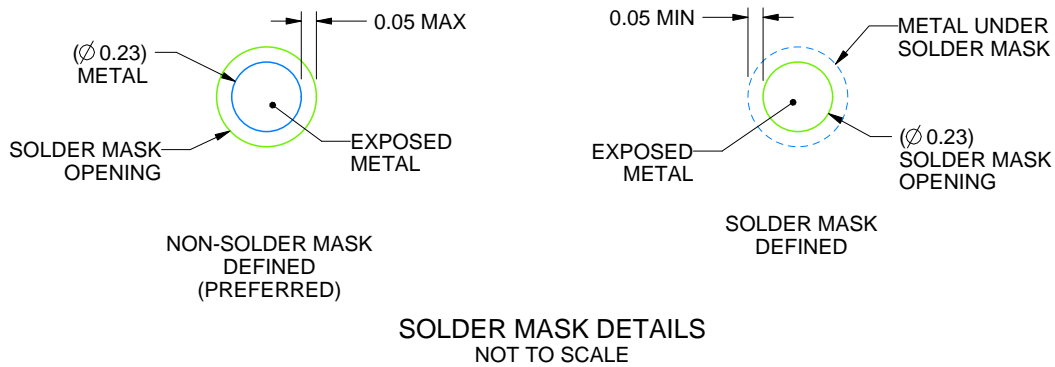

SOLDER MASK DETAILS  
NOT TO SCALE

4225306/A 09/2019

NOTES: (continued)

- Final dimensions may vary due to manufacturing tolerance considerations and also routing constraints. See Texas Instruments Literature No. SNVA009 ([www.ti.com/lit/snva009](http://www.ti.com/lit/snva009)).

# EXAMPLE STENCIL DESIGN

YFP0025

DSBGA - 0.5 mm max height

DIE SIZE BALL GRID ARRAY

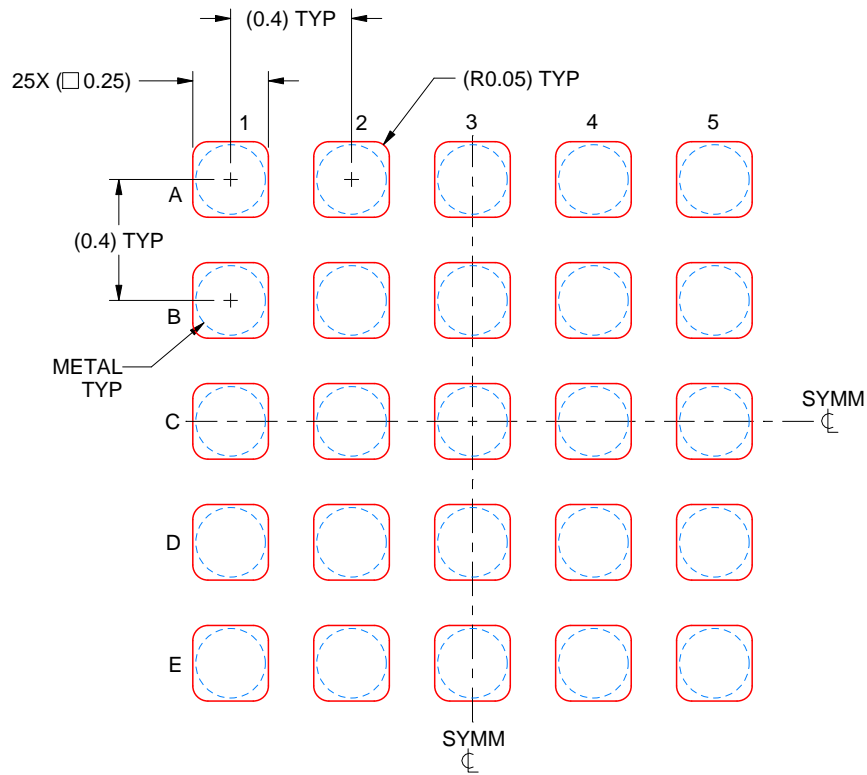

SOLDER PASTE EXAMPLE  
BASED ON 0.1 mm THICK STENCIL  
SCALE: 40X

4225306/A 09/2019

NOTES: (continued)

4. Laser cutting apertures with trapezoidal walls and rounded corners may offer better paste release.

## 重要通知和免责声明

TI“按原样”提供技术和可靠性数据（包括数据表）、设计资源（包括参考设计）、应用或其他设计建议、网络工具、安全信息和其他资源，不保证没有瑕疵且不做任何明示或暗示的担保，包括但不限于对适销性、某特定用途方面的适用性或不侵犯任何第三方知识产权的暗示担保。

这些资源可供使用 TI 产品进行设计的熟练开发人员使用。您将自行承担以下全部责任：(1) 针对您的应用选择合适的 TI 产品，(2) 设计、验证并测试您的应用，(3) 确保您的应用满足相应标准以及任何其他功能安全、信息安全、监管或其他要求。

这些资源如有变更，恕不另行通知。TI 授权您仅可将这些资源用于研发本资源所述的 TI 产品的相关应用。严禁以其他方式对这些资源进行复制或展示。您无权使用任何其他 TI 知识产权或任何第三方知识产权。您应全额赔偿因在这些资源的使用中对 TI 及其代表造成的任何索赔、损害、成本、损失和债务，TI 对此概不负责。

TI 提供的产品受 [TI 的销售条款](#) 或 [ti.com](#) 上其他适用条款/TI 产品随附的其他适用条款的约束。TI 提供这些资源并不会扩展或以其他方式更改 TI 针对 TI 产品发布的适用的担保或担保免责声明。

TI 反对并拒绝您可能提出的任何其他或不同的条款。

邮寄地址：Texas Instruments, Post Office Box 655303, Dallas, Texas 75265  
版权所有 © 2025，德州仪器 (TI) 公司