

AMC1306M25E 具有 -55°C 工作温度范围的高精度、增强型隔离式 Δ - Σ 调制器

1 特性

- 线性输入电压范围： $\pm 250\text{mV}$
- 低直流误差：
 - 失调电压误差： $\pm 100\ \mu\text{V}$ (最大值)
 - 温漂 $1\ \mu\text{V}/^\circ\text{C}$ (最大值)
 - 增益误差： $\pm 0.2\%$ (最大值)
 - 增益漂移： $\pm 40\text{ppm}/^\circ\text{C}$ (最大值)
- 高 CMTI： $100\text{kV}/\mu\text{s}$ (最小值)
- 低 EMI：符合 CISPR-11 和 CISPR-25 标准
- 安全相关认证：
 - 符合 DIN EN IEC 60747-17 (VDE 0884-17): 2021-10 标准的 $7070\text{V}_{\text{PEAK}}$ 增强型隔离。
 - 符合 UL1577 标准且长达 1 分钟的 $5000\text{V}_{\text{RMS}}$ 隔离
- 针对更大工业温度范围进行了全面优化： -40°C 至 $+125^\circ\text{C}$
- 支持在低至 -55°C 下运行

2 应用

- 基于分流电阻器的电流感应和隔离式电压测量，包括：
 - [牵引逆变器](#)
 - [车载充电器](#)
 - [直流/直流转换器](#)
 - [混合动力汽车/电动汽车直流充电器](#)

3 说明

AMC1306M25E 是一款精密 Δ - Σ 调制器，此调制器的输出与输入电路由抗电磁干扰性能极强的隔离层隔开。该隔离栅经认证可提供高达 $7070\text{V}_{\text{PEAK}}$ 的增强型隔离，符合 DIN EN IEC 60747-17 (VDE 0884-17) 和 UL1577 标准，并且可支持高达 $1.5\text{kV}_{\text{RMS}}$ 的工作电压。该隔离层可将系统中以不同共模电压电平运行的各器件隔开，防止高电压冲击导致低压侧器件电气损坏或对操作员造成伤害。

AMC1306M25E 的输入端经过了优化，可直接连接到分流电阻器或其他低电压电平信号源。具有出色的直流精度和低温漂，可支持精确的电流控制，适用于车载充电器 (OBC)、直流/直流转换器、牵引逆变器或其他高压应用。通过使用集成式数字滤波器 (如 [TMS320F2807x](#) 或 [TMS320F2837x](#) 微控制器系列中的滤波器) 来抽取位流，该器件可在 78kSPS 数据速率下实现 85dB 动态范围的 16 位分辨率。

AMC1306M25E 采用 8 引脚宽体 SOIC 封装，额定的工业级工作温度范围为 -40°C 至 $+125^\circ\text{C}$ ，并支持在低至 -55°C 下运行。

封装信息

器件型号	封装 ⁽¹⁾	封装尺寸 (标称值)
AMC1306M25E	DWV (SOIC, 8)	5.85mm × 7.50mm

(1) 有关所有的可用封装，请参阅数据表末尾的可订购产品附录。

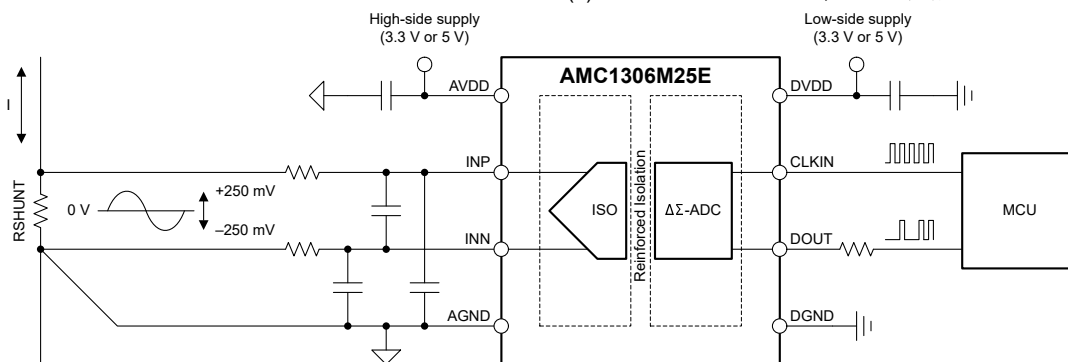

典型应用



Table of Contents

1 特性	1	7.1 Overview.....	18
2 应用	1	7.2 Functional Block Diagram.....	18
3 说明	1	7.3 Feature Description.....	19
4 Revision History	2	7.4 Device Functional Modes.....	22
5 Pin Configuration and Functions	3	8 Application and Implementation	23
6 Specifications	4	8.1 Application Information.....	23
6.1 Absolute Maximum Ratings.....	4	8.2 Typical Application.....	23
6.2 ESD Ratings.....	4	8.3 Best Design Practices.....	26
6.3 Recommended Operating Conditions.....	4	8.4 Power Supply Recommendations.....	26
6.4 Thermal Information.....	5	8.5 Layout.....	27
6.5 Power Ratings.....	5	9 Device and Documentation Support	28
6.6 Insulation Specifications.....	6	9.1 Documentation Support.....	28
6.7 Safety-Related Certifications.....	7	9.2 接收文档更新通知.....	28
6.8 Safety Limiting Values.....	7	9.3 支持资源.....	28
6.9 Electrical Characteristics.....	8	9.4 Trademarks.....	28
6.10 Switching Characteristics.....	10	9.5 静电放电警告.....	28
6.11 Timing Diagrams.....	10	9.6 术语表.....	28
6.12 Insulation Characteristics Curves.....	11	10 Mechanical, Packaging, and Orderable Information	28
6.13 Typical Characteristics.....	12		
7 Detailed Description	18		

4 Revision History

注：以前版本的页码可能与当前版本的页码不同

DATE	REVISION	NOTES
March 2023	*	Initial Release

5 Pin Configuration and Functions



图 5-1. DWV Package, 8-Pin SOIC (Top View)

表 5-1. Pin Functions

PIN		TYPE	DESCRIPTION
NO.	NAME		
1	AVDD	High-side power	Analog (high-side) power supply ⁽¹⁾
2	INP	Analog input	Noninverting analog input
3	INN	Analog input	Inverting analog input
4	AGND	High-side ground	Analog (high-side) ground reference
5	DGND	Low-side ground	Digital (low-side) ground reference
6	DOUT	Digital output	Modulator data output
7	CLKIN	Digital input	Modulator clock input with internal pulldown resistor (typical value: 1.5 M Ω)
8	DVDD	Low-side power	Digital (low-side) power supply ⁽¹⁾

(1) See the [Power Supply Recommendations](#) section for power-supply decoupling recommendations.

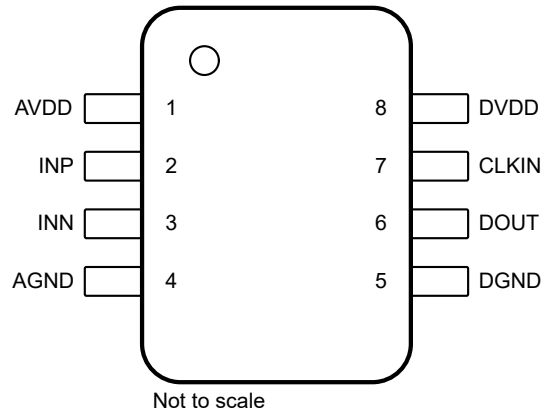
6 Specifications

6.1 Absolute Maximum Ratings

see⁽¹⁾

PARAMETER		MIN	MAX	UNIT
Power-supply voltage	AVDD to AGND	- 0.3	6.5	V
	DVDD to DGND	- 0.3	6.5	
Analog input voltage	INP, INN	AGND - 6	AVDD + 0.5V	V
Digital input voltage	CLKIN	DGND - 0.5	DVDD + 0.5	V
Digital output voltage	DOUT	DGND - 0.5	DVDD + 0.5	V
Input current	Continuous, any pin except power-supply pins	- 10	10	mA
Temperature	Junction, T _J		150	°C
	Storage, T _{stg}	- 65	150	

- (1) Operation outside the *Absolute Maximum Ratings* may cause permanent device damage. *Absolute Maximum Ratings* do not imply functional operation of the device at these or any other conditions beyond those listed under *Recommended Operating Conditions*. If used outside the Recommended Operating Conditions but within the Absolute Maximum Ratings, the device may not be fully functional, and this may affect device reliability, functionality, performance, and shorten the device lifetime.

6.2 ESD Ratings

			VALUE	UNIT
V _(ESD)	Electrostatic discharge	Human-body model (HBM), per ANSI/ESDA/JEDEC JS-001 ⁽¹⁾	±2000	V
		Charged-device model (CDM), per per ANSI/ESDA/JEDEC JS-002 ⁽²⁾	±1000	

- (1) JEDEC document JEP155 states that 500-V HBM allows safe manufacturing with a standard ESD control process.
 (2) JEDEC document JEP157 states that 250-V CDM allows safe manufacturing with a standard ESD control process.

6.3 Recommended Operating Conditions

over operating ambient temperature range (unless otherwise noted)

			MIN	NOM	MAX	UNIT
POWER SUPPLY						
AVDD	Hgh-side power supply	AVDD to AGND	3	5.0	5.5	V
DVDD	Low-side power supply	DVDD to DGND	2.7	3.3	5.5	V
ANALOG INPUT						
V _{Clipping}	Differential input voltage before clipping output	V _{IN} = V _{INP} - V _{INN}		±320		mV
V _{FSR}	Specified linear differential full-scale voltage	V _{IN} = V _{INP} - V _{INN}	- 250		250	mV
V _{CM}	Operating common-mode input voltage	(V _{INP} + V _{INN}) / 2 to AGND	- 0.16	AVDD - 2.1		V
DIGITAL I/O						
V _{IO}	Digital input/output voltage		0		VDD	V
f _{CLKIN}	Input clock frequency, - 55°C ≤ T _A ≤ 125°C	4.5 V ≤ AVDD ≤ 5.5 V	5	20	21	MHz
		3.0 V ≤ AVDD ≤ 5.5 V	5	20	20	
t _{HIGH}	Input clock high time, - 55°C ≤ T _A ≤ 125°C		20	25	120	ns
t _{LOW}	Input clock low time, - 55°C ≤ T _A ≤ 125°C		20	25	120	ns
TEMPERATURE RANGE						
T _A	Specified ambient temperature		- 40		125	°C
	Operating ambient temperature		- 55		125	

6.4 Thermal Information

THERMAL METRIC ⁽¹⁾		DWV (SOIC)	UNIT
		8 PINS	
$R_{\theta JA}$	Junction-to-ambient thermal resistance	112.2	°C/W
$R_{\theta JC(top)}$	Junction-to-case (top) thermal resistance	47.6	°C/W
$R_{\theta JB}$	Junction-to-board thermal resistance	60.0	°C/W
Ψ_{JT}	Junction-to-top characterization parameter	23.1	°C/W
Ψ_{JB}	Junction-to-board characterization parameter	60.0	°C/W
$R_{\theta JC(bot)}$	Junction-to-case (bottom) thermal resistance	N/A	°C/W

(1) For more information about traditional and new thermal metrics, see the [Semiconductor and IC Package Thermal Metrics](#) application report.

6.5 Power Ratings

PARAMETER		TEST CONDITIONS	VALUE	UNIT
P_D	Maximum power dissipation (both sides)	AVDD = DVDD = 5.5 V	87	mW
P_{D1}	Maximum power dissipation (high-side supply)	AVDD = 3.6 V	31	mW
		AVDD = 5.5 V	54	
P_{D2}	Maximum power dissipation (low-side supply)	DVDD = 3.6 V	17	mW
		DVDD = 5.5 V	33	

6.6 Insulation Specifications

over operating ambient temperature range (unless otherwise noted)

PARAMETER		TEST CONDITIONS	VALUE	UNIT
GENERAL				
CLR	External clearance ⁽¹⁾	Shortest pin-to-pin distance through air	≥ 8.5	mm
CPG	External creepage ⁽¹⁾	Shortest pin-to-pin distance across the package surface	≥ 8.5	mm
DTI	Distance through insulation	Minimum internal gap (internal clearance) of the double insulation	≥ 0.021	mm
CTI	Comparative tracking index	DIN EN 60112 (VDE 0303-11); IEC 60112	≥ 600	V
	Material group	According to IEC 60664-1	I	
	Overvoltage category per IEC 60664-1	Rated mains voltage ≤ 600 V _{RMS}	I-IV	
		Rated mains voltage ≤ 1000 V _{RMS}	I-III	
DIN EN IEC 60747-17 (VDE 0884-17)⁽²⁾				
V _{IORM}	Maximum repetitive peak isolation voltage	At AC voltage	2120	V _{PK}
V _{IOWM}	Maximum-rated isolation working voltage	At AC voltage (sine wave)	1500	V _{RMS}
		At DC voltage	2120	V _{DC}
V _{IOTM}	Maximum transient isolation voltage	V _{TEST} = V _{IOTM} , t = 60 s (qualification test), V _{TEST} = 1.2 × V _{IOTM} , t = 1 s (100% production test)	7070	V _{PK}
V _{IMP}	Maximum impulse voltage ⁽³⁾	Tested in air, 1.2/50-μs waveform per IEC 62368-1	9800	V _{PK}
V _{IOSM}	Maximum surge isolation voltage ⁽⁴⁾	Tested in oil (qualification test), 1.2/50-μs waveform per IEC 62368-1	12800	V _{PK}
q _{pd}	Apparent charge ⁽⁵⁾	Method a, after input/output safety test subgroups 2 and 3, V _{pd(ini)} = V _{IOTM} , t _{ini} = 60 s, V _{pd(m)} = 1.2 × V _{IORM} , t _m = 10 s	≤ 5	pC
		Method a, after environmental tests subgroup 1, V _{pd(ini)} = V _{IOTM} , t _{ini} = 60 s, V _{pd(m)} = 1.6 × V _{IORM} , t _m = 10 s	≤ 5	
		Method b1, at preconditioning (type test) and routine test, V _{pd(ini)} = 1.2 × V _{IOTM} , t _{ini} = 1 s, V _{pd(m)} = 1.875 × V _{IORM} , t _m = 1 s	≤ 5	
		Method b2, at routine test (100% production) ⁽⁷⁾ , V _{pd(ini)} = V _{pd(m)} = 1.2 × V _{IOTM} ; t _{ini} = t _m = 1 s	≤ 5	
C _{IO}	Barrier capacitance, input to output ⁽⁶⁾	V _{IO} = 0.5 V _{PP} at 1 MHz	~1.5	pF
R _{IO}	Insulation resistance, input to output ⁽⁶⁾	V _{IO} = 500 V at T _A = 25°C	> 10 ¹²	Ω
		V _{IO} = 500 V at 100°C ≤ T _A ≤ 125°C	> 10 ¹¹	
		V _{IO} = 500 V at T _S = 150°C	> 10 ⁹	
	Pollution degree		2	
	Climatic category		55/125/21	
UL1577				
V _{ISO}	Withstand isolation voltage	V _{TEST} = V _{ISO} , t = 60 s (qualification test), V _{TEST} = 1.2 × V _{ISO} , t = 1 s (100% production test)	5000	V _{RMS}

- (1) Apply creepage and clearance requirements according to the specific equipment isolation standards of an application. Care must be taken to maintain the creepage and clearance distance of a board design to ensure that the mounting pads of the isolator on the printed circuit board (PCB) do not reduce this distance. Creepage and clearance on a PCB become equal in certain cases. Techniques such as inserting grooves, ribs, or both on a PCB are used to help increase these specifications.
- (2) This coupler is suitable for *safe electrical insulation* only within the safety ratings. Compliance with the safety ratings shall be ensured by means of suitable protective circuits.
- (3) Testing is carried out in air to determine the surge immunity of the package.
- (4) Testing is carried in oil to determine the intrinsic surge immunity of the isolation barrier.
- (5) Apparent charge is electrical discharge caused by a partial discharge (pd).
- (6) All pins on each side of the barrier are tied together, creating a two-pin device.
- (7) Either method b1 or b2 is used in production.

6.7 Safety-Related Certifications

VDE	UL
DIN EN IEC 60747-17 (VDE 0884-17), EN IEC 60747-17, DIN EN IEC 62368-1 (VDE 0868-1), EN IEC 62368-1, IEC 62368-1 Clause : 5.4.3 ; 5.4.4.4 ; 5.4.9	Recognized under 1577 component recognition program
Reinforced insulation	Single protection
Certificate number: 40040142	File number: E181974

6.8 Safety Limiting Values

PARAMETER		TEST CONDITIONS	MIN	TYP	MAX	UNIT
I _S	Safety input, output, or supply current	R _{θJA} = 112.2°C/W, AVDD = DVDD = 5.5 V, T _J = 150°C, T _A = 25°C			203	mA
		R _{θJA} = 112.2°C/W, AVDD = DVDD = 3.6 V, T _J = 150°C, T _A = 25°C			309	
P _S	Safety input, output, or total power ⁽¹⁾	R _{θJA} = 112.2°C/W, T _J = 150°C, T _A = 25°C			1114	mW
T _S	Maximum safety temperature				150	°C

- (1) The maximum safety temperature, T_S, has the same value as the maximum junction temperature, T_J, specified for the device. The I_S and P_S parameters represent the safety current and safety power, respectively. Do not exceed the maximum limits of I_S and P_S. These limits vary with the ambient temperature, T_A.

The junction-to-air thermal resistance, R_{θJA}, in the [Thermal Information](#) table is that of a device installed on a high-K test board for leaded surface-mount packages. Use these equations to calculate the value for each parameter:

T_J = T_A + R_{θJA} × P, where P is the power dissipated in the device.

T_{J(max)} = T_S = T_A + R_{θJA} × P_S, where T_{J(max)} is the maximum junction temperature.

P_S = I_S × AVDD_{max} + I_S × DVDD_{max}, where AVDD_{max} is the maximum high-side voltage and DVDD_{max} is the maximum controller-side supply voltage.

6.9 Electrical Characteristics

minimum and maximum specifications are at $T_A = -40^\circ\text{C}$ to 125°C , $AVDD = 3.0\text{ V}$ to 5.5 V , $DVDD = 2.7\text{ V}$ to 5.5 V , $INP = -250\text{ mV}$ to 250 mV , $INN = 0\text{ V}$, and sinc³ filter with $OSR = 256$ (unless otherwise noted); typical specifications are at $T_A = 25^\circ\text{C}$, $CLKIN = 20\text{ MHz}$, $AVDD = 5\text{ V}$, and $DVDD = 3.3\text{ V}$

PARAMETER		TEST CONDITIONS	MIN	TYP	MAX	UNIT
ANALOG INPUTS						
V_{CMov}	Common-mode overvoltage detection level	$(INP + INN) / 2$ to AGND	$AVDD - 2$			V
C_{IN}	Single-ended input capacitance	$INN = AGND$	2			pF
C_{IND}	Differential input capacitance		1			pF
I_{IB}	Input bias current	$INP = INN = AGND$, $I_{IB} = I_{BP} + I_{BN}$, $-55^\circ\text{C} \leq T_A \leq 125^\circ\text{C}$	-82	-60	-48	μA
R_{IN}	Single-ended input resistance	$INN = AGND$, $-55^\circ\text{C} \leq T_A \leq 125^\circ\text{C}$	19			$k\Omega$
R_{IND}	Differential input resistance	$-55^\circ\text{C} \leq T_A \leq 125^\circ\text{C}$	22			$k\Omega$
I_{IO}	Input offset current		± 5			nA
CMTI	Common-mode transient immunity		100	150		$\text{KV}/\mu\text{s}$
CMRR	Common-mode rejection ratio	$INP = INN$, $f_{IN} = 0\text{ Hz}$, $V_{CM\ min} \leq V_{IN} \leq V_{CM\ max}$	-95			dB
		$INP = INN$, f_{IN} from 0.1 Hz to 50 kHz, $V_{CM\ min} \leq V_{IN} \leq V_{CM\ max}$	-95			
BW	Input bandwidth		900			kHz
DC ACCURACY						
DNL	Differential nonlinearity	Resolution: 16 bits, $-55^\circ\text{C} \leq T_A \leq 125^\circ\text{C}$	-0.99		0.99	LSB
INL	Integral nonlinearity ⁽²⁾	Resolution: 16 bits, $-55^\circ\text{C} \leq T_A \leq 125^\circ\text{C}$	-4	± 1	4	LSB
E_O	Offset error ⁽¹⁾	$INP = INN = AGND$, $T_A = 25^\circ\text{C}$	-100	± 4.5	100	μV
		$INP = INN = AGND$, $T_A = -55^\circ\text{C}$	-180	± 20	180	
TCE_O	Offset error temperature drift ⁽³⁾		-1		1	$\mu\text{V}/^\circ\text{C}$
E_G	Gain error	$T_A = 25^\circ\text{C}$	-0.2%	$\pm 0.005\%$	0.2%	
		$T_A = -55^\circ\text{C}$	-0.52%	$\pm 0.17\%$	0.52%	
TCE_G	Gain error temperature drift ⁽⁴⁾	$-40^\circ\text{C} \leq T_A \leq 125^\circ\text{C}$	-40	± 20	40	$\text{ppm}/^\circ\text{C}$
PSRR	Power-supply rejection ratio	$INP = INN = AGND$, $AVDD$ from 3.0 V to 5.5 V, at DC	-103			dB
		$INP = INN = AGND$, $AVDD$ from 3.0 V to 5.5 V, 10-kHz / 100-mV ripple	-92			
AC ACCURACY						
SNR	Signal-to-noise ratio	$f_{IN} = 1\text{ kHz}$	82	86		dB
SINAD	Signal-to-noise + distortion	$f_{IN} = 1\text{ kHz}$	81.9	85.7		dB
THD	Total harmonic distortion ⁽⁵⁾	$4.5\text{ V} \leq AVDD \leq 5.5\text{ V}$, $f_{IN} = 1\text{ kHz}$, $5\text{ MHz} \leq f_{CLKIN} \leq 21\text{ MHz}$	-98			dB
		$3.0\text{ V} \leq AVDD \leq 3.6\text{ V}$, $f_{IN} = 1\text{ kHz}$, $5\text{ MHz} \leq f_{CLKIN} \leq 20\text{ MHz}$	-93			
SFDR	Spurious-free dynamic range	$f_{IN} = 1\text{ kHz}$	83	100		dB
CMOS LOGIC WITH SCHMITT-TRIGGER						
I_{IN}	Input current	$DGND \leq V_{IN} \leq DVDD$	0			μA
C_{IN}	Input capacitance		4			pF
V_{IH}	High-level input voltage		$0.7 \times DVDD$		$DVDD + 0.3$	V

6.9 Electrical Characteristics (continued)

minimum and maximum specifications are at $T_A = -40^\circ\text{C}$ to 125°C , $AVDD = 3.0\text{ V}$ to 5.5 V , $DVDD = 2.7\text{ V}$ to 5.5 V , $INP = -250\text{ mV}$ to 250 mV , $INN = 0\text{ V}$, and sinc³ filter with $OSR = 256$ (unless otherwise noted); typical specifications are at $T_A = 25^\circ\text{C}$, $CLKIN = 20\text{ MHz}$, $AVDD = 5\text{ V}$, and $DVDD = 3.3\text{ V}$

PARAMETER		TEST CONDITIONS	MIN	TYP	MAX	UNIT
V_{IL}	Low-level input voltage		- 0.3		$0.3 \times DVDD$	V
C_{LOAD}	Output load capacitance			30		pF
V_{OH}	High-level output voltage	$I_{OH} = -4\text{ mA}$, $-55^\circ\text{C} \leq T_A \leq 125^\circ\text{C}$	$DVDD - 0.4$			V
V_{OL}	Low-level output voltage	$I_{OL} = 4\text{ mA}$, $-55^\circ\text{C} \leq T_A \leq 125^\circ\text{C}$			0.4	V
POWER SUPPLY						
I_{AVDD}	High-side supply current	$3.0\text{ V} \leq AVDD \leq 3.6\text{ V}$		6.3	8.5	mA
		$4.5\text{ V} \leq AVDD \leq 5.5\text{ V}$		7.2	9.8	
I_{DVDD}	Low-side supply current	$2.7\text{ V} \leq DVDD \leq 3.6\text{ V}$, $C_{LOAD} = 15\text{ pF}$		3.3	4.8	mA
		$4.5\text{ V} \leq DVDD \leq 5.5\text{ V}$, $C_{LOAD} = 15\text{ pF}$		3.9	6.0	
$AVDD_{UV}$	High-side undervoltage detection threshold	$AVDD$ rising, $-55^\circ\text{C} \leq T_A \leq 125^\circ\text{C}$	2.45	2.7	2.9	V
		$AVDD$ falling, $-55^\circ\text{C} \leq T_A \leq 125^\circ\text{C}$	2.4	2.6	2.8	
$DVDD_{UV}$	Low-side undervoltage detection threshold	$DVDD$ rising, $-55^\circ\text{C} \leq T_A \leq 125^\circ\text{C}$	2.2	2.45	2.65	V
		$DVDD$ falling, $-55^\circ\text{C} \leq T_A \leq 125^\circ\text{C}$	1.75	2.0	2.2	

- (1) This parameter is input referred.
- (2) Integral nonlinearity is defined as the maximum deviation from a straight line passing through the end-points of the ideal ADC transfer function expressed as number of LSBs or as a percent of the specified linear full-scale range FSR.
- (3) Offset error temperature drift is calculated using the box method, as described by the following equation:
 $TCE_O = (E_{O,MAX} - E_{O,MIN}) / TempRange$ where $E_{O,MAX}$ and $E_{O,MIN}$ refer to the maximum and minimum E_O values measured within the temperature range (-40 to 125°C).
- (4) Gain error temperature drift is calculated using the box method, as described by the following equation:
 $TCE_G (ppm) = ((E_{G,MAX} - E_{G,MIN}) / TempRange) \times 10^4$ where $E_{G,MAX}$ and $E_{G,MIN}$ refer to the maximum and minimum E_G values (in %) measured within the temperature range (-40 to 125°C).
- (5) THD is the ratio of the rms sum of the amplitudes of first five higher harmonics to the amplitude of the fundamental.

6.10 Switching Characteristics

PARAMETER		TEST CONDITIONS	MIN	TYP	MAX	UNIT
t_H	DOUT hold time after rising edge of CLKIN	$C_{LOAD} = 15 \text{ pF}$	3.5			ns
t_D	Rising edge of CLKIN to DOUT valid delay	$C_{LOAD} = 15 \text{ pF}$			15	ns
t_r	DOUT rise time	10% to 90%, $2.7 \text{ V} \leq DVDD \leq 3.6 \text{ V}$, $C_{LOAD} = 15 \text{ pF}$		2.5	6	ns
		10% to 90%, $4.5 \text{ V} \leq DVDD \leq 5.5 \text{ V}$, $C_{LOAD} = 15 \text{ pF}$		3.2	6	
t_f	DOUT fall time	10% to 90%, $2.7 \text{ V} \leq DVDD \leq 3.6 \text{ V}$, $C_{LOAD} = 15 \text{ pF}$		2.2	6	ns
		10% to 90%, $4.5 \text{ V} \leq DVDD \leq 5.5 \text{ V}$, $C_{LOAD} = 15 \text{ pF}$		2.9	6	
t_{START}	Device start-up time	AVDD step from 0 to 3.0 V with $DVDD \geq 2.7 \text{ V}$ to bitstream valid, 0.1% settling		0.5		ms

6.11 Timing Diagrams



图 6-1. Digital Interface Timing



图 6-2. Device Start-Up Timing

6.12 Insulation Characteristics Curves

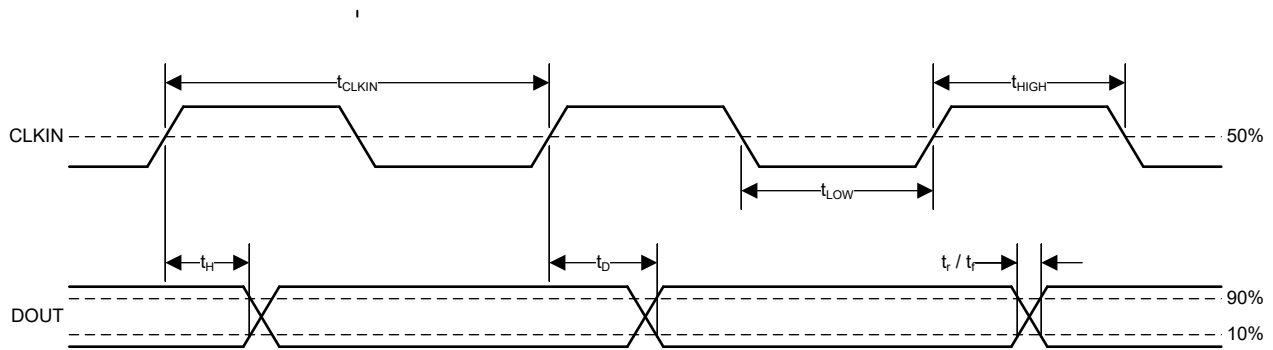

6.13 Typical Characteristics

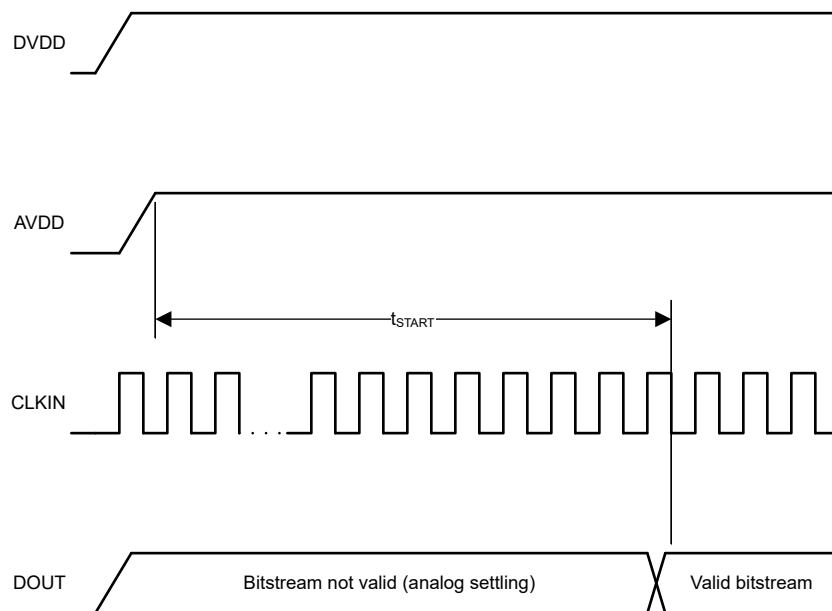
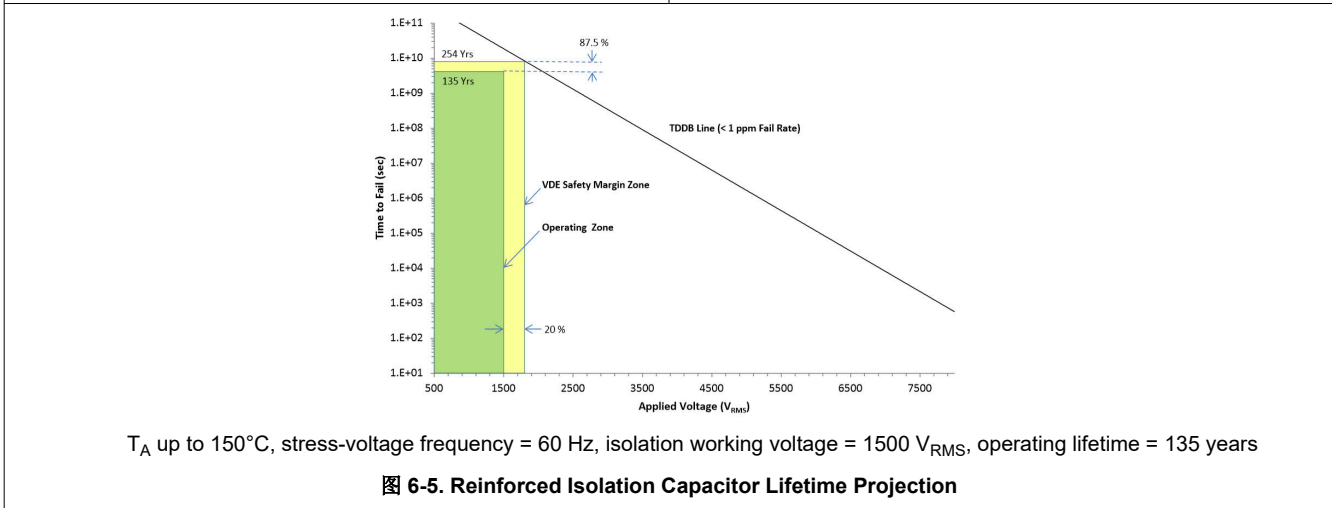
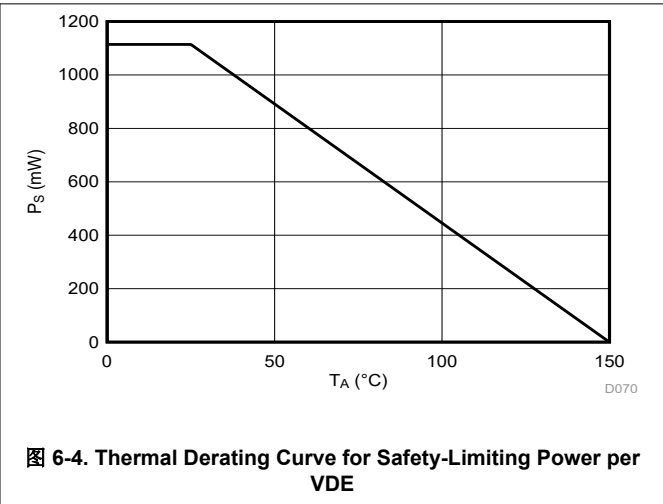
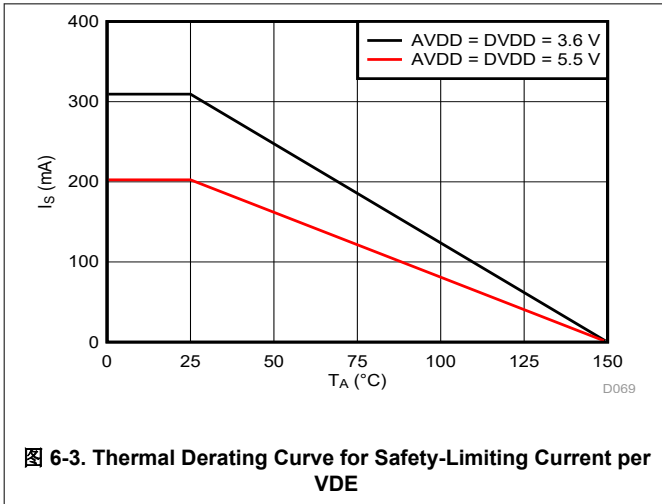
at AVDD = 5 V, DVDD = 3.3 V, INP = - 250 mV to 250 mV, INN = AGND, $f_{CLKIN} = 20$ MHz, and sinc³ filter with OSR = 256 (unless otherwise noted)



图 6-6. Maximum Operating Common-Mode Input Voltage vs High-Side Supply Voltage



图 6-7. Common-Mode Overtolerance Detection Level vs Temperature

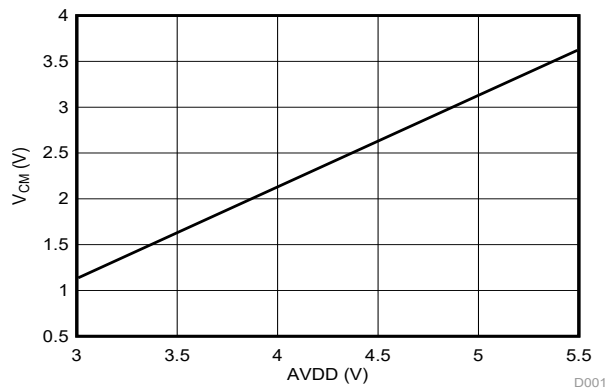

图 6-8. Input Bias Current vs Common-Mode Input Voltage

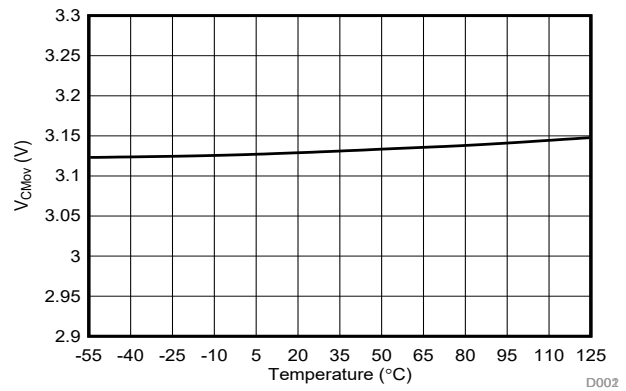

图 6-9. Common-Mode Rejection Ratio vs Input Signal Frequency

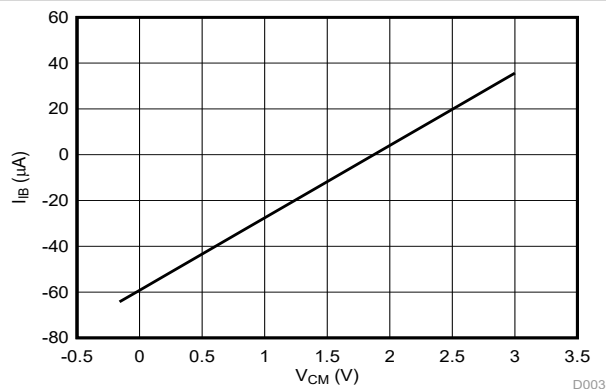

图 6-10. Integral Nonlinearity vs Temperature

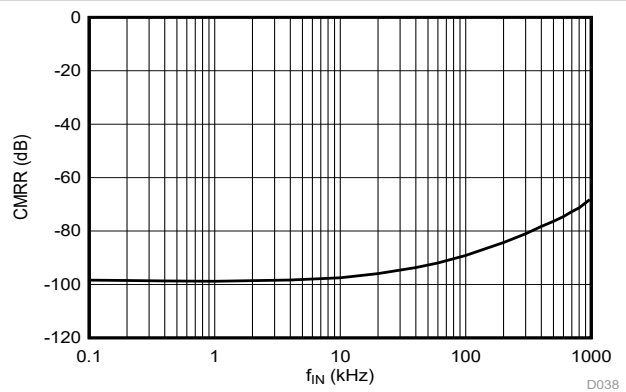

图 6-11. Offset Error vs High-Side Supply Voltage

6.13 Typical Characteristics (continued)

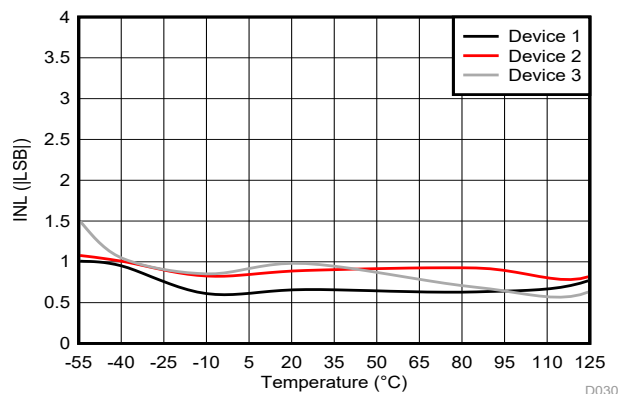
at AVDD = 5 V, DVDD = 3.3 V, INP = - 250 mV to 250 mV, INN = AGND, f_{CLKIN} = 20 MHz, and sinc³ filter with OSR = 256 (unless otherwise noted)

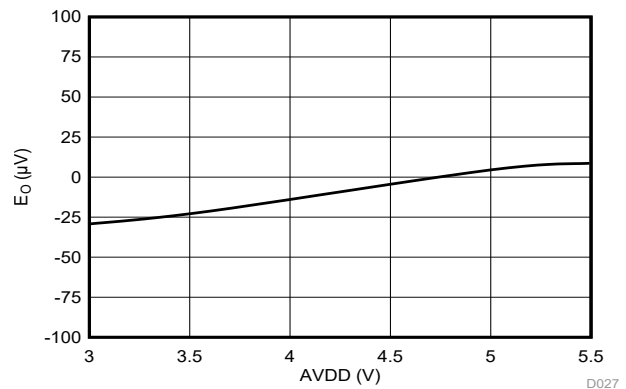
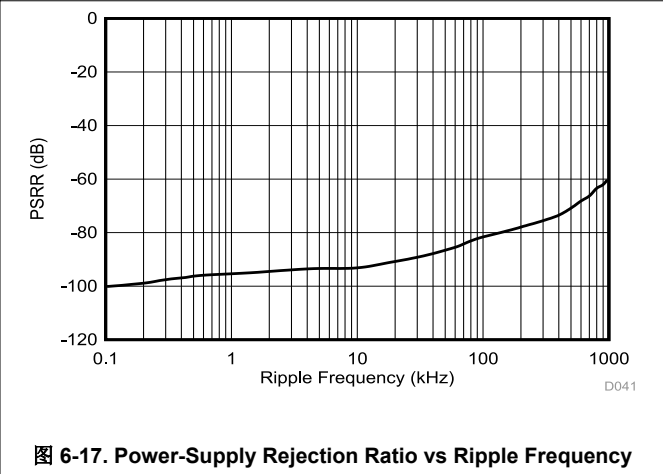
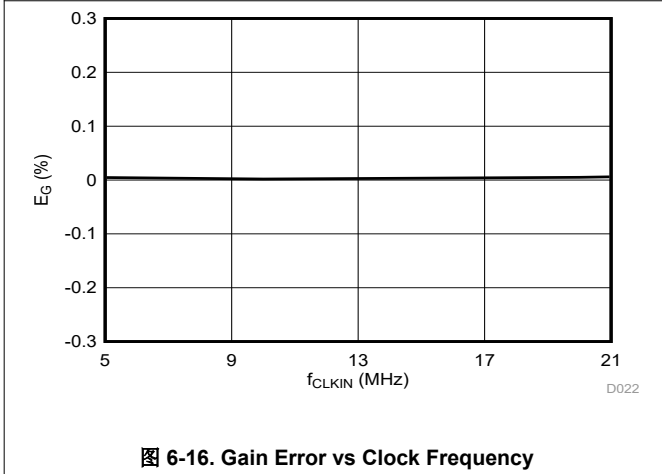
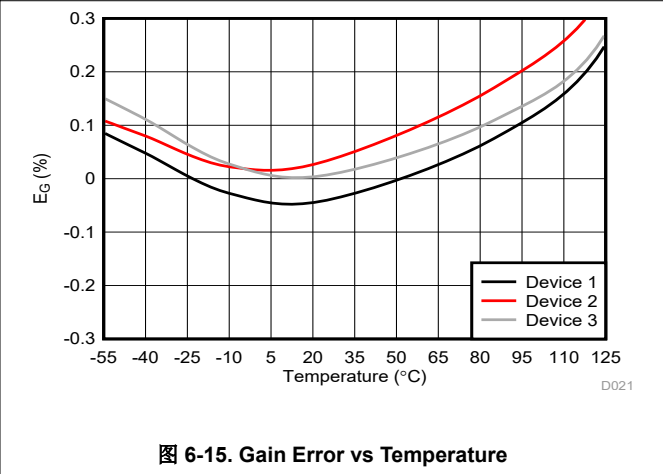
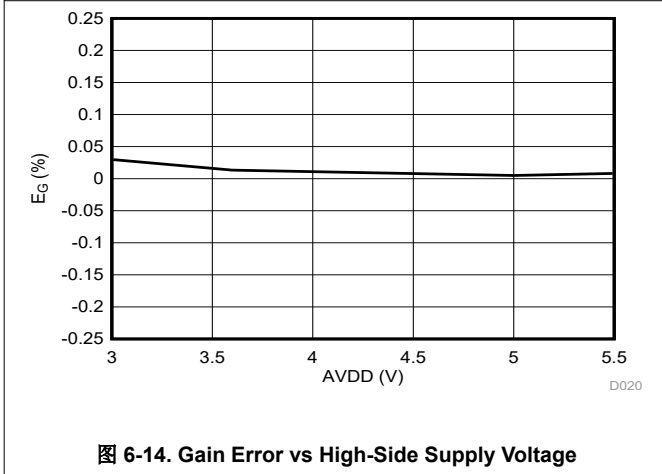
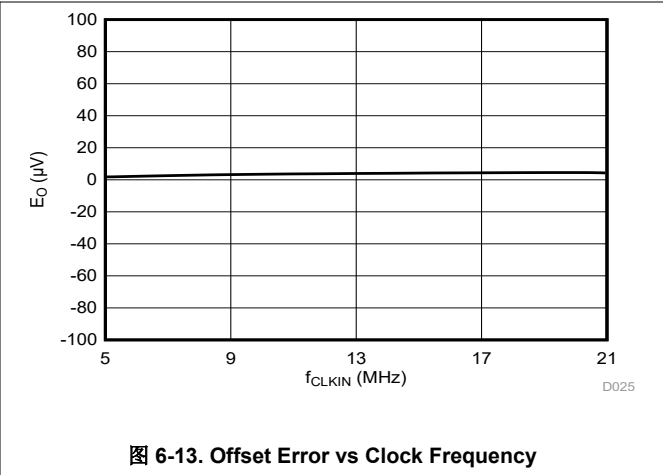
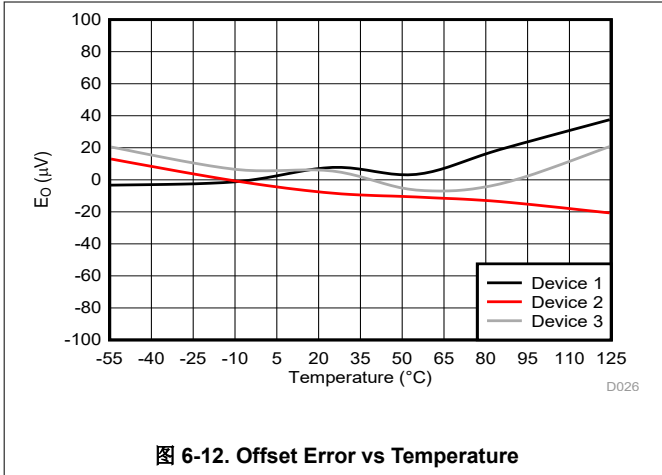

6.13 Typical Characteristics (continued)

at AVDD = 5 V, DVDD = 3.3 V, INP = - 250 mV to 250 mV, INN = AGND, f_{CLKIN} = 20 MHz, and sinc³ filter with OSR = 256 (unless otherwise noted)



图 6-18. Signal-to-Noise Ratio and Signal-to-Noise + Distortion vs High-Side Supply Voltage



图 6-19. Signal-to-Noise Ratio and Signal-to-Noise + Distortion vs Temperature

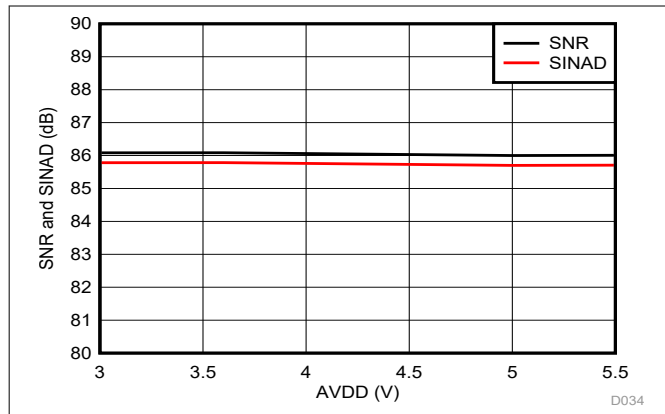

图 6-20. Signal-to-Noise Ratio and Signal-to-Noise + Distortion vs Clock Frequency

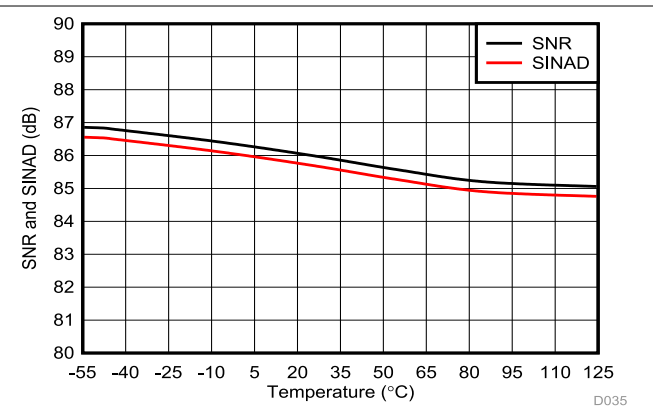

图 6-21. Signal-to-Noise Ratio and Signal-to-Noise + Distortion vs Input Signal Frequency

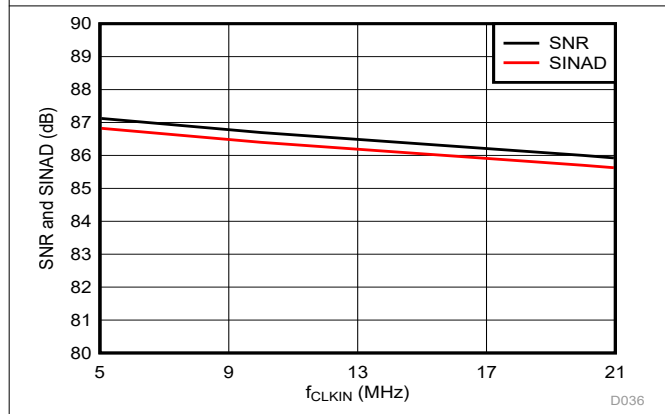

图 6-22. Signal-to-Noise Ratio and Signal-to-Noise + Distortion vs Input Signal Amplitude

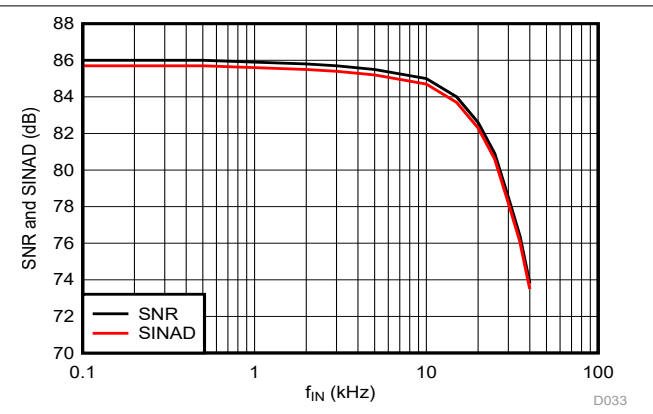

图 6-23. Total Harmonic Distortion vs High-Side Supply Voltage (5 V, nom)

6.13 Typical Characteristics (continued)

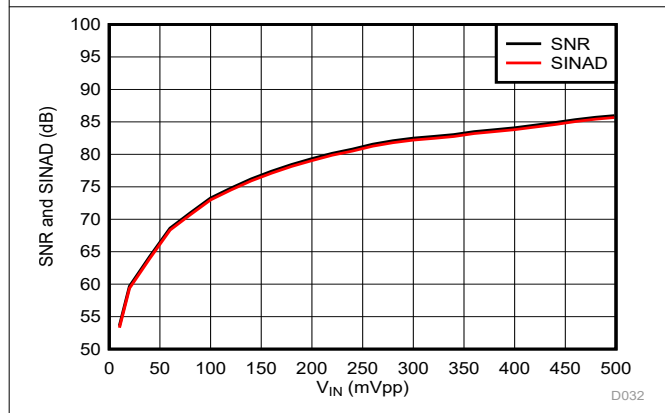
at AVDD = 5 V, DVDD = 3.3 V, INP = - 250 mV to 250 mV, INN = AGND, f_{CLKIN} = 20 MHz, and sinc³ filter with OSR = 256 (unless otherwise noted)

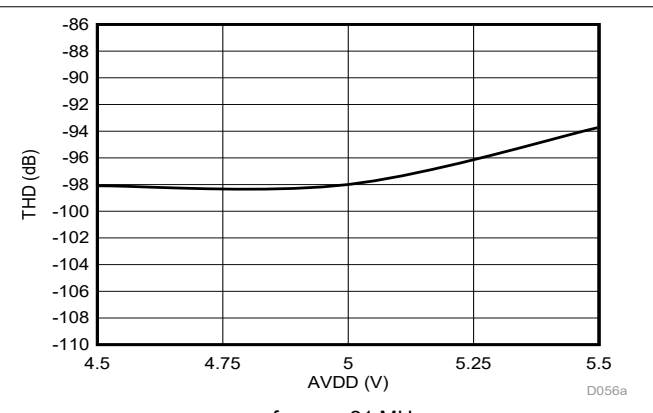

图 6-24. Total Harmonic Distortion vs High-Side Supply Voltage (3.3 V, nom)



图 6-25. Total Harmonic Distortion vs Temperature

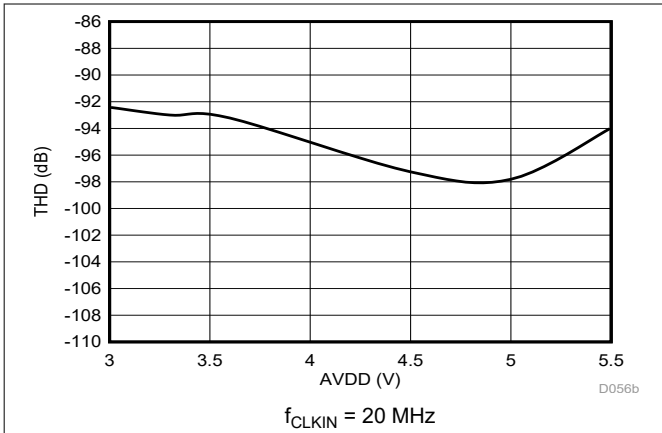

图 6-26. Total Harmonic Distortion vs Clock Frequency

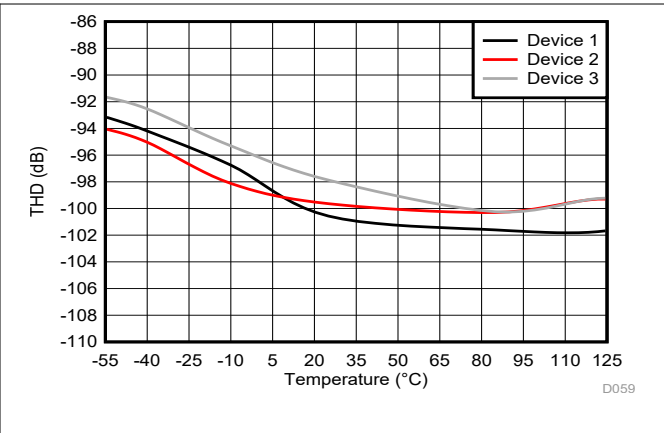

图 6-27. Total Harmonic Distortion vs Input Signal Frequency

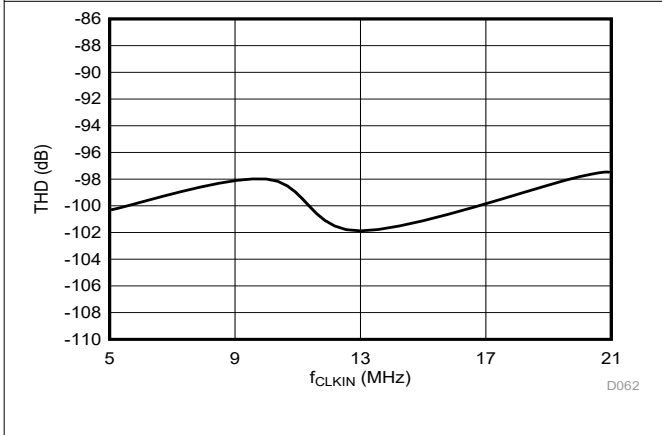

图 6-28. Total Harmonic Distortion vs Input Signal Amplitude

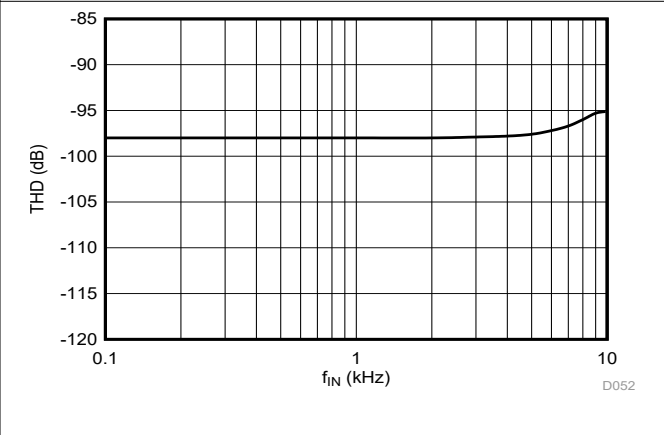

图 6-29. Spurious-Free Dynamic Range vs High-Side Supply Voltage

6.13 Typical Characteristics (continued)

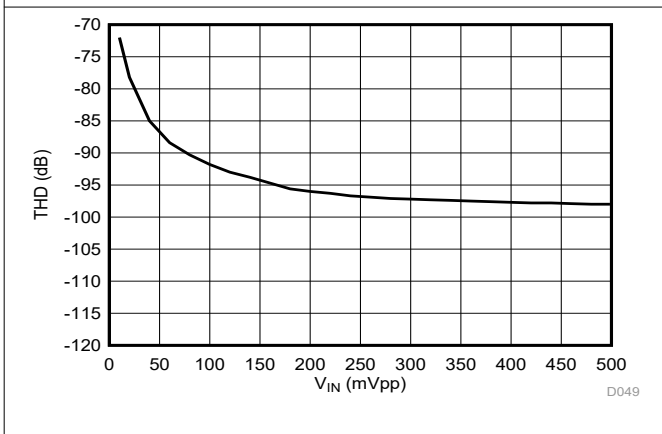
at AVDD = 5 V, DVDD = 3.3 V, INP = - 250 mV to 250 mV, INN = AGND, f_{CLKIN} = 20 MHz, and sinc³ filter with OSR = 256 (unless otherwise noted)

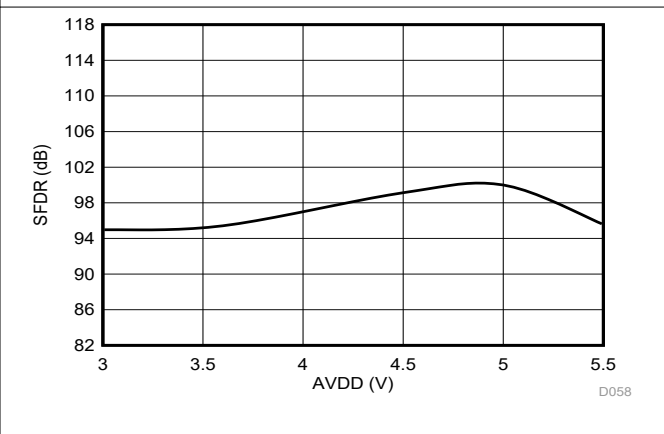

图 6-30. Spurious-Free Dynamic Range vs Temperature



图 6-31. Spurious-Free Dynamic Range vs Clock Frequency

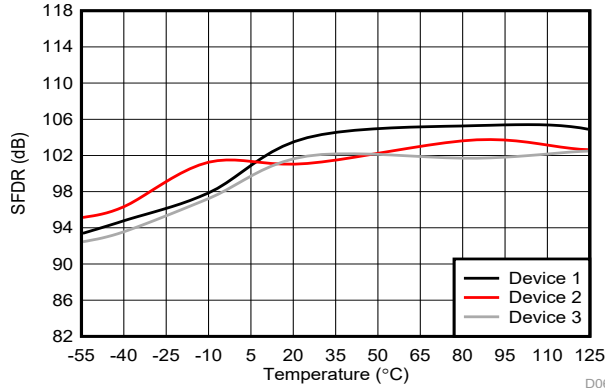

图 6-32. Spurious-Free Dynamic Range vs Input Signal Frequency

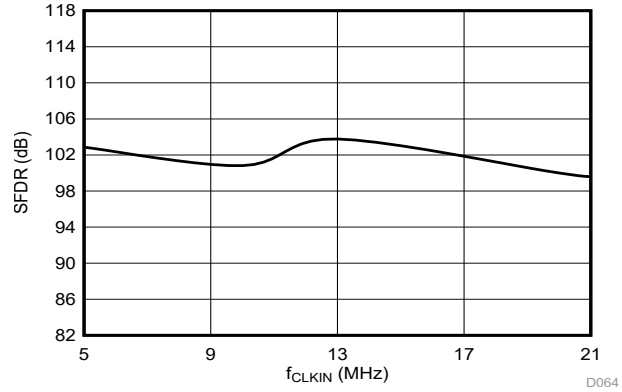

图 6-33. Spurious-Free Dynamic Range vs Input Signal Amplitude

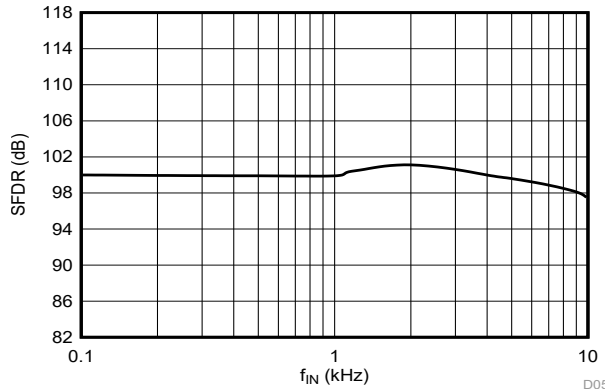

图 6-34. Frequency Spectrum With 1-kHz Input Signal

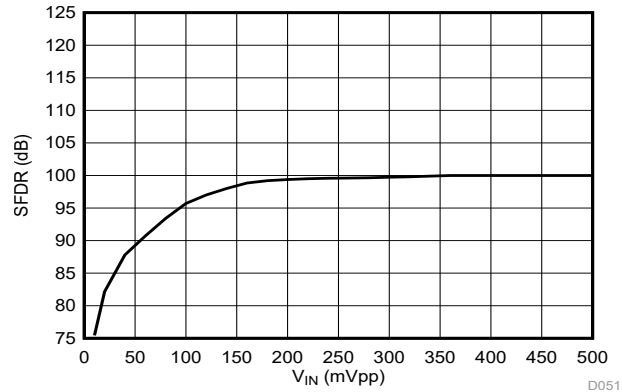

图 6-35. Frequency Spectrum With 10-kHz Input Signal

6.13 Typical Characteristics (continued)

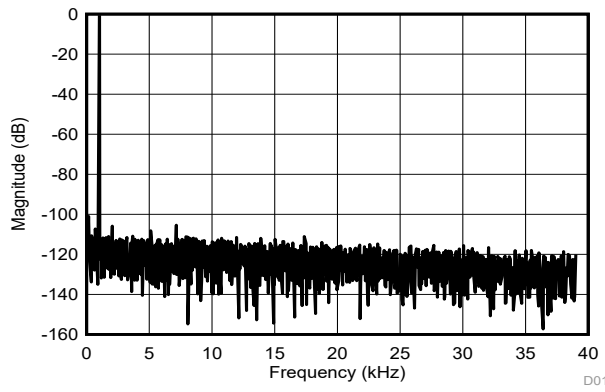
at AVDD = 5 V, DVDD = 3.3 V, INP = - 250 mV to 250 mV, INN = AGND, f_{CLKIN} = 20 MHz, and sinc³ filter with OSR = 256 (unless otherwise noted)

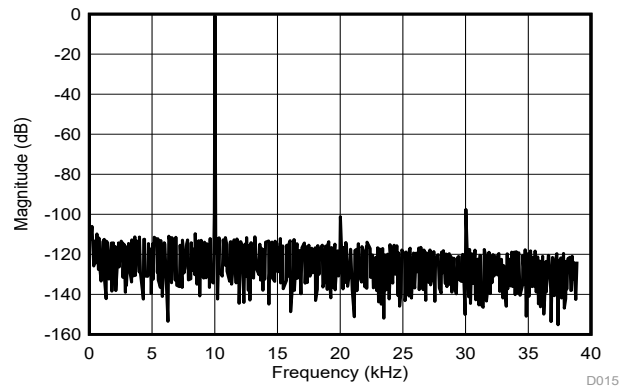
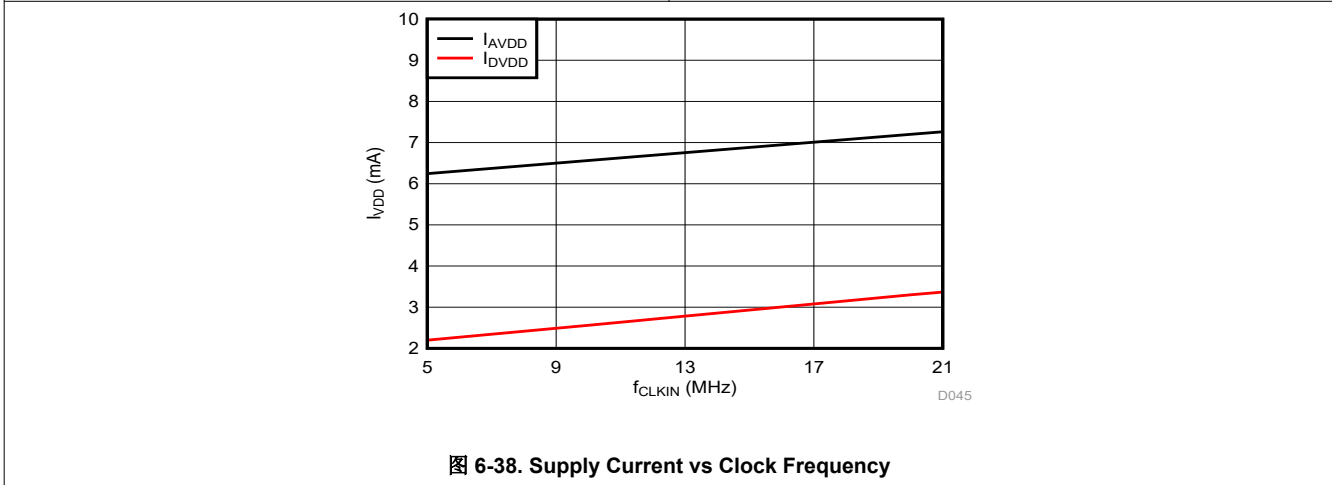
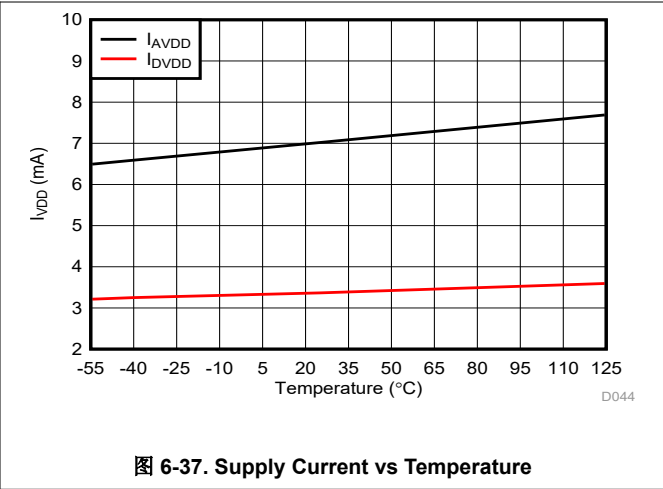
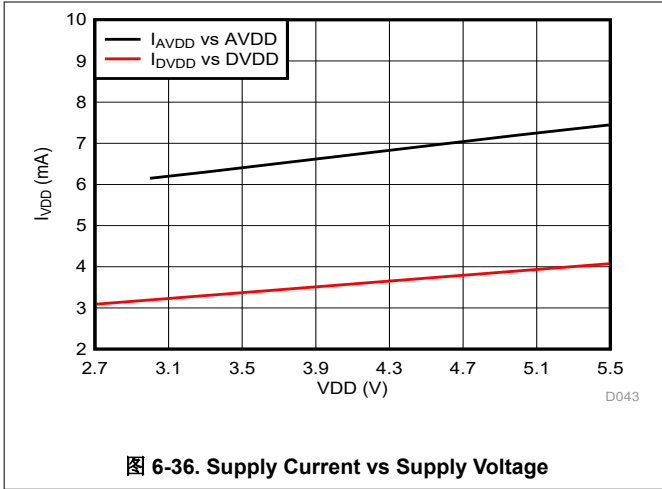

7 Detailed Description

7.1 Overview

The input stage of the AMC1306M25E consists of a fully differential amplifier that feeds the switched-capacitor input of a second-order, delta-sigma ($\Delta \Sigma$) modulator. The modulator converts the analog input signal into a digital bitstream that is transferred across the isolation barrier that separates the high-side from the low-side. The isolated data output DOUT of the converter provides a stream of digital ones and zeros that is synchronous to the externally provided clock source at the CLKIN pin. The time average of this serial bitstream output is proportional to the analog input voltage. The external clock input simplifies the synchronization of multiple current-sensing channels on the system level.

The silicon-dioxide (SiO_2) based capacitive isolation barrier supports a high level of magnetic field immunity as described in the [ISO72x Digital Isolator Magnetic-Field Immunity application note](#). The digital modulation used in the AMC1306M25E to transmit data across the isolation barrier, and the isolation barrier characteristics, result in high reliability and common-mode transient immunity.

7.2 Functional Block Diagram

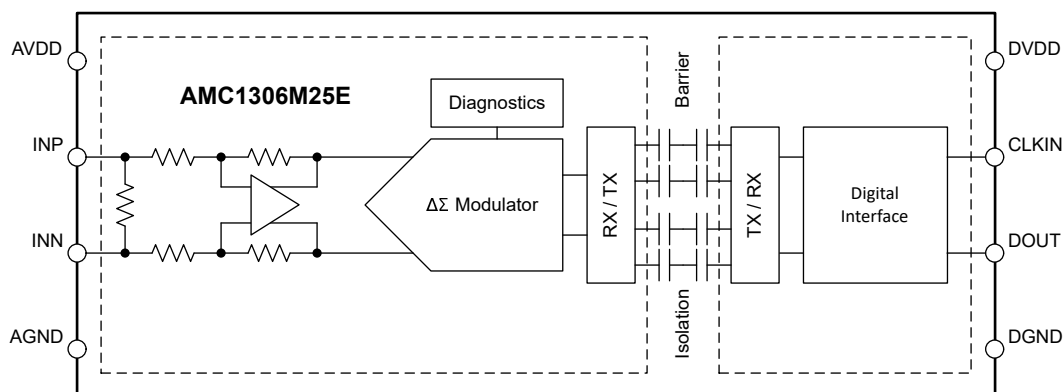

7.3 Feature Description

7.3.1 Analog Input

The differential amplifier input stage of the AMC1306M25E feeds a second-order, switched-capacitor, feed-forward $\Delta\Sigma$ modulator. The gain of the differential amplifier is set by internal precision resistors with a differential input impedance of R_{IND} . The modulator converts the analog input signal into a bitstream that is transferred across the isolation barrier, as described in the [Isolation Channel Signal Transmission](#) section.

For reduced offset and offset drift, the differential amplifier is chopper-stabilized with the switching frequency set at $f_{CLKIN} / 32$. As shown in [图 7-1](#), the switching frequency generates a spur at 625 kHz.

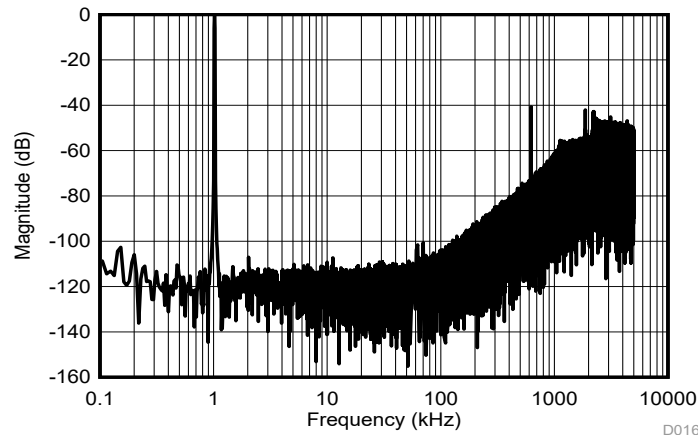

sinc³ filter, OSR = 2, f_{CLKIN} = 20 MHz, f_{IN} = 1 kHz

图 7-1. Quantization Noise Shaping

There are two restrictions on the analog input signals INP and INN. First, if the input voltages V_{INP} or V_{INN} exceed the range specified in the [Absolute Maximum Ratings](#) table, the input currents must be limited to the absolute maximum value because the electrostatic discharge (ESD) protection turns on. In addition, the linearity and parametric performance of the device are ensured only when the analog input voltage remains within the linear full-scale range (V_{FSR}) and within the common-mode input voltage range (V_{CM}) as specified in the [Recommended Operating Conditions](#) table.

7.3.2 Modulator

[图 7-2](#) conceptualizes the second-order, switched-capacitor, feed-forward $\Delta\Sigma$ modulator implemented in the AMC1306M25E. The analog input voltage V_{IN} and the output V_5 of the 1-bit digital-to-analog converter (DAC) are differentiated, providing an analog voltage V_1 at the input of the first integrator stage. The output of the first integrator feeds the input of the second integrator stage, resulting in output voltage V_3 that is differentiated with the input signal V_{IN} and the output of the first integrator V_2 . Depending on the polarity of the resulting voltage V_4 , the output of the comparator is changed. In this case, the 1-bit DAC responds on the next clock pulse by changing the associated analog output voltage V_5 , causing the integrators to progress in the opposite direction, and forcing the value of the integrator output to track the average value of the input.



图 7-2. Block Diagram of a Second-Order Modulator

The modulator shifts the quantization noise to high frequencies, as illustrated in [Figure 7-1](#). Therefore, use a low-pass digital filter at the output of the device to increase the overall performance. This filter is also used to convert the 1-bit data stream at a high sampling rate into a higher-bit data word at a lower rate (decimation). TI's [C2000™](#) and [Sitara™](#) microcontroller families offer a suitable programmable, hardwired filter structure termed a *sigma-delta filter module* (SDFM) optimized for usage with the AMC1306M25E. Alternatively, a field-programmable gate array (FPGA) or complex programmable logic device (CPLD) can be used to implement the filter.

7.3.3 Isolation Channel Signal Transmission

The AMC1306M25E uses an on-off keying (OOK) modulation scheme, as shown in [Figure 7-3](#), to transmit the modulator output bitstream across the SiO₂-based isolation barrier. The transmit driver (TX) shown in the [Functional Block Diagram](#) transmits an internally generated, high-frequency carrier across the isolation barrier to represent a digital *one* and does not send a signal to represent a digital *zero*. The nominal frequency of the carrier used inside the AMC1306M25E is 480 MHz.

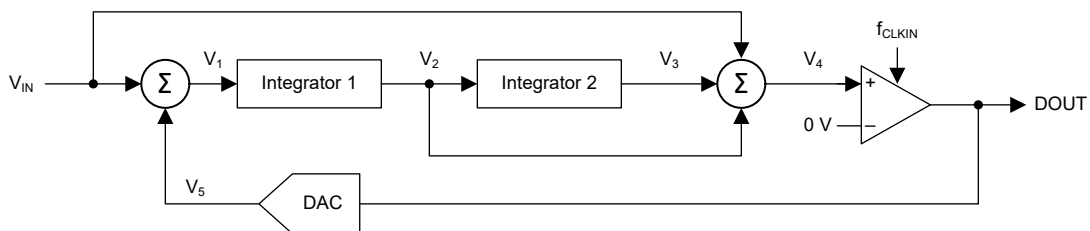
The receiver (RX) on the other side of the isolation barrier recovers and demodulates the signal and produces the output. The AMC1306M25E transmission channel is optimized to achieve the highest level of common-mode transient immunity (CMTI) and lowest level of radiated emissions caused by the high-frequency carrier and RX/TX buffer switching.



图 7-3. OOK-Based Modulation Scheme

7.3.4 Digital Output

A differential input signal of 0 V ideally produces a stream of ones and zeros that are high 50% of the time. A differential input of produces a stream of ones and zeros that are high 89.06% of the time. With 16 bits of resolution, that percentage ideally corresponds to code 58368. A differential input of produces a stream of ones and zeros that are high 10.94% of the time and ideally results in code 7168 with 16-bit resolution. These input voltages are also the specified linear range of the AMC1306M25E. If the input voltage value exceeds this range, the output of the modulator shows nonlinear behavior as the quantization noise increases. The output of the modulator clips with a constant stream of zeros with an input less than or equal to or with a constant stream of ones with an input greater than or equal to . In this case, however, the AMC1306M25E generates a single 1 (if the input is at negative full-scale) or 0 (if the input is at positive full-scale) every 128 clock cycles to indicate proper device function (see the [Output Behavior in Case of a Full-Scale Input](#) section for more details). 图 7-4 shows the input voltage versus the output modulator signal.

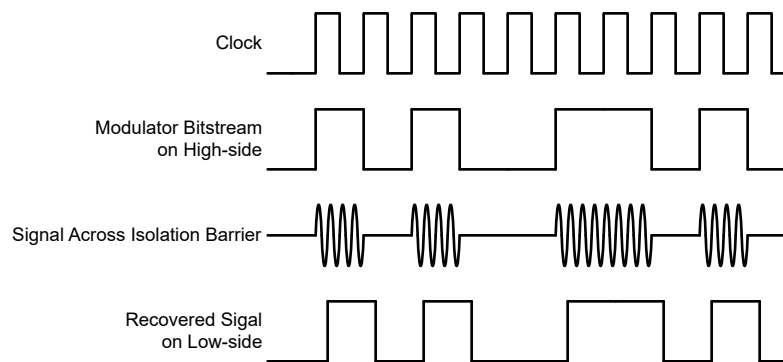

图 7-4. AMC1306M25E Modulator Output vs Analog Input

The density of ones in the output bitstream can be calculated using 方程式 1 for any input voltage ($V_{IN} = V_{INP} - V_{INN}$) value with the exception of a full-scale input signal, as described in 方程式 1:

$$\rho = \frac{V_{IN} + V_{Clipping}}{2 \times V_{Clipping}} \quad (1)$$

7.3.4.1 Output Behavior in Case of a Full-Scale Input

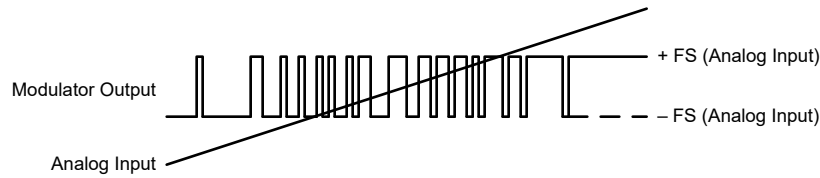
If a full-scale input signal is applied to the AMC1306M25E (that is, $|V_{IN}| \geq |V_{Clipping}|$), the device generates a single one or zero every 128 bits at DOUT, as shown in 图 7-5, depending on the actual polarity of the signal being sensed. In this way, differentiating between a missing AVDD and a full-scale input signal is possible on the system level.



图 7-5. Output of the AMC1306M25E in Case of an Input Overrange

7.3.4.2 Output Behavior in Case of Input Common-Mode Overrange

If INN or INP is disconnected from the shunt resistor, the input bias current of the AMC1306M25E drives the disconnected terminal towards the positive supply rail, and the common-mode input voltage increases. A similar effect happens when there is no DC current path between INN, INP, and HGND. If the input common-mode voltage exceeds the common-mode overvoltage detection threshold V_{CMov} , the device provides a constant bitstream of logic 1's at the output, as shown in [图 7-6](#); that is, DOUT is permanently high. A zero is not generated every 128 clock pulses, which differentiates this condition from a valid positive full-scale input. This feature is useful to identify interconnect problems on the board.

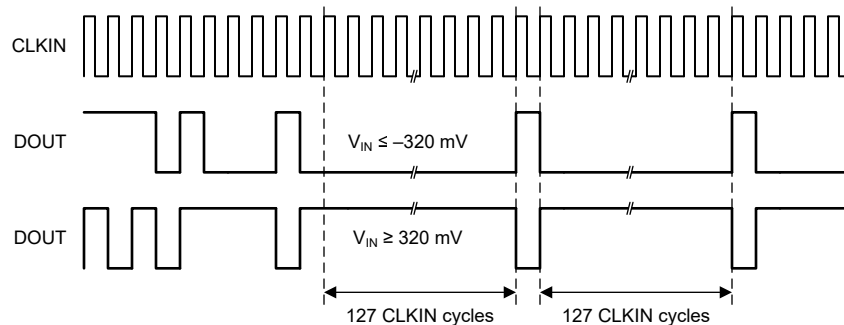

图 7-6. Output of the AMC1306M25E in Case of a Common-Mode Overvoltage

There is no common-mode overvoltage detection in the negative direction; thus, if the common-mode input voltage is below the minimum V_{CM} value specified in the [Recommended Operating Conditions](#) table, the bitstream at the DOUT output is not determined.

7.3.4.3 Output Behavior in Case of a Missing High-Side Supply

If the high-side supply is missing, the device provides a constant bitstream of logic 0's at the output, as shown in [图 7-7](#); that is, DOUT is permanently low. A one is not generated every 128 clock pulses, which differentiates this condition from a valid negative full-scale input. This feature is useful to identify high-side power-supply problems on the board.

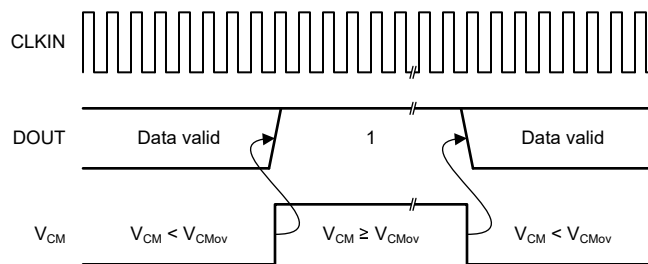

图 7-7. Output of the AMC1306M25E in Case of a Missing High-Side Supply

7.4 Device Functional Modes

The AMC1306M25E is operational when the power supplies AVDD and DVDD are applied as specified in the [Recommended Operating Conditions](#) table.

8 Application and Implementation

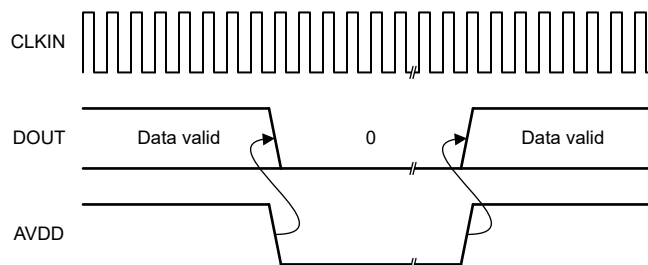
备注

以下应用部分中的信息不属于 TI 器件规格的范围，TI 不担保其准确性和完整性。TI 的客户应负责确定器件是否适用于其应用。客户应验证并测试其设计，以确保系统功能。

8.1 Application Information

The low analog input voltage range, excellent accuracy, and low temperature drift make the AMC1306M25E a high-performance solution for applications where shunt-based current sensing in the presence of high common-mode voltage levels is required.

8.2 Typical Application

The AMC1306M25E is designed for shunt-based current-sensing applications where accurate current monitoring is required in the presence of high common-mode voltages.

图 8-1 shows the AMC1306M25E in a typical application. The load current flowing through an external shunt resistor RSHUNT produces a voltage drop that is sensed by the AMC1306M25E. The AMC1306M25E digitizes the analog input signal on the high-side, transfers the data across the isolation barrier to the low-side, and outputs the digital bitstream on the DOUT pin. The 5-V high-side power supply (AVDD) is generated from the floating gate driver supply using a resistor (R4) and a Zener diode (D1). The 49.9-Ω resistor on the DOUT pin is used for line-termination and improves signal integrity on the receiving end.

The differential input, digital output, and the high common-mode transient immunity (CMTI) of the AMC1306M25E ensure reliable and accurate operation even in high-noise environments.



图 8-1. Using the AMC1306M25E for Current Sensing in a Typical Application

8.2.1 Design Requirements

表 8-1 lists the parameters for this typical application.

表 8-1. Design Requirements

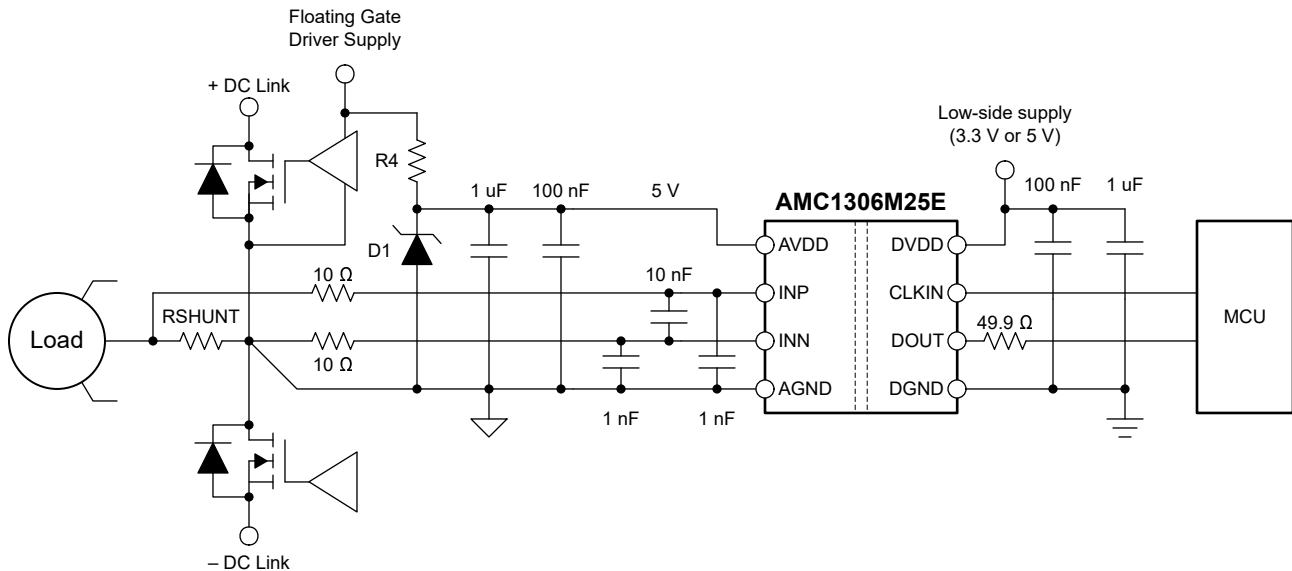
PARAMETER	VALUE
High-side supply voltage	3.3 V or 5 V
Low-side supply voltage	3.3 V or 5 V
Voltage drop across RSHUNT for a linear response	

8.2.2 Detailed Design Procedure

In 图 8-1, the high-side power supply (AVDD) for the AMC1306M25E is derived from the floating power supply of the upper gate driver, using a resistor (R4) and a Zener diode (D1).

The floating ground reference (AGND) is derived from the end of the shunt resistor that is connected to the negative input of the AMC1306M25E (INN). If a four-pin shunt is used, the inputs of the AMC1306M25E are connected to the inner leads and AGND is connected to the outer lead on the INN-side of the shunt. To minimize offset and improve accuracy, route the ground connection as a separate trace that connects directly to the shunt resistor rather than shorting AGND to INN directly at the input to the device. See the [Layout](#) section for more details.

8.2.2.1 Shunt Resistor Sizing

Use Ohm's Law to calculate the voltage drop across the shunt resistor (V_{SHUNT}) for the desired measured current: $V_{SHUNT} = I \times RSHUNT$.

Consider the following two restrictions when selecting the value of the shunt resistor, RSHUNT:

- The voltage drop caused by the nominal current range must not exceed the recommended differential input voltage range for a linear response: $|V_{SHUNT}| \leq |V_{FSR}|$
- The voltage drop caused by the maximum allowed overcurrent must not exceed the input voltage that causes a clipping output: $|V_{SHUNT}| \leq |V_{Clipping}|$

8.2.2.2 Input Filter Design

Place a differential RC filter (R1, R2, C5) in front of the isolated modulator to improve signal-to-noise performance of the signal path. Design the input filter such that:

- The cutoff frequency of the filter is at least one order of magnitude lower than the sampling frequency (f_{CLKIN}) of the $\Delta \Sigma$ modulator
- The input bias current does not generate significant voltage drop across the DC impedances (R1, R2) of the input filter
- The impedances measured from the analog inputs are equal (R1 equals R2)

Capacitors C6 and C7 are optional and improve common-mode rejection at high frequencies (>1 MHz). For best performance, C6 must match the value of C7 and both capacitors must be 10 to 20 times lower in value than C5. For most applications, the structure shown in 图 8-2 achieves excellent performance.



图 8-2. Differential Input Filter

8.2.2.3 Bitstream Filtering

The modulator generates a bitstream that is processed by a digital filter to obtain a digital word similar to a conversion result of a conventional analog-to-digital converter (ADC). As described by 方程式 2, a very simple filter built with minimal effort and hardware, is a sinc³-type filter:

$$H(z) = \left(\frac{1 - z^{-OSR}}{1 - z^{-1}} \right)^3 \quad (2)$$

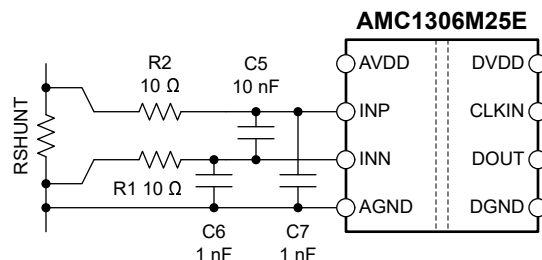
This filter provides the best output performance at the lowest hardware size (count of digital gates) for a second-order modulator. All characterization in this document is also done with a sinc³ filter with an oversampling ratio (OSR) of 256 and an output word width of 16 bits, unless specified otherwise. The measured effective number of bits (ENOB) as a function of the OSR is illustrated in 图 8-3 of the *Typical Application* section.

A *Delta Sigma Modulator Filter Calculator* is available for download at www.ti.com that aids in the filter design and selecting the right OSR and filter order to achieve the desired output resolution and filter response time.

An example code for implementing a sinc³ filter in an FPGA is discussed in the *Combining the ADS1202 with an FPGA Digital Filter for Current Measurement in Motor Control Applications* application note, available for download at www.ti.com.

For modulator output bitstream filtering, a device from TI's C2000™ or Sitara™ microcontroller families is recommended. These families support up to eight channels of dedicated hardwired filter structures that significantly simplify system level design by offering two filtering paths per channel: one providing high-accuracy results for the control loop and one fast-response path for overcurrent detection.

A *delta sigma modulator filter calculator* is available for download at www.ti.com that aids in the filter design and selecting the right OSR and filter order to achieve the desired output resolution and filter response time.

8.2.3 Application Curve

The effective number of bits (ENOB) is often used to compare the performance of ADCs and ΔΣ modulators. 图 8-3 shows the ENOB of the AMC1306M25E with different oversampling ratios. By using 方程式 3, this number can also be calculated from the SINAD:

$$SINAD = 1.76 \text{ dB} + 6.02 \text{ dB} \times ENOB \quad (3)$$



图 8-3. Measured Effective Number of Bits vs Oversampling Ratio

8.3 Best Design Practices

Do not leave the inputs of the AMC1306M25E unconnected (floating) when the device is powered up. If the device inputs are left floating, the input bias current can drive the inputs to a positive value that exceeds the operating common-mode input voltage and DOUT is permanently high, as described in the [Output Behavior in Case of Input Common-Mode Overage](#) section.

Connect the high-side ground (AGND) to INN, either by a hard short or through a resistive path. A DC current path between INN and AGND is required to define the input common-mode voltage. Take care not to exceed the input common-mode range as specified in the [Recommended Operating Conditions](#) table. For best accuracy, route the ground connection as a separate trace that connects directly to the shunt resistor rather than shorting AGND to INN directly at the input to the device. See the [Layout](#) section for more details.

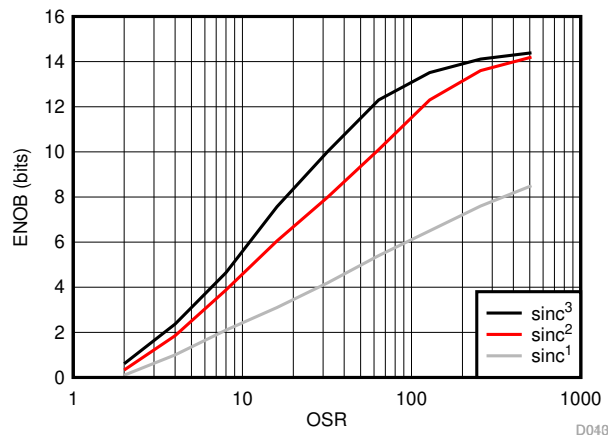
8.4 Power Supply Recommendations

The AMC1306M25E does not require any specific power-up sequencing. The high-side power supply (AVDD) is decoupled with a low-ESR, 100-nF capacitor (C1) parallel to a low-ESR, 1- μ F capacitor (C2). The low-side power supply (DVDD) is equally decoupled with a low-ESR, 100-nF capacitor (C3) parallel to a low-ESR, 1- μ F capacitor (C4). Place all four capacitors (C1, C2, C3, and C4) as close to the device as possible.

The ground reference for the high-side (AGND) is derived from the end of the shunt resistor that is connected to the negative input (INN) of the device. For best DC accuracy, use a separate trace to make this connection instead of shorting AGND to INN directly at the device input. If a four-terminal shunt is used, the device inputs are connected to the inner leads and AGND is connected to the outer lead on the INN-side of the shunt. [图 8-4](#) shows a decoupling diagram of the AMC1306M25E.



图 8-4. Decoupling of the AMC1306M25E

Capacitors must provide adequate effective capacitance under the applicable DC bias conditions they experience in the application. Multilayer ceramic capacitors (MLCC) typically exhibit only a fraction of their nominal capacitance under real-world conditions and this factor must be taken into consideration when selecting these capacitors. This problem is especially acute in low-profile capacitors, in which the dielectric field strength is higher than in taller components. Reputable capacitor manufacturers provide capacitance versus DC bias curves that greatly simplify component selection.

8.5 Layout

8.5.1 Layout Guidelines

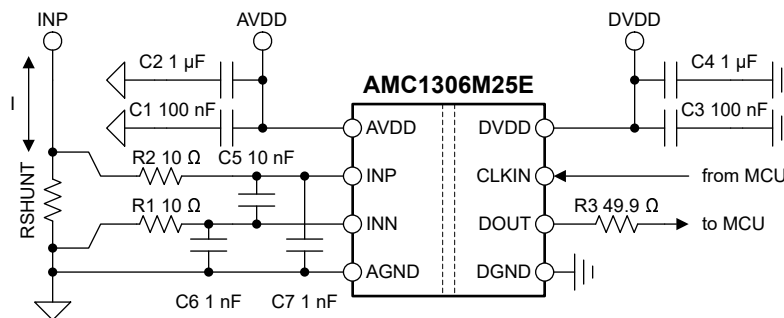
图 8-5 shows a layout recommendation with the critical placement of the decoupling capacitors (as close as possible to the AMC1306M25E supply pins) and placement of the other components required by the device. For best performance, place the shunt resistor close to the INP and INN inputs of the AMC1306M25E and keep the layout of both connections symmetrical.

8.5.2 Layout Example



图 8-5. Recommended Layout of the AMC1306M25E

9 Device and Documentation Support

9.1 Documentation Support

9.1.1 Related Documentation

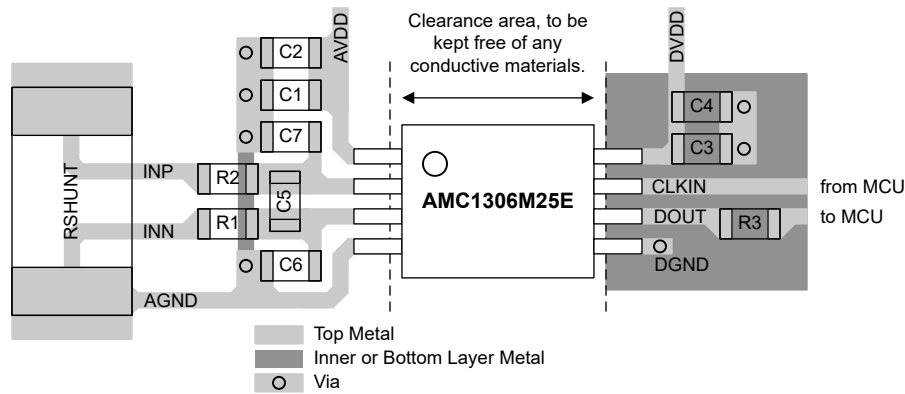
For related documentation see the following:

- Texas Instruments, [Isolation Glossary application report](#)
- Texas Instruments, [Semiconductor and IC Package Thermal Metrics application report](#)
- Texas Instruments, [ISO72x Digital Isolator Magnetic-Field Immunity application report](#)
- Texas Instruments, [Delta Sigma Modulator Filter Calculator design tool](#)

9.2 接收文档更新通知

要接收文档更新通知，请导航至 [ti.com](https://www.ti.com) 上的器件产品文件夹。点击 [订阅更新](#) 进行注册，即可每周接收产品信息更改摘要。有关更改的详细信息，请查看任何已修订文档中包含的修订历史记录。

9.3 支持资源

[TI E2E™ 支持论坛](#) 是工程师的重要参考资料，可直接从专家获得快速、经过验证的解答和设计帮助。搜索现有解答或提出自己的问题可获得所需的快速设计帮助。

链接的内容由各个贡献者“按原样”提供。这些内容并不构成 TI 技术规范，并且不一定反映 TI 的观点；请参阅 TI 的 [《使用条款》](#)。

9.4 Trademarks

C2000™, Sitara™, and TI E2E™ are trademarks of Texas Instruments.

所有商标均为其各自所有者的财产。

9.5 静电放电警告



静电放电 (ESD) 会损坏这个集成电路。德州仪器 (TI) 建议通过适当的预防措施处理所有集成电路。如果不遵守正确的处理和安装程序，可能会损坏集成电路。

ESD 的损坏小至导致微小的性能降级，大至整个器件故障。精密的集成电路可能更容易受到损坏，这是因为非常细微的参数更改都可能会导致器件与其发布的规格不相符。

9.6 术语表

[TI 术语表](#) 本术语表列出并解释了术语、首字母缩略词和定义。

10 Mechanical, Packaging, and Orderable Information

The following pages include mechanical, packaging, and orderable information. This information is the most current data available for the designated devices. This data is subject to change without notice and revision of this document. For browser-based versions of this data sheet, refer to the left-hand navigation.

PACKAGING INFORMATION

Orderable Device	Status (1)	Package Type	Package Drawing	Pins	Package Qty	Eco Plan (2)	Lead finish/ Ball material (6)	MSL Peak Temp (3)	Op Temp (°C)	Device Marking (4/5)	Samples
AMC1306M25EDWVR	ACTIVE	SOIC	DWV	8	1000	RoHS & Green	NIPDAU	Level-3-260C-168 HR	-55 to 125	1306M25E	Samples

(1) The marketing status values are defined as follows:

ACTIVE: Product device recommended for new designs.

LIFEBUY: TI has announced that the device will be discontinued, and a lifetime-buy period is in effect.

NRND: Not recommended for new designs. Device is in production to support existing customers, but TI does not recommend using this part in a new design.

PREVIEW: Device has been announced but is not in production. Samples may or may not be available.

OBsolete: TI has discontinued the production of the device.

(2) **RoHS:** TI defines "RoHS" to mean semiconductor products that are compliant with the current EU RoHS requirements for all 10 RoHS substances, including the requirement that RoHS substance do not exceed 0.1% by weight in homogeneous materials. Where designed to be soldered at high temperatures, "RoHS" products are suitable for use in specified lead-free processes. TI may reference these types of products as "Pb-Free".

RoHS Exempt: TI defines "RoHS Exempt" to mean products that contain lead but are compliant with EU RoHS pursuant to a specific EU RoHS exemption.

Green: TI defines "Green" to mean the content of Chlorine (Cl) and Bromine (Br) based flame retardants meet JS709B low halogen requirements of <=1000ppm threshold. Antimony trioxide based flame retardants must also meet the <=1000ppm threshold requirement.

(3) MSL, Peak Temp. - The Moisture Sensitivity Level rating according to the JEDEC industry standard classifications, and peak solder temperature.

(4) There may be additional marking, which relates to the logo, the lot trace code information, or the environmental category on the device.

(5) Multiple Device Markings will be inside parentheses. Only one Device Marking contained in parentheses and separated by a "~" will appear on a device. If a line is indented then it is a continuation of the previous line and the two combined represent the entire Device Marking for that device.

(6) Lead finish/Ball material - Orderable Devices may have multiple material finish options. Finish options are separated by a vertical ruled line. Lead finish/Ball material values may wrap to two lines if the finish value exceeds the maximum column width.

Important Information and Disclaimer: The information provided on this page represents TI's knowledge and belief as of the date that it is provided. TI bases its knowledge and belief on information provided by third parties, and makes no representation or warranty as to the accuracy of such information. Efforts are underway to better integrate information from third parties. TI has taken and continues to take reasonable steps to provide representative and accurate information but may not have conducted destructive testing or chemical analysis on incoming materials and chemicals. TI and TI suppliers consider certain information to be proprietary, and thus CAS numbers and other limited information may not be available for release.

In no event shall TI's liability arising out of such information exceed the total purchase price of the TI part(s) at issue in this document sold by TI to Customer on an annual basis.



DWV0008A

SOIC - 2.8 mm max height

SOIC

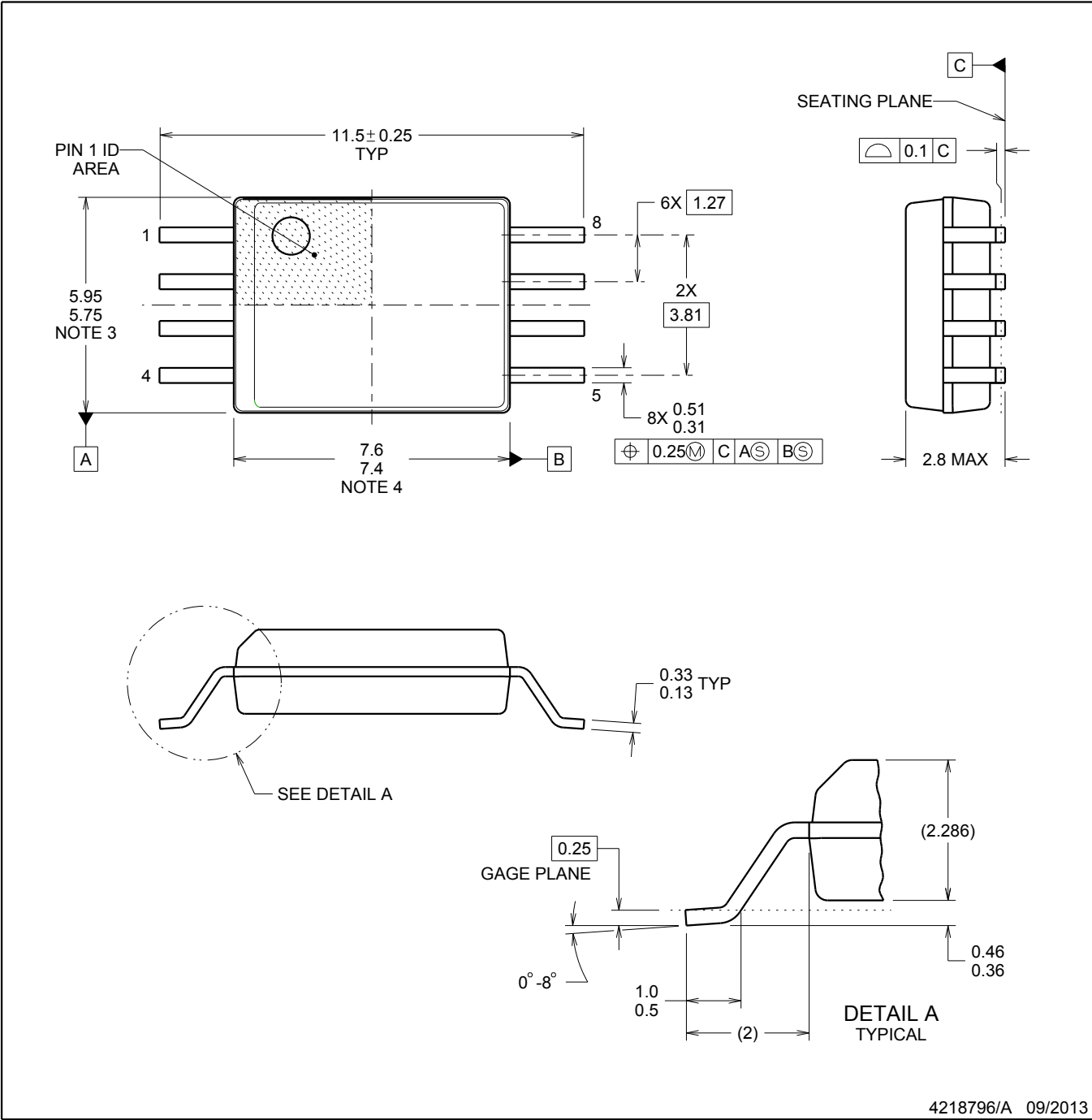

4218796/A 09/2013

NOTES:

1. All linear dimensions are in millimeters. Dimensions in parenthesis are for reference only. Dimensioning and tolerancing per ASME Y14.5M.
2. This drawing is subject to change without notice.
3. This dimension does not include mold flash, protrusions, or gate burrs. Mold flash, protrusions, or gate burrs shall not exceed 0.15 mm, per side.
4. This dimension does not include interlead flash. Interlead flash shall not exceed 0.25 mm, per side.

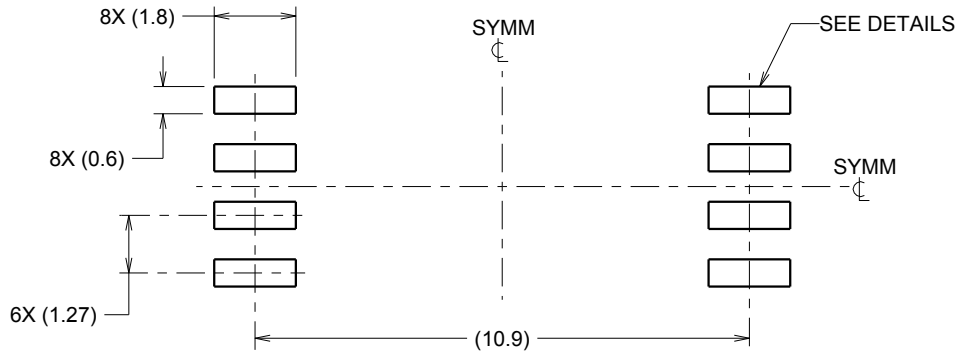

LAND PATTERN EXAMPLE
 9.1 mm NOMINAL CLEARANCE/CREEPAGE
 SCALE:6X

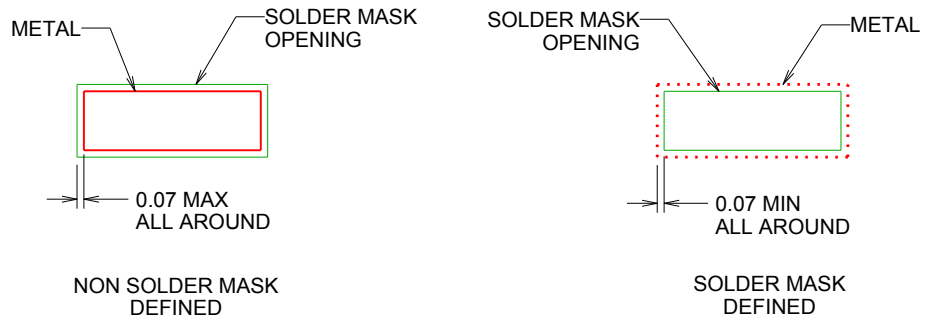

SOLDER MASK DETAILS

4218796/A 09/2013

NOTES: (continued)

- 5. Publication IPC-7351 may have alternate designs.
- 6. Solder mask tolerances between and around signal pads can vary based on board fabrication site.

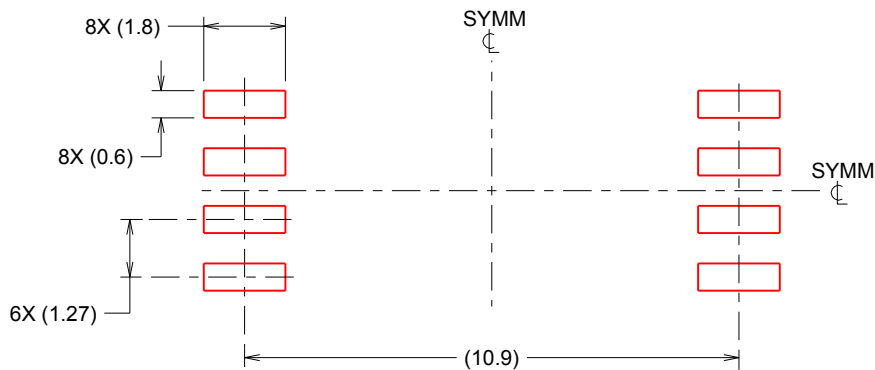

SOLDER PASTE EXAMPLE
 BASED ON 0.125 mm THICK STENCIL
 SCALE:6X

4218796/A 09/2013

NOTES: (continued)

- 7. Laser cutting apertures with trapezoidal walls and rounded corners may offer better paste release. IPC-7525 may have alternate design recommendations.
- 8. Board assembly site may have different recommendations for stencil design.

重要声明和免责声明

TI“按原样”提供技术和可靠性数据（包括数据表）、设计资源（包括参考设计）、应用或其他设计建议、网络工具、安全信息和其他资源，不保证没有瑕疵且不做任何明示或暗示的担保，包括但不限于对适销性、某特定用途方面的适用性或不侵犯任何第三方知识产权的暗示担保。

这些资源可供使用 TI 产品进行设计的熟练开发人员使用。您将自行承担以下全部责任：(1) 针对您的应用选择合适的 TI 产品，(2) 设计、验证并测试您的应用，(3) 确保您的应用满足相应标准以及任何其他功能安全、信息安全、监管或其他要求。

这些资源如有变更，恕不另行通知。TI 授权您仅可将这些资源用于研发本资源所述的 TI 产品的应用。严禁对这些资源进行其他复制或展示。您无权使用任何其他 TI 知识产权或任何第三方知识产权。您应全额赔偿因在这些资源的使用中对 TI 及其代表造成的任何索赔、损害、成本、损失和债务，TI 对此概不负责。

TI 提供的产品受 [TI 的销售条款](#) 或 [ti.com](#) 上其他适用条款/TI 产品随附的其他适用条款的约束。TI 提供这些资源并不会扩展或以其他方式更改 TI 针对 TI 产品发布的适用的担保或担保免责声明。

TI 反对并拒绝您可能提出的任何其他或不同的条款。

邮寄地址：Texas Instruments, Post Office Box 655303, Dallas, Texas 75265

Copyright © 2023，德州仪器 (TI) 公司