

双通道 12 位 500Mps 模数转换器

查询样品: [ADS5407](#)

特性

- 双通道
- **12 位分辨率**
- **最大时钟速率: 500Mps**
- **低摆幅满量程输入: 1.25Vpp**
- 支持高阻抗输入的模拟输入缓冲器
- **输入带宽 (3dB): >1.0GHz**
- **数据输出接口: 双倍速率 (DDR) 低压差分信号 (LVDS)**
- 具有低通或高通滤波器的可选 2 倍抽取
- **196 引脚球状引脚栅格阵列 (BGA) 封装 (12mm x 12mm)**

应用范围

- 测试和测量仪器
- 超宽波段软件定义无线电
- 数据采集
- 功率放大器线性化
- 信号智能和干扰
- 雷达和卫星系统
- 微波接收器

关键技术参数

- **功率耗散: 每通道 675mW (自动纠错被禁用)**
- **$f_{IN} = 230\text{MHz}$ IF 时的频谱性能**
 - **信噪比 (SNR): 63.7dBFS**
 - **无杂散动态范围 (SFDR):**
 - **77dBc (自动纠错禁用关闭)**
 - **75dBc (自动纠错禁用打开)**
- **$f_{IN} = 450\text{MHz}$ IF 时的频谱性能**
 - **SNR: 63.6dBFS**
 - **SFDR:**
 - **77dBc (自动纠错禁用关闭)**
 - **75dBc (自动纠错禁用打开)**

说明

ADS5407 是一款高线性双通道 12 位, 500MSPS 模数转换器 (ADC), 此器件简化了针对宽带接收器的前端滤波器设计。模拟输入缓冲器使片载跟踪保持的内部切换不会干扰信号源并提供一个高阻抗输入。可选择对输出数据进行 2 倍抽取。设计用于高 SFDR, 此 ADC 在宽输入频率范围内具有低噪声性能以及出色的无杂散动态范围。此器件采用 196 引脚 BGA 封装并且指定在整个工业温度范围内 (-40°C 至 85°C)。

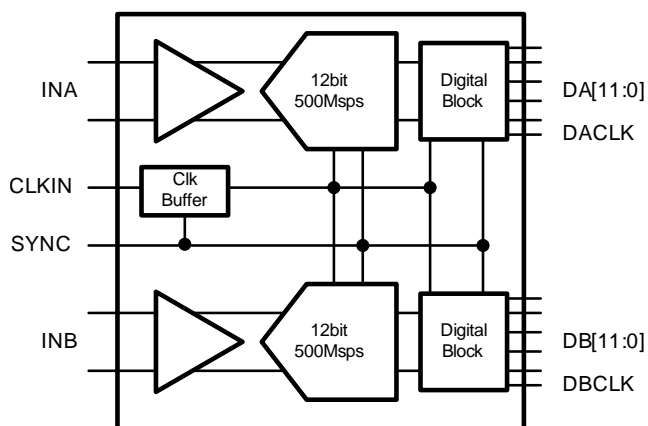

器件型号	通道数量	速度等级
ADS5402	2	800Mps
ADS5401	1	800Mps
ADS5404	2	500Mps
ADS5403	1	500Mps
ADS5407	2	500Mps
ADS5409	2	900Mps



Please be aware that an important notice concerning availability, standard warranty, and use in critical applications of Texas Instruments semiconductor products and disclaimers thereto appears at the end of this data sheet.



This integrated circuit can be damaged by ESD. Texas Instruments recommends that all integrated circuits be handled with appropriate precautions. Failure to observe proper handling and installation procedures can cause damage.

ESD damage can range from subtle performance degradation to complete device failure. Precision integrated circuits may be more susceptible to damage because very small parametric changes could cause the device not to meet its published specifications.

DETAILED BLOCK DIAGRAM

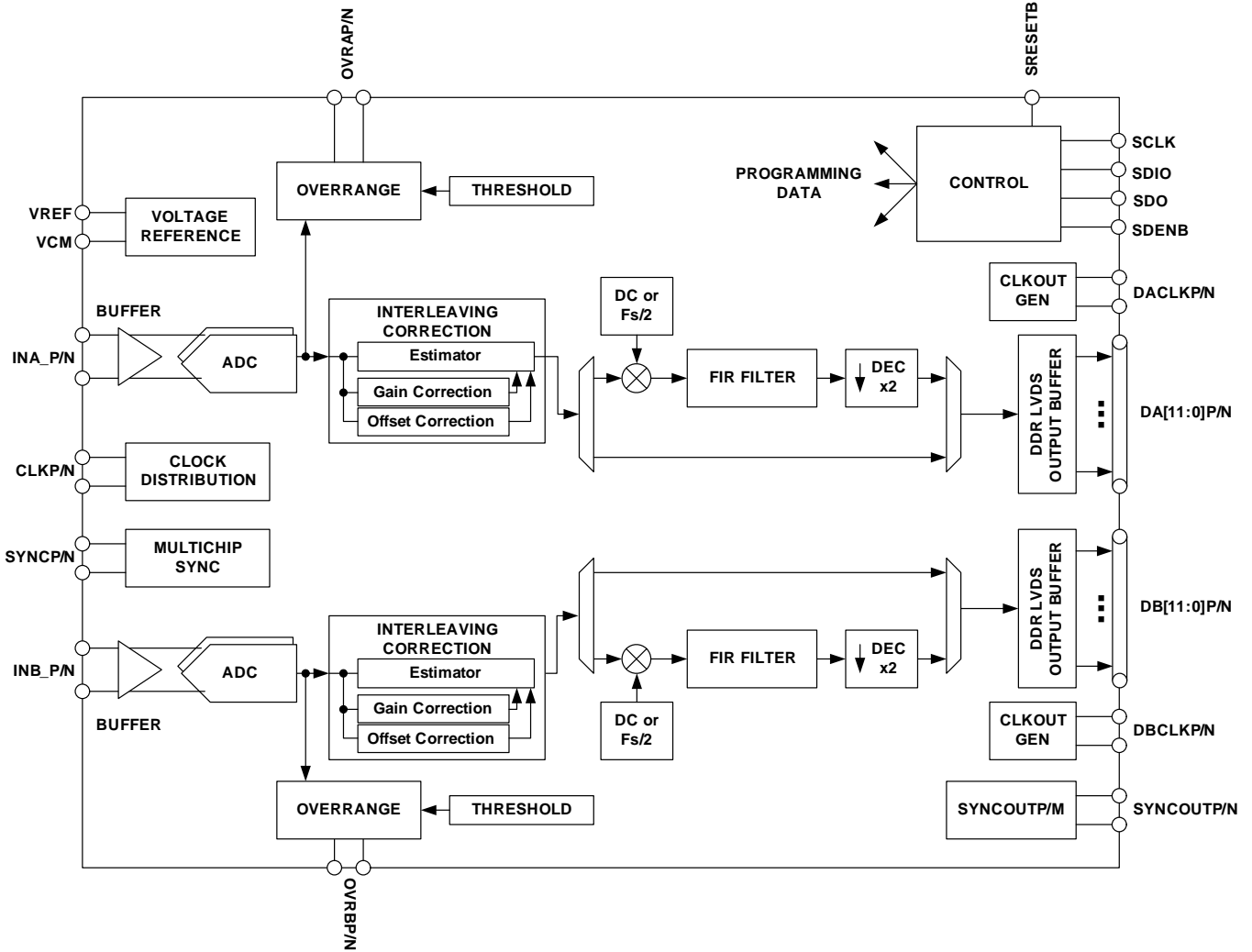

Figure 1. Detailed Block Diagram

PINOUT INFORMATION

	A	B	C	D	E	F	G	H	J	K	L	M	N	P	
14	VREF	VCM	GND	INB_N	INB_P	GND	AVDDC	AVDDC	GND	INA_P	INA_N	GND	GND	CLKINP	14
13	SDENB	TEST MODE	GND	GND	GND	GND	GND	GND	GND	GND	GND	GND	GND	CLKINN	13
12	SCLK	SRESET B	GND	AVDD33	AVDD33	AVDD33	AVDD33	AVDD33	AVDD33	AVDD33	AVDD33	GND	AVDD33	AVDD33	12
11	SDIO	ENABLE	GND	AVDD18	AVDD18	AVDD18	AVDD18	AVDD18	AVDD18	AVDD18	AVDD18	GND	AVDD18	AVDD18	11
10	SDO	IOVDD	GND	AVDD18	GND	GND	GND	GND	GND	GND	AVDD18	GND	NC	NC	10
9	DVDD	DVDD	GND	GND	GND	GND	GND	GND	GND	GND	GND	GND	SYNC	SYNCP	9
8	DVDD	DVDD	DVDD	DVDD	GND	GND	GND	GND	GND	GND	DVDD	DVDD	DVDD	DVDD	8
7	DB0N	DB0P	DVDD LVDS	DVDD LVDS	GND	GND	GND	GND	GND	GND	DVDD LVDS	DVDD LVDS	NC	NC	7
6	DB1N	DB1P	DVDD LVDS	DVDD LVDS	GND	GND	GND	GND	GND	GND	DVDD LVDS	DVDD LVDS	NC	NC	6
5	DB2N	DB2P	OVRBN	OVRBP	GND	GND	GND	GND	GND	GND	OVRAN	OVRAP	SYNC OUTN	SYNC OUTP	5
4	DB3N	DB3P	DB8P	DB10P	NC	NC	NC	DA0P	DA2P	DA4P	DA6P	DA8P	NC	NC	4
3	DB4N	DB4P	DB8N	DB10N	NC	NC	NC	DA0N	DA2N	DA4N	DA6N	DA8N	DA11N	DA11P	3
2	DB5N	DB5P	DB7P	DB9P	DB11P	SYNC OUTP	DBCLKP	DACLKP	DA1P	DA3P	DA5P	DA7P	DA10N	DA10P	2
1	DB6N	DB6P	DB7N	DB9N	DB11N	SYNC OUTN	DBCLKN	DACLKN	DA1N	DA3N	DA5N	DA7N	DA9N	DA9P	1
	A	B	C	D	E	F	G	H	J	K	L	M	N	P	

Figure 2. Pinout in DDR output mode (top down view)

PIN ASSIGNMENTS

PIN		I/O	DESCRIPTION
NAME	NUMBER		
INPUT/REFERENCE			
INA_P/N	K14, L14	I	Analog ADC A differential input signal.
INB_P/N	E14, D14	I	Analog ADC B differential input signal.
VCM	B14	O	Output of the analog input common mode (nominally 1.9V). A 0.1µF capacitor to AGND is recommended.
VREF	A14	O	Reference voltage output (2V nominal). A 0.1µF capacitor to AGND is recommended, but not required.
CLOCK/SYNC			
CLKINP/N	P14, P13	I	Differential input clock
SYNCP/N	P9, N9	I	Synchronization input. Inactive if logic low. When clocked in a high state initially, this is used for resetting internal clocks and digital logic and starting the SYNCOUT signal. Internal 100Ω termination.
CONTROL/SERIAL			

PIN ASSIGNMENTS (continued)

PIN		I/O	DESCRIPTION
NAME	NUMBER		
SRESET	B12	I	Serial interface reset input. Active low. Initialized internal registers during high to low transition. Asynchronous. Internal 50kΩ pull up resistor to IOVDD.
ENABLE	B11	I	Chip enable – active high. Power down function can be controlled through SPI register assignment. Internal 50kΩ pull up resistor to IOVDD.
SCLK	A12	I	Serial interface clock. Internal 50kΩ pull-down resistor.
SDIO	A11	I/O	Bi-directional serial data in 3 pin mode (default). In 4-pin interface mode (register x00, D16), the SDIO pin is an input only. Internal 50kΩ pull-down.
SDENB	A13	I	Serial interface enable. Internal 50kΩ pull-down resistor.
SDO	A10	O	Uni-directional serial interface data in 4 pin mode (register x00, D16). The SDO pin is tri-stated in 3-pin interface mode (default). Internal 50kΩ pull-down resistor.
TESTMODE	B13	–	Factory internal test, do not connect
DATA INTERFACE			
DA[11:0]P/N	P3, N3, P2, N2, P1, N1, M4, M3, M2, M1, L4, L3, L2, L1, K4, K3, K2, K1, J4, J3, J2, J1, H4, H3	O	ADC A Data Bits 11 (MSB) to 0 (LSB) in DDR output mode. Standard LVDS output.
DB[11:0]P/N	E2, E1, D4, D3, D2, D1, C4, C3, C2, C1, B1, A1, B2, A2, B3, A3, B4, A4, B5, A5, B6, A6, B7, A7	O	ADC B Data Bits 11 (MSB) to 0 (LSB) in DDR output mode. Standard LVDS output.
DACLKP/N	H2, H1	O	DDR differential output data clock for Bus A. Register programmable to provide either rising or falling edge to center of stable data nominal timing.
DBCLKP/N	G2, G1	O	DDR differential output data clock for Bus B. Register programmable to provide either rising or falling edge to center of stable data nominal timing. Optionally Bus B can be latched with DACLKP/N.
SYNCOUPT/N	F2, F1, P5, N5	O	Synchronization output signal for synchronizing multiple ADCs. Can be disabled via SPI.
OVRAP/N	M5, L5	O	Bus A, Overrange indicator, LVDS output. A logic high signals an analog input in excess of the full-scale range. Optional SYNC output.
OVRBP/N	D5, C5	O	Bus B, Overrange indicator, LVDS output. A logic high signals an analog input in excess of the full-scale range. Optional SYNC output.
NC	E3, E4, F3, F4, G3, G4, N4, N6, N7, N10, P4, P6, P7, P10	–	Don't connect to pin
POWER SUPPLY			
AVDD33	D12, E12, F12, G12, H12, J12, K12, L12, N12, P12	I	3.3V analog supply
AVDDC	G14, H14	I	1.8V supply for clock input
AVDD18	D10, D11, E11, F11, G11, H11, J11, K11, L10, L11, N11, P11	I	1.8V analog supply
DVDD	A8, A9, B8, B9, C8, D8, L8, M8, N8, P8	I	1.8V supply for digital block
DVDDLVD	C6, C7, D6, D7, L6, L7, M6, M7	I	1.8V supply for LVDS outputs
IOVDD	B10	I	1.8V for digital I/Os
GND		I	Ground

PACKAGE/ORDERING INFORMATION

PRODUCT	PACKAGE- LEAD	PACKAGE DESIGNATOR	SPECIFIED TEMPERATURE RANGE	PACKAGE MARKING	ORDERING NUMBER	TRANSPORT MEDIA, QUANTITY
ADS5407	196-BGA	ZAY	–40C to 85C	ADS5407I	ADS5407IZAY	Tray
					ADS5407IZAYR	Tape and Reel

ABSOLUTE MAXIMUM RATINGS

over operating free-air temperature range (unless otherwise noted)

	VALUE		UNIT	
	MIN	MAX		
Supply voltage range, AVDD33	–0.5	4	V	
Supply voltage range, AVDDC	–0.5	2.3	V	
Supply voltage range, AVDD18	–0.5	2.3	V	
Supply voltage range, DVDD	–0.5	2.3	V	
Supply voltage range, DVDDLVD	–0.5	2.3	V	
Supply voltage range, IOVDD	–0.5	4	V	
Voltage applied to input pins	INA/B_P, INA/B_N	–0.5	AVDD33 + 0.5	V
	CLKINP, CLKINN	–0.5	AVDDC + 0.5	V
	SYNCP, SYNCN	–0.5	AVDD33 + 0.5	V
	SRESET, SDENB, SCLK, SDIO, SDO, ENABLE	–0.5	IOVDD + 0.5	V
Operating free-air temperature range, T _A	–40	85	°C	
Operating junction temperature range, T _J		150	°C	
Storage temperature range	–65	150	°C	
ESD, Human Body Model		2	kV	

THERMAL INFORMATION

THERMAL METRIC ⁽¹⁾		ADS5407	UNITS
		nFBGA (196-PIN)	
θ_{JA}	Junction-to-ambient thermal resistance	37.6	°C/W
θ_{JCTop}	Junction-to-case (top) thermal resistance	6.8	
θ_{JB}	Junction-to-board thermal resistance	16.8	
ψ_{JT}	Junction-to-top characterization parameter	0.2	
ψ_{JB}	Junction-to-board characterization parameter	16.4	

 (1) For more information about traditional and new thermal metrics, see the *IC Package Thermal Metrics* application report, [SPRA953](#).

RECOMMENDED OPERATING CONDITIONS

over operating free-air temperature range (unless otherwise noted)

		MIN	NOM	MAX	UNIT
T _J	Recommended operating junction temperature			105	°C
	Maximum rated operating junction temperature ⁽¹⁾	125			
T _A	Recommended free-air temperature	–40	25	85	°C

(1) Prolonged use at this junction temperature may increase the device failure-in-time (FIT) rate.

ELECTRICAL CHARACTERISTICS

Typical values at $T_A = 25^\circ\text{C}$, full temperature range is $T_{\text{MIN}} = -40^\circ\text{C}$ to $T_{\text{MAX}} = 85^\circ\text{C}$, ADC sampling rate = 500MSPS, 50% clock duty cycle, AVDD33 = 3.3V, AVDDC/AVDD18/DVDD/DVDDLVS/IOVDD = 1.8V, –1dBFS differential input (unless otherwise noted).

PARAMETER		TEST CONDITIONS	MIN	TYP	MAX	UNITS
ADC Clock Frequency			40		500	MSPS
Resolution			12			Bits
SUPPLY						
AVDD33			3.15	3.3	3.45	V
AVDDC, AVDD18, DVDD, DVDDLVS			1.7	1.8	1.9	V
IOVDD			1.7	1.8	3.45	V
POWER SUPPLY						
I_{AVDD33}	3.3V Analog supply current			239	270	mA
I_{AVDD18}	1.8V Analog supply current			79	90	mA
I_{AVDDC}	1.8V Clock supply current			27	35	mA
I_{DVDD}	1.8V Digital supply current	Auto Correction Disabled		117	140	mA
I_{DVDD}	1.8V Digital supply current	Auto Correction Enabled		207		mA
I_{DVDD}	1.8V Digital supply current	Auto Correction Disabled, decimation filter enabled		142		mA
I_{DVDDLVS}	1.8V LVDS supply current	Unused LVDS outputs Disabled		104	120	mA
I_{IOVDD}	1.8V I/O Voltage supply current			1	2	mA
P_{dis}	Total power dissipation	Auto Correction Disabled, decimation filter disabled		1.35	1.5	W
PSRR		250kHz to 500MHz		40		dB
Shut-down power dissipation				7		mW
Shut-down wake up time				2.5		ms
Standby power dissipation				7		mW
Standby wake up time				100		μs
Deep-sleep mode power dissipation		Auto correction disabled		264		mW
		Auto correction enabled		371		mW
Deep-sleep mode wakeup time				20		μs
Light-sleep mode power dissipation		Auto correction disabled		559		mW
		Auto correction enabled		666		mW
Light-sleep mode wakeup time				2		μs

ELECTRICAL CHARACTERISTICS

Typical values at $T_A = 25^\circ\text{C}$, full temperature range is $T_{\text{MIN}} = -40^\circ\text{C}$ to $T_{\text{MAX}} = 85^\circ\text{C}$, ADC sampling rate = 500MSPS, 50% clock duty cycle, $\text{AVDD3V} = 3.3\text{V}$, $\text{AVDD/DRVDD/IOVDD} = 1.8\text{V}$, -1dBFS differential input (unless otherwise noted).

PARAMETER	TEST CONDITIONS	MIN	TYP	MAX	UNITS
ANALOG INPUTS					
Differential input full-scale			1.0 1.25		V _{pp}
Input common mode voltage			1.9 ±0.1		V
Input resistance	Differential at DC		1		kΩ
Input capacitance	Each input to GND		2		pF
VCM common mode voltage output			1.9		V
Analog input bandwidth (3dB)			1000		MHz
DYNAMIC ACCURACY					
Offset Error	Auto Correction Disabled	-20	±4	20	mV
	Auto Correction Enabled	-1	0	1	mV
Offset temperature coefficient			-611		μV/°C
Gain error		-5	±0.6	5	%FS
Gain temperature coefficient			0.005		%FS/°C
Differential nonlinearity	$f_{\text{IN}} = 230\text{ MHz}$	-1	±0.8	2	LSB
Integral nonlinearity	$f_{\text{IN}} = 230\text{ MHz}$	-5	±2	5	LSB
CLOCK INPUT					
Input clock frequency		40		500	MHz
Input clock amplitude			2		V _{pp}
Input clock duty cycle		40%	50%	60%	
Internal clock biasing			0.9		V

ELECTRICAL CHARACTERISTICS

Typical values at $T_A = 25^\circ\text{C}$, full temperature range is $T_{\text{MIN}} = -40^\circ\text{C}$ to $T_{\text{MAX}} = 85^\circ\text{C}$, ADC sampling rate = 500MSPS, 50% clock duty cycle, AVDD33 = 3.3V, AVDDC/AVDD18/DVDD/DVDDLVD/IOVDD = 1.8V, -1dBFS differential input (unless otherwise noted).

PARAMETER		TEST CONDITIONS	MIN	TYP	MAX	MIN	TYP	MAX	UNITS
Auto Correction			Enabled			Disabled			Vpp
DYNAMIC AC CHARACTERISTICS⁽¹⁾ – Vref = 1.25V									
SNR	Signal to Noise Ratio	$f_{\text{IN}} = 10 \text{ MHz}$		63.6			63.8		dBFS
		$f_{\text{IN}} = 100 \text{ MHz}$		63.5			63.7		
		$f_{\text{IN}} = 230 \text{ MHz}$		63.5	61.5		63.7		
		$f_{\text{IN}} = 450 \text{ MHz}$		63.1			63.6		
		$f_{\text{IN}} = 700 \text{ MHz}$		62.5			63.2		
HD2,3	Second and third harmonic distortion	$f_{\text{IN}} = 10 \text{ MHz}$		84			81		dBc
		$f_{\text{IN}} = 100 \text{ MHz}$		84			83		
		$f_{\text{IN}} = 230 \text{ MHz}$		76	55		77		
		$f_{\text{IN}} = 450 \text{ MHz}$		82			84		
		$f_{\text{IN}} = 700 \text{ MHz}$		74			74		
Non HD2,3	Spur Free Dynamic Range (excluding second, third harmonic distortion and Fs/2-Fin spur)	$f_{\text{IN}} = 10 \text{ MHz}$		78			79		dBc
		$f_{\text{IN}} = 100 \text{ MHz}$		78			79		
		$f_{\text{IN}} = 230 \text{ MHz}$		76	70		77		
		$f_{\text{IN}} = 450 \text{ MHz}$		76			77		
		$f_{\text{IN}} = 700 \text{ MHz}$		72			72		
IL	Fs/2-Fin interleaving spur	$f_{\text{IN}} = 10 \text{ MHz}$		90			87		dBc
		$f_{\text{IN}} = 100 \text{ MHz}$		86			85		
		$f_{\text{IN}} = 230 \text{ MHz}$		83	60		80		
		$f_{\text{IN}} = 450 \text{ MHz}$		81			80		
		$f_{\text{IN}} = 700 \text{ MHz}$		77			77		
SINAD	Signal to noise and distortion ratio	$f_{\text{IN}} = 10 \text{ MHz}$		63.4			63.6		dBFS
		$f_{\text{IN}} = 100 \text{ MHz}$		63.3			63.5		
		$f_{\text{IN}} = 230 \text{ MHz}$		63.1	55		63.4		
		$f_{\text{IN}} = 450 \text{ MHz}$		62.8			63.0		
		$f_{\text{IN}} = 700 \text{ MHz}$		61.8			62.4		
THD	Total Harmonic Distortion	$f_{\text{IN}} = 10 \text{ MHz}$		77			77		dBc
		$f_{\text{IN}} = 100 \text{ MHz}$		76			77		
		$f_{\text{IN}} = 230 \text{ MHz}$		74	54		74		
		$f_{\text{IN}} = 450 \text{ MHz}$		75			75		
		$f_{\text{IN}} = 700 \text{ MHz}$		70			70		
IMD3	Inter modulation distortion	$f_{\text{IN}} = 129.5 \text{ and } 130.5 \text{ MHz, } -7 \text{ dBFS}$		83			83		dBFS
		$f_{\text{IN}} = 349.5 \text{ and } 350.5 \text{ MHz, } -7 \text{ dBFS}$		80			78		
	Crosstalk			90			90		dB
ENOB	Effective number of bits	$f_{\text{IN}} = 230 \text{ MHz}$		10.2			10.3		Bit

(1) SNR calculations do not include the DC, Fs/2 and Fs/2-fin bins when Auto correction is disabled.

ELECTRICAL CHARACTERISTICS

Typical values at $T_A = 25^\circ\text{C}$, full temperature range is $T_{\text{MIN}} = -40^\circ\text{C}$ to $T_{\text{MAX}} = 85^\circ\text{C}$, ADC sampling rate = 500MSPS, 50% clock duty cycle, AVDD33 = 3.3V, AVDDC/AVDD18/DVDD/DVDDLVD/IOVDD = 1.8V, –1dBFS differential input (unless otherwise noted).

PARAMETER	TEST CONDITIONS	MIN	TYP	MAX	UNITS
OVER-DRIVE RECOVERY ERROR					
Input overload recovery	Recovery to within 5% (of final value) for 6dB overload with sine wave input		2		ns
SAMPLE TIMING CHARACTERISTICS					
rms Aperture Jitter	Sample uncertainty		100		fs rms
Data Latency	ADC sample to digital output, auto correction disabled		38		Clock Cycles
	ADC sample to digital output, auto correction enabled		50		
	ADC sample to digital output, Decimation filter enabled, Auto correction disabled		74		Sampling clock Cycles
Over-range Latency	ADC sample to over-range output		12		Clock Cycles

ELECTRICAL CHARACTERISTICS

The DC specifications refer to the condition where the digital outputs are not switching, but are permanently at a valid logic level 0 or 1. AVDD33 = 3.3V, AVDDC/AVDD18/DVDD/DVDDLVD/IOVDD = 1.8V

PARAMETER	TEST CONDITIONS	MIN	TYP	MAX	UNITS	
DIGITAL INPUTS – SRESET, SCLK, SDENB, SDIO, ENABLE						
High-level input voltage	All digital inputs support 1.8V and 3.3V logic levels.	0.7 x IOVDD			V	
Low-level input voltage				0.3 x IOVDD	V	
High-level input current		–50		200	μA	
Low-level input current		–50		50	μA	
Input capacitance			5		pF	
DIGITAL OUTPUTS – SDO						
High-level output voltage	$I_{\text{Load}} = -100\mu\text{A}$	IOVDD – 0.2			V	
	$I_{\text{Load}} = -2\text{mA}$	0.8 x IOVDD				
Low-level output voltage	$I_{\text{Load}} = 100\mu\text{A}$			0.2	V	
	$I_{\text{Load}} = 2\text{mA}$			0.22 x IOVDD		
DIGITAL INPUTS – SYNC/P/N, TRIGGER/P/N						
V_{ID}	Differential input voltage	250	350	450	mV	
V_{CM}	Input common mode voltage	1.125	1.2	1.375	V	
t_{SU}		500			ps	
DIGITAL OUTPUTS – DA[11:0]P/N, DACLK/P/N, OVRAP/N, SYNCOUTP/N, TRDYP/N, HRESP/N, DB[11:0]P/N, DBCLK/P/N, OVRBP/N,						
V_{OD}	Output differential voltage	$I_{\text{OUT}} = 3.5\text{mA}$	250	350	450	mV
V_{OCM}	Output common mode voltage	$I_{\text{OUT}} = 3.5\text{mA}$	1.125	1.25	1.375	V
t_{SUA}	$F_s = 500\text{MSPS}$	Data valid to zero-crossing of DACLK	600	800		ps
t_{hA}	$F_s = 500\text{MSPS}$	Zero-crossing of DACLK to data becoming invalid	600	790		ps
t_{SUB}	$F_s = 500\text{MSPS}$	Data valid to zero-crossing of DBCLK	700	900		ps
t_{hB}	$F_s = 500\text{MSPS}$	Zero-crossing of DBCLK to data becoming invalid	500	600		ps
t_{PD}	$F_s = 500\text{MSPS}$	CLKIN falling edge to DACLK, DBCLK rising edge	3.28	3.48	3.74	ns

ELECTRICAL CHARACTERISTICS (continued)

The DC specifications refer to the condition where the digital outputs are not switching, but are permanently at a valid logic level 0 or 1. AVDD33 = 3.3V, AVDDC/AVDD18/DVDD/DVDDL/VDS/IOVDD = 1.8V

PARAMETER	TEST CONDITIONS	MIN	TYP	MAX	UNITS
t _{RISE}	10% - 90%	100	150	200	ps
t _{FALL}	90% - 10%	100	150	200	ps

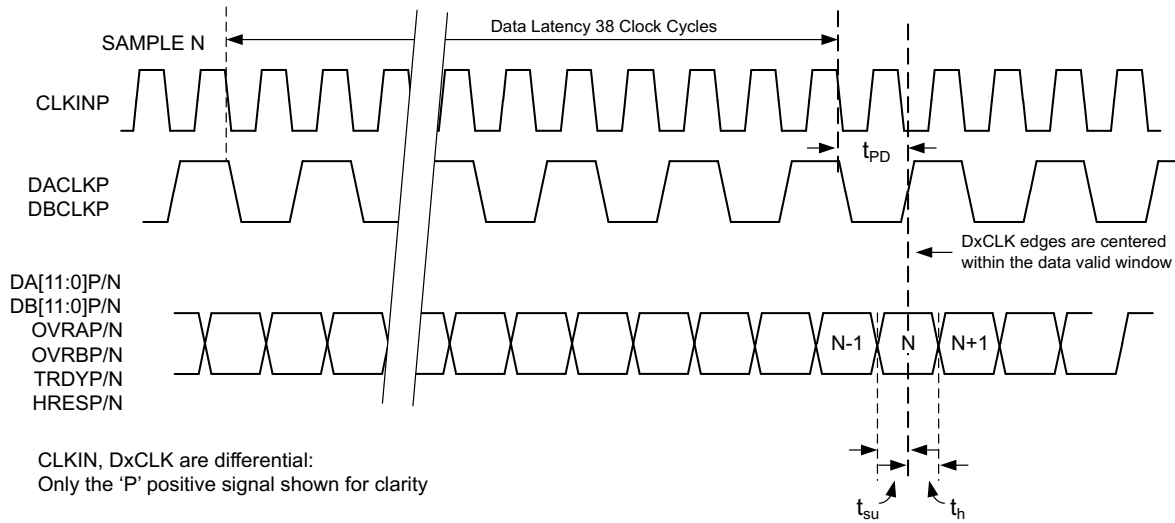

Figure 3. Timing Diagram for 12-bit DDR Output

TYPICAL CHARACTERISTICS

Typical values at TA = +25°C, full temperature range is T_{MIN} = -40°C to T_{MAX} = +85°C, ADC sampling rate = 500Mps, 50% clock duty cycle, AVDD33 = 3.3V, AVDDC/AVDD18/DVDD/DVDDLVS/IOVDD = 1.8V, Vref = 1.25V, -1dBFS differential input, unless otherwise noted.

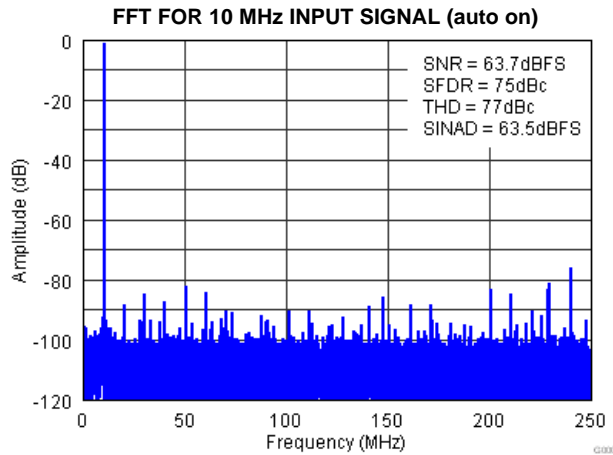

Figure 4.

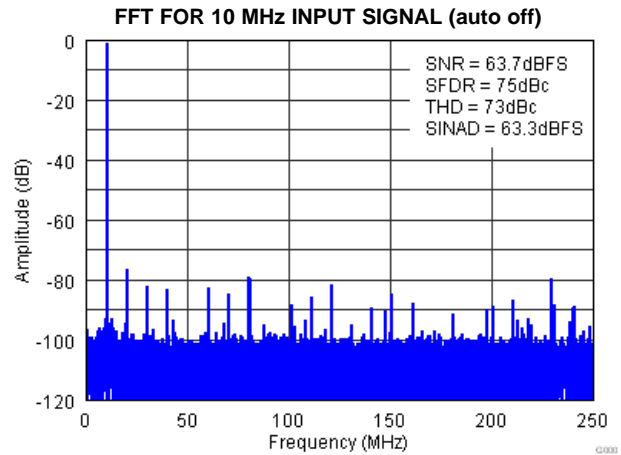

Figure 5.

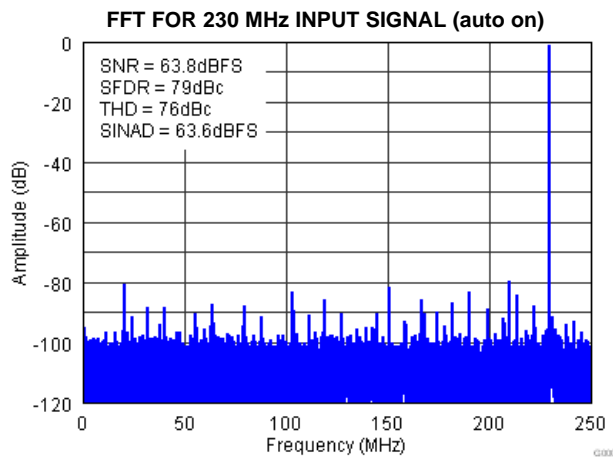

Figure 6.

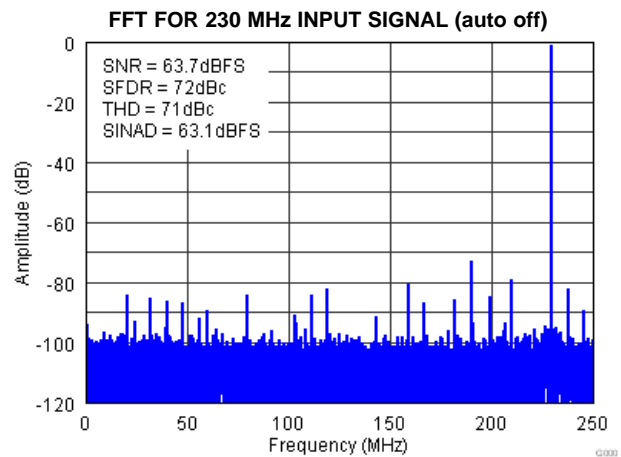

Figure 7.

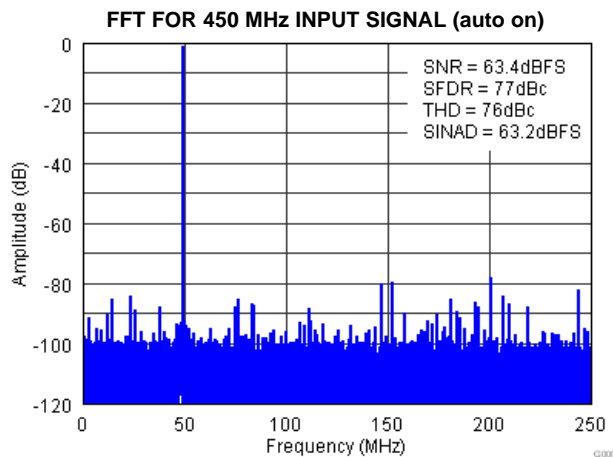

Figure 8.

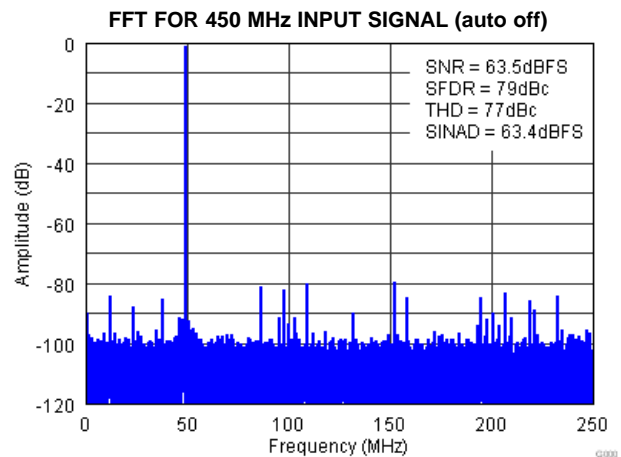

Figure 9.

TYPICAL CHARACTERISTICS (continued)

Typical values at TA = +25°C, full temperature range is T_{MIN} = -40°C to T_{MAX} = +85°C, ADC sampling rate = 500Mps, 50% clock duty cycle, AVDD33 = 3.3V, AVDDC/AVDD18/DVDD/DVDDLVS/IOVDD = 1.8V, Vref = 1.25V, -1dBFS differential input, unless otherwise noted.

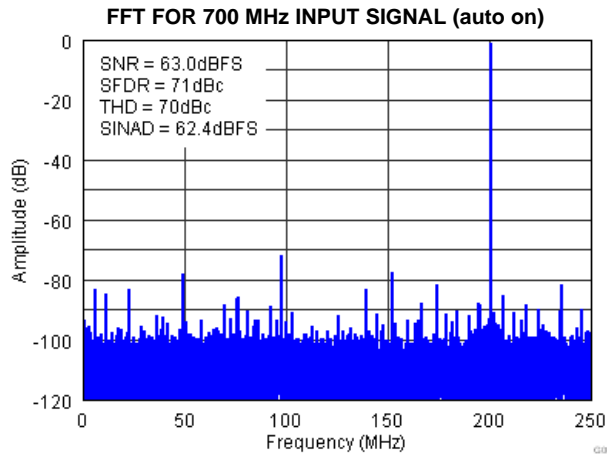

Figure 10.

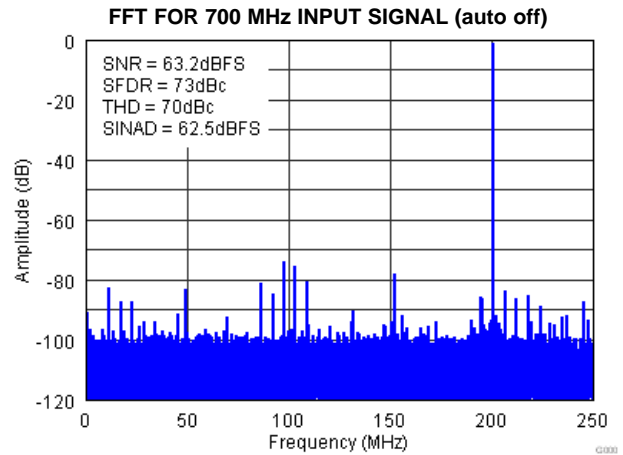

Figure 11.

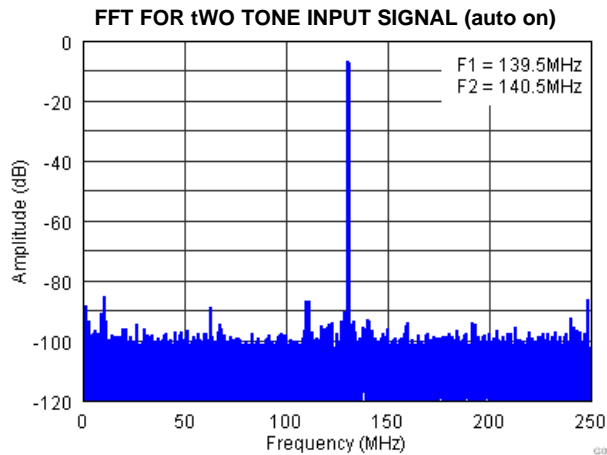

Figure 12.

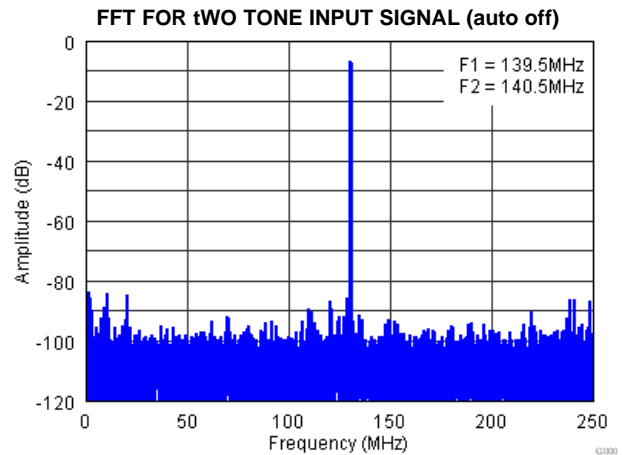

Figure 13.

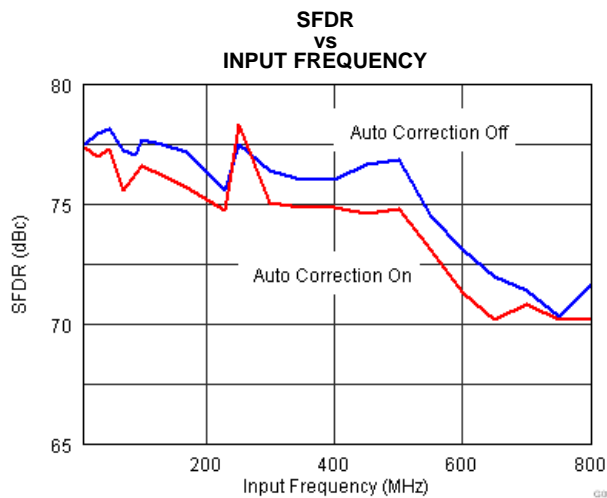

Figure 14.

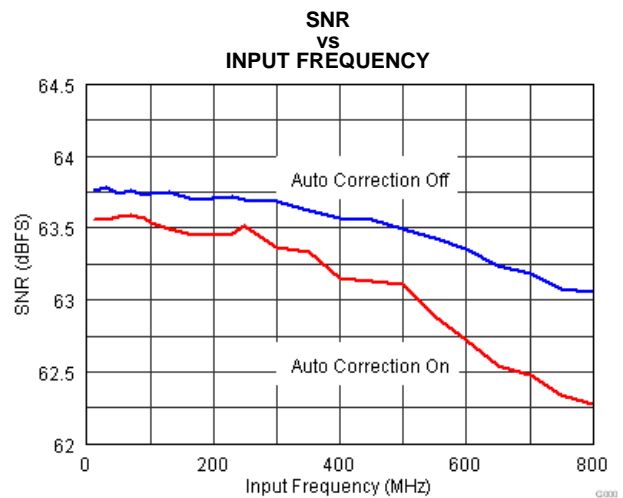

Figure 15.

TYPICAL CHARACTERISTICS (continued)

Typical values at TA = +25°C, full temperature range is T_{MIN} = -40°C to T_{MAX} = +85°C, ADC sampling rate = 500Msps, 50% clock duty cycle, AVDD33 = 3.3V, AVDDC/AVDD18/DVDD/DVDDLVS/IOVDD = 1.8V, Vref = 1.25V, -1dBFS differential input, unless otherwise noted.

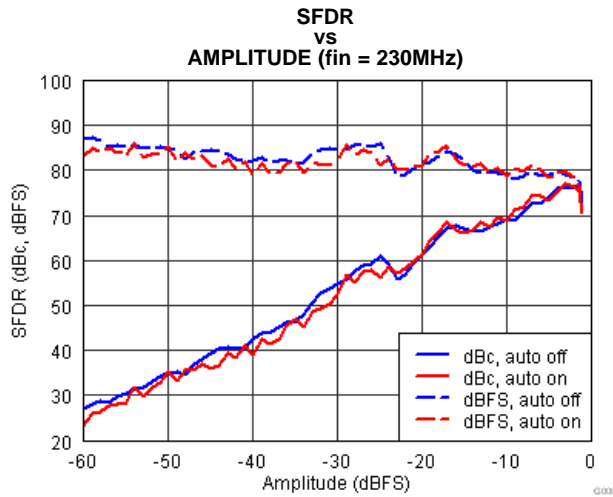

Figure 16.

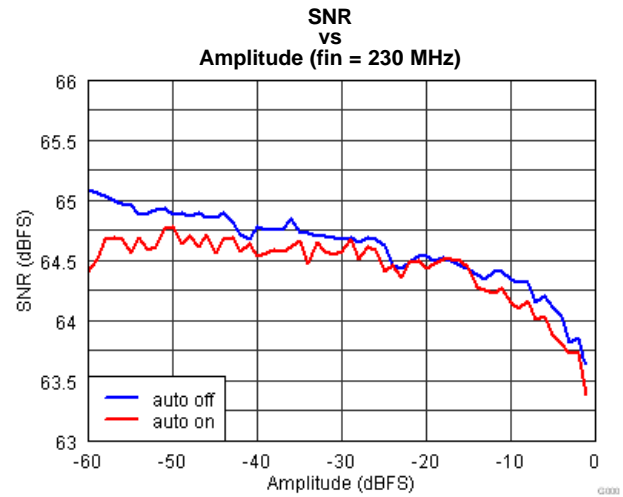

Figure 17.

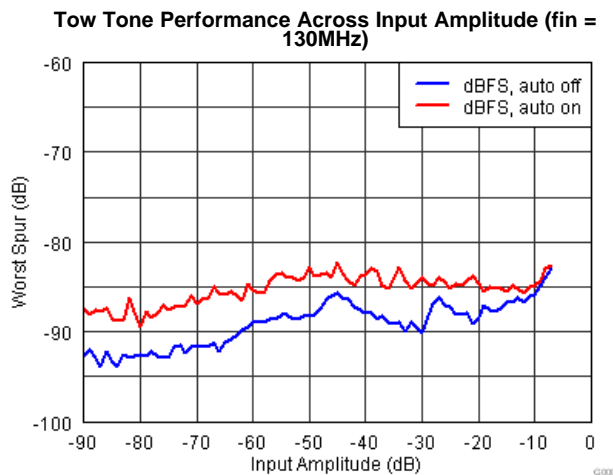

Figure 18.

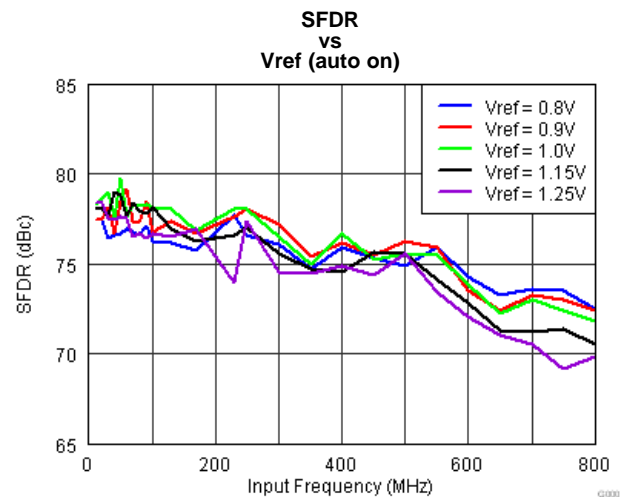

Figure 19.

TYPICAL CHARACTERISTICS (continued)

Typical values at TA = +25°C, full temperature range is T_{MIN} = -40°C to T_{MAX} = +85°C, ADC sampling rate = 500Mpsps, 50% clock duty cycle, AVDD33 = 3.3V, AVDDC/AVDD18/DVDD/DVDDLVS/IOVDD = 1.8V, Vref = 1.25V, -1dBFS differential input, unless otherwise noted.

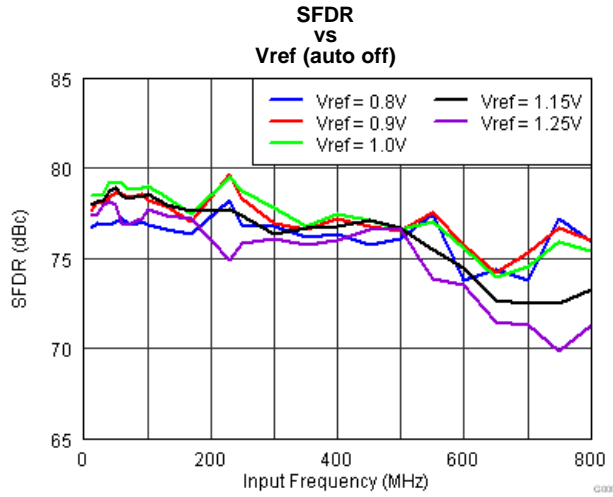

Figure 20.

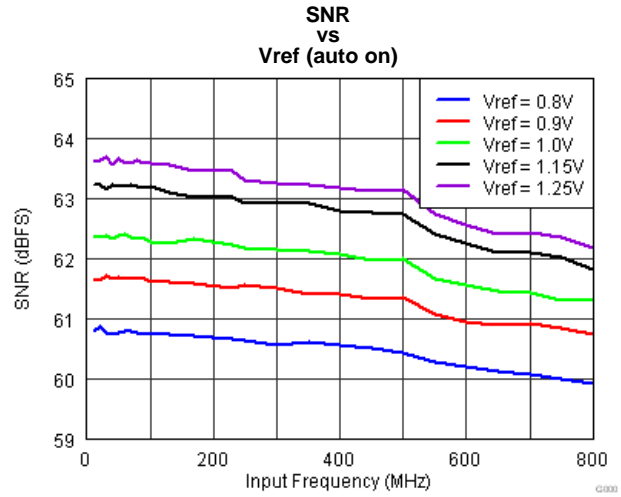

Figure 21.

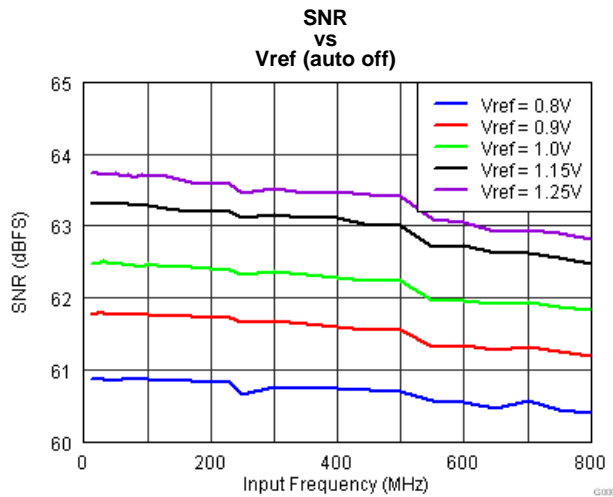

Figure 22.

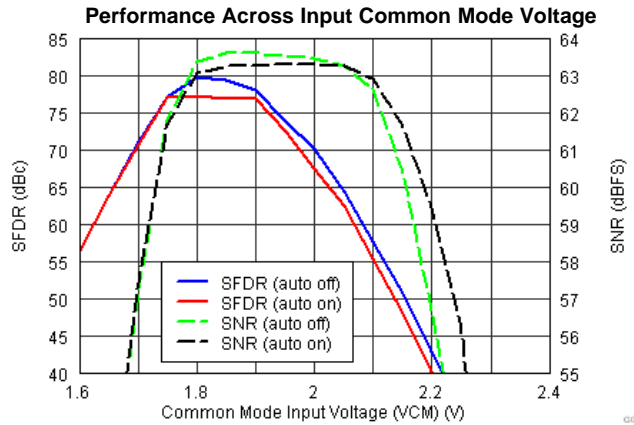

Figure 23.

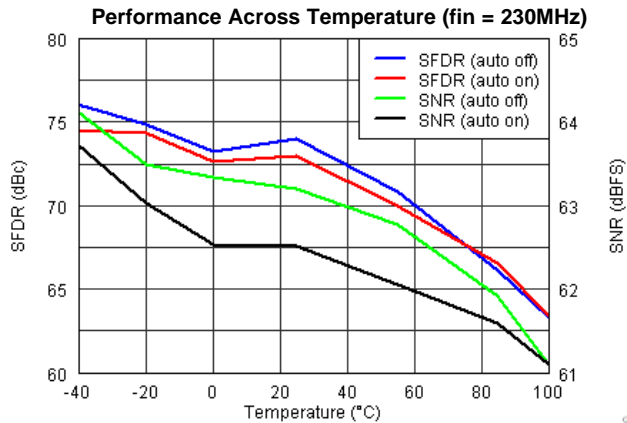

Figure 24.

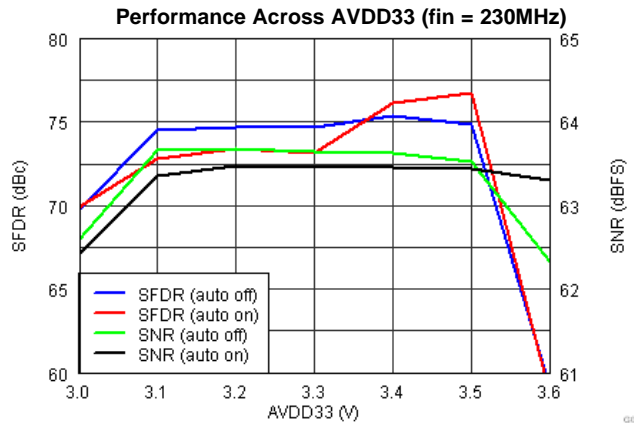

Figure 25.

TYPICAL CHARACTERISTICS (continued)

Typical values at TA = +25°C, full temperature range is T_{MIN} = -40°C to T_{MAX} = +85°C, ADC sampling rate = 500Mps, 50% clock duty cycle, AVDD33 = 3.3V, AVDDC/AVDD18/DVDD/DVDDLVS/IOVDD = 1.8V, Vref = 1.25V, -1dBFS differential input, unless otherwise noted.

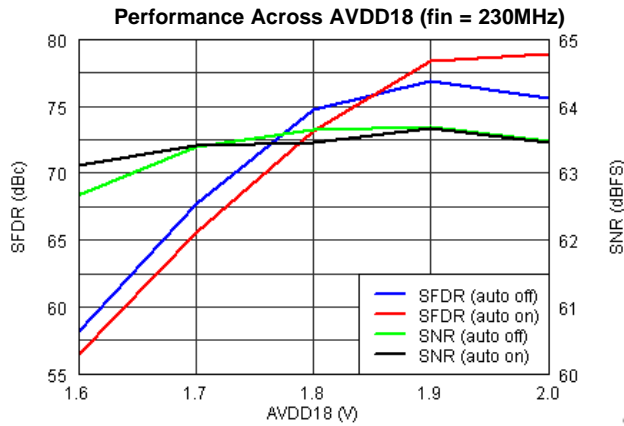

Figure 26.

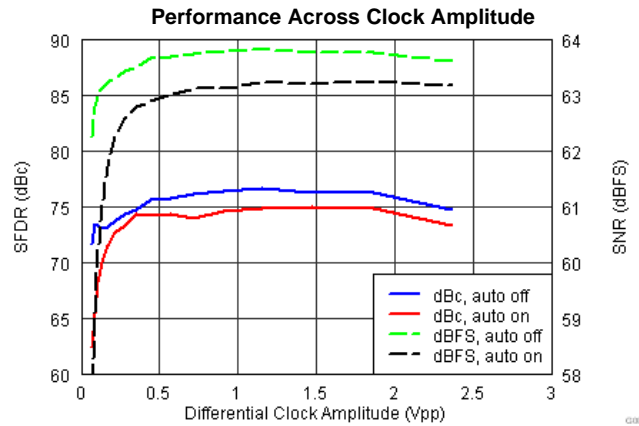

Figure 27.

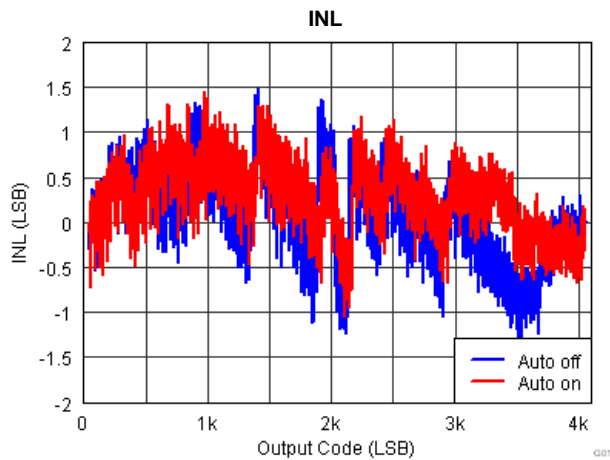

Figure 28.

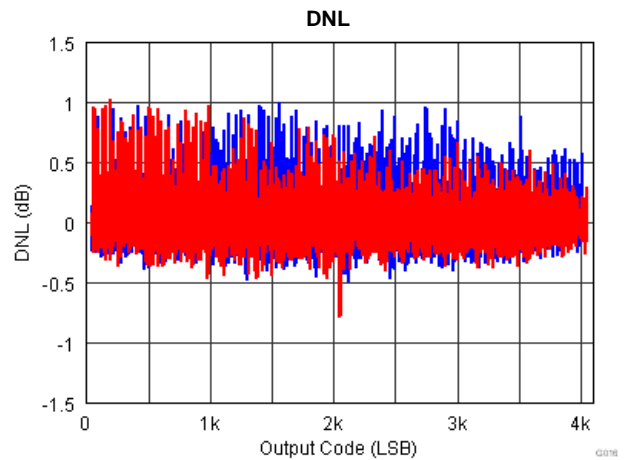

Figure 29.

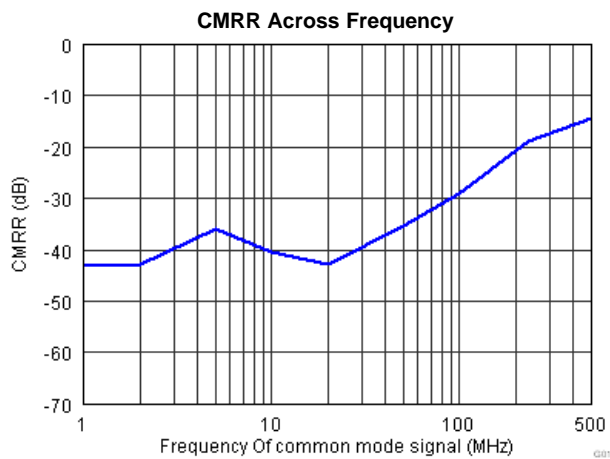

Figure 30.

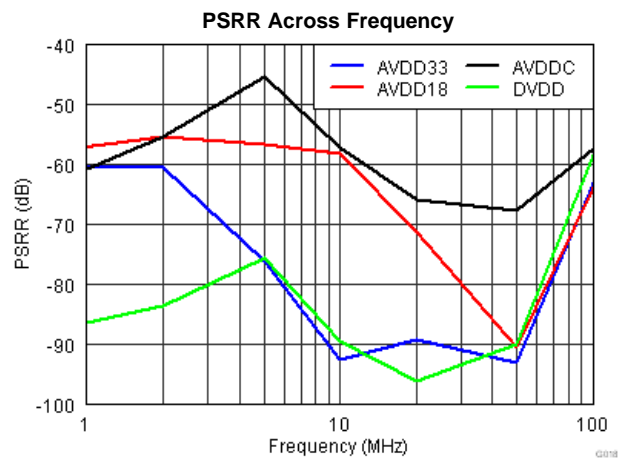

Figure 31.

TYPICAL CHARACTERISTICS (continued)

Typical values at TA = +25°C, full temperature range is T_{MIN} = -40°C to T_{MAX} = +85°C, ADC sampling rate = 500Mps, 50% clock duty cycle, AVDD33 = 3.3V, AVDDC/AVDD18/DVDD/DVDDLVD5/IOVDD = 1.8V, Vref = 1.25V, -1dBFS differential input, unless otherwise noted.

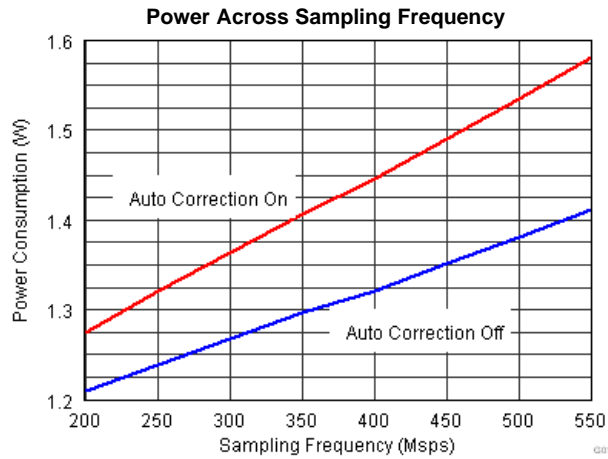

Figure 32.

SFDR Across Input and Sampling Frequencies (auto on)

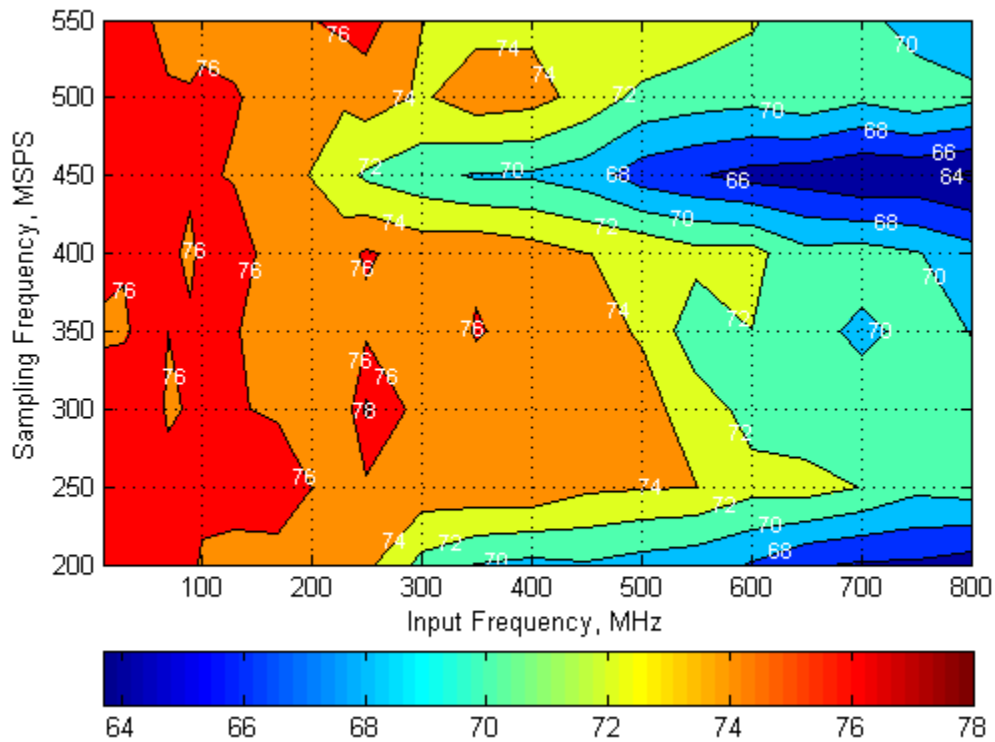

Figure 33.

TYPICAL CHARACTERISTICS (continued)

Typical values at TA = +25°C, full temperature range is T_{MIN} = -40°C to T_{MAX} = +85°C, ADC sampling rate = 500MSPS, 50% clock duty cycle, AVDD33 = 3.3V, AVDDC/AVDD18/DVDD/DVDDLVD5/IOVDD = 1.8V, Vref = 1.25V, -1dBFS differential input, unless otherwise noted.

SFDR Across Input and Sampling Frequencies (auto off)

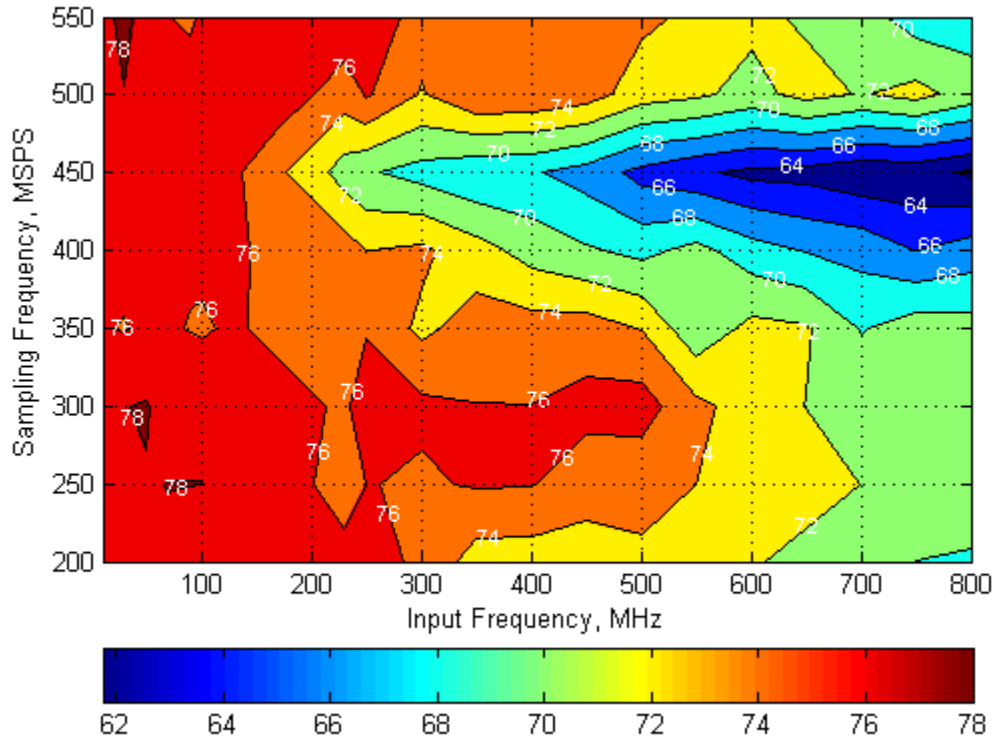

Figure 34.

TYPICAL CHARACTERISTICS (continued)

Typical values at TA = +25°C, full temperature range is T_{MIN} = -40°C to T_{MAX} = +85°C, ADC sampling rate = 500Mpsps, 50% clock duty cycle, AVDD33 = 3.3V, AVDDC/AVDD18/DVDD/DVDDLVD5/IOVDD = 1.8V, Vref = 1.25V, -1dBFS differential input, unless otherwise noted.

SNR Across Input and Sampling Frequencies (auto on)

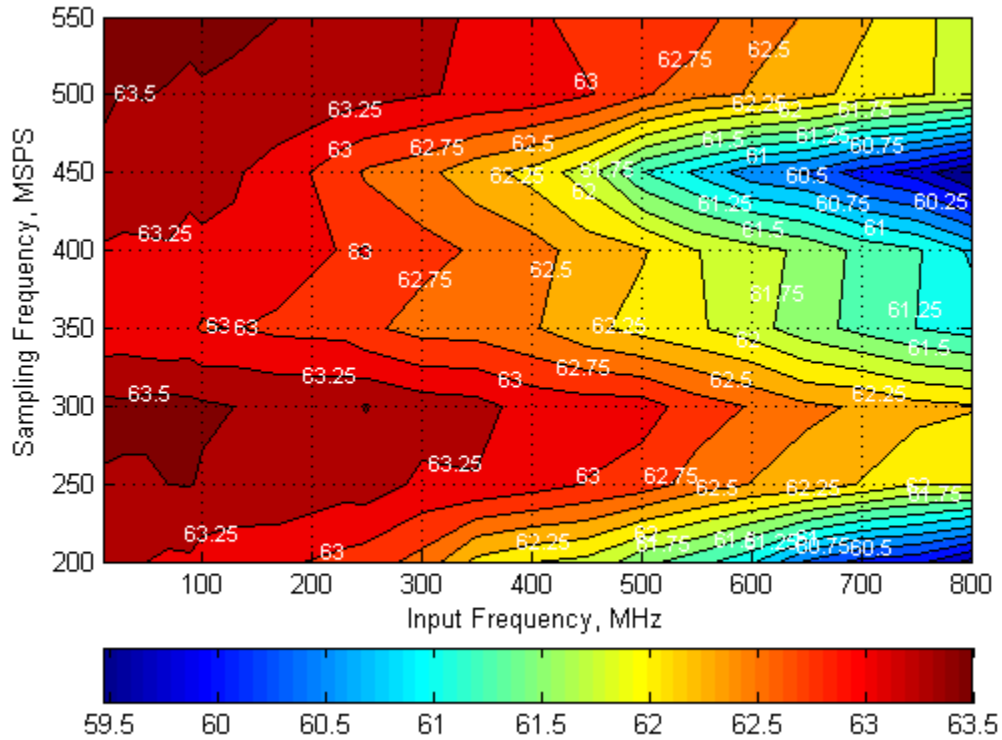

Figure 35.

TYPICAL CHARACTERISTICS (continued)

Typical values at TA = +25°C, full temperature range is T_{MIN} = -40°C to T_{MAX} = +85°C, ADC sampling rate = 500Mpsps, 50% clock duty cycle, AVDD33 = 3.3V, AVDDC/AVDD18/DVDD/DVDDLVD/IOVDD = 1.8V, Vref = 1.25V, -1dBFS differential input, unless otherwise noted.

SNR Across Input and Sampling Frequencies (auto on)

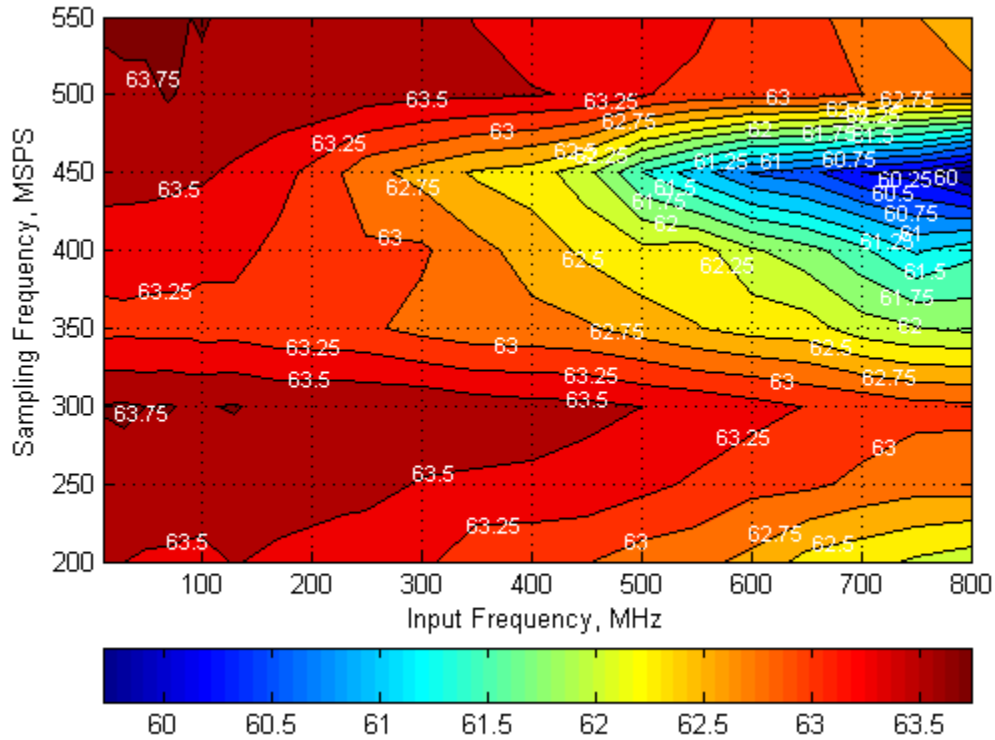

Figure 36.

FEATURES

POWER DOWN MODES

The ADS5407 can be configured via SPI write (address x37) to a stand-by, light or deep sleep power mode which is controlled by the ENABLE pin. The sleep modes are active when the ENABLE pin goes low. Different internal functions stay powered up which results in different power consumption and wake up time between the two sleep modes.

Sleep mode	Wake up time	Power Consumption Auto Correction Disabled	Power Consumption Auto Correction Enabled
Complete Shut Down	2.5 ms	7mW	7mW
Stand-by	100µs	7mW	7mW
Deep Sleep	20µs	264mW	371mW
Light Sleep	2µs	559mW	666mW

TEST PATTERN OUTPUT

The ADS5407 can be configured to output different test patterns that can be used to verify the digital interface is connected and working properly.

To enable the test pattern mode, the high performance mode 1 has to be disabled first via SPI register write. Then different test patterns can be selected by configuring registers x3C, x3D and x3E. All three registers must be configured for the test pattern to work properly.

First set HP1 = 0 (Addr 0x01, D01)

Register Address	All 0s	All 1s	Toggle (0xAAA => 0x555)	Toggle (0xFF F => 0x000)
0x3C	0x8000	0xBFFC	0x9554	0xBFFC
0x3D	0x0000	0x3FFC	0x2AA8	0x0000
0x3E	0x0000	0x3FFC	0x1554	0x3FFC

Register Address	Custom Pattern															
	D15	D14	D13	D12	D11	D10	D9	D8	D7	D6	D5	D4	D3	D2	D1	D0
x3C	1	0	D11	D10	D9	D8	D7	D6	D5	D4	D3	D2	D1	D0	0	0
x3D	0	0													0	0
x3E	0	0													0	0

For normal operation, set HP1 = 1 (Addr 0x01, D01) and 0x3C, 0x3D, 0x3E all to 0.

CLOCK INPUT

The ADS5407 clock input can be driven differentially with a sine wave, LVPECL or LVDS source with little or no difference in performance. The common mode voltage of the clock input is set to 0.9V using internal 2kΩ resistors. This allows for AC coupling of the clock inputs. The termination resistors should be placed as close as possible to the clock inputs in order to minimize signal reflections and jitter degradation.

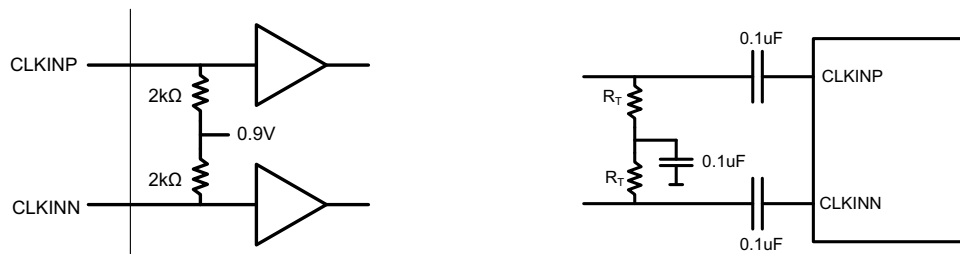

Recommended differential clock driving circuit

Figure 37. Recommended Differential Clock Driving Circuit

SNR AND CLOCK JITTER

The signal to noise ratio of the ADC is limited by three different factors: the quantization noise is typically not noticeable in pipeline converters and is 74dB for a 12bit ADC. The thermal noise limits the SNR at low input frequencies while the clock jitter sets the SNR for higher input frequencies.

$$\text{SNR}_{\text{ADC}}[\text{dBc}] = -20 \times \log \sqrt{\left(10 - \frac{\text{SNR}_{\text{Quantization_Noise}}}{20}\right)^2 + \left(10 - \frac{\text{SNR}_{\text{ThermalNoise}}}{20}\right)^2 + \left(10 - \frac{\text{SNR}_{\text{Jitter}}}{20}\right)^2} \quad (1)$$

The SNR limitation due to sample clock jitter can be calculated as following:

$$\text{SNR}_{\text{Jitter}}[\text{dBc}] = -20 \times \log(2\pi \times f_{\text{IN}} \times t_{\text{jitter}}) \quad (2)$$

The total clock jitter (TJitter) has three components – the internal aperture jitter (100fs for ADS5407) which is set by the noise of the clock input buffer, the external clock jitter and the jitter from the analog input signal. It can be calculated as following:

$$T_{\text{Jitter}} = \sqrt{(T_{\text{Jitter,Ext.Clock_Input}})^2 + (T_{\text{Aperture_ADC}})^2} \quad (3)$$

External clock jitter can be minimized by using high quality clock sources and jitter cleaners as well as bandpass filters at the clock input while a faster clock slew rate improves the ADC aperture jitter.

The ADS5407 has a thermal noise of 63.8 dBFS and internal aperture jitter of 100fs. The SNR depending on amount of external jitter for different input frequencies is shown in the following figure.

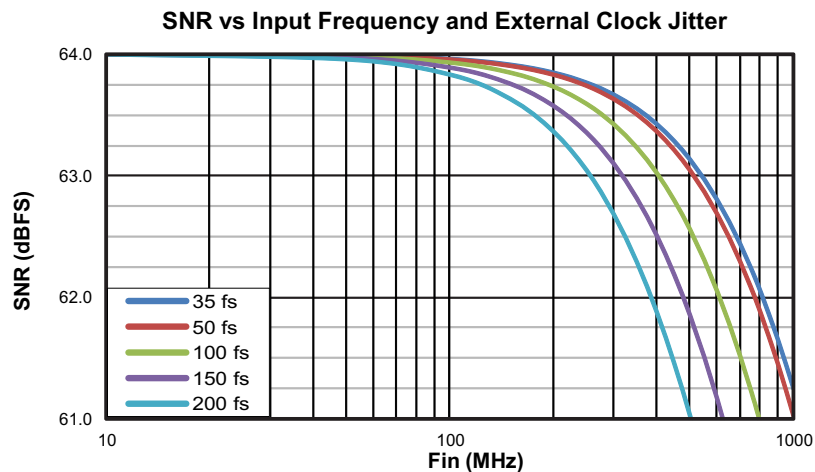

ANALOG INPUTS

The ADS5407 analog signal inputs are designed to be driven differentially. The analog input pins have internal analog buffers that drive the sampling circuit. As a result of the analog buffer, the input pins present a high impedance input across a very wide frequency range to the external driving source which enables great flexibility in the external analog filter design as well as excellent 50Ω matching for RF applications. The buffer also helps to isolate the external driving circuit from the internal switching currents of the sampling circuit which results in a more constant SFDR performance across input frequencies.

The common-mode voltage of the signal inputs is internally biased to 1.9V using 500Ω resistors which allows for AC coupling of the input drive network. Each input pin (INP, INM) must swing symmetrically between (VCM + 0.25V) and (VCM – 0.25V), resulting in a 1.0Vpp (default) differential input swing. The input sampling circuit has a 3dB bandwidth that extends up to 1.2GHz.

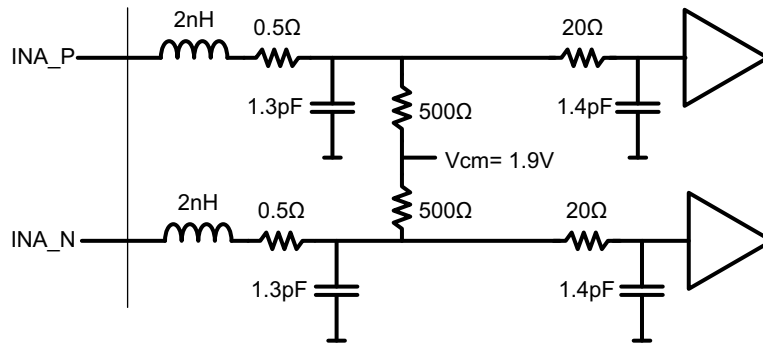

OVER-RANGE INDICATION

The ADS5407 provides a fast over-range indication on the OVRA/B pins. The fast OVR is triggered if the input voltage exceeds the programmable overrange threshold and it gets presented after just 12 clock cycles enabling a quicker reaction to an overrange event. The OVR threshold can be configured using SPI register writes.

The input voltage level at which the overload is detected is referred to as the threshold and is programmable using the Over-range threshold bits. The threshold at which fast OVR is triggered is (full-scale × [the decimal value of the FAST OVR THRESH bits] /16). After reset, the default value of the over-range threshold is set to 15 (decimal) which corresponds to a threshold of 0.56dB below full scale (20*log(15/16)).

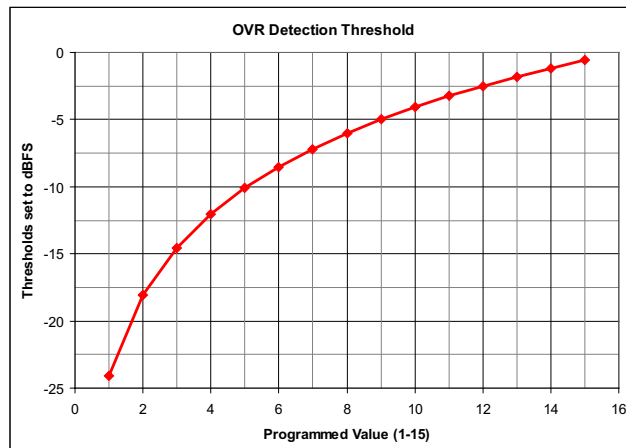

INTERLEAVING CORRECTION

Each of the two data converter channels consists of two interleaved ADCs each operating at half of the ADC sampling rate but 180° out of phase from each other. The front end track and hold circuitry is operating at the full ADC sampling rate which minimizes the timing mismatch between the two interleaved ADCs. In addition the ADS5407 is equipped with internal interleaving correction logic that can be enabled via SPI register write.

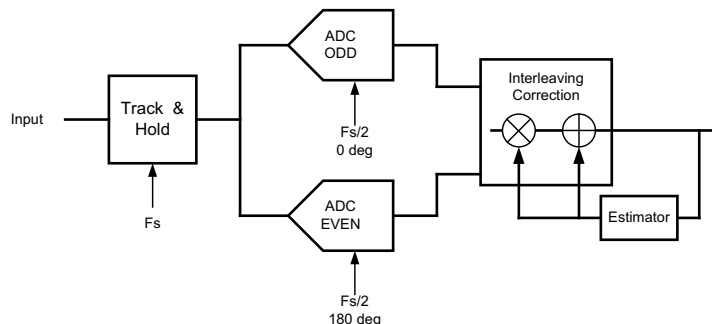

The interleaving operation creates 2 distinct and interleaving products:

- $F_s/2 - F_{in}$: this spur is created by gain timing mismatch between the ADCs. Since internally the front end track and hold is operated at the full sampling rate, this component is greatly improved and mostly dependent on gain mismatch.
- $F_s/2$ Spur: due to offset mismatch between ADCs

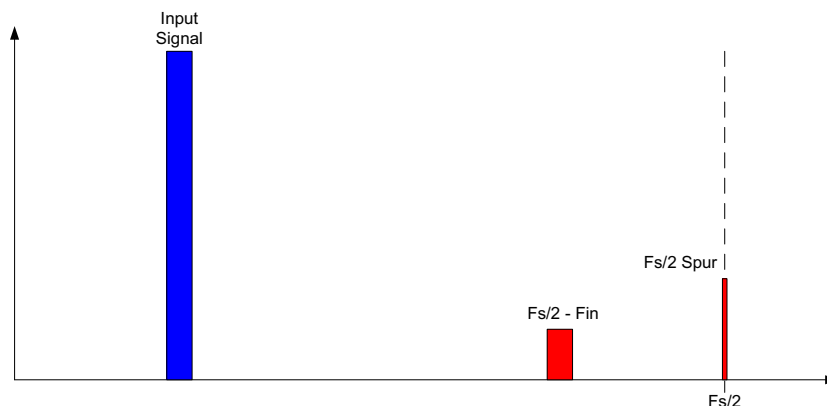

The auto correction loop can be enabled via SPI register write in address 0x01 and resetting the correction circuit in address 0x03 and 0x1A. . By default, it is disabled for lowest possible power consumption. The DC correction function can be enabled in 0x03 & 0x1A for chA and chB respectively. The default settings for the auto correction function should work for most applications. However please contact Texas Instruments if further fine tuning of the algorithm is required.

The auto correction function yields best performance for input frequencies below 250MHz.

DECIMATION FILTER

Each channel has a digital filter in the data path as shown in Figure 38. The filter can be programmed as a low-pass or a high-pass filter and the normalized frequency response of both filters is shown in Figure 39.

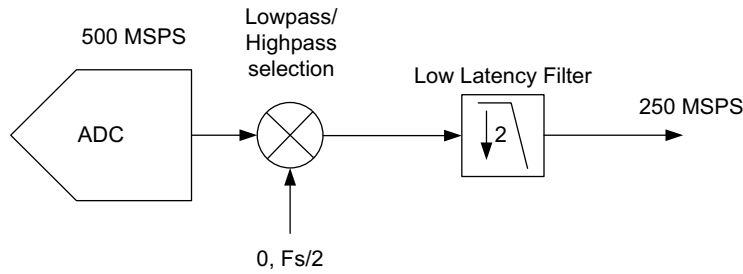

Figure 38.

The decimation filter response has a 0.1dB pass band ripple with approximately 41% pass-band bandwidth. The stop-band attenuation is approximately 40dB.

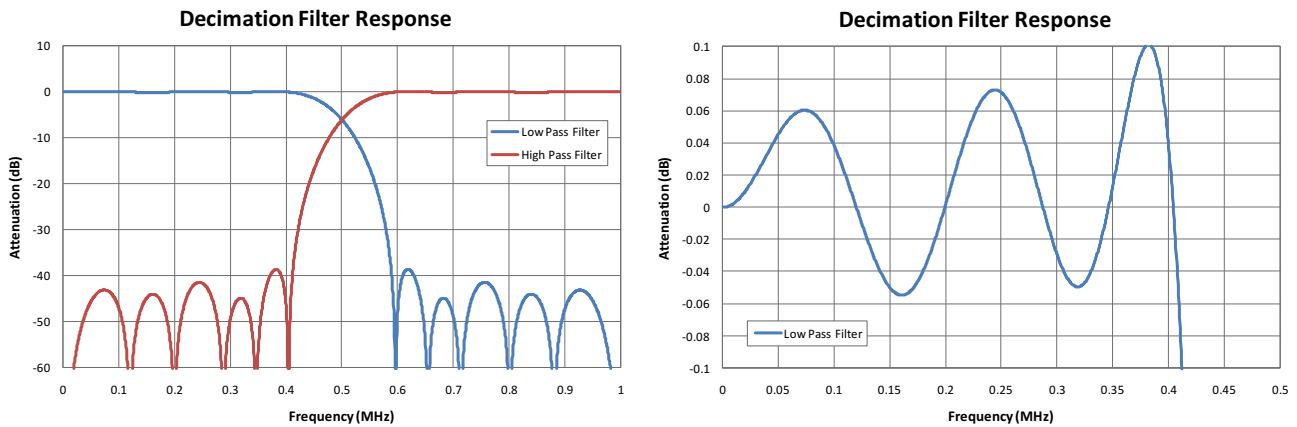
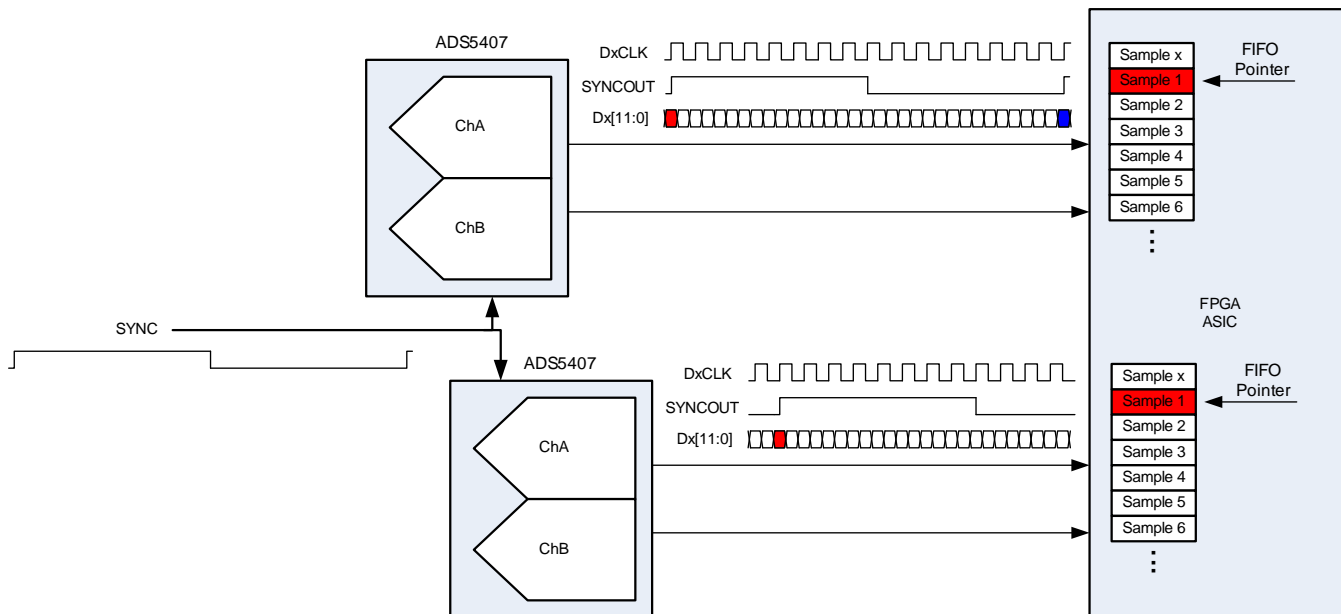

Figure 39.

MULTI DEVICE SYNCHRONIZATION

The ADS5407 simplifies the synchronization of data from multiple ADCs in one common receiver. Upon receiving the initial SYNC input signal, the ADS5407 resets all the internal clocks and digital logic while also starting a SYNCOUT signal which operates on a 5bit counter (32 clock cycles). Therefore by providing a common SYNC signal to multiple ADCs their output data can be synchronized as the SYNCOUT signal marks a specific sample with the same latency in all ADCs. The SYNCOUT signal then can be used in the receiving device to synchronize the FIFO pointers across the different input data streams. Thus the output data of multiple ADCs can be aligned properly even if there are different trace lengths between the different ADCs.



The SYNC input signal should be a one time pulse to trigger the periodic 5-bit counter for SYNCOUT or a periodic signal repeating every 32 CLKIN clock cycles. It gets registered on the rising edge of the ADC input clock (CLKIN). Upon registering the initial rising edge of the SYNC signal, the internal clocks and logic get reset which results in invalid output data for 36 samples (1 complete sync cycle and 4 additional samples). The SYNCOUT signal starts with the next output clock (DACLK) rising edge and operates on a 5-bit counter. If a SYNCIN rising edge gets registered at a new position, the counter gets reset and SYNCOUT starts from the new position.

Since the ADS5407 output interface operates with a DDR clock, the synchronization can happen on the rising edge or falling edge sample. Synchronization on the falling edge sample will result in a half cycle clock stretch of DA/BCLK. For convenience the SYNCOUT signal is available on the ChA/B output LVDS bus. When using decimation the SYNCOUT signal still operates on 32 clock cycles of CLKIN but since the output data is decimated by 2, only the first 18 samples should be discarded.

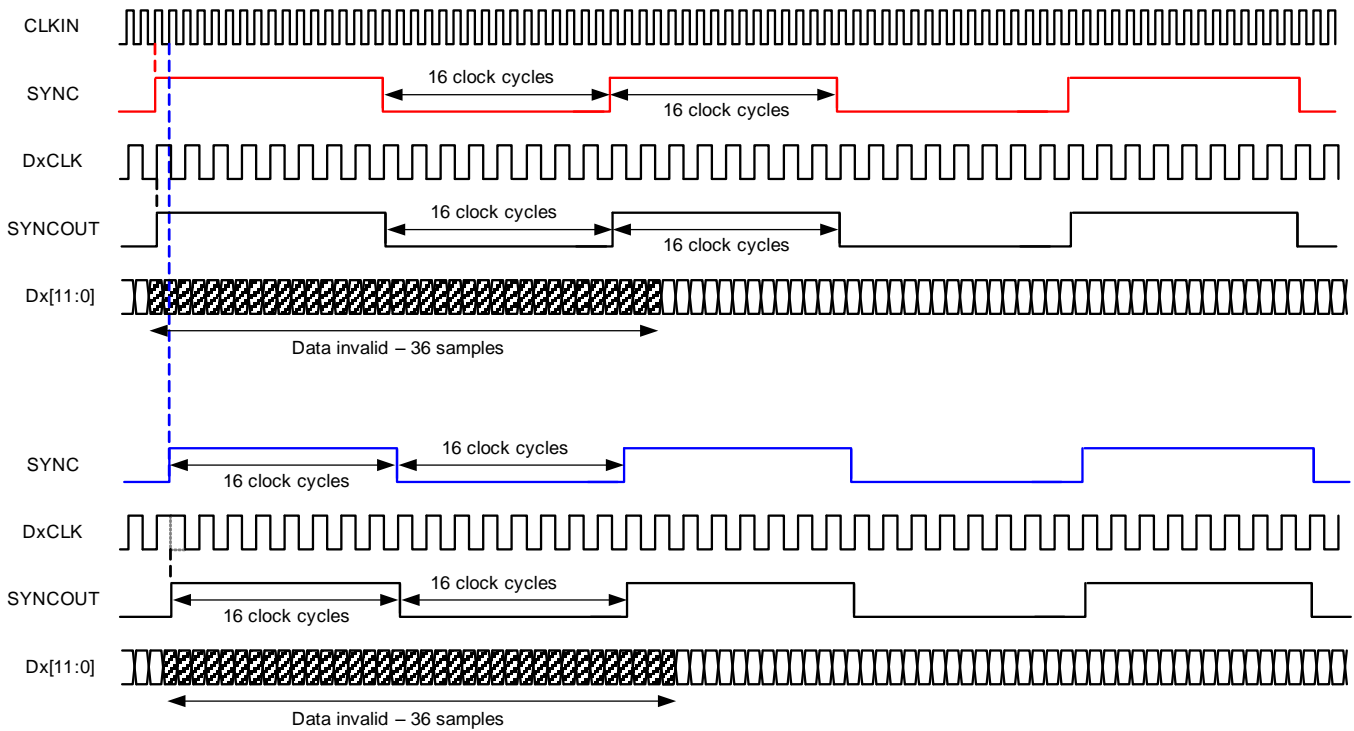

PROGRAMMING INTERFACE

The serial interface (SIF) included in the ADS5407 is a simple 3 or 4 pin interface. In normal mode, 3 pins are used to communicate with the device. There is an enable (SDENB), a clock (SCLK) and a bi-directional IO port (SDIO). If the user would like to use the 4 pin interface one write must be implemented in the 3 pin mode to enable 4 pin communications. In this mode, the SDO pin becomes the dedicated output. The serial interface has an 8-bit address word and a 16-bit data word. The first rising edge of SCLK after SDENB goes low will latch the read/write bit. If a high is registered then a read is requested, if it is low then a write is requested. SDENB must be brought high again before another transfer can be requested. The signal diagram is shown below:

Device Initialization

After power up, it is recommended to initialize the device through a hardware reset by applying a logic low pulse on the SRESETb pin (of width greater than 20ns), as shown in Figure 40. This resets all internal digital blocks (including SPI registers) to their default condition.

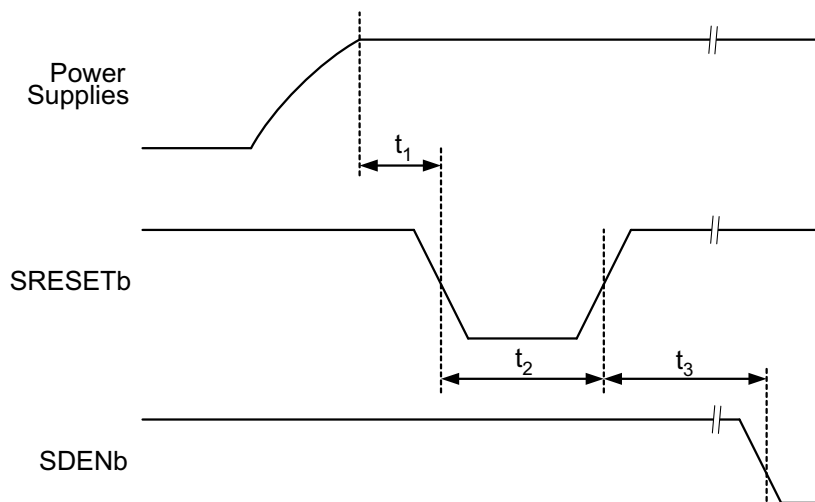

Figure 40. Device Initialization Timing Diagram

Table 1. Reset Timing

PARAMETER		CONDITIONS	MIN	TYP	MAX	UNIT
t ₁	Power-on delay	Delay from power up to active low RESET pulse	3			ms
t ₂	Reset pulse width	Active low RESET pulse width	20			ns
t ₃	Register write delay	Delay from RESET disable to SDENb active	100			ns

Recommended Device Initialization Sequence:

1. Power up
2. Reset ADS5407 using hardware reset.
3. Apply clock and input signal.
4. Set register 0x01 bit D15 to "1" (ChA Corr EN) and bit D9 to "1" (ChB Corr EN) to enable gain/offset correction circuit and other desired registers.
5. Set register 0x03 and 0x1A bit D14 to "1" (Start Auto Corr ChA/B). This clears and resets the accumulator values in the DC and gain correction loop.
6. Set register 0x03 and 0x1A bit D14 to "0" (Start Auto Corr ChA/B). This starts the DC and gain auto-correction loop.

Serial Register Write

The internal register of the ADS5407 can be programmed following these steps:

1. Drive SDENB pin low
2. Set the R/W bit to '0' (bit A7 of the 8 bit address)

3. Initiate a serial interface cycle specifying the address of the register (A6 to A0) whose content has to be written
4. Write 16bit data which is latched on the rising edge of SCLK

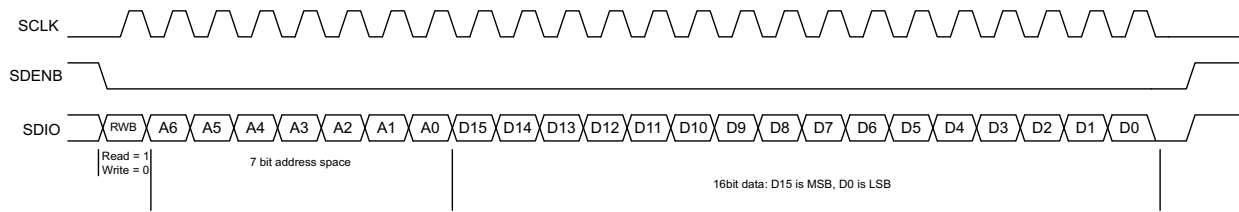

Figure 41. Serial Register Write Timing Diagram

PARAMETER		MIN	TYP ⁽¹⁾	MAX	UNIT
f _{SCLK}	SCLK frequency (equal to 1/t _{SCLK})	>DC		20	MHz
t _{SLOADS}	SDENB to SCLK setup time	25			ns
t _{SLOADH}	SCLK to SDENB hold time	25			ns
t _{DSU}	SDIO setup time	25			ns
t _{DH}	SDIO hold time	25			ns

(1) Typical values at +25°C; minimum and maximum values across the full temperature range: TMIN = -40°C to TMAX = +85°C, AVDD3V = 3.3V, AVDD, DRVDD = 1.9V, unless otherwise noted.

Serial Register Readout

The device includes a mode where the contents of the internal registers can be read back using the SDO/SDIO pins. This read-back mode may be useful as a diagnostic check to verify the serial interface communication between the external controller and the ADC.

1. Drive SDENB pin low
2. Set the RW bit (A7) to '1'. This setting disables any further writes to the registers
3. Initiate a serial interface cycle specifying the address of the register (A6 to A0) whose content has to be read.
4. The device outputs the contents (D15 to D0) of the selected register on the SDO/SDIO pin
5. The external controller can latch the contents at the SCLK rising edge.
6. To enable register writes, reset the RW register bit to '0'.

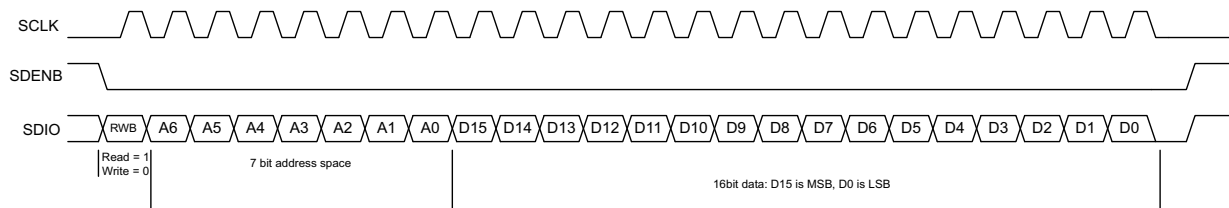

Figure 42. Serial Register Read Timing Diagram

SERIAL REGISTER MAP⁽²⁾

(2) Multiple functions in a register can be programmed in a single write operation.

Register Address	Register Data																
A7–A0 IN HEX	D15	D14	D13	D12	D11	D10	D9	D8	D7	D6	D5	D4	D3	D2	D1	D0	
0	3/4 Wire SPI	Decimation Filter EN	0	ChA High/Low Pass	0	0	ChB High/Low Pass	0	0	0	0	0	0	0	0	0	
1	ChA Corr EN	0	0	0	0	0	ChB Corr EN	0	0	0	0	0	Data Format	0	Hp Mode1	0	
2	0	0	0	0	0	Over-range threshold				0	0	0	0	0	0	0	
3	0	Start Auto Corr ChA	0	0	1	0	1	1	0	0	0	1	1	0	0	0	
E	Sync Select															0	0
F	Sync Select				0	0	0	0	0	VREF Set			0	0	0	0	
1A	0	Start Auto Corr ChB	0	0	1	0	1	1	0	0	0	1	1	0	0	0	
2B	0	0	0	0	0	0	0	Temp Sensor									
2C	Reset																
37	Sleep Modes							0	0	0	0	0	0	0	0	0	0
38	HP Mode2									BIAS EN	SYNC EN	LP Mode 1	1	1	1	1	
3A	LVDS Current Strength		LVDS SW		Internal LVDS Termination		0	0	0	0	DACLK EN	DBCLK EN	0	OVRA EN	OVRB EN		
66	LVDS Output Bus A EN																
67	LVDS Output Bus B EN																

DESCRIPTION OF SERIAL INTERFACE REGISTERS

Register Address	Register Data															
A7–A0 in hex	D15	D14	D13	D12	D11	D10	D9	D8	D7	D6	D5	D4	D3	D2	D1	D0
0	3/4 Wire SPI	Decimation Filter EN	0	ChA High/Low Pass	0	0	ChB High/Low Pass	0	0	0	0	0	0	0r	0	0

- D15 **3/4 Wire SPI** Enables 4-bit serial interface when set
Default 0
- 0 3 wire SPI is used with SDIO pin operating as bi-directional I/O port
- 1 4 wire SPI is used with SDIO pin operating as data input and SDO pin as data output port.
- D14 **Decimation Filter EN** 2x decimation filter is enabled when bit is set
Default 0
- 0 Normal operation with data output at full sampling rate
- 1 2x decimation filter enabled
- D12 **ChA High/Low Pass** (Decimation filter must be enabled first: set bit D14)
Default 0
- 0 Low Pass

- 1 High Pass
- D9 **ChB High/Low Pass** (Decimation filter must be enabled first: set bit D14)
 Default 0
- 0 Low Pass
- 1 High Pass

Register Address	Register Data															
A7-A0 in hex	D15	D14	D13	D12	D11	D10	D9	D8	D7	D6	D5	D4	D3	D2	D1	D0
1	ChA Corr EN	0	0	0	0	0	ChB Corr EN	0	0	0	0	0	Data Format	0	HP Mode1	0

- D15 **ChA Corr EN (should be enabled for maximum performance)**
 Default 0
- 0 auto correction disabled
- 1 auto correction enabled
- D9 **ChB Corr EN (should be enabled for maximum performance)**
 Default 0
- 0 auto correction disabled
- 1 auto correction enabled
- D3 **Data Format**
 Default 0
- 0 Two's complement
- 1 Offset Binary
- D1 **HP Mode 1**
 Default 0
- 1 Must be set to 1 for optimum performance

Register Address	Register Data															
	D15	D14	D13	D12	D11	D10	D9	D8	D7	D6	D5	D4	D3	D2	D1	D0
A7-A0 in hex	2	0	0	0	0	0	Over-range threshold			0	0	0	0	0	0	0

D10-D7 Over-range threshold The over-range detection is triggered 20 output clock cycles after the overload condition occurs. The threshold at which the OVR is triggered = $1.1V \times [\text{decimal value of } \langle \text{Over-range threshold} \rangle] / 16$. After power up or reset, the default value is 15 (decimal) which corresponds to a OVR threshold of 0.56dB below fullscale ($20 \times \log(15/16)$).

This OVR threshold is applicable to both channels.

Default 1111

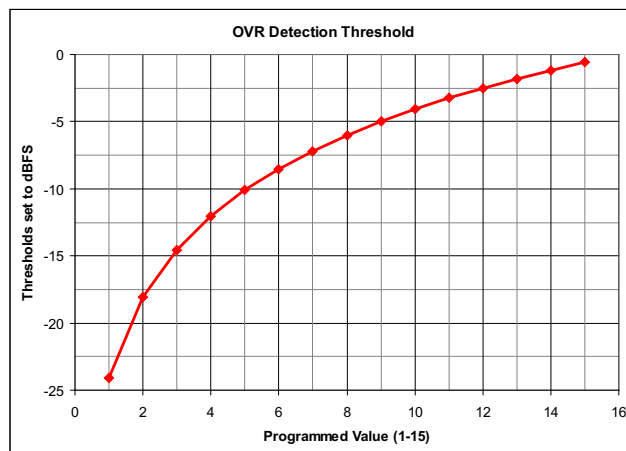

Register Address	Register Data															
	D15	D14	D13	D12	D11	D10	D9	D8	D7	D6	D5	D4	D3	D2	D1	D0
A7-A0 in hex	3	0	DC Offset Coff ChA	0	0	1	0	1	1	0	0	0	1	1	0	0

- D14 **DC Offset Corr ChA** Starts DC offset correction loop for ChA
Default 1
- 0 Starts offset correction loop for ChA
- 1 DC offset correction loop is cleared
- D11, 9, 8, 4, 3 Must be set to 1 for maximum performance
Default 1

Register Address	Register Data															
	D15	D14	D13	D12	D11	D10	D9	D8	D7	D6	D5	D4	D3	D2	D1	D0
A7-A0 in hex																
E	Sync Select														0	0

D15-D2 **Sync Select** Sync selection for the clock generator block (also need to see address 0x0F)
Default 1010 1010 1010 10
0000 0000 0000 00 Sync is disabled
0101 0101 0101 01 Sync is set to one shot (one time synchronization only)
1010 1010 1010 10 Sync is derived from SYNC input pins
1111 1111 1111 11 not supported

Register Address	Register Data															
	D15	D14	D13	D12	D11	D10	D9	D8	D7	D6	D5	D4	D3	D2	D1	D0
A7-A0 in hex																
F	Sync Select				0	0	0	0	0	VREF Sel			0	0	0	0

D15-D12 **Sync Select** Sync selection for the clock generator block
Default 1010
0000 Sync is disabled
0101 Sync is set to one shot (one time synchronization only)
1010 Sync is derived from SYNC input pins
1111 not supported
D6-D4 **VREF SEL** Internal voltage reference selection
Default 000
000 1.0V
001 1.25V
010 0.9V
011 0.8V
100 1.15V
Others external reference

Register Address	Register Data															
	D15	D14	D13	D12	D11	D10	D9	D8	D7	D6	D5	D4	D3	D2	D1	D0
A7-A0 in hex																
1A	0	Start Auto Corr ChB	0	0	1	0	1	1	0	0	0	1	1	0	0	0

D14 **Start Auto Corr ChB** Starts DC offset and Gain correction loop for ChB
Default 1
0 Starts the DC offset and Gain correction loops for ChB
1 Clears DC offset correction value to 0 and Gain correction value to 1
D11, 9, 8, 4, 3 Must be set to 1 for maximum performance
Default 1

Register Address	Register Data															
A7-A0 in hex	D15	D14	D13	D12	D11	D10	D9	D8	D7	D6	D5	D4	D3	D2	D1	D0
2B	0	0	0	0	0	0	0	Temp Sensor								

D8-D0 **Temp Sensor** Internal temperature sensor value – read only

Register Address	Register Data															
A7-A0 in hex	D15	D14	D13	D12	D11	D10	D9	D8	D7	D6	D5	D4	D3	D2	D1	D0
2C	Reset															

D15-D0 **Reset** This is a software reset to reset all SPI registers to their default value. Self Default clears to 0.
 0000

1101001011110000 Perform software reset

Register Address	Register Data															
A7-A0 in hex	D15	D14	D13	D12	D11	D10	D9	D8	D7	D6	D5	D4	D3	D2	D1	D0
37	Sleep Modes						0	0	0	0	0	0	0	0	0	0

D15-D14 **Sleep Modes** Sleep mode selection which is controlled by the ENABLE pin. Sleep modes are active when ENABLE pin goes low.
 Default 00

- 000000 Complete shut down Wake up time 2.5 ms
- 100000 Stand-by mode Wake up time 100 μs
- 110000 Deep sleep mode Wake up time 20 μs
- 110101 Light sleep mode Wake up time 2 μs

Register Address	Register Data															
	D15	D14	D13	D12	D11	D10	D9	D8	D7	D6	D5	D4	D3	D2	D1	D0
38	HP Mode 2									Bias EN	SYNC EN	LP Mode 1	1	1	1	1

D15-D7 HP Mode 2

Default 11111111

1 Set to 1 for normal operation

D6 BIAS EN Enables internal fuse bias voltages – can be disabled after power up to save power.
 Default 1

0 Internal bias powered down

1 Internal bias enabled

D5 SYNC EN Enables the SYNC input buffer.
 Default 1

0 SYNC input buffer disabled

1 SYNC input buffer enabled

D4 LP Mode 1 Low power mode 1 to disable unused internal input buffer
 Default 1

0 Internal input buffer disabled

1 Internal input buffer enabled

D3-D0 Reads back 1

Register Address	Register Data																
	A7-A0 in hex	D15	D14	D13	D12	D11	D10	D9	D8	D7	D6	D5	D4	D3	D2	D1	D0
3A	LVDS Current Strength			LVDS SW			Internal LVDS Termination		0	0	0	0	DACLK EN	DBCLK EN	0	OVRA EN	OVRB EN

- D15-D13 **LVDS Current Strength** LVDS output current strength.
 Default 000
 - 000 2 mA 100 3 mA
 - 001 2.25 mA 101 3.25 mA
 - 010 2.5 mA 110 3.5 mA
 - 011 2.75 mA 111 3.75 mA

- D12-D11 **LVDS SW** LVDS driver internal switch setting – correct range must be set for setting in D15-D13
 Default 01
 - 01 2 mA to 2.75 mA
 - 11 3mA to 3.75mA

- D10-D9 **Internal LVDS Termination** Internal termination
 Default 00
 - 00 2 kΩ
 - 01 200 Ω
 - 10 200 Ω
 - 11 100 Ω

- D4 **DACLK EN** Enable DACLK output buffer
 Default 1
 - 0 DACLK output buffer powered down
 - 1 DACLK output buffer enabled

- D3 **DBCLK EN** Enable DBCLK output buffer
 Default 1
 - 0 DBCLK output buffer powered down
 - 1 DBCLK output buffer enabled

- D1 **OVRA EN** Enable OVRA output buffer
 Default 1
 - 0 OVRA output buffer powered down
 - 1 OVRA output buffer enabled

- D0 **OVRB EN** Enable OVRB output buffer
 Default 1
 - 0 OVRB output buffer powered down
 - 1 OVRB output buffer enabled

Register Address	Register Data															
	D15	D14	D13	D12	D11	D10	D9	D8	D7	D6	D5	D4	D3	D2	D1	D0
A7-A0 in hex																
66	LVDS Output Bus A EN															

- D15-D0 **LVDS Output Bus A EN** Individual LVDS output pin power down for channel A
 Default FFFF
- 0 Output is powered down
 1 Output is enabled
- D15 Pins N7, P7 (no connect pins) which are not used and should be powered down for power savings
 D14 Pins N6, P6 (no connect pins) which are not used and should be powered down for power savings.
 D13 SYNCOUTP/N (pins N5, P5)
 D12 Pins N4, P4 (no connect pins) which are not used and should be powered down for power savings
 D11-D0 corresponds to DA11-DA0

Register Address	Register Data															
	D15	D14	D13	D12	D11	D10	D9	D8	D7	D6	D5	D4	D3	D2	D1	D0
A7-A0 in hex																
67	LVDS Output Bus B EN															

- D15-D0 **LVDS Output Bus B EN** Individual LVDS output pin power down for channel B
 Default FFFF
- 0 Output is powered down
 1 Output is enabled
- D15 Pins G3, G4 (no connect pins) which are not used and should be powered down for power savings
 D14 Pins F3, F4 (no connect pins) which are not used and should be powered down for power savings.
 D13 SYNCOUTP/N (pins F1, F2)
 D12 Pins E3, E4 (no connect pins) which are not used and should be powered down for power savings
 D11-D0 corresponds to DB11-DB0

REVISION HISTORY

Changes from Revision A (August 2013) to Revision B	Page
• Changed package from QFN to nFBGA in THERMAL INFORMATION	5
• Deleted text from last paragraph in INTERLEAVING CORRECTION section	23
• Changed second paragraph in MULTI DEVICE SYNCHRONIZATION section	25
• Deleted Register Initialization section and added Device Initialization section	27
• Changed Register Address E Bits D1 and D0 to 0 in SERIAL REGISTER MAP	30
• Changed Register Address 38 Bits D3 to D0 from 0 to 1 in SERIAL REGISTER MAP	30
• Changed Register Address E Bit D1 and D0 to 0	33
• Changed Register Address 38 Bits D3 to D0 from 0 to 1 and add D3 to D0 Read back 1	35
• Changed Register Address 66 D15-D10 to D15-D0 and DA11-D0 to DA11-DA0	37
• Changed Register Address 67 D15-D10 to D15-D0	37

Changes from Original (March 2013) to Revision A	Page
• Changed D13 in Register 66 From: SYNCOUTP/N (pins F1, F2) To: SYNCOUTP/N (pins N5, P5)	37
• Changed D12 in Register 66 From: "Pins E3, E4..." To: "Pins N4, P4..."	37
• Changed D11-D10 - corresponds to DB11-DB0 in Register 66 To: D11-D0 -corresponds to DA11-D0	37
• Changed D11-D10 - corresponds to DB11-DB0 in Register 67 To: D11-D0 -corresponds to DB11-DB0	37

PACKAGING INFORMATION

Orderable Device	Status (1)	Package Type	Package Drawing	Pins	Package Qty	Eco Plan (2)	Lead finish/ Ball material (6)	MSL Peak Temp (3)	Op Temp (°C)	Device Marking (4/5)	Samples
ADS5407IZAY	ACTIVE	NFBGA	ZAY	196	160	RoHS & Green	SNAGCU	Level-3-260C-168 HR	-40 to 85	ADS5407I	Samples
ADS5407IZAYR	ACTIVE	NFBGA	ZAY	196	1000	RoHS & Green	SNAGCU	Level-3-260C-168 HR	-40 to 85	ADS5407I	Samples

(1) The marketing status values are defined as follows:

ACTIVE: Product device recommended for new designs.

LIFEBUY: TI has announced that the device will be discontinued, and a lifetime-buy period is in effect.

NRND: Not recommended for new designs. Device is in production to support existing customers, but TI does not recommend using this part in a new design.

PREVIEW: Device has been announced but is not in production. Samples may or may not be available.

OBSOLETE: TI has discontinued the production of the device.

(2) **RoHS:** TI defines "RoHS" to mean semiconductor products that are compliant with the current EU RoHS requirements for all 10 RoHS substances, including the requirement that RoHS substance do not exceed 0.1% by weight in homogeneous materials. Where designed to be soldered at high temperatures, "RoHS" products are suitable for use in specified lead-free processes. TI may reference these types of products as "Pb-Free".

RoHS Exempt: TI defines "RoHS Exempt" to mean products that contain lead but are compliant with EU RoHS pursuant to a specific EU RoHS exemption.

Green: TI defines "Green" to mean the content of Chlorine (Cl) and Bromine (Br) based flame retardants meet JS709B low halogen requirements of <=1000ppm threshold. Antimony trioxide based flame retardants must also meet the <=1000ppm threshold requirement.

(3) MSL, Peak Temp. - The Moisture Sensitivity Level rating according to the JEDEC industry standard classifications, and peak solder temperature.

(4) There may be additional marking, which relates to the logo, the lot trace code information, or the environmental category on the device.

(5) Multiple Device Markings will be inside parentheses. Only one Device Marking contained in parentheses and separated by a "~" will appear on a device. If a line is indented then it is a continuation of the previous line and the two combined represent the entire Device Marking for that device.

(6) Lead finish/Ball material - Orderable Devices may have multiple material finish options. Finish options are separated by a vertical ruled line. Lead finish/Ball material values may wrap to two lines if the finish value exceeds the maximum column width.

Important Information and Disclaimer:The information provided on this page represents TI's knowledge and belief as of the date that it is provided. TI bases its knowledge and belief on information provided by third parties, and makes no representation or warranty as to the accuracy of such information. Efforts are underway to better integrate information from third parties. TI has taken and continues to take reasonable steps to provide representative and accurate information but may not have conducted destructive testing or chemical analysis on incoming materials and chemicals. TI and TI suppliers consider certain information to be proprietary, and thus CAS numbers and other limited information may not be available for release.

In no event shall TI's liability arising out of such information exceed the total purchase price of the TI part(s) at issue in this document sold by TI to Customer on an annual basis.

TAPE AND REEL INFORMATION

QUADRANT ASSIGNMENTS FOR PIN 1 ORIENTATION IN TAPE

*All dimensions are nominal

Device	Package Type	Package Drawing	Pins	SPQ	Reel Diameter (mm)	Reel Width W1 (mm)	A0 (mm)	B0 (mm)	K0 (mm)	P1 (mm)	W (mm)	Pin1 Quadrant
ADS5407IZAYR	NFBGA	ZAY	196	1000	330.0	24.4	12.3	12.3	2.3	16.0	24.0	Q1

TAPE AND REEL BOX DIMENSIONS

*All dimensions are nominal

Device	Package Type	Package Drawing	Pins	SPQ	Length (mm)	Width (mm)	Height (mm)
ADS5407IZAYR	NFBGA	ZAY	196	1000	350.0	350.0	43.0

TRAY

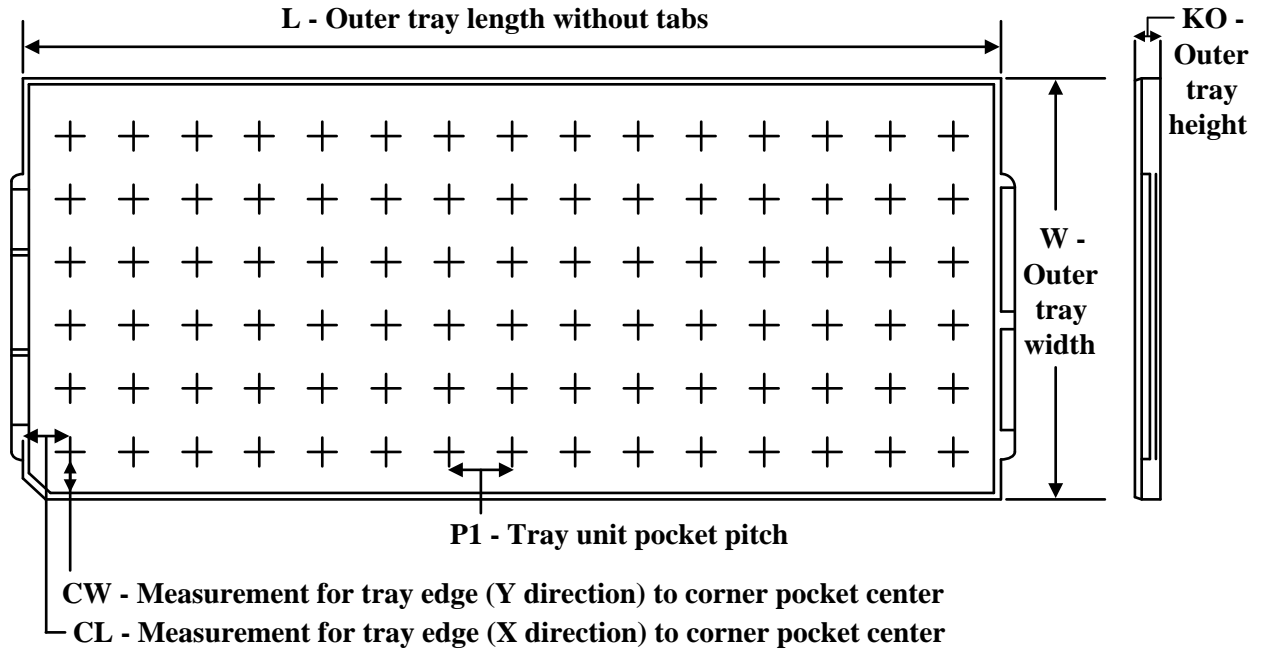

Chamfer on Tray corner indicates Pin 1 orientation of packed units.

*All dimensions are nominal

Device	Package Name	Package Type	Pins	SPQ	Unit array matrix	Max temperature (°C)	L (mm)	W (mm)	K0 (µm)	P1 (mm)	CL (mm)	CW (mm)
ADS5407IZAY	ZAY	NFBGA	196	160	8 x 20	150	315	135.9	7620	15.4	11.2	19.65

ZAY0196A

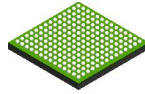

PACKAGE OUTLINE

NFBGA - 1.4 mm max height

PLASTIC BALL GRID ARRAY

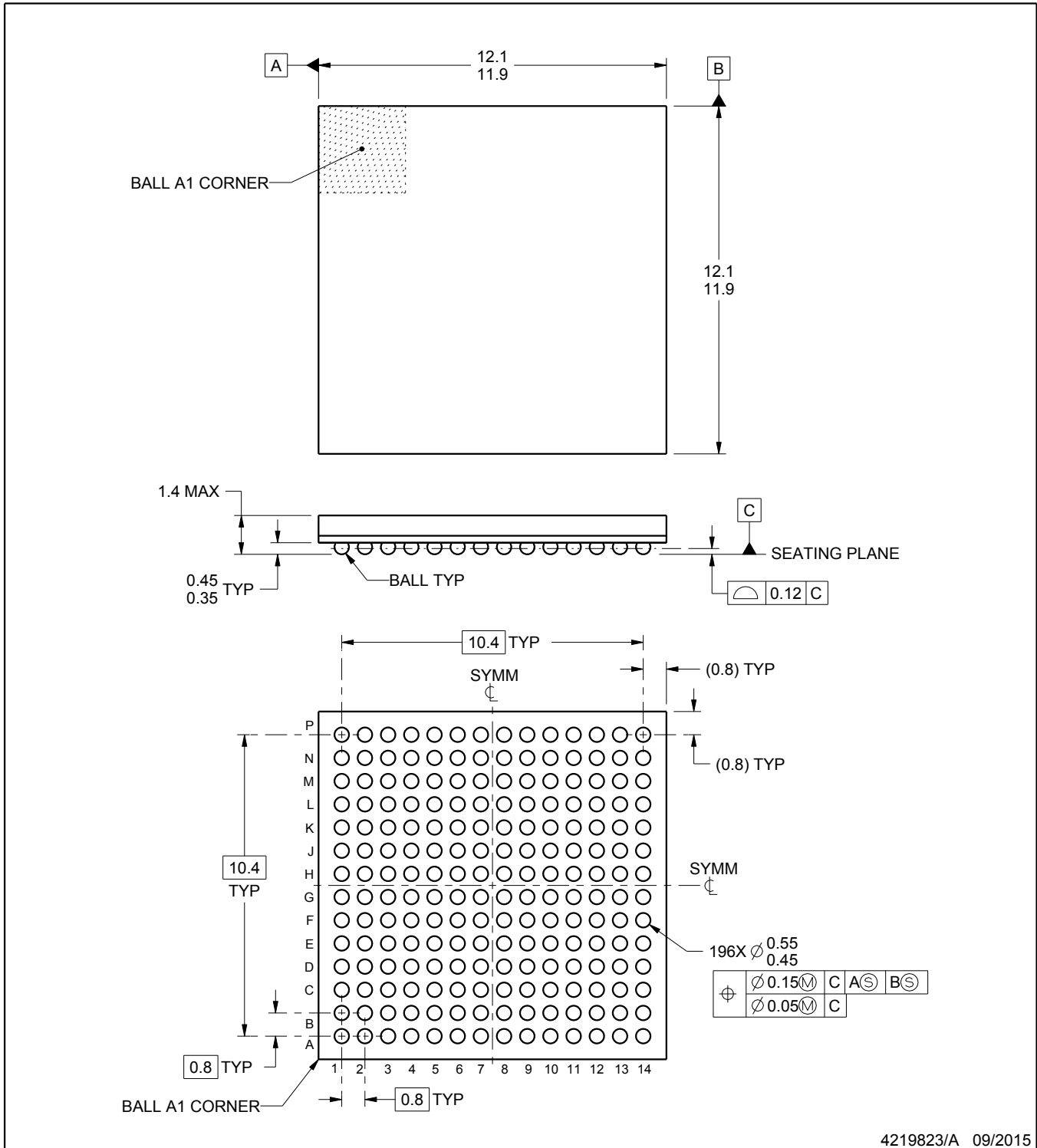

4219823/A 09/2015

NOTES:

1. All linear dimensions are in millimeters. Any dimensions in parenthesis are for reference only. Dimensioning and tolerancing per ASME Y14.5M.
2. This drawing is subject to change without notice.

EXAMPLE BOARD LAYOUT

ZAY0196A

NFBGA - 1.4 mm max height

PLASTIC BALL GRID ARRAY

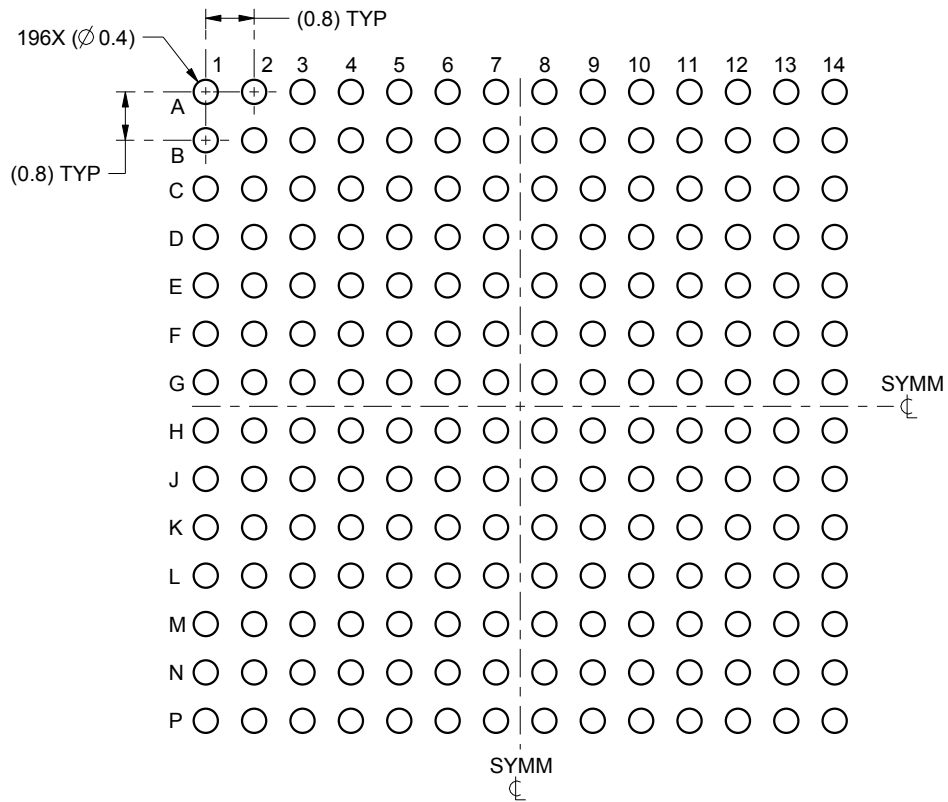

LAND PATTERN EXAMPLE
SCALE:8X

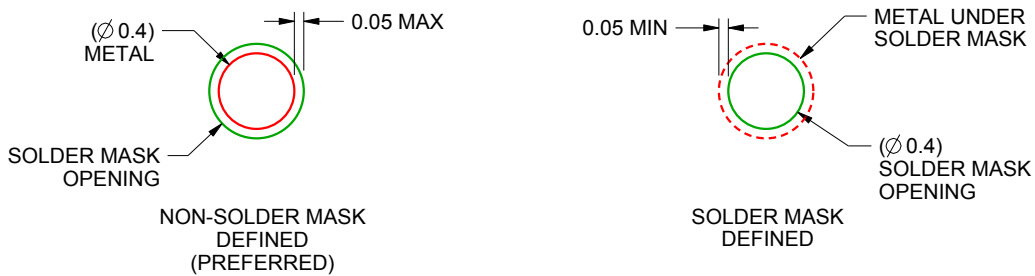

SOLDER MASK DETAILS
NOT TO SCALE

4219823/A 09/2015

NOTES: (continued)

- Final dimensions may vary due to manufacturing tolerance considerations and also routing constraints. For information, see Texas Instruments literature number SPRAA99 (www.ti.com/lit/spraa99).

EXAMPLE STENCIL DESIGN

ZAY0196A

NFBGA - 1.4 mm max height

PLASTIC BALL GRID ARRAY

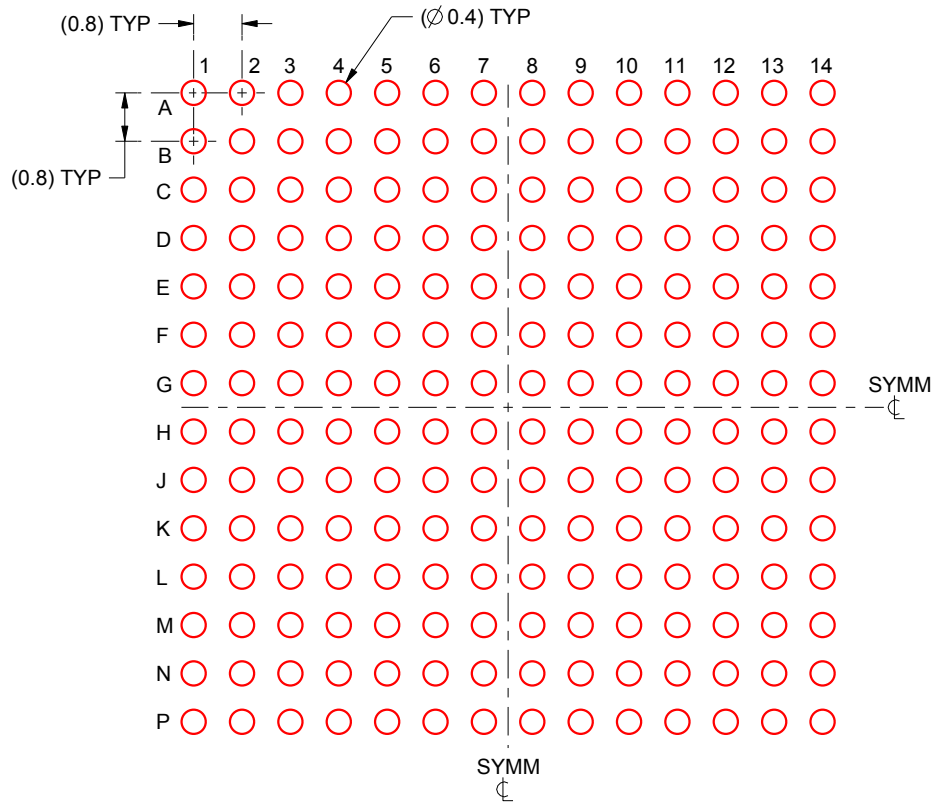

SOLDER PASTE EXAMPLE
BASED ON 0.15 mm THICK STENCIL
SCALE:8X

4219823/A 09/2015

NOTES: (continued)

4. Laser cutting apertures with trapezoidal walls and rounded corners may offer better paste release.

重要声明和免责声明

TI“按原样”提供技术和可靠性数据（包括数据表）、设计资源（包括参考设计）、应用或其他设计建议、网络工具、安全信息和其他资源，不保证没有瑕疵且不做任何明示或暗示的担保，包括但不限于对适销性、某特定用途方面的适用性或不侵犯任何第三方知识产权的暗示担保。

这些资源可供使用 TI 产品进行设计的熟练开发人员使用。您将自行承担以下全部责任：(1) 针对您的应用选择合适的 TI 产品，(2) 设计、验证并测试您的应用，(3) 确保您的应用满足相应标准以及任何其他功能安全、信息安全、监管或其他要求。

这些资源如有变更，恕不另行通知。TI 授权您仅可将这些资源用于研发本资源所述的 TI 产品的应用。严禁对这些资源进行其他复制或展示。您无权使用任何其他 TI 知识产权或任何第三方知识产权。您应全额赔偿因在这些资源的使用中对 TI 及其代表造成的任何索赔、损害、成本、损失和债务，TI 对此概不负责。

TI 提供的产品受 [TI 的销售条款](#) 或 [ti.com](#) 上其他适用条款/TI 产品随附的其他适用条款的约束。TI 提供这些资源并不会扩展或以其他方式更改 TI 针对 TI 产品发布的适用的担保或担保免责声明。

TI 反对并拒绝您可能提出的任何其他或不同的条款。

邮寄地址：Texas Instruments, Post Office Box 655303, Dallas, Texas 75265

Copyright © 2023，德州仪器 (TI) 公司