

## **AN-979 The Practical Limits of RS-485**

---

### **ABSTRACT**

This application note discusses the EIA-485 standard for differential multipoint data transmission and its practical limits. It is commonly called RS-485, however its official name is EIA-485 which reflects the name of the committee at the time it was released. It is expected to be revised soon and will then become TIA/EIA-485-A.

### **Contents**

1	Introduction .....	2
2	Key RS-485 Requirements .....	2
3	Compatibility Tradeoffs .....	4
4	Implementation Issues .....	5
5	Practical Limits .....	7
6	Conclusion .....	7
7	References .....	8

### **List of Figures**

1	No Load Configuration .....	2
2	Termination Load Configuration.....	3
3	Full Load Configuration .....	3
4	Typical RS-485 Application .....	3
5	V/I Relationship defining a Unit Load.....	4
6	Receiver Input Range .....	4
7	Bus Topology .....	5
8	Star Topology.....	5
9	Stub Length .....	6
10	Eye Patterns .....	7

### **List of Tables**

1	Driver Output Voltage Requirements.....	3
---	---	---

## 1 Introduction

This application note discusses the EIA-485 standard for differential multipoint data transmission and its practical limits. It is commonly called RS-485, however its official name is EIA-485 which reflects the name of the committee at the time it was released. It is expected to be revised soon and will then become TIA/EIA-485-A.

Differential data transmission is ideal for transmitting at high data rates, over long distances and through noisy environments. It nullifies the effects of ground shifts and noise signals which appear as common mode voltages on the transmission line. TIA/EIA-422-B is a standard that defines differential data transmission from a single driver to multiple receivers. RS-485 allows multiple drivers in operation, which makes multipoint (party line) configurations possible.

This application note will discuss the specifications as defined in the RS-485 document. Interpretations of the standard and device specifications can vary among manufacturers. However, there are some guarantees required to be completely compliant with the standard.

There are many possibilities and trade-offs associated with being partially compliant—or “compatible.” Some applications can tolerate the trade-offs in return for increased performance or added value. For that reason, this application note will discuss the practical application of the specifications.

A detailed explanation of each requirement of the standard will not be given as this is beyond the scope of this note. Also beyond the scope are advanced topics relating to new technology.

## 2 Key RS-485 Requirements

The key features are:

- Differential (Balanced) Interface
- Multipoint Operation
- Operation from a single +5V Supply
- -7V to +12V Bus Common Mode Range
- Up to 32 Unit Loads (Transceivers)
- 10 Mbps Maximum Data Rate (@40 feet)

4000 Foot Maximum Cable Length (@100 kbps)

A typical application is shown in [Figure 4](#).

The key requirement of the driver is its guaranteed differential output voltage as measured: with no load; with a minimum configuration of two nodes; and with the full load of 32 nodes. The terms used in the specification are:

$V_{OA}$ — True output voltage with respect to ground

$V_{OB}$ — Complimentary output voltage with respect to ground

$V_{OD}$ — Differential output voltage ( $V_{OA}-V_{OB}$ )

$V_{OS}$ — Offset voltage, or center point of  $V_{OA}$  or  $V_{OB}$ , also called  $V_{OC}$

$V_{CM}$ — Algebraic mean of  $V_{OA}$  and  $V_{OB}$ , including any ground potential difference or noise

The specifications are best represented by the following figures and table.

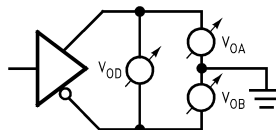

**Figure 1. No Load Configuration**

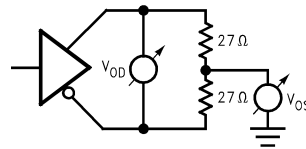

Figure 2. Termination Load Configuration

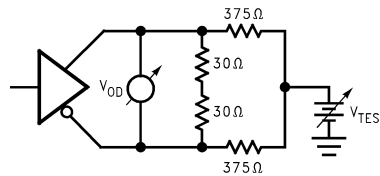

Figure 3. Full Load Configuration

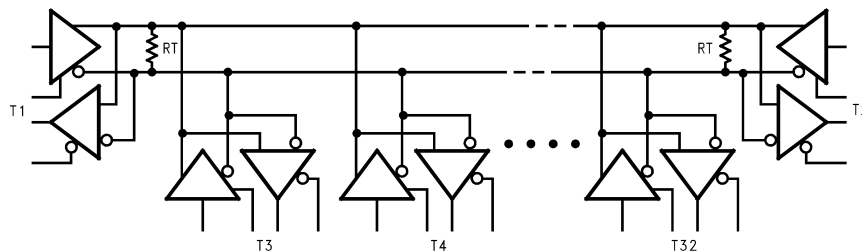

Figure 4. Typical RS-485 Application

Table 1. Driver Output Voltage Requirements

Configuration	Test	Min	Max	Units
No Load <a href="#">Figure 1</a>	$V_{OD1}$	1.5	6.0	V
	$V_{OA}$	0	6.0	V
	$V_{OB}$	0	6.0	V
Termination <a href="#">Figure 2</a>	$V_{OD2}$	1.5	5.0	V
	$V_{OS}$	-1.0	3.0	V
Full Load <a href="#">Figure 3</a>	$V_{OD3}$	1.5	5.0	V
	with $-7V \leq V_{CM} \leq +12V$			

There is also a condition that the driver must not be damaged when the outputs are shorted to each other or any potential within the common mode range of  $-7V$  to  $+12V$ . The peak current under shorted conditions must be less than 250 mA. This point is key to multipoint operation, since contention may occur.

The data rate requirements have implications on the speed of the device. Switching characteristics must specify that the transition time ( $t_r$ ,  $t_f$ ) be  $\leq 0.3$  of the unit interval. The minimum unit interval for 10 Mbps at 40 feet is 100 ns so  $t_r/t_f \leq 33$  ns; for 100 kbps at 4000 feet it is 10  $\mu$ s so  $t_r/t_f \leq 3.3$   $\mu$ s.

A Unit Load is defined as a load on the bus, it is commonly a driver and a receiver. The result should be that the unit load does not load down the bus under power-on or power-off conditions. Driver leakage tends to be in micro-amps but receiver input current can be significant compared to driver leakage. Four points define the unit load, shown in [Figure 5](#).

Rec. Input current ( $I_{IN}$ ) at  $+12V \leq 1$  mA

$I_{IN}$  between  $+5V$  and  $+12V \geq 0$  mA

$I_{IN}$  at  $-7V \geq -0.8$  mA

$I_{IN}$  between  $-3V$  and  $-7V \leq 0$  mA

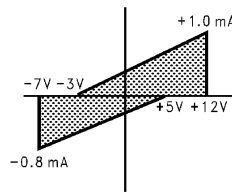

**Figure 5. V/I Relationship defining a Unit Load**

The shaded area effectively defines the receiver input impedance ( $R_{IN}$ ),  $\geq 10.6 \text{ k}\Omega$  ( $19\text{V}/1.8 \text{ mA}$ ). The standard does not require a specific impedance, only that it falls within the shaded area.

The key receiver requirements are its threshold voltage levels and common mode range. The receiver output must be HIGH if the true input is more than 200 mV above the complimentary input; LOW if it is more than 200 mV below the complimentary input. This must be possible with the inputs varying from  $-7\text{V}$  to  $+12\text{V}$ . A graphic representation is shown in Figure 6. In this diagram, the lightly shaded region represents the range of points where RI is more than 200 mV below  $RI^*$ ; therefore the output is LOW.

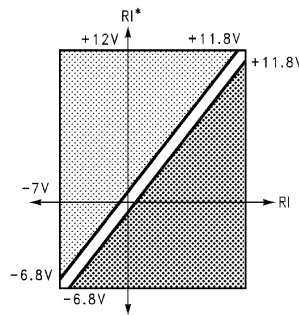

**Figure 6. Receiver Input Range**

The 200 mV receiver threshold and the 1.5V minimum differential driver output voltage provide 1.3V of differential noise margin. Since the bus is typically a twisted pair, ground noise is canceled out by the differential operation. The result is a bus that is well suited for high data rates and noisy environments.

There are further requirements such as balance of terminated voltage, balance of offset voltage and timing which can be reviewed in the standard. Note that all of these requirements should be met over the full supply voltage and temperature range in which the device will operate.

Interpreting the standard and creating device specifications appears to be straight forward. However, the range of practices shows that there are differing opinions.

### 3 Compatibility Tradeoffs

It is not always practical to meet all of the requirements. The devices may have limitations, the applications may not need full compliance or there may be a possible improvement in one area at the expense of another.

Commonly accepted minimum specifications for compatibility include  $V_{OD1}$ ,  $V_{OD2}$ ,  $I_{OS}$ ,  $V_{CM}$ ,  $V_{TH}$ . At times, these are specified at controlled conditions—not over the full operating range, as is required. Furthermore, “Up to 32 unit loads . . .” implies  $V_{OD3}$  and  $R_{IN}$  or the V/I relationship discussed above.  $V_{OD3}$  can be traded off if the application is not expected to be fully loaded.

$R_{IN}$  can be increased and thereby allowing more than 32 nodes to be connected without exceeding the 32 unit loads. For example, a  $R_{IN}$  of 24 k $\Omega$  implies that 64 nodes equates to 32 unit loads.

In many applications,  $I_{CC}$  is the differentiating factor. Optimizing a device for low power may slow switching speed. The end user may define the acceptable speed but switching speed is quite often defined by the choice of protocol.

Many low power technologies have lower breakdown voltages, which reduces the recommended maximum voltage range for the bus pins. The recommended voltage range for the bus pins defines how much protection the device has beyond the -7V to +12V common mode range. If the environment demands that the bus survive voltages up to  $\pm 24V$ , then the device must guarantee this, otherwise external protection must be included.

External limitations may dictate controlled edge rates to allow greater stub lengths or reduced EMI, which may result in a device that does not meet the prescribed data rate. All of these trade-offs must be considered in the design of the system.

#### 4 Implementation Issues

**Topology:** RS-485 is defined as a multi-point bus, (Figure 7) therefore multiple drivers and receivers can be connected to the bus at the same time (see discussion regarding unit load).

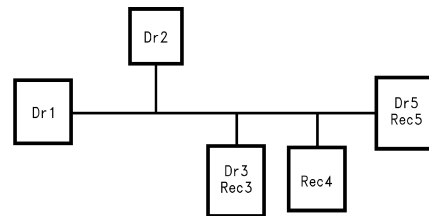

Figure 7. Bus Topology

In such a configuration, only one driver has control at a time and all the active receivers receive the same signals.

A ring which is created by connecting both ends of a bus together will not work. A traditional ring uses point-to-point links between the nodes. This can be implemented using RS-485, however, there are many other point-to-point technologies available.

Star configurations are also discouraged. In a star configuration (Figure 8) the device is effectively at the end of a very long stub, and this causes reflection and termination problems.

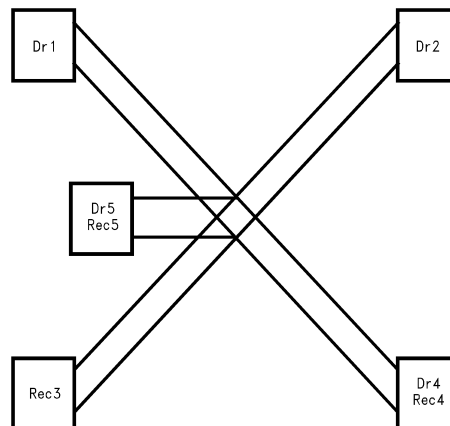
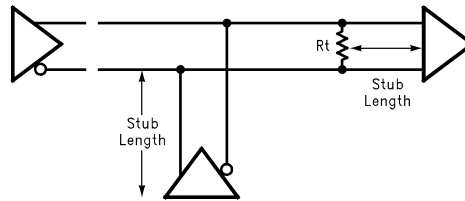

Figure 8. Star Topology

**Stubs:** RS-485 recommends keeping the stubs as short as practical. A stub is the distance from the device to the bus, or the termination resistor (in the case at the ends of the bus), see Figure 9. The maximum length is not defined by the standard, but longer stubs will have a negative impact on signal quality. This affect can be reduced by controlling the transition time of the driver.



**Figure 9. Stub Length**

The driven signal encounters a reflection at the end of the stub, if this occurs within the rising edge of the signal then it can be neglected. A general rule is that stubs should be less than  $\frac{1}{3}$  of the transition time. Therefore, slowing the transition time can extend the practical stub length.

**stub  $l$** —  $\leq \frac{1}{3}$  (transition time)/(velocity)  
 $l_{ft} \leq \frac{1}{3} (t_r \text{ or } t_f) / (1.5 \text{ ns/ft})$

**Number of Nodes:** The standard allows 32 unit loads, as defined by the driver leakage and receiver impedance—this was intended to mean 32 transceivers. If a number of the devices guarantee a greater impedance, then it is possible to add more than 32 transceivers to a bus.

**Termination:** RS-485 has defined the termination as  $120\Omega$  parallel termination at each end of the bus. This assumes a characteristic impedance in the range of  $Z_0 = 100\Omega$  to  $120\Omega$  for the cable. Other termination schemes could be implemented, but a thorough analysis must be done to assure adequate signal quality. For more information on termination, see AN-903.

**Bus Faults:** This bus is defined to be resistant to many of the faults associated with a cable environment such as noise and variations in device ground. It is built for party line applications so it can withstand driver contention. In most cases, there is enough noise margin to detect a valid HIGH or LOW. However, in the case where both lines are open or there is a short between the two lines, the state may be unknown. Such a case requires the designer to implement a “failsafe” scheme to bias the receiver to a known state. See AN-847 and AN-903 for a detailed discussion of failsafe techniques.

**Data Rate:** Earlier, the data rate vs distance guidelines were given as 10 Mbps at 40 feet and 100 kbps at 4000 feet. Advances in technology continue to push these limits. At long distances the practical limitation is dominated by the rise time degradation due to the cable. The approximate delay associated with  $100\Omega$  cable is 1.5 ns/foot. Therefore, 4000 feet of cable will cause 6  $\mu\text{s}$  of delay—which limits the data rate to 333 kbps (166 kHz) before device delays are involved. At 100 feet only 150 ns of delay are added by the cable, so an ideal driver/receiver could switch at 10 Mbps theoretically. Further complications are added by encoding schemes (PWM, RTZ, etc.) and protocol requirements (idle time, overhead, etc.). If an off-set bias is implemented for receiver failsafe, this may induce some signal distortion or cause slight duty cycle distortion which must be factored in to the data rate considerations.

RS-485 is defined as a half-duplex bus, though many applications use multiple channels in parallel or full-duplex. In parallel bus applications, channel-to-channel skew becomes a critical issue. These and possible protocol requirements would have to be considered in the evaluation of each device.

**Supply Power:**  $I_{CC}$  is not always the dominant indicator of power requirements. Low power CMOS devices require little quiescent current, typically less than 1 mA. However, when switching against a heavy load, the load current can be over 60 mA! And switching at higher frequencies also requires more current. Comparing bipolar and CMOS devices should include the case when switching a heavy load at high frequencies as well as the quiescent case. The total requirement will depend on the portion of time at idle versus switching.

**Signal Quality:** At the extremes of distance and data rate, the signal quality will be degraded. This is a qualitative parameter that is usually judged with eye patterns or in probabilities of errors.

Eye patterns show the effects of intersymbol interference, a hypothetical example is shown in [Figure 10](#). A full discussion on signal quality is given in AN-808.

**Interfacing to other standards:** This bus is not intended to be inter-operable with other standards such as TIA/EIA-232-E or ECL. TIA/EIA-422-B buses can accept RS-485 devices, but the opposite case is not true for the drivers. For a full discussion on this topic, see AN-972. The international standard ISO 8482.1994 has recently become compatible with RS-485.

## 5 Practical Limits

Theoretical limits defined by the standard should not be exceeded without fully examining the trade-offs discussed above. However, there are some common practices which can extend RS-485 beyond its defined limits.

The maximum number of nodes can exceed 32.  $R_{IN}$  can be defined as  $\frac{1}{2}$  unit load or  $\frac{1}{4}$  unit load, thus extending the number of nodes that can be attached to a single bus to 64 or 128 respectively. The leakage specifications must also support the stated unit load. Note that a bus with 128 nodes requires that the average loading be  $\frac{1}{4}$  unit load—including any third-party nodes that may be attached. Not all devices need the same unit load rating, but the total cannot exceed 32 unit loads.

The common-mode voltage range requirements continue to be a factor that limits many other types of interfaces. TIA/EIA-422-B offers a common-mode range of  $\pm 7V$ , but does not allow multiple drivers on the bus. The process technologies and design techniques required to meet the  $-7V$  to  $+12V$  range are somewhat unique. In fact, many applications see common-mode voltages beyond this range, such as  $\pm 24V$ ! Generally, reducing common-mode voltage in trade for any performance or integration gains has not been acceptable. Increasing common-mode beyond the RS-485 limits depends on the specific devices; wider common-mode may affect the thresholds and hysteresis of the receiver which reduces the noise margin.

Speed and power requirements are opposing trends: higher data rates tend to use more power, yet lower power ( $I_{CC}$ ) technologies tend to be slower. Technologies that effectively combine both high speed and low power are becoming available, and will come down in cost. Optimizing for speed in excess of the RS-485 limits may require technologies that consume greater quiescent current. In applications that are not transmitting for extended periods, optimizing for low power is common. Such devices may not meet the 10 Mbps data rate referenced in RS-485, which is acceptable since many of these applications are specified between 9600 bps and 1 Mbps.

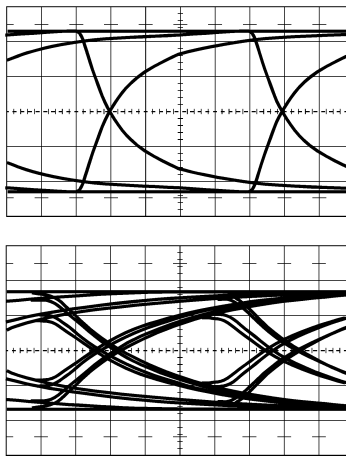

**Figure 10. Eye Patterns**

## 6 Conclusion

RS-485 is a well-defined, multi-purpose electrical specification for multi-point data transmission. The standard allows manufacturers to optimize devices for speed and power. Despite the definition, there is still potential for compatibility issues if the devices are not fully specified.

Many of the limits imposed in RS-485 can be exceeded at some cost and with increased risk. But technology barriers are continuously being removed and this promises tremendous performance gains, perhaps eliminating those costs and risks.

RS-485 is a very rugged standard for multi-point applications. It has proven to be popular over a span of many years. With the breadth of devices available and new technologies being applied, RS-485 will continue for many years to come.

## 7 References

EIA RS-485 standard for differential multi-point data transmission

TIA/EIA-422-B standard for differential multi-drop data transmission

ISO 8482.1994 Information processing systems—Data communication Twisted pair multipoint interconnections



## IMPORTANT NOTICE

Texas Instruments Incorporated and its subsidiaries (TI) reserve the right to make corrections, enhancements, improvements and other changes to its semiconductor products and services per JESD46, latest issue, and to discontinue any product or service per JESD48, latest issue. Buyers should obtain the latest relevant information before placing orders and should verify that such information is current and complete. All semiconductor products (also referred to herein as "components") are sold subject to TI's terms and conditions of sale supplied at the time of order acknowledgment.

TI warrants performance of its components to the specifications applicable at the time of sale, in accordance with the warranty in TI's terms and conditions of sale of semiconductor products. Testing and other quality control techniques are used to the extent TI deems necessary to support this warranty. Except where mandated by applicable law, testing of all parameters of each component is not necessarily performed.

TI assumes no liability for applications assistance or the design of Buyers' products. Buyers are responsible for their products and applications using TI components. To minimize the risks associated with Buyers' products and applications, Buyers should provide adequate design and operating safeguards.

TI does not warrant or represent that any license, either express or implied, is granted under any patent right, copyright, mask work right, or other intellectual property right relating to any combination, machine, or process in which TI components or services are used. Information published by TI regarding third-party products or services does not constitute a license to use such products or services or a warranty or endorsement thereof. Use of such information may require a license from a third party under the patents or other intellectual property of the third party, or a license from TI under the patents or other intellectual property of TI.

Reproduction of significant portions of TI information in TI data books or data sheets is permissible only if reproduction is without alteration and is accompanied by all associated warranties, conditions, limitations, and notices. TI is not responsible or liable for such altered documentation. Information of third parties may be subject to additional restrictions.

Resale of TI components or services with statements different from or beyond the parameters stated by TI for that component or service voids all express and any implied warranties for the associated TI component or service and is an unfair and deceptive business practice. TI is not responsible or liable for any such statements.

Buyer acknowledges and agrees that it is solely responsible for compliance with all legal, regulatory and safety-related requirements concerning its products, and any use of TI components in its applications, notwithstanding any applications-related information or support that may be provided by TI. Buyer represents and agrees that it has all the necessary expertise to create and implement safeguards which anticipate dangerous consequences of failures, monitor failures and their consequences, lessen the likelihood of failures that might cause harm and take appropriate remedial actions. Buyer will fully indemnify TI and its representatives against any damages arising out of the use of any TI components in safety-critical applications.

In some cases, TI components may be promoted specifically to facilitate safety-related applications. With such components, TI's goal is to help enable customers to design and create their own end-product solutions that meet applicable functional safety standards and requirements. Nonetheless, such components are subject to these terms.

No TI components are authorized for use in FDA Class III (or similar life-critical medical equipment) unless authorized officers of the parties have executed a special agreement specifically governing such use.

Only those TI components which TI has specifically designated as military grade or "enhanced plastic" are designed and intended for use in military/aerospace applications or environments. Buyer acknowledges and agrees that any military or aerospace use of TI components which have **not** been so designated is solely at the Buyer's risk, and that Buyer is solely responsible for compliance with all legal and regulatory requirements in connection with such use.

TI has specifically designated certain components which meet ISO/TS16949 requirements, mainly for automotive use. Components which have not been so designated are neither designed nor intended for automotive use; and TI will not be responsible for any failure of such components to meet such requirements.

### Products

Audio	<a href="http://www.ti.com/audio">www.ti.com/audio</a>
Amplifiers	<a href="http://amplifier.ti.com">amplifier.ti.com</a>
Data Converters	<a href="http://dataconverter.ti.com">dataconverter.ti.com</a>
DLP® Products	<a href="http://www.dlp.com">www.dlp.com</a>
DSP	<a href="http://dsp.ti.com">dsp.ti.com</a>
Clocks and Timers	<a href="http://www.ti.com/clocks">www.ti.com/clocks</a>
Interface	<a href="http://interface.ti.com">interface.ti.com</a>
Logic	<a href="http://logic.ti.com">logic.ti.com</a>
Power Mgmt	<a href="http://power.ti.com">power.ti.com</a>
Microcontrollers	<a href="http://microcontroller.ti.com">microcontroller.ti.com</a>
RFID	<a href="http://www.ti-rfid.com">www.ti-rfid.com</a>
OMAP Applications Processors	<a href="http://www.ti.com/omap">www.ti.com/omap</a>
Wireless Connectivity	<a href="http://www.ti.com/wirelessconnectivity">www.ti.com/wirelessconnectivity</a>

### Applications

Automotive and Transportation	<a href="http://www.ti.com/automotive">www.ti.com/automotive</a>
Communications and Telecom	<a href="http://www.ti.com/communications">www.ti.com/communications</a>
Computers and Peripherals	<a href="http://www.ti.com/computers">www.ti.com/computers</a>
Consumer Electronics	<a href="http://www.ti.com/consumer-apps">www.ti.com/consumer-apps</a>
Energy and Lighting	<a href="http://www.ti.com/energy">www.ti.com/energy</a>
Industrial	<a href="http://www.ti.com/industrial">www.ti.com/industrial</a>
Medical	<a href="http://www.ti.com/medical">www.ti.com/medical</a>
Security	<a href="http://www.ti.com/security">www.ti.com/security</a>
Space, Avionics and Defense	<a href="http://www.ti.com/space-avionics-defense">www.ti.com/space-avionics-defense</a>
Video and Imaging	<a href="http://www.ti.com/video">www.ti.com/video</a>

### TI E2E Community

[e2e.ti.com](http://e2e.ti.com)