

# **Simplifying Stability Checks**

John Stevens

*PMP - DC/DC Controllers*

## **ABSTRACT**

This application report explains a method for verifying relative stability of a circuit by showing the relationship between phase margin in an AC loop response and ringing in a load-step analysis.

### **Contents**

1	What is Stability and Phase Margin? .....	2
2	What is Ringing and How Does it Relate to Stability? .....	3
	2.1 Example Test Setup .....	4
	2.2 Examples of Load Step Analysis .....	4
	2.3 TPS5430 Laboratory Tests .....	6
3	Conclusion .....	7

### **List of Figures**

1	Calculating Phase Margin From a Frequency Response Plot .....	2
2	Comparison of Load Step Responses for Varying Phase Margin .....	3
3	Example Test Setup for Finding Step-Response .....	4
4	Load Step With Phase Margin = 45.7° (1 Peak) .....	4
5	Load Step With Phase Margin = 40.61° (2 Peaks) .....	5
6	Load Step With Phase Margin = 34.72° (3 Peaks) .....	5
7	Loop Response of TPS5430 Tested in Laboratory (Phase Margin = 55°) .....	6
8	Load-Step Response of TPS5430 Tested in Laboratory (Phase Margin = 55°) .....	6

### **List of Tables**

1	Phase Margin vs Ringing in Load-Step Response .....	3
---	---	---

## 1 What is Stability and Phase Margin?

When discussing control systems, stability is a term referring to the ability of a controller to regain a constant or decaying output after an input or load disturbance, such as a step function. Stability is an important criterion for control circuits because they have inherent delay in the feedback loop(s). If the output signal lags one full wavelength, it becomes superimposed on the input signal of the controller and the circuit becomes unstable and oscillates.

Phase margin (PM) is a measure of relative stability, in degrees, that indicates the likelihood of a closed-loop control system to oscillate when given a disturbance such as a step function. For systems with a negative angle phase response, the PM is the difference between  $-180^\circ$  (due to the inverting nature of most amplifiers) and the phase angle of the frequency response at the same frequency where the magnitude response is 1 or 0 db. For systems with a positive phase response, the phase margin is merely the phase itself at the frequency where the magnitude response is 1 or 0 db. A positive PM technically yields a *stable system* whereas a negative PM yields an unstable system. However, a system with a  $3^\circ$  PM, for example, is not necessarily stable because practical factors make such a small degree of margin unreliable. Thus, a PM of about  $45^\circ$  is considered generally acceptable, but this can vary based on the designer's preference. This classic method of finding the phase margin can be observed in [Figure 1](#).

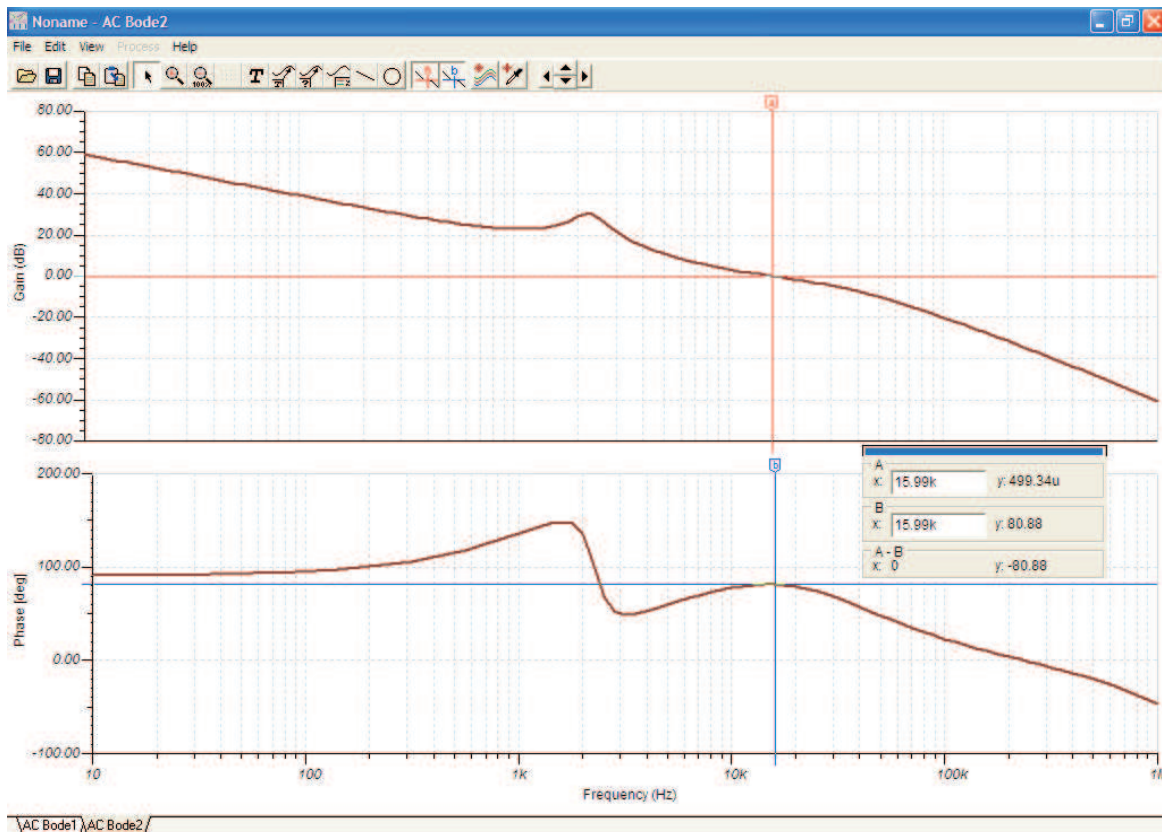

**Figure 1. Calculating Phase Margin From a Frequency Response Plot**

As can be seen in the plot of [Figure 1](#), an AC response, (Magnitude on top and Phase underneath), is given. The Magnitude Response plot is shown to be 0 db at 15.99 kHz. The phase at 15.99 kHz is  $80.88^\circ$ . Thus, the phase margin of this system is  $80.88^\circ$ .

Although this method is acceptable for simulated devices, in real systems it creates many problems. For example, many devices with control systems cannot tolerate the wide range of frequencies necessary for such an analysis. Further, to conduct such a test requires an isolation of the feedback loop which in some cases is difficult or impossible. Although tools such as network analyzers can test stability directly, the cost sometimes restricts their availability. Therefore, an alternate method to test stability using a common laboratory oscilloscope is now considered.

## 2 What is Ringing and How Does it Relate to Stability?

Ringling is the unwanted oscillation seen in a voltage or current signal when the input or load is changed very quickly. If the controller cannot correct the output properly, overshoot and/or undershoot can occur, until it is damped out according to the damping factor of the system. In the extreme case, the system becomes unstable and the output oscillates indefinitely at the frequency where the gain = 1 and phase margin is 0°. In a circuit with a positive phase margin, the oscillations decay and are limited in number. Considering this, it can be stated that fewer bumps (peaks) or ripples in the transient load-step response correspond to more damping and a higher phase margin. In [Figure 2](#), this relationship can be observed.

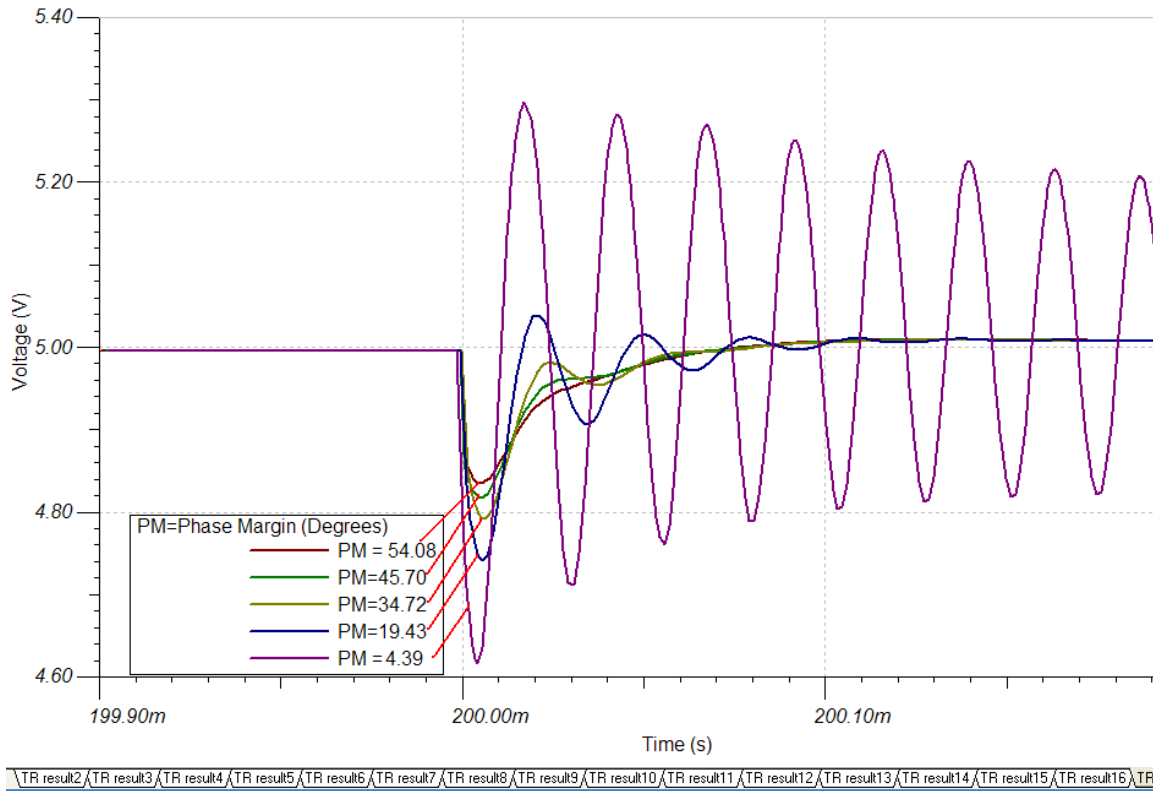

**Figure 2. Comparison of Load Step Responses for Varying Phase Margin**

As [Figure 2](#) illustrates, the response with the highest PM, 54.08°, (in brown), damps the fastest. As PM decreases, the number of oscillatory peaks increases until eventually, at very low PM, the circuit is in lightly damped oscillation. For a quick reference, see [Table 1](#).

**Table 1. Phase Margin vs Ringing in Load-Step Response**

Phase Margin (Degrees)	Ringing (Bumps)
80.88	0
60.75	0
57.64	0
54.08	0
50.16	1
45.7	1.5
40.61	2
34.72	3
27.78	4
19.43	6
9.09	17

## 2.1 Example Test Setup

The device under test (DUT) can be set up as seen in [Figure 3](#)

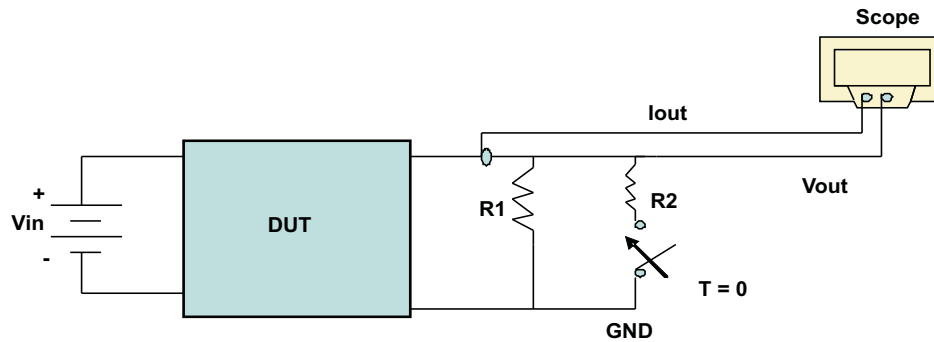

**Figure 3. Example Test Setup for Finding Step-Response**

## 2.2 Examples of Load Step Analysis

For a better definition of what an oscillatory *bump* or peak is, see [Figure 4](#), [Figure 5](#), and [Figure 6](#).

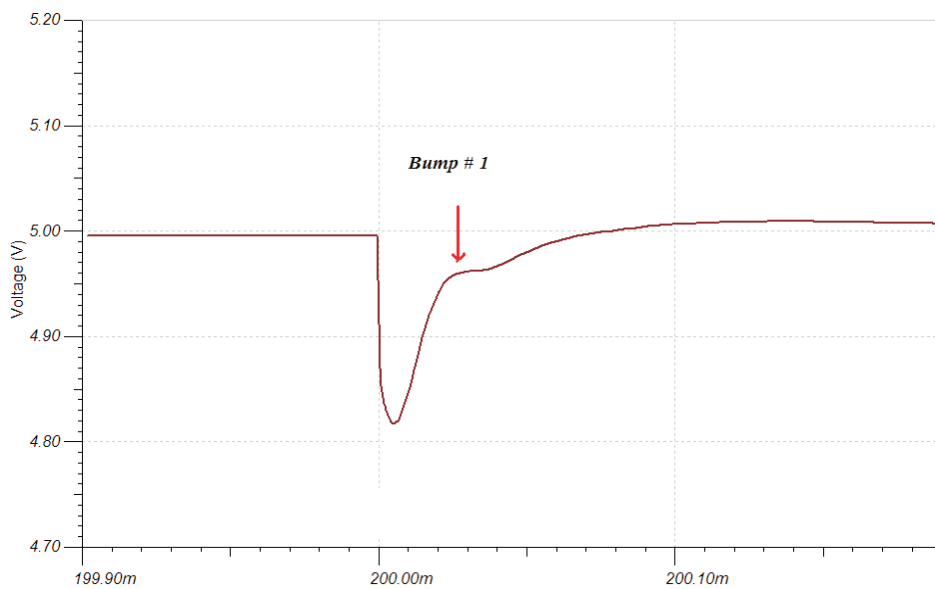

**Figure 4. Load Step With Phase Margin = 45.7° (1 Peak)**

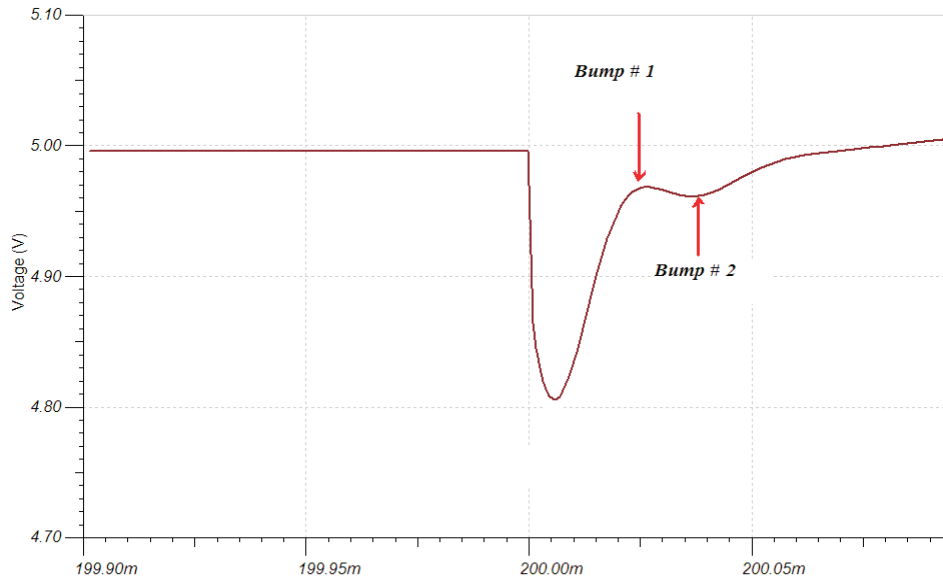

**Figure 5. Load Step With Phase Margin = 40.61° (2 Peaks)**

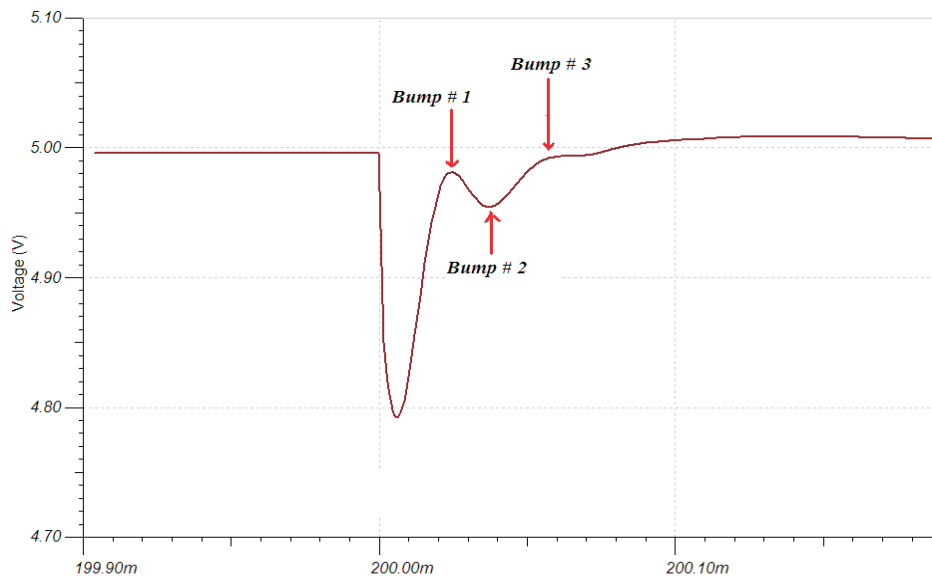

**Figure 6. Load Step With Phase Margin = 34.72° (3 Peaks)**

### 2.3 TPS5430 Laboratory Tests

To verify that these simulations produce realistic results, the TPS5430 was tested in a laboratory.

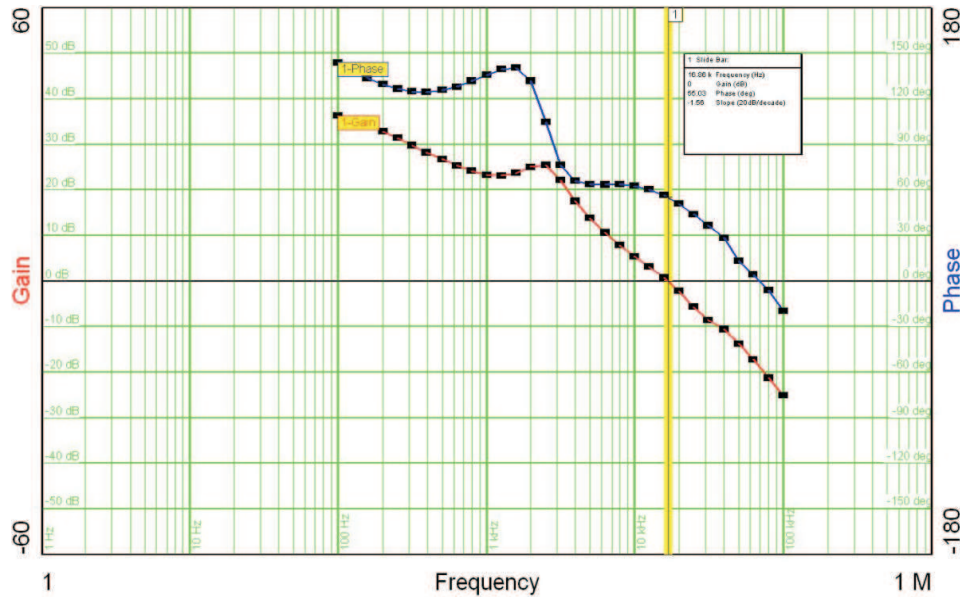
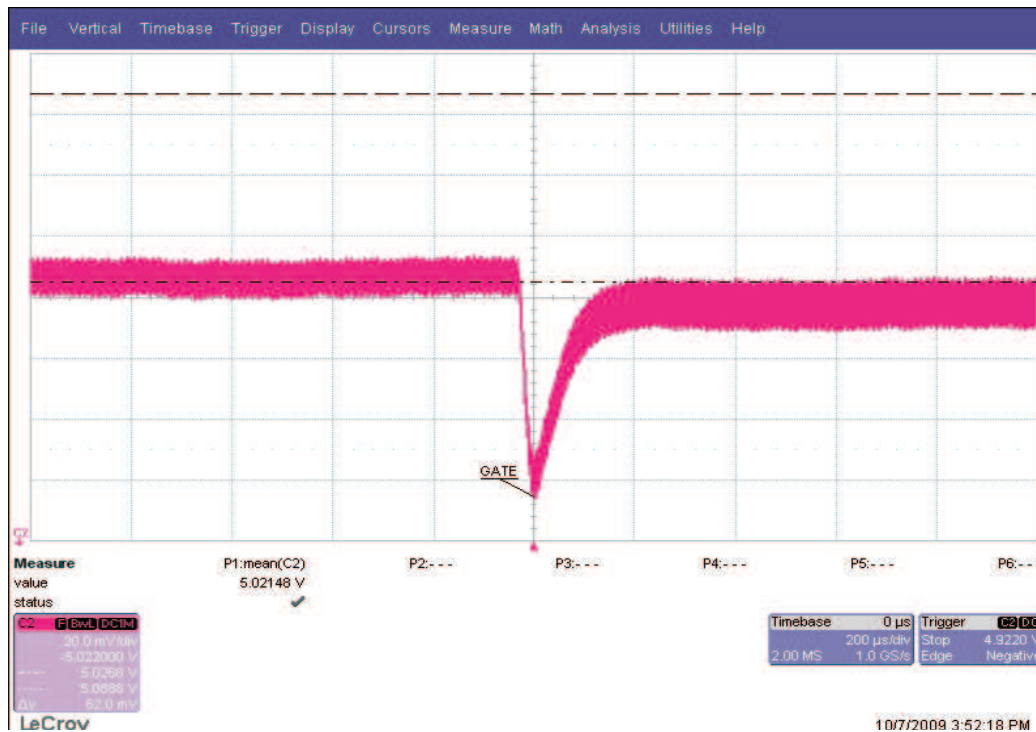

Figure 7. Loop Response of TPS5430 Tested in Laboratory (Phase Margin = 55°)



NOTE: Uses a 50% Load Step at 1-10µs Slew Rate

Figure 8. Load-Step Response of TPS5430 Tested in Laboratory (Phase Margin = 55°)

In the laboratory test of the load-step response in Figure 8, there are no oscillatory peaks. At a phase margin of 55°, this result matches what is found in Table 1.

---

### 3 Conclusion

This application report explains the link between the load-step response and the loop response of a given circuit. Based on this relationship, this document provides details to make an estimate at relative stability based on phase margin. The designer must always consider that this measurement requires some interpretation of load-step response and that these measurements can vary.

---

## Revision History

Changes from A Revision (September 2011) to B Revision	Page
• Changed 0 dB to 0° in 1st paragraph of <a href="#">Section 2</a> (typo) .....	3

---

NOTE: Page numbers for previous revisions may differ from page numbers in the current version.

## IMPORTANT NOTICE

Texas Instruments Incorporated and its subsidiaries (TI) reserve the right to make corrections, enhancements, improvements and other changes to its semiconductor products and services per JESD46, latest issue, and to discontinue any product or service per JESD48, latest issue. Buyers should obtain the latest relevant information before placing orders and should verify that such information is current and complete. All semiconductor products (also referred to herein as "components") are sold subject to TI's terms and conditions of sale supplied at the time of order acknowledgment.

TI warrants performance of its components to the specifications applicable at the time of sale, in accordance with the warranty in TI's terms and conditions of sale of semiconductor products. Testing and other quality control techniques are used to the extent TI deems necessary to support this warranty. Except where mandated by applicable law, testing of all parameters of each component is not necessarily performed.

TI assumes no liability for applications assistance or the design of Buyers' products. Buyers are responsible for their products and applications using TI components. To minimize the risks associated with Buyers' products and applications, Buyers should provide adequate design and operating safeguards.

TI does not warrant or represent that any license, either express or implied, is granted under any patent right, copyright, mask work right, or other intellectual property right relating to any combination, machine, or process in which TI components or services are used. Information published by TI regarding third-party products or services does not constitute a license to use such products or services or a warranty or endorsement thereof. Use of such information may require a license from a third party under the patents or other intellectual property of the third party, or a license from TI under the patents or other intellectual property of TI.

Reproduction of significant portions of TI information in TI data books or data sheets is permissible only if reproduction is without alteration and is accompanied by all associated warranties, conditions, limitations, and notices. TI is not responsible or liable for such altered documentation. Information of third parties may be subject to additional restrictions.

Resale of TI components or services with statements different from or beyond the parameters stated by TI for that component or service voids all express and any implied warranties for the associated TI component or service and is an unfair and deceptive business practice. TI is not responsible or liable for any such statements.

Buyer acknowledges and agrees that it is solely responsible for compliance with all legal, regulatory and safety-related requirements concerning its products, and any use of TI components in its applications, notwithstanding any applications-related information or support that may be provided by TI. Buyer represents and agrees that it has all the necessary expertise to create and implement safeguards which anticipate dangerous consequences of failures, monitor failures and their consequences, lessen the likelihood of failures that might cause harm and take appropriate remedial actions. Buyer will fully indemnify TI and its representatives against any damages arising out of the use of any TI components in safety-critical applications.

In some cases, TI components may be promoted specifically to facilitate safety-related applications. With such components, TI's goal is to help enable customers to design and create their own end-product solutions that meet applicable functional safety standards and requirements. Nonetheless, such components are subject to these terms.

No TI components are authorized for use in FDA Class III (or similar life-critical medical equipment) unless authorized officers of the parties have executed a special agreement specifically governing such use.

Only those TI components which TI has specifically designated as military grade or "enhanced plastic" are designed and intended for use in military/aerospace applications or environments. Buyer acknowledges and agrees that any military or aerospace use of TI components which have **not** been so designated is solely at the Buyer's risk, and that Buyer is solely responsible for compliance with all legal and regulatory requirements in connection with such use.

TI has specifically designated certain components as meeting ISO/TS16949 requirements, mainly for automotive use. In any case of use of non-designated products, TI will not be responsible for any failure to meet ISO/TS16949.

### Products

Audio	<a href="http://www.ti.com/audio">www.ti.com/audio</a>
Amplifiers	<a href="http://amplifier.ti.com">amplifier.ti.com</a>
Data Converters	<a href="http://dataconverter.ti.com">dataconverter.ti.com</a>
DLP® Products	<a href="http://www.dlp.com">www.dlp.com</a>
DSP	<a href="http://dsp.ti.com">dsp.ti.com</a>
Clocks and Timers	<a href="http://www.ti.com/clocks">www.ti.com/clocks</a>
Interface	<a href="http://interface.ti.com">interface.ti.com</a>
Logic	<a href="http://logic.ti.com">logic.ti.com</a>
Power Mgmt	<a href="http://power.ti.com">power.ti.com</a>
Microcontrollers	<a href="http://microcontroller.ti.com">microcontroller.ti.com</a>
RFID	<a href="http://www.ti-rfid.com">www.ti-rfid.com</a>
OMAP Applications Processors	<a href="http://www.ti.com/omap">www.ti.com/omap</a>
Wireless Connectivity	<a href="http://www.ti.com/wirelessconnectivity">www.ti.com/wirelessconnectivity</a>

### Applications

Automotive and Transportation	<a href="http://www.ti.com/automotive">www.ti.com/automotive</a>
Communications and Telecom	<a href="http://www.ti.com/communications">www.ti.com/communications</a>
Computers and Peripherals	<a href="http://www.ti.com/computers">www.ti.com/computers</a>
Consumer Electronics	<a href="http://www.ti.com/consumer-apps">www.ti.com/consumer-apps</a>
Energy and Lighting	<a href="http://www.ti.com/energy">www.ti.com/energy</a>
Industrial	<a href="http://www.ti.com/industrial">www.ti.com/industrial</a>
Medical	<a href="http://www.ti.com/medical">www.ti.com/medical</a>
Security	<a href="http://www.ti.com/security">www.ti.com/security</a>
Space, Avionics and Defense	<a href="http://www.ti.com/space-avionics-defense">www.ti.com/space-avionics-defense</a>
Video and Imaging	<a href="http://www.ti.com/video">www.ti.com/video</a>

### TI E2E Community

[e2e.ti.com](http://e2e.ti.com)