PurePath™ Smart Amp for Laptops

Jorge Arbona

High Performance Analog / Audio

ABSTRACT

Laptop computers have special time requirements and memory restrictions that are not usually present on other device form factors. This report discusses methods to configure the Smart Amp device in a basic mode during the computer Power-on Self-test (POST) to overcome these limitations. Download times and memory requirements are also presented for each configuration. Project collateral discussed in this application report can be downloaded from the following URL: <http://www.ti.com/lit/zip/SLAA653>.

WARNING: EXPORT NOTICE

Recipient agrees to not knowingly export or re-export, directly or indirectly, any product or technical data (as defined by the U.S., EU, and other Export Administration Regulations) including software, or any controlled product restricted by other applicable national regulations, received from Disclosing party under this Agreement, or any direct product of such technology, to any destination to which such export or re-export is restricted or prohibited by U.S. or other applicable laws, without obtaining prior authorization from U.S. Department of Commerce and other competent Government authorities to the extent required by those laws. This provision shall survive termination or expiration of this Agreement. According to our best knowledge of the state and end-use of this product or technology, and in compliance with the export control regulations of dual-use goods in force in the origin and exporting countries, this technology is classified as follows:

**US ECCN: 3E991
EU ECCN: EAR99**

And may require export or re-export license for shipping it in compliance with the applicable regulations of certain countries.

Contents

1	General Overview	3
1.1	Tips 3	
1.2	Supported Smart Amp Devices	4
2	Background Information	4
3	Configuration Modes	7
3.1	Basic Mode.....	7
3.2	Smart Amp Mode.....	9
3.3	Sleep Commands.....	9
3.4	Wake Commands.....	9
4	Audio Driver	10
5	Configuration Options	10
5.1	Configuration 1	11
5.2	Configuration 2	12
5.3	Configuration 3	13
5.4	Configuration 4	14
6	Generating Output Files	15
	References	17
	Appendix A. Reset Block	18
	Appendix B. Sleep Block	19
	Appendix C. Basic Mode Block	20
	Appendix D. Config Block	21
	Appendix E. Wake Block	22
	Appendix F. Smart Amp Mode Block	23
	Appendix G. I-RAM Block	24
	Appendix H. C-RAM Buffer A Block	25
	Appendix I. C-RAM Buffer B Block	26
	Revision History	27
	Trademarks	27

Figures

Figure 1.	TAS5766M miniDSP Memory Access	5
Figure 2.	Audio Driver with .cfg File Pipe	10
Figure 3.	Configuration 1	11
Figure 4.	Configuration 2	12
Figure 5.	Configuration 3	13
Figure 6.	Configuration 4	14
Figure 7.	Example .reg file	15
Figure 8.	Output .h file	15
Figure 9.	Example .reg File using the Dump Feature	15
Figure 10.	Output .h File using the Dump Feature	16
Figure 11.	Burst Size Configuration	16
Figure 12.	Output .h File using the Dump Feature (Burst = 128)	16
Figure 13.	Reset Block Code	18
Figure 14.	Sleep Block Code	19
Figure 15.	Basic Mode Block Code	20
Figure 16.	Config Block Code	21
Figure 17.	Wake Block Code	22
Figure 18.	Smart Amp Mode Block Code	23

Figure 19.	I-RAM Block Code	SLAA653A – November 2014 – Revised March 2015	24
Figure 20.	C-RAM Buffer A Block Code.....		25
Figure 21.	C-RAM Buffer B Block Code.....		26

Tables

Table 1.	Memory Access Control Bits.....		5
Table 2.	TAS5766M Worst-Case Download Time and Memory Requirements.....		6
Table 3.	Page 0 / Register 61		8
Table 4.	Page 0 / Register 62		8
Table 5.	Configuration 1 Download Time and Memory Requirements		11
Table 6.	Configuration 2 Download Time and Memory Requirements		12
Table 7.	Configuration 3 Download Time and Memory Requirements		13
Table 8.	Configuration 4 Download Time and Memory Requirements		14
Revision History			27

1 General Overview

This document was developed to help the software and hardware engineer:

- Understand the problem by providing background information (Chapter [2](#))
- Understand the Basic and Smart Amp configuration modes (Chapter [3](#))
- Explore the configuration options (Chapter [5](#))

1.1 Tips

When selecting a code snippet for copy-paste, select the entire block not just the text, as the following image shows:

```

# Command Dump Configuration
#-----
# Project: PurePath™ Smart Amp for Laptops
# SA Plug-in Version: TAS5766MDCAEVM v4.0010
# Configuration: Reset
# Version: 20141008
#-----
#
#-----
# Reset
#-----

# Select Page 0
0 = 0x00

# Set the device into Powerdown
2 = 0x11

# Reset Device
1 = 0x11
  
```

1.2 Supported Smart Amp Devices

This document pertains to the following Smart Amp devices:

1. [TAS5766M](#)
2. [TAS5768M](#)

2 Background Information

Laptop computers have special time requirements and memory restrictions that are not usually present on other device form factors:

1. The computer *Power-on Self-test* (POST) must complete within a defined time, which depends on the hardware configuration of the computer [1]. This limits the time available to download the Smart Amp code into the Smart Amp device.
2. The *Basic Input/Output System* (BIOS) of the computer might limit how much Smart Amp code can be stored.

There are several methods that can be employed to mitigate these restrictions which are explained in the following sections.

The TAS5766M has an integrated miniDSP with volatile memory for instructions (I-RAM) and coefficients (C-RAM). [Figure 1](#) shows a high-level overview of this architecture.

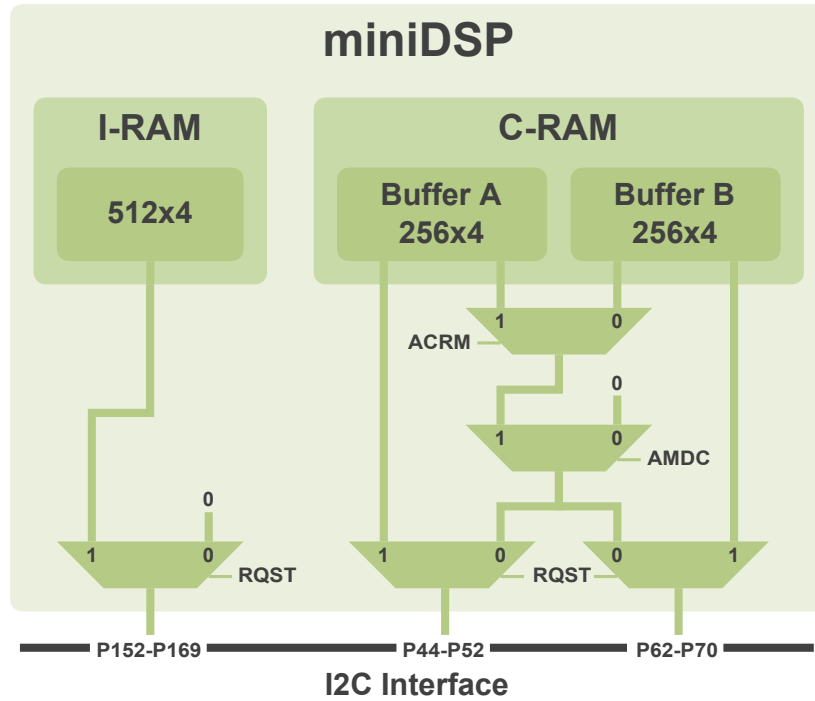

Figure 1. TAS5766M miniDSP Memory Access

Looking at [Figure 1](#) and [Table 1](#), it can be concluded that I-RAM and C-RAM are fully accessible through I²C during *Standby Mode* and C-RAM is partially available in *Adaptive Mode*.

Table 1. Memory Access Control Bits

Name	Page / Register / Bit(s)	Description
RQST	P0_R2_D4	Standby Request
AMDC	P44_R1_D2	Adaptive Mode Control
ACRM	P44_R1_D3	Active CRAM Monitor

In summary:

1. When the TAS5766M is in *Standby Mode* (RQST = 1), I-RAM is available through P152-P169, C-RAM Buffer A is available through P44-P52 and C-RAM Buffer B is available through P62-70 via the I²C interface.
2. When the TAS5766M is in *Active Mode* (RQST = 0) and in *Non-adaptive Mode* (AMDC = 0), I-RAM and C-RAM cannot be accessed via the I²C interface.
3. When the TAS5766M is in *Active Mode* (RQST = 0) and in *Adaptive Mode* (AMDC = 1), only one of the C-RAM buffers can be accessed via the I²C interface based on the ACRM bit status.

An important detail is that the I-RAM contents are retained even if the device is reset. Only a power cycle of the 3.3-V supplies will clear the I-RAM contents. C-RAM is set to its default when reset.

Refer to the *PurePath™ Smart Amp Design Guide* for additional details on accessing C-RAM. See [\[2\]](#) for information on how to obtain this document.

Table 2 shows the worst-case download time and memory requirements for the TAS5766M. The Smart Amp code itself may take a little less time to download since it may consume less I-RAM and C-RAM resources but should be close these numbers. The download time row assumes no time between I²C transactions (that is, $t_{BUF} = 0$). However, the minimum time allowed between STOP and START commands by the I²C specification should not impact these numbers significantly.

Table 2. TAS5766M Worst-Case Download Time and Memory Requirements

	miniDSP I-RAM	miniDSP C-RAM	Configuration	Total
Words	512	512	-	1024
Data Bytes	2048	2048	21	4117
Overhead Bytes	90	90	42	222
Total Bytes	2138	2138	63	4339
I²C Download Time (ms)				
400 kHz	48.11	48.11	1.42	97.63
100 kHz	192.42	192.42	5.67	390.51

Note that it takes approximately 18 ms for the output to produce a pulse-width modulation (PWM) signal once the TAS5766M is configured in *Active Mode* or the *Audio Serial Interface* (ASI) is provided in *Active Mode*.

3 Configuration Modes

As shown in the accompanying diagram, the TAS5766M can be configured into a *Basic Mode* during *POST* to reduce the size and download time at this stage. Basic Mode remains active during *MS-DOS® Mode* or an operating system (OS) installation.

If the computer boots the operating system, it can load *Smart Amp Mode* through the audio driver through the *Chipset* or the *Embedded Controller (EC)*. The *Smart Amp Mode* code can reside on the driver itself or the EC.

Once the OS has completed the booting process, it is considered Active.

If the OS issues a sleep event, the audio driver can issue a *Sleep* command to the TAS5766M.

Once the OS issues a wake event, the audio driver can issue a *Wake* command to the TAS5766M.

If the system does not have any restrictions on size and download time during *POST*, then there is no need to load *Basic Mode*. *Smart Amp Mode* could be loaded directly in such case.

The following subsections discuss details on:

1. Basic Mode
2. Smart Amp Mode
3. Sleep
4. Wake

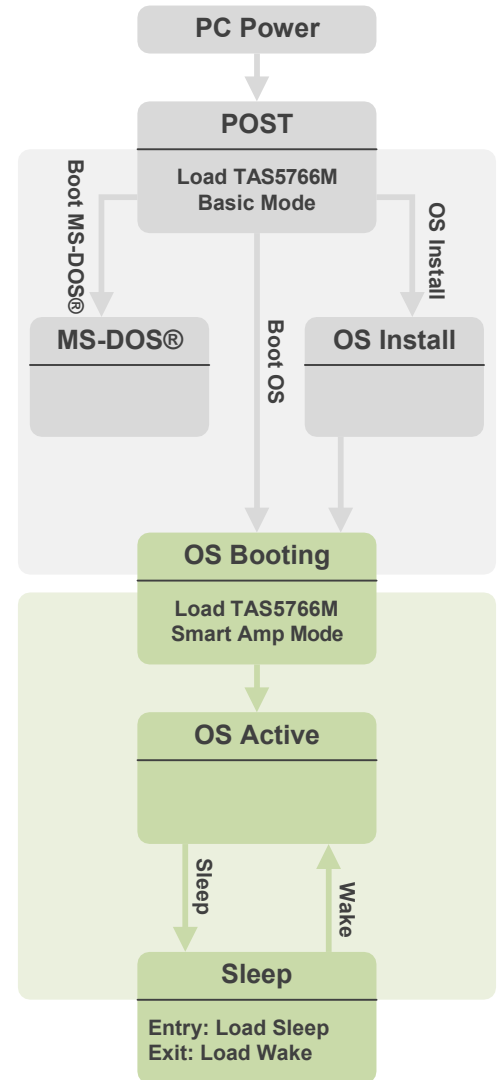

The actual implementation options for these configurations are presented in Chapter 5.

3.1 Basic Mode

Basic Mode allows playback to the laptop loudspeaker without exceeding its power handling specification. It simply configures the TAS5766M with no processing and a fixed output level.

As explained in the *PurePath™ Smart Amp Design Guide*, the peak amplitude corresponding to a particular loudspeaker power handling level can be calculated by the following equation:

$$V_{pk,asic} = \sqrt{2P_{ave,spk} \times Z_L}$$

For example, an 8-ohm speaker rated for 5 W can withstand a 9 V_{pk} sinusoid. The goal is to configure the TAS5766M *Digital Volume* control in Basic Mode such that the calculated peak level is never exceeded. The *Digital Volume* control is available on *Page 0 / Registers 61 and 62*, as shown in the following tables.

Table 3. Page 0 / Register 61

Dec	Hex	b7	b6	b5	b4	b3	b2	b1	b0
61	3D	VOLL7	VOLL6	VOLL5	VOLL4	VOLL3	VOLL2	VOLL1	VOLL0
Reset Value		0	0	1	1	0	0	0	0

VOLL[7:0]
Left Digital Volume

These bits control the left channel digital volume. The digital volume is 0 dB to -103 dB in -0.5 dB steps.

Default value: 00110000

00000000: Reserved

00000001: Reserved

...

00101111: Reserved

00110000: 0.0 dB

00110001: -0.5 dB

...

11111110: -103 dB

11111111: Mute

Table 4. Page 0 / Register 62

Dec	Hex	b7	b6	b5	b4	b3	b2	b1	b0
62	3E	VOLR7	VOLR6	VOLR5	VOLR4	VOLR3	VOLR2	VOLR1	VOLR0
Reset Value		0	0	1	1	0	0	0	0

VOLR[7:0]
Right Digital Volume

These bits control the right channel digital volume. The digital volume is 0 dB to -103 dB in -0.5 dB steps.

Default value: 00110000

00000000: Reserved

00000001: Reserved

...

00101111: Reserved

00110000: 0.0 dB

00110001: -0.5 dB

...

11111110: -103 dB

11111111: Mute

Refer to the *Calibrating the System Gain in the End-System* section of the *PurePath™ Smart Amp Design Guide* document for details on obtaining the System Gain. Once the System Gain is known, the TAS5766M *Digital Volume* level can be calculated as follows:

$$G_{digital} = 20 \times \log \frac{V_{pk,asic}^{10}}{G_{system}}$$

As an example, if 9 V is the peak voltage to keep the loudspeaker within specifications and the system gain is 28, then the digital gain setting must be configured as -10dB (or 0x44) for both channels. This value should be entered in the Basic Mode block (see [Appendix C](#)).

3.2 Smart Amp Mode

Smart Amp Mode simply configures the TAS5766M into Smart Amp mode. In this mode, the tuning performed with the PurePath™ Console software should be implemented.

3.3 Sleep Commands

The TAS5766M should be set into sleep when the computer goes to sleep to save power. During this time, all 3.3-V supplies should be present in order to keep the device configuration intact.

3.4 Wake Commands

Once the PVCC supply is stable, the device status can be restored when the computer wakes from Sleep.

4 Audio Driver

Texas Instruments does not provide audio drivers to implement this functionality. However, this application report does provide recommendations on its implementation.

Once the final Smart Amp tuning is complete, the resulting header files generated by the PurePath™ Console software (see Chapter 6) can be compiled into the driver. This may seem straightforward; however, audio engineers might want to work with several tunings before considering these final. To assist with this tuning process, a pipe in the driver to parse .cfg text files could be used during development (DEBUG = 1), as shown in Figure 2. This allows the developer to tune without having to recompile the driver code.

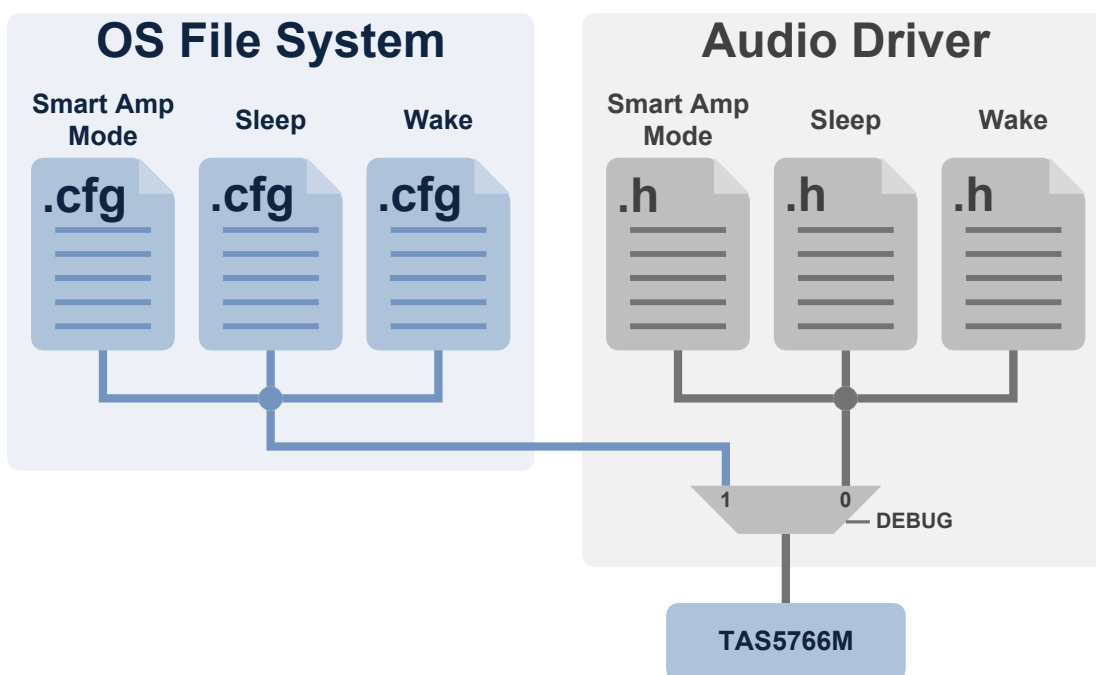

Figure 2. Audio Driver with .cfg File Pipe

5 Configuration Options

This chapter describes several configuration options and their size and download time requirements. To create a *Mode*, simply copy and paste the *Blocks* from the Appendix sections into a custom .reg file. These files and how to generate output cfg and header files are described in Chapter 6.

5.1 Configuration 1

This configuration writes the Smart Amp Mode I-RAM in Basic Mode.

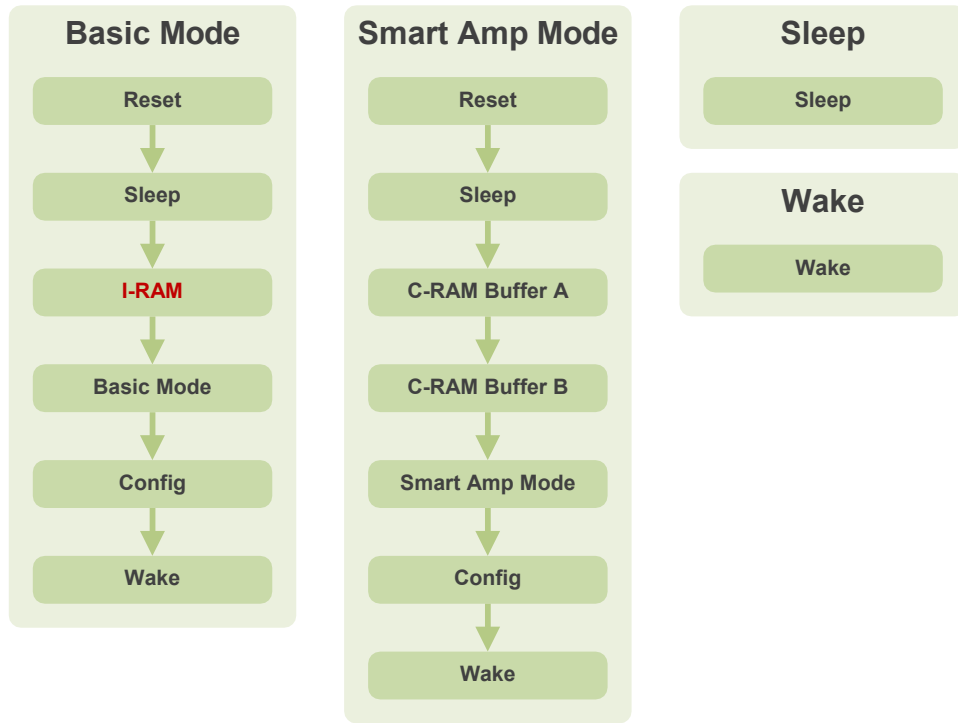

Figure 3. Configuration 1

Table 5. Configuration 1 Download Time and Memory Requirements

	Basic Mode	Smart Amp Mode	Sleep	Wake
Data Bytes	2069	2063	3	3
Overhead Bytes	132	120	6	6
Total Bytes	2201	2183	9	9
I²C Download Time (ms)				
400 kHz	49.52	49.12	0.20	0.20
100 kHz	198.09	196.47	0.81	0.81

5.2 Configuration 2

This configuration removes the C-RAM Buffer B configuration. This should only be used if Smart Amp parameters (for example, volume) are **not** changed on-the-fly.

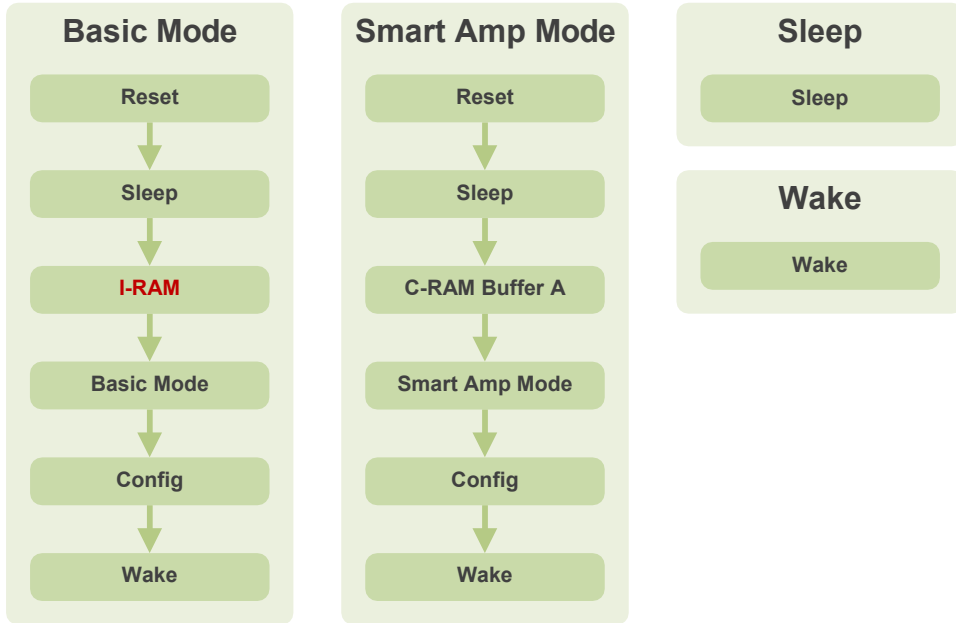

Figure 4. Configuration 2

Table 6. Configuration 2 Download Time and Memory Requirements

	Basic Mode	Smart Amp Mode	Sleep	Wake
Data Bytes	2069	1039	3	3
Overhead Bytes	132	75	6	6
Total Bytes	2201	1114	9	9
I ² C Download Time (ms)				
400 kHz	49.52	25.07	0.20	0.20
100 kHz	198.09	100.26	0.81	0.81

5.3 Configuration 3

This configuration reduces code size and download times during POST.

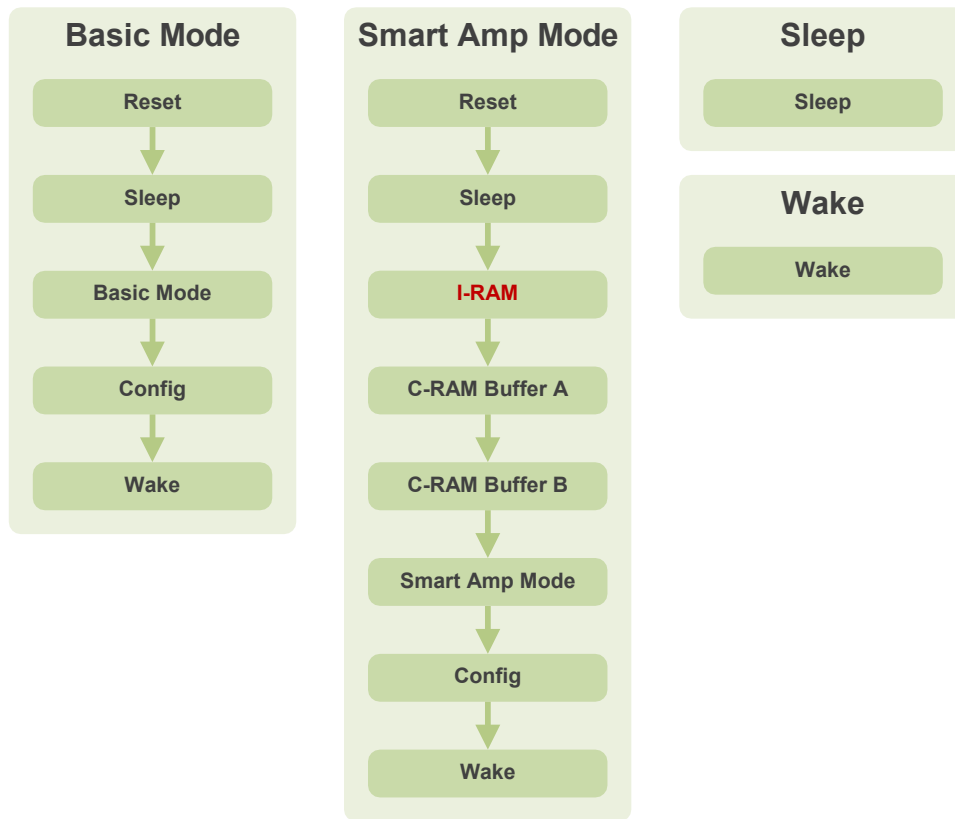

Figure 5. Configuration 3

Table 7. Configuration 3 Download Time and Memory Requirements

	Basic Mode	Smart Amp Mode	Sleep	Wake
Data Bytes	21	4111	3	3
Overhead Bytes	42	210	6	6
Total Bytes	63	4321	9	9
I²C Download Time (ms)				
400 kHz	1.42	97.22	0.20	0.20
100 kHz	5.67	388.89	0.81	0.81

5.4 Configuration 4

This configuration reduces code size and download times during POST and removes the C-RAM Buffer B configuration. This should only be used if Smart Amp parameters (for example, volume) are **not** changed on-the-fly.

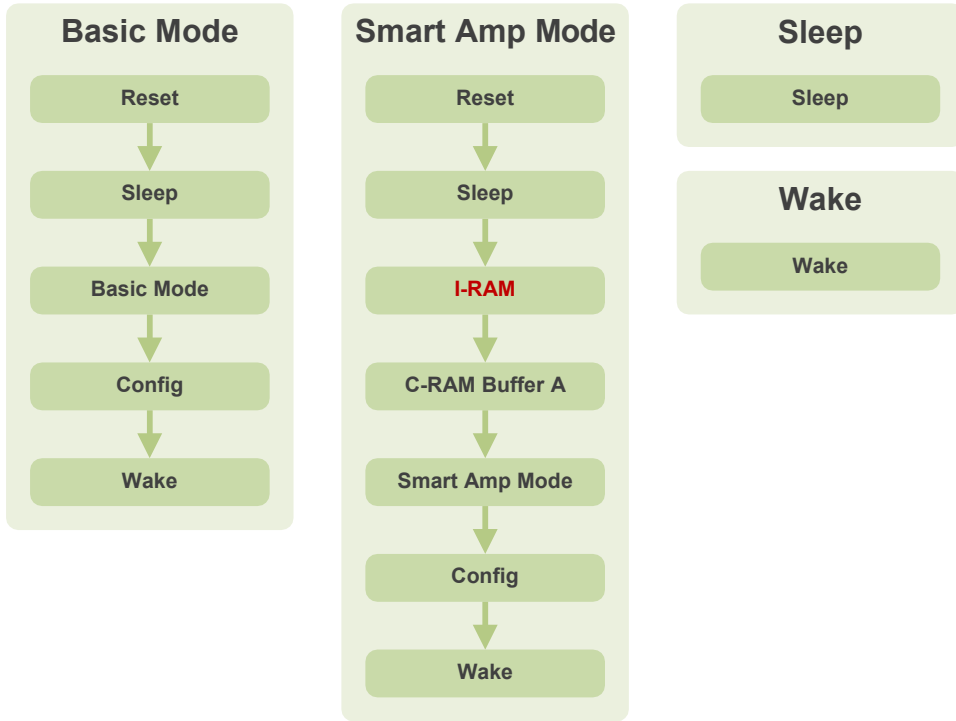

Figure 6. Configuration 4

Table 8. Configuration 4 Download Time and Memory Requirements

	Basic Mode	Smart Amp Mode	Sleep	Wake
Data Bytes	21	3087	3	3
Overhead Bytes	42	165	6	6
Total Bytes	63	3252	9	9
I ² C Download Time (ms)				
400 kHz	1.42	73.17	0.20	0.20
100 kHz	5.67	292.68	0.81	0.81

6 Generating Output Files

As explained in the *PurePath™ Smart Amp Design Guide* and the *PurePath Console Quick Start User Guide* documents, *Dump Definition Files* (.reg extension) define how the output .cfg or .h file will be generated based on the contents of the device. This process should be performed once the desired Smart Amp tuning is performed and requires having the TAS5766M EVM connected to the *PurePath™ Console* software.

In the .reg snippet below, the first command will generate a write command in the header file that writes 0x2C to Register 0.

```
# Select Page 44
0 = 0x2C
# Enable miniDSP_D Adaptive Mode
1 = 0x04
# Select Page 0
0 = 0x00
```

Figure 7. Example .reg file

Figure 8 contains the generated header file snippet.

```
// Select Page 44
{ 0x00, 0x2C },
// Enable miniDSP_D Adaptive Mode
{ 0x01, 0x04 },
// Select Page 0
{ 0x00, 0x00 },
```

Figure 8. Output .h file

A 'xx' in a .reg file instructs the header file generator to dump the contents of a particular register or range of registers. In Figure 9, registers 0x08 to 0x7F of Page 44 are dumped from the TAS5766M EVM into a header file.

```
# Coefficient Memory A
# page 44 (0x2C)
0x00, 0x2C, 0x00 = xx
0x00, 0x2C, 0x08-0x7F = xx

# page 45 (0x2D)
0x00, 0x2D, 0x00 = xx
0x00, 0x2D, 0x08-0x7F = xx
```

Figure 9. Example .reg File Using the Dump Feature

Figure 10 shows the resulting header file.

```

/-----
// Begin C-RAM_D, Buffer A Dump
/-----
// Coefficient Memory A
// page 44 (0x2C)
  { 0x00, 0x2C },
  { 0x08, 0x40 },
  { 0x09, 0x00 },
  { 0x0A, 0x00 },
  { 0x0B, 0x00 },
.
.
.

```

Figure 10. Output .h File Using the Dump Feature

To minimize code size, a special command `CFG_META_BURST` is generated if the Burst field in the Register Dump configuration window is greater than 1. This will repurpose the register offset field in the header file for data bytes of consecutive register writes. The Burst value **must** be set to either **1** or **120** for PurePath™ Console 1.16 revision 32169 or earlier.



Figure 11. Burst Size Configuration

The snippet in Figure 12 shows the output when Burst is 120.

```

#define CFG_META_BURST (253)
.
.
.
/-----
// Begin C-RAM_D, Buffer A Dump
/-----
// Coefficient Memory A
// page 44 (0x2C)
  { 0x00, 0x2C },
  { CFG_META_BURST, 120},    // 120 consecutive registers
  { 0x08, 0x40 },          // {Reg, data0}
  { 0x00, 0x00 },          // {data1, data2}
  { 0x00, 0xFF },          // {data3, data4}
  { 0xFF, 0xFF },          // {data5, data6}
.
.
.

```

Figure 12. Output .h File Using the Dump Feature (Burst = 128)

References

- [1] **Windows Hardware Certification Requirements: Client and Server Systems.**
<http://download.microsoft.com/download/A/D/F/ADF5BEDE-C0FB-4CC0-A3E1-B38093F50BA1/windows8-hardware-cert-requirements-system.pdf>
- [2] <http://www.ti.com/lit/pdf/slaa625>

Appendix A. Reset Block

Reset

```
# Command Dump Configuration
#-----
# Project: PurePath™ Smart Amp for Laptops
# SA Plug-in Version: TAS5766MDCAEVM v4.0010
# Block: Reset
# Version: 20141008
#-----
#
#-----
# Reset
#-----

# Select Page 0
0 = 0x00

# Set the device into Powerdown
2 = 0x11

# Reset Device
1 = 0x11
```

Figure 13. Reset Block Code

Appendix B. Sleep Block

Sleep

```

# Command Dump Configuration
#-----
# Project: PurePath™ Smart Amp for Laptops
# SA Plug-in Version: TAS5766MDCAEVM v4.0010
# Block: Sleep
# Version: 20141008
#-----
#
#-----
# Sleep
#-----

# Select Page 0
0 = 0x00

# Mute Left and Right Channels
3 = 0x11

# Set the device into Standby
2 = 0x10
    
```

Figure 14. Sleep Block Code

Appendix C. Basic Mode Block

Basic Mode

```
# Command Dump Configuration
#-----
# Project: PurePath™ Smart Amp for Laptops
# SA Plug-in Version: TAS5766MDCAEVM v4.0010
# Block: Basic Mode
# Version: 20141008
#-----
#
#-----
# Select DSP Mode 1
#-----

# Select Page 0
0 = 0x00

# DSP Program = Mode 1
43 = 0x01

# Digital Volume Control
# *Configure based on speaker power handling*
# See Smart Amp Design Guide
61 = 0x30
62 = 0x30

# Select Page 44
0 = 0x2C

# Disable miniDSP_D Adaptive Mode
1 = 0x00
```

Figure 15. Basic Mode Block Code

Appendix D. Config Block

Config

```

# Command Dump Configuration
#-----
# Project: PurePath™ Smart Amp for Laptops
# SA Plug-in Version: TAS5766MDCAEVM v4.0010
# Block: Config
# Version: 20141008
#-----
#
#-----
# Post-configuration
#-----

# Select Page 1
0 = 0x01

# Charge Pump Delay = 165ns
3 = 0x04

# Select Page 0
0 = 0x00

# PLL reference clock = BCK (no SCK present)
13 = 0x10

# Ignore SCK halt detection (no SCK present)
37 = 0x08

# Fast BG ramp-up
8 = 0x10
    
```

Figure 16. Config Block Code

Appendix E. Wake Block

Wake

```
# Command Dump Configuration
#-----
# Project: PurePath™ Smart Amp for Laptops
# SA Plug-in Version: TAS5766MDCAEVM v4.0010
# Block: Wake
# Version: 20141008
#-----
#
#-----
# Wake
#-----

# Select Page 0
0 = 0x00

# Wake from Standby
2 = 0x00

# Unmute L/R
3 = 0x00
```

Figure 17. Wake Block Code

Appendix F. Smart Amp Mode Block

Smart Amp Mode

```

# Command Dump Configuration
#-----
# Project: PurePath™ Smart Amp for Laptops
# SA Plug-in Version: TAS5766MDCAEVM v4.0010
# Block: Smart Amp Mode
# Version: 20141008
#-----
#
#-----
# Smart Amp Mode
#-----

# Select Page 0
0 = 0x00

# DSP Program = miniDSP
43 = 0x1F

# Digital Volume Control = 0dB
61 = 0x30
62 = 0x30

# Select Page 44
0 = 0x2C

# Disable miniDSP_D Adaptive Mode
1 = 0x00

# Enable miniDSP_D Adaptive Mode
1 = 0x04
    
```

Figure 18. Smart Amp Mode Block Code

Appendix G. I-RAM Block

I-RAM

```

# Instruction Memory
# page 152 (0x98)
0x00, 0x98, 0x00 = xx
0x00, 0x98, 0x08-0x7F = xx
# page 153 (0x99)
0x00, 0x99, 0x00 = xx
0x00, 0x99, 0x08-0x7F = xx
# page 154 (0x9A)
0x00, 0x9A, 0x00 = xx
0x00, 0x9A, 0x08-0x7F = xx
# page 155 (0x9B)
0x00, 0x9B, 0x00 = xx
0x00, 0x9B, 0x08-0x7F = xx
# page 156 (0x9C)
0x00, 0x9C, 0x00 = xx
0x00, 0x9C, 0x08-0x7F = xx
# page 157 (0x9D)
0x00, 0x9D, 0x00 = xx
0x00, 0x9D, 0x08-0x7F = xx
# page 158 (0x9E)
0x00, 0x9E, 0x00 = xx
0x00, 0x9E, 0x08-0x7F = xx
# page 159 (0x9F)
0x00, 0x9F, 0x00 = xx
0x00, 0x9F, 0x08-0x7F = xx
# page 160 (0xA0)
0x00, 0xA0, 0x00 = xx
0x00, 0xA0, 0x08-0x7F = xx
# page 161 (0xA1)
0x00, 0xA1, 0x00 = xx
0x00, 0xA1, 0x08-0x7F = xx
# page 162 (0xA2)
0x00, 0xA2, 0x00 = xx
0x00, 0xA2, 0x08-0x7F = xx
# page 163 (0xA3)
0x00, 0xA3, 0x00 = xx
0x00, 0xA3, 0x08-0x7F = xx
# page 164 (0xA4)
0x00, 0xA4, 0x00 = xx
0x00, 0xA4, 0x08-0x7F = xx
# page 165 (0xA5)
0x00, 0xA5, 0x00 = xx
0x00, 0xA5, 0x08-0x7F = xx
# page 166 (0xA6)
0x00, 0xA6, 0x00 = xx
0x00, 0xA6, 0x08-0x7F = xx
# page 167 (0xA7)
0x00, 0xA7, 0x00 = xx
0x00, 0xA7, 0x08-0x7F = xx
# page 168 (0xA8)
0x00, 0xA8, 0x00 = xx
0x00, 0xA8, 0x08-0x7F = xx
# page 169 (0xA9)
0x00, 0xA9, 0x00 = xx
0x00, 0xA9, 0x08-0x7F = xx

```

Figure 19. I-RAM Block Code

Appendix H. C-RAM Buffer A Block

C-RAM Buffer A

```

# Command Dump Configuration
#-----
# Project: PurePath™ Smart Amp for Laptops
# SA Plug-in Version: TAS5766MDCAEVM v4.0010
# Block: C-RAM Buffer A
# Version: 20141008
#-----
#
#-----
# Begin C-RAM_D, Buffer A Dump
#-----

# Coefficient Memory A
# page 44 (0x2C)
0x00, 0x2C, 0x00 = xx
0x00, 0x2C, 0x08-0x7F = xx

# page 45 (0x2D)
0x00, 0x2D, 0x00 = xx
0x00, 0x2D, 0x08-0x7F = xx

# page 46 (0x2E)
0x00, 0x2E, 0x00 = xx
0x00, 0x2E, 0x08-0x7F = xx

# page 47 (0x2F)
0x00, 0x2F, 0x00 = xx
0x00, 0x2F, 0x08-0x7F = xx

# page 48 (0x30)
0x00, 0x30, 0x00 = xx
0x00, 0x30, 0x08-0x7F = xx

# page 49 (0x31)
0x00, 0x31, 0x00 = xx
0x00, 0x31, 0x08-0x7F = xx

# page 50 (0x32)
0x00, 0x32, 0x00 = xx
0x00, 0x32, 0x08-0x7F = xx

# page 51 (0x33)
0x00, 0x33, 0x00 = xx
0x00, 0x33, 0x08-0x7F = xx

# page 52 (0x34)
0x00, 0x34, 0x00 = xx
0x00, 0x34, 0x08-0x7F = xx
    
```

Figure 20. C-RAM Buffer A Block Code

Appendix I. C-RAM Buffer B Block

C-RAM Buffer B

```

# Command Dump Configuration
#-----
# Project: PurePath™ Smart Amp for Laptops
# SA Plug-in Version: TAS5766MDCAEVM v4.0010
# Block: C-RAM Buffer B
# Version: 20141008
#-----
#
#-----
# Begin C-RAM_D, Buffer B Dump
#-----

# Coefficient Memory B
# page 62 (0x3E)
0x00, 0x3E, 0x00 = xx
0x00, 0x3E, 0x08-0x7F = xx

# page 63 (0x3F)
0x00, 0x3F, 0x00 = xx
0x00, 0x3F, 0x08-0x7F = xx

# page 64 (0x40)
0x00, 0x40, 0x00 = xx
0x00, 0x40, 0x08-0x7F = xx

# page 65 (0x41)
0x00, 0x41, 0x00 = xx
0x00, 0x41, 0x08-0x7F = xx

# page 66 (0x42)
0x00, 0x42, 0x00 = xx
0x00, 0x42, 0x08-0x7F = xx

# page 67 (0x43)
0x00, 0x43, 0x00 = xx
0x00, 0x43, 0x08-0x7F = xx

# page 68 (0x44)
0x00, 0x44, 0x00 = xx
0x00, 0x44, 0x08-0x7F = xx

# page 69 (0x45)
0x00, 0x45, 0x00 = xx
0x00, 0x45, 0x08-0x7F = xx

# page 70 (0x46)
0x00, 0x46, 0x00 = xx
0x00, 0x46, 0x08-0x7F = xx

```

Figure 21. C-RAM Buffer B Block Code

Revision History

This revision history highlights the changes made to this application report.

Revision History

Version	Date	Author(s)	Additions/Modifications/Deletions
20141008	October 2014	J. Arbona	- Initial Release.
20141009	October 2014	J. Arbona	- Fixed typo, added Driver section.
20141010	October 2014	J. Arbona	- Figure 11 shows burst size of 120. - I-RAM block last dump set 0x08-0x7F.
Rev. A	March 2015	J. Arbona	- Table 1 RQST is P0_R2_D4.

Trademarks

MS-DOS is a registered trademark of Microsoft Corporation.

All trademarks are the property of their respective owners.

IMPORTANT NOTICE AND DISCLAIMER

TI PROVIDES TECHNICAL AND RELIABILITY DATA (INCLUDING DATASHEETS), DESIGN RESOURCES (INCLUDING REFERENCE DESIGNS), APPLICATION OR OTHER DESIGN ADVICE, WEB TOOLS, SAFETY INFORMATION, AND OTHER RESOURCES "AS IS" AND WITH ALL FAULTS, AND DISCLAIMS ALL WARRANTIES, EXPRESS AND IMPLIED, INCLUDING WITHOUT LIMITATION ANY IMPLIED WARRANTIES OF MERCHANTABILITY, FITNESS FOR A PARTICULAR PURPOSE OR NON-INFRINGEMENT OF THIRD PARTY INTELLECTUAL PROPERTY RIGHTS.

These resources are intended for skilled developers designing with TI products. You are solely responsible for (1) selecting the appropriate TI products for your application, (2) designing, validating and testing your application, and (3) ensuring your application meets applicable standards, and any other safety, security, or other requirements. These resources are subject to change without notice. TI grants you permission to use these resources only for development of an application that uses the TI products described in the resource. Other reproduction and display of these resources is prohibited. No license is granted to any other TI intellectual property right or to any third party intellectual property right. TI disclaims responsibility for, and you will fully indemnify TI and its representatives against, any claims, damages, costs, losses, and liabilities arising out of your use of these resources.

TI's products are provided subject to TI's Terms of Sale (www.ti.com/legal/termsofsale.html) or other applicable terms available either on ti.com or provided in conjunction with such TI products. TI's provision of these resources does not expand or otherwise alter TI's applicable warranties or warranty disclaimers for TI products.

Mailing Address: Texas Instruments, Post Office Box 655303, Dallas, Texas 75265
Copyright © 2019, Texas Instruments Incorporated