

# **Cascading Multiple-Linking Addressable-Scan-Port Devices**

*Rakesh N. Joshi and Kenneth L. Williams*

*MPD Digital Products*

## **ABSTRACT**

This application report is intended to illustrate the capability of cascading multiple Texas Instruments (TI) linking addressable scan port (LASP)<sup>†</sup> devices. It explains configuring the secondary test access ports (TAPs) of cascaded LASPs with the help of a single linking shadow protocol and protocol-bypass inputs. Several examples of linking shadow protocol, along with timing requirements and scan data path, are provided. Additionally, it also discusses linking shadow-protocol errors and the LASP response to these protocol errors.

## **Contents**

<b>1</b>	<b>Introduction</b> .....	<b>3</b>
<b>2</b>	<b>Linking Shadow Protocol and Cascade Connections</b> .....	<b>4</b>
<b>3</b>	<b>Primary-to-Secondary TAPs Connections and Scan Data Path</b> .....	<b>6</b>
<b>4</b>	<b>Linking Shadow Protocol Errors in Command Field</b> .....	<b>16</b>
<b>5</b>	<b>Summary</b> .....	<b>16</b>
<b>6</b>	<b>References</b> .....	<b>16</b>

## **List of Figures**

1	An Example of Select-and-Acknowledge Protocol for Addressing and Connecting Primary-to-Secondary Taps of Three Cascaded LASPs .....	4
2	Cascade Connections for Three LASPs .....	5
3	Primary-to-Secondary TAPs Connections and Scan Data Path of Three Cascaded LASPs Using Linking Shadow Protocol or Protocol-Bypass Inputs .....	6
4	Scan Data Path When Position and Configuration for the First LASP Are Not Received or, if Received, the Configuration Bits are Decoded as 111 .....	7
5	Scan Data Path When Position and Configuration for the Second LASP Are Not Received or, if Received, the Configuration Bits are Decoded as 111 .....	8
6	Scan Data Path When Position and Configuration for the Third LASP Are Not Received or, if Received, the Configuration Bits are Decoded as 111 .....	9
7	Scan Data Path When Position and Configuration for the Second and Third LASP Are Not Received or, if Received, the Configuration Bits are Decoded as 111 .....	10
8	Scan Data Path When Position and Configuration for the First and Third LASP Are Not Received or, if Received, the Configuration Bits are Decoded as 111 .....	11

<sup>†</sup> For detailed operation of LASP, please refer to the SN74LVT8986 (SCBS759) data sheet.

- 9 Scan Data Path When Position and Configuration for the First and Second LASP  
Are Not Received or, if Received, the Configuration Bits are Decoded as 111 ..... 12
- 10 Linking Shadow Protocol and Data-Flow Timing for Three Cascaded LASPs ..... 15

### List of Tables

- 1 Secondary TAP Connections and Scan Data Path When Using Linking Shadow Protocol ..... 13
- 2 Secondary TAP Connections and Scan Data Path When Using Protocol-Bypass Inputs ..... 14

## 1 Introduction

The IEEE 1149.1 standard (JTAG) provides boundary-scan architecture and a serial test bus for integrated circuits (ICs). Multiple ICs can be connected together on the test bus to allow accessing all ICs together during board-level testing. Boards equipped with these JTAG ICs can be connected at the backplane level using two fundamental access schemes. The first scheme is to serially daisy-chain boards together to allow all boards to be accessed simultaneously. The second scheme is to provide each board with an addressable interface, such that boards can be accessed individually. The first scheme suffers from the fact that if one board is removed from the backplane, access to other boards is disabled. The second scheme overcomes this problem by using an addressable scheme to access remaining boards in the backplane.

Some boards are designed preferably by partitioning subsets of ICs onto individual scan paths. This partitioning allows accessing subset groups of ICs separately, which offers several advantages. One advantage is that ICs that are capable of being accessed at higher JTAG test-bus clock rates can be included in one group, while ICs that operate at slower test-bus clock rates can be placed in another group. Thus, test-bus speed binning is possible. Similarly, complex programmable logic devices (CPLD) and flash memories also could be placed in subset groups for in-circuit programming. As densities of CPLDs and flash memories increase and package sizes decrease, it becomes difficult to program them out-of-circuit. Programming in-circuit is desirable in both development and production environments. For development, engineers can change the configuration information stored in the CPLD or the code stored in flash memory devices during the development process. For production, in-circuit programming allows CPLDs and flash devices to remain on the shelf in an unprogrammed or blank state. These blank devices then can be installed at assembly and programmed in-circuit, thus reducing programming and tracking costs.

Another advantage in partitioning ICs onto separate scan paths is that it allows accessing a first-scan-path group to initiate a self-test operation, then, while that group operates the self-test, it allows accessing another scan-path group to start testing of another IC group. Still another advantage is that some ICs may include emulation and debug features that are accessible by the JTAG test bus. Being able to place these types of ICs in a group separate from other ICs leads to improvements in execution efficiency of JTAG-based debug and emulation operations.

The LASP uses a linking shadow protocol that is transmitted transparently over the JTAG test bus. At the backplane level, the linking shadow protocol is used to send an address and command over the backplane test bus to enable one of a plurality of board-resident LASPs. Once enabled, the LASP of the addressed board allows the backplane JTAG test bus to communicate to the ICs of the addressed board. The three secondary TAPs of LASP allow accessing ICs in the previously mentioned grouping style if the board has a maximum of three separate scan paths. Thus, a board with more than three separate scan paths would require multiple LASPs. The capability of cascading a maximum of eight LASPs allows accessing 24 separate scan paths, either individually, in selected combinations, or all linked together into one scan path.

## 2 Linking Shadow Protocol and Cascade Connections

Figure 1 is an example of a complete select-and-acknowledge protocol for addressing and connecting primary-to-secondary TAPs of three cascaded LASPs. Each protocol consists of an address and command fields. Command fields consist of position field and configuration field for each LASP in the cascade chain. Select-bit pairs frame address and command fields at the beginning and end, and idle-bit pairs frame the message at the beginning and end. All the LASPs that are cascaded have the same address applied to the address input pins  $A_9-A_0$ .

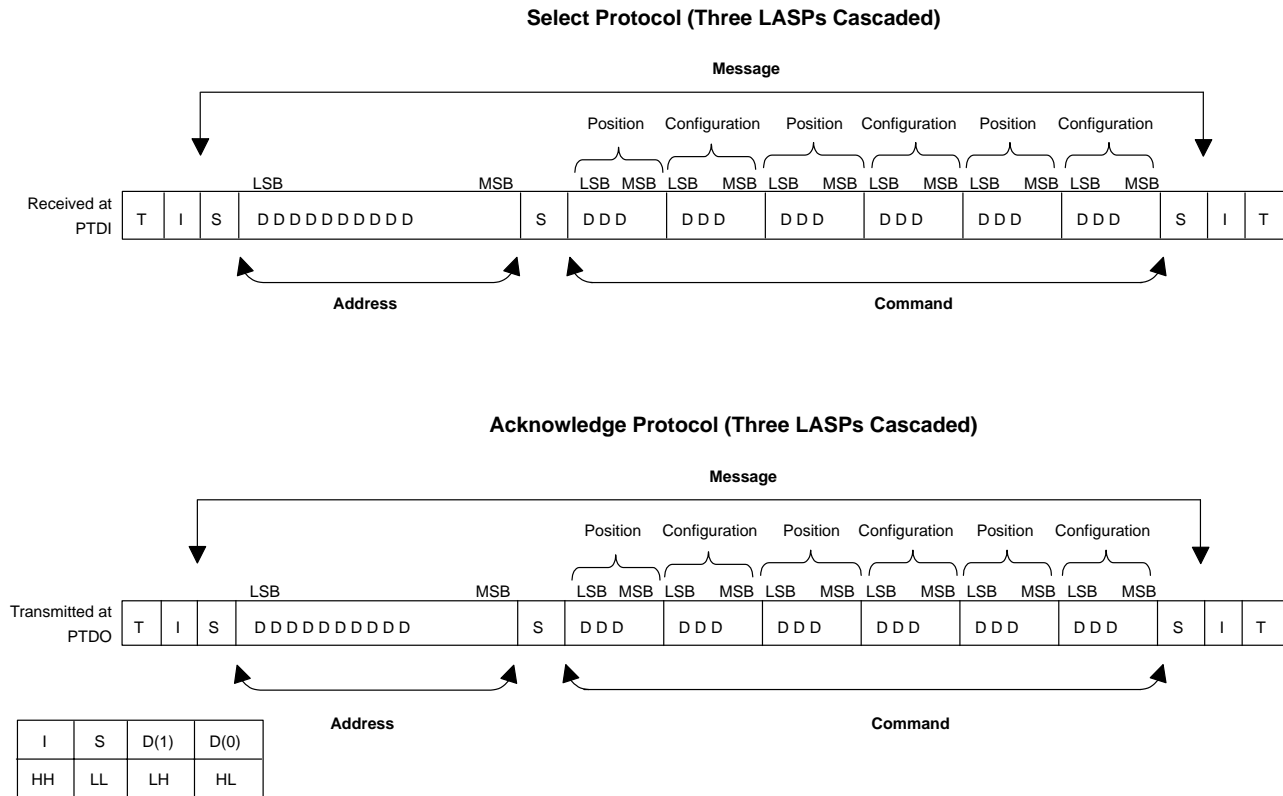

**Figure 1. An Example of Select-and-Acknowledge Protocol for Addressing and Connecting Primary-to-Secondary Taps of Three Cascaded LASPs**

Three LASPs are shown cascaded in Figure 2. Each LASP is wired at its primary TAP to common (multidrop) TAP signals (sourced from a central IEEE Std 1149.1 bus master) and fans out its secondary to the specific group of IEEE Std 1149.1-compliant devices with which it is associated. CTDI input of the LASP is wired to the CTDO output of the previous LASP in a cascade chain. CTDI input of the first LASP in the cascaded chain is not wired and is pulled to high with an internal pullup. CTDO output of the last LASP in the cascaded chain is not wired. The position inputs  $P_2-P_0$  of the first LASP in the cascaded chain are set low. The second LASP in the cascade chain has its position inputs ( $P_2$  and  $P_1$ ) set low, while  $P_0$  set high. The third LASP, which is also the last LASP in the cascaded chain, has its position inputs ( $P_2$  and  $P_0$ ) set low, while  $P_1$  is set high. All the LASPs receive the select protocol at its PTDI input; however, only the last LASP in the cascaded chain transmits the acknowledge protocol at its PTDO output. During acknowledge protocol and after primary-to-secondary TAPs connections are established, the remaining LASPs in the cascaded chain have their PTDO outputs in the high-impedance state (3-state) to avoid bus contention.

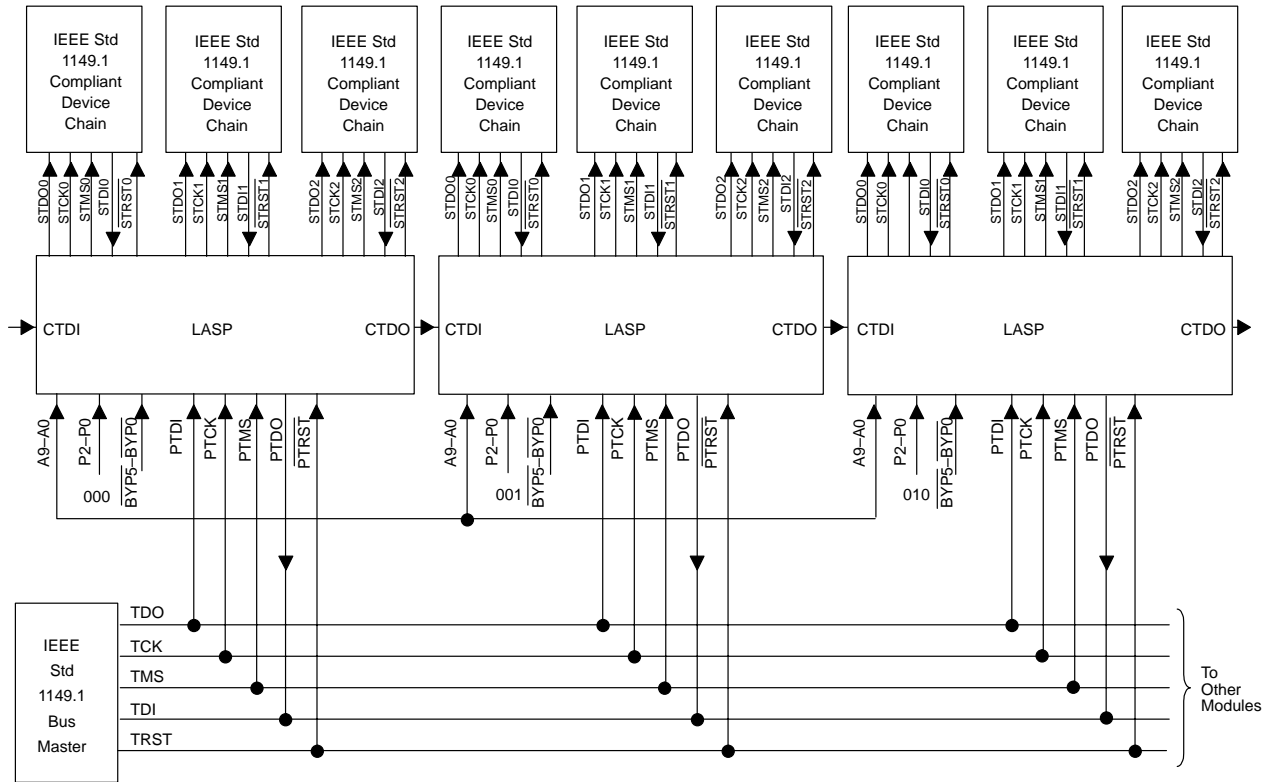
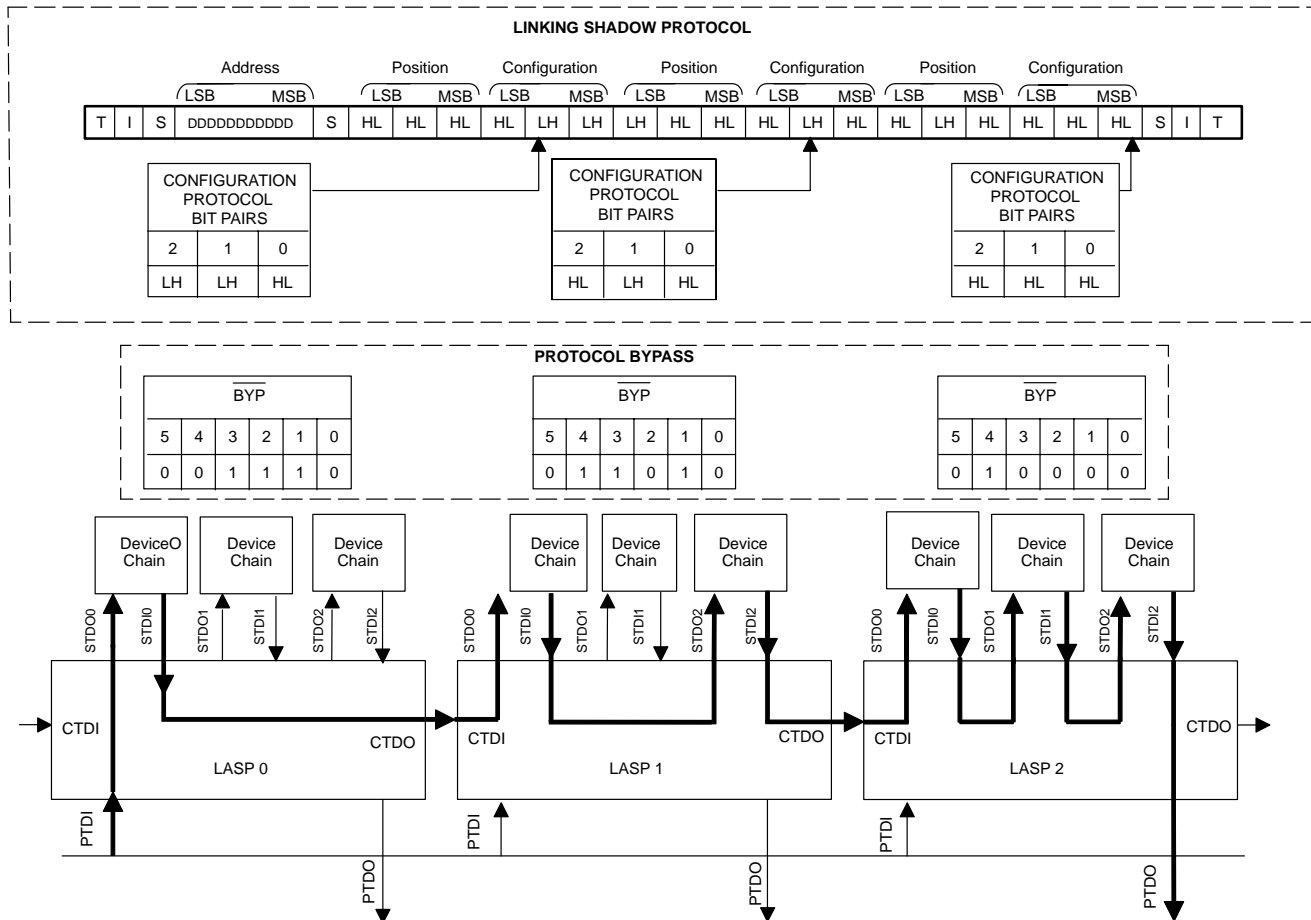

Figure 2. Cascade Connections for Three LASPs

### 3 Primary-to-Secondary TAPs Connections and Scan Data Path

Figure 3 illustrates primary-to-secondary TAPs connections and scan data path of three cascaded LASPs using linking shadow protocol or protocol-bypass inputs. The first LASP in the cascaded chain has only STAP<sub>0</sub> active, the second LASP has STAP<sub>0</sub> and STAP<sub>2</sub> active, while the third or last LASP has all of the three secondary TAPs (STAP<sub>0</sub>, STAP<sub>1</sub>, STAP<sub>2</sub>) active. Figure 3 also includes the linking shadow protocol and states of protocol bypass inputs required for the previously mentioned primary-to-secondary TAPs connections. If using protocol bypass inputs, they should be used for all cascaded LASPs. No mixing of linking shadow protocol and protocol-bypass inputs should be attempted.



**Figure 3. Primary-to-Secondary TAPs Connections and Scan Data Path of Three Cascaded LASPs Using Linking Shadow Protocol or Protocol-Bypass Inputs**

Primary-to-secondary TAPs connections and scan data path of three cascaded LASPs using linking shadow protocol or protocol-bypass inputs is shown in Figures 4, 5, and 6. Here, during the select protocol, position and configuration for one LASP in the cascaded chain are not received or, if received, the configuration bits are decoded as 111. This allows bypassing a complete set of device chains from the scan path.

In Figure 4, the first LASP in the cascaded chain has all the three secondary TAPs inactive because it does not receive its matching position and corresponding configuration or, if received, the configuration bits are decoded as 111. The second LASP now behaves as the first LASP in the cascaded chain and has STAP<sub>0</sub> and STAP<sub>2</sub> active. The third LASP has all three secondary TAPs (STAP<sub>0</sub>, STAP<sub>1</sub>, STAP<sub>2</sub>) active. When protocol-bypass inputs are used,  $\overline{\text{BYP}}_4$  and  $\overline{\text{BYP}}_3$  of the first LASP are set high, the second LASP has  $\overline{\text{BYP}}_4$  input set low and  $\overline{\text{BYP}}_3$  input set high, so that it behaves as the first LASP in the cascaded chain.

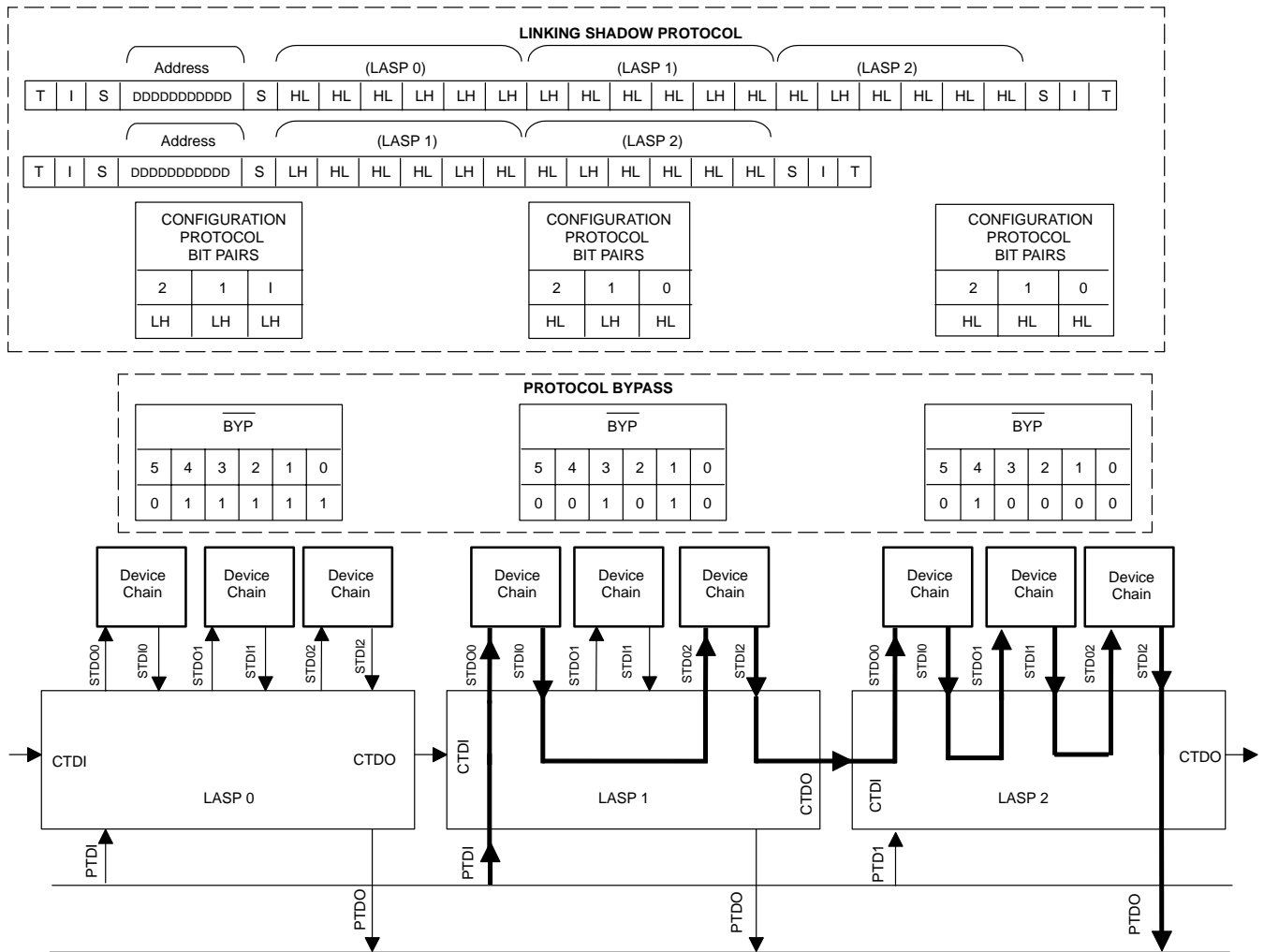

**Figure 4. Scan Data Path When Position and Configuration for the First LASP Are Not Received or, if Received, the Configuration Bits are Decoded as 111**

In Figure 5, the second LASP in the cascaded chain has all three secondary TAPs inactive because it does not receive its matching position and corresponding configuration or, if received, the configuration bits are decoded as 111. The first LASP in the cascaded chain has only STAP<sub>0</sub> active. The second LASP has all three secondary TAPs inactive, but CTDI input is connected to CTDO output to pass the scan data between the first and third LASP. The third LASP has all three secondary TAPs (STAP<sub>0</sub>, STAP<sub>1</sub>, STAP<sub>2</sub>) active.

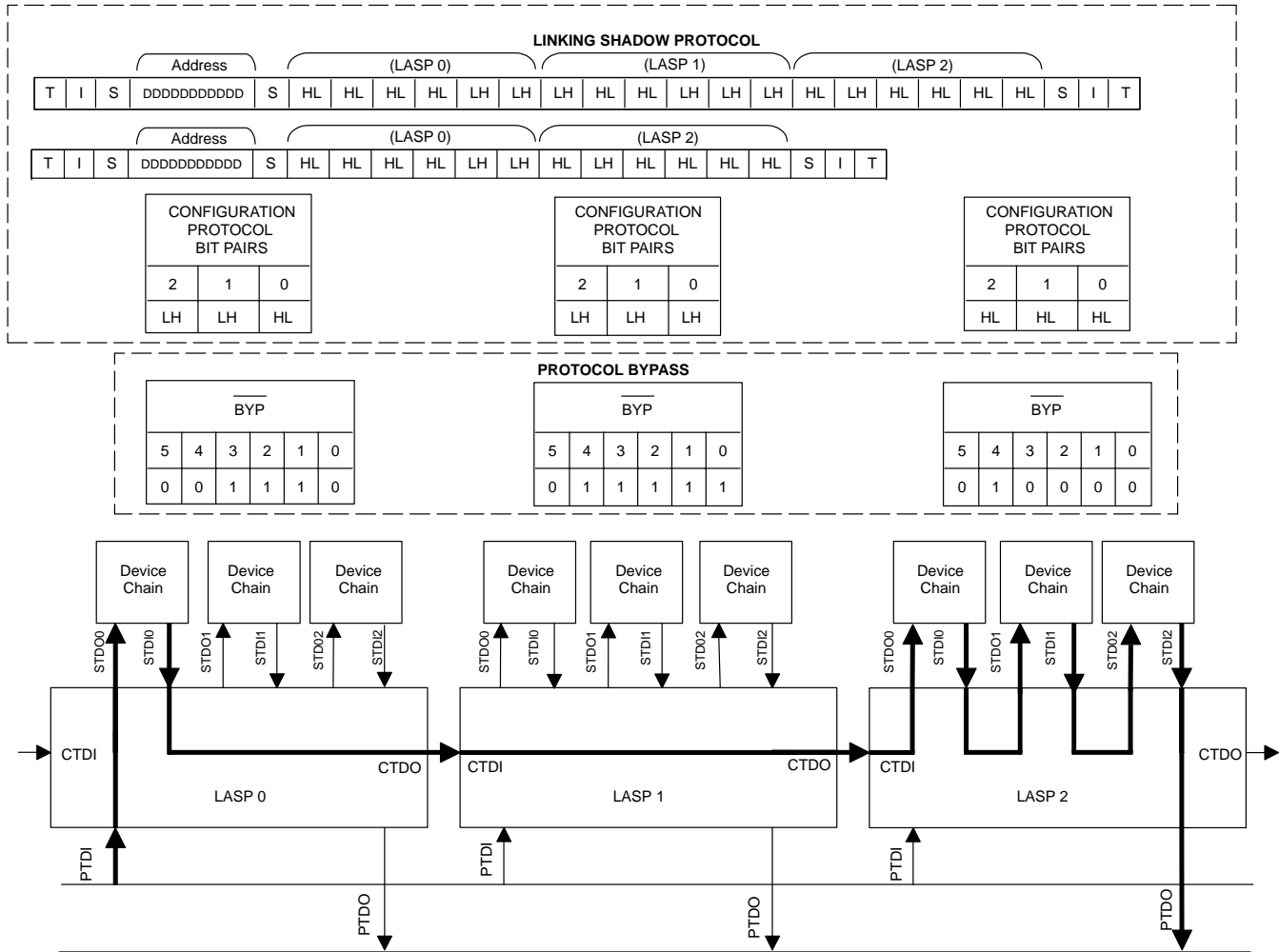

**Figure 5. Scan Data Path When Position and Configuration for the Second LASP Are Not Received or, if Received, the Configuration Bits Are Decoded as 111**



In Figure 6, the third LASP in the cascaded chain has all three secondary TAPs inactive because it does not receive its matching position and corresponding configuration or, if received, the configuration bits are decoded as 111. The first LASP in the cascaded chain has only STAP<sub>0</sub> active. The second LASP has STAP<sub>0</sub> and STAP<sub>2</sub> active and now behaves as the last LASP in the cascaded chain. When protocol-bypass inputs are used, the second LASP has  $\overline{\text{BYP}}_4$  input set high and  $\overline{\text{BYP}}_3$  input set low, so that it behaves as the last LASP in the cascaded chain. The  $\overline{\text{BYP}}_4$  and  $\overline{\text{BYP}}_3$  inputs of the third LASP are set high.

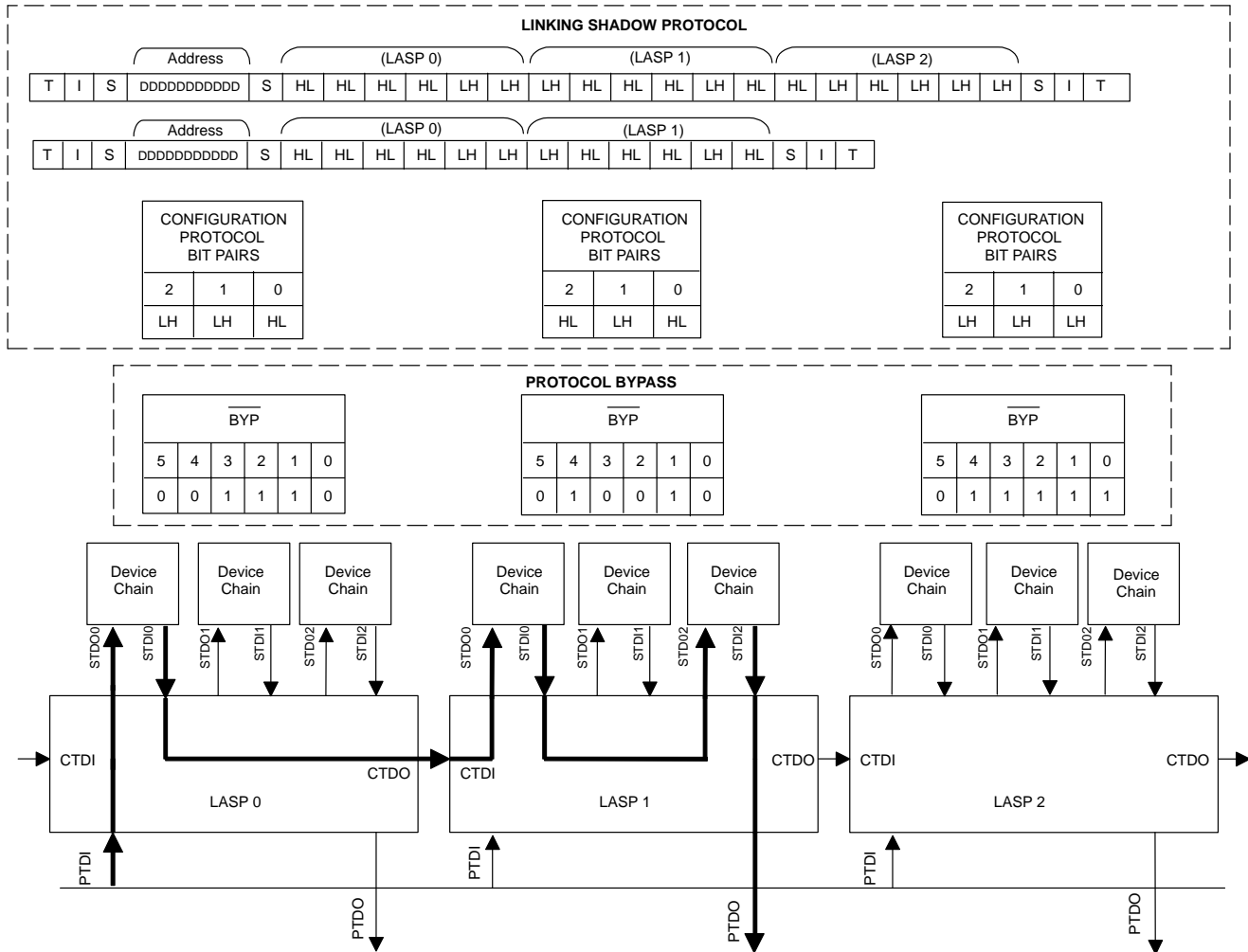

**Figure 6. Scan Data Path When Position and Configuration for the Third LASP Are Not Received or, if Received, the Configuration Bits Are Decoded as 111**

Primary-to-secondary TAPs connections and the scan data path of three cascaded LASPs using linking shadow protocol or protocol-bypass inputs is shown in Figures 7, 8, and 9. Here, during the select protocol, position and configuration for only one LASP in the cascaded chain is received or, if received for more than one, the configuration bits are decoded as 111, except for one. This allows operating the device as a single device and bypassing the rest of the devices in cascaded chains from the scan path.

In Figure 7, during the select protocol, position and configuration for the second and third LASP are not received or, if received, their configuration bits are decoded as 111. The first LASP in the cascaded chain has only STAP<sub>0</sub> active and now behaves as a single LASP (not cascaded). The second and third LASP have all three secondary TAPs inactive. When protocol-bypass inputs are used, the first LASP has its  $\overline{\text{BYP}}_4$  and  $\overline{\text{BYP}}_3$  inputs set low, so that it behaves as a single LASP (not cascaded). The  $\overline{\text{BYP}}_4$  and  $\overline{\text{BYP}}_3$  inputs of the second and third LASPs are set high.

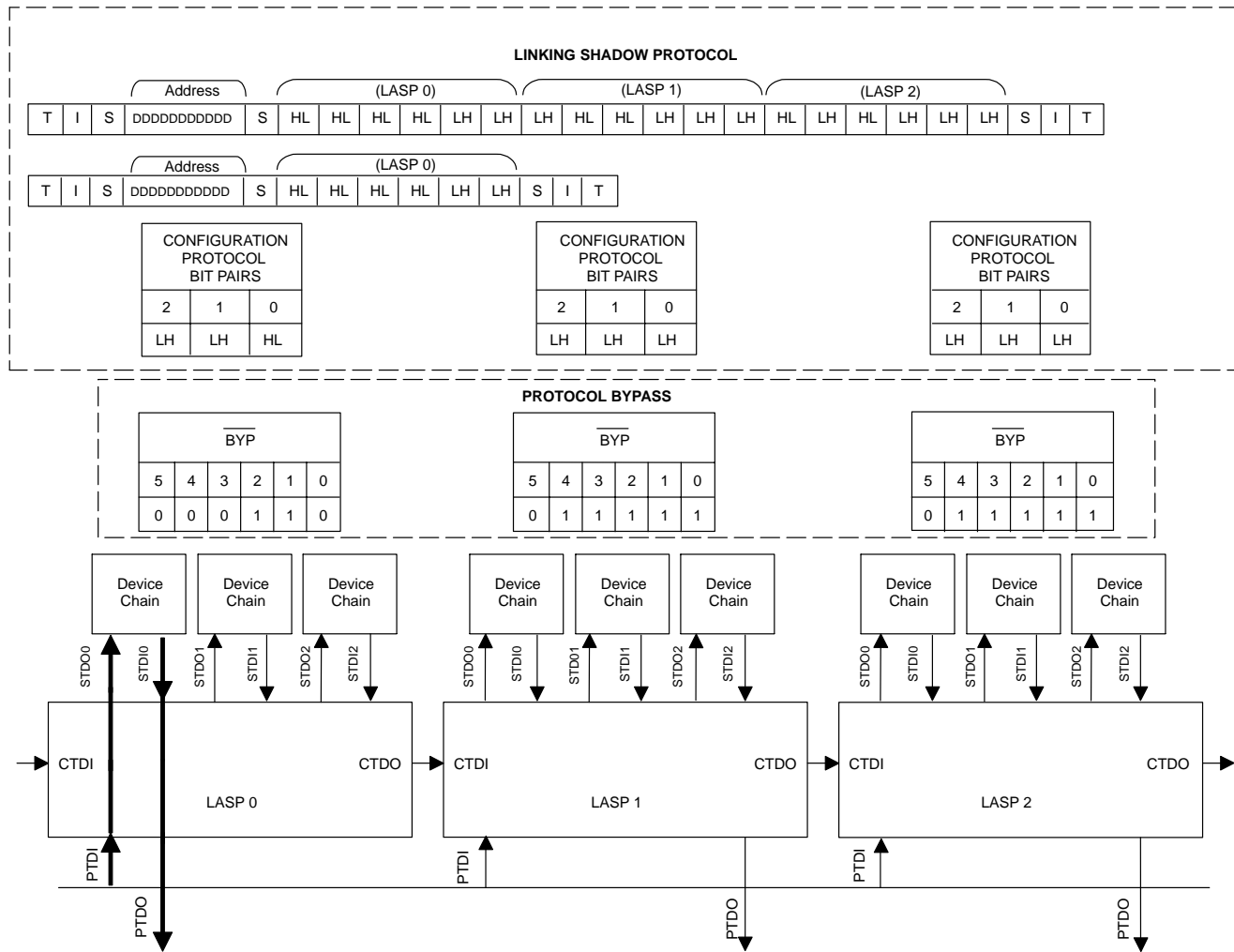

**Figure 7. Scan Data Path When Position and Configuration for the Second and Third LASPs Are Not Received or, if Received, the Configuration Bits Are Decoded as 111**

In Figure 8, during the select protocol, position and configuration for the first and third LASPs are not received or, if received, their configuration bits are decoded as 111. The second LASP in the cascaded chain has STAP<sub>0</sub> and STAP<sub>2</sub> active and now behaves as a single device (not cascaded). The first and third LASPs have all the three secondary TAPs inactive. When protocol-bypass inputs are used, the second LASP has its  $\overline{\text{BYP}}_4$  and  $\overline{\text{BYP}}_3$  inputs set low, so that it behaves as a single LASP (not cascaded). The  $\overline{\text{BYP}}_4$  and  $\overline{\text{BYP}}_3$  inputs of first and third LASPs are set high.

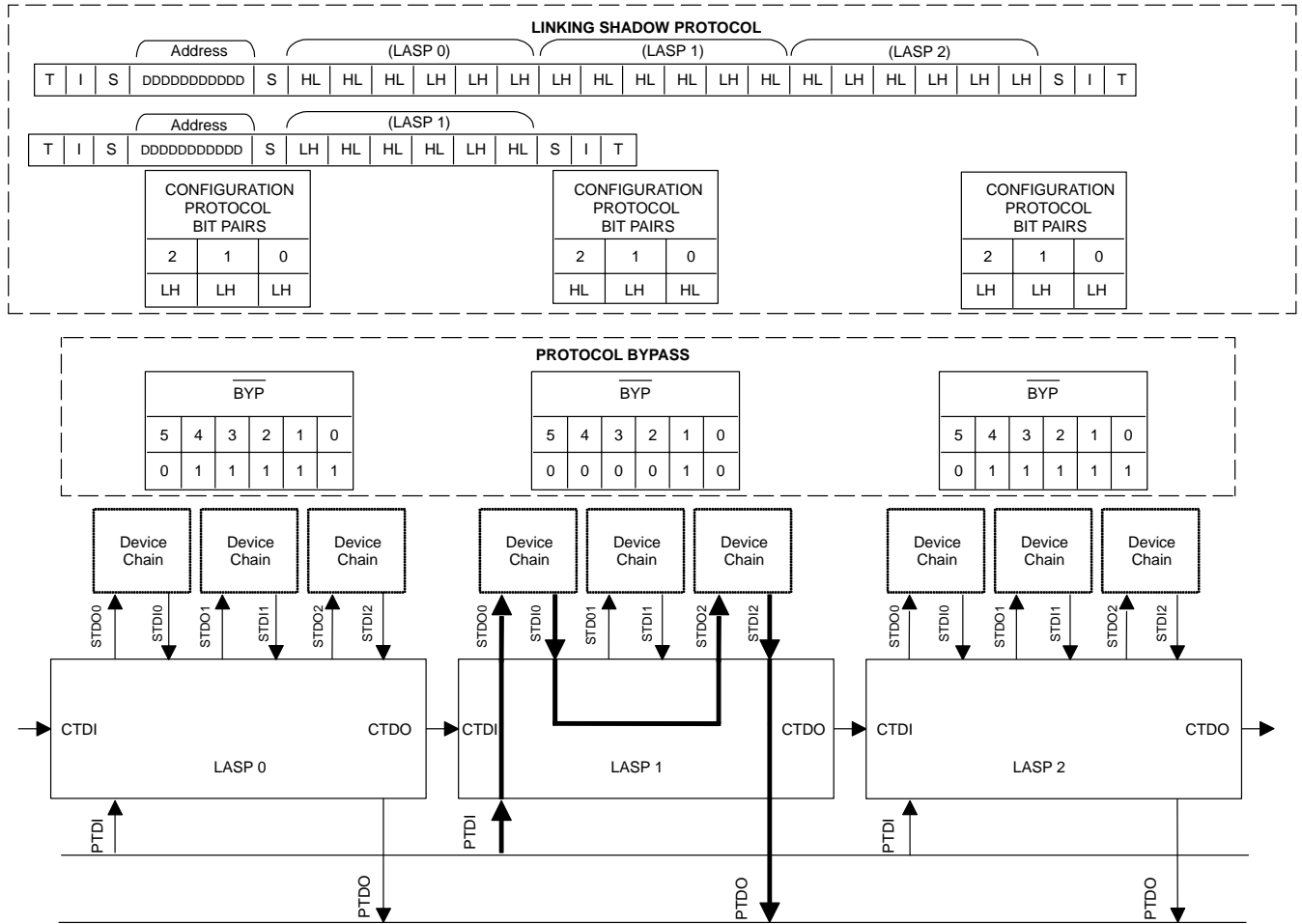

**Figure 8. Scan Data Path When Position and Configuration for the First and Third LASPs Are Not Received or, if Received, the Configuration Bits Are Decoded as 111**

In Figure 9, during the select protocol, position and configuration for the first and second LASPs are not received or, if received, their configuration bits are decoded as 111. The third LASP in the cascaded chain has all three secondary TAPs active and now behaves as a single device (not cascaded). The first and second LASPs have all three secondary TAPs inactive. When protocol-bypass inputs are used, the third LASP has its  $\overline{\text{BYP}}_4$  and  $\overline{\text{BYP}}_3$  inputs set low, so that it behaves as a single LASP (not cascaded). The  $\overline{\text{BYP}}_4$  and  $\overline{\text{BYP}}_3$  inputs of the first and second LASPs are set high.

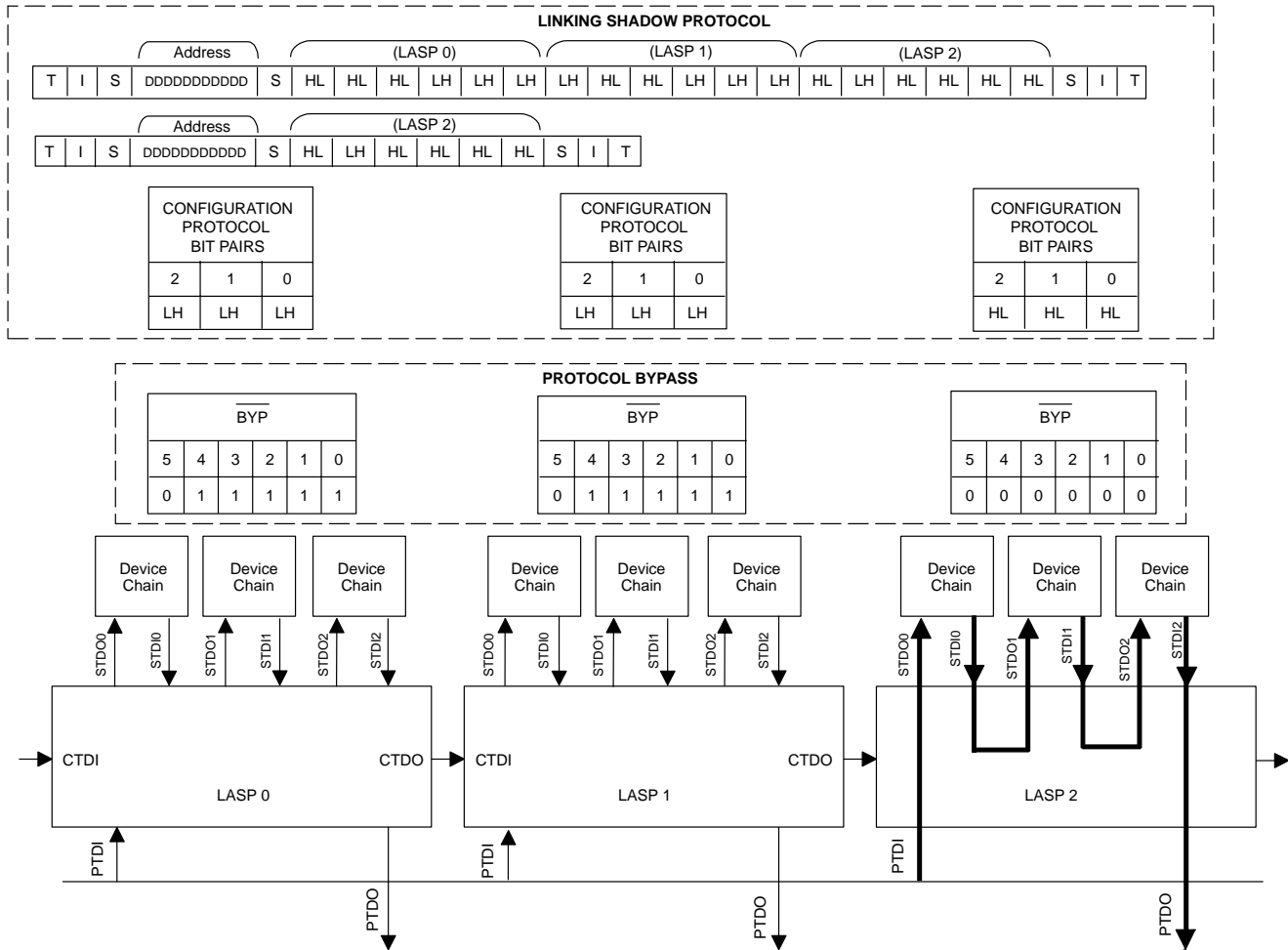

**Figure 9. Scan Data Path When Position and Configuration for the First and Second LASPs Are Not Received or, if Received, the Configuration Bits Are Decoded as 111**

Secondary TAP connections and scan data path, when using linking shadow protocol or protocol-bypass inputs, are shown in Tables 1 and 2. Secondary TAP connections and scan data path are shown when the position of the LASP within the cascade chain is first, last, not first nor last, and when it is used as a single device.

**Table 1. Secondary TAP Connections and Scan Data Path  
When Using Linking Shadow Protocol**

Position	Configuration			STAP Configuration			Scan Data Path
	BIT 2	BIT 1	BIT 0	STAP <sub>2</sub>	STAP <sub>1</sub>	STAP <sub>0</sub>	
Single device	1	1	1	Inactive	Inactive	Inactive	None
	1	1	0	Inactive	Inactive	Active	PTDI – STAP <sub>0</sub> – PTDO
	1	0	1	Inactive	Active	Inactive	PTDI – STAP <sub>1</sub> – PTDO
	1	0	0	Inactive	Active	Active	PTDI – STAP <sub>0</sub> – STAP <sub>1</sub> – PTDO
	0	1	1	Active	Inactive	Inactive	PTDI – STAP <sub>2</sub> – PTDO
	0	1	0	Active	Inactive	Active	PTDI – STAP <sub>0</sub> – STAP <sub>2</sub> – PTDO
	0	0	1	Active	Active	Inactive	PTDI – STAP <sub>1</sub> – STAP <sub>2</sub> – PTDO
	0	0	0	Active	Active	Active	PTDI – STAP <sub>0</sub> – STAP <sub>1</sub> – STAP <sub>2</sub> – PTDO
First device in cascade chain	1	1	1	Inactive	Inactive	Inactive	None
	1	1	0	Inactive	Inactive	Active	PTDI – STAP <sub>0</sub> – CTDO
	1	0	1	Inactive	Active	Inactive	PTDI – STAP <sub>1</sub> – CTDO
	1	0	0	Inactive	Active	Active	PTDI – STAP <sub>0</sub> – STAP <sub>1</sub> – CTDO
	0	1	1	Active	Inactive	Inactive	PTDI – STAP <sub>2</sub> – CTDO
	0	1	0	Active	Inactive	Active	PTDI – STAP <sub>0</sub> – STAP <sub>2</sub> – CTDO
	0	0	1	Active	Active	Inactive	PTDI – STAP <sub>1</sub> – STAP <sub>2</sub> – CTDO
	0	0	0	Active	Active	Active	PTDI – STAP <sub>0</sub> – STAP <sub>1</sub> – STAP <sub>2</sub> – CTDO
Last device in cascade chain	1	1	1	Inactive	Inactive	Inactive	None
	1	1	0	Inactive	Inactive	Active	CTDI – STAP <sub>0</sub> – PTDO
	1	0	1	Inactive	Active	Inactive	CTDI – STAP <sub>1</sub> – PTDO
	1	0	0	Inactive	Active	Active	CTDI – STAP <sub>0</sub> – STAP <sub>1</sub> – PTDO
	0	1	1	Active	Inactive	Inactive	CTDI – STAP <sub>2</sub> – PTDO
	0	1	0	Active	Inactive	Active	CTDI – STAP <sub>0</sub> – STAP <sub>2</sub> – PTDO
	0	0	1	Active	Active	Inactive	CTDI – STAP <sub>1</sub> – STAP <sub>2</sub> – PTDO
	0	0	0	Active	Active	Active	CTDI – STAP <sub>0</sub> – STAP <sub>1</sub> – STAP <sub>2</sub> – PTDO
Not first/last device in cascade chain	1	1	1	Inactive	Inactive	Inactive	CTDI – CTDO
	1	1	0	Inactive	Inactive	Active	CTDI – STAP <sub>0</sub> – CTDO
	1	0	1	Inactive	Active	Inactive	CTDI – STAP <sub>1</sub> – CTDO
	1	0	0	Inactive	Active	Active	CTDI – STAP <sub>0</sub> – STAP <sub>1</sub> – CTDO
	0	1	1	Active	Inactive	Inactive	CTDI – STAP <sub>2</sub> – CTDO
	0	1	0	Active	Inactive	Active	CTDI – STAP <sub>0</sub> – STAP <sub>2</sub> – CTDO
	0	0	1	Active	Active	Inactive	CTDI – STAP <sub>1</sub> – STAP <sub>2</sub> – CTDO
	0	0	0	Active	Active	Active	CTDI – STAP <sub>0</sub> – STAP <sub>1</sub> – STAP <sub>2</sub> – CTDO

**Table 2. Secondary TAP Connections and Scan Data Path  
When Using Protocol-Bypass Inputs**

$\overline{\text{BYP}}$						STAP Configuration			Scan Data Path
5	4	3	2	1	0	STAP <sub>2</sub>	STAP <sub>1</sub>	STAP <sub>0</sub>	
0	0	0	1	1	1	Inactive	Inactive	Inactive	None
0	0	0	1	1	0	Inactive	Inactive	Active	PTDI – STAP <sub>0</sub> – PTDO
0	0	0	1	0	1	Inactive	Active	Inactive	PTDI – STAP <sub>1</sub> – PTDO
0	0	0	1	0	0	Inactive	Active	Active	PTDI – STAP <sub>0</sub> – STAP <sub>1</sub> – PTDO
0	0	0	0	1	1	Active	Inactive	Inactive	PTDI – STAP <sub>2</sub> – PTDO
0	0	0	0	1	0	Active	Inactive	Active	PTDI – STAP <sub>0</sub> – STAP <sub>2</sub> – PTDO
0	0	0	0	0	1	Active	Active	Inactive	PTDI – STAP <sub>1</sub> – STAP <sub>2</sub> – PTDO
0	0	0	0	0	0	Active	Active	Active	PTDI – STAP <sub>0</sub> – STAP <sub>1</sub> – STAP <sub>2</sub> – PTDO
0	0	1	1	1	1	Inactive	Inactive	Inactive	None
0	0	1	1	1	0	Inactive	Inactive	Active	PTDI – STAP <sub>0</sub> – CTDO
0	0	1	1	0	1	Inactive	Active	Inactive	PTDI – STAP <sub>1</sub> – CTDO
0	0	1	1	0	0	Inactive	Active	Active	PTDI – STAP <sub>0</sub> – STAP <sub>1</sub> – CTDO
0	0	1	0	1	1	Active	Inactive	Inactive	PTDI – STAP <sub>2</sub> – CTDO
0	0	1	0	1	0	Active	Inactive	Active	PTDI – STAP <sub>0</sub> – STAP <sub>2</sub> – CTDO
0	0	1	0	0	1	Active	Active	Inactive	PTDI – STAP <sub>1</sub> – STAP <sub>2</sub> – CTDO
0	0	1	0	0	0	Active	Active	Active	PTDI – STAP <sub>0</sub> – STAP <sub>1</sub> – STAP <sub>2</sub> – CTDO
0	1	0	1	1	1	Inactive	Inactive	Inactive	None
0	1	0	1	1	0	Inactive	Inactive	Active	CTDI – STAP <sub>0</sub> – PTDO
0	1	0	1	0	1	Inactive	Active	Inactive	CTDI – STAP <sub>1</sub> – PTDO
0	1	0	1	0	0	Inactive	Active	Active	CTDI – STAP <sub>0</sub> – STAP <sub>1</sub> – PTDO
0	1	0	0	1	1	Active	Inactive	Inactive	CTDI – STAP <sub>2</sub> – PTDO
0	1	0	0	1	0	Active	Inactive	Active	CTDI – STAP <sub>0</sub> – STAP <sub>2</sub> – PTDO
0	1	0	0	0	1	Active	Active	Inactive	CTDI – STAP <sub>1</sub> – STAP <sub>2</sub> – PTDO
0	1	0	0	0	0	Active	Active	Active	CTDI – STAP <sub>0</sub> – STAP <sub>1</sub> – STAP <sub>2</sub> – PTDO
0	1	1	1	1	1	Inactive	Inactive	Inactive	CTDI – CTDO
0	1	1	1	1	0	Inactive	Inactive	Active	CTDI – STAP <sub>0</sub> – CTDO
0	1	1	1	0	1	Inactive	Active	Inactive	CTDI – STAP <sub>1</sub> – CTDO
0	1	1	1	0	0	Inactive	Active	Active	CTDI – STAP <sub>0</sub> – STAP <sub>1</sub> – CTDO
0	1	1	0	1	1	Active	Inactive	Inactive	CTDI – STAP <sub>2</sub> – CTDO
0	1	1	0	1	0	Active	Inactive	Active	CTDI – STAP <sub>0</sub> – STAP <sub>2</sub> – CTDO
0	1	1	0	0	1	Active	Active	Inactive	CTDI – STAP <sub>1</sub> – STAP <sub>2</sub> – CTDO
0	1	1	0	0	0	Active	Active	Active	CTDI – STAP <sub>0</sub> – STAP <sub>1</sub> – STAP <sub>2</sub> – CTDO
1	X	X	X	X	X	As requested by linking shadow protocol			

Linking shadow protocol and data-flow timing for three cascaded LASPs is shown in Figure 10. The linking shadow protocol result is a match and the prior connect status is OFF. The first LASP (LASP<sub>0</sub>) in the cascade chain has only STAP<sub>0</sub> active, the second LASP (LASP<sub>1</sub>) has STAP<sub>0</sub> and STAP<sub>2</sub> active, while the third or last LASP (LASP<sub>2</sub>) has all three secondary TAPs (STAP<sub>0</sub>, STAP<sub>1</sub>, STAP<sub>2</sub>) active.

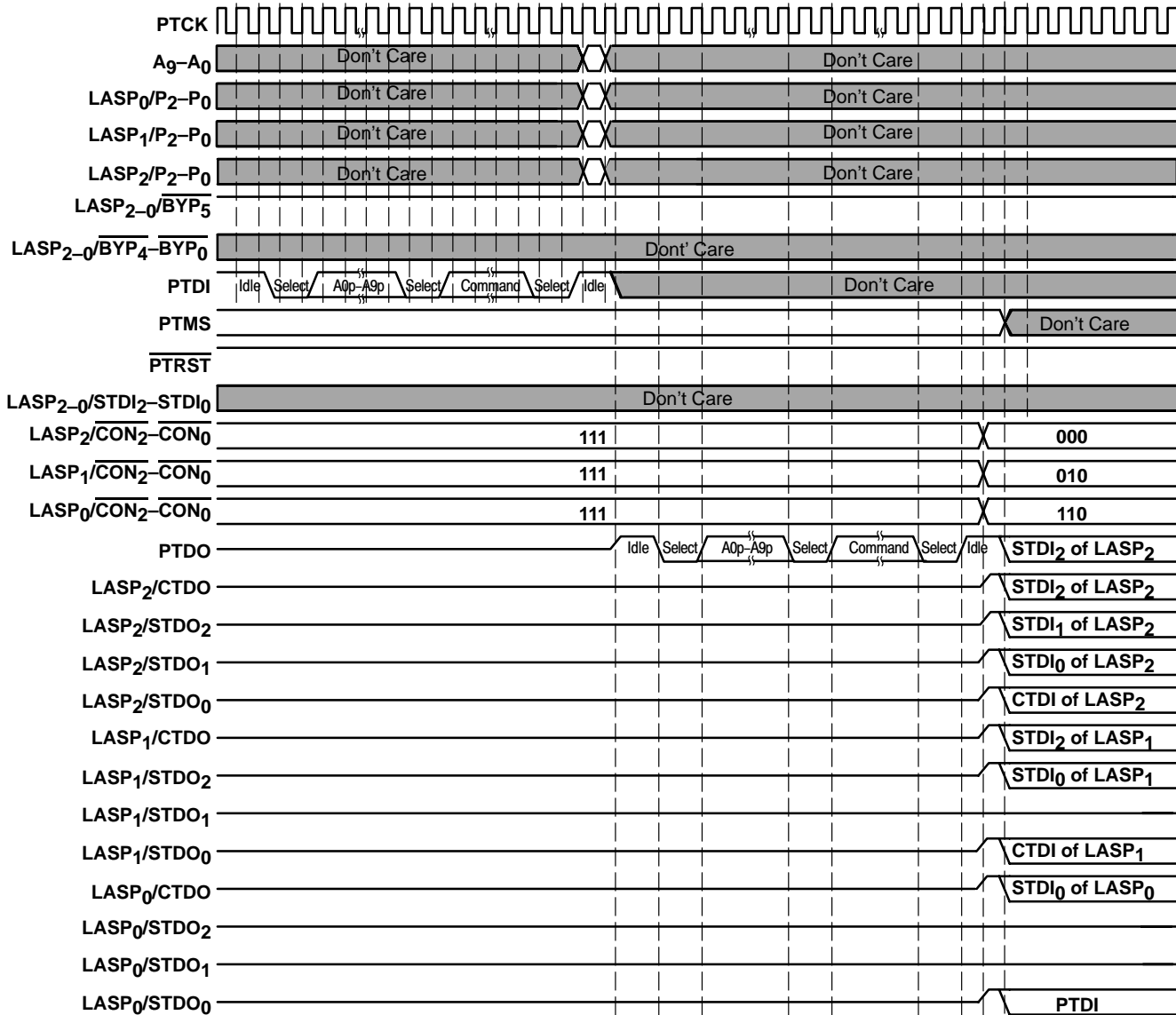

Figure 10. Linking Shadow Protocol and Data-Flow Timing for Three Cascaded LASPs

## 4 Linking Shadow Protocol Errors in Command Field

The command field received during the select protocol is required to be a multiple of 6-bit pairs, otherwise the protocol result is HARD ERROR. The receipt of a long command field, i.e., greater than 48-bit pairs, also results in HARD ERROR. If the configuration field received in the single-device mode is decoded as 111 or all the configuration fields received when multiple LASPs are cascaded are decoded as 111, the protocol result is HARD ERROR. When the protocol result is HARD ERROR, connections to LASPs are dissolved.

If the number of positions and configurations received is greater than actual LASPs cascaded, or if a received position does not match that of any cascaded LASPs, then the LASP operation is undefined.

## 5 Summary

The capability of cascading a maximum of eight LASPs exists. This allows accessing 24 separate scan paths, either individually, in selected combinations, or all linked together into one scan path. The secondary TAPs of all the cascaded LASPs can be configured using a single linking shadow protocol or protocol bypass inputs. All cascaded LASPs share the same address; as such, their  $A_9$ – $A_0$  inputs are tied together. The position inputs  $P_2$ – $P_0$  identify their position in the cascaded chain. The position and corresponding configuration bits received during linking shadow protocol determine the primary-to-secondary TAPs connections for the matching LASP. When protocol-bypass inputs are used, inputs  $\overline{BYP}_4$  and  $\overline{BYP}_3$  identify the position of LASP in the cascaded chain, while inputs  $\overline{BYP}_2$ – $\overline{BYP}_0$  configure the primary-to-secondary TAPs connections.

## 6 References

1. *A Proposed Method of Accessing 1149.1 in a Backplane Environment* (SCTA032).
2. *Partitioning Designs With 1149.1 Scan Capabilities* (SCTA031).



## IMPORTANT NOTICE

Texas Instruments Incorporated and its subsidiaries (TI) reserve the right to make corrections, modifications, enhancements, improvements, and other changes to its products and services at any time and to discontinue any product or service without notice. Customers should obtain the latest relevant information before placing orders and should verify that such information is current and complete. All products are sold subject to TI's terms and conditions of sale supplied at the time of order acknowledgment.

TI warrants performance of its hardware products to the specifications applicable at the time of sale in accordance with TI's standard warranty. Testing and other quality control techniques are used to the extent TI deems necessary to support this warranty. Except where mandated by government requirements, testing of all parameters of each product is not necessarily performed.

TI assumes no liability for applications assistance or customer product design. Customers are responsible for their products and applications using TI components. To minimize the risks associated with customer products and applications, customers should provide adequate design and operating safeguards.

TI does not warrant or represent that any license, either express or implied, is granted under any TI patent right, copyright, mask work right, or other TI intellectual property right relating to any combination, machine, or process in which TI products or services are used. Information published by TI regarding third-party products or services does not constitute a license from TI to use such products or services or a warranty or endorsement thereof. Use of such information may require a license from a third party under the patents or other intellectual property of the third party, or a license from TI under the patents or other intellectual property of TI.

Reproduction of information in TI data books or data sheets is permissible only if reproduction is without alteration and is accompanied by all associated warranties, conditions, limitations, and notices. Reproduction of this information with alteration is an unfair and deceptive business practice. TI is not responsible or liable for such altered documentation.

Resale of TI products or services with statements different from or beyond the parameters stated by TI for that product or service voids all express and any implied warranties for the associated TI product or service and is an unfair and deceptive business practice. TI is not responsible or liable for any such statements.

### Mailing Address:

Texas Instruments  
Post Office Box 655303  
Dallas, Texas 75265