

TMS320C28x Optimizing C/C++ Compiler v18.1.0.LTS

User's Guide



Literature Number: SPRU514P

January 2018

Preface	10
1 Introduction to the Software Development Tools	13
1.1 Software Development Tools Overview	14
1.2 Compiler Interface.....	15
1.3 ANSI/ISO Standard	16
1.4 Output Files	16
1.5 Utilities	16
2 Using the C/C++ Compiler	17
2.1 About the Compiler.....	18
2.2 Invoking the C/C++ Compiler	18
2.3 Changing the Compiler's Behavior with Options	19
2.3.1 Linker Options	26
2.3.2 Frequently Used Options	28
2.3.3 Miscellaneous Useful Options	29
2.3.4 Run-Time Model Options.....	31
2.3.5 Symbolic Debugging and Profiling Options	32
2.3.6 Specifying Filenames	33
2.3.7 Changing How the Compiler Interprets Filenames	33
2.3.8 Changing How the Compiler Processes C Files	33
2.3.9 Changing How the Compiler Interprets and Names Extensions	34
2.3.10 Specifying Directories.....	34
2.3.11 Assembler Options	34
2.3.12 Dynamic Linking	36
2.3.13 Deprecated Options.....	36
2.4 Controlling the Compiler Through Environment Variables.....	37
2.4.1 Setting Default Compiler Options (C2000_C_OPTION)	37
2.4.2 Naming One or More Alternate Directories (C2000_C_DIR)	38
2.5 Controlling the Preprocessor	38
2.5.1 Predefined Macro Names	39
2.5.2 The Search Path for #include Files	40
2.5.3 Support for the #warning and #warn Directives	41
2.5.4 Generating a Preprocessed Listing File (--preproc_only Option)	41
2.5.5 Continuing Compilation After Preprocessing (--preproc_with_compile Option)	41
2.5.6 Generating a Preprocessed Listing File with Comments (--preproc_with_comment Option)	42
2.5.7 Generating Preprocessed Listing with Line-Control Details (--preproc_with_line Option)	42
2.5.8 Generating Preprocessed Output for a Make Utility (--preproc_dependency Option)	42
2.5.9 Generating a List of Files Included with #include (--preproc_includes Option)	42
2.5.10 Generating a List of Macros in a File (--preproc_macros Option)	42
2.6 Passing Arguments to main().....	42
2.7 Understanding Diagnostic Messages.....	43
2.7.1 Controlling Diagnostic Messages	44
2.7.2 How You Can Use Diagnostic Suppression Options	45
2.8 Other Messages	46
2.9 Generating Cross-Reference Listing Information (--gen_cross_reference Option).....	46
2.10 Generating a Raw Listing File (--gen_preprocessor_listing Option).....	47

2.11	Using Inline Function Expansion	48
2.11.1	Inlining Intrinsic Operators	49
2.11.2	Unguarded Definition-Controlled Inlining.....	49
2.11.3	Guarded Inlining and the <code>_INLINE</code> Preprocessor Symbol	50
2.11.4	Inlining Restrictions	51
2.12	Using Interlist	52
2.13	Enabling Entry Hook and Exit Hook Functions.....	53
3	Optimizing Your Code	54
3.1	Invoking Optimization	55
3.2	Performing File-Level Optimization (<code>--opt_level=3</code> option).....	56
3.2.1	Creating an Optimization Information File (<code>--gen_opt_info</code> Option).....	56
3.3	Program-Level Optimization (<code>--program_level_compile</code> and <code>--opt_level=3</code> options).....	56
3.3.1	Controlling Program-Level Optimization (<code>--call_assumptions</code> Option).....	57
3.3.2	Optimization Considerations When Mixing C/C++ and Assembly	58
3.4	Link-Time Optimization (<code>--opt_level=4</code> Option)	59
3.4.1	Option Handling	59
3.4.2	Incompatible Types	59
3.5	Using Feedback Directed Optimization.....	59
3.5.1	Feedback Directed Optimization	60
3.5.2	Profile Data Decoder.....	62
3.5.3	Feedback Directed Optimization API	63
3.5.4	Feedback Directed Optimization Summary	63
3.6	Using Profile Information to Analyze Code Coverage.....	64
3.6.1	Code Coverage.....	64
3.6.2	Related Features and Capabilities	65
3.7	Special Considerations When Using Optimization.....	66
3.7.1	Use Caution With <code>asm</code> Statements in Optimized Code	66
3.7.2	Use the Volatile Keyword for Necessary Memory Accesses	66
3.8	Automatic Inline Expansion (<code>--auto_inline</code> Option)	68
3.9	Using the Interlist Feature With Optimization.....	68
3.10	Data Page (DP) Pointer Load Optimization.....	71
3.11	Debugging and Profiling Optimized Code.....	71
3.11.1	Profiling Optimized Code.....	71
3.12	Controlling Code Size Versus Speed	72
3.13	Increasing Code-Size Optimizations (<code>--opt_for_space</code> Option).....	73
3.14	Compiler Support for Generating DMAC Instructions	74
3.14.1	Automatic Generation of DMAC Instructions	75
3.14.2	Assertions to Specify Data Address Alignment	75
3.14.3	<code>__dmac</code> Intrinsic	76
3.15	What Kind of Optimization Is Being Performed?	77
3.15.1	Cost-Based Register Allocation	77
3.15.2	Alias Disambiguation	77
3.15.3	Branch Optimizations and Control-Flow Simplification	78
3.15.4	Data Flow Optimizations	78
3.15.5	Expression Simplification.....	78
3.15.6	Inline Expansion of Functions	78
3.15.7	Function Symbol Aliasing	78
3.15.8	Induction Variables and Strength Reduction	79
3.15.9	Loop-Invariant Code Motion	79
3.15.10	Loop Rotation	79
3.15.11	Instruction Scheduling.....	79
3.15.12	Register Variables	79
3.15.13	Register Tracking/Targeting.....	79

3.15.14	Tail Merging	79
3.15.15	Autoincrement Addressing	79
3.15.16	Removing Comparisons to Zero	80
3.15.17	RPTB Generation (for FPU Targets Only).....	80
4	Linking C/C++ Code	81
4.1	Invoking the Linker Through the Compiler (-z Option)	82
4.1.1	Invoking the Linker Separately	82
4.1.2	Invoking the Linker as Part of the Compile Step	83
4.1.3	Disabling the Linker (--compile_only Compiler Option)	83
4.2	Linker Code Optimizations	84
4.2.1	Generating Function Subsections (--gen_func_subsections Compiler Option)	84
4.2.2	Generating Aggregate Data Subsections (--gen_data_subsections Compiler Option)	84
4.3	Controlling the Linking Process	84
4.3.1	Including the Run-Time-Support Library	84
4.3.2	Run-Time Initialization	85
4.3.3	Initialization by the Interrupt Vector	86
4.3.4	Global Object Constructors	86
4.3.5	Specifying the Type of Global Variable Initialization.....	86
4.3.6	Specifying Where to Allocate Sections in Memory	87
4.3.7	A Sample Linker Command File	88
4.4	Linking C28x and C2XLP Code	89
5	Post-Link Optimizer	90
5.1	The Post-Link Optimizer's Role in the Software Development Flow	91
5.2	Removing Redundant DP Loads	92
5.3	Tracking DP Values Across Branches.....	92
5.4	Tracking DP Values Across Function Calls.....	93
5.5	Other Post-Link Optimizations	93
5.6	Controlling Post-Link Optimizations.....	94
5.6.1	Excluding Files (-ex Option)	94
5.6.2	Controlling Post-Link Optimization Within an Assembly File	94
5.6.3	Retaining Post-Link Optimizer Output (--keep_asm Option)	94
5.6.4	Disable Optimization Across Function Calls (-nf Option).....	94
5.6.5	Annotating Assembly with Advice (--plink_advice_only option)	94
5.7	Restrictions on Using the Post-Link Optimizer	95
5.8	Naming the Outfile (--output_file Option).....	95
6	TMS320C28x C/C++ Language Implementation	96
6.1	Characteristics of TMS320C28x C	97
6.1.1	Implementation-Defined Behavior.....	97
6.2	Characteristics of TMS320C28x C++	101
6.3	Using MISRA C 2004	102
6.4	Data Types	103
6.4.1	Size of Enum Types	103
6.4.2	Support for 64-Bit Integers	103
6.4.3	C28x long double Floating-Point Type Change.....	104
6.5	Keywords	105
6.5.1	The const Keyword	105
6.5.2	The __register Keyword	106
6.5.3	The __interrupt Keyword.....	107
6.5.4	The restrict Keyword	108
6.5.5	The volatile Keyword	108
6.6	C++ Exception Handling	110
6.7	Register Variables and Parameters	110
6.8	The __asm Statement.....	111

6.9	Pragma Directives	112
6.9.1	The CALLS Pragma	113
6.9.2	The CHECK_MISRA Pragma	113
6.9.3	The CLINK Pragma.....	113
6.9.4	The CODE_ALIGN Pragma	114
6.9.5	The CODE_SECTION Pragma	114
6.9.6	The DATA_ALIGN Pragma.....	116
6.9.7	The DATA_SECTION Pragma	117
6.9.8	The Diagnostic Message Pragmas	118
6.9.9	The FAST_FUNC_CALL Pragma	118
6.9.10	The FUNC_ALWAYS_INLINE Pragma	120
6.9.11	The FUNC_CANNOT_INLINE Pragma	120
6.9.12	The FUNC_EXT_CALLED Pragma	121
6.9.13	The FUNCTION_OPTIONS Pragma	121
6.9.14	The INTERRUPT Pragma	121
6.9.15	The MUST_ITERATE Pragma	123
6.9.16	The NO_HOOKS Pragma	124
6.9.17	The RESET_MISRA Pragma	124
6.9.18	The RETAIN Pragma.....	124
6.9.19	The SET_CODE_SECTION and SET_DATA_SECTION Pragmas.....	125
6.9.20	The UNROLL Pragma.....	126
6.10	The _Pragma Operator	126
6.11	Object File Symbol Naming Conventions (Linknames)	127
6.12	Initializing Static and Global Variables	127
6.12.1	Initializing Static and Global Variables With the Linker	127
6.12.2	Initializing Static and Global Variables With the const Type Qualifier	128
6.13	Changing the ANSI/ISO C/C++ Language Mode.....	128
6.13.1	C99 Support (--c99)	129
6.13.2	Strict ANSI Mode and Relaxed ANSI Mode (--strict_ansi and --relaxed_ansi)	130
6.14	GNU and Clang Language Extensions	131
6.14.1	Extensions	131
6.14.2	Function Attributes.....	132
6.14.3	Variable Attributes	133
6.14.4	Type Attributes	133
6.14.5	Built-In Functions	133
6.14.6	Using the Byte Peripheral Type Attribute.....	134
6.15	Compiler Limits.....	135
7	Run-Time Environment.....	136
7.1	Memory Model	137
7.1.1	Sections	137
7.1.2	C/C++ System Stack	138
7.1.3	Allocating _econst to Program Memory	139
7.1.4	Dynamic Memory Allocation.....	139
7.1.5	Initialization of Variables	140
7.1.6	Allocating Memory for Static and Global Variables.....	140
7.1.7	Field/Structure Alignment	140
7.1.8	Character String Constants.....	140
7.2	Register Conventions	141
7.2.1	TMS320C28x Register Use and Preservation	141
7.2.2	Status Registers	142
7.3	Function Structure and Calling Conventions	143
7.3.1	How a Function Makes a Call	143
7.3.2	How a Called Function Responds	144

7.3.3	Special Case for a Called Function (Large Frames)	145
7.3.4	Accessing Arguments and Local Variables.....	145
7.3.5	Allocating the Frame and Accessing 32-Bit Values in Memory.....	146
7.4	Accessing Linker Symbols in C and C++.....	146
7.5	Interfacing C and C++ With Assembly Language	146
7.5.1	Using Assembly Language Modules With C/C++ Code	146
7.5.2	Accessing Assembly Language Functions From C/C++	147
7.5.3	Accessing Assembly Language Variables From C/C++	148
7.5.4	Sharing C/C++ Header Files With Assembly Source	149
7.5.5	Using Inline Assembly Language.....	150
7.5.6	Using Intrinsics to Access Assembly Language Statements.....	151
7.6	Interrupt Handling.....	158
7.6.1	General Points About Interrupts	158
7.6.2	Using C/C++ Interrupt Routines	158
7.7	Integer Expression Analysis	159
7.7.1	Operations Evaluated With Run-Time-Support Calls	159
7.7.2	C/C++ Code Access to the Upper 16 Bits of 16-Bit Multiply	159
7.8	Floating-Point Expression Analysis.....	160
7.9	System Initialization	160
7.9.1	Boot Hook Functions for System Pre-Initialization	161
7.9.2	Run-Time Stack.....	161
7.9.3	Automatic Initialization of Variables	162
8	Using Run-Time-Support Functions and Building Libraries	166
8.1	C and C++ Run-Time Support Libraries	167
8.1.1	Linking Code With the Object Library	167
8.1.2	Header Files	167
8.1.3	Modifying a Library Function	167
8.1.4	Support for String Handling.....	168
8.1.5	Minimal Support for Internationalization	168
8.1.6	Allowable Number of Open Files	168
8.1.7	Library Naming Conventions	168
8.2	The C I/O Functions	169
8.2.1	High-Level I/O Functions	170
8.2.2	Overview of Low-Level I/O Implementation	171
8.2.3	Device-Driver Level I/O Functions.....	174
8.2.4	Adding a User-Defined Device Driver for C I/O.....	178
8.2.5	The device Prefix	179
8.3	Handling Reentrancy (_register_lock() and _register_unlock() Functions).....	181
8.4	Library-Build Process.....	182
8.4.1	Required Non-Texas Instruments Software	182
8.4.2	Using the Library-Build Process	182
8.4.3	Extending mklib	185
9	C++ Name Demangler	186
9.1	Invoking the C++ Name Demangler	187
9.2	C++ Name Demangler Options	187
9.3	Sample Usage of the C++ Name Demangler	188
10	CLA Compiler.....	190
10.1	How to Invoke the CLA Compiler.....	191
10.2	CLA C Language Implementation	192
10.2.1	Characteristics	192
10.2.2	C Language Restrictions.....	193
10.2.3	Memory Model - Sections	194
10.2.4	Function Structure and Calling Conventions	194

A	Glossary	195
	A.1 Terminology	195
B	Revision History	200
	B.1 Recent Revisions	200

List of Figures

1-1.	TMS320C28x Software Development Flow.....	14
5-1.	The Post-Link Optimizer in the TMS320C28x Software Development Flow	91
7-1.	Use of the Stack During a Function Call.....	143
7-2.	Format of Initialization Records in the .cinit Section	162
7-3.	Format of Initialization Records in the .pinit Section	163
7-4.	Autoinitialization at Run Time	164
7-5.	Initialization at Load Time	165
10-1.	CLA Compilation Overview	191

List of Tables

2-1.	Processor Options	19
2-2.	Optimization Options	19
2-3.	Advanced Optimization Options	20
2-4.	Debug Options	20
2-5.	Include Options	20
2-6.	Control Options	21
2-7.	Language Options.....	21
2-8.	Parser Preprocessing Options.....	21
2-9.	Predefined Symbols Options	22
2-10.	Diagnostic Message Options	22
2-11.	Run-Time Model Options.....	23
2-12.	Entry/Exit Hook Options	23
2-13.	Feedback Options	23
2-14.	Assembler Options	24
2-15.	File Type Specifier Options	24
2-16.	Directory Specifier Options.....	24
2-17.	Default File Extensions Options	25
2-18.	Command Files Options.....	25
2-19.	MISRA-C 2004 Options	25
2-20.	Linker Basic Options	26
2-21.	File Search Path Options.....	26
2-22.	Command File Preprocessing Options	26
2-23.	Diagnostic Message Options	26
2-24.	Linker Output Options	27
2-25.	Symbol Management Options	27
2-26.	Run-Time Environment Options	27
2-27.	Link-Time Optimization Options	27
2-28.	Miscellaneous Options.....	28
2-29.	Linker Options For Dynamic Linking.....	36
2-30.	Predefined C28x Macro Names	39
2-31.	Raw Listing File Identifiers	47
2-32.	Raw Listing File Diagnostic Identifiers.....	47
3-1.	Interaction Between Debugging and Optimization Options.....	56
3-2.	Options That You Can Use With --opt_level=3.....	56
3-3.	Selecting a Level for the --gen_opt_info Option.....	56
3-4.	Selecting a Level for the --call_assumptions Option.....	57
3-5.	Special Considerations When Using the --call_assumptions Option	57

3-6.	Interaction Between Debugging and Optimization Options	71
4-1.	Initialized Sections Created by the Compiler	87
4-2.	Uninitialized Sections Created by the Compiler	87
6-1.	TMS320C28x C/C++ Data Types.....	103
6-2.	Valid Control Registers.....	106
6-3.	GCC Language Extensions	131
7-1.	Summary of Sections and Memory Placement	138
7-2.	Register Use and Preservation Conventions.....	141
7-3.	FPU Register Use and Preservation Conventions	141
7-4.	Status Register Fields	142
7-5.	Floating-Point Status Register (STF) Fields For FPU Targets Only	142
7-6.	TMS320C28x C/C++ Compiler Intrinsics	151
7-7.	C/C++ Compiler Intrinsics for FPU	156
7-8.	C/C++ Compiler Intrinsics for TMU	156
8-1.	The mklib Program Options	184
10-1.	C/C++ Compiler Intrinsics for CLA	192
B-1.	Revision History.....	200

Read This First

About This Manual

The *TMS320C28x Optimizing C/C++ Compiler User's Guide* explains how to use the following Texas Instruments Code Generation compiler tools:

- Compiler
- Post-link optimizer
- Library build utility
- C++ name demangler

The TI compiler accepts C and C++ code conforming to the International Organization for Standardization (ISO) standards for these languages. The compiler supports both the 1989 and 1999 versions of the C language and the 2003 version of the C++ language.

This user's guide discusses the characteristics of the TI C/C++ compiler. It assumes that you already know how to write C/C++ programs. *The C Programming Language* (second edition), by Brian W. Kernighan and Dennis M. Ritchie, describes C based on the ISO C standard. You can use the Kernighan and Ritchie (hereafter referred to as K&R) book as a supplement to this manual. References to K&R C (as opposed to ISO C) in this manual refer to the C language as defined in the first edition of Kernighan and Ritchie's *The C Programming Language*.

Notational Conventions

This document uses the following conventions:

- Program listings, program examples, and interactive displays are shown in a *special typeface*. Interactive displays use a **bold version** of the special typeface to distinguish commands that you enter from items that the system displays (such as prompts, command output, error messages, etc.).

Here is a sample of C code:

```
#include <stdio.h>
main()
{   printf("Hello World\n");
}
```

- In syntax descriptions, instructions, commands, and directives are in a **bold typeface** and parameters are in an *italic typeface*. Portions of a syntax that are in bold should be entered as shown; portions of a syntax that are in italics describe the type of information that should be entered.
- Square brackets ([and]) identify an optional parameter. If you use an optional parameter, you specify the information within the brackets. Unless the square brackets are in the **bold typeface**, do not enter the brackets themselves. The following is an example of a command that has an optional parameter:

```
cl2000 [options] [filenames] [--run_linker [link_options] [object files]]
```

- Braces ({ and }) indicate that you must choose one of the parameters within the braces; you do not enter the braces themselves. This is an example of a command with braces that are not included in the actual syntax but indicate that you must specify either the --rom_model or --ram_model option:

```
cl2000 --run_linker {--rom_model | --ram_model} filenames
  [--output_file= name.out] --library= libraryname
```

- In assembler syntax statements, the leftmost column is reserved for the first character of a label or symbol. If the label or symbol is optional, it is usually not shown. If a label or symbol is a required parameter, it is shown starting against the left margin of the box, as in the example below. No instruction, command, directive, or parameter, other than a symbol or label, can begin in the leftmost column.

<i>symbol</i> .usect "section name", size in bytes[, alignment]
--

- Some directives can have a varying number of parameters. For example, the `.byte` directive. This syntax is shown as `[, ..., parameter]`.
- The TMS320C2800™ core is referred to as TMS320C28x or C28x.

Related Documentation

You can use the following books to supplement this user's guide:

ANSI X3.159-1989, Programming Language - C (Alternate version of the 1989 C Standard), American National Standards Institute

ISO/IEC 9899:1989, International Standard - Programming Languages - C (The 1989 C Standard), International Organization for Standardization

ISO/IEC 9899:1999, International Standard - Programming Languages - C (The 1999 C Standard), International Organization for Standardization

ISO/IEC 14882-2003, International Standard - Programming Languages - C++ (The 2003 C++ Standard), International Organization for Standardization

The C Programming Language (second edition), by Brian W. Kernighan and Dennis M. Ritchie, published by Prentice-Hall, Englewood Cliffs, New Jersey, 1988

The Annotated C++ Reference Manual, Margaret A. Ellis and Bjarne Stroustrup, published by Addison-Wesley Publishing Company, Reading, Massachusetts, 1990

C: A Reference Manual (fourth edition), by Samuel P. Harbison, and Guy L. Steele Jr., published by Prentice Hall, Englewood Cliffs, New Jersey

Programming Embedded Systems in C and C++, by Michael Barr, Andy Oram (Editor), published by O'Reilly & Associates; ISBN: 1565923545, February 1999

Programming in C, Steve G. Kochan, Hayden Book Company

The C++ Programming Language (second edition), Bjarne Stroustrup, published by Addison-Wesley Publishing Company, Reading, Massachusetts, 1990

Tool Interface Standards (TIS) DWARF Debugging Information Format Specification Version 2.0, TIS Committee, 1995

DWARF Debugging Information Format Version 3, DWARF Debugging Information Format Workgroup, Free Standards Group, 2005 (<http://dwarfstd.org>)

DWARF Debugging Information Format Version 4, DWARF Debugging Information Format Workgroup, Free Standards Group, 2010 (<http://dwarfstd.org>)

System V ABI specification (<http://www.sco.com/developers/gabi/>)

Related Documentation From Texas Instruments

See the following resources for further information about the TI Code Generation Tools:

- Texas Instruments Wiki: [Compiler topics](#)
- Texas Instruments E2E Community: [Compiler forum](#)

You can use the following documents to supplement this user's guide:

SPRAAB5 — *The Impact of DWARF on TI Object Files*. Describes the Texas Instruments extensions to the DWARF specification.

SPRU513 — *TMS320C28x Assembly Language Tools User's Guide* describes the assembly language tools (assembler and other tools used to develop assembly language code), assembler directives, macros, common object file format, and symbolic debugging directives for the TMS320C28x device.

SPRU430 — *TMS320C28x DSP CPU and Instruction Set Reference Guide* describes the central processing unit (CPU) and the assembly language instructions of the TMS320C28x fixed-point digital signal processors (DSPs). It also describes emulation features available on these DSPs.

SPRU566 — *TMS320x28xx, 28xxx Peripheral Reference Guide* describes the peripheral reference guides of the 28x digital signal processors (DSPs).

SPRUEX3 — *TI SYS/BIOS Real-time Operating System User's Guide*. SYS/BIOS gives application developers the ability to develop embedded real-time software. SYS/BIOS is a scalable real-time kernel. It is designed to be used by applications that require real-time scheduling and synchronization or real-time instrumentation. SYS/BIOS provides preemptive multithreading, hardware abstraction, real-time analysis, and configuration tools.

Trademarks

TMS320C2800, TMS320C28x are trademarks of Texas Instruments.
All other trademarks are the property of their respective owners.

Introduction to the Software Development Tools

The TMS320C28x™ is supported by a set of software development tools, which includes an optimizing C/C++ compiler, an assembler, a linker, and assorted utilities.

This chapter provides an overview of these tools and introduces the features of the optimizing C/C++ compiler. The assembler and linker are discussed in detail in the *TMS320C28x Assembly Language Tools User's Guide*.

Topic	Page
1.1 Software Development Tools Overview	14
1.2 Compiler Interface	15
1.3 ANSI/ISO Standard	16
1.4 Output Files	16
1.5 Utilities	16

1.1 Software Development Tools Overview

Figure 1-1 illustrates the software development flow. The shaded portion of the figure highlights the most common path of software development for C language programs. The other portions are peripheral functions that enhance the development process.

Figure 1-1. TMS320C28x Software Development Flow

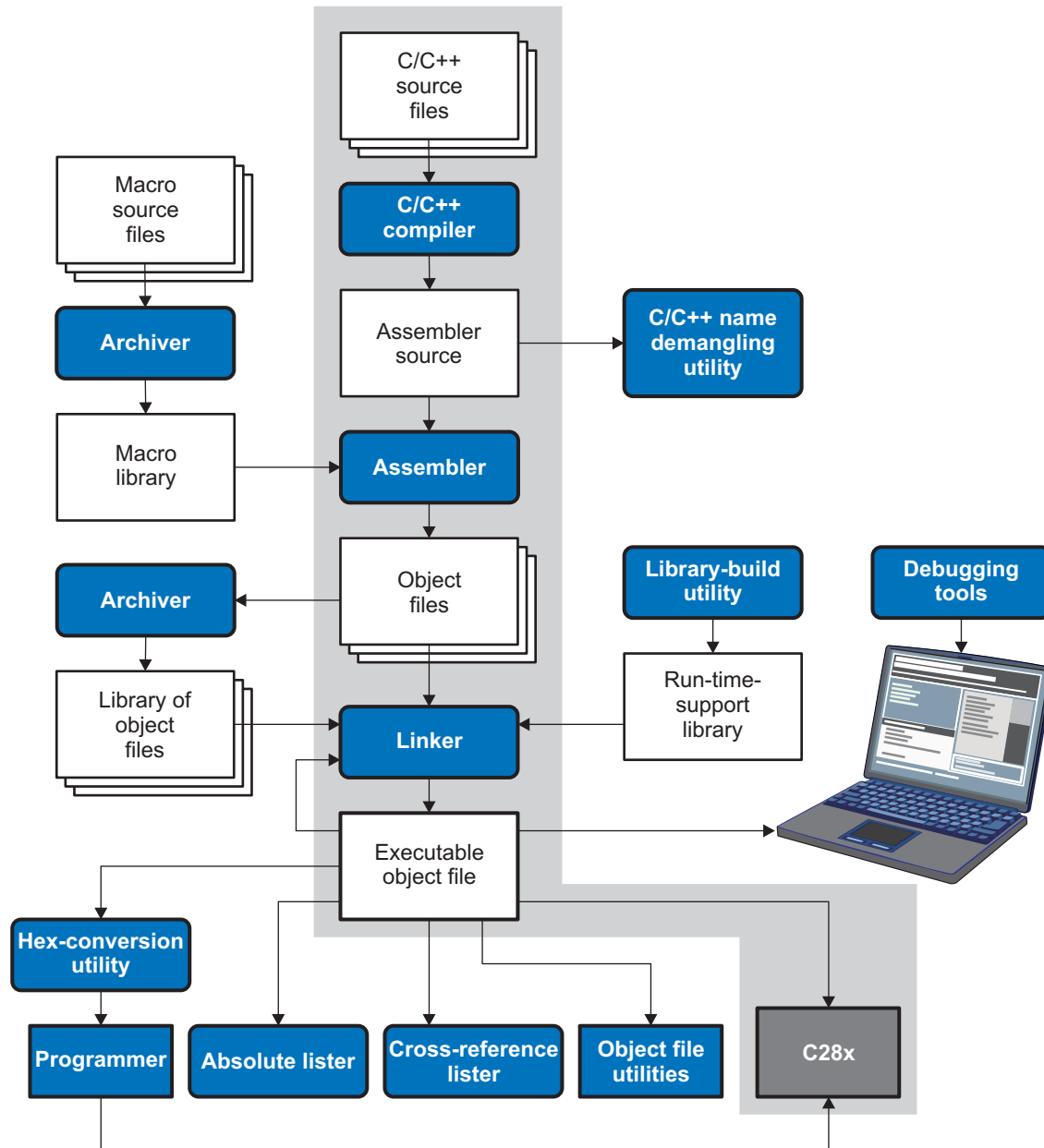

The following list describes the tools that are shown in Figure 1-1:

- The **compiler** accepts C/C++ source code and produces C28x assembly language source code. See [Chapter 2](#).
- The **assembler** translates assembly language source files into machine language relocatable object files. See the *TMS320C28x Assembly Language Tools User's Guide*.
- The **linker** combines relocatable object files into a single absolute executable object file. As it creates the executable file, it performs relocation and resolves external references. The linker accepts relocatable object files and object libraries as input. See [Chapter 4](#) for an overview of the linker. See the *TMS320C28x Assembly Language Tools User's Guide* for details.

- The **archiver** allows you to collect a group of files into a single archive file, called a *library*. The archiver allows you to modify such libraries by deleting, replacing, extracting, or adding members. One of the most useful applications of the archiver is building a library of object files. See the *TMS320C28x Assembly Language Tools User's Guide*.
- The **run-time-support libraries** contain the standard ISO C and C++ library functions, compiler-utility functions, floating-point arithmetic functions, and C I/O functions that are supported by the compiler. See [Chapter 8](#).
The **library-build utility** automatically builds the run-time-support library if compiler and linker options require a custom version of the library. See [Section 8.4](#). Source code for the standard run-time-support library functions for C and C++ is provided in the lib\src subdirectory of the directory where the compiler is installed.
- The **hex conversion utility** converts an object file into other object formats. You can download the converted file to an EPROM programmer. See the *TMS320C28x Assembly Language Tools User's Guide*.
- The **absolute lister** accepts linked object files as input and creates .abs files as output. You can assemble these .abs files to produce a listing that contains absolute, rather than relative, addresses. Without the absolute lister, producing such a listing would be tedious and would require many manual operations. See the *TMS320C28x Assembly Language Tools User's Guide*.
- The **cross-reference lister** uses object files to produce a cross-reference listing showing symbols, their definitions, and their references in the linked source files. See the *TMS320C28x Assembly Language Tools User's Guide*.
- The **C++ name demangler** is a debugging aid that converts names mangled by the compiler back to their original names as declared in the C++ source code. As shown in [Figure 1-1](#), you can use the C++ name demangler on the assembly file that is output by the compiler; you can also use this utility on the assembler listing file and the linker map file. See [Chapter 9](#).
- The **post-link optimizer** removes or modifies assembly language instructions to generate better code. The post-link optimizer must be run with the compiler -plink option. See [Chapter 5](#).
- The **disassembler** decodes object files to show the assembly instructions that they represent. See the *TMS320C28x Assembly Language Tools User's Guide*.
- The main product of this development process is an executable object file that can be executed in a **TMS320C28x** device.

1.2 Compiler Interface

The compiler is a command-line program named cl2000. This program can compile, optimize, assemble, and link programs in a single step. Within Code Composer Studio, the compiler is run automatically to perform the steps needed to build a project.

For more information about compiling a program, see [Section 2.1](#)

The compiler has straightforward calling conventions, so you can write assembly and C functions that call each other. For more information about calling conventions, see [Chapter 7](#).

1.3 ANSI/ISO Standard

The compiler supports both the 1989 and 1999 versions of the C language and the 2003 version of the C++ language. The C and C++ language features in the compiler are implemented in conformance with the following ISO standards:

- **ISO-standard C**

The C compiler supports the 1989 and 1999 versions of the C language.

- **C89.** Compiling with the `--c89` option causes the compiler to conform to the ISO/IEC 9899:1990 C standard, which was previously ratified as ANSI X3.159-1989. The names "C89" and "C90" refer to the same programming language. "C89" is used in this document.
- **C99.** Compiling with the `--c99` option causes the compiler to conform to the ISO/IEC 9899:1999 C standard. This standard supports several features not part of C89, such as inline functions, new data types, and one-line comments beginning with `//`.

The C language is also described in the second edition of Kernighan and Ritchie's *The C Programming Language* (K&R).

- **ISO-standard C++**

The compiler uses the C++03 version of the C++ standard. See the C++ Standard ISO/IEC 14882:2003. The language is also described in Ellis and Stroustrup's *The Annotated C++ Reference Manual* (ARM), but that is not the standard. For a description of *unsupported* C++ features, see [Section 6.2](#).

- **ISO-standard run-time support**

The compiler tools come with an extensive run-time library. Library functions conform to the ISO C/C++ library standard unless otherwise stated. The library includes functions for standard input and output, string manipulation, dynamic memory allocation, data conversion, timekeeping, trigonometry, and exponential and hyperbolic functions. Functions for signal handling are not included, because these are target-system specific. For more information, see [Chapter 8](#).

See [Section 6.13](#) for command line options to select the C or C++ standard your code uses.

1.4 Output Files

The following type of output file is created by the compiler:

- **COFF object files**

Common object file format (COFF) provides basic modular (separately-compiled) compilation features, such as relocations.

1.5 Utilities

These features are compiler utilities:

- **Library-build utility**

The library-build utility lets you custom-build object libraries from source for any combination of run-time models. For more information, see [Section 8.4](#).

- **C++ name demangler**

The C++ name demangler (`dem2000`) is a debugging aid that translates each mangled name it detects in compiler-generated assembly code, disassembly output, or compiler diagnostic messages to its original name found in the C++ source code. For more information, see [Chapter 9](#).

- **Hex conversion utility**

For stand-alone embedded applications, the compiler has the ability to place all code and initialization data into ROM, allowing C/C++ code to run from reset. The COFF files output by the compiler can be converted to EPROM programmer data files by using the hex conversion utility, as described in the *TMS320C28x Assembly Language Tools User's Guide*.

Using the C/C++ Compiler

The compiler translates your source program into machine language object code that the TMS320C28x can execute. Source code must be compiled, assembled, and linked to create an executable object file. All of these steps are executed at once by using the compiler.

Topic	Page
2.1 About the Compiler	18
2.2 Invoking the C/C++ Compiler	18
2.3 Changing the Compiler's Behavior with Options	19
2.4 Controlling the Compiler Through Environment Variables	37
2.5 Controlling the Preprocessor.....	38
2.6 Passing Arguments to main()	42
2.7 Understanding Diagnostic Messages.....	43
2.8 Other Messages	46
2.9 Generating Cross-Reference Listing Information (--gen_cross_reference Option).....	46
2.10 Generating a Raw Listing File (--gen_preprocessor_listing Option).....	47
2.11 Using Inline Function Expansion.....	48
2.12 Using Interlist	52
2.13 Enabling Entry Hook and Exit Hook Functions	53

2.1 About the Compiler

The compiler lets you compile, optimize, assemble, and optionally link in one step. The compiler performs the following steps on one or more source modules:

- The **compiler** accepts C/C++ source code and assembly code. It produces object code. You can compile C, C++, and assembly files in a single command. The compiler uses the filename extensions to distinguish between different file types. See [Section 2.3.9](#) for more information.
- The **linker** combines object files to create a static executable or dynamic object file. The link step is optional, so you can compile and assemble many modules independently and link them later. See [Chapter 4](#) for information about linking the files.

Invoking the Linker

NOTE: By default, the compiler does not invoke the linker. You can invoke the linker by using the `--run_linker (-z)` compiler option. See [Section 4.1.1](#) for details.

For a complete description of the assembler and the linker, see the *TMS320C28x Assembly Language Tools User's Guide*.

2.2 Invoking the C/C++ Compiler

To invoke the compiler, enter:

```
cl2000 [options] [filenames] [--run_linker [link_options] object files]
```

cl2000	Command that runs the compiler and the assembler.
<i>options</i>	Options that affect the way the compiler processes input files. The options are listed in Table 2-6 through Table 2-28 .
<i>filenames</i>	One or more C/C++ source files and assembly language source files.
--run_linker (-z)	Option that invokes the linker. The <code>--run_linker</code> option's short form is <code>-z</code> . See Chapter 4 for more information.
<i>link_options</i>	Options that control the linking process.
<i>object files</i>	Names of the object files for the linking process.

The arguments to the compiler are of three types:

- Compiler options
- Link options
- Filenames

The `--run_linker` option indicates linking is to be performed. If the `--run_linker` option is used, any compiler options must precede the `--run_linker` option, and all link options must follow the `--run_linker` option.

Source code filenames must be placed before the `--run_linker` option. Additional object file filenames can be placed after the `--run_linker` option.

For example, if you want to compile two files named `syntab.c` and `file.c`, assemble a third file named `seek.asm`, and link to create an executable program called `myprogram.out`, you will enter:

```
cl2000 syntab.c file.c seek.asm --run_linker --library=lnk.cmd
      --output_file=myprogram.out
```

2.3 Changing the Compiler's Behavior with Options

Options control the operation of the compiler. This section provides a description of option conventions and an option summary table. It also provides detailed descriptions of the most frequently used options, including options used for type-checking and assembling.

For a help screen summary of the options, enter **cl2000** with no parameters on the command line.

The following apply to the compiler options:

- There are typically two ways of specifying a given option. The "long form" uses a two hyphen prefix and is usually a more descriptive name. The "short form" uses a single hyphen prefix and a combination of letters and numbers that are not always intuitive.
- Options are usually case sensitive.
- Individual options cannot be combined.
- An option with a parameter should be specified with an equal sign before the parameter to clearly associate the parameter with the option. For example, the option to undefine a constant can be expressed as `--undefine=name`. Likewise, the option to specify the maximum amount of optimization can be expressed as `-O=3`. You can also specify a parameter directly after certain options, for example `-O3` is the same as `-O=3`. No space is allowed between the option and the optional parameter, so `-O 3` is not accepted.
- Files and options except the `--run_linker` option can occur in any order. The `--run_linker` option must follow all compiler options and precede any linker options.

You can define default options for the compiler by using the `C2000_C_OPTION` environment variable. For a detailed description of the environment variable, see [Section 2.4.1](#).

[Table 2-6](#) through [Table 2-28](#) summarize all options (including link options). Use the references in the tables for more complete descriptions of the options.

Table 2-1. Processor Options

Option	Alias	Effect	Section
<code>--silicon_version=28</code>	<code>-v28</code>	Specifies TMS320C28x architecture. The default (and only value accepted) is 28. This option is no longer required.	Section 2.3.4
<code>--unified_memory</code>	<code>-mt</code>	Generates code for the unified memory model.	Section 2.3.4
<code>--cla_support[=cla0 cla1 cla2]</code>		Specifies TMS320C28x CLA accelerator support for Type 0, Type 1, or Type 2. Default is cla0.	Section 2.3.4
<code>--float_support={fpu32 softlib}</code>		Specifies use of TMS320C28x 32-bit hardware floating-point support. The default is softlib.	Section 2.3.4
<code>--tmu_support[=tmu0]</code>		Enables support for the Trigonometric Math Unit (TMU). Using this option also enables FPU32 support (as with <code>--float_support=fpu32</code>). If this option is used but no value is specified, the default is tmu0.	Section 2.3.4
<code>--vcu_support[=vcu0 vcu2]</code>		Specifies C28x VCU coprocessor support Type 0 or Type 2. Default is vcu0.	Section 2.3.4

Table 2-2. Optimization Options⁽¹⁾

Option	Alias	Effect	Section
<code>--opt_level=off</code>		Disables all optimization (default).	Section 3.1
<code>--opt_level=n</code>	<code>-On</code>	Level 0 (-O0) optimizes register usage only. Level 1 (-O1) uses Level 0 optimizations and optimizes locally. Level 2 (-O2) uses Level 1 optimizations and optimizes globally. Level 3 (-O3) uses Level 2 optimizations and optimizes the file. () Level 4 (-O4) uses Level 3 optimizations and performs link-time optimization. ()	Section 3.1 , Section 3.2 , Section 3.4
<code>--opt_for_space=n</code>	<code>-ms</code>	Controls code size on four levels (0, 1, 2, and 3).	Section 3.13
<code>--fp_mode={relaxed strict}</code>		Enables or disables relaxed floating-point mode.	Section 2.3.3
<code>--fp_reassoc={on off}</code>		Enables or disables the reassociation of floating-point arithmetic.	Section 2.3.3

⁽¹⁾ **Note:** Machine-specific options (see [Table 2-11](#)) can also affect optimization.

Table 2-2. Optimization Options⁽¹⁾ (continued)

Option	Alias	Effect	Section
--sat_reassoc={on off}		Enables or disables the reassociation of saturating arithmetic. Default is --sat_reassoc=off.	Section 2.3.3

Table 2-3. Advanced Optimization Options⁽¹⁾

Option	Alias	Effect	Section
--auto_inline=[size]	-oi	Sets automatic inlining size (--opt_level=3 only). If <i>size</i> is not specified, the default is 1.	Section 3.8
--call_assumptions= <i>n</i>	-op <i>n</i>	Level 0 (-op0) specifies that the module contains functions and variables that are called or modified from outside the source code provided to the compiler. Level 1 (-op1) specifies that the module contains variables modified from outside the source code provided to the compiler but does not use functions called from outside the source code. Level 2 (-op2) specifies that the module contains no functions or variables that are called or modified from outside the source code provided to the compiler (default). Level 3 (-op3) specifies that the module contains functions that are called from outside the source code provided to the compiler but does not use variables modified from outside the source code.	Section 3.3.1
--gen_opt_info= <i>n</i>	-on <i>n</i>	Level 0 (-on0) disables the optimization information file. Level 1 (-on1) produces an optimization information file. Level 2 (-on2) produces a verbose optimization information file.	Section 3.2.1
--opt_for_speed=[<i>n</i>]	-mf	Controls the tradeoff between size and speed (0-5 range). If this option is specified without <i>n</i> , the default value is 4. If this option is not specified, the default setting is 2.	Section 3.12
--optimizer_interlist	-os	Interlists optimizer comments with assembly statements.	Section 3.9
--program_level_compile	-pm	Combines source files to perform program-level optimization.	Section 3.3
--aliased_variables	-ma	Notifies the compiler that addresses passed to functions may be modified by an alias in the called function.	Section 3.7.2.2

⁽¹⁾ **Note:** Machine-specific options (see [Table 2-11](#)) can also affect optimization.

Table 2-4. Debug Options

Option	Alias	Effect	Section
--symdebug:dwarf	-g	Default behavior. Enables symbolic debugging. The generation of debug information no longer impacts optimization. Therefore, generating debug information is enabled by default. If you explicitly use the -g option but do not specify an optimization level, no optimization is performed.	Section 2.3.5 Section 3.11
--symdebug:none		Disables all symbolic debugging.	Section 2.3.5 Section 3.11
--symdebug:profile_coff		Enables profiling using the alternate STABS debugging format.	Section 2.3.5
--symdebug:skeletal		(Deprecated; has no effect.)	

Table 2-5. Include Options

Option	Alias	Effect	Section
--include_path= <i>directory</i>	-I	Adds the specified directory to the #include search path.	Section 2.5.2.1
--preinclude= <i>filename</i>		Includes <i>filename</i> at the beginning of compilation.	Section 2.3.3

Table 2-6. Control Options

Option	Alias	Effect	Section
--compile_only	-c	Disables linking (negates --run_linker).	Section 4.1.3
--help	-h	Prints (on the standard output device) a description of the options understood by the compiler.	Section 2.3.2
--run_linker	-z	Causes the linker to be invoked from the compiler command line.	Section 2.3.2
--skip_assembler	-n	Compiles C/C++ source file, producing an assembly language output file. The assembler is not run and no object file is produced.	Section 2.3.2

Table 2-7. Language Options

Option	Alias	Effect	Section
--c89		Processes C files according to the ISO C89 standard.	Section 6.13
--c99		Processes C files according to the ISO C99 standard.	Section 6.13
--c++03		Processes C++ files according to the ISO C++03 standard.	Section 6.13
--cla_default		Processes both .c and .cla files as CLA files.	Section 10.1
--cpp_default	-fg	Processes all source files with a C extension as C++ source files.	Section 2.3.7
--exceptions		Enables C++ exception handling.	Section 6.6
--float_operations_allowed={none all 32 64}		Restricts the types of floating point operations allowed.	Section 2.3.3
--gen_cross_reference	-px	Generates a cross-reference listing file (.crl).	Section 2.9
--gen_preprocessor_listing	-pl	Generates a raw listing file (.rl).	Section 2.10
--relaxed_ansi	-pr	Enables relaxed mode; ignores strict ISO violations. This is on by default. To disable this mode, use the --strict_ansi option.	Section 6.13.2
--rtti	-rtti	Enables C++ run-time type information (RTTI).	--
--strict_ansi	-ps	Enables strict ANSI/ISO mode (for C/C++, not for K&R C). In this mode, language extensions that conflict with ANSI/ISO C/C++ are disabled. In strict ANSI/ISO mode, most ANSI/ISO violations are reported as errors. Violations that are considered discretionary may be reported as warnings instead.	Section 6.13.2

Table 2-8. Parser Preprocessing Options

Option	Alias	Effect	Section
--preproc_dependency[= <i>filename</i>]	-ppd	Performs preprocessing only, but instead of writing preprocessed output, writes a list of dependency lines suitable for input to a standard make utility.	Section 2.5.8
--preproc_includes[= <i>filename</i>]	-ppi	Performs preprocessing only, but instead of writing preprocessed output, writes a list of files included with the #include directive.	Section 2.5.9
--preproc_macros[= <i>filename</i>]	-ppm	Performs preprocessing only. Writes list of predefined and user-defined macros to a file with the same name as the input but with a .pp extension.	Section 2.5.10
--preproc_only	-ppo	Performs preprocessing only. Writes preprocessed output to a file with the same name as the input but with a .pp extension.	Section 2.5.4
--preproc_with_comment	-ppc	Performs preprocessing only. Writes preprocessed output, keeping the comments, to a file with the same name as the input but with a .pp extension.	Section 2.5.6
--preproc_with_compile	-ppa	Continues compilation after preprocessing with any of the -pp<x> options that normally disable compilation.	Section 2.5.5
--preproc_with_line	-ppl	Performs preprocessing only. Writes preprocessed output with line-control information (#line directives) to a file with the same name as the input but with a .pp extension.	Section 2.5.7

Table 2-9. Predefined Symbols Options

Option	Alias	Effect	Section
--define= <i>name</i> [= <i>def</i>]	-D	Predefines <i>name</i> .	Section 2.3.2
--undefine= <i>name</i>	-U	Undefines <i>name</i> .	Section 2.3.2

Table 2-10. Diagnostic Message Options

Option	Alias	Effect	Section
--advice:performance[= <i>all</i> , <i>none</i>]		Provides advice on ways to improve performance. Default is all.	Section 2.3.3
--compiler_revision		Prints out the compiler release revision and exits.	--
--diag_error= <i>num</i>	-pdse	Categorizes the diagnostic identified by <i>num</i> as an error.	Section 2.7.1
--diag_remark= <i>num</i>	-pdsr	Categorizes the diagnostic identified by <i>num</i> as a remark.	Section 2.7.1
--diag_suppress= <i>num</i>	-pds	Suppresses the diagnostic identified by <i>num</i> .	Section 2.7.1
--diag_warning= <i>num</i>	-pdsd	Categorizes the diagnostic identified by <i>num</i> as a warning.	Section 2.7.1
--diag_wrap={ <i>on</i> <i>off</i> }		Wrap diagnostic messages (default is on). Note that this command-line option cannot be used within the Code Composer Studio IDE.	
--display_error_number	-pden	Displays a diagnostic's identifiers along with its text. Note that this command-line option cannot be used within the Code Composer Studio IDE.	Section 2.7.1
--emit_warnings_as_errors	-pdew	Treat warnings as errors.	Section 2.7.1
--issue_remarks	-pdr	Issues remarks (non-serious warnings).	Section 2.7.1
--no_warnings	-pdw	Suppresses diagnostic warnings (errors are still issued).	Section 2.7.1
--quiet	-q	Suppresses progress messages (quiet).	--
--set_error_limit= <i>num</i>	-pdel	Sets the error limit to <i>num</i> . The compiler abandons compiling after this number of errors. (The default is 100.)	Section 2.7.1
--super_quiet	-qq	Super quiet mode.	--
--tool_version	-version	Displays version number for each tool.	--
--verbose		Display banner and function progress information.	--
--verbose_diagnostics	-pdv	Provides verbose diagnostic messages that display the original source with line-wrap. Note that this command-line option cannot be used within the Code Composer Studio IDE.	Section 2.7.1
--write_diagnostics_file	-pdf	Generates a diagnostic message information file. Compiler only option. Note that this command-line option cannot be used within the Code Composer Studio IDE.	Section 2.7.1

Table 2-11. Run-Time Model Options

Option	Alias	Effect	Section
--disable_dp_load_opt	-md	Disables DP load optimizations.	Section 2.3.4
--gen_data_subsections={on off}		Place all aggregate data (arrays, structs, and unions) into subsections. This gives the linker more control over removing unused data during the final link step. The default is on.	Section 4.2.2
--gen_func_subsections={on off}	-mo	Puts each function in a separate subsection in the object file.	Section 4.2.1
--no_rpt	-mi	Disables generation of RPT instructions.	Section 2.3.4
--printf_support={nofloat full minimal}		Enables support for smaller, limited versions of the printf function family (sprintf, fprintf, etc.) and the scanf function family (sscanf, fscanf, etc.) run-time-support functions.	Section 2.3.3
--protect_volatile	-mv	Enables volatile reference protection.	Section 2.3.4
--ramfunc={on off}		If set to on, specifies that all functions should be placed in the .TI.ramfunc section, which is placed in RAM.	Section 2.3.4
--rpt_threshold=k		Generates RPT loops that iterate <i>k</i> times or less. (<i>k</i> is a constant between 0 and 256.)	Section 2.3.4
--symdebug:dwarf_version=2 3 4		Specifies the DWARF format version.	Section 2.3.5

Table 2-12. Entry/Exit Hook Options

Option	Alias	Effect	Section
--entry_hook[= <i>name</i>]		Enables entry hooks.	Section 2.13
--entry_parm={none name address}		Specifies the parameters to the function to the --entry_hook option.	Section 2.13
--exit_hook[= <i>name</i>]		Enables exit hooks.	Section 2.13
--exit_parm={none name address}		Specifies the parameters to the function to the --exit_hook option.	Section 2.13
--remove_hooks_when_inlining		Removes entry/exit hooks for auto-inlined functions.	Section 2.13

Table 2-13. Feedback Options

Option	Alias	Effect	Section
--analyze={codecov callgraph}		Generate analysis info from profile data.	Section 3.6.2.2
--analyze_only		Only generate analysis.	Section 3.6.2.2
--gen_profile_info		Generates instrumentation code to collect profile information.	Section 3.5.1.3
--use_profile_info= <i>file1</i> [, <i>file2</i> ,...]		Specifies the profile information file(s).	Section 3.5.1.3

Table 2-14. Assembler Options

Option	Alias	Effect	Section
--keep_asm	-k	Keeps the assembly language (.asm) file.	Section 2.3.11
--asm_listing	-al	Generates an assembly listing file.	Section 2.3.11
--c_src_interlist	-ss	Interlists C source and assembly statements.	Section 2.12 Section 3.9
--src_interlist	-s	Interlists optimizer comments (if available) and assembly source statements; otherwise interlists C and assembly source statements.	Section 2.3.2
--absolute_listing	-aa	Enables absolute listing.	Section 2.3.11
--asm_define= <i>name</i> [= <i>def</i>]	-ad	Sets the <i>name</i> symbol.	Section 2.3.11
--asm_dependency	-apd	Performs preprocessing; lists only assembly dependencies.	Section 2.3.11
--asm_includes	-api	Performs preprocessing; lists only included #include files.	Section 2.3.11
--issue_remarks		Issues remarks (non-serious warnings), which include additional assembly-time checking.	Section 2.3.11
--asm_undefine= <i>name</i>	-au	Undefines the predefined constant <i>name</i> .	Section 2.3.11
--asm_listing_cross_reference	-ax	Generates the cross-reference file.	Section 2.3.11
--flash_prefetch_warn		Assembler warnings for F281X BF flash prefetch issue.	Section 2.3.11
--include_file= <i>filename</i>	-ahi	Includes the specified file for the assembly module.	Section 2.3.11
--preproc_asm	-mx	Preprocesses assembly source, expands assembly macros.	Section 2.3.11

Table 2-15. File Type Specifier Options

Option	Alias	Effect	Section
--asm_file= <i>filename</i>	-fa	Identifies <i>filename</i> as an assembly source file regardless of its extension. By default, the compiler and assembler treat .asm files as assembly source files.	Section 2.3.7
--c_file= <i>filename</i>	-fc	Identifies <i>filename</i> as a C source file regardless of its extension. By default, the compiler treats .c files as C source files.	Section 2.3.7
--cpp_file= <i>filename</i>	-fp	Identifies <i>filename</i> as a C++ file, regardless of its extension. By default, the compiler treats .C, .cpp, .cc and .cxx files as a C++ files.	Section 2.3.7
--obj_file= <i>filename</i>	-fo	Identifies <i>filename</i> as an object code file regardless of its extension. By default, the compiler and linker treat .obj files as object code files.	Section 2.3.7

Table 2-16. Directory Specifier Options

Option	Alias	Effect	Section
--abs_directory= <i>directory</i>	-fb	Specifies an absolute listing file directory. By default, the compiler uses the .obj directory.	Section 2.3.10
--asm_directory= <i>directory</i>	-fs	Specifies an assembly file directory. By default, the compiler uses the current directory.	Section 2.3.10
--list_directory= <i>directory</i>	-ff	Specifies an assembly listing file and cross-reference listing file directory. By default, the compiler uses the .obj directory.	Section 2.3.10
--obj_directory= <i>directory</i>	-fr	Specifies an object file directory. By default, the compiler uses the current directory.	Section 2.3.10
--output_file= <i>filename</i>	-fe	Specifies a compilation output file name; can override --obj_directory.	Section 2.3.10
--pp_directory= <i>dir</i>		Specifies a preprocessor file directory. By default, the compiler uses the current directory.	Section 2.3.10
--temp_directory= <i>directory</i>	-ft	Specifies a temporary file directory. By default, the compiler uses the current directory.	Section 2.3.10

Table 2-17. Default File Extensions Options

Option	Alias	Effect	Section
--asm_extension=[.] <i>extension</i>	-ea	Sets a default extension for assembly source files.	Section 2.3.9
--c_extension=[.] <i>extension</i>	-ec	Sets a default extension for C source files.	Section 2.3.9
--cpp_extension=[.] <i>extension</i>	-ep	Sets a default extension for C++ source files.	Section 2.3.9
--listing_extension=[.] <i>extension</i>	-es	Sets a default extension for listing files.	Section 2.3.9
--obj_extension=[.] <i>extension</i>	-eo	Sets a default extension for object files.	Section 2.3.9

Table 2-18. Command Files Options

Option	Alias	Effect	Section
--cmd_file= <i>filename</i>	-@	Interprets contents of a file as an extension to the command line. Multiple -@ instances can be used.	Section 2.3.2

Table 2-19. MISRA-C 2004 Options

Option	Alias	Effect	Section
--check_misra={all required advisory none <i>rulespec</i> }		Enables checking of the specified MISRA-C:2004 rules. Default is all.	Section 2.3.3
--misra_advisory={error warning remark suppress}		Sets the diagnostic severity for advisory MISRA-C:2004 rules.	Section 2.3.3
--misra_required={error warning remark suppress}		Sets the diagnostic severity for required MISRA-C:2004 rules.	Section 2.3.3

2.3.1 Linker Options

The following tables list the linker options. See [Chapter 4](#) of this document and the *TMS320C28x Assembly Language Tools User's Guide* for details on these options.

Table 2-20. Linker Basic Options

Option	Alias	Description
--run_linker	-z	Enables linking.
--output_file= <i>file</i>	-o	Names the executable output file. The default filename is a .out file.
--map_file= <i>file</i>	-m	Produces a map or listing of the input and output sections, including holes, and places the listing in <i>file</i> .
--stack_size= <i>size</i>	[-]-stack	Sets C system stack size to <i>size</i> words and defines a global symbol that specifies the stack size. Default = 1K words.
--heap_size= <i>size</i>	[-]-heap	Sets heap size (for the dynamic memory allocation in C) to <i>size</i> words and defines a global symbol that specifies the heap size. Default = 1K words.
--warn_sections	-w	Displays a message when an undefined output section is created.

Table 2-21. File Search Path Options

Option	Alias	Description
--library= <i>file</i>	-l	Names an archive library or link command <i>file</i> as linker input.
--search_path= <i>pathname</i>	-I	Alters library-search algorithms to look in a directory named with <i>pathname</i> before looking in the default location. This option must appear before the --library option.
--priority	-priority	Satisfies unresolved references by the first library that contains a definition for that symbol.
--reread_libs	-x	Forces rereading of libraries, which resolves back references.
--disable_auto_rts		Disables the automatic selection of a run-time-support library. See Section 4.3.1.1 .

Table 2-22. Command File Preprocessing Options

Option	Alias	Description
--define= <i>name=value</i>		Predefines <i>name</i> as a preprocessor macro.
--undefine= <i>name</i>		Removes the preprocessor macro <i>name</i> .
--disable_pp		Disables preprocessing for command files.

Table 2-23. Diagnostic Message Options

Option	Alias	Description
--diag_error= <i>num</i>		Categorizes the diagnostic identified by <i>num</i> as an error.
--diag_remark= <i>num</i>		Categorizes the diagnostic identified by <i>num</i> as a remark.
--diag_suppress= <i>num</i>		Suppresses the diagnostic identified by <i>num</i> .
--diag_warning= <i>num</i>		Categorizes the diagnostic identified by <i>num</i> as a warning.
--display_error_number		Displays a diagnostic's identifiers along with its text.
--emit_warnings_as_errors	-pdew	Treat warnings as errors.
--issue_remarks		Issues remarks (non-serious warnings).
--no_demangle		Disables demangling of symbol names in diagnostic messages.
--no_warnings		Suppresses diagnostic warnings (errors are still issued).
--set_error_limit= <i>count</i>		Sets the error limit to <i>count</i> . The linker abandons linking after this number of errors. (The default is 100.)
--verbose_diagnostics		Provides verbose diagnostic messages that display the original source with line-wrap.

Table 2-24. Linker Output Options

Option	Alias	Description
--absolute_exe	-a	Produces an absolute, executable object file. This is the default; if neither --absolute_exe nor --relocatable is specified, the linker acts as if --absolute_exe were specified.
--ecc:data_error		Inject specified errors into the output file for testing.
--ecc:ecc_error		Inject specified errors into the Error Correcting Code (ECC) for testing.
--mapfile_contents= <i>attribute</i>		Controls the information that appears in the map file.
--relocatable	-r	Produces a nonexecutable, relocatable output object file.
--rom		Creates a ROM object.
--run_abs	-abs	Produces an absolute listing file.
--xml_link_info= <i>file</i>		Generates a well-formed XML <i>file</i> containing detailed information about the result of a link.

Table 2-25. Symbol Management Options

Option	Alias	Description
--entry_point= <i>symbol</i>	-e	Defines a global symbol that specifies the primary entry point for the executable object file.
--globalize= <i>pattern</i>		Changes the symbol linkage to global for symbols that match <i>pattern</i> .
--hide= <i>pattern</i>		Hides symbols that match the specified <i>pattern</i> .
--localize= <i>pattern</i>		Make the symbols that match the specified <i>pattern</i> local.
--make_global= <i>symbol</i>	-g	Makes <i>symbol</i> global (overrides -h).
--make_static	-h	Makes all global symbols static.
--no_sym_merge	-b	Disables merge of symbolic debugging information in COFF object files.
--no_syntable	-s	Strips symbol table information and line number entries from the executable object file.
--scan_libraries	-scanlibs	Scans all libraries for duplicate symbol definitions.
--symbol_map= <i>refname=defname</i>		Specifies a symbol mapping; references to the <i>refname</i> symbol are replaced with references to the <i>defname</i> symbol. The --symbol_map option is now supported when used with --opt_level=4.
--undef_sym= <i>symbol</i>	-u	Adds <i>symbol</i> to the symbol table as an unresolved symbol.
--unhide= <i>pattern</i>		Excludes symbols that match the specified <i>pattern</i> from being hidden.

Table 2-26. Run-Time Environment Options

Option	Alias	Description
--arg_size= <i>size</i>	--args	Reserve <i>size</i> bytes for the argc/argv memory area.
--fill_value= <i>value</i>	-f	Sets default fill value for holes within output sections
--ram_model	-cr	Initializes variables at load time.
--rom_model	-c	Autoinitializes variables at run time.

Table 2-27. Link-Time Optimization Options⁽¹⁾

Option	Alias	Description
--keep_asm		Retain any post-link files (.pl) and .absolute listing files (.abs) generated by the -plink option. This allows you to view any changes the post-link optimizer makes. (Requires use of -plink)
--no_postlink_across_calls	-nf	Disable post-link optimizations across functions. (Requires use of -plink)
--plink_advice_only		Annotates assembly code with comments if changes cannot be made safely due to pipeline considerations, such as when float support or VCU support is enabled. (Requires use of -plink)
--postlink_exclude	-ex	Exclude files from post-link pass. (Requires use of -plink)
--postlink_opt	-plink	Post-link optimizations (only after -z).

⁽¹⁾ See [Chapter 5](#) for details.

Table 2-28. Miscellaneous Options

Option	Alias	Description
<code>--disable_clink</code>	<code>-j</code>	Disables conditional linking of COFF object files.
<code>--linker_help</code>	<code>[-]help</code>	Displays information about syntax and available options.
<code>--preferred_order=function</code>		Prioritizes placement of functions.
<code>--strict_compatibility[=off on]</code>		Performs more conservative and rigorous compatibility checking of input object files. Default is on.

2.3.2 Frequently Used Options

Following are detailed descriptions of options that you will probably use frequently:

<code>--c_src_interlist</code>	Invokes the interlist feature, which interweaves original C/C++ source with compiler-generated assembly language. The interlisted C statements may appear to be out of sequence. You can use the interlist feature with the optimizer by combining the <code>--optimizer_interlist</code> and <code>--c_src_interlist</code> options. See Section 3.9 . The <code>--c_src_interlist</code> option can have a negative performance and/or code size impact.
<code>--cmd_file=filename</code>	Appends the contents of a file to the option set. You can use this option to avoid limitations on command line length or C style comments imposed by the host operating system. Use a <code>#</code> or <code>;</code> at the beginning of a line in the command file to include comments. You can also include comments by delimiting them with <code>/*</code> and <code>*/</code> . To specify options, surround hyphens with quotation marks. For example, <code>--"quiet</code> . You can use the <code>--cmd_file</code> option multiple times to specify multiple files. For instance, the following indicates that <code>file3</code> should be compiled as source and <code>file1</code> and <code>file2</code> are <code>--cmd_file</code> files: <code>cl2000 --cmd_file=file1 --cmd_file=file2 file3</code>
<code>--compile_only</code>	Suppresses the linker and overrides the <code>--run_linker</code> option, which specifies linking. The <code>--compile_only</code> option's short form is <code>-c</code> . Use this option when you have <code>--run_linker</code> specified in the <code>C2000_C_OPTION</code> environment variable and you do not want to link. See Section 4.1.3 .
<code>--define=name[=def]</code>	Predefines the constant <i>name</i> for the preprocessor. This is equivalent to inserting <code>#define name def</code> at the top of each C source file. If the optional <code>[=def]</code> is omitted, the <i>name</i> is set to 1. The <code>--define</code> option's short form is <code>-D</code> . If you want to define a quoted string and keep the quotation marks, do one of the following: <ul style="list-style-type: none"> • For Windows, use <code>--define=name="string def"</code>. For example, <code>--define=car="sedan"</code> • For UNIX, use <code>--define=name="string def"</code>. For example, <code>--define=car="sedan"</code> • For Code Composer Studio, enter the definition in a file and include that file with the <code>--cmd_file</code> option.
<code>--help</code>	Displays the syntax for invoking the compiler and lists available options. If the <code>--help</code> option is followed by another option or phrase, detailed information about the option or phrase is displayed. For example, to see information about debugging options use <code>--help debug</code> .
<code>--include_path=directory</code>	Adds <i>directory</i> to the list of directories that the compiler searches for <code>#include</code> files. The <code>--include_path</code> option's short form is <code>-I</code> . You can use this option several times to define several directories; be sure to separate the <code>--include_path</code> options with spaces. If you do not specify a directory name, the preprocessor ignores the <code>--include_path</code> option. See Section 2.5.2.1 .

--keep_asm	Retains the assembly language output from the compiler or assembly optimizer. Normally, the compiler deletes the output assembly language file after assembly is complete. The <code>--keep_asm</code> option's short form is <code>-k</code> .
--quiet	Suppresses banners and progress information from all the tools. Only source filenames and error messages are output. The <code>--quiet</code> option's short form is <code>-q</code> .
--run_linker	Runs the linker on the specified object files. The <code>--run_linker</code> option and its parameters follow all other options on the command line. All arguments that follow <code>--run_linker</code> are passed to the linker. The <code>--run_linker</code> option's short form is <code>-z</code> . See Section 4.1 .
--skip_assembler	Compiles only. The specified source files are compiled but not assembled or linked. The <code>--skip_assembler</code> option's short form is <code>-n</code> . This option overrides <code>--run_linker</code> . The output is assembly language output from the compiler.
--src_interlist	Invokes the interlist feature, which interweaves optimizer comments or C/C++ source with assembly source. If the optimizer is invoked (<code>--opt_level=<i>n</i></code> option), optimizer comments are interlisted with the assembly language output of the compiler, which may rearrange code significantly. If the optimizer is not invoked, C/C++ source statements are interlisted with the assembly language output of the compiler, which allows you to inspect the code generated for each C/C++ statement. The <code>--src_interlist</code> option implies the <code>--keep_asm</code> option. The <code>--src_interlist</code> option's short form is <code>-s</code> .
--tool_version	Prints the version number for each tool in the compiler. No compiling occurs.
--undefine=<i>name</i>	Undefines the predefined constant <i>name</i> . This option overrides any <code>--define</code> options for the specified constant. The <code>--undefine</code> option's short form is <code>-U</code> .
--verbose	Displays progress information and toolset version while compiling. Resets the <code>--quiet</code> option.

2.3.3 Miscellaneous Useful Options

Following are detailed descriptions of miscellaneous options:

--advice:performance[=<i>all none</i>]	When Trigonometric Math Unit (TMU) support is enabled (<code>--tmu_support</code>) and <code>--fp_mode=strict</code> , advice will be generated if the compiler encounters function calls that could be replaced with TMU hardware instructions under <code>--fp_mode=relaxed</code> . These include floating point division, <code>sqrt</code> , <code>sin</code> , <code>cos</code> , <code>atan</code> , and <code>atan2</code> .
--check_misra={<i>all required advisory none rulespec</i>}	Displays the specified amount or type of MISRA-C documentation. This option must be used if you want to enable use of the <code>CHECK_MISRA</code> and <code>RESET_MISRA</code> pragmas within the source code. The <i>rulespec</i> parameter is a comma-separated list of specifiers. See Section 6.3 for details.
--float_operations_allowed={<i>none all 32 64</i>}	Restricts the type of floating point operations allowed in the application. The default is <code>all</code> . If set to <code>none</code> , <code>32</code> , or <code>64</code> , the application is checked for operations that will be performed at runtime. For example, if <code>--float_operations_allowed=32</code> is specified on the command line, the compiler issues an error if a double precision operation will be generated. This can be used to ensure that double precision operations are not accidentally introduced into an application. The checks are performed after relaxed mode optimizations have been performed, so illegal operations that are completely removed result in no diagnostic messages.

--fp_mode ={relaxed strict}	<p>The default floating-point mode is strict. To enable relaxed floating-point mode use the <code>--fp_mode=relaxed</code> option. Relaxed floating-point mode causes double-precision floating-point computations and storage to be converted to integers where possible. This behavior does not conform with ISO, but it results in faster code, with some loss in accuracy. The following specific changes occur in relaxed mode:</p> <ul style="list-style-type: none"> • Division by a constant is converted to inverse multiplication. • Certain C standard float functions--such as <code>sqrt</code>, <code>sin</code>, <code>cos</code>, <code>atan</code>, and <code>atan2</code>--are redirected to optimized inline functions where possible. • If the <code>--tmu_support</code> option is used to enable support for the Trigonometric Math Unit (TMU) and relaxed floating-point mode is enabled, RTS library calls are replaced with the corresponding TMU hardware instructions for the following floating-point operations: floating point division, <code>sqrt</code>, <code>sin</code>, <code>cos</code>, <code>atan</code>, and <code>atan2</code>. Note that there are algorithmic differences between the TMU hardware instructions and the library routines, so the results of operations may differ slightly.
--fp_reassoc ={on off}	<p>Enables or disables the reassociation of floating-point arithmetic. The default value is <code>--fp_reassoc=on</code>.</p> <p>Because floating-point values are of limited precision, and because floating-point operations round, floating-point arithmetic is neither associative nor distributive. For instance, $(1 + 3e100) - 3e100$ is not equal to $1 + (3e100 - 3e100)$. If strictly following IEEE 754, the compiler cannot, in general, reassociate floating-point operations. Using <code>--fp_reassoc=on</code> allows the compiler to perform the algebraic reassociation, at the cost of a small amount of precision for some operations.</p> <p>When <code>--fp_reassoc=on</code>, RPT MACF32 instructions may be generated. Because the RPT MACF32 instruction computes two partial sums and adds them together afterward to compute the entire accumulation, the result can vary in precision from a serial floating-point multiply accumulate loop.</p>
--misra_advisory ={error warning remark suppress}	Sets the diagnostic severity for advisory MISRA-C:2004 rules.
--misra_required ={error warning remark suppress}	Sets the diagnostic severity for required MISRA-C:2004 rules.
--preinclude = <i>filename</i>	Includes the source code of <i>filename</i> at the beginning of the compilation. This can be used to establish standard macro definitions. The filename is searched for in the directories on the include search list. The files are processed in the order in which they were specified.
--printf_support ={full nofloat minimal}	<p>Enables support for smaller, limited versions of the <code>printf</code> function family (<code>sprintf</code>, <code>fprintf</code>, etc.) and the <code>scanf</code> function family (<code>sscanf</code>, <code>fscanf</code>, etc.) run-time-support functions. The valid values are:</p> <ul style="list-style-type: none"> • <code>full</code>: Supports all format specifiers. This is the default. • <code>nofloat</code>: Excludes support for printing and scanning floating-point values. Supports all format specifiers except <code>%a</code>, <code>%A</code>, <code>%f</code>, <code>%F</code>, <code>%g</code>, <code>%G</code>, <code>%e</code>, and <code>%E</code>. • <code>minimal</code>: Supports the printing and scanning of integer, char, or string values without width or precision flags. Specifically, only the <code>%%</code>, <code>%d</code>, <code>%o</code>, <code>%c</code>, <code>%s</code>, and <code>%x</code> format specifiers are supported <p>There is no run-time error checking to detect if a format specifier is used for which support is not included. The <code>--printf_support</code> option precedes the <code>--run_linker</code> option, and must be used when performing the final link.</p>
--sat_reassoc ={on off}	Enables or disables the reassociation of saturating arithmetic.

2.3.4 Run-Time Model Options

These options are specific to the TMS320C28x toolset. See the referenced sections for more information. TMS320C28x-specific assembler options are listed in [Section 2.3.11](#).

--cla_support ={cla0 cla1 cla2}	Specifies TMS320C28x Control Law Accelerator (CLA) Type 0, Type 1, or Type 2 support. This option is used to compile or assemble code written for the CLA. This option does not require any special library support when linking; the libraries used for C28x with/without FPU support should be sufficient.
--disable_dp_load_opt	Disables the compiler from optimizing redundant loads of the DP register when using DP direct addressing. See Section 3.10 for more about when to use this option to disable data page blocking.
--float_support ={fpu32}	Specifies use of TMS320C28x 32-bit hardware floating-point support. Using --float_support=fpu32 specifies the C28x architecture with 32-bit hardware floating-point support. If the --tmu_support option is used to enable support for the Trigonometric Math Unit, the --float_support option is automatically set to fpu32 .
--no_rpt	Prevents the compiler from generating repeat (RPT) instructions. By default, repeat instructions are generated for certain memcopy, division, and multiply-accumulate operations. However, repeat instructions are not interruptible.
--protect_volatile = <i>num</i>	Enables volatile reference protection. Pipeline conflicts may occur between non-local variables that have been declared volatile. A conflict can occur between a write to one volatile variable that is followed by a read from a different volatile variable. The --protect_volatile option allows at least <i>num</i> instructions to be placed between the two volatile references to ensure the write occurs before the read. The <i>num</i> is optional. If no <i>num</i> is given, the default value is 2. For example, if --protect_volatile=4 is used, volatile writes and volatile reads are protected by at least 4 instructions. The peripheral pipeline protection hardware protects all internal peripherals and XINTF zone 1. If you connect peripherals to Xintf zone 0, 2, 6, 7 then you may need to use the --protect_volatile option. Hardware protection or using this option is not required for memories.
--ramfunc ={on off}	If set to on, specifies that all functions should be placed in the .TI.ramfunc section, which is placed in RAM. If set to off, only functions with the ramfunc function attribute are treated this way. See Section 6.14.2 . Newer TI linker command files support the --ramfunc option automatically by placing functions in the .TI.ramfunc section. If you have a linker command file that does not include a section specification for the .TI.ramfunc section, you can modify the linker command file to place this section in RAM. See the <i>TMS320C28x Assembly Language Tools User's Guide</i> for details on section placement. Projects or files that were previously compiled without the --no_fast_branch option should use the --ramfunc=on option instead to generate fast branch instructions for all functions.
--rpt_threshold = <i>k</i>	Generates RPT loops that iterate <i>k</i> times or less (<i>k</i> is a constant between 0 and 256). Multiple RPT's may be generated for the same loop, if iteration count is more than <i>k</i> and if code size does not increase too much. Using this option when optimizing for code size disables RPT loop generation for loops whose iteration count can be greater than <i>k</i> .
--silicon_version =28	Generates code for the TMS320C28x architecture. The only value accepted is 28. This is the default, so this option is no longer required on command lines.

--unified_memory	Use the <code>--unified_memory</code> (<code>-mt</code>) option if your memory map is configured as a single unified space; this allows the compiler to generate RPT PREAD instructions for most memcopy calls and structure assignments. This also allows MAC instructions to be generated. The <code>--unified_memory</code> option also allows more efficient data memory instructions to be used to access switch tables. Even under unified memory, memory for some peripherals and some RAM associated with those peripherals is allocated only in data memory. If <code>--unified_memory</code> is enabled, you can prevent program memory address access to specific symbols by declaring those symbols as volatile.
--tmu_support[=tmu0]	Enables support for the Trigonometric Math Unit (TMU). Using this option automatically enables FPU32 support (as with the <code>--float_support=fpu32</code> option). When TMU support is enabled, intrinsics are available to perform trigonometric instructions on the TMU. In addition, in relaxed floating point mode, RTS library calls are replaced with the corresponding TMU hardware instructions for the following floating-point operations: floating point division, <code>sqrt</code> , <code>sin</code> , <code>cos</code> , <code>atan</code> , and <code>atan2</code> . Note that there are algorithmic differences between the TMU hardware instructions and the library routines, so the results of operations may differ slightly.
--vcu_support[=vcu0 vcu2]	Specifies support for Type 0 or Type 2 of the Viterbi, Complex Math and CRC Unit (VCU). This option is useful only if the source is in assembly code, written for the VCU. The option is ignored for C/C++ code. This option does not need any special library support when linking; the libraries used for C28x with/without VCU support should be sufficient. Also note that there is no VCU Type 1.

2.3.5 Symbolic Debugging and Profiling Options

The following options are used to select symbolic debugging or profiling:

--symdebug:dwarf	(Default) Generates directives that are used by the C/C++ source-level debugger and enables assembly source debugging in the assembler. The <code>--symdebug:dwarf</code> option's short form is <code>-g</code> . See Section 3.11 . For more information on the DWARF debug format, see <i>The DWARF Debugging Standard</i> .
--symdebug:dwarf_version={2 3 4}	Specifies the DWARF debugging format version (2, 3, or 4) to be generated when <code>--symdebug:dwarf</code> (the default) is specified. By default, the compiler generates DWARF version 3 debug information. DWARF versions 2, 3, and 4 may be intermixed safely. When DWARF 4 is used, type information is placed in the <code>.debug_types</code> section. At link time, duplicate type information will be removed. This method of type merging is superior to those used in DWARF 2 or 3 and will result in a smaller executable. In addition, DWARF 4 reduces the size of intermediate object files in comparison to DWARF 3. For more information on TI extensions to the DWARF language, see <i>The Impact of DWARF on TI Object Files</i> (SPRAAB5).
--symdebug:none	Disables all symbolic debugging output. This option is not recommended; it prevents debugging and most performance analysis capabilities.
--symdebug:profile_coff	Adds the necessary debug directives to the object file which are needed by the profiler to allow function level profiling with minimal impact on optimization (when used). This option does not hinder optimization. You can set breakpoints and profile on function-level boundaries in Code Composer Studio, but you cannot single-step through code as with full debug ability.
--symdebug:skeletal	Deprecated. Has no effect.

2.3.6 Specifying Filenames

The input files that you specify on the command line can be C source files, C++ source files, assembly source files, or object files. The compiler uses filename extensions to determine the file type.

Extension	File Type
.asm, .abs, or .s* (extension begins with s)	Assembly source
.c	C source
.C	Depends on operating system
.cpp, .cxx, .cc	C++ source
.obj .o* .dll .so	Object

NOTE: Case Sensitivity in Filename Extensions

Case sensitivity in filename extensions is determined by your operating system. If your operating system is not case sensitive, a file with a .C extension is interpreted as a C file. If your operating system is case sensitive, a file with a .C extension is interpreted as a C++ file.

For information about how you can alter the way that the compiler interprets individual filenames, see [Section 2.3.7](#). For information about how you can alter the way that the compiler interprets and names the extensions of assembly source and object files, see [Section 2.3.10](#).

You can use wildcard characters to compile or assemble multiple files. Wildcard specifications vary by system; use the appropriate form listed in your operating system manual. For example, to compile all of the files in a directory with the extension .cpp, enter the following:

```
c12000 *.cpp
```

NOTE: No Default Extension for Source Files is Assumed

If you list a filename called example on the command line, the compiler assumes that the entire filename is example not example.c. No default extensions are added onto files that do not contain an extension.

2.3.7 Changing How the Compiler Interprets Filenames

You can use options to change how the compiler interprets your filenames. If the extensions that you use are different from those recognized by the compiler, you can use the filename options to specify the type of file. You can insert an optional space between the option and the filename. Select the appropriate option for the type of file you want to specify:

```
--asm_file=filename    for an assembly language source file
--c_file=filename       for a C source file
--cpp_file=filename     for a C++ source file
--obj_file=filename     for an object file
```

For example, if you have a C source file called file.s and an assembly language source file called assy, use the --asm_file and --c_file options to force the correct interpretation:

```
c12000 --c_file=file.s --asm_file=assy
```

You cannot use the filename options with wildcard specifications.

2.3.8 Changing How the Compiler Processes C Files

The --cpp_default option causes the compiler to process C files as C++ files. By default, the compiler treats files with a .c extension as C files. See [Section 2.3.9](#) for more information about filename extension conventions.

2.3.9 Changing How the Compiler Interprets and Names Extensions

You can use options to change how the compiler program interprets filename extensions and names the extensions of the files that it creates. The filename extension options must precede the filenames they apply to on the command line. You can use wildcard specifications with these options. An extension can be up to nine characters in length. Select the appropriate option for the type of extension you want to specify:

--asm_extension=new extension	for an assembly language file
--c_extension=new extension	for a C source file
--cpp_extension=new extension	for a C++ source file
--listing_extension=new extension	sets default extension for listing files
--obj_extension=new extension	for an object file

The following example assembles the file `fit.rrr` and creates an object file named `fit.o`:

```
cl2000 --asm_extension=.rrr --obj_extension=.o fit.rrr
```

The period (`.`) in the extension is optional. You can also write the example above as:

```
cl2000 --asm_extension=rrr --obj_extension=o fit.rrr
```

2.3.10 Specifying Directories

By default, the compiler program places the object, assembly, and temporary files that it creates into the current directory. If you want the compiler program to place these files in different directories, use the following options:

--abs_directory=directory	Specifies the destination directory for absolute listing files. The default is to use the same directory as the object file directory. For example: cl2000 --abs_directory=d:\abso_list
--asm_directory=directory	Specifies a directory for assembly files. For example: cl2000 --asm_directory=d:\assembly
--list_directory=directory	Specifies the destination directory for assembly listing files and cross-reference listing files. The default is to use the same directory as the object file directory. For example: cl2000 --list_directory=d:\listing
--obj_directory=directory	Specifies a directory for object files. For example: cl2000 --obj_directory=d:\object
--output_file=filename	Specifies a compilation output file name; can override <code>--obj_directory</code> . For example: cl2000 --output_file=transfer
--pp_directory=directory	Specifies a preprocessor file directory for object files (default is <code>.</code>). For example: cl2000 --pp_directory=d:\preproc
--temp_directory=directory	Specifies a directory for temporary intermediate files. For example: cl2000 --temp_directory=d:\temp

2.3.11 Assembler Options

Following are assembler options that you can use with the compiler. For more information, see the *TMS320C28x Assembly Language Tools User's Guide*.

--absolute_listing	Generates a listing with absolute addresses rather than section-relative offsets.
--asm_define=name[=def]	<p>Predefines the constant <i>name</i> for the assembler; produces a <code>.set</code> directive for a constant or an <code>.arg</code> directive for a string. If the optional <code>[=def]</code> is omitted, the <i>name</i> is set to 1. If you want to define a quoted string and keep the quotation marks, do one of the following:</p> <ul style="list-style-type: none"> • For Windows, use <code>--asm_define=name="\string def"</code>. For example: <code>--asm_define=car="\sedan\ "</code> • For UNIX, use <code>--asm_define=name="string def"</code>. For example: <code>--asm_define=car=' "sedan" '</code> • For Code Composer Studio, enter the definition in a file and include that file with the <code>--cmd_file</code> option.
--asm_dependency	Performs preprocessing for assembly files, but instead of writing preprocessed output, writes a list of dependency lines suitable for input to a standard make utility. The list is written to a file with the same name as the source file but with a <code>.ppa</code> extension.
--asm_includes	Performs preprocessing for assembly files, but instead of writing preprocessed output, writes a list of files included with the <code>#include</code> directive. The list is written to a file with the same name as the source file but with a <code>.ppa</code> extension.
--asm_listing	Produces an assembly listing file.
--issue_remarks	Issues remarks (non-serious warnings). For the assembler, enables additional assembly-time checking. A remark is generated if an <code>.ebss</code> allocation size is greater than 64 words, or if a 16-bit immediate operand value resides outside of the -32 768 to 65 535 range.
--asm_undefine=name	Undefines the predefined constant <i>name</i> . This option overrides any <code>--asm_define</code> options for the specified name.
--asm_listing_cross_reference	Produces a symbolic cross-reference in the listing file.
--flash_prefetch_warn	Enables assembler warnings if a program data access instruction follows within 8 words of a BF or SBF instruction. As outlined in the TMS320C281X/TMS320F281X DSP Silicon Errata (SPRZ193) advisory on the "Flash and OTP Prefetch Buffer Overflow", the flash prefetch buffer may overflow if this instruction sequence is executed from flash or One-Time-Programmable (OTP) memory with the flash prefetch buffer enabled. Whether or not an overflow actually occurs depends on the instruction sequence, flash wait states, and CPU pipeline stalls. If an overflow occurs, it will result in execution of invalid opcodes. Instructions that use program memory addressing include MAC/XMAC, DMAC/XMACD, QMACL, IMACL, PREAD/XPREAD, and PWRITE/XPWRITE.
--include_file=filename	Includes the specified file for the assembly module; acts like an <code>.include</code> directive. The file is included before source file statements. The included file does not appear in the assembly listing files.
--preproc_asm	Expands macros in an assembly file and assembles the expanded file. Expanding macros helps you to debug the assembly file. The <code>--preproc_asm</code> option affects only the assembly file. When <code>--preproc_asm</code> is used, the compiler first invokes the assembler to generate the macro-expanded source <code>.exp</code> file. Then the <code>.exp</code> file is assembled to generate the object file. The debugger uses the <code>.exp</code> file for debugging. The <code>.exp</code> file is an intermediate file and any update to this file will be lost. You need to make any updates to the original assembly file.

2.3.12 Dynamic Linking

The C28x v?.? Code Generation Tools (CGT) support dynamic linking. For details on dynamic linking with the C28x CGT, see the *TMS320C28x Assembly Language Tools User's Guide*.

Table 2-29 provides a brief summary of the linker options that are related to support for the Dynamic Linking Model in the C28x CGT.

Table 2-29. Linker Options For Dynamic Linking

Option	Description
<code>--dynamic[=exe]</code>	Specifies that the result of a link will be a lightweight dynamic executable.
<code>--dynamic=lib</code>	Specifies that the result of a link will be a dynamic library.
<code>--export=symbol</code>	Specifies that <i>symbol</i> is exported by the ELF object that is generated for this link.
<code>--fini=symbol</code>	Specifies the <i>symbol</i> name of the termination code for the output file currently being linked.
<code>--import=symbol</code>	Specifies that <i>symbol</i> is imported by the ELF object that is generated for this link.
<code>--init=symbol</code>	Specifies the <i>symbol</i> name of the initialization code for the output file currently being linked.
<code>--rpath=dir</code>	Adds a directory to the beginning of the dynamic library search path.
<code>--runpath=dir</code>	Adds a directory to the end of the dynamic library search path.
<code>--soname=string</code>	Specifies shared object name to be used to identify this ELF object to the any downstream ELF object consumers.

2.3.13 Deprecated Options

Several compiler options have been deprecated, removed, or renamed. The compiler continues to accept some of the deprecated options, but they are not recommended for use. See the [Compiler Option Cleanup wiki page](#) for a list of deprecated and removed options, options that have been removed from CCS, and options that have been renamed.

2.4 Controlling the Compiler Through Environment Variables

An environment variable is a system symbol that you define and assign a string to. Setting environment variables is useful when you want to run the compiler repeatedly without re-entering options, input filenames, or pathnames.

NOTE: **C_OPTION** and **C_DIR** -- The **C_OPTION** and **C_DIR** environment variables are deprecated. Use device-specific environment variables instead.

2.4.1 Setting Default Compiler Options (C2000_C_OPTION)

You might find it useful to set the compiler, assembler, and linker default options using the **C2000_C_OPTION** environment variable. If you do this, the compiler uses the default options and/or input filenames that you name **C2000_C_OPTION** every time you run the compiler.

Setting the default options with these environment variables is useful when you want to run the compiler repeatedly with the same set of options and/or input files. After the compiler reads the command line and the input filenames, it looks for the **C2000_C_OPTION** environment variable and processes it.

The table below shows how to set the **C2000_C_OPTION** environment variable. Select the command for your operating system:

Operating System	Enter
UNIX (Bourne shell)	C2000_C_OPTION =" option ₁ [option ₂ . . .]"; export C2000_C_OPTION
Windows	set C2000_C_OPTION = option ₁ [option ₂ . . .]

Environment variable options are specified in the same way and have the same meaning as they do on the command line. For example, if you want to always run quietly (the **--quiet** option), enable C/C++ source interlisting (the **--src_interlist** option), and link (the **--run_linker** option) for Windows, set up the **C2000_C_OPTION** environment variable as follows:

```
set C2000_C_OPTION=--quiet --src_interlist --run_linker
```

In the following examples, each time you run the compiler, it runs the linker. Any options following **--run_linker** on the command line or in **C2000_C_OPTION** are passed to the linker. Thus, you can use the **C2000_C_OPTION** environment variable to specify default compiler and linker options and then specify additional compiler and linker options on the command line. If you have set **--run_linker** in the environment variable and want to compile only, use the compiler **--compile_only** option. These additional examples assume **C2000_C_OPTION** is set as shown above:

```
cl2000 *c ; compiles and links
cl2000 --compile_only *.c ; only compiles
cl2000 *.c --run_linker lnk.cmd ; compiles and links using a command file
cl2000 --compile_only *.c --run_linker lnk.cmd
; only compiles (--compile_only overrides --run_linker)
```

For details on compiler options, see [Section 2.3](#). For details on linker options, see the *Linker Description* chapter in the *TMS320C28x Assembly Language Tools User's Guide*.

2.4.2 Naming One or More Alternate Directories (C2000_C_DIR)

The linker uses the C2000_C_DIR environment variable to name alternate directories that contain object libraries. The command syntaxes for assigning the environment variable are:

Operating System	Enter
UNIX (Bourne shell)	C2000_C_DIR=" <i>pathname₁</i> ; <i>pathname₂</i> ;..."; export C2000_C_DIR
Windows	set C2000_C_DIR= <i>pathname₁</i> ; <i>pathname₂</i> ;...

The *pathnames* are directories that contain input files. The pathnames must follow these constraints:

- Pathnames must be separated with a semicolon.
- Spaces or tabs at the beginning or end of a path are ignored. For example, the space before and after the semicolon in the following is ignored:

```
set C2000_C_DIR=c:\path\one\to\tools ; c:\path\two\to\tools
```

- Spaces and tabs are allowed within paths to accommodate Windows directories that contain spaces. For example, the pathnames in the following are valid:

```
set C2000_C_DIR=c:\first path\to\tools;d:\second path\to\tools
```

The environment variable remains set until you reboot the system or reset the variable by entering:

Operating System	Enter
UNIX (Bourne shell)	<code>unset C2000_C_DIR</code>
Windows	<code>set C2000_C_DIR=</code>

2.5 Controlling the Preprocessor

This section describes features that control the preprocessor, which is part of the parser. A general description of C preprocessing is in section A12 of K&R. The C/C++ compiler includes standard C/C++ preprocessing functions, which are built into the first pass of the compiler. The preprocessor handles:

- Macro definitions and expansions
- #include files
- Conditional compilation
- Various preprocessor directives, specified in the source file as lines beginning with the # character

The preprocessor produces self-explanatory error messages. The line number and the filename where the error occurred are printed along with a diagnostic message.

2.5.1 Predefined Macro Names

The compiler maintains and recognizes the predefined macro names listed in [Table 2-30](#).

Table 2-30. Predefined C28x Macro Names

Macro Name	Description
<code>__DATE__</code> ⁽¹⁾	Expands to the compilation date in the form <i>mmm dd yyyy</i>
<code>__FILE__</code> ⁽¹⁾	Expands to the current source filename
<code>__LINE__</code> ⁽¹⁾	Expands to the current line number
<code>__little_endian__</code>	Always defined
<code>__PTRDIFF_T_TYPE__</code>	Set to the type of <code>ptrdiff_t</code> .
<code>__SIZE_T_TYPE__</code>	Set to the type of <code>size_t</code> .
<code>__STDC__</code> ⁽¹⁾	Defined to indicate that compiler conforms to ISO C Standard. See Section 6.1 for exceptions to ISO C conformance.
<code>__STDC_VERSION__</code>	C standard macro
<code>__TI_COMPILER_VERSION__</code>	Defined to a 7-9 digit integer, depending on if X has 1, 2, or 3 digits. The number does not contain a decimal. For example, version 3.2.1 is represented as 3002001. The leading zeros are dropped to prevent the number being interpreted as an octal.
<code>__TI_GNU_ATTRIBUTE_SUPPORT__</code>	Defined if GCC extensions are enabled (which is the default)
<code>__TI_STRICT_ANSI_MODE__</code>	Defined if strict ANSI/ISO mode is enabled (the <code>--strict_ansi</code> option is used); otherwise, it is undefined.
<code>__TI_STRICT_FP_MODE__</code>	Defined to 1 if <code>--fp_mode=strict</code> is used (or implied); otherwise, it is undefined.
<code>__TIME__</code> ⁽¹⁾	Expands to the compilation time in the form " <i>hh:mm:ss</i> "
<code>__TMS320C2000__</code>	Defined for C28x processor
<code>__TMS320C28XX__</code>	Defined if target is C28x
<code>__TMS320C28XX_CLA__</code>	Defined to 1 if any <code>--cla_support</code> option was used.
<code>__TMS320C28XX_CLA0__</code>	Defined to 1 if the <code>--cla_support=cla0</code> option was used.
<code>__TMS320C28XX_CLA1__</code>	Defined to 1 if the <code>--cla_support=cla1</code> option was used.
<code>__TMS320C28XX_CLA2__</code>	Defined to 1 if the <code>--cla_support=cla2</code> option was used.
<code>__TMS320C28XX_FPU32__</code>	Expands to 1 (identifies the C28x processor with 32-bit hardware floating-point support).
<code>__TMS320C28XX_TMU__</code>	Defined to 1 if the <code>--tmu_support</code> option was used to enable the Trigonometric Math Unit.
<code>__WCHAR_T_TYPE__</code>	Set to the type of <code>wchar_t</code> .
<code>__INLINE</code>	Expands to 1 if optimization is used (<code>--opt_level</code> or <code>-O</code> option); undefined otherwise.

⁽¹⁾ Specified by the ISO standard

You can use the names listed in [Table 2-30](#) in the same manner as any other defined name. For example,

```
printf ( "%s %s" , __TIME__ , __DATE__ );
```

translates to a line such as:

```
printf ( "%s %s" , "13:58:17" , "Jan 14 1997" );
```

2.5.2 The Search Path for #include Files

The #include preprocessor directive tells the compiler to read source statements from another file. When specifying the file, you can enclose the filename in double quotes or in angle brackets. The filename can be a complete pathname, partial path information, or a filename with no path information.

- If you enclose the filename in double quotes (" "), the compiler searches for the file in the following directories in this order:
 1. The directory of the file that contains the #include directive and in the directories of any files that contain that file.
 2. Directories named with the --include_path option.
 3. Directories set with the C2000_C_DIR environment variable.
- If you enclose the filename in angle brackets (< >), the compiler searches for the file in the following directories in this order:
 1. Directories named with the --include_path option.
 2. Directories set with the C2000_C_DIR environment variable.

See [Section 2.5.2.1](#) for information on using the --include_path option. See [Section 2.4.2](#) for more information on input file directories.

2.5.2.1 Adding a Directory to the #include File Search Path (--include_path Option)

The --include_path option names an alternate directory that contains #include files. The --include_path option's short form is -I. The format of the --include_path option is:

```
--include_path=directory1 [--include_path= directory2 ...]
```

There is no limit to the number of --include_path options per invocation of the compiler; each --include_path option names one *directory*. In C source, you can use the #include directive without specifying any directory information for the file; instead, you can specify the directory information with the --include_path option.

For example, assume that a file called source.c is in the current directory. The file source.c contains the following directive statement:

```
#include "alt.h"
```

Assume that the complete pathname for alt.h is:

UNIX	/tools/files/alt.h
Windows	c:\tools\files\alt.h

The table below shows how to invoke the compiler. Select the command for your operating system:

Operating System	Enter
UNIX	<code>cl2000 --include_path=/tools/files source.c</code>
Windows	<code>cl2000 --include_path=c:\tools\files source.c</code>

NOTE: Specifying Path Information in Angle Brackets

If you specify the path information in angle brackets, the compiler applies that information relative to the path information specified with `--include_path` options and the `C2000_C_DIR` environment variable.

For example, if you set up `C2000_C_DIR` with the following command:

```
C2000_C_DIR "/usr/include;/usr/ucb"; export C2000_C_DIR
```

or invoke the compiler with the following command:

```
cl2000 --include_path=/usr/include file.c
```

and `file.c` contains this line:

```
#include <sys/proc.h>
```

the result is that the included file is in the following path:

```
/usr/include/sys/proc.h
```

2.5.3 Support for the `#warning` and `#warn` Directives

In strict ANSI mode, the TI preprocessor allows you to use the `#warn` directive to cause the preprocessor to issue a warning and continue preprocessing. The `#warn` directive is equivalent to the `#warning` directive supported by GCC, IAR, and other compilers.

If you use the `--relaxed_ansi` option (on by default), both the `#warn` and `#warning` preprocessor directives are supported.

2.5.4 Generating a Preprocessed Listing File (`--preproc_only` Option)

The `--preproc_only` option allows you to generate a preprocessed version of your source file with an extension of `.pp`. The compiler's preprocessing functions perform the following operations on the source file:

- Each source line ending in a backslash (`\`) is joined with the following line.
- Trigraph sequences are expanded.
- Comments are removed.
- `#include` files are copied into the file.
- Macro definitions are processed.
- All macros are expanded.
- All other preprocessing directives, including `#line` directives and conditional compilation, are expanded.

The `--preproc_only` option is useful when creating a source file for a technical support case or to ask a question about your code. It allows you to reduce the test case to a single source file, because `#include` files are incorporated when the preprocessor runs.

2.5.5 Continuing Compilation After Preprocessing (`--preproc_with_compile` Option)

If you are preprocessing, the preprocessor performs preprocessing only; it does not compile your source code. To override this feature and continue to compile after your source code is preprocessed, use the `--preproc_with_compile` option along with the other preprocessing options. For example, use `--preproc_with_compile` with `--preproc_only` to perform preprocessing, write preprocessed output to a file with a `.pp` extension, and compile your source code.

2.5.6 **Generating a Preprocessed Listing File with Comments (--preproc_with_comment Option)**

The `--preproc_with_comment` option performs all of the preprocessing functions except removing comments and generates a preprocessed version of your source file with a `.pp` extension. Use the `--preproc_with_comment` option instead of the `--preproc_only` option if you want to keep the comments.

2.5.7 **Generating Preprocessed Listing with Line-Control Details (--preproc_with_line Option)**

By default, the preprocessed output file contains no preprocessor directives. To include the `#line` directives, use the `--preproc_with_line` option. The `--preproc_with_line` option performs preprocessing only and writes preprocessed output with line-control information (`#line` directives) to a file named as the source file but with a `.pp` extension.

2.5.8 **Generating Preprocessed Output for a Make Utility (--preproc_dependency Option)**

The `--preproc_dependency` option performs preprocessing only. Instead of writing preprocessed output, it writes a list of dependency lines suitable for input to a standard make utility. If you do not supply an optional filename, the list is written to a file with the same name as the source file but a `.pp` extension.

2.5.9 **Generating a List of Files Included with #include (--preproc_includes Option)**

The `--preproc_includes` option performs preprocessing only, but instead of writing preprocessed output, writes a list of files included with the `#include` directive. If you do not supply an optional filename, the list is written to a file with the same name as the source file but with a `.pp` extension.

2.5.10 **Generating a List of Macros in a File (--preproc_macros Option)**

The `--preproc_macros` option generates a list of all predefined and user-defined macros. If you do not supply an optional filename, the list is written to a file with the same name as the source file but with a `.pp` extension. Predefined macros are listed first and indicated by the comment `/* Predefined */`. User-defined macros are listed next and indicated by the source filename.

2.6 **Passing Arguments to main()**

Some programs pass arguments to `main()` via `argc` and `argv`. This presents special challenges in an embedded program that is not run from the command line. In general, `argc` and `argv` are made available to your program through the `.args` section. There are various ways to populate the contents of this section for use by your program.

To cause the linker to allocate an `.args` section of the appropriate size, use the `--arg_size=size` linker option. This option tells the linker to allocate an uninitialized section named `.args`, which can be used by the loader to pass arguments from the command line of the loader to the program. The `size` is the number of bytes to be allocated. When you use the `--arg_size` option, the linker defines the `__c_args__` symbol to contain the address of the `.args` section.

It is the responsibility of the loader to populate the `.args` section. The loader and the target boot code can use the `.args` section and the `__c_args__` symbol to determine whether and how to pass arguments from the host to the target program. The format of the arguments is an array of pointers to `char` on the target. Due to variations in loaders, it is not specified how the loader determines which arguments to pass to the target.

If you are using Code Composer Studio to run your application, you can use the Scripting Console tool to populate the `.args` section. To open this tool, choose **View > Scripting Console** from the CCS menus. You can use the `loadProg` command to load an object file and its associated symbol table into memory and pass an array of arguments to `main()`. These arguments are automatically written to the allocated `.args` section.

The `loadProg` syntax is as follows, where *file* is an executable file and *args* is an object array of arguments. Use JavaScript to declare the array of arguments before using this command.

```
loadProg(file, args)
```

The `.args` section is loaded with the following data for non-SYS/BIOS-based executables, where each element in the `argv[]` array contains a string corresponding to that argument:

```
Int argc;
Char * argv[0];
Char * argv[1];
...
Char * argv[n];
```

For SYS/BIOS-based executables, the elements in the `.args` section are as follows:

```
Int argc;
Char ** argv; /* points to argv[0] */
Char * envp; /* ignored by loadProg command */
Char * argv[0];
Char * argv[1];
...
Char * argv[n];
```

For more details, see the "[Scripting Console](#)" topic in the TI Processors Wiki.

2.7 Understanding Diagnostic Messages

One of the primary functions of the compiler and linker is to report diagnostic messages for the source program. A diagnostic message indicates that something may be wrong with the program. When the compiler or linker detects a suspect condition, it displays a message in the following format:

"file.c", line n : diagnostic severity : diagnostic message

<i>"file.c"</i>	The name of the file involved
line n :	The line number where the diagnostic applies
<i>diagnostic severity</i>	The diagnostic message severity (severity category descriptions follow)
<i>diagnostic message</i>	The text that describes the problem

Diagnostic messages have a severity, as follows:

- A **fatal error** indicates a problem so severe that the compilation cannot continue. Examples of such problems include command-line errors, internal errors, and missing include files. If multiple source files are being compiled, any source files after the current one will not be compiled.
- An **error** indicates a violation of the syntax or semantic rules of the C/C++ language. Compilation may continue, but object code is not generated.
- A **warning** indicates something that is likely to be a problem, but cannot be proven to be an error. For example, the compiler emits a warning for an unused variable. An unused variable does not affect program execution, but its existence suggests that you might have meant to use it. Compilation continues and object code is generated (if no errors are detected).
- A **remark** is less serious than a warning. It may indicate something that is a potential problem in rare cases, or the remark may be strictly informational. Compilation continues and object code is generated (if no errors are detected). By default, remarks are not issued. Use the `--issue_remarks` compiler option to enable remarks.

Diagnostic messages are written to standard error with a form like the following example:

```
"test.c", line 5: error: a break statement may only be used within a loop or switch
    break;
    ^
```

By default, the source code line is not printed. Use the `--verbose_diagnostics` compiler option to display the source line and the error position. The above example makes use of this option.

The message identifies the file and line involved in the diagnostic, and the source line itself (with the position indicated by the `^` character) follows the message. If several diagnostic messages apply to one source line, each diagnostic has the form shown; the text of the source line is displayed several times, with an appropriate position indicated each time.

Long messages are wrapped to additional lines, when necessary.

You can use the `--display_error_number` command-line option to request that the diagnostic's numeric identifier be included in the diagnostic message. When displayed, the diagnostic identifier also indicates whether the diagnostic can have its severity overridden on the command line. If the severity can be overridden, the diagnostic identifier includes the suffix `-D` (for *discretionary*); otherwise, no suffix is present. For example:

```
"Test_name.c", line 7: error #64-D: declaration does not declare anything
    struct {};
    ^

"Test_name.c", line 9: error #77: this declaration has no storage class or type specifier
    xxxxx;
    ^
```

Because errors are determined to be discretionary based on the severity in a specific context, an error can be discretionary in some cases and not in others. All warnings and remarks are discretionary.

For some messages, a list of entities (functions, local variables, source files, etc.) is useful; the entities are listed following the initial error message:

```
"test.c", line 4: error: more than one instance of overloaded function "f"
    matches the argument list:
    function "f(int)"
    function "f(float)"
    argument types are: (double)

    f(1.5);
    ^
```

In some cases, additional context information is provided. Specifically, the context information is useful when the front end issues a diagnostic while doing a template instantiation or while generating a constructor, destructor, or assignment operator function. For example:

```
"test.c", line 7: error: "A::A()" is inaccessible
    B x;
    ^
    detected during implicit generation of "B::B()" at line 7
```

Without the context information, it is difficult to determine to what the error refers.

2.7.1 Controlling Diagnostic Messages

The C/C++ compiler provides diagnostic options to control compiler- and linker-generated diagnostic messages. The diagnostic options must be specified before the `--run_linker` option.

`--diag_error=num` Categorizes the diagnostic identified by *num* as an error. To determine the numeric identifier of a diagnostic message, use the `--display_error_number` option first in a separate compile. Then use `--diag_error=num` to recategorize the diagnostic as an error. You can only alter the severity of discretionary diagnostic messages.

--diag_remark=num	Categorizes the diagnostic identified by <i>num</i> as a remark. To determine the numeric identifier of a diagnostic message, use the <code>--display_error_number</code> option first in a separate compile. Then use <code>--diag_remark=num</code> to recategorize the diagnostic as a remark. You can only alter the severity of discretionary diagnostic messages.
--diag_suppress=num	Suppresses the diagnostic identified by <i>num</i> . To determine the numeric identifier of a diagnostic message, use the <code>--display_error_number</code> option first in a separate compile. Then use <code>--diag_suppress=num</code> to suppress the diagnostic. You can only suppress discretionary diagnostic messages.
--diag_warning=num	Categorizes the diagnostic identified by <i>num</i> as a warning. To determine the numeric identifier of a diagnostic message, use the <code>--display_error_number</code> option first in a separate compile. Then use <code>--diag_warning=num</code> to recategorize the diagnostic as a warning. You can only alter the severity of discretionary diagnostic messages.
--display_error_number	Displays a diagnostic's numeric identifier along with its text. Use this option in determining which arguments you need to supply to the diagnostic suppression options (<code>--diag_suppress</code> , <code>--diag_error</code> , <code>--diag_remark</code> , and <code>--diag_warning</code>). This option also indicates whether a diagnostic is discretionary. A discretionary diagnostic is one whose severity can be overridden. A discretionary diagnostic includes the suffix <code>-D</code> ; otherwise, no suffix is present. See Section 2.7 .
--emit_warnings_as_errors	Treats all warnings as errors. This option cannot be used with the <code>--no_warnings</code> option. The <code>--diag_remark</code> option takes precedence over this option. This option takes precedence over the <code>--diag_warning</code> option.
--issue_remarks	Issues remarks (non-serious warnings), which are suppressed by default.
--no_warnings	Suppresses diagnostic warnings (errors are still issued).
--set_error_limit=num	Sets the error limit to <i>num</i> , which can be any decimal value. The compiler abandons compiling after this number of errors. (The default is 100.)
--verbose_diagnostics	Provides verbose diagnostic messages that display the original source with line-wrap and indicate the position of the error in the source line. Note that this command-line option cannot be used within the Code Composer Studio IDE.
--write_diagnostics_file	Produces a diagnostic message information file with the same source file name with an <code>.err</code> extension. (The <code>--write_diagnostics_file</code> option is not supported by the linker.) Note that this command-line option cannot be used within the Code Composer Studio IDE.

2.7.2 How You Can Use Diagnostic Suppression Options

The following example demonstrates how you can control diagnostic messages issued by the compiler. You control the linker diagnostic messages in a similar manner.

```
int one();
int I;
int main()
{
    switch (I){
        case 1;
            return one ();
            break;
        default:
            return 0;
            break;
    }
}
```

If you invoke the compiler with the `--quiet` option, this is the result:

```
"err.c", line 9: warning: statement is unreachable
"err.c", line 12: warning: statement is unreachable
```

Because it is standard programming practice to include break statements at the end of each case arm to avoid the fall-through condition, these warnings can be ignored. Using the `--display_error_number` option, you can find out the diagnostic identifier for these warnings. Here is the result:

```
[err.c]
"err.c", line 9: warning #111-D: statement is unreachable
"err.c", line 12: warning #111-D: statement is unreachable
```

Next, you can use the diagnostic identifier of 111 as the argument to the `--diag_remark` option to treat this warning as a remark. This compilation now produces no diagnostic messages (because remarks are disabled by default).

NOTE: You can suppress any non-fatal errors, but be careful to make sure you only suppress diagnostic messages that you understand and are known not to affect the correctness of your program.

2.8 Other Messages

Other error messages that are unrelated to the source, such as incorrect command-line syntax or inability to find specified files, are usually fatal. They are identified by the symbol `>>` preceding the message.

2.9 Generating Cross-Reference Listing Information (`--gen_cross_reference` Option)

The `--gen_cross_reference` option generates a cross-reference listing file that contains reference information for each identifier in the source file. (The `--gen_cross_reference` option is separate from `--asm_listing_cross_reference`, which is an assembler rather than a compiler option.) The cross-reference listing file has the same name as the source file with a `.crl` extension.

The information in the cross-reference listing file is displayed in the following format:

sym-id name X filename line number column number

<i>sym-id</i>	An integer uniquely assigned to each identifier
<i>name</i>	The identifier name
<i>X</i>	One of the following values:
	D Definition
	d Declaration (not a definition)
	M Modification
	A Address taken
	U Used
	C Changed (used and modified in a single operation)
	R Any other kind of reference
	E Error; reference is indeterminate
<i>filename</i>	The source file
<i>line number</i>	The line number in the source file
<i>column number</i>	The column number in the source file

2.10 Generating a Raw Listing File (--gen_preprocessor_listing Option)

The `--gen_preprocessor_listing` option generates a raw listing file that can help you understand how the compiler is preprocessing your source file. Whereas the preprocessed listing file (generated with the `--preproc_only`, `--preproc_with_comment`, `--preproc_with_line`, and `--preproc_dependency` preprocessor options) shows a preprocessed version of your source file, a raw listing file provides a comparison between the original source line and the preprocessed output. The raw listing file has the same name as the corresponding source file with an `.rl` extension.

The raw listing file contains the following information:

- Each original source line
- Transitions into and out of include files
- Diagnostic messages
- Preprocessed source line if nontrivial processing was performed (comment removal is considered trivial; other preprocessing is nontrivial)

Each source line in the raw listing file begins with one of the identifiers listed in [Table 2-31](#).

Table 2-31. Raw Listing File Identifiers

Identifier	Definition
N	Normal line of source
X	Expanded line of source. It appears immediately following the normal line of source if nontrivial preprocessing occurs.
S	Skipped source line (false <code>#if</code> clause)
L	Change in source position, given in the following format: L <i>line number filename key</i> Where <i>line number</i> is the line number in the source file. The <i>key</i> is present only when the change is due to entry/exit of an include file. Possible values of <i>key</i> are: 1 = entry into an include file 2 = exit from an include file

The `--gen_preprocessor_listing` option also includes diagnostic identifiers as defined in [Table 2-32](#).

Table 2-32. Raw Listing File Diagnostic Identifiers

Diagnostic Identifier	Definition
E	Error
F	Fatal
R	Remark
W	Warning

Diagnostic raw listing information is displayed in the following format:

<i>S filename line number column number diagnostic</i>
--

S	One of the identifiers in Table 2-32 that indicates the severity of the diagnostic
<i>filename</i>	The source file
<i>line number</i>	The line number in the source file
<i>column number</i>	The column number in the source file
<i>diagnostic</i>	The message text for the diagnostic

Diagnostic messages after the end of file are indicated as the last line of the file with a column number of 0. When diagnostic message text requires more than one line, each subsequent line contains the same file, line, and column information but uses a lowercase version of the diagnostic identifier. For more information about diagnostic messages, see [Section 2.7](#).

2.11 Using Inline Function Expansion

When an inline function is called, a copy of the C/C++ source code for the function is inserted at the point of the call. This is known as inline function expansion, commonly called *function inlining* or just *inlining*. Inline function expansion can speed up execution by eliminating function call overhead. This is particularly beneficial for very small functions that are called frequently. Function inlining involves a tradeoff between execution speed and code size, because the code is duplicated at each function call site. Large functions that are called frequently are poor candidates for inlining.

Function inlining is triggered by the following situations:

- The use of built-in intrinsic operations. Intrinsic operations look like function calls, and are inlined automatically, even though no function body exists.
- Use of the inline keyword or the equivalent `__inline` keyword. Functions declared with the inline keyword may be inlined by the compiler if you set `--opt_level=3` or greater. The inline keyword is a suggestion from the programmer to the compiler. Even if your optimization level is high, inlining is still optional for the compiler. The compiler decides whether to inline a function based on the length of the function, the number of times it is called, your `--opt_for_speed` setting, your `--opt_for_space` setting, and any contents of the function that disqualify it from inlining (see [Section 2.11.4](#)). Functions can be inlined at `--opt_level=3` if the function body is visible in the same module or if `-pm` is also used and the function is visible in one of the modules being compiled. Functions may be inlined at link time if the file containing the definition and the call site were both compiled with `--opt_level=4`.
- Use of static inline functions. Functions defined as both static and inline are more likely to be inlined.
- When `--opt_level=3` or greater is used, the compiler may automatically inline eligible functions even if they are not declared as inline functions. The same list of decision factors listed for functions explicitly defined with the inline keyword is used. For more about automatic function inlining, see [Section 3.8](#)
- Definition-controlled inlining with the unguarded inline keyword
- Definition-controlled inlining with the guarded inline keyword
- The pragma `FUNC_ALWAYS_INLINE` forces a function to be inlined (where it is legal to do so) unless `--opt_level=off`. That is, the pragma `FUNC_ALWAYS_INLINE` forces function inlining even if `--opt_level=0` or `--opt_level=1`.

NOTE: Function Inlining Can Greatly Increase Code Size

Function inlining increases code size, especially inlining a function that is called in a number of places. Function inlining is optimal for functions that are called only from a small number of places and for small functions.

The semantics of the inline keyword in C code follow the C99 standard. The semantics of the inline keyword in C++ code follow the C++ standard.

The inline keyword is supported in all C++ modes, in relaxed ANSI mode for all C standards, and in strict ANSI mode for C99. It is disabled in strict ANSI mode for C89, because it is a language extension that could conflict with a strictly conforming program. If you want to define inline functions while in strict ANSI C89 mode, use the alternate keyword `__inline`.

Compiler options that affect inlining are: `--opt_level`, `--auto_inline`, `-remove_hooks_when_inlining`, `--opt_for_space`, and `-opt_for_speed`.

In most cases, inlining will reduce the code size by a small amount.

2.11.1 Inlining Intrinsic Operators

The compiler has built-in function-like operations called intrinsics. Intrinsic operations look like function calls, and can be implemented very efficiently with the target's instruction set.

There are many intrinsic operators for the C28x. All of them are automatically inlined by the compiler. The inlining happens automatically whether or not you use the optimizer.

For details about intrinsics, and a list of the intrinsics, see [Section 7.5.6](#).

2.11.2 Unguarded Definition-Controlled Inlining

The inline keyword specifies that a function is expanded inline at the point at which it is called rather than by using standard calling procedures. The compiler performs inline expansion of functions declared with the inline keyword.

You must invoke the optimizer with any `--opt_level` option (`--opt_level=0`, `--opt_level=1`, `--opt_level=2`, or `--opt_level=3`) to turn on definition-controlled inlining. Automatic inlining is also turned on when using `--opt_level=3`.

[Example 2-1](#) shows usage of the inline keyword, where the function call is replaced by the code in the called function.

Example 2-1. Using the Inline Keyword

```
inline float volume_sphere(float r)
{
    return 4.0/3.0 * PI * r * r * r;
}
int foo(...)
{
    ...
    volume = volume_sphere(radius);
    ...
}
```

2.11.3 Guarded Inlining and the `_INLINE` Preprocessor Symbol

When declaring a function in a header file as static inline, you must follow additional procedures to avoid a potential code size increase the optimizer is not run.

To prevent a static inline function in a header file from causing an increase in code size when inlining gets turned off, use the following procedure. This allows external-linkage when inlining is turned off; thus, only one function definition will exist throughout the object files.

- Prototype a static inline version of the function. Then, prototype an alternative, nonstatic, externally-linked version of the function. Conditionally preprocess these two prototypes with the `_INLINE` preprocessor symbol, as shown in [Example 2-2](#).
- Create an identical version of the function definition in a `.c` or `.cpp` file, as shown in [Example 2-3](#).

In the following examples there are two definitions of the `strlen` function. The first ([Example 2-2](#)), in the header file, is an inline definition. This definition is enabled and the prototype is declared as static inline only if `_INLINE` is true (`_INLINE` is automatically defined for you when the optimizer is used).

The second definition (see [Example 2-3](#)) for the library, ensures that the callable version of `strlen` exists when inlining is disabled. Since this is not an inline function, the `_INLINE` preprocessor symbol is undefined (`#undef`) before `string.h` is included to generate a noninline version of `strlen`'s prototype.

Example 2-2. Header File `string.h`

```

/*****
/* string.h vx.xx
/* Copyright (c) 1993-2006 Texas Instruments Incorporated
/* Excerpted ...
/*****
#ifdef _INLINE
#define _IDECL static inline
#else
#define _IDECL extern _CODE_ACCESS
#endif

_IDECL size_t strlen(const char *_string);

#ifdef _INLINE

/*****
/* strlen
/*****
static inline size_t strlen(const char *string)
{
    size_t    n = (size_t)-1;
    const char *s = string - 1;

    do n++; while (*++s);
    return n
}

#endif

```

Example 2-3. Library Definition File

```

/*****
/*  strlen
*****/
#undef _INLINE

#include <string>
_CODE_ACCESS size_t strlen(const char * string)
{
    size_t    n = (size_t)-1;
    const char *s = string - 1;

    do n++; while (*++s);
    return n;
}

```

2.11.4 Inlining Restrictions

The compiler makes decisions about which functions to inline based on the factors mentioned in [Section 2.11](#). In addition, there are several restrictions that can disqualify a function from being inlined by automatic inlining or inline keyword-based inlining. The `FUNC_ALWAYS_INLINE` pragma overrides these disqualifications, so you should be aware of situations that can cause problems if you are using the `FUNC_ALWAYS_INLINE` pragma.

- Is not defined in the current compilation unit and you are not using `-O4` optimization
- Never returns
- Is a recursive or nonleaf function that exceeds the depth limit
- Has a variable-length argument list
- Has a different number of arguments than the call site
- Has an argument whose type is incompatible with the corresponding call site argument
- Has a class, struct, or union parameter
- Contains a volatile local variable or argument
- Contains local static variables but is not a static inline function.
- Is not declared inline and contains an `asm()` statement that is not a comment
- Is the `main()` function
- Is an interrupt function
- Is not declared inline and returns void but its return value is needed.
- Is not declared inline and will require too much stack space for local array or structure variables.

Furthermore, inlining should be used for small functions or functions that are called in a few places (though the compiler does not enforce this).

NOTE: Excessive Inlining Can Degrade Performance

Excessive inlining can make the compiler dramatically slower and degrade the performance of generated code.

2.12 Using Interlist

The compiler tools include a feature that interlists C/C++ source statements into the assembly language output of the compiler. The interlist feature enables you to inspect the assembly code generated for each C statement. The interlist behaves differently, depending on whether or not the optimizer is used, and depending on which options you specify.

The easiest way to invoke the interlist feature is to use the `--c_src_interlist` option. To compile and run the interlist on a program called `function.c`, enter:

```
cl2000 --c_src_interlist function
```

The `--c_src_interlist` option prevents the compiler from deleting the interlisted assembly language output file. The output assembly file, `function.asm`, is assembled normally.

When you invoke the interlist feature without the optimizer, the interlist runs as a separate pass between the code generator and the assembler. It reads both the assembly and C/C++ source files, merges them, and writes the C/C++ statements into the assembly file as comments.

Using the `--c_src_interlist` option can cause performance and/or code size degradation.

[Example 2-4](#) shows a typical interlisted assembly file.

For more information about using the interlist feature with the optimizer, see [Section 3.9](#).

Example 2-4. An Interlisted Assembly Language File

```

;-----
; 1 | int main()
;-----

;*****
;* FNAME: _main                FR SIZE: 0          *
;*                               *
;* FUNCTION ENVIRONMENT        *
;*                               *
;* FUNCTION PROPERTIES         *
;*                               0 Parameter, 0 Auto, 0 SOE *
;*****

_main:
;-----
; 3 | printf("Hello World\n");
;-----
        MOVL    XAR4,#SL1                ; |3|
        LCR    #_printf                  ; |3|
        ; call occurs [#_printf] ; |3|
;-----
; 4 | return 0;
;-----

;*****
;* STRINGS *
;*****

        .sect    ".econst"
SL1:    .string "Hello World",10,0
;*****
;* UNDEFINED EXTERNAL REFERENCES *
;*****
.global _printf

```

2.13 Enabling Entry Hook and Exit Hook Functions

An entry hook is a routine that is called upon entry to each function in the program. An exit hook is a routine that is called upon exit of each function. Applications for hooks include debugging, trace, profiling, and stack overflow checking.

Entry and exit hooks are enabled using the following options:

<code>--entry_hook[=<i>name</i>]</code>	Enables entry hooks. If specified, the hook function is called <i>name</i> . Otherwise, the default entry hook function name is <code>__entry_hook</code> .
<code>--entry_parm{=<i>name</i> address none}</code>	Specify the parameters to the hook function. The name parameter specifies that the name of the calling function is passed to the hook function as an argument. In this case the signature for the hook function is: <code>void hook(const char *name);</code> The address parameter specifies that the address of the calling function is passed to the hook function. In this case the signature for the hook function is: <code>void hook(void (*addr)());</code> The none parameter specifies that the hook is called with no parameters. This is the default. In this case the signature for the hook function is: <code>void hook(void);</code>
<code>--exit_hook[=<i>name</i>]</code>	Enables exit hooks. If specified, the hook function is called <i>name</i> . Otherwise, the default exit hook function name is <code>__exit_hook</code> .
<code>--exit_parm{=<i>name</i> address none}</code>	Specify the parameters to the hook function. The name parameter specifies that the name of the calling function is passed to the hook function as an argument. In this case the signature for the hook function is: <code>void hook(const char *name);</code> The address parameter specifies that the address of the calling function is passed to the hook function. In this case the signature for the hook function is: <code>void hook(void (*addr)());</code> The none parameter specifies that the hook is called with no parameters. This is the default. In this case the signature for the hook function is: <code>void hook(void);</code>

The presence of the hook options creates an implicit declaration of the hook function with the given signature. If a declaration or definition of the hook function appears in the compilation unit compiled with the options, it must agree with the signatures listed above.

In C++, the hooks are declared extern "C". Thus you can define them in C (or assembly) without being concerned with name mangling.

Hooks can be declared inline, in which case the compiler tries to inline them using the same criteria as other inline functions.

Entry hooks and exit hooks are independent. You can enable one but not the other, or both. The same function can be used as both the entry and exit hook.

You must take care to avoid recursive calls to hook functions. The hook function should not call any function which itself has hook calls inserted. To help prevent this, hooks are not generated for inline functions, or for the hook functions themselves.

You can use the `--remove_hooks_when_inlining` option to remove entry/exit hooks for functions that are auto-inlined by the optimizer.

See [Section 6.9.16](#) for information about the `NO_HOOKS` pragma.

Optimizing Your Code

The compiler tools can perform many optimizations to improve the execution speed and reduce the size of C and C++ programs by simplifying loops, rearranging statements and expressions, and allocating variables into registers.

This chapter describes how to invoke different levels of optimization and describes which optimizations are performed at each level. This chapter also describes how you can use the Interlist feature when performing optimization and how you can profile or debug optimized code.

Topic	Page
3.1 Invoking Optimization	55
3.2 Performing File-Level Optimization (--opt_level=3 option)	56
3.3 Program-Level Optimization (--program_level_compile and --opt_level=3 options).....	56
3.4 Link-Time Optimization (--opt_level=4 Option)	59
3.5 Using Feedback Directed Optimization	59
3.6 Using Profile Information to Analyze Code Coverage	64
3.7 Special Considerations When Using Optimization.....	66
3.8 Automatic Inline Expansion (--auto_inline Option).....	68
3.9 Using the Interlist Feature With Optimization.....	68
3.10 Data Page (DP) Pointer Load Optimization	71
3.11 Debugging and Profiling Optimized Code.....	71
3.12 Controlling Code Size Versus Speed	72
3.13 Increasing Code-Size Optimizations (--opt_for_space Option)	73
3.14 Compiler Support for Generating DMAC Instructions	74
3.15 What Kind of Optimization Is Being Performed?	77

3.1 Invoking Optimization

The C/C++ compiler is able to perform various optimizations. High-level optimizations are performed in the optimizer and low-level, target-specific optimizations occur in the code generator. Use high-level optimization levels, such as `--opt_level=2` and `--opt_level=3`, to achieve optimal code.

The easiest way to invoke optimization is to use the compiler program, specifying the `--opt_level=n` option on the compiler command line. You can use `-On` to alias the `--opt_level` option. The *n* denotes the level of optimization (0, 1, 2, 3, and 4), which controls the type and degree of optimization.

- **`--opt_level=off` or `-Ooff`**
 - Performs no optimization
- **`--opt_level=0` or `-O0`**
 - Performs control-flow-graph simplification
 - Allocates variables to registers
 - Performs loop rotation
 - Eliminates unused code
 - Simplifies expressions and statements
 - Expands calls to functions declared inline
- **`--opt_level=1` or `-O1`**

Performs all `--opt_level=0` (`-O0`) optimizations, plus:

 - Performs local copy/constant propagation
 - Removes unused assignments
 - Eliminates local common expressions
- **`--opt_level=2` or `-O2`**

Performs all `--opt_level=1` (`-O1`) optimizations, plus:

 - Performs loop optimizations
 - Eliminates global common subexpressions
 - Eliminates global unused assignments
 - Performs loop unrolling
- **`--opt_level=3` or `-O3`**

Performs all `--opt_level=2` (`-O2`) optimizations, plus:

 - Removes all functions that are never called
 - Simplifies functions with return values that are never used
 - Inlines calls to small functions
 - Reorders function declarations; the called functions attributes are known when the caller is optimized
 - Propagates arguments into function bodies when all calls pass the same value in the same argument position
 - Identifies file-level variable characteristics

If you use `--opt_level=3` (`-O3`), see [Section 3.2](#) and [Section 3.3](#) for more information.
- **`--opt_level=4` or `-O4`**

Performs link-time optimization. See [Section 3.4](#) for details.

By default, debugging is enabled and the default optimization level is unaffected by the generation of debug information. However, the optimization level used is affected by whether or not the command line includes the `-g` (`--symdebug:dwarf`) option and the `--opt_level` option as shown in the following table:

Table 3-1. Interaction Between Debugging and Optimization Options

Optimization	no -g	-g
no <code>--opt_level</code>	<code>--opt_level=off</code>	<code>--opt_level=off</code>
<code>--opt_level</code>	<code>--opt_level=2</code>	<code>--opt_level=2</code>
<code>--opt_level=n</code>	optimized as specified	optimized as specified

The levels of optimizations described above are performed by the stand-alone optimization pass. The code generator performs several additional optimizations, particularly processor-specific optimizations. It does so regardless of whether you invoke the optimizer. These optimizations are always enabled, although they are more effective when the optimizer is used.

3.2 Performing File-Level Optimization (`--opt_level=3` option)

The `--opt_level=3` option (aliased as the `-O3` option) instructs the compiler to perform file-level optimization. You can use the `--opt_level=3` option alone to perform general file-level optimization, or you can combine it with other options to perform more specific optimizations. The options listed in [Table 3-2](#) work with `--opt_level=3` to perform the indicated optimization:

Table 3-2. Options That You Can Use With `--opt_level=3`

If You ...	Use this Option	See
Want to create an optimization information file	<code>--gen_opt_level=n</code>	Section 3.2.1
Want to compile multiple source files	<code>--program_level_compile</code>	Section 3.3

3.2.1 Creating an Optimization Information File (`--gen_opt_info` Option)

When you invoke the compiler with the `--opt_level=3` option, you can use the `--gen_opt_info` option to create an optimization information file that you can read. The number following the option denotes the level (0, 1, or 2). The resulting file has an `.nfo` extension. Use [Table 3-3](#) to select the appropriate level to append to the option.

Table 3-3. Selecting a Level for the `--gen_opt_info` Option

If you...	Use this option
Do not want to produce an information file, but you used the <code>--gen_opt_level=1</code> or <code>--gen_opt_level=2</code> option in a command file or an environment variable. The <code>--gen_opt_level=0</code> option restores the default behavior of the optimizer.	<code>--gen_opt_info=0</code>
Want to produce an optimization information file	<code>--gen_opt_info=1</code>
Want to produce a verbose optimization information file	<code>--gen_opt_info=2</code>

3.3 Program-Level Optimization (`--program_level_compile` and `--opt_level=3` options)

You can specify program-level optimization by using the `--program_level_compile` option with the `--opt_level=3` option (aliased as `-O3`). (If you use `--opt_level=4` (`-O4`), the `--program_level_compile` option cannot be used, because link-time optimization provides the same optimization opportunities as program level optimization.)

With program-level optimization, all of your source files are compiled into one intermediate file called a *module*. The module moves to the optimization and code generation passes of the compiler. Because the compiler can see the entire program, it performs several optimizations that are rarely applied during file-level optimization:

- If a particular argument in a function always has the same value, the compiler replaces the argument with the value and passes the value instead of the argument.
- If a return value of a function is never used, the compiler deletes the return code in the function.
- If a function is not called directly or indirectly by `main()`, the compiler removes the function.

The `--program_level_compile` option requires use of `--opt_level=3` or higher in order to perform these optimizations.

To see which program-level optimizations the compiler is applying, use the `--gen_opt_level=2` option to generate an information file. See [Section 3.2.1](#) for more information.

In Code Composer Studio, when the `--program_level_compile` option is used, C and C++ files that have the same options are compiled together. However, if any file has a file-specific option that is not selected as a project-wide option, that file is compiled separately. For example, if every C and C++ file in your project has a different set of file-specific options, each is compiled separately, even though program-level optimization has been specified. To compile all C and C++ files together, make sure the files do not have file-specific options. Be aware that compiling C and C++ files together may not be safe if previously you used a file-specific option.

Compiling Files With the `--program_level_compile` and `--keep_asm` Options

NOTE: If you compile all files with the `--program_level_compile` and `--keep_asm` options, the compiler produces only one `.asm` file, not one for each corresponding source file.

3.3.1 Controlling Program-Level Optimization (`--call_assumptions` Option)

You can control program-level optimization, which you invoke with `--program_level_compile --opt_level=3`, by using the `--call_assumptions` option. Specifically, the `--call_assumptions` option indicates if functions in other modules can call a module's external functions or modify a module's external variables. The number following `--call_assumptions` indicates the level you set for the module that you are allowing to be called or modified. The `--opt_level=3` option combines this information with its own file-level analysis to decide whether to treat this module's external function and variable declarations as if they had been declared static. Use [Table 3-4](#) to select the appropriate level to append to the `--call_assumptions` option.

Table 3-4. Selecting a Level for the `--call_assumptions` Option

If Your Module ...	Use this Option
Has functions that are called from other modules and global variables that are modified in other modules	<code>--call_assumptions=0</code>
Does not have functions that are called by other modules but has global variables that are modified in other modules	<code>--call_assumptions=1</code>
Does not have functions that are called by other modules or global variables that are modified in other modules	<code>--call_assumptions=2</code>
Has functions that are called from other modules but does not have global variables that are modified in other modules	<code>--call_assumptions=3</code>

In certain circumstances, the compiler reverts to a different `--call_assumptions` level from the one you specified, or it might disable program-level optimization altogether. [Table 3-5](#) lists the combinations of `--call_assumptions` levels and conditions that cause the compiler to revert to other `--call_assumptions` levels.

Table 3-5. Special Considerations When Using the `--call_assumptions` Option

If <code>--call_assumptions</code> is...	Under these Conditions...	Then the <code>--call_assumptions</code> Level...
Not specified	The <code>--opt_level=3</code> optimization level was specified	Defaults to <code>--call_assumptions=2</code>
Not specified	The compiler sees calls to outside functions under the <code>--opt_level=3</code> optimization level	Reverts to <code>--call_assumptions=0</code>
Not specified	Main is not defined	Reverts to <code>--call_assumptions=0</code>
<code>--call_assumptions=1</code> or <code>--call_assumptions=2</code>	No function has main defined as an entry point, <i>and</i> no interrupt functions are defined, <i>and</i> no functions are identified by the <code>FUNC_EXT_CALLED</code> pragma	Reverts to <code>--call_assumptions=0</code>
<code>--call_assumptions=1</code> or <code>--call_assumptions=2</code>	A main function is defined, <i>or</i> an interrupt function is defined, <i>or</i> a function is identified by the <code>FUNC_EXT_CALLED</code> pragma	Remains <code>--call_assumptions=1</code> or <code>--call_assumptions=2</code>
<code>--call_assumptions=3</code>	Any condition	Remains <code>--call_assumptions=3</code>

In some situations when you use `--program_level_compile` and `--opt_level=3`, you *must* use a `--call_assumptions` option or the `FUNC_EXT_CALLED` pragma. See [Section 3.3.2](#) for information about these situations.

3.3.2 Optimization Considerations When Mixing C/C++ and Assembly

If you have any assembly functions in your program, you need to exercise caution when using the `--program_level_compile` option. The compiler recognizes only the C/C++ source code and not any assembly code that might be present. Because the compiler does not recognize the assembly code calls and variable modifications to C/C++ functions, the `--program_level_compile` option optimizes out those C/C++ functions. To keep these functions, place the `FUNC_EXT_CALLED` pragma (see [Section 6.9.12](#)) before any declaration or reference to a function that you want to keep.

Another approach you can take when you use assembly functions in your program is to use the `--call_assumptions=n` option with the `--program_level_compile` and `--opt_level=3` options. See [Section 3.3.1](#) for information about the `--call_assumptions=n` option.

In general, you achieve the best results through judicious use of the `FUNC_EXT_CALLED` pragma in combination with `--program_level_compile --opt_level=3` and `--call_assumptions=1` or `--call_assumptions=2`.

If any of the following situations apply to your application, use the suggested solution:

Situation — Your application consists of C/C++ source code that calls assembly functions. Those assembly functions do not call any C/C++ functions or modify any C/C++ variables.

Solution — Compile with `--program_level_compile --opt_level=3 --call_assumptions=2` to tell the compiler that outside functions do not call C/C++ functions or modify C/C++ variables.

If you compile with the `--program_level_compile --opt_level=3` options only, the compiler reverts from the default optimization level (`--call_assumptions=2`) to `--call_assumptions=0`. The compiler uses `--call_assumptions=0`, because it presumes that the calls to the assembly language functions that have a definition in C/C++ may call other C/C++ functions or modify C/C++ variables.

Situation — Your application consists of C/C++ source code that calls assembly functions. The assembly language functions do not call C/C++ functions, but they modify C/C++ variables.

Solution — Try both of these solutions and choose the one that works best with your code:

- Compile with `--program_level_compile --opt_level=3 --call_assumptions=1`.
- Add the `volatile` keyword to those variables that may be modified by the assembly functions and compile with `--program_level_compile --opt_level=3 --call_assumptions=2`.

Situation — Your application consists of C/C++ source code and assembly source code. The assembly functions are interrupt service routines that call C/C++ functions; the C/C++ functions that the assembly functions call are never called from C/C++. These C/C++ functions act like `main`: they function as entry points into C/C++.

Solution — Add the `volatile` keyword to the C/C++ variables that may be modified by the interrupts. Then, you can optimize your code in one of these ways:

- You achieve the best optimization by applying the `FUNC_EXT_CALLED` pragma to all of the entry-point functions called from the assembly language interrupts, and then compiling with `--program_level_compile --opt_level=3 --call_assumptions=2`. *Be sure that you use the pragma with all of the entry-point functions.* If you do not, the compiler might remove the entry-point functions that are not preceded by the `FUNC_EXT_CALLED` pragma.
- Compile with `--program_level_compile --opt_level=3 --call_assumptions=3`. Because you do not use the `FUNC_EXT_CALLED` pragma, you must use the `--call_assumptions=3` option, which is less aggressive than the `--call_assumptions=2` option, and your optimization may not be as effective.

Keep in mind that if you use `--program_level_compile --opt_level=3` without additional options, the compiler removes the C functions that the assembly functions call. Use the `FUNC_EXT_CALLED` pragma to keep these functions.

3.4 Link-Time Optimization (`--opt_level=4` Option)

Link-time optimization is an optimization mode that allows the compiler to have visibility of the entire program. The optimization occurs at link-time instead of compile-time like other optimization levels.

Link-time optimization is invoked by using the `--opt_level=4` option. This option must be used in both the compilation and linking steps. At compile time, the compiler embeds an intermediate representation of the file being compiled into the resulting object file. At link-time this representation is extracted from every object file which contains it, and is used to optimize the entire program.

If you use `--opt_level=4` (`-O4`), the `--program_level_compile` option cannot also be used, because link-time optimization provides the same optimization opportunities as program level optimization ([Section 3.3](#)). Link-time optimization provides the following benefits:

- Each source file can be compiled separately. One issue with program-level compilation is that it requires all source files to be passed to the compiler at one time. This often requires significant modification of a customer's build process. With link-time optimization, all files can be compiled separately.
- References to C/C++ symbols from assembly are handled automatically. When doing program-level compilation, the compiler has no knowledge of whether a symbol is referenced externally. When performing link-time optimization during a final link, the linker can determine which symbols are referenced externally and prevent eliminating them during optimization.
- Third party object files can participate in optimization. If a third party vendor provides object files that were compiled with the `--opt_level=4` option, those files participate in optimization along with user-generated files. This includes object files supplied as part of the TI run-time support. Object files that were not compiled with `--opt_level=4` can still be used in a link that is performing link-time optimization. Those files that were not compiled with `--opt_level=4` do not participate in the optimization.
- Source files can be compiled with different option sets. With program-level compilation, all source files must be compiled with the same option set. With link-time optimization files can be compiled with different options. If the compiler determines that two options are incompatible, it issues an error.

3.4.1 Option Handling

When performing link-time optimization, source files can be compiled with different options. When possible, the options that were used during compilation are used during link-time optimization. For options which apply at the program level, `--auto_inline` for instance, the options used to compile the main function are used. If main is not included in link-time optimization, the option set used for the first object file specified on the command line is used. Some options, `--opt_for_speed` for instance, can affect a wide range of optimizations. For these options, the program-level behavior is derived from main, and the local optimizations are obtained from the original option set.

Some options are incompatible when performing link-time optimization. These are usually options which conflict on the command line as well, but can also be options that cannot be handled during link-time optimization.

3.4.2 Incompatible Types

During a normal link, the linker does not check to make sure that each symbol was declared with the same type in different files. This is not necessary during a normal link. When performing link-time optimization, however, the linker must ensure that all symbols are declared with compatible types in different source files. If a symbol is found which has incompatible types, an error is issued. The rules for compatible types are derived from the C and C++ standards.

3.5 Using Feedback Directed Optimization

Feedback directed optimization provides a method for finding frequently executed paths in an application using compiler-based instrumentation. This information is fed back to the compiler and is used to perform optimizations. This information is also used to provide you with information about application behavior.

3.5.1 Feedback Directed Optimization

Feedback directed optimization uses run-time feedback to identify and optimize frequently executed program paths. Feedback directed optimization is a two-phase process.

3.5.1.1 Phase 1 -- Collect Program Profile Information

In this phase the compiler is invoked with the option `--gen_profile_info`, which instructs the compiler to add instrumentation code to collect profile information. The compiler inserts a minimal amount of instrumentation code to determine control flow frequencies. Memory is allocated to store counter information.

The instrumented application program is executed on the target using representative input data sets. The input data sets should correlate closely with the way the program is expected to be used in the end product environment. When the program completes, a run-time-support function writes the collected information into a profile data file called a PDAT file. Multiple executions of the program using different input data sets can be performed and in such cases, the run-time-support function appends the collected information into the PDAT file. The resulting PDAT file is post-processed using a tool called the Profile Data Decoder or `pdd2000`. The `pdd2000` tool consolidates multiple data sets and formats the data into a feedback file (PRF file, see [Section 3.5.2](#)) for consumption by phase 2 of feedback directed optimization.

3.5.1.2 Phase 2 -- Use Application Profile Information for Optimization

In this phase, the compiler is invoked with the `--use_profile_info=file.prf` option, which reads the specified PRF file generated in phase 1. In phase 2, optimization decisions are made using the data generated during phase 1. The profile feedback file is used to guide program optimization. The compiler optimizes frequently executed program paths more aggressively.

The compiler uses data in the profile feedback file to guide certain optimizations of frequently executed program paths.

3.5.1.3 Generating and Using Profile Information

There are two options that control feedback directed optimization:

- gen_profile_info** tells the compiler to add instrumentation code to collect profile information. When the program executes the run-time-support `exit()` function, the profile data is written to a PDAT file. This option applies to all the C/C++ source files being compiled on the command-line.
- If the environment variable `TI_PROFDATA` on the host is set, the data is written into the specified file. Otherwise, it uses the default filename: `pprofout.pdat`. The full pathname of the PDAT file (including the directory name) can be specified using the `TI_PROFDATA` host environment variable.
- By default, the RTS profile data output routine uses the C I/O mechanism to write data to the PDAT file. You can install a device handler for the PPHNDL device to re-direct the profile data to a custom device driver routine. For example, this could be used to send the profile data to a device that does not use a file system.
- Feedback directed optimization requires you to turn on at least some debug information when using the `--gen_profile_info` option. This enables the compiler to output debug information that allows `pdd2000` to correlate compiled functions and their associated profile data.
- use_profile_info** specifies the profile information file(s) to use for performing phase 2 of feedback directed optimization. More than one profile information file can be specified on the command line; the compiler uses all input data from multiple information files. The syntax for the option is:
- use_profile_info==file 1[, file2, ..., filen]**
- If no filename is specified, the compiler looks for a file named `pprofout.prf` in the directory where the compiler is invoked.

3.5.1.4 Example Use of Feedback Directed Optimization

These steps illustrate the creation and use of feedback directed optimization.

1. Generate profile information.

```
cl2000 --opt_level=2 --gen_profile_info foo.c --run_linker --output_file=foo.out
      --library=lnk.cmd --library=rts2800_ml.lib
```

2. Execute the application.

The execution of the application creates a PDAT file named `pprofout.pdat` in the current (host) directory. The application can be run on on target hardware connected to a host machine.

3. Process the profile data.

After running the application with multiple data-sets, run `pdd2000` on the PDAT files to create a profile information (PRF) file to be used with `--use_profile_info`.

```
pdd2000 -e foo.out -o pprofout.prf pprofout.pdat
```

4. Re-compile using the profile feedback file.

```
cl2000 --opt_level=2 --use_profile_info=pprofout.prf foo.c --run_linker
      --output_file=foo.out --library=lnk.cmd --library=rts2800_ml.lib
```

3.5.1.5 The .ppdata Section

The profile information collected in phase 1 is stored in the `.ppdata` section, which must be allocated into target memory. The `.ppdata` section contains profiler counters for all functions compiled with `--gen_profile_info`. The default `lnk.cmd` file in has directives to place the `.ppdata` section in data memory. If the link command file has no section directive for allocating `.ppdata` section, the link step places the `.ppdata` section in a writable memory range.

The `.ppdata` section must be allocated memory in multiples of 32 bytes. Please refer to the linker command file in the distribution for example usage.

3.5.1.6 Feedback Directed Optimization and Code Size Tune

Feedback directed optimization is different from the Code Size Tune feature in Code Composer Studio (CCS). The code size tune feature uses CCS profiling to select specific compilation options for each function in order to minimize code size while still maintaining a specific performance point. Code size tune is coarse-grained, since it is selecting an option set for the whole function. Feedback directed optimization selects different optimization goals along specific regions within a function.

3.5.1.7 Instrumented Program Execution Overhead

During profile collection, the execution time of the application may increase. The amount of increase depends on the size of the application and the number of files in the application compiled for profiling.

The profiling counters increase the code and data size of the application. Consider using the `--opt_for_space` (`-ms`) code size options when using profiling to mitigate the code size increase. This has no effect on the accuracy of the profile data being collected. Since profiling only counts execution frequency and not cycle counts, code size optimization flags do not affect profiler measurements.

3.5.1.8 Invalid Profile Data

When recompiling with `--use_profile_info`, the profile information is invalid in the following cases:

- The source file name changed between the generation of profile information (`gen-profile`) and the use of the profile information (`use-profile`).
- The source code was modified since `gen-profile`. In this case, profile information is invalid for the modified functions.
- Certain compiler options used with `gen-profile` are different from those with used with `use-profile`. In particular, options that affect parser behavior could invalidate profile data during `use-profile`. In general, using different optimization options during `use-profile` should not affect the validity of profile data.

3.5.2 Profile Data Decoder

The code generation tools include a tool called the Profile Data Decoder or `pdd2000`, which is used for post processing profile data (PDAT) files. The `pdd2000` tool generates a profile feedback (PRF) file. See [Section 3.5.1](#) for a discussion of where `pdd2000` fits in the profiling flow. The `pdd2000` tool is invoked with this syntax:

```
pdd2000 -e exec.out -o application.prf filename .pdat
```

-a	Computes the average of the data values in the data sets instead of accumulating data values
-e exec.out	Specifies <i>exec.out</i> is the name of the application executable.
-o application.prf	Specifies <i>application.prf</i> is the formatted profile feedback file that is used as the argument to <code>--use_profile_info</code> during recompilation. If no output file is specified, the default output filename is <code>pprofout.prf</code> .
filename .pdat	Is the name of the profile data file generated by the run-time-support function. This is the default name and it can be overridden by using the host environment variable <code>TI_PROFDATA</code> .

The run-time-support function and pdd2000 append to their respective output files and do not overwrite them. This enables collection of data sets from multiple runs of the application.

Profile Data Decoder Requirements

NOTE: Your application must be compiled with at least DWARF debug support to enable feedback directed optimization. When compiling for feedback directed optimization, the pdd2000 tool relies on basic debug information about each function in generating the formatted .prf file.

The pprofout.pdat file generated by the run-time support is a raw data file of a fixed format understood only by pdd2000. You should not modify this file in any way.

3.5.3 Feedback Directed Optimization API

There are two user interfaces to the profiler mechanism. You can start and stop profiling in your application by using the following run-time-support calls.

- `_TI_start_pprof_collection()`
This interface informs the run-time support that you wish to start profiling collection from this point on and causes the run-time support to clear all profiling counters in the application (that is, discard old counter values).
- `_TI_stop_pprof_collection()`
This interface directs the run-time support to stop profiling collection and output profiling data into the output file (into the default file or one specified by the `TI_PROFDATA` host environment variable). The run-time support also disables any further output of profile data into the output file during `exit()`, unless you call `_TI_start_pprof_collection()` again.

3.5.4 Feedback Directed Optimization Summary

Options

--gen_profile_info	Adds instrumentation to the compiled code. Execution of the code results in profile data being emitted to a PDAT file.
--use_profile_info=file.prf	Uses profile information for optimization and/or generating code coverage information.
--analyze=codecov	Generates a code coverage information file and continues with profile-based compilation. Must be used with <code>--use_profile_info</code> .
--analyze_only	Generates only a code coverage information file. Must be used with <code>--use_profile_info</code> . You must specify both <code>--analyze=codecov</code> and <code>--analyze_only</code> to do code coverage analysis of the instrumented application.

Host Environment Variables

<code>TI_PROFDATA</code>	Writes profile data into the specified file
<code>TI_COVDIR</code>	Creates code coverage files in the specified directory
<code>TI_COVDATA</code>	Writes code coverage data into the specified file

API

<code>_TI_start_pprof_collection()</code>	Clears the profile counters to file
<code>_TI_stop_pprof_collection()</code>	Writes out all profile counters to file
<code>PPHDNL</code>	Device driver handle for low-level C I/O based driver for writing out profile data from a target program.

Files Created

*.pdat	Profile data file, which is created by executing an instrumented program and used as input to the profile data decoder
*.prf	Profiling feedback file, which is created by the profile data decoder and used as input to the re-compilation step

3.6 Using Profile Information to Analyze Code Coverage

You can use the analysis information from the Profile Data Decoder to analyze code coverage.

3.6.1 Code Coverage

The information collected during feedback directed optimization can be used for generating code coverage reports. As with feedback directed optimization, the program must be compiled with the `--gen_profile_info` option.

Code coverage conveys the execution count of each line of source code in the file being compiled, using data collected during profiling.

3.6.1.1 Phase1 -- Collect Program Profile Information

In this phase the compiler is invoked with the option `--gen_profile_info`, which instructs the compiler to add instrumentation code to collect profile information. The compiler inserts a minimal amount of instrumentation code to determine control flow frequencies. Memory is allocated to store counter information.

The instrumented application program is executed on the target using representative input data sets. The input data sets should correlate closely with the way the program is expected to be used in the end product environment. When the program completes, a run-time-support function writes the collected information into a profile data file called a PDAT file. Multiple executions of the program using different input data sets can be performed and in such cases, the run-time-support function appends the collected information into the PDAT file. The resulting PDAT file is post-processed using a tool called the Profile Data Decoder or `pdd2000`. The `pdd2000` tool consolidates multiple data sets and formats the data into a feedback file (PRF file, see [Section 3.5.2](#)) for consumption by phase 2 of feedback directed optimization.

3.6.1.2 Phase 2 -- Generate Code Coverage Reports

In this phase, the compiler is invoked with the `--use_profile_info=file.prf` option, which indicates that the compiler should read the specified PRF file generated in phase 1. The application must also be compiled with either the `--codecov` or `--onlycodecov` option; the compiler generates a code-coverage info file. The `--codecov` option directs the compiler to continue compilation after generating code-coverage information, while the `--onlycodecov` option stops the compiler after generating code-coverage data. For example:

```
cl2000 --opt_level=2 --use_profile_info=pptest.prf --onlycodecov foo.c
```

You can specify two environment variables to control the destination of the code-coverage information file.

- The `TI_COVDIR` environment variable specifies the directory where the code-coverage file should be generated. The default is the directory where the compiler is invoked.
- The `TI_COVDATA` environment variable specifies the name of the code-coverage data file generated by the compiler. the default is `filename.csv` where `filename` is the base-name of the file being compiled. For example, if `foo.c` is being compiled, the default code-coverage data file name is `foo.csv`.

If the code-coverage data file already exists, the compiler appends the new dataset at the end of the file.

Code-coverage data is a comma-separated list of data items that can be conveniently handled by data-processing tools and scripting languages. The following is the format of code-coverage data:

```
"filename-with-full-path", "funcname", line#, column#, exec-frequency, "comments"
```

<code>"filename-with-full-path"</code>	Full pathname of the file corresponding to the entry
<code>"funcname"</code>	Name of the function
<code>line#</code>	Line number of the source line corresponding to frequency data
<code>column#</code>	Column number of the source line
<code>exec-frequency</code>	Execution frequency of the line
<code>"comments"</code>	Intermediate-level representation of the source-code generated by the parser

The full filename, function name, and comments appear within quotation marks ("). For example:
`"/some_dir/zlib/c2000/deflate.c", "_deflateInit2_", 216, 5, 1, "(strm->zalloc)"`

Other tools, such as a spreadsheet program, can be used to format and view the code coverage data.

3.6.2 Related Features and Capabilities

The code generation tools provide some features and capabilities that can be used in conjunction with code coverage analysis. The following is a summary:

3.6.2.1 Path Profiler

The code generation tools include a path profiling utility, pprof2000, that is run from the compiler, cl2000. The pprof2000 utility is invoked by the compiler when the `--gen_profile` or the `--use_profile` command is used from the compiler command line:

```
cl2000 --gen_profile ... file.c
cl2000 --use_profile ... file.c
```

For further information about profile-based optimization and a more detailed description of the profiling infrastructure, see [Section 3.5](#).

3.6.2.2 Analysis Options

The path profiling utility, pprof2000, appends code coverage information to existing CSV (comma separated values) files that contain the same type of analysis information.

The utility checks to make sure that an existing CSV file contains analysis information that is consistent with the type of analysis information it is being asked to generate. Attempts to mix code coverage and other analysis information in the same output CSV file will be detected, and pprof2000 will emit a fatal error and abort.

<code>--analyze=codecov</code>	Instructs the compiler to generate code coverage analysis information. This option replaces the previous <code>--codecov</code> option.
<code>--analyze_only</code>	Halts compilation after generation of analysis information is completed.

3.6.2.3 Environment Variables

To assist with the management of output CSV analysis files, pprof2000 supports this environment variable:

<code>TI_ANALYSIS_DIR</code>	Specifies the directory in which the output analysis file will be generated.
------------------------------	--

3.7 Special Considerations When Using Optimization

The compiler is designed to improve your ANSI/ISO-conforming C and C++ programs while maintaining their correctness. However, when you write code for optimization, you should note the special considerations discussed in the following sections to ensure that your program performs as you intend.

3.7.1 Use Caution With *asm* Statements in Optimized Code

You must be extremely careful when using *asm* (inline assembly) statements in optimized code. The compiler rearranges code segments, uses registers freely, and can completely remove variables or expressions. Although the compiler never optimizes out an *asm* statement (except when it is unreachable), the surrounding environment where the assembly code is inserted can differ significantly from the original C/C++ source code.

It is usually safe to use *asm* statements to manipulate hardware controls such as interrupt masks, but *asm* statements that attempt to interface with the C/C++ environment or access C/C++ variables can have unexpected results. After compilation, check the assembly output to make sure your *asm* statements are correct and maintain the integrity of the program.

3.7.2 Use the *Volatile* Keyword for Necessary Memory Accesses

The compiler analyzes data flow to avoid memory accesses whenever possible. If you have code that depends on memory accesses exactly as written in the C/C++ code, you must use the *volatile* keyword to identify these accesses. The compiler does not optimize out any references to *volatile* variables.

In the following example, the loop waits for a location to be read as 0xFF:

```
unsigned int *ctrl;  
while (*ctrl !=0xFF);
```

In this example, **ctrl* is a loop-invariant expression, so the loop is optimized down to a single memory read. To correct this, declare *ctrl* as:

```
volatile unsigned int *ctrl
```

3.7.2.1 Use Caution When Accessing Aliased Variables

Aliasing occurs when a single object can be accessed in more than one way, such as when two pointers point to the same object or when a pointer points to a named object. Aliasing can disrupt optimization because any indirect reference can refer to another object. The compiler analyzes the code to determine where aliasing can and cannot occur, then optimizes as much as possible while still preserving the correctness of the program. The compiler behaves conservatively.

The compiler assumes that if the address of a local variable is passed to a function, the function might change the local by writing through the pointer, but that it will not make its address available for use elsewhere after returning. For example, the called function cannot assign the local's address to a global variable or return it. In cases where this assumption is invalid, use the *-ma* compiler option to force the compiler to assume worst-case aliasing. In worst-case aliasing, any indirect reference (that is, using a pointer) can refer to such a variable.

3.7.2.2 Use the `--aliased_variables` Option to Indicate That the Following Technique Is Used

The compiler, when invoked with optimization, assumes that any variable whose address is passed as an argument to a function will not be subsequently modified by an alias set up in the called function.

Examples include:

- Returning the address from a function
- Assigning the address to a global

If you use aliases like this in your code, you must use the `--aliased_variables` option when you are optimizing your code. For example, if your code is similar to this, use the `--aliased_variables` option:

```
int *glob_ptr;

g()
{
    int x = 1;
    int *p = f(&x);

    *p      = 5; /* p aliases x      */
    *glob_ptr = 10; /* glob_ptr aliases x */

    h(x);
}

int *f(int *arg)
{
    glob_ptr = arg;
    return arg;
}
```

3.7.2.3 On FPU Targets Only: Use `restrict` Keyword to Indicate That Pointers Are Not Aliased

On FPU targets, with `--opt_level=2`, the optimizer performs dependency analysis. To help the compiler determine memory dependencies, you can qualify a pointer, reference, or array with the `restrict` keyword. The `restrict` keyword is a type qualifier that can be applied to pointers, references, and arrays. Its use represents a guarantee by the programmer that within the scope of the pointer declaration the object pointed to can be accessed only by that pointer. Any violation of this guarantee renders the program undefined. This practice helps the compiler optimize certain sections of code because aliasing information can be more easily determined. This can improve performance and code size, as more FPU operations can be parallelized.

As shown in [Example 3-1](#) and [Example 3-2](#) you can use the `restrict` keyword to tell the compiler that `a` and `b` never point to the same object in `foo`. Furthermore, the compiler is assured that the objects pointed to by `a` and `b` do not overlap in memory.

Example 3-1. Use of the `restrict` Type Qualifier With Pointers

```
void foo(float * restrict a, float * restrict b)
{
    /* foo's code here */
}
```

Example 3-2. Use of the `restrict` Type Qualifier With Pointers

```
void foo(float c[restrict], float d[restrict])
{
    /* foo's code here */
}
```

3.8 Automatic Inline Expansion (--auto_inline Option)

When optimizing with the `--opt_level=3` option (aliased as `-O3`), the compiler automatically inlines small functions. A command-line option, `--auto_inline=size`, specifies the size threshold. Any function larger than the `size` threshold is not automatically inlined. You can use the `--auto_inline=size` option in the following ways:

- If you set the `size` parameter to 0 (`--auto_inline=0`), automatic inline expansion is disabled.
- If you set the `size` parameter to a nonzero integer, the compiler uses this size threshold as a limit to the size of the functions it automatically inlines. The compiler multiplies the number of times the function is inlined (plus 1 if the function is externally visible and its declaration cannot be safely removed) by the size of the function.

The compiler inlines the function only if the result is less than the size parameter. The compiler measures the size of a function in arbitrary units; however, the optimizer information file (created with the `--gen_opt_level=1` or `--gen_opt_level=2` option) reports the size of each function in the same units that the `--auto_inline` option uses.

The `--auto_inline=size` option controls only the inlining of functions that are not explicitly declared as inline. If you do not use the `--auto_inline=size` option, the compiler inlines very small functions.

Optimization Level 3 and Inlining

NOTE: In order to turn on automatic inlining, you must use the `--opt_level=3` option. If you desire the `--opt_level=3` optimizations, but not automatic inlining, use `--auto_inline=0` with the `--opt_level=3` option.

Inlining and Code Size

NOTE: Expanding functions inline increases code size, especially inlining a function that is called in a number of places. Function inlining is optimal for functions that are called only from a small number of places and for small functions. To prevent increases in code size because of inlining, use the `--auto_inline=0` option. This option causes the compiler to inline intrinsics only.

3.9 Using the Interlist Feature With Optimization

You control the output of the interlist feature when compiling with optimization (the `--opt_level=n` or `-On` option) with the `--optimizer_interlist` and `--c_src_interlist` options.

- The `--optimizer_interlist` option interlists compiler comments with assembly source statements.
- The `--c_src_interlist` and `--optimizer_interlist` options together interlist the compiler comments and the original C/C++ source with the assembly code.

When you use the `--optimizer_interlist` option with optimization, the interlist feature does *not* run as a separate pass. Instead, the compiler inserts comments into the code, indicating how the compiler has rearranged and optimized the code. These comments appear in the assembly language file as comments starting with `;**`. The C/C++ source code is not interlisted, unless you use the `--c_src_interlist` option also.

The interlist feature can affect optimized code because it might prevent some optimization from crossing C/C++ statement boundaries. Optimization makes normal source interlisting impractical, because the compiler extensively rearranges your program. Therefore, when you use the `--optimizer_interlist` option, the compiler writes reconstructed C/C++ statements.

[Example 3-4](#) shows a function that has been compiled with optimization (`--opt_level=2`) and the `--optimizer_interlist` option. The assembly file contains compiler comments interlisted with assembly code.

Impact on Performance and Code Size

NOTE: The `--c_src_interlist` option can have a negative effect on performance and code size.

When you use the `--c_src_interlist` and `--optimizer_interlist` options with optimization, the compiler inserts its comments and the interlist feature runs before the assembler, merging the original C/C++ source into the assembly file.

[Example 3-5](#) shows the function from [Example 3-4](#) compiled with the optimization (`--opt_level=2`) and the `-c_src_interlist` and `--optimizer_interlist` options. The assembly file contains compiler comments and C source interlisted with assembly code.

Example 3-3. C Code for Interlist Illustration

```
int copy (char *str, const char *s, int n)
{
    int i;

    for (i = 0; i < n; i ++)
        *str++ = *s++;
}
```

Example 3-4. The Function From [Example 3-3](#) Compiled With the `-O2` and `--optimizer_interlist` Options

```
*****
;* FNAME: _copy                FR SIZE: 0          *
;*                               *
;* FUNCTION ENVIRONMENT        *
;*                               *
;* FUNCTION PROPERTIES         *
;*                               0 Parameter, 0 Auto, 0 SOE *
;*****

_copy:
;*** 6 ----- if ( n <= 0 ) goto g4;
    CMPB    AL,#0                ; |6|
    B      L2,LEQ                ; |6|
    ; branch occurs ; |6|
;*** ----- #pragma MUST_ITERATE(1, 4294967295, 1)
;*** ----- L$1 = n-1;
    ADDB    AL,#-1
    MOVZ    AR6,AL
L1:
;*** -----g3:
;*** 7 ----- *str++ = *s++;
;*** 7 ----- if ( (--L$1) != (-1) ) goto g3;
    MOV     AL,*XAR5++           ; |7|
    MOV     *XAR4++,AL          ; |7|
    BANZ    L1,AR6--
    ; branch occurs ; |7|
;*** -----g4:
;*** ----- return;
L2:
    LRETR
    ; return occurs
```

Example 3-5. The Function From Example 3-3 Compiled with the --opt_level=2, --optimizer_interlist, and -c_src_interlist Options

```

;-----
; 2 | int copy (char *str, const char *s, int n)
;-----
;*****
;* FNAME: _copy                FR SIZE: 0          *
;*                               *
;* FUNCTION ENVIRONMENT        *
;*                               *
;* FUNCTION PROPERTIES         *
;* FUNCTION PROPERTIES         *
;*                               *
;*                               0 Parameter, 0 Auto, 0 SOE *
;*****

_copy
;* AR4  assigned to _str
;* AR5  assigned to _s
;* AL   assigned to _n
;* AL   assigned to _n
;* AR5  assigned to _s
;* AR4  assigned to _str
;* AR6  assigned to L$1
;*** 6  -----          if ( n <= 0 ) goto g4;
;-----
; 4 | int i;
;-----
;-----
; 6 | for ( i = 0; i < n; i++)
;-----
      CMPB    AL,#0                ; |6|
      B      L2,LEQ                ; |6|
      ; branch occurs ; |6|
;*** -----          #pragma MUST_ITERATE(1, 4294967295, 1)
;*** -----          L$1 = n-1;
      ADDB    AL,#-1
      MOVZ    AR6,AL
      NOP
L1:
;*** 7  -----          *str++ = *s++;
;*** 7  -----          if ( (--L$1) != (-1) ) goto g3;
;-----
; 7 | *str++ = *s++;
;-----
      MOV     AL,*XAR5++           ; |7|
      MOV     *XAR4++,AL          ; |7|
      BANZ    L1,AR6--
      ; branch occurs ; |7|
;*** -----          -g4:
;*** -----          return;
L2:
      LRETR
      ; return occurs
    
```

3.10 Data Page (DP) Pointer Load Optimization

By default, the compiler performs data page load optimization. The compiler blocks global variables by either forcing them to fit within a 64-word data page or aligning the start to a page boundary. Data page blocking allows the compiler to use the direct addressing mode more often. As a result, it minimizes the need for DP load instructions when accessing global variables known to be stored on a single data page.

However, the data page blocking optimization can result in unused holes within data sections. You can weigh your application's need for code size and speed optimization against its need for data size optimization. If you determine that you want to disable data page load optimization, use the `--disable_dp_load_opt` compiler option. Another technique for managing how global variables are organized in memory include grouping global variables that should be stored together in a structure. The `DATA_SECTION` and `SET_DATA_SECTION` pragmas can also be used to manage data pages.

For more details about and examples of data blocking, see the [Tools Insider blog in TI's E2E community](#).

3.11 Debugging and Profiling Optimized Code

Generating symbolic debugging information no longer affects the ability to optimize code. The same executable code is generated regardless of whether generation of debug information is turned on or off. For this reason, debug information is now generated by default. You do not need to specify the `-g` option in order to debug your application.

If you do not specify the `-g` option and allow the default generation of debug information to be used, the default level of optimization is used unless you specify some other optimization level.

The `--symdebug:dwarf` option no longer disables optimization, because generation of debug information no longer impacts optimization.

If you specify the `-g` option explicitly but do not specify an optimization level, no optimization is performed. This is because while generating debug information does not affect the ability to optimize code, optimizing code does make it more difficult to debug code. At higher levels of optimization, the compiler's extensive rearrangement of code and the many-to-many allocation of variables to registers often make it difficult to correlate source code with object code for debugging purposes. It is recommended that you perform debugging using the lowest level of optimization possible.

If you specify an `--opt_level` (aliased as `-O`) option, that optimization level is used no matter what type of debugging information you enabled.

The optimization level used if you do not specify the level on the command line is affected by whether or not the command line includes the `-g` option and the `--opt_level` option as shown in the following table:

Table 3-6. Interaction Between Debugging and Optimization Options

Optimization	no -g	-g
no <code>--opt_level</code>	<code>--opt_level=off</code>	<code>--opt_level=off</code>
<code>--opt_level</code>	<code>--opt_level=2</code>	<code>--opt_level=2</code>
<code>--opt_level=n</code>	optimized as specified	optimized as specified

Debug information increases the size of object files, but it does not affect the size of code or data on the target. If object file size is a concern and debugging is not needed, use `--symdebug:none` to disable the generation of debug information.

3.11.1 Profiling Optimized Code

To profile optimized code, use optimization (`--opt_level=0` through `--opt_level=3`).

3.12 Controlling Code Size Versus Speed

The latest mechanism for controlling the goal of optimizations in the compiler is represented by the `--opt_for_speed=num` option. The *num* denotes the level of optimization (0-5), which controls the type and degree of code size or code speed optimization:

- `--opt_for_speed=0`
Enables optimizations geared towards improving the code size with a *high* risk of worsening or impacting performance.
- `--opt_for_speed=1`
Enables optimizations geared towards improving the code size with a *medium* risk of worsening or impacting performance.
- `--opt_for_speed=2`
Enables optimizations geared towards improving the code size with a *low* risk of worsening or impacting performance.
- `--opt_for_speed=3`
Enables optimizations geared towards improving the code performance/speed with a *low* risk of worsening or impacting code size.
- `--opt_for_speed=4`
Enables optimizations geared towards improving the code performance/speed with a *medium* risk of worsening or impacting code size.
- `--opt_for_speed=5`
Enables optimizations geared towards improving the code performance/speed with a *high* risk of worsening or impacting code size.

If you specify the `--opt_for_speed` option without a parameter, the default setting is `--opt_for_speed=4`. If you do not specify the `--opt_for_speed` option, the default setting is 2

The initial mechanism for controlling code space, the `--opt_for_space` option, has the following equivalences with the `--opt_for_speed` option:

<code>--opt_for_space</code>	<code>--opt_for_speed</code>
none	=4
=0	=3
=1	=2
=2	=1
=3	=0

A fast branch (BF) instruction is generated by default when the `--opt_for_speed` option is used. When `--opt_for_speed` is not used, the compiler generates a BF instruction only when the condition code is one of NEQ, EQ, NTC and TC. The reason is that BF with these condition codes can be optimized to SBF. There is a code size penalty to use BF instruction when the condition code is NOT one of NEQ, EQ, NTC and TC. (Fast branch instructions are also generated for functions with the `ramfunc` function attribute.)

The `--no_fast_branch` option is deprecated and has no effect.

3.13 Increasing Code-Size Optimizations (--opt_for_space Option)

The `--opt_for_space` option increases the level of code-size optimizations performed by the compiler. These optimizations are done at the expense of performance. The optimizations include procedural abstraction where common blocks of code are replaced with function calls. For example, prolog and epilog code, certain intrinsics, and other common code sequences, can be replaced with calls to functions that are defined in the run-time library. It is necessary to link with the supplied run-time library when using the `--opt_for_space` option. It is not necessary to use optimization to invoke the `--opt_for_space` option.

To illustrate how the `--opt_for_space` option works, the following describes how prolog and epilog code can be replaced. This code is changed to function calls depending on the number of SOE registers, the size of the frame, and whether a frame pointer is used. These functions are defined in each file with the `--opt_for_space` option, as shown below:

```
_prolog_c28x_1
_prolog_c28x_2
_prolog_c28x_3
_epilog_c28x_1
_epilog_c28x_2
```

[Example 3-6](#) provides an example of C code to be compiled with the `--opt_for_space` option. The resulting output is shown in [Example 3-7](#).

Example 3-6. C Code to Show Code-Size Optimizations

```
extern int x, y, *ptr;
extern int foo();

int main(int a, int b, int c)
{
    ptr[50] = foo();
    y = ptr[50] + x + y + a + b + c;
}
```

Example 3-7. Example 3-6 Compiled With the --opt_for_space Option

```

FP      .set      XAR2
        .global  _prolog_c28x_1
        .global  _prolog_c28x_2
        .global  _prolog_c28x_3
        .global  _epilog_c28x_1
        .global  _epilog_c28x_2
        .sect   ".text"
        .global  _main

;*****
;* FNAME: _main          FR SIZE:   6          *
;*                      *                    *
;* FUNCTION ENVIRONMENT *                    *
;*                      *                    *
;* FUNCTION PROPERTIES  *                    *
;*                      *                    *
;*                      0 Parameter, 0 Auto, 6 SOE *
;*****

_main:

        FFC      XAR7,_prolog_c28x_1
        MOVZ     AR3,AR4          ; |5|
        MOVZ     AR2,AH          ; |5|
        MOVZ     AR1,AL          ; |5|
        LCR      #_foo           ; |6|
        ; call occurs [#_foo] ; |6|
        MOVW     DP,#_ptr
        MOVL     XAR6,@_ptr      ; |6|
        MOVB     XAR0,#50        ; |6|
        MOVW     DP,#_y
        MOV      *+XAR6[AR0],AL  ; |6|
        MOV      AH,@_y          ; |7|
        MOVW     DP,#_x
        ADD      AH,AL           ; |7|
        ADD      AH,@_x          ; |7|
        ADD      AH,AR3          ; |7|
        ADD      AH,AR1          ; |7|
        ADD      AH,AR2          ; |7|
        MOVB     AL,#0
        MOVW     DP,#_y
        MOV      @_y,AH          ; |7|
        FFC      XAR7,_epilog_c28x_1
        LRETR
        ; return occurs
    
```

3.14 Compiler Support for Generating DMAC Instructions

The C28x compiler supports DMAC instructions, which perform multiply-accumulate operations on two adjacent signed integers at the same time, optionally shifting the products. A multiply-accumulate operation multiplies two numbers and adds that product to an accumulator. That is, it computes $a = a + (b \times c)$. There are three levels of DMAC support that require different levels of C-source modification:

- Generate DMAC instructions automatically from C code (see [Section 3.14.1](#)).
- Use assertions for data address alignment to enable DMAC instruction generation (see [Section 3.14.2](#)).
- Use the `__dmac` intrinsic (see [Section 3.14.3](#)).

3.14.1 Automatic Generation of DMAC Instructions

The compiler automatically generates DMAC instructions if the compiler recognizes the C-language statements as a DMAC opportunity and the compiler can verify that the data addresses being operated upon are 32-bit aligned. This is the best scenario, because it requires no code modification aside from data alignment pragmas. The following is an example:

```
int src1[N], src2[N];
#pragma DATA_ALIGN(src1,2);           // int arrays must be 32-bit aligned
#pragma DATA_ALIGN(src2,2);

{...}
int i;
long res = 0;

for (i = 0; i < N; i++)                // N must be a known even constant
    res += (long)src1[i] * src2[i];    // Arrays must be accessed via array indices
```

At optimization levels $\geq -O2$, the compiler generates a RPT || DMAC instruction for the example code above if N is a known even constant.

DMAC instructions can also shift the product left by 1 or right by 1 to 6 before accumulation. For example:

```
for (i = 0; i < N; i++)
    res += (long)src1[i] * src2[i] >> 1; // product shifted right by 1
```

3.14.2 Assertions to Specify Data Address Alignment

In some cases the compiler may recognize a DMAC opportunity in C-language statements but not be able to verify that the data addresses passed to the computation are both 32-bit aligned. In this case, assertions placed in the code can enable the compiler to generate DMAC instructions. The following is an example:

```
int *src1, *src2; // src1 and src2 are pointers to int arrays of at least size N
                // You must ensure that both are 32-bit aligned addresses

{...}
int i;
long res = 0;

_nassert((long)src1 % 2 == 0);
_nassert((long)src2 % 2 == 0);

for (i = 0; i < N; i++)                // N must be a known even constant
    res += (long)src1[i] * src2[i]; // src1 and src2 must be accessed via array indices
```

At optimization levels $\geq -O2$, the compiler generates a RPT || DMAC instruction for the example code above if N is a known even constant.

The `_nassert` intrinsic generates no code and so is not a compiler intrinsic like those listed in [Table 7-6](#). Instead, it tells the optimizer that the expression declared with the `assert` function is true. This can be used to give hints to the optimizer about what optimizations might be valid. In this example, `_nassert` is used to assert that the data addresses represented by the `src1` and `src2` pointers are 32-bit aligned. You are responsible for ensuring that only 32-bit aligned data addresses are passed via these pointers. The code will result in a run-time failure if the asserted conditions are not true.

DMAC instructions can also shift the product left by 1 or right by 1 to 6 before accumulation. For example:

```
for (i = 0; i < N; i++)
    res += (long)src1[i] * src2[i] >> 1; // product shifted right by 1
```

3.14.3 `__dmac` Intrinsic

You can force the compiler to generate a DMAC instruction by using the `__dmac` intrinsic. In this case, you are fully responsible for ensuring that the data addresses are 32-bit aligned.

```
void __dmac(long *src1, long *src2, long &accum1, long &accum2, int shift);
```

- `Src1` and `src2` must be 32-bit aligned addresses that point to int arrays.
- `Accum1` and `accum2` are pass-by-reference longs for the two temporary accumulations. These must be added together after the intrinsic to compute the total sum.
- `Shift` specifies how far to shift the products prior to each accumulation. Valid shift values are -1 for a left shift by 1, 0 for no shift, and 1-6 for a right shift by 1-6, respectively. Note that this argument is required, so you must pass 0 if you want no shift.

See [Table 7-6](#) for details about the `__dmac` intrinsic.

Example 1:

```
int src1[2N], src2[2N]; // src1 and src2 are int arrays of at least size 2N
                        // You must ensure that both start on 32-bit
                        // aligned boundaries.
{...}
int i;
long res = 0;
long temp = 0;

for (i=0; i < N; i++) // N does not have to be a known constant
    __dmac((long *)src1[i], ((long *)src2)[i], res, temp, 0);

res += temp;
```

Example 2:

```
int *src1, *src2; // src1 and src2 are pointers to int arrays of at
                 // least size 2N. User must ensure that both are
                 // 32-bit aligned addresses.
{...}
int i;
long res = 0;
long temp = 0;

long *ls1 = (long *)src1;
long *ls2 = (long *)src2;

for (i=0; i < N; i++) // N does not have to be a known constant
    __dmac(*ls1++, *ls2++, res, temp, 0);

res += temp;
```

In these examples, `res` holds the final sum of a multiply-accumulate operation on int arrays of length $2*N$, with two computations being performed at a time.

Additionally, an optimization level $\geq -O2$ must be used to generate efficient code. Moreover, if there is nothing else in the loop body as in these examples, the compiler generates a RPT || DMAC instruction, further improving performance.

3.15 What Kind of Optimization Is Being Performed?

The TMS320C28x C/C++ compiler uses a variety of optimization techniques to improve the execution speed of your C/C++ programs and to reduce their size.

Following are some of the optimizations performed by the compiler:

Optimization	See
Cost-based register allocation	Section 3.15.1
Alias disambiguation	Section 3.15.1
Branch optimizations and control-flow simplification	Section 3.15.3
Data flow optimizations <ul style="list-style-type: none"> • Copy propagation • Common subexpression elimination • Redundant assignment elimination 	Section 3.15.4
Expression simplification	Section 3.15.5
Inline expansion of functions	Section 3.15.6
Function Symbol Aliasing	Section 3.15.7
Induction variable optimizations and strength reduction	Section 3.15.8
Loop-invariant code motion	Section 3.15.9
Loop rotation	Section 3.15.10
Instruction scheduling	Section 3.15.11

C28x-Specific Optimization	See
Register variables	Section 3.15.12
Register tracking/targeting	Section 3.15.13
Tail merging	Section 3.15.14
Autoincrement addressing	Section 3.15.15
Removing comparisons to zero	Section 3.15.16
RPTB generation (for FPU targets only)	Section 3.15.17

3.15.1 Cost-Based Register Allocation

The compiler, when optimization is enabled, allocates registers to user variables and compiler temporary values according to their type, use, and frequency. Variables used within loops are weighted to have priority over others, and those variables whose uses do not overlap can be allocated to the same register.

Induction variable elimination and loop test replacement allow the compiler to recognize the loop as a simple counting loop and unroll or eliminate the loop. Strength reduction turns the array references into efficient pointer references with autoincrements.

3.15.2 Alias Disambiguation

C and C++ programs generally use many pointer variables. Frequently, compilers are unable to determine whether or not two or more l values (lowercase L: symbols, pointer references, or structure references) refer to the same memory location. This aliasing of memory locations often prevents the compiler from retaining values in registers because it cannot be sure that the register and memory continue to hold the same values over time.

Alias disambiguation is a technique that determines when two pointer expressions cannot point to the same location, allowing the compiler to freely optimize such expressions.

3.15.3 Branch Optimizations and Control-Flow Simplification

The compiler analyzes the branching behavior of a program and rearranges the linear sequences of operations (basic blocks) to remove branches or redundant conditions. Unreachable code is deleted, branches to branches are bypassed, and conditional branches over unconditional branches are simplified to a single conditional branch.

When the value of a condition is determined at compile time (through copy propagation or other data flow analysis), the compiler can delete a conditional branch. Switch case lists are analyzed in the same way as conditional branches and are sometimes eliminated entirely. Some simple control flow constructs are reduced to conditional instructions, totally eliminating the need for branches.

3.15.4 Data Flow Optimizations

Collectively, the following data flow optimizations replace expressions with less costly ones, detect and remove unnecessary assignments, and avoid operations that produce values that are already computed. The compiler with optimization enabled performs these data flow optimizations both locally (within basic blocks) and globally (across entire functions).

- **Copy propagation.** Following an assignment to a variable, the compiler replaces references to the variable with its value. The value can be another variable, a constant, or a common subexpression. This can result in increased opportunities for constant folding, common subexpression elimination, or even total elimination of the variable.
- **Common subexpression elimination.** When two or more expressions produce the same value, the compiler computes the value once, saves it, and reuses it.
- **Redundant assignment elimination.** Often, copy propagation and common subexpression elimination optimizations result in unnecessary assignments to variables (variables with no subsequent reference before another assignment or before the end of the function). The compiler removes these dead assignments.

3.15.5 Expression Simplification

For optimal evaluation, the compiler simplifies expressions into equivalent forms, requiring fewer instructions or registers. Operations between constants are folded into single constants. For example, $a = (b + 4) - (c + 1)$ becomes $a = b - c + 3$.

3.15.6 Inline Expansion of Functions

The compiler replaces calls to small functions with inline code, saving the overhead associated with a function call as well as providing increased opportunities to apply other optimizations.

3.15.7 Function Symbol Aliasing

The compiler recognizes a function whose definition contains only a call to another function. If the two functions have the same signature (same return value and same number of parameters with the same type, in the same order), then the compiler can make the calling function an alias of the called function.

For example, consider the following:

```
int bbb(int arg1, char *arg2);

int aaa(int n, char *str)
{
    return bbb(n, str);
}
```

For this example, the compiler makes `aaa` an alias of `bbb`, so that at link time all calls to function `aaa` should be redirected to `bbb`. If the linker can successfully redirect all references to `aaa`, then the body of function `aaa` can be removed and the symbol `aaa` is defined at the same address as `bbb`.

For information about using the GCC function attribute syntax to declare function aliases, see [Section 6.14.2](#)

3.15.8 Induction Variables and Strength Reduction

Induction variables are variables whose value within a loop is directly related to the number of executions of the loop. Array indices and control variables for loops are often induction variables.

Strength reduction is the process of replacing inefficient expressions involving induction variables with more efficient expressions. For example, code that indexes into a sequence of array elements is replaced with code that increments a pointer through the array.

Induction variable analysis and strength reduction together often remove all references to your loop-control variable, allowing its elimination.

3.15.9 Loop-Invariant Code Motion

This optimization identifies expressions within loops that always compute to the same value. The computation is moved in front of the loop, and each occurrence of the expression in the loop is replaced by a reference to the precomputed value.

3.15.10 Loop Rotation

The compiler evaluates loop conditionals at the bottom of loops, saving an extra branch out of the loop. In many cases, the initial entry conditional check and the branch are optimized out.

3.15.11 Instruction Scheduling

The compiler performs instruction scheduling, which is the rearranging of machine instructions in such a way that improves performance while maintaining the semantics of the original order. Instruction scheduling is used to improve instruction parallelism and hide latencies. It can also be used to reduce code size.

3.15.12 Register Variables

The compiler helps maximize the use of registers for storing local variables, parameters, and temporary values. Accessing variables stored in registers is more efficient than accessing variables in memory. Register variables are particularly effective for pointers.

3.15.13 Register Tracking/Targeting

The compiler tracks the contents of registers to avoid reloading values if they are used again soon. Variables, constants, and structure references such as (a.b) are tracked through straight-line code. Register targeting also computes expressions directly into specific registers when required, as in the case of assigning to register variables or returning values from functions.

3.15.14 Tail Merging

If you are optimizing for code size, tail merging can be very effective for some functions. Tail merging finds basic blocks that end in an identical sequence of instructions and have a common destination. If such a set of blocks is found, the sequence of identical instructions is made into its own block. These instructions are then removed from the set of blocks and replaced with branches to the newly created block. Thus, there is only one copy of the sequence of instructions, rather than one for each block in the set.

3.15.15 Autoincrement Addressing

For pointer expressions of the form *p++, the compiler uses efficient C28x autoincrement addressing modes. In many cases, where code steps through an array in a loop such as below, the loop optimizations convert the array references to indirect references through autoincremented register variable pointers.

```
for (I = 0; I <N; ++I) a(I)...
```

3.15.16 Removing Comparisons to Zero

Because most of the 32-bit instructions and some of the 16-bit instructions can modify the status register when the result of their operation is 0, explicit comparisons to 0 may be unnecessary. The C28x C/C++ compiler removes comparisons to 0 if a previous instruction can be modified to set the status register appropriately.

3.15.17 RPTB Generation (for FPU Targets Only)

When the target has hardware floating-point support, some loops can be converted to hardware loops called repeat blocks (RPTB). Normally, a loop looks like this:

```
Label:  
    ...loop body...  
    SUB loop_count  
    CMP  
    B    Label
```

The same loop, when converted to a RPTB loop, looks like this:

```
RPTB    end_label, loop_count  
    ...loop body...  
end_label:
```

A repeat block loop is loaded into a hardware buffer and executed for the specified number of iterations. This kind of loop has minimal or zero branching overhead, and can improve performance. The loop count is stored in a special register RB (repeat block register), and the hardware seamlessly decrements the count without any explicit subtractions. Thus, there is no overhead due to the subtract, the compare, and the branch. The only overhead is due to the RPTB instruction that executes once before the loop. The RPTB instruction takes one cycle if the number of iterations is a constant, and 4 cycles otherwise. This overhead is incurred once per loop.

There are limitations on the minimum and maximum loop size for a loop to qualify for becoming a repeat block, due to the presence of the buffer. Also, the loop cannot contain any inner loops or function calls.

Linking C/C++ Code

The C/C++ compiler and assembly language tools provide two methods for linking your programs:

- You can compile individual modules and link them together. This method is especially useful when you have multiple source files.
- You can compile and link in one step. This method is useful when you have a single source module.

This chapter describes how to invoke the linker with each method. It also discusses special requirements of linking C/C++ code, including the run-time-support libraries, specifying the type of initialization, and allocating the program into memory. For a complete description of the linker, see the *TMS320C28x Assembly Language Tools User's Guide*.

Topic	Page
4.1 Invoking the Linker Through the Compiler (-z Option)	82
4.2 Linker Code Optimizations	84
4.3 Controlling the Linking Process.....	84
4.4 Linking C28x and C2XLP Code	89

4.1 Invoking the Linker Through the Compiler (-z Option)

This section explains how to invoke the linker after you have compiled and assembled your programs: as a separate step or as part of the compile step.

4.1.1 Invoking the Linker Separately

This is the general syntax for linking C/C++ programs as a separate step:

```
cl2000 --run_linker {--rom_model | --ram_model} filenames
      [options] [--output_file= name.out] --library= library [Ink.cmd]
```

cl2000 --run_linker	The command that invokes the linker.
--rom_model --ram_model	Options that tell the linker to use special conventions defined by the C/C++ environment. When you use <code>cl2000 --run_linker</code> , you must use --rom_model or --ram_model . The <code>--rom_model</code> option uses automatic variable initialization at run time; the <code>--ram_model</code> option uses variable initialization at load time.
<i>filenames</i>	Names of object files, linker command files, or archive libraries. The default extension for all input files is <code>.obj</code> ; any other extension must be explicitly specified. The linker can determine whether the input file is an object or ASCII file that contains linker commands. The default output filename is <code>a.out</code> , unless you use the <code>--output_file</code> option to name the output file.
<i>options</i>	Options affect how the linker handles your object files. Linker options can only appear after the --run_linker option on the command line, but otherwise may be in any order. (Options are discussed in detail in the <i>TMS320C28x Assembly Language Tools User's Guide</i> .)
--output_file= name.out	Names the output file.
--library= library	Identifies the appropriate archive library containing C/C++ run-time-support and floating-point math functions, or linker command files. If you are linking C/C++ code, you must use a run-time-support library. You can use the libraries included with the compiler, or you can create your own run-time-support library. If you have specified a run-time-support library in a linker command file, you do not need this parameter. The <code>--library</code> option's short form is <code>-l</code> .
<i>Ink.cmd</i>	Contains options, filenames, directives, or commands for the linker.

When you specify a library as linker input, the linker includes and links only those library members that resolve undefined references. The linker uses a default allocation algorithm to allocate your program into memory. You can use the `MEMORY` and `SECTIONS` directives in the linker command file to customize the allocation process. For information, see the *TMS320C28x Assembly Language Tools User's Guide*.

You can link a C/C++ program consisting of object files `prog1.obj`, `prog2.obj`, and `prog3.obj`, with an executable object file filename of `prog.out` with the command:

```
cl2000 --run_linker --rom_model prog1 prog2 prog3
      --output_file=prog.out --library=rts2800_ml.lib
```

4.1.2 Invoking the Linker as Part of the Compile Step

This is the general syntax for linking C/C++ programs as part of the compile step:

```
cl2000 filenames [options] --run_linker {--rom_model | --ram_model} filenames
      [options] [--output_file= name.out] --library= library [Ink.cmd]
```

The `--run_linker` option divides the command line into the compiler options (the options before `--run_linker`) and the linker options (the options following `--run_linker`). The `--run_linker` option must follow all source files and compiler options on the command line.

All arguments that follow `--run_linker` on the command line are passed to the linker. These arguments can be linker command files, additional object files, linker options, or libraries. These arguments are the same as described in [Section 4.1.1](#).

All arguments that precede `--run_linker` on the command line are compiler arguments. These arguments can be C/C++ source files, assembly files, or compiler options. These arguments are described in [Section 2.2](#).

You can compile and link a C/C++ program consisting of object files `prog1.c`, `prog2.c`, and `prog3.c`, with an executable object file filename of `prog.out` with the command:

```
cl2000 prog1.c prog2.c prog3.c --run_linker --rom_model --output_file=prog.out
      --library=rts2800_ml.lib
```

NOTE: Order of Processing Arguments in the Linker

The order in which the linker processes arguments is important. The compiler passes arguments to the linker in the following order:

1. Object filenames from the command line
 2. Arguments following the `--run_linker` option on the command line
 3. Arguments following the `--run_linker` option from the `C2000_C_OPTION` environment variable
-

4.1.3 Disabling the Linker (--compile_only Compiler Option)

You can override the `--run_linker` option by using the `--compile_only` compiler option. The `--run_linker` option's short form is `-z` and the `--compile_only` option's short form is `-c`.

The `--compile_only` option is especially helpful if you specify the `--run_linker` option in the `C2000_C_OPTION` environment variable and want to selectively disable linking with the `--compile_only` option on the command line.

4.2 Linker Code Optimizations

4.2.1 Generating Function Subsections (`--gen_func_subsections` Compiler Option)

The compiler translates a source module into an object file. It may place all of the functions into a single code section, or it may create multiple code sections. The benefit of multiple code sections is that the linker may omit unused functions from the executable.

When the linker collects code to be placed into an executable file, it cannot split code sections. If the compiler did not use multiple code sections, and any function in a particular module needs to be linked into the executable, then all functions in that module are linked in, even if they are not used.

An example is a library .obj file that contains a signed divide routine and an unsigned divide routine. If the application requires only signed division, then only the signed divide routine is required for linking. If only one code section was used, both the signed and unsigned routines are linked in since they exist in the same .obj file.

The `--gen_func_subsections` compiler option remedies this problem by placing each function in a file in its own subsection. Thus, only the functions that are referenced in the application are linked into the final executable. This can result in an overall code size reduction.

4.2.2 Generating Aggregate Data Subsections (`--gen_data_subsections` Compiler Option)

Similarly to code sections described in the previous section, data can either be placed in a single section or multiple sections. The benefit of multiple data sections is that the linker may omit unused data structures from the executable. By default, the `--gen_data_subsections` option is on. This option causes aggregate data—arrays, structs, and unions—to be placed in separate subsections of the data section.

4.3 Controlling the Linking Process

Regardless of the method you choose for invoking the linker, special requirements apply when linking C/C++ programs. You must:

- Include the compiler's run-time-support library
- Specify the type of boot-time initialization
- Determine how you want to allocate your program into memory

This section discusses how these factors are controlled and provides an example of the standard default linker command file. For more information about how to operate the linker, see the linker description in the *TMS320C28x Assembly Language Tools User's Guide*

4.3.1 Including the Run-Time-Support Library

You must link all C/C++ programs with a run-time-support library. The library contains standard C/C++ functions as well as functions used by the compiler to manage the C/C++ environment. The following sections describe two methods for including the run-time-support library.

4.3.1.1 Automatic Run-Time-Support Library Selection

The linker assumes you are using the C and C++ conventions if either the `--rom_model` or `--ram_model` linker option is specified, or if the link step includes the compile step for a C or C++ file, or if you link against the index library `libc.a`.

If the linker assumes you are using the C and C++ conventions and the entry point for the program (normally `c_int00`) is not resolved by any specified object file or library, the linker attempts to automatically include the most compatible run-time-support library for your program. The run-time-support library chosen by the compiler is searched after any other libraries specified with the `--library` option on the command line or in the linker command file. If `libc.a` is explicitly used, the appropriate run-time-support library is included in the search order where `libc.a` is specified.

You can disable the automatic selection of a run-time-support library by using the `--disable_auto_rts` option.

If the `--issue_remarks` option is specified before the `--run_linker` option during the linker, a remark is generated indicating which run-time support library was linked in. If a different run-time-support library is desired than the one reported by `--issue_remarks`, you must specify the name of the desired run-time-support library using the `--library` option and in your linker command files when necessary.

Example 4-1. Using the `--issue_remarks` Option

```
cl2000 --issue_remarks main.c --run_linker --rom_model

<Linking>
remark: linking in "libc.a"
remark: linking in "rts2800_ml.lib" in place of "libc.a"
```

4.3.1.2 Manual Run-Time-Support Library Selection

You can bypass automatic library selection by explicitly specifying the desired run-time-support library to use. Use the `--library` linker option to specify the name of the library. The linker will search the path specified by the `--search_path` option and then the `C2000_C_DIR` environment variable for the named library. You can use the `--library` linker option on the command line or in a command file.

```
cl2000 --run_linker {--rom_model | --ram_model} filenames --library= libraryname
```

4.3.1.3 Library Order for Searching for Symbols

Generally, you should specify the run-time-support library as the last name on the command line because the linker searches libraries for unresolved references in the order that files are specified on the command line. If any object files follow a library, references from those object files to that library are not resolved. You can use the `--reread_libs` option to force the linker to reread all libraries until references are resolved. Whenever you specify a library as linker input, the linker includes and links only those library members that resolve undefined references.

By default, if a library introduces an unresolved reference and multiple libraries have a definition for it, then the definition from the same library that introduced the unresolved reference is used. Use the `--priority` option if you want the linker to use the definition from the first library on the command line that contains the definition.

4.3.2 Run-Time Initialization

You must link all C/C++ programs with code to initialize and execute the program called a bootstrap routine. The bootstrap routine is responsible for the following tasks:

1. Set up status and configuration registers
2. Set up the stack and secondary system stack
3. Process the `.cinit` run-time initialization table to autoinitialize global variables (when using the `--rom_model` option)
4. Call all global object constructors (`.pinit`)
5. Call the `main()` function
6. Call `exit()` when `main()` returns

NOTE: The `_c_int00` Symbol

If you use the `--ram_model` or `--rom_model` link option, `_c_int00` is automatically defined as the entry point for the program. Otherwise, an entry point is not automatically selected and you will receive a linker warning.

4.3.3 Initialization by the Interrupt Vector

If your C/C++ program begins running at RESET, you must set up the RESET vector to branch to a suitable bootstrap routine, such as `_c_int00`. You must also make sure the interrupt vectors are included in the project, typically by using the `--undef_sym` linker option to make a symbol at the start of the interrupt vector a root linker object.

A sample interrupt vector is provided in `vectors.obj` in `rts2800_ml.lib`. For C28x, the first few lines of the vector are:

```
.def _Reset
.ref _c_int00
_Reset: .vec _c_int00, USE_RETA
```

4.3.4 Global Object Constructors

Global C++ variables that have constructors and destructors require their constructors to be called during program initialization and their destructors to be called during program termination. The C++ compiler produces a table of constructors to be called at startup.

Constructors for global objects from a single module are invoked in the order declared in the source code, but the relative order of objects from different object files is unspecified.

Global constructors are called after initialization of other global variables and before the `main()` function is called. Global destructors are invoked during the exit run-time support function, similar to functions registered through `atexit`.

[Section 7.9.3.4](#) discusses the format of the global constructor table.

4.3.5 Specifying the Type of Global Variable Initialization

The C/C++ compiler produces data tables for initializing global variables. [Section 7.9.3.1](#) discusses the format of these initialization tables. The initialization tables are used in one of the following ways:

- Global variables are initialized at *run time*. Use the `--rom_model` linker option (see [Section 7.9.3.2](#)).
- Global variables are initialized at *load time*. Use the `--ram_model` linker option (see [Section 7.9.3.3](#)).

When you link a C/C++ program, you must use either the `--rom_model` or `--ram_model` option. These options tell the linker to select initialization at run time or load time. When you compile and link programs, the `--rom_model` option is the default. If used, the `--rom_model` option must follow the `--run_linker` option (see [Section 4.1](#)). The following list outlines the linking conventions used with `--rom_model` or `--ram_model`:

- The symbol `_c_int00` is defined as the program entry point; it identifies the beginning of the C/C++ boot routine in `boot.obj`. When you use `--rom_model` or `--ram_model`, `_c_int00` is automatically referenced, ensuring that `boot.obj` is automatically linked in from the run-time-support library.
- The initialization output section is padded with a termination record so that the loader (load-time initialization) or the boot routine (run-time initialization) knows when to stop reading the initialization tables.
- When initializing at load time (the `--ram_model` option), the following occur:
 - The linker sets the initialization table symbol to `-1`. This indicates that the initialization tables are not in memory, so no initialization is performed at run time.
 - The `STYP_COPY` flag is set in the initialization table section header. `STYP_COPY` is the special attribute that tells the loader to perform autoinitialization directly and not to load the initialization table into memory. The linker does not allocate space in memory for the initialization table.
- When autoinitializing at run time (`--rom_model` option), the linker defines the initialization table symbol as the starting address of the initialization table. The boot routine uses this symbol as the starting point for autoinitialization.

4.3.6 Specifying Where to Allocate Sections in Memory

The compiler produces relocatable blocks of code and data. These blocks, called *sections*, are allocated in memory in a variety of ways to conform to a variety of system configurations. See [Section 7.1.1](#) for a complete description of how the compiler uses these sections.

The compiler creates two basic kinds of sections: initialized and uninitialized. [Table 4-1](#) summarizes the initialized sections. [Table 4-2](#) summarizes the uninitialized sections.

Table 4-1. Initialized Sections Created by the Compiler

Name	Contents	Restrictions
.binit	Boot time copy tables (See the <i>Assembly Language Tools User's Guide</i> for information on BINIT in linker command files.)	
.cinit	Tables for explicitly initialized global and static variables.	Program
.econst	Global and static const variables that are explicitly initialized and contain string literals. String literals are placed in the .econst.string subsection to enable greater link-time placement control.	Anywhere in data
.pinit	Table of constructors to be called at startup.	Program
.switch	Jump tables for large switch statements.	Program with -mt option Data without -mt option
.text	Executable code and constants.	Program

Table 4-2. Uninitialized Sections Created by the Compiler

Name	Contents	Restrictions
.ebss	Global and static variables	Anywhere in data
.stack	Stack	Low 64K
.esysmem	Memory for malloc functions (heap)	Anywhere in data

When you link your program, you must specify where to allocate the sections in memory. In general, initialized sections are linked into ROM or RAM; uninitialized sections are linked into RAM. With the exception of .text, the initialized and uninitialized sections created by the compiler cannot be allocated into internal program memory.

The linker provides MEMORY and SECTIONS directives for allocating sections. For more information about allocating sections into memory, see the *TMS320C28x Assembly Language Tools User's Guide*.

4.3.7 A Sample Linker Command File

[Example 4-2](#) shows a typical linker command file that links a C program. The command file in this example is named `lnk.cmd`. It links three object files (`a.obj`, `b.obj`, and `c.obj`) and creates a program (`prog.out`) and a map file (`prog.map`).

To link the program, enter the following:

```
cl2000 --run_linker lnk.cmd
```

The `MEMORY` and possibly the `SECTIONS` directives, might require modification to work with your system. See the *TMS320C28x Assembly Language Tools User's Guide* for more information on these directives.

Example 4-2. Linker Command File

```
a.obj b.obj c.obj          /* Input filenames */
--output_file=prog.out    /* Options */
--map_file=prog.map
--library=rts2800_ml.lib  /* Get run-time support */

MEMORY                    /* MEMORY directive */
{
    RAM:  origin = 100h    length = 0100h
    ROM:  origin = 01000h length = 0100h
}

SECTIONS                  /* SECTIONS directive */
{
    .text:  > ROM
    .data:  > ROM
    .ebss:  > RAM
    .pinit: > ROM
    .cinit: > ROM
    .switch: > ROM
    .econst: > RAM
    .stack: > RAM
    .esysmem: > RAM
}
```

4.4 Linking C28x and C2XLP Code

The error in the C28x linker to prevent linking code with a 64-word page size (C28x) and a 128-word page size (C2XLP) has been changed to a warning. It is possible to call a C2XLP assembly function from C28x C/C++ code. One possible way is to replace the call to the C2XLP function with a veneer function that correctly sets up the arguments and call stack for the C2XLP code. For example, to make a call to a C2XLP function expecting five integer arguments, change the C28x code to:

```
extern void foo_veneer(int, int, int, int, int);
void bar()
{
    /* replace the C2XLP call with a veneer call */
    /* foo(1, 2, 3, 4, 5); */
    foo_veneer(1, 2, 3, 4, 5);
}
```

[Example 4-3](#) illustrates how the veneer function might look:

Example 4-3. Veneer Function for Linking C2xx and C2XLP Code

```
.sect ".text"
.global _foo_veneer
.global _foo
_veneer:
    ;save registers
    PUSH AR1:AR0
    PUSH AR3:AR2
    PUSH AR5:AR4

    ;set the size of the C2XLP frame (including args size)
    ADDB SP,#10

    ;push args onto the C2XLP frame
    MOV *-SP[10],AL ;copy arg 1
    MOV *-SP[9],AH ;copy arg 2
    MOV *-SP[8],AR4 ;copy arg 3
    MOV *-SP[7],AR5 ;copy arg 4
    MOV AL,*-SP[19]
    MOV *-SP[6],AL ;copy arg 5

    ;save the return address
    MOV *-SP[5],#_label

    ;set AR1,ARP
    MOV AL,SP
    SUBB AL,#3
    MOV AR1,AL
    NOP *ARP1

    ;jump to C2XLP function
    LB _foo
_label:

    ;restore register
    POP AR5:AR4
    POP AR3:AR2
    POP AR1:AR0LRETR
```

Since the veneer function frame will act as the frame for all C2XLP calls, it is necessary to add sufficient size to the frame for any subsequent calls made by the first C2XLP function.

Global variables will be placed in the .ebss sections for C28x C/C++ code. A C2XLP .ebss section is not guaranteed to begin on a 128-word boundary when linked with C28x code. To avoid this problem, define a new section, change the C2XLP globals to the new section, and update the linker command file to ensure this new section begins at a 128-word boundary.

Post-Link Optimizer

The TMS320C28x post-link optimizer removes or modifies assembly language instructions to generate better code. The post-link optimizer examines the final addresses of symbols determined by linking and uses this information to make code changes.

Post-link optimization requires the `-plink` compiler option. The `-plink` compiler option invokes added passes of the tools that include running the absolute lister and rerunning the assembler and linker. You must use the `-plink` option following the `--run_linker` option.

Topic	Page
5.1 The Post-Link Optimizer’s Role in the Software Development Flow	91
5.2 Removing Redundant DP Loads	92
5.3 Tracking DP Values Across Branches	92
5.4 Tracking DP Values Across Function Calls	93
5.5 Other Post-Link Optimizations	93
5.6 Controlling Post-Link Optimizations	94
5.7 Restrictions on Using the Post-Link Optimizer	95
5.8 Naming the Outfile (--output_file Option).....	95

5.1 The Post-Link Optimizer's Role in the Software Development Flow

The post-link optimizer is not part of the normal development flow. Figure 5-1 shows the flow including the post-link optimizer; this flow occurs only when you use the compiler and the -plink option.

Figure 5-1. The Post-Link Optimizer in the TMS320C28x Software Development Flow

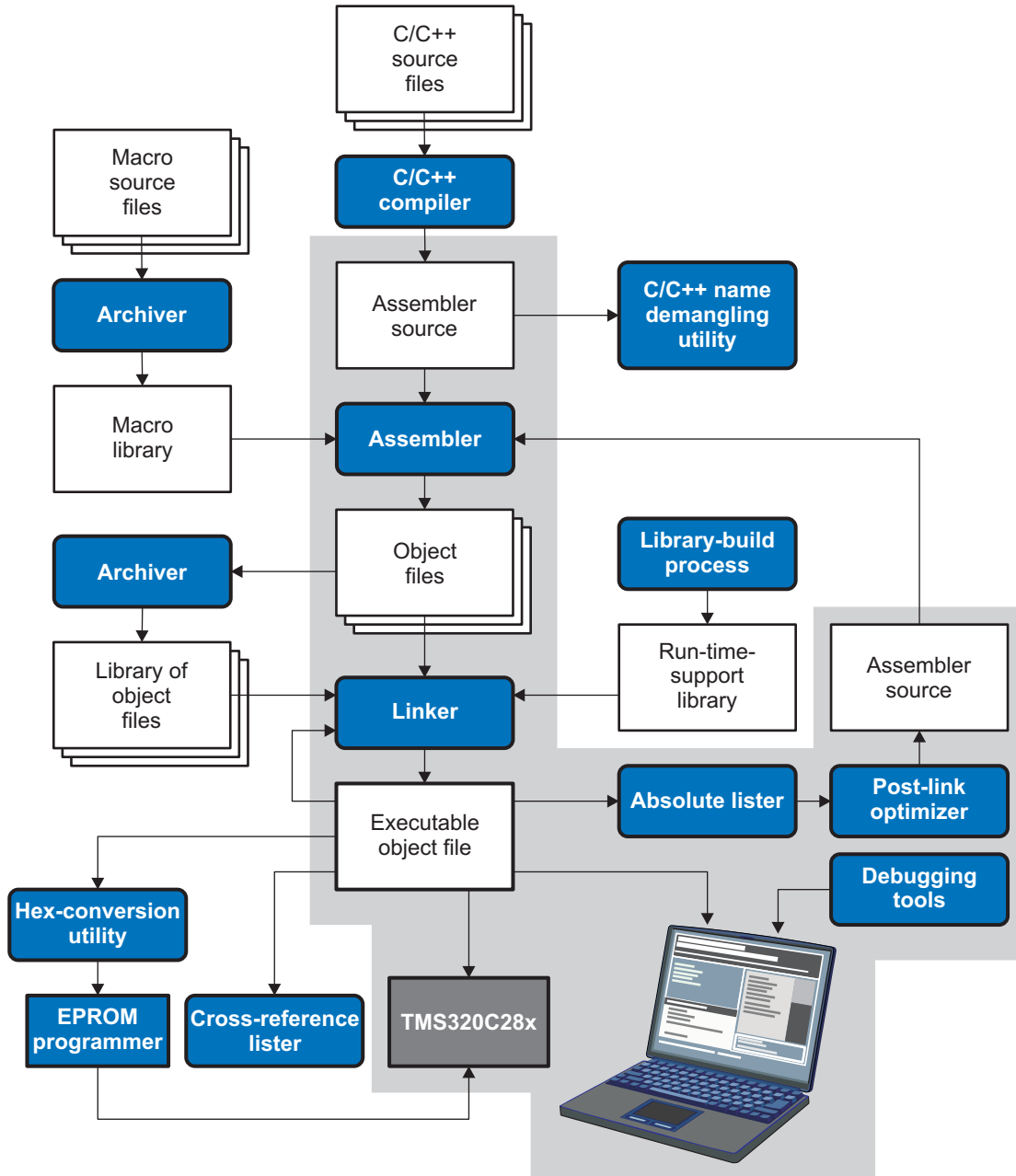

As the flow shows, the absolute lister (abs2000) is also part of the post-link optimizing process. The absolute lister outputs the absolute addresses of all globally defined symbols and COFF sections. The post-link optimizer takes .abs files as input and uses these addresses to perform optimizations. The output is a .pl file, which is an optimized version of the original .asm file. The flow then reruns the assembler and linker to produce a final output file.

The described flow is supported only when you use the compiler (cl2000) and the -plink option. If you use a batch file to invoke each tool individually, you must adapt the flow to use the compiler instead. In addition, you must use the --output_file option to specify an output file name when using the -plink option. See Section 5.8 for more details.

For example, replace these lines:

```
cl2000 file1.asm file1.obj
cl2000 file2.asm file2.obj
cl2000 --run_linker file1.obj file2.obj lnk.cmd --output_file=prog.out
```

with this line:

```
cl2000 file1.asm file2.asm --run_linker lnk.cmd --output_file=prog.out -p-link
```

The advice_only mode is the only post-link optimization support provided for FPU and VCU targets.

5.2 Removing Redundant DP Loads

Post-link optimization reduces the difficulty of managing the Data Page (DP) register by removing redundant DP loads. It does this by tracking the current value of the DP and determining whether the address in a MOV DP,#address instruction is located on the same 64-word page to which the DP is currently pointing. If the address can be accessed using the current DP value, the instruction is redundant and can be removed. For example, consider the following code segment:

```
MOVZ    DP, #name1
ADD     @name1, #10
MOVZ    DP, #name2
ADD     @name2, #10
```

If name1 and name2 are linked to the same page, the post-link optimizer determines that loading DP with the address of name2 is not necessary, and it comments out the redundant load.

```
MOVZ    DP, #name1
ADD     @name1, #10
; <<REDUNDANT>>          MOVZ    DP, #name2
ADD     @name2, #10
```

This optimization can be used on C files as well. Even though the compiler manages the DP for all global variable references that are defined within a module, it conservatively emits DP loads for any references to global variables that are externally defined. Using the post-link optimizer can help reduce the number of DP loads in these instances.

Additionally, the --map_file linker option can be used to generate a listing of symbols sorted by data page to assist with data layout and DP load reduction. For more information, refer to the Linker Description chapter in the *TMS320C28x Assembly Language Tools User's Guide*.

5.3 Tracking DP Values Across Branches

In order to track DP values across branches, the post-link optimizer requires that there are no indirect calls or branches, and all possible branch destinations have labels. If an indirect branch or call is encountered, the post-link optimizer will only track the DP value within a basic block. Branch destinations without labels may cause incorrect output from the post-link optimizer.

If the post-link optimizer encounters indirect calls or branches, it issues the following warning:

```
NO POST LINK OPTIMIZATION DONE ACROSS BRANCHES
Branch/Call must have labeled destination
```

This warning is issued so that if the file is a hand written assembly file, you can try to change the indirect call/branch to a direct one to obtain the best optimization from the post linker.

5.4 Tracking DP Values Across Function Calls

The post-link optimizer optimizes DP loads after a call to a function if the function is defined in the same file scope. For example, consider the following post-link optimized code:

```

_main:
    LCR    #_foo
    MOVB  AL, #0
; <<REDUNDANT>>    MOVZ    DP, #_g2
    MOV   @_g2, #20
    LRETR

    .global    _foo
_foo:
    MOVZ   DP, #g1
    MOV   @_g1, #10
    LRETR
  
```

The MOVZ DP after the function call to `_foo` is removed by the post-link optimizer as the variables `_g1` and `_g2` are in the same page and the function `_foo` already set the DP.

In order for the post-link optimizer to optimize across the function calls, the functions should have only one return statement. If you are running the post-link optimizer on hand written assembly that has more than one return statement per function, the post-link optimization output can be incorrect. You can turn off the optimization across function calls by specifying the `-nf` option after the `-plink` option.

5.5 Other Post-Link Optimizations

An externally defined symbol used as a constant operand forces the assembler to choose a 16-bit encoding to hold the immediate value. Since the post-link optimizer has access to the externally defined symbol value, it replaces a 16-bit encoding with an 8-bit encoding when possible. For example:

```

.ref ext_sym ; externally defined to be 4
:
:
ADD AL, #ext_sym ; assembly will encode ext_sym with 16 bits
  
```

Since `ext_sym` is externally defined, the assembler chooses a 16-bit encoding for `ext_sym`. The post-link optimizer changes the encoding of `ext_sym` to an 8-bit encoding:

```

.ref ext_sym
:
:
; << ADD=>ADDB>> ADD AL, #ext_sym
ADDB AL, #ext_sym
  
```

Similarly the post-link optimizer attempts to reduce the following 2-word instructions to 1-word instructions:

2-Word Instructions	1-Word Instructions
ADD ACC, #imm	ADDDB ACC, #imm
ADD AL, #imm	ADDDB AL, #imm
AND AL, #imm	ANDB AL, #imm
CMP AL, #imm	CMPB AL, #imm
MOVL XARn, #imm	MOVB XARn, #imm
OR AL, #imm	ORB AL, #imm
SUB ACC, #imm	SUBB ACC, #imm
SUB AL, #imm	SUBB AL, #imm
XOR AL, #imm	XORB AL, #imm

5.6 Controlling Post-Link Optimizations

There are three ways to control post-link optimizations: by excluding files, by inserting specific comments within an assembly file, and by manually editing the post-link optimization file.

5.6.1 Excluding Files (-ex Option)

Specific files can be excluded from the post-link optimization process by using the `-ex` option. The files to be excluded must follow the `-ex` option and include file extensions. The `-ex` option must be used after the `-plink` option and no other option may follow. For example:

```
cl2000 file1.asm file2.asm file3.asm --keep_asm --run_linker lnk.cmd -plink -o=prog.out -
ex=file3.asm
```

The file3.asm will be excluded from the post-link optimization process.

5.6.2 Controlling Post-Link Optimization Within an Assembly File

Within an assembly file, post-link optimizations can be disabled or enabled by using two specially formatted comment statements:

```
;//NOPLINK//
;//PLINK//
```

Assembly statements following the NOPLINK comment are not optimized. Post-link optimization can be reenabled using the //PLINK// comment.

The PLINK and NOPLINK comment format is not case sensitive. There can be white space between the semicolon and PLINK delimiter. The PLINK and NOPLINK comments must appear on a separate line, alone, and must begin in column 1. For example:

```
; //PLINK//
```

5.6.3 Retaining Post-Link Optimizer Output (--keep_asm Option)

The `--keep_asm` option allows you to retain any post-link files (.pl) and .absolute listing files (.abs) generated by the `-plink` option. Using the `--keep_asm` option lets you view any changes the post-link optimizer makes.

The .pl files contain the commented out statement shown with <<REDUNDANT>> or any improvements to instructions, such as <<ADD=>ADDB>>. The .pl files are assembled and linked again to exclude the commented out lines.

5.6.4 Disable Optimization Across Function Calls (-nf Option)

The `-nf` option disables the post-link optimization across function calls. The post-link optimizer recognizes the function end by the return statement and assumes there is only one return statement per function. In some hand written assembly code, it is possible to have more than one return statement per function. In such cases, the output of the post-link optimization can be incorrect. You can turn off the optimization across function calls by using the `-nf` option. This option affects all the files.

5.6.5 Annotating Assembly with Advice (--plink_advice_only option)

The `--plink_advice_only` option annotates assembly code with comments if changes cannot be made safely due to pipeline considerations, such as when float support or VCU support is enabled.

If you use this option, note that the post-link files (.pl), which contain the generated advice, are retained only if you also use the `--keep_asm` option.

5.7 Restrictions on Using the Post-Link Optimizer

The following restrictions affect post-link optimization:

- The `advice_only` mode is the only post-link optimization support provided for FPU and VCU targets.
- Branches or calls to unlabeled destinations invalidate DP load optimizations. All branch destinations must have labels.
- If the position of the data sections depends on the size of the code sections, the data page layout information used to decide which DP load instructions to remove may no longer be valid.

For example, consider the following link command file:

```
SECTIONS
{
    .text    > MEM,
    .mydata > MEM, }
```

A change in the size of the `.text` section after optimizing causes the `.mydata` section to shift. Ensuring that all output data sections are aligned on a 64-word boundary removes this shifting issue. For example, consider the following link command file:

```
SECTIONS
{
    .text > MEM,
    .mydata align = 64 > MEM, }
```

5.8 Naming the Outfile (`--output_file` Option)

When using the `-plink` option, you must include the `--output_file` option. If the output filename is specified in a linker command file, the compiler does not have access to the filename to pass it along to other phases of post-link optimization, and the process will fail. For example:

```
c12000 file1.c file2.asm --run_linker --output_file=prog.out lnk.cmd -plink
```

Because the post-link optimization flow uses the absolute lister, `abs2000`, it must be included in your path.

TMS320C28x C/C++ Language Implementation

The C/C++ compiler supports the C/C++ language standard that was developed by a committee of the American National Standards Institute (ANSI) and subsequently adopted by the International Standards Organization (ISO).

The C++ language supported by the C28x is defined by the ANSI/ISO/IEC 14882:2003 standard with certain exceptions.

Topic	Page
6.1 Characteristics of TMS320C28x C	97
6.2 Characteristics of TMS320C28x C++	101
6.3 Using MISRA C 2004	102
6.4 Data Types.....	103
6.5 Keywords	105
6.6 C++ Exception Handling	110
6.7 Register Variables and Parameters	110
6.8 The <code>__asm</code> Statement.....	111
6.9 Pragma Directives	112
6.10 The <code>_Pragma</code> Operator	126
6.11 Object File Symbol Naming Conventions (Linknames)	127
6.12 Initializing Static and Global Variables	127
6.13 Changing the ANSI/ISO C/C++ Language Mode	128
6.14 GNU and Clang Language Extensions.....	131
6.15 Compiler Limits	135

6.1 Characteristics of TMS320C28x C

The C compiler supports the 1989 and 1999 versions of the C language:

- **C89.** Compiling with the `--c89` option causes the compiler to conform to the ISO/IEC 9899:1990 C standard, which was previously ratified as ANSI X3.159-1989. The names "C89" and "C90" refer to the same programming language. "C89" is used in this document.
- **C99.** Compiling with the `--c99` option causes the compiler to conform to the ISO/IEC 9899:1999 C standard. This standard supports several features not part of C89, such as inline functions, new data types, and one-line comments beginning with `//`.

The C language is also described in the second edition of Kernighan and Ritchie's *The C Programming Language* (K&R). The compiler can also accept many of the language extensions found in the GNU C compiler (see [Section 6.14](#)).

The compiler supports some features of C99 in the default relaxed ANSI mode with C89 support. It supports all language features of C99 in C99 mode. See [Section 6.13](#).

The ANSI/ISO standard identifies some features of the C language that may be affected by characteristics of the target processor, run-time environment, or host environment. This set of features can differ among standard compilers.

Unsupported features of the C library are:

- The run-time library has minimal support for wide and multibyte characters. The type `wchar_t` is implemented as `int`. The wide character set is equivalent to the set of values of type `char`. The library includes the header files `<wchar.h>` and `<wctype.h>`, but does not include all the functions specified in the standard.
- The run-time library includes the header file `<locale.h>`, but with a minimal implementation. The only supported locale is the C locale. That is, library behavior that is specified to vary by locale is hard-coded to the behavior of the C locale, and attempting to install a different locale by way of a call to `setlocale()` will return `NULL`.
- Some run-time functions and features in the C99 specification are not supported. See [Section 6.13](#).

6.1.1 Implementation-Defined Behavior

The C standard requires that conforming implementations provide documentation on how the compiler handles instances of implementation-defined behavior.

The TI compiler officially supports a freestanding environment. The C standard does not require a freestanding environment to supply every C feature; in particular the library need not be complete. However, the TI compiler strives to provide most features of a hosted environment.

The section numbers in the lists that follow correspond to section numbers in Appendix J of the C99 standard. The numbers in parentheses at the end of each item are sections in the C99 standard that discuss the topic. Certain items listed in Appendix J of the C99 standard have been omitted from this list.

J.3.1 Translation

- The compiler and related tools emit diagnostic messages with several distinct formats. Diagnostic messages are emitted to `stderr`; any text on `stderr` may be assumed to be a diagnostic. If any errors are present, the tool will exit with an exit status indicating failure (non-zero). (3.10, 5.1.1.3)
- Nonempty sequences of white-space characters are preserved and are not replaced by a single space character in translation phase 3. (5.1.1.2)

J.3.2 Environment

- The compiler does not support multibyte characters in identifiers, so there is no mapping from multibyte characters to the source character set. However, the compiler accepts multibyte characters in comments, string literals, and character constants in the physical source file. (5.1.1.2)
- The name of the function called at program startup is "main" (5.1.2.1)
- Program termination does not affect the environment; there is no way to return an exit code to the environment. By default, the program is known to have halted when execution reaches the special `C$EXIT` label. (5.1.2.1)
- In relaxed ANSI mode, the compiler accepts `"void main(void)"` and `"void main(int argc, char *argv[])"` as

alternate definitions of main. The alternate definitions are rejected in strict ANSI mode. (5.1.2.2.1)

- If space is provided for program arguments at link time with the `--args` option and the program is run under a system that can populate the `.args` section (such as CCS), `argv[0]` will contain the filename of the executable, `argv[1]` through `argv[argc-1]` will contain the command-line arguments to the program, and `argv[argc]` will be NULL. Otherwise, the value of `argv` and `argc` are undefined. (5.1.2.2.1)
- Interactive devices include `stdin`, `stdout`, and `stderr` (when attached to a system that honors CIO requests). Interactive devices are not limited to those output locations; the program may access hardware peripherals that interact with the external state. (5.1.2.3)
- Signals are not supported. The function `signal` is not supported. (7.14) (7.14.1.1)
- The library function `getenv` is implemented through the CIO interface. If the program is run under a system that supports CIO, the system performs `getenv` calls on the host system and passes the result back to the program. Otherwise the operation of `getenv` is undefined. No method of changing the environment from inside the target program is provided. (7.20.4.5)
- The system function is not supported. (7.20.4.6).

J.3.3. Identifiers

- The compiler does not support multibyte characters in identifiers. (6.4.2)
- The number of significant initial characters in an identifier is unlimited. (5.2.4.1, 6.4.2)

J.3.4 Characters

- The number of bits in a byte (`CHAR_BIT`) is 16. See [Section 6.4](#) for details about data types. (3.6)
- The execution character set is the same as the basic execution character set: plain ASCII. (5.2.1)
- The values produced for the standard alphabetic escape sequences are as follows: (5.2.2)

Escape Sequence	ASCII Meaning	Integer Value
<code>\a</code>	BEL (bell)	7
<code>\b</code>	BS (backspace)	8
<code>\f</code>	FF (form feed)	12
<code>\n</code>	LF (line feed)	10
<code>\r</code>	CR (carriage return)	13
<code>\t</code>	HT (horizontal tab)	9
<code>\v</code>	VT (vertical tab)	11

- The value of a char object into which any character other than a member of the basic execution character set has been stored is the ASCII value of that character. (6.2.5)
- Plain char is identical to signed char. (6.2.5, 6.3.1.1)
- The source character set and execution character set are both plain ASCII, so the mapping between them is one-to-one. The compiler does accept multibyte characters in comments, string literals, and character constants. (6.4.4.4, 5.1.1.2)
- The compiler currently supports only one locale, "C". (6.4.4.4).
- The compiler currently supports only one locale, "C". (6.4.5).

J.3.5 Integers

- No extended integer types are provided. (6.2.5)
- Integer types are represented as two's complement, and there are no trap representations. (6.2.6.2)
- No extended integer types are provided, so there is no change to the integer ranks. (6.3.1.1)
- When an integer is converted to a signed integer type which cannot represent the value, the value is truncated (without raising a signal) by discarding the bits which cannot be stored in the destination type; the lowest bits are not modified. (6.3.1.3)
- Right shift of a signed integer value performs an arithmetic (signed) shift. The bitwise operations other than right shift operate on the bits in exactly the same way as on an unsigned value. That is, after the usual arithmetic conversions, the bitwise operation is performed without regard to the format of the integer type, in particular the sign bit. (6.5)

J.3.6 Floating point

- The accuracy of floating-point operations (+ - * /) is bit-exact. The accuracy of library functions that return floating-point results is not specified. (5.2.4.2.2)
- The compiler does not provide non-standard values for FLT_ROUNDS (5.2.4.2.2)
- The compiler does not provide non-standard negative values of FLT_EVAL_METHOD (5.2.4.2.2)
- The rounding direction when an integer is converted to a floating-point number is IEEE-754 "round to even". (6.3.1.4)
- The rounding direction when a floating-point number is converted to a narrower floating-point number is IEEE-754 "round to even". (6.3.1.5)
- For floating-point constants that are not exactly representable, the implementation uses the nearest representable value. (6.4.4.2)
- The compiler does not contract float expressions. (6.5)
- The default state for the FENV_ACCESS pragma is off. (7.6.1)
- The TI compiler does not define any additional float exceptions (7.6, 7.12)
- The default state for the FP_CONTRACT pragma is off. (7.12.2)
- The "inexact" floating-point exception cannot be raised if the rounded result equals the mathematical result. (F.9)
- The "underflow" and "inexact" floating-point exceptions cannot be raised if the result is tiny but not inexact. (F.9)

J.3.7 Arrays and pointers

- When converting a pointer to an integer or vice versa, the pointer is considered an unsigned integer of the same size, and the normal integer conversion rules apply. Some pointers are not the same size as any integral type, but the conversion proceeds as if such a type did exist, with the rules implied by normal integer conversion.
- When converting a pointer to an integer or vice versa, if the bitwise representation of the destination can hold all of the bits in the bitwise representation of the source, the bits are copied exactly. (6.3.2.3)
- The size of the result of subtracting two pointers to elements of the same array is the size of ptrdiff_t, which is defined in [Section 6.4](#). (6.5.6)

J.3.8 Hints

- When the optimizer is used, the register storage-class specifier is ignored. When the optimizer is not used, the compiler will preferentially place register storage class objects into registers to the extent possible. The compiler reserves the right to place any register storage class object somewhere other than a register. (6.7.1)
- The inline function specifier is ignored unless the optimizer is used. For other restrictions on inlining, see [Section 2.11.4](#). (6.7.4)

J.3.9 Structures, unions, enumerations, and bit-fields

- A "plain" int bit-field is treated as a signed int bit-field. (6.7.2, 6.7.2.1)
- In addition to _Bool, signed int, and unsigned int, the compiler allows char, signed char, unsigned char, signed short, unsigned short, signed long, unsigned long, signed long long, unsigned long long, and enum types as bit-field types. (6.7.2.1)
- Bit-fields may not straddle a storage-unit boundary. (6.7.2.1)
- Bit-fields are allocated in endianness order within a unit. (6.7.2.1)
- Non-bit-field members of structures are aligned as specified in [See .](#) (6.7.2.1)
- The integer type underlying each enumerated type is described in [Section 6.4.1](#). (6.7.2.2)

J.3.10 Qualifiers

- The TI compiler does not shrink or grow volatile accesses. It is the user's responsibility to make sure the access size is appropriate for devices that only tolerate accesses of certain widths. The TI compiler does not change the number of accesses to a volatile variable unless absolutely necessary. This is significant for read-modify-write expressions such as += ; for an architecture which does not have a corresponding read-modify-write instruction, the compiler will be forced to use two accesses, one for

the read and one for the write. Even for architectures with such instructions, it is not guaranteed that the compiler will be able to map such expressions to an instruction with a single memory operand. It is not guaranteed that the memory system will lock that memory location for the duration of the instruction. In a multi-core system, some other core may write the location after a RMW instruction reads it, but before it writes the result. The TI compiler will not reorder two volatile accesses, but it may reorder a volatile and a non-volatile access, so volatile cannot be used to create a critical section. Use some sort of lock if you need to create a critical section. (6.7.3)

J.3.11 Preprocessing directives

- Include directives may have one of two forms, " " or < >. For both forms, the compiler will look for a real file on-disk by that name using the include file search path. See [Section 2.5.2](#). (6.4.7).
- The value of a character constant in a constant expression that controls conditional inclusion matches the value of the same character constant in the execution character set (both are ASCII). (6.10.1).
- The compiler uses the file search path to search for an included < > delimited header file. See [Section 2.5.2](#). (6.10.2).
- The compiler uses the file search path to search for an included " " delimited header file. See [Section 2.5.2](#). (6.10.2).
- There is no arbitrary nesting limit for #include processing. (6.10.2).
- See [Section 6.9](#) for a description of the recognized non-standard pragmas. (6.10.6).
- The date and time of translation are always available from the host. (6.10.8).

J.3.12 Library functions

- Almost all of the library functions required for a hosted implementation are provided by the TI library, with exceptions noted in [Section 6.13.1](#). (5.1.2.1).
- The format of the diagnostic printed by the assert macro is "Assertion failed, (*assertion macro argument*), file *file*, line *line*". (7.2.1.1).
- No strings other than "C" and "" may be passed as the second argument to the setlocale function (7.11.1.1).
- No signal handling is supported. (7.14.1.1).
- The +INF, -INF, +inf, -inf, NAN, and nan styles can be used to print an infinity or NaN. (7.19.6.1, 7.24.2.1).
- The output for %p conversion in the fprintf or fwprintf function is the same as %x of the appropriate size. (7.19.6.1, 7.24.2.1).
- The termination status returned to the host environment by the abort, exit, or _Exit function is not returned to the host environment. (7.20.4.1, 7.20.4.3, 7.20.4.4).
- The system function is not supported. (7.20.4.6).

J.3.13 Architecture

- The values or expressions assigned to the macros specified in the headers float.h, limits.h, and stdint.h are described along with the sizes and format of integer types are described in [Section 6.4](#). (5.2.4.2, 7.18.2, 7.18.3)
- The number, order, and encoding of bytes in any object are described in . (6.2.6.1)
- The value of the result of the sizeof operator is the storage size for each type, in terms of bytes. See . (6.5.3.4)

6.2 Characteristics of TMS320C28x C++

The C28x compiler supports C++ as defined in the ANSI/ISO/IEC 14882:2003 standard, including these features:

- Complete C++ standard library support, with exceptions noted below.
- Templates
- Exceptions, which are enabled with the `--exceptions` option; see [Section 6.6](#).
- Run-time type information (RTTI), which can be enabled with the `--rtti` compiler option.

The compiler supports the 2003 standard of C++ as standardized by the ISO. However, the following features are *not* implemented or fully supported:

- The compiler does not support embedded C++ run-time-support libraries.
- The `<complex>` header and its functions are not included in the library.
- The library supports wide chars (`wchar_t`), in that template functions and classes that are defined for `char` are also available for `wchar_t`. For example, wide char stream classes `wios`, `wiostream`, `wstringstream` and so on (corresponding to `char` classes `ios`, `iostream`, `stringstream`) are implemented. However, there is no low-level file I/O for wide chars. Also, the C library interface to wide char support (through the C++ headers `<wchar>` and `<cwctype>`) is limited as described above in the C library.
- If the definition of an inline function contains a static variable, and it appears in multiple compilation units (usually because it's a member function of a class defined in a header file), the compiler generates multiple copies of the static variable rather than resolving them to a single definition. The compiler emits a warning (#1369) in such cases.
- Two-phase name binding in templates, as described in [tesp.res] and [temp.dep] of the standard, is not implemented.
- The `export` keyword for templates is not implemented.
- A typedef of a function type cannot include member function cv-qualifiers.
- A partial specialization of a class member template cannot be added outside of the class definition.

6.3 Using MISRA C 2004

MISRA C is a set of software development guidelines for the C programming language. It promotes best practices in developing safety-related electronic systems in road vehicles and other embedded systems. MISRA C was originally launched in 1998 by the Motor Industry Software Reliability Association, and has since been adopted across a wide variety of industries. A subsequent update to the guidelines was published as MISRA C:2004.

You can alter your code to work with the MISRA C:2004 rules. The following options and pragmas can be used to enable/disable rules:

- The `--check_misra` option enables checking of the specified MISRA C:2004 rules. This compiler option must be used if you want to enable further control over checking using the `CHECK_MISRA` and `RESET_MISRA` pragmas.
- The `CHECK_MISRA` pragma enables/disables MISRA C:2004 rules at the source level. See [Section 6.9.2](#).
- The `RESET_MISRA` pragma resets the specified MISRA C:2004 rules to their state before any `CHECK_MISRA` pragmas were processed. See [Section 6.9.17](#).

The syntax of the option and the pragmas is:

```
--check_misra={all|required|advisory|none|rulespec}
#pragma CHECK_MISRA ("{all|required|advisory|none|rulespec}")
#pragma RESET_MISRA ("{all|required|advisory|rulespec}")
```

The *rulespec* parameter is a comma-separated list of rule numbers to enable or disable.

Example: `--check_misra=1.1,1.4,1.5,2.1,2.7,7.1,7.2,8.4`

- Enables checking of rules 1.1, 1.4, 1.5, 2.1, 2.7, 7.1, 7.2, and 8.4.

Example: `#pragma CHECK_MISRA("-7.1,-7.2,-8.4")`

- Disables checking of rules 7.1, 7.2, and 8.4.

A typical use case is to use the `--check_misra` option on the command line to specify the rules that should be checked in most of your code. Then, use the `CHECK_MISRA` pragma with a *rulespec* to activate or deactivate certain rules for a particular region of code.

Two options control the severity of certain MISRA C:2004 rules:

- The `--misra_required` option sets the diagnostic severity for required MISRA C:2004 rules.
- The `--misra_advisory` option sets the diagnostic severity for advisory MISRA C:2004 rules.

The syntax for these options is:

```
--misra_advisory={error|warning|remark|suppress}
--misra_required={error|warning|remark|suppress}
```

6.4 Data Types

[Table 6-1](#) lists the size, representation, and range of each scalar data type for the C28x compiler. Many of the range values are available as standard macros in the header file `limits.h`.

Table 6-1. TMS320C28x C/C++ Data Types

Type	Size	Representation	Range	
			Minimum	Maximum
char, signed char	16 bits	ASCII	-32 768	32 767
unsigned char, <code>_Bool</code>	16 bits	ASCII	0	65 535
short	16 bits	2s complement	-32 768	32 767
unsigned short	16 bits	Binary	0	65 535
int, signed int	16 bits	2s complement	-32 768	32 767
unsigned int	16 bits	Binary	0	65 535
long, signed long	32 bits	2s complement	-2 147 483 648	2 147 483 647
unsigned long	32 bits	Binary	0	4 294 967 295
long long, signed long long	64 bits	2s complement	-9 223 372 036 854 775 808	9 223 372 036 854 775 807
unsigned long long	64 bits	Binary	0	18 446 744 073 709 551 615
enum ⁽¹⁾	16 bits	2s complement	-32 768	32 767
float	32 bits	IEEE 32-bit	1.19 209 290e-38 ⁽²⁾	3.40 282 35e+38
double	32 bits	IEEE 32-bit	1.19 209 290e-38 ⁽²⁾	3.40 282 35e+38
long double	64 bits	IEEE 64-bit	2.22 507 385e-308 ⁽²⁾	1.79 769 313e+308
pointers ⁽³⁾	32 bits	Binary	0	0xFFFFFFFF

⁽¹⁾ For details about the size of an enum type, see [Section 6.4.1](#).

⁽²⁾ Figures are minimum precision.

⁽³⁾ Even though pointers are 32-bits, the compiler assumes that the addresses of global variables and functions are within 22-bits.

NOTE: TMS320C28x Byte is 16 Bits

By ANSI/ISO C definition, the `sizeof` operator yields the number of bytes required to store an object. ANSI/ISO further stipulates that when `sizeof` is applied to `char`, the result is 1. Since the TMS320C28x `char` is 16 bits (to make it separately addressable), a byte is also 16 bits. This yields results you may not expect; for example, `size of (int) = 1` (not 2). TMS320C28x bytes and words are equivalent (16 bits). To access data in increments of 8 bits, use the `__byte()` and `__mov_byte()` intrinsics described in [Section 7.5.6](#).

6.4.1 Size of Enum Types

An enum type is represented by an underlying integer type. The size of the integer type and whether it is signed is based on the range of values of the enumerated constants.

In strict C89 or C99 mode, the compiler allows only enumeration constants with values that will fit in "int" or "unsigned int".

For C++ and relaxed C89/C99, the compiler allows enumeration constants up to the largest integral type (64 bits). The default, which is recommended, is for the underlying type to be the first type in the following list in which all the enumerated constant values can be represented: int, unsigned int, long, unsigned long long long, unsigned long long.

6.4.2 Support for 64-Bit Integers

The TMS320C28x compiler supports the long long and unsigned long long data types. The range values are available as standard macros in the header file `limits.h`.

The long long data types are stored in register pairs. In memory they are stored as 64-bit objects at word (32-bit) aligned addresses.

A long long integer constant can have an ll or LL suffix. Without the suffix the value of the constant determines the type of the constant.

The formatting rules for long long in C I/O require ll in the format string. For example:

```
printf("%lld", 0x0011223344556677);
printf("%llx", 0x0011223344556677);
```

The run-time-support library functions, llabs(), strtoll() and strtoull(), are added.

6.4.3 C28x long double Floating-Point Type Change

When compiling C/C++ code for the TMS320C28x only, the long double floating point type is now IEEE 64-bit double precision. No other floating-point types have changed formats. C28x floating point types are:

Type	Format
float	IEEE 32-bit single precision
double	IEEE 32-bit single precision
long double	IEEE 64-bit double precision

When you initialize a long double to a constant, you must use the l or L suffix. The constant is treated as a double type without the suffix and the run-time support double-to-long conversion routine is called for the initialization. This could result in the loss of precision. For example:

```
long double a = 12.34L; /* correctly initializes to double precision */
long double b = 56.78; /* converts single precision value to double precision */
```

The formatting rules for long doubles in C I/O require a capital 'L' in the format string. For example:

```
printf("%Lg", 1.23L);
printf("%Le", 3.45L);
```

In response to the change in the long double type to 64-bit IEEE double-precision format, the C28x calling conventions have changed.

All long double arguments are passed by reference. A long double return value is returned by reference. The first two long double arguments will pass their addresses in XAR4 and XAR5. All other long double arguments will have their addresses passed on the stack.

If a function returns a long double, the function making that call will place the return address in XAR6. For example:

```
long double foo(long double a, long double b, long double c)
{
    long double d = a + b + c;
    return d;
}

long double a = 1.2L;
long double b = 2.2L;
long double c = 3.2L;
long double d;

void bar()
{
    d = foo(a, b, c);
}
```

In function bar(), at the call to foo(), the register values are:

Register	Equals
XAR4	The address of a
XAR5	The address of b
*-SP[2]	The address of c
XAR6	The address of d

The run-time-support library has been updated to include the necessary long double arithmetic operations and conversion functions. All C28x floating-point run-time-support routines have had their names updated. For example, a previous call to the floating point add routine was:

```
LCR F$$ADD
```

This has been updated to:

```
LCR FS$$ADD ; single-precision add
LCR FD$$ADD ; double-precision add
```

Any C28x routine that calls floating-point arithmetic or conversion routines will need to be recompiled.

6.5 Keywords

The C28x C/C++ compiler supports all of the standard C89 keywords, including `const`, `volatile`, and `register`. It also supports all of the standard C99 keywords, including `inline` and `restrict`. It also supports TI extension keywords `__interrupt`, `__cregister`, and `__asm`. The compiler supports the `restrict` keyword for FPU targets; for other targets `restrict` is ignored. Some keywords are not available in strict ANSI mode.

The following keywords may appear in other target documentation and require the same treatment as the `interrupt` and `restrict` keywords:

- `trap`
- `reentrant`
- `cregister`

6.5.1 The `const` Keyword

The C/C++ compiler supports the ANSI/ISO standard keyword `const` in all modes.

This keyword gives you greater optimization and control over allocation of storage for certain data objects. You can apply the `const` qualifier to the definition of any variable or array to ensure that its value is not altered.

Global objects qualified as `const` are placed in the `.econst` section. The linker allocates the `.econst` section from ROM or FLASH, which are typically more plentiful than RAM. The `const` data storage allocation rule has the following exceptions:

- If `volatile` is also specified in the object definition. For example, `volatile const int x`. Volatile keywords are assumed to be allocated to RAM. (The program is not allowed to modify a `const volatile` object, but something external to the program might.)
- If the object has automatic storage (function scope).
- If the object is a C++ object with a "mutable" member.
- If the object is initialized with a value that is not known at compile time (such as the value of another variable).

In these cases, the storage for the object is the same as if the `const` keyword were not used.

The placement of the `const` keyword within a definition is important. For example, the first statement below defines a constant pointer `p` to a modifiable `int`. The second statement defines a modifiable pointer `q` to a constant `int`:

```
int * const p = &x;
const int * q = &x;
```

Using the `const` keyword, you can define large constant tables and allocate them into system ROM. For example, to allocate a ROM table, you could use the following definition:

```
const int digits[] = {0,1,2,3,4,5,6,7,8,9};
```

6.5.2 The `__cregister` Keyword

The compiler extends the C/C++ language by adding the `cregister` keyword to allow high level language access to control registers. This keyword is available in normal mode, but not in strict ANSI/ISO mode (using the `--strict_ansi` compiler option). The alternate keyword, `__cregister`, provides the same functionality but is available in either strict ANSI/ISO mode or normal mode.

When you use the `cregister` keyword on an object, the compiler compares the name of the object to a list of standard control registers for the C28x (see [Table 6-2](#)). If the name matches, the compiler generates the code to reference the control register. If the name does not match, the compiler issues an error.

Table 6-2. Valid Control Registers

Register	Description
IER	Interrupt enable register
IFR	Interrupt flag register

The `cregister` keyword can be used only in file scope. The `cregister` keyword is not allowed on any declaration within the boundaries of a function. It can only be used on objects of type integer or pointer. The `cregister` keyword is not allowed on objects of any floating-point type or on any structure or union objects.

The `cregister` keyword does not imply that the object is volatile. If the control register being referenced is volatile (that is, can be modified by some external control), then the object must be declared with the `volatile` keyword also.

To use the control registers in [Table 6-2](#), you must declare each register as follows. The `c28x.h` include file defines all the control registers through this syntax:

```
extern cregister volatile unsigned int register ;
```

Once you have declared the register, you can use the register name directly, though in a limited manner. IFR is read only and can be set only by using the `|` (OR) operation with an immediate. IFR can be cleared only by using the `&` (AND) operation with an immediate. For example:

```
IFR |= 0x4;
IFR &= 0x0800
```

The IER register also can be used in an assignment other than OR and AND. Since the C28x architecture has limited instructions to manipulate these registers, the compiler terminates with the following message if illegal use of these registers is found:

```
>>> Illegal use of control register
```

See [Example 6-1](#) for an example that declares and uses control registers.

Example 6-1. Define and Use Control Registers

```
extern cregister volatile unsigned int IFR;
extern cregister volatile unsigned int IER;
extern int x;

main()
{
    IER = x;
    IER |= 0x100;
    printf("IER = %x\n", IER);

    IFR &= 0x100;
    IFR |= 0x100;
```

6.5.3 The `__interrupt` Keyword

The compiler extends the C/C++ language by adding the `__interrupt` keyword, which specifies that a function is treated as an interrupt function. This keyword is an IRQ interrupt. The alternate keyword, "interrupt", may also be used except in strict ANSI C or C++ modes.

Note that the interrupt function attribute described in [Section 6.9.14](#) is the recommended syntax for declaring interrupt functions.

Functions that handle interrupts follow special register-saving rules and a special return sequence. The implementation stresses safety. The interrupt routine does not assume that the C run-time conventions for the various CPU register and status bits are in effect; instead, it re-establishes any values assumed by the run-time environment. When C/C++ code is interrupted, the interrupt routine must preserve the contents of all machine registers that are used by the routine or by any function called by the routine. When you use the `__interrupt` keyword with the definition of the function, the compiler generates register saves based on the rules for interrupt functions and the special return sequence for interrupts.

You can only use the `__interrupt` keyword with a function that is defined to return void and that has no parameters. The body of the interrupt function can have local variables and is free to use the stack or global variables. For example:

```
__interrupt void int_handler()
{
    unsigned int flags;
    ...
}
```

The name `c_int00` is the C/C++ entry point. This name is reserved for the system reset interrupt. This special interrupt routine initializes the system and calls the `main()` function. Because it has no caller, `c_int00` does not save any registers.

Hwi Objects and the `__interrupt` Keyword

NOTE: The `__interrupt` keyword must not be used when SYS/BIOS Hwi objects are used in conjunction with C functions. The `Hwi_enter/Hwi_exit` macros and the Hwi dispatcher already contain this functionality, and the use of the C modifier can cause unwanted conflicts.

6.5.4 The restrict Keyword

To help the compiler determine memory dependencies, you can qualify a pointer, reference, or array with the restrict keyword. The restrict keyword is a type qualifier that can be applied to pointers, references, and arrays. Its use represents a guarantee by you, the programmer, that within the scope of the pointer declaration the object pointed to can be accessed only by that pointer. Any violation of this guarantee renders the program undefined. This practice helps the compiler optimize certain sections of code because aliasing information can be more easily determined.

In [Example 6-2](#), the restrict keyword is used to tell the compiler that the function func1 is never called with the pointers a and b pointing to objects that overlap in memory. You are promising that accesses through a and b will never conflict; therefore, a write through one pointer cannot affect a read from any other pointers. The precise semantics of the restrict keyword are described in the 1999 version of the ANSI/ISO C Standard.

The "restrict" keyword is a C99 keyword, and cannot be accepted in strict ANSI C89 mode. Use the "__restrict" keyword if the strict ANSI C89 mode must be used. See [Section 6.13](#).

Example 6-2. Use of the restrict Type Qualifier With Pointers

```
void func1(int * restrict a, int * restrict b)
{
    /* func1's code here */
}
```

[Example 6-3](#) illustrates using the restrict keyword when passing arrays to a function. Here, the arrays c and d must not overlap, nor may c and d point to the same array.

Example 6-3. Use of the restrict Type Qualifier With Arrays

```
void func2(int c[restrict], int d[restrict])
{
    int i;

    for(i = 0; i < 64; i++)
    {
        c[i] += d[i];
        d[i] += 1;
    }
}
```

At this time the restrict keyword is useful only for FPU targets. For non-FPU targets restrict is ignored.

6.5.5 The volatile Keyword

The C/C++ compiler supports the *volatile* keyword in all modes. In addition, the __volatile keyword is supported in relaxed ANSI mode for C89, C99, and C++.

The volatile keyword indicates to the compiler that there is something about how the variable is accessed that requires that the compiler not use overly-clever optimization on expressions involving that variable. For example, the variable may also be accessed by an external program, an interrupt, another thread, or a peripheral device.

The compiler eliminates redundant memory accesses whenever possible, using data flow analysis to figure out when it is legal. However, some memory accesses may be special in some way that the compiler cannot see, and in such cases you should use the volatile keyword to prevent the compiler from optimizing away something important. The compiler does not optimize out any accesses to variables declared volatile. The number of volatile reads and writes will be exactly as they appear in the C/C++ code, no more and no less and in the same order.

Any variable which might be modified by something external to the obvious control flow of the program (such as an interrupt service routine) must be declared volatile. This tells the compiler that an interrupt function might modify the value at any time, so the compiler should not perform optimizations which will change the number or order of accesses of that variable. This is the primary purpose of the volatile keyword. In the following example, the loop intends to wait for a location to be read as 0xFF:

```
unsigned int *ctrl;
while (*ctrl !=0xFF);
```

However, in this example, *ctrl is a loop-invariant expression, so the loop is optimized down to a single-memory read. To get the desired result, define ctrl as:

```
volatile unsigned int *ctrl;
```

Here the *ctrl pointer is intended to reference a hardware location, such as an interrupt flag.

The volatile keyword must also be used when accessing memory locations that represent memory-mapped peripheral devices. Such memory locations might change value in ways that the compiler cannot predict. These locations might change if accessed, or when some other memory location is accessed, or when some signal occurs.

Volatile must also be used for local variables in a function which calls setjmp, if the value of the local variables needs to remain valid if a longjmp occurs.

Example 6-4. Volatile for Local Variables With setjmp

```
#include <stdlib.h>
jmp_buf context;
void function()
{
    volatile int x = 3;
    switch(setjmp(context))
    {
        case 0: setup(); break;
        default:
        {
            printf("x == %d\n", x); /* We can only reach here if longjmp has occurred; because x's
                                   lifetime begins before the setjmp and lasts through the longjmp,
                                   the C standard requires x be declared "volatile" */

            break;
        }
    }
}
```

The --unified_memory option can be used if your memory map is configured as a single unified space; this option allows the compiler to generate more efficient instructions for most memcpy calls and structure assignments. Even under unified memory, memory for some peripherals and some RAM associated with those peripherals is allocated only in data memory. If --unified_memory is enabled, you can prevent program memory address access to specific symbols by declaring those symbols as volatile.

6.6 C++ Exception Handling

The compiler supports all the C++ exception handling features as defined by the ANSI/ISO 14882 C++ Standard. More details are discussed in *The C++ Programming Language, Third Edition* by Bjarne Stroustrup.

The compiler `--exceptions` option enables exception handling. The compiler's default is no exception handling support.

For exceptions to work correctly, all C++ files in the application must be compiled with the `--exceptions` option, regardless of whether exceptions occur in a particular file. Mixing exception-enabled object files and libraries with object files and libraries that do not have exceptions enabled can lead to undefined behavior.

Exception handling requires support in the run-time-support library, which come in exception-enabled and exception-disabled forms; you must link with the correct form. When using automatic library selection (the default), the linker automatically selects the correct library [Section 4.3.1.1](#). If you select the library manually, you must use run-time-support libraries whose name contains `_eh` if you enable exceptions.

Using the `--exceptions` option causes the compiler to insert exception handling code. This code will increase the size of the program and execution time, even if no exceptions are thrown.

See [Section 8.1](#) for details on the run-time libraries.

6.7 Register Variables and Parameters

The C/C++ compiler treats register variables (variables defined with the `register` keyword) differently, depending on whether you use the `--opt_level (-O)` option.

- **Compiling with optimization**

The compiler ignores any register definitions and allocates registers to variables and temporary values by using an algorithm that makes the most efficient use of registers.

- **Compiling without optimization**

If you use the `register` keyword, you can suggest variables as candidates for allocation into registers. The compiler uses the same set of registers for allocating temporary expression results as it uses for allocating register variables.

The compiler attempts to honor all register definitions. If the compiler runs out of appropriate registers, it frees a register by moving its contents to memory. If you define too many objects as register variables, you limit the number of registers the compiler has for temporary expression results. This limit causes excessive movement of register contents to memory.

Any object with a scalar type (integral, floating point, or pointer) can be defined as a register variable. The register designator is ignored for objects of other types, such as arrays.

The register storage class is meaningful for parameters as well as local variables. Normally, in a function, some of the parameters are copied to a location on the stack where they are referenced during the function body. The compiler copies a register parameter to a register instead of the stack, which speeds access to the parameter within the function.

For more information about register conventions, see [Section 7.2](#).

6.8 The `__asm` Statement

The C/C++ compiler can embed assembly language instructions or directives directly into the assembly language output of the compiler. This capability is an extension to the C/C++ language implemented through the `__asm` keyword. The `__asm` keyword provides access to hardware features that C/C++ cannot provide.

The alternate keyword, "asm", may also be used except in strict ANSI C mode. It is available in relaxed C and C++ modes.

Using `__asm` is syntactically performed as a call to a function named `__asm`, with one string constant argument:

```
__asm(" assembler text ");
```

The compiler copies the argument string directly into your output file. The assembler text must be enclosed in double quotes. All the usual character string escape codes retain their definitions. For example, you can insert a `.byte` directive that contains quotes as follows:

```
__asm("STR: .byte \"abc\"");
```

The inserted code must be a legal assembly language statement. Like all assembly language statements, the line of code inside the quotes must begin with a label, a blank, a tab, or a comment (asterisk or semicolon). The compiler performs no checking on the string; if there is an error, the assembler detects it. For more information about the assembly language statements, see the *TMS320C28x Assembly Language Tools User's Guide*.

The `__asm` statements do not follow the syntactic restrictions of normal C/C++ statements. Each can appear as a statement or a declaration, even outside of blocks. This is useful for inserting directives at the very beginning of a compiled module.

The `__asm` statement does not provide any way to refer to local variables. If your assembly code needs to refer to local variables, you will need to write the entire function in assembly code.

For more information, refer to [Section 7.5.5](#).

NOTE: Avoid Disrupting the C/C++ Environment With asm Statements

Be careful not to disrupt the C/C++ environment with `__asm` statements. The compiler does not check the inserted instructions. Inserting jumps and labels into C/C++ code can cause unpredictable results in variables manipulated in or around the inserted code. Directives that change sections or otherwise affect the assembly environment can also be troublesome.

Be especially careful when you use optimization with `__asm` statements. Although the compiler cannot remove `__asm` statements, it can significantly rearrange the code order near them and cause undesired results.

NOTE: Use Single asm Statement for the RPT Instruction

When adding a C28x RPT instruction, do not use a separate `asm` statement for RPT and the repeated instruction. The compiler could insert debug directives between `asm` directives and the assembler does not allow any directives between the RPT and the repeated instruction. For example, to insert a RPT MAC instruction, use the following:

```
asm("\tRPT #10\n\t|MAC P, *XAR4++, *XAR7++");
```

6.9 Pragma Directives

Pragma directives tell the compiler how to treat a certain function, object, or section of code. The C28x C/C++ compiler supports the following pragmas:

- CALLS (See [Section 6.9.1](#))
- CHECK_MISRA (See [Section 6.9.2](#))
- CLINK (See [Section 6.9.3](#))
- CODE_ALIGN (See [Section 6.9.4](#))
- CODE_SECTION (See [Section 6.9.5](#))
- DATA_ALIGN (See [Section 6.9.6](#))
- DATA_SECTION (See [Section 6.9.7](#))
- diag_suppress, diag_remark, diag_warning, diag_error, diag_default, diag_push, diag_pop (See [Section 6.9.8](#))
- FAST_FUNC_CALL (See [Section 6.9.9](#))
- FUNC_ALWAYS_INLINE (See [Section 6.9.10](#))
- FUNC_CANNOT_INLINE (See [Section 6.9.11](#))
- FUNC_EXT_CALLED (See [Section 6.9.12](#))
- FUNCTION_OPTIONS (See [Section 6.9.13](#))
- INTERRUPT (See [Section 6.9.14](#))
- MUST_ITERATE (See [Section 6.9.15](#))
- NO_HOOKS (See [Section 6.9.16](#))
- RESET_MISRA (See [Section 6.9.17](#))
- RETAIN (See [Section 6.9.18](#))
- SET_CODE_SECTION (See [Section 6.9.19](#))
- SET_DATA_SECTION (See [Section 6.9.19](#))
- UNROLL (See [Section 6.9.20](#))

The arguments *func* and *symbol* cannot be defined or declared inside the body of a function. You must specify the pragma outside the body of a function; and the pragma specification must occur before any declaration, definition, or reference to the *func* or *symbol* argument. If you do not follow these rules, the compiler issues a warning and may ignore the pragma.

For pragmas that apply to functions or symbols, the syntax differs between C and C++.

- In C, you must supply the name of the object or function to which you are applying the pragma as the first argument. Because the entity operated on is specified, a pragma in C can appear some distance way from the definition of that entity.
- In C++, pragmas are positional. They do not name the entity on which they operate as an argument. Instead, they always operate on the next entity defined after the pragma.

6.9.1 The CALLS Pragma

The CALLS pragma specifies a set of functions that can be called indirectly from a specified calling function.

The CALLS pragma is used by the compiler to embed debug information about indirect calls in object files. Using the CALLS pragma on functions that make indirect calls enables such indirect calls to be included in calculations for such functions' inclusive stack sizes. For more information on generating function stack usage information, see the `-cg` option of the Object File Display Utility in the "Invoking the Object File Display Utility" section of the *TMS320C28x Assembly Language Tools User's Guide*.

The CALLS pragma can precede either the calling function's definition or its declaration. In C, the pragma must have at least 2 arguments—the first argument is the calling function, followed by at least one function that will be indirectly called from the calling function. In C++, the pragma applies to the next function declared or defined, and the pragma must have at least one argument.

The syntax for the CALLS pragma in C is as follows. This indicates that `calling_function` can indirectly call `function_1` through `function_n`.

```
#pragma CALLS ( calling_function, function_1, function_2, ..., function_n )
```

The syntax for the CALLS pragma in C++ is:

```
#pragma CALLS ( function_1_mangled_name, ..., function_n_mangled_name )
```

Note that in C++, the arguments to the CALLS pragma must be the full mangled names for the functions that can be indirectly called from the calling function.

The GCC-style "calls" attribute syntax, which has the same effect as the CALLS pragma, is as follows:

```
__attribute__((calls("function_1","function_2",..., "function_n")))
```

6.9.2 The CHECK_MISRA Pragma

The CHECK_MISRA pragma enables/disables MISRA C:2004 rules at the source level. The compiler option `--check_misra` must be used to enable checking in order for this pragma to function at the source level.

The syntax of the pragma in C is:

```
#pragma CHECK_MISRA (" {all|required|advisory|none|rulespec} ")
```

The *rulespec* parameter is a comma-separated list of rule numbers. See [Section 6.3](#) for details.

The RESET_MISRA pragma can be used to reset any CHECK_MISRA pragmas; see [Section 6.9.17](#).

6.9.3 The CLINK Pragma

The CLINK pragma can be applied to a code or data symbol. It causes a `.clink` directive to be generated into the section that contains the definition of the symbol. The `.clink` directive tells the linker that a section is eligible for removal during conditional linking. Thus, if the section is not referenced by any other section in the application being compiled and linked, it will not be included in the resulting output file.

The syntax of the pragma in C is:

```
#pragma CLINK (symbol)
```

The syntax of the pragma in C++ is:

```
#pragma CLINK
```

The RETAIN pragma has the opposite effect of the CLINK pragma. See [Section 6.9.18](#) for more details.

6.9.4 The `CODE_ALIGN` Pragma

The `CODE_ALIGN` pragma aligns *func* along the specified alignment. The alignment *constant* must be a power of 2. The `CODE_ALIGN` pragma is useful if you have functions that you want to start at a certain boundary.

The syntax of the pragma in C is:

```
#pragma CODE_ALIGN ( func, constant )
```

The syntax of the pragma in C++ is:

```
#pragma CODE_ALIGN ( constant )
```

6.9.5 The `CODE_SECTION` Pragma

The `CODE_SECTION` pragma allocates space for the *symbol* in C, or the next symbol declared in C++, in a section named *section name*.

The syntax of the pragma in C is:

```
#pragma CODE_SECTION (symbol , "section name ")
```

The syntax of the pragma in C++ is:

```
#pragma CODE_SECTION (" section name ")
```

The `CODE_SECTION` pragma is useful if you have code objects that you want to link into an area separate from the `.text` section.

The following example demonstrates the use of the `CODE_SECTION` pragma.

Example 6-5. Using the `CODE_SECTION` Pragma C Source File

```
char bufferA[80];
char bufferB[80];

#pragma CODE_SECTION(funcA, "codeA")

char funcA(int i);
char funcB(int i);

void main()
{
    char c;
    c = funcA(1);
    c = funcB(2);
}

char funcA (int i)
{
    return bufferA[i];
}

char funcB (int j)
{
    return bufferB[j];
}
```

Example 6-6. Generated Assembly Code From [Example 6-5](#)

```

        .sect    ".text"
        .global _main;

*****
;* FNAME: _main                FR SIZE:  2          *
;*                               *
;* FUNCTION ENVIRONMENT        *
;*                               *
;* FUNCTION PROPERTIES         *
;*                               0 Parameter, 1 Auto, 0 SOE *
;*                               *
*****

:_main:
        ADDB    SP,#2
        MOVB    AL,#1           ; |12|
        LCR     #_funcA         ; |12|
                               ; call occurs [#_funcA] ; |12|
        MOV     *-SP[1],AL      ; |12|
        MOVB    AL,#1           ; |13|
        LCR     #_funcB         ; |13|
                               ; call occurs [#_funcB] ; |13|
        MOV     *-SP[1],AL      ; |13|
        SUBB    SP,#2
        LRETR
        ; return occurs

        .sect    "codeA"
        .global _funcA
*****
;* FNAME: _funcA              FR SIZE:  1          *
;*                               *
;* FUNCTION ENVIRONMENT        *
;*                               *
;* FUNCTION PROPERTIES         *
;*                               0 Parameter, 1 Auto, 0 SOE *
;*                               *
*****

_funcA:
        ADDB    SP,#1
        MOV     *-SP[1],AL      ; |17|
        MOVZ    AR6,*-SP[1]     ; |18|
        ADD     AR6,#_bufferA   ; |18|
        SUBB    SP,#1           ; |18|
        MOV     AL,*+XAR6[0]    ; |18|
        LRETR
        ;return occurs

        .sect    ".text"
        .global _funcB;

*****
;* FNAME: _funcB              FR SIZE:  1          *
;*                               *
;* FUNCTION ENVIRONMENT        *
;*                               *
;* FUNCTION PROPERTIES         *
;*                               0 Parameter, 1 Auto, 0 SOE *
;*                               *
*****

_funcB:
        ADDB    SP,#1
        MOV     *-SP[1],AL      ; |22|
        MOVZ    AR6,*-SP[1]     ; |23|

```

Example 6-6. Generated Assembly Code From Example 6-5 (continued)

```

ADD     AR6, #_bufferB      ; |23|
SUBB   SP, #1              ; |23|
MOV     AL, *+XAR6[0]      ; |23|
LRETR
;return occurs

```

6.9.6 The DATA_ALIGN Pragma

The DATA_ALIGN pragma aligns the *symbol* in C, or the next symbol declared in C++, to an alignment boundary. The alignment boundary is the maximum of the symbol's default alignment value or the value of the *constant* in bytes. The constant must be a power of 2. The maximum alignment is 32768.

The DATA_ALIGN pragma cannot be used to reduce an object's natural alignment.

The syntax of the pragma in C is:

```
#pragma DATA_ALIGN ( symbol , constant )
```

The syntax of the pragma in C++ is:

```
#pragma DATA_ALIGN ( constant )
```

6.9.7 The DATA_SECTION Pragma

The DATA_SECTION pragma allocates space for the *symbol* in C, or the next symbol declared in C++, in a section named *section name*.

The syntax of the pragma in C is:

```
#pragma DATA_SECTION ( symbol , " section name ")
```

The syntax of the pragma in C++ is:

```
#pragma DATA_SECTION (" section name ")
```

The DATA_SECTION pragma is useful if you have data objects that you want to link into an area separate from the .ebss section.

[Example 6-7](#) through [Example 6-9](#) demonstrate the use of the DATA_SECTION pragma.

Example 6-7. Using the DATA_SECTION Pragma C Source File

```
#pragma DATA_SECTION(bufferB, "my_sect")
char bufferA[512];
char bufferB[512];
```

Example 6-8. Using the DATA_SECTION Pragma C++ Source File

```
char bufferA[512];
#pragma DATA_SECTION("my_sect")
char bufferB[512];
```

Example 6-9. Using the DATA_SECTION Pragma Assembly Source File

```
.global _bufferA
.ebss _bufferA,512,4
.global _bufferB
_bufferB: .usect "my_sect",512,4
```

6.9.8 The Diagnostic Message Pragas

The following pragmas can be used to control diagnostic messages in the same ways as the corresponding command line options:

Pragma	Option	Description
diag_suppress <i>num</i>	-pds= <i>num</i> [, <i>num</i> ₂ , <i>num</i> ₃ ...]	Suppress diagnostic <i>num</i>
diag_remark <i>num</i>	-pdsr= <i>num</i> [, <i>num</i> ₂ , <i>num</i> ₃ ...]	Treat diagnostic <i>num</i> as a remark
diag_warning <i>num</i>	-pdsw= <i>num</i> [, <i>num</i> ₂ , <i>num</i> ₃ ...]	Treat diagnostic <i>num</i> as a warning
diag_error <i>num</i>	-pdse= <i>num</i> [, <i>num</i> ₂ , <i>num</i> ₃ ...]	Treat diagnostic <i>num</i> as an error
diag_default <i>num</i>	n/a	Use default severity of the diagnostic
diag_push	n/a	Push the current diagnostics severity state to store it for later use.
diag_pop	n/a	Pop the most recent diagnostic severity state stored with #pragma diag_push to be the current setting.

The syntax of the diag_suppress, diag_remark, diag_warning, and diag_error pragmas in C is:

```
#pragma diag_XXX [=]num[, num2, num3...]
```

Notice that the names of these pragmas are in lowercase.

The diagnostic affected (*num*) is specified using either an error number or an error tag name. The equal sign (=) is optional. Any diagnostic can be overridden to be an error, but only diagnostic messages with a severity of discretionary error or below can have their severity reduced to a warning or below, or be suppressed. The diag_default pragma is used to return the severity of a diagnostic to the one that was in effect before any pragmas were issued (i.e., the normal severity of the message as modified by any command-line options).

The diagnostic identifier number is output with the message when you use the -pden command line option. The following example suppresses a diagnostic message and then restores the previous diagnostics severity state:

```
#pragma diag_push
#pragma diag_suppress 551
#pragma CHECK_MISRA("-9.1")
#pragma diag_pop
```

6.9.9 The FAST_FUNC_CALL Pragma

The FAST_FUNC_CALL pragma, when applied to a function, generates a TMS320C28x FFC instruction to call the function instead of the CALL instruction. Refer to the *TMS320C28x DSP CPU and Instruction Set User's Guide* for more details on the FFC instruction.

The syntax of the pragma in C is:

```
#pragma FAST_FUNC_CALL ( func )
```

The syntax of the pragma in C++ is:

```
#pragma FAST_FUNC_CALL ( func )
```

The FAST_FUNC_CALL pragma should be applied only to a call to an assembly function that returns with the LB *XAR7 instruction. See [Section 7.5.1](#) for information on combining C/C++ and assembly code.

Since this pragma should be applied only to assembly functions, if the compiler finds a definition for *func* in the file scope, it issues a warning and ignores the pragma.

The following example demonstrates the use of the FAST_FUNC_CALL pragma.

Example 6-10. Using the FAST_FUNC_CALL Pragma Assembly Function

```
_add_long:
    ADD ACC, *-SP[2]
    LB *XAR7
```

Example 6-11. Using the FAST_FUNC_CALL Pragma C Source File

```
#pragma FAST_FUNC_CALL (add_long)

long add_long(long, long);

void foo()
{
    long x, y;
    x = 0xffff;
    y = 0xff;
    y = add_long(x, y);
}
```

Example 6-12. Generated Assembly File

```
*****
;* FNAME: _foo                      FR SIZE: 6          *
;*                                  *
;* FUNCTION ENVIRONMENT              *
;*                                  *
;* FUNCTION PROPERTIES                *
;*                                  2 Parameter, 4 Auto, 0 SOE *
*****

_foo:
    ADDB     SP,#6
    MOVB     ACC,#255
    MOVL     XAR6,#65535          ; |8|
    MOVL     *-SP[6],ACC
    MOVL     *-SP[2],ACC         ; |10|
    MOVL     *-SP[4],XAR6        ; |8|
    MOVL     ACC,*-SP[4]         ; |10|
    FFC      XAR7,#_add_long     ; |10|
    ; call occurs [#_add_long]   ; |10|
    MOVL     *-SP[6],ACC         ; |10|
    SUBB     SP,#6
    LRETR
    ; return occurs
```

6.9.10 The `FUNC_ALWAYS_INLINE` Pragma

The `FUNC_ALWAYS_INLINE` pragma instructs the compiler to always inline the named function. The compiler only inlines the function if it is legal to inline the function and the compiler is invoked with any level of optimization (`--opt_level=0`). See [Section 2.11](#) for details about interaction between various types of inlining.

This pragma must appear before any declaration or reference to the function that you want to inline. In C, the argument *func* is the name of the function that will be inlined. In C++, the pragma applies to the next function declared.

The syntax of the pragma in C is:

```
#pragma FUNC_ALWAYS_INLINE ( func )
```

The syntax of the pragma in C++ is:

```
#pragma FUNC_ALWAYS_INLINE
```

The following example uses this pragma:

```
#pragma FUNC_ALWAYS_INLINE(functionThatMustGetInlined)
static inline void functionThatMustGetInlined(void) {
    P1OUT |= 0x01;
    P1OUT &= ~0x01;
}
```

Use Caution with the `FUNC_ALWAYS_INLINE` Pragma

NOTE: The `FUNC_ALWAYS_INLINE` pragma overrides the compiler's inlining decisions. Overuse of this pragma could result in increased compilation times or memory usage, potentially enough to consume all available memory and result in compilation tool failures.

6.9.11 The `FUNC_CANNOT_INLINE` Pragma

The `FUNC_CANNOT_INLINE` pragma instructs the compiler that the named function cannot be expanded inline. Any function named with this pragma overrides any inlining you designate in any other way, such as using the `inline` keyword. Automatic inlining is also overridden with this pragma; see [Section 2.11](#).

The pragma must appear before any declaration or reference to the function that you want to keep. In C, the argument *func* is the name of the function that cannot be inlined. In C++, the pragma applies to the next function declared.

The syntax of the pragma in C is:

```
#pragma FUNC_CANNOT_INLINE ( func )
```

The syntax of the pragma in C++ is:

```
#pragma FUNC_CANNOT_INLINE
```

6.9.12 The **FUNC_EXT_CALLED** Pragma

When you use the `--program_level_compile` option, the compiler uses program-level optimization. When you use this type of optimization, the compiler removes any function that is not called, directly or indirectly, by `main()`. You might have C/C++ functions that are called by hand-coded assembly instead of `main()`.

The `FUNC_EXT_CALLED` pragma specifies that the optimizer should keep these C functions or any functions these C/C++ functions call. These functions act as entry points into C/C++. The pragma must appear before any declaration or reference to the function to keep. In C, the argument *func* is the name of the function to keep. In C++, the pragma applies to the next function declared.

The syntax of the pragma in C is:

```
#pragma FUNC_EXT_CALLED ( func )
```

The syntax of the pragma in C++ is:

```
#pragma FUNC_EXT_CALLED
```

Except for `_c_int00`, which is the name reserved for the system reset interrupt for C/C++ programs, the name of the interrupt (the *func* argument) does not need to conform to a naming convention.

When you use program-level optimization, you may need to use the `FUNC_EXT_CALLED` pragma with certain options. See [Section 3.3.2](#).

6.9.13 The **FUNCTION_OPTIONS** Pragma

The `FUNCTION_OPTIONS` pragma allows you to compile a specific function in a C or C++ file with additional command-line compiler options. The affected function will be compiled as if the specified list of options appeared on the command line after all other compiler options. In C, the pragma is applied to the function specified. In C++, the pragma is applied to the next function.

The syntax of the pragma in C is:

```
#pragma FUNCTION_OPTIONS ( func, "additional options" )
```

The syntax of the pragma in C++ is:

```
#pragma FUNCTION_OPTIONS( "additional options" )
```

Supported options for this pragma are `--opt_level`, `--auto_inline`, `--code_state`, `--opt_for_space`, and `--opt_for_speed`. In order to use `--opt_level` and `--auto_inline` with the `FUNCTION_OPTIONS` pragma, the compiler must be invoked with some optimization level (that is, at least `--opt_level=0`).

6.9.14 The **INTERRUPT** Pragma

The `INTERRUPT` pragma enables you to handle interrupts directly with C code. In C, the argument *func* is the name of a function. In C++, the pragma applies to the next function declared.

The syntax of the pragma in C is:

```
#pragma INTERRUPT ( func )
```

The syntax of the pragma in C++ is:

```
#pragma INTERRUPT  
void func( void )
```

The GCC interrupt attribute syntax, which has the same effects as the `INTERRUPT` pragma, is as follows. Note that the interrupt attribute can precede either the function's definition or its declaration.

```
__attribute__((interrupt)) void func( void )
```

On the FPU, there are two kinds of interrupts - High Priority Interrupt (HPI) and Low Priority Interrupt (LPI). High priority interrupts use a fast context save and cannot be nested. Low priority interrupts behave like normal C28x interrupts and can be nested.

The kind of interrupt can be specified by way of the interrupt pragma using an optional second argument. The C syntax of the pragma is:

```
#pragma INTERRUPT ( func , {HPI|LPI} )
```

The syntax of the pragma in C++ is:

```
#pragma INTERRUPT ( {HPI|LPI} )
```

The syntax of the GCC attribute, which has the same effects as the INTERRUPT pragma, is:

```
__attribute__((interrupt( "HPI"|"LPI" ))) void func( void )  
{ ... }
```

On FPU, if no interrupt priority is specified LPI is assumed. Interrupts specified with the interrupt keyword also default to LPI.

CLA interrupts and CLA2 background tasks can be created using the interrupt attribute or the INTERRUPT pragma. For example the following could both be used with a CLA interrupt:

```
__attribute__((interrupt))  
void interrupt_name(void) {...}
```

```
#pragma INTERRUPT(interrupt _name);  
void interrupt _name(void) {...}
```

The following examples both create a CLA2 background task:

```
__attribute__((interrupt("BACKGROUND")))  
void task_name(void) {...}
```

```
#pragma INTERRUPT(task_name, "BACKGROUND");  
void task_name(void) {...}
```

Hwi Objects and the INTERRUPT Pragma

NOTE: The INTERRUPT pragma must not be used when SYS/BIOS Hwi objects are used in conjunction with C functions. The Hwi_enter/Hwi_exit macros and the Hwi dispatcher contain this functionality, and the use of the C modifier can cause negative results.

6.9.15 The `MUST_ITERATE` Pragma

The `MUST_ITERATE` pragma specifies to the compiler certain properties of a loop. When you use this pragma, you are guaranteeing to the compiler that a loop executes a specific number of times or a number of times within a specified range.

Any time the `UNROLL` pragma is applied to a loop, `MUST_ITERATE` should be applied to the same loop. For loops the `MUST_ITERATE` pragma's third argument, `multiple`, is the most important and should always be specified.

Furthermore, the `MUST_ITERATE` pragma should be applied to any other loops as often as possible. This is because the information provided via the pragma (especially the minimum number of iterations) aids the compiler in choosing the best loops and loop transformations (that is, nested loop transformations). It also helps the compiler reduce code size.

No statements are allowed between the `MUST_ITERATE` pragma and the `for`, `while`, or `do-while` loop to which it applies. However, other pragmas, such as `UNROLL`, can appear between the `MUST_ITERATE` pragma and the loop.

6.9.15.1 The `MUST_ITERATE` Pragma Syntax

The syntax of the pragma for C and C++ is:

```
#pragma MUST_ITERATE ( min, max, multiple )
```

The arguments *min* and *max* are programmer-guaranteed minimum and maximum trip counts. The trip count is the number of times a loop iterates. The trip count of the loop must be evenly divisible by *multiple*. All arguments are optional. For example, if the trip count could be 5 or greater, you can specify the argument list as follows:

```
#pragma MUST_ITERATE(5)
```

However, if the trip count could be any nonzero multiple of 5, the pragma would look like this:

```
#pragma MUST_ITERATE(5, , 5) /* Note the blank field for max */
```

It is sometimes necessary for you to provide *min* and *multiple* in order for the compiler to perform unrolling. This is especially the case when the compiler cannot easily determine how many iterations the loop will perform (that is, the loop has a complex exit condition).

When specifying a *multiple* via the `MUST_ITERATE` pragma, results of the program are undefined if the trip count is not evenly divisible by *multiple*. Also, results of the program are undefined if the trip count is less than the minimum or greater than the maximum specified.

If no *min* is specified, zero is used. If no *max* is specified, the largest possible number is used. If *multiple* `MUST_ITERATE` pragmas are specified for the same loop, the smallest *max* and largest *min* are used.

6.9.15.2 Using `MUST_ITERATE` to Expand Compiler Knowledge of Loops

Through the use of the `MUST_ITERATE` pragma, you can guarantee that a loop executes a certain number of times. The example below tells the compiler that the loop is guaranteed to run exactly 10 times:

```
#pragma MUST_ITERATE(10,10)
```

```
for(i = 0; i < trip_count; i++) { ...
```

In this example, the compiler attempts to generate a loop even without the pragma. However, if `MUST_ITERATE` is not specified for a loop such as this, the compiler generates code to bypass the loop, to account for the possibility of 0 iterations. With the pragma specification, the compiler knows that the loop iterates at least once and can eliminate the loop-bypassing code.

`MUST_ITERATE` can specify a range for the trip count as well as a factor of the trip count. The following example tells the compiler that the loop executes between 8 and 48 times and the `trip_count` variable is a multiple of 8 (8, 16, 24, 32, 40, 48). The *multiple* argument allows the compiler to unroll the loop.

```
#pragma MUST_ITERATE(8, 48, 8)
```

```
for(i = 0; i < trip_count; i++) { ...
```

You should consider using `MUST_ITERATE` for loops with complicated bounds. In the following example, the compiler would have to generate a divide function call to determine, at run time, the number of iterations performed.

```
for(i2 = ipos[2]; i2 < 40; i2 += 5) { ...
```

The compiler will not do the above. In this case, using `MUST_ITERATE` to specify that the loop always executes eight times allows the compiler to attempt to generate a loop:

```
#pragma MUST_ITERATE(8, 8)
```

```
for(i2 = ipos[2]; i2 < 40; i2 += 5) { ...
```

6.9.16 The `NO_HOOKS` Pragma

The `NO_HOOKS` pragma prevents entry and exit hook calls from being generated for a function.

The syntax of the pragma in C is:

```
#pragma NO_HOOKS ( func )
```

The syntax of the pragma in C++ is:

```
#pragma NO_HOOKS
```

See [Section 2.13](#) for details on entry and exit hooks.

6.9.17 The `RESET_MISRA` Pragma

The `RESET_MISRA` pragma resets the specified MISRA C:2004 rules to the state they were before any `CHECK_MISRA` pragmas (see [Section 6.9.2](#)) were processed. For instance, if a rule was enabled on the command line but disabled in the source, the `RESET_MISRA` pragma resets it to enabled. This pragma accepts the same format as the `--check_misra` option, except for the "none" keyword.

The `--check_misra` compiler command-line option must be used to enable MISRA C:2004 rule checking in order for this pragma to function at the source level.

The syntax of the pragma in C is:

```
#pragma RESET_MISRA (" {all|required|advisory|rulespec} ")
```

The *rulespec* parameter is a comma-separated list of rule numbers. See [Section 6.3](#) for details.

6.9.18 The `RETAIN` Pragma

The `RETAIN` pragma can be applied to a code or data symbol. It causes a `.retain` directive to be generated into the section that contains the definition of the symbol. The `.retain` directive indicates to the linker that the section is ineligible for removal during conditional linking. Therefore, regardless whether or not the section is referenced by another section in the application that is being compiled and linked, it will be included in the output file result of the link.

The syntax of the pragma in C is:

```
#pragma RETAIN ( symbol )
```

The syntax of the pragma in C++ is:

```
#pragma RETAIN
```

The `CLINK` pragma has the opposite effect of the `RETAIN` pragma. See [Section 6.9.3](#) for more details.

6.9.19 The `SET_CODE_SECTION` and `SET_DATA_SECTION` Pragmas

These pragmas can be used to set the section for all declarations below the pragma.

The syntax of the pragmas in C/C++ is:

```
#pragma SET_CODE_SECTION ("section name")
```

```
#pragma SET_DATA_SECTION ("section name")
```

In [Example 6-13](#) `x` and `y` are put in the section `mydata`. To reset the current section to the default used by the compiler, a blank parameter should be passed to the pragma. An easy way to think of the pragma is that it is like applying the `CODE_SECTION` or `DATA_SECTION` pragma to all symbols below it.

Example 6-13. Setting Section With `SET_DATA_SECTION` Pragma

```
#pragma SET_DATA_SECTION("mydata")
int x;
int y;
#pragma SET_DATA_SECTION()
```

The pragmas apply to both declarations and definitions. If applied to a declaration and not the definition, the pragma that is active at the declaration is used to set the section for that symbol. Here is an example:

Example 6-14. Setting a Section With `SET_CODE_SECTION` Pragma

```
#pragma SET_CODE_SECTION("func1")
extern void func1();
#pragma SET_CODE_SECTION()
...
void func1() { ... }
```

In [Example 6-14](#) `func1` is placed in section `func1`. If conflicting sections are specified at the declaration and definition, a diagnostic is issued.

The current `CODE_SECTION` and `DATA_SECTION` pragmas and GCC attributes can be used to override the `SET_CODE_SECTION` and `SET_DATA_SECTION` pragmas. For example:

Example 6-15. Overriding `SET_DATA_SECTION` Setting

```
#pragma DATA_SECTION(x, "x_data")
#pragma SET_DATA_SECTION("mydata")
int x;
int y;
#pragma SET_DATA_SECTION()
```

In [Example 6-15](#) `x` is placed in `x_data` and `y` is placed in `mydata`. No diagnostic is issued for this case.

The pragmas work for both C and C++. In C++, the pragmas are ignored for templates and for implicitly created objects, such as implicit constructors and virtual function tables.

6.9.20 The UNROLL Pragma

No statements are allowed between the UNROLL pragma and the for, while, or do-while loop to which it applies. However, other pragmas, such as MUST_ITERATE, can appear between the UNROLL pragma and the loop.

The syntax of the pragma for C and C++ is:

```
#pragma UNROLL( n )
```

If possible, the compiler unrolls the loop so there are *n* copies of the original loop. The compiler only unrolls if it can determine that unrolling by a factor of *n* is safe. In order to increase the chances the loop is unrolled, the compiler needs to know certain properties:

- The loop iterates a multiple of *n* times. This information can be specified to the compiler via the multiple argument in the MUST_ITERATE pragma.
- The smallest possible number of iterations of the loop
- The largest possible number of iterations of the loop

The compiler can sometimes obtain this information itself by analyzing the code. However, sometimes the compiler can be overly conservative in its assumptions and therefore generates more code than is necessary when unrolling. This can also lead to not unrolling at all. Furthermore, if the mechanism that determines when the loop should exit is complex, the compiler may not be able to determine these properties of the loop. In these cases, you must tell the compiler the properties of the loop by using the MUST_ITERATE pragma.

Specifying #pragma UNROLL(1) asks that the loop not be unrolled. Automatic loop unrolling also is not performed in this case.

If multiple UNROLL pragmas are specified for the same loop, it is undefined which pragma is used, if any.

6.10 The _Pragma Operator

The C28x C/C++ compiler supports the C99 preprocessor _Pragma() operator. This preprocessor operator is similar to #pragma directives. However, _Pragma can be used in preprocessing macros (#defines).

The syntax of the operator is:

```
_Pragma (" string_literal ");
```

The argument *string_literal* is interpreted in the same way the tokens following a #pragma directive are processed. The *string_literal* must be enclosed in quotes. A quotation mark that is part of the *string_literal* must be preceded by a backward slash.

You can use the _Pragma operator to express #pragma directives in macros. For example, the DATA_SECTION syntax:

```
#pragma DATA_SECTION( func , " section ")
```

Is represented by the _Pragma() operator syntax:

```
_Pragma ("DATA_SECTION( func , \" section \")")
```

The following code illustrates using _Pragma to specify the DATA_SECTION pragma in a macro:

```
...
#define EMIT_PRAGMA(x) _Pragma(#x)
#define COLLECT_DATA(var) EMIT_PRAGMA(DATA_SECTION(var, "mysection"))

COLLECT_DATA(x)
int x;
...
```

The EMIT_PRAGMA macro is needed to properly expand the quotes that are required to surround the section argument to the DATA_SECTION pragma.

6.11 Object File Symbol Naming Conventions (Linknames)

Each externally visible identifier is assigned a unique symbol name to be used in the object file, a so-called *linkname*. This name is assigned by the compiler according to an algorithm which depends on the name, type, and source language of the symbol. This algorithm may add a prefix to the identifier (typically an underscore), and it may *mangle* the name.

For COFF, the compiler places an underscore at the beginning of the linknames of C identifiers, so you can safely use identifiers that do not begin with an underscore in your assembly code.

Name mangling encodes the types of the parameters of a function in the linkname for a function. Name mangling only occurs for C++ functions which are not declared 'extern "C"'. Mangling allows function overloading, operator overloading, and type-safe linking. Be aware that the return value of the function is not encoded in the mangled name, as C++ functions cannot be overloaded based on the return value.

The mangling algorithm used closely follows that described in The Annotated Reference Manual (ARM).

For example, the general form of a C++ linkname for a function named `func` is:

`_func__F parmcodes`

Where `parmcodes` is a sequence of letters that encodes the parameter types of `func`.

For this simple C++ source file:

```
int foo(int i){ } //global C++ function
```

This is the resulting assembly code:

```
_foo__Fi
```

The linkname of `foo` is `_foo__Fi`, indicating that `foo` is a function that takes a single argument of type `int`. To aid inspection and debugging, a name demangling utility is provided that demangles names into those found in the original C++ source. See [Chapter 9](#) for more information.

6.12 Initializing Static and Global Variables

The ANSI/ISO C standard specifies that global (extern) and static variables without explicit initializations must be initialized to 0 before the program begins running. This task is typically done when the program is loaded. Because the loading process is heavily dependent on the specific environment of the target application system, the compiler itself makes no provision for initializing to 0 otherwise uninitialized static storage class variables at run time. It is up to your application to fulfill this requirement.

Initialize Global Objects

NOTE: You should explicitly initialize all global objects which you expected the compiler would set to zero by default.

6.12.1 Initializing Static and Global Variables With the Linker

If your loader does not preinitialize variables, you can use the linker to preinitialize the variables to 0 in the object file. For example, in the linker command file, use a fill value of 0 in the `.ebss` section:

```
SECTIONS
{
    ...
    .ebss: {} = 0x00;
    ...
}
```

Because the linker writes a complete load image of the zeroed `.ebss` section into the output COFF file, this method can have the unwanted effect of significantly increasing the size of the output file (but not the program).

If you burn your application into ROM, you should explicitly initialize variables that require initialization. The preceding method initializes `.ebss` to 0 only at load time, not at system reset or power up. To make these variables 0 at run time, explicitly define them in your code.

For more information about linker command files and the SECTIONS directive, see the linker description information in the *TMS320C28x Assembly Language Tools User's Guide*.

6.12.2 Initializing Static and Global Variables With the const Type Qualifier

Static and global variables of type *const* without explicit initializations are similar to other static and global variables because they might not be preinitialized to 0 (for the same reasons discussed in [Section 6.12](#)). For example:

```
const int zero;      /* might not be initialized to 0 */
```

However, the initialization of *const* global and static variables is different because these variables are declared and initialized in a section called `.econst`. For example:

```
const int zero = 0  /* guaranteed to be 0 */
```

This corresponds to an entry in the `.econst` section:

```
.sect   .econst
_zero
.word   0
```

This feature is particularly useful for declaring a large table of constants, because neither time nor space is wasted at system startup to initialize the table. Additionally, the linker can be used to place the `.econst` section in ROM.

You can use the `DATA_SECTION` pragma to put the variable in a section other than `.econst`. For example, the following C code:

```
#pragma DATA_SECTION (var, ".mysect")
const int zero=0;
```

is compiled into this assembly code:

```
.sect   .mysect
_zero
.word   0
```

6.13 Changing the ANSI/ISO C/C++ Language Mode

The language mode command-line options determine how the compiler interprets your source code. You specify one option to identify which language standard your code follows. You can also specify a separate option to specify how strictly the compiler should expect your code to conform to the standard.

Specify one of the following language options to control the language standard that the compiler expects the source to follow. The options are:

- ANSI/ISO C89 (`--c89`, default for C files)
- ANSI/ISO C99 (`--c99`, see [Section 6.13.1](#).)
- ISO C++03 (`--c++03`, used for all C++ files)

Use one of the following options to specify how strictly the code conforms to the standard:

- Relaxed ANSI/ISO (`--relaxed_ansi` or `-pr`) This is the default.
- Strict ANSI/ISO (`--strict_ansi` or `-ps`)

The default is relaxed ANSI/ISO mode. Under relaxed ANSI/ISO mode, the compiler accepts language extensions that could potentially conflict with ANSI/ISO C/C++. Under strict ANSI mode, these language extensions are suppressed so that the compiler will accept all strictly conforming programs. (See [Section 6.13.2](#).)

6.13.1 C99 Support (--c99)

The compiler supports the 1999 standard of C as standardized by the ISO. However, the following list of run-time functions and features are *not* implemented or fully supported:

- complex.h
- ctype.h
 - isblank()
- fenv.h
- float.h
 - DECIMAL_DIG
 - FLT_EVAL_METHOD
- inttypes.h
 - wcstoimax() / wcstoumax()
- math.h: The math library used by the compiler in C99 mode has been changed. Full C99 math support is now available, including long double (64-bit) and float versions of floating point math routines. See the [list of standard math.h C99 routines](#).
- stdarg.h
 - va_copy macro
- stdio.h
 - %a and %A format specifiers for hexadecimal float
 - The %e specifier may produce "-0" when "0" is expected by the standard
 - snprintf() does not properly pad with spaces when writing to a wide character array
- stdlib.h
 - strtod() / atof() / strtod() / strtold() do not support hexadecimal float strings
 - vfscanf() / vscanf() / vsscanf() return value on floating point matching failure is incorrect
- tgmath.h
- time.h
 - strftime()
- wchar.h
 - getws() / fputws()
 - mbrlen()
 - mbsrtowcs()
 - wcscat()
 - wcschr()
 - wcscmp() / wcsncmp()
 - wcsncpy() / wcsncpy()
 - wcsftime()
 - wcsrtombs()
 - wcsstr()
 - wcstok()
 - wcsxfrm()
 - Wide character print / scan functions
 - Wide character conversion functions

6.13.2 Strict ANSI Mode and Relaxed ANSI Mode (`--strict_ansi` and `--relaxed_ansi`)

Under relaxed ANSI/ISO mode (the default), the compiler accepts language extensions that could potentially conflict with a strictly conforming ANSI/ISO C/C++ program. Under strict ANSI mode, these language extensions are suppressed so that the compiler will accept all strictly conforming programs.

Use the `--strict_ansi` option when you know your program is a conforming program and it will not compile in relaxed mode. In this mode, language extensions that conflict with ANSI/ISO C/C++ are disabled and the compiler will emit error messages where the standard requires it to do so. Violations that are considered discretionary by the standard may be emitted as warnings instead.

Examples:

The following is strictly conforming C code, but will not be accepted by the compiler in the default relaxed mode. To get the compiler to accept this code, use strict ANSI mode. The compiler will suppress the `interrupt` keyword language extension, and `interrupt` may then be used as an identifier in the code.

```
int main()
{
    int interrupt = 0;
    return 0;
}
```

The following is not strictly conforming code. The compiler will not accept this code in strict ANSI mode. To get the compiler to accept it, use relaxed ANSI mode. The compiler will provide the `interrupt` keyword extension and will accept the code

```
interrupt void isr(void);

int main()
{
    return 0;
}
```

The following code is accepted in all modes. The `__interrupt` keyword does not conflict with the ANSI/ISO C standard, so it is always available as a language extension.

```
__interrupt void isr(void);

int main()
{
    return 0;
}
```

The default mode is relaxed ANSI. This mode can be selected with the `--relaxed_ansi` (or `-pr`) option. Relaxed ANSI mode accepts the broadest range of programs. It accepts all TI language extensions, even those which conflict with ANSI/ISO, and ignores some ANSI/ISO violations for which the compiler can do something reasonable. Some GCC language extensions described in [Section 6.14](#) may conflict with strict ANSI/ISO standards, but many do not conflict with the standards.

6.14 GNU and Clang Language Extensions

The GNU compiler collection (GCC) defines a number of language features not found in the ANSI/ISO C and C++ standards. The definition and examples of these extensions (for GCC version 4.7) can be found at the GNU web site, <http://gcc.gnu.org/onlinedocs/gcc-4.7.2/gcc/C-Extensions.html#C-Extensions>. Most of these extensions are also available for C++ source code.

The compiler also supports the following Clang macro extensions, which are described in the [Clang 6 Documentation](#):

- `__has_feature` (up to tests described for Clang 3.5)
- `__has_extension` (up to tests described for Clang 3.5)
- `__has_include`
- `__has_include_next`
- `__has_builtin`
- `__has_attribute`

6.14.1 Extensions

Most of the GCC language extensions are available in the TI compiler when compiling in relaxed ANSI mode (`--relaxed_ansi`).

The extensions that the TI compiler supports are listed in [Table 6-3](#), which is based on the list of extensions found at the GNU web site. The shaded rows describe extensions that are not supported.

Table 6-3. GCC Language Extensions

Extensions	Descriptions
Statement expressions	Putting statements and declarations inside expressions (useful for creating smart 'safe' macros)
Local labels	Labels local to a statement expression
Labels as values	Pointers to labels and computed gotos
Nested functions	As in Algol and Pascal, lexical scoping of functions
Constructing calls	Dispatching a call to another function
Naming types ⁽¹⁾	Giving a name to the type of an expression
typeof operator	typeof referring to the type of an expression
Generalized lvalues	Using question mark (?) and comma (,) and casts in lvalues
Conditionals	Omitting the middle operand of a ?: expression
long long	Double long word integers and long long int type
Hex floats	Hexadecimal floating-point constants
Complex	Data types for complex numbers
Zero length	Zero-length arrays
Variadic macros	Macros with a variable number of arguments
Variable length	Arrays whose length is computed at run time
Empty structures	Structures with no members
Subscripting	Any array can be subscripted, even if it is not an lvalue.
Escaped newlines	Slightly looser rules for escaped newlines
Multi-line strings ⁽¹⁾	String literals with embedded newlines
Pointer arithmetic	Arithmetic on void pointers and function pointers
Initializers	Non-constant initializers
Compound literals	Compound literals give structures, unions, or arrays as values
Designated initializers	Labeling elements of initializers
Cast to union	Casting to union type from any member of the union
Case ranges	'Case 1 ... 9' and such
Mixed declarations	Mixing declarations and code

⁽¹⁾ Feature defined for GCC 3.0; definition and examples at <http://gcc.gnu.org/onlinedocs/gcc-4.7.2/gcc/C-Extensions.html#C-Extensions>

Table 6-3. GCC Language Extensions (continued)

Extensions	Descriptions
Function attributes	Declaring that functions have no side effects, or that they can never return
Attribute syntax	Formal syntax for attributes
Function prototypes	Prototype declarations and old-style definitions
C++ comments	C++ comments are recognized.
Dollar signs	A dollar sign is allowed in identifiers.
Character escapes	The character ESC is represented as <code>\e</code>
Variable attributes	Specifying the attributes of variables
Type attributes	Specifying the attributes of types
Alignment	Inquiring about the alignment of a type or variable
Inline	Defining inline functions (as fast as macros)
Assembly labels	Specifying the assembler name to use for a C symbol
Extended asm	Assembler instructions with C operands
Constraints	Constraints for asm operands
Wrapper headers	Wrapper header files can include another version of the header file using <code>#include_next</code>
Alternate keywords	Header files can use <code>__const__</code> , <code>__asm__</code> , etc
Explicit reg vars	Defining variables residing in specified registers
Incomplete enum types	Define an enum tag without specifying its possible values
Function names	Printable strings which are the name of the current function
Return address	Getting the return or frame address of a function (limited support)
Other built-ins	Other built-in functions (see Section 6.14.5)
Vector extensions	Using vector instructions through built-in functions
Target built-ins	Built-in functions specific to particular targets
Pragmas	Pragmas accepted by GCC
Unnamed fields	Unnamed struct/union fields within structs/unions
Thread-local	Per-thread variables
Binary constants	Binary constants using the <code>'0b'</code> prefix.

6.14.2 Function Attributes

The following GCC function attributes are supported:

- `alias`
- `always_inline`
- `const`
- `constructor`
- `deprecated`
- `format`
- `format_arg`
- `interrupt`
- `malloc`
- `noinline`
- `noreturn`
- `pure`
- `ramfunc`
- `section`
- `unused`
- `used`

- `warn_unused_result`

For example, this function declaration uses the **alias** attribute to make "my_alias" a function alias for the "myFunc" function:

```
void my_alias() __attribute__((alias("myFunc")));
```

The **format** attribute is applied to the declarations of `printf`, `fprintf`, `sprintf`, `snprintf`, `vprintf`, `vfprintf`, `vsprintf`, `vsnprintf`, `scanf`, `fscanf`, `vfscanf`, `vscanf`, `vsscanf`, and `sscanf` in `stdio.h`. Thus when GCC extensions are enabled, the data arguments of these functions are type checked against the format specifiers in the format string argument and warnings are issued when there is a mismatch. These warnings can be suppressed in the usual ways if they are not desired.

See [Section 6.9.14](#) for more about using the **interrupt** function attribute.

The **malloc** attribute is applied to the declarations of `malloc`, `calloc`, `realloc` and `memalign` in `stdlib.h`.

The **ramfunc** attribute specifies that a function will be placed in and executed from RAM. The `ramfunc` attribute allows the compiler to optimize functions for RAM execution, as well as to automatically copy functions to RAM on flash-based devices. For example:

```
__attribute__((ramfunc))
void f(void) {
    ...
}
```

The `--ramfunc=on` option specifies that all functions compiled with this option are placed in and executed from RAM, even if this function attribute is not used.

Newer TI linker command files support the `ramfunc` attribute automatically by placing functions with this attribute in the `.TI.ramfunc` section. If you have a linker command file that does not include a section specification for the `.TI.ramfunc` section, you can modify the linker command file to place this section in RAM. See the [Placing functions in RAM](#) wiki page for more about the `ramfunc` attribute and option. See the *TMS320C28x Assembly Language Tools User's Guide* for details on section placement.

Fast branch instructions are generated for `ramfunc` functions. Regular branch instructions are generated for all other functions.

The `ramfunc` attribute is ignored by the CLA compiler.

6.14.3 Variable Attributes

The following variable attributes are supported: `aligned`, `deprecated`, `mode`, `section`, `transparent_union`, `unused`, and `used`.

The **used** attribute is defined in GCC 4.2 (see <http://gcc.gnu.org/onlinedocs/gcc-4.2.4/gcc/Variable-Attributes.html#Variable-Attributes>).

6.14.4 Type Attributes

The following type attributes are supported: `aligned`, `byte_peripheral`, `deprecated`, `transparent_union`, and `unused`.

You cannot create arrays using the **aligned** type attribute with an alignment larger than the size of the type. This is because the C language guarantees that the size of an array is the same as the size of each element times the number of elements. This might not be the case if an array used the `aligned` type attribute, because padding could be added to the array.

See [Section 6.14.6](#) for details about the **byte_peripheral** type attribute.

6.14.5 Built-In Functions

The following built-in functions are supported: `__builtin_abs`, `__builtin_classify_type`, `__builtin_constant_p`, `__builtin_expect`, `__builtin_fabs`, `__builtin_fabsf`, `__builtin_frame_address`, `__builtin_labs`, `__builtin_memcpy`, and `__builtin_return_address`.

The `__builtin_frame_address` function always returns zero.

The `__builtin_return_address` function always returns zero.

6.14.6 Using the Byte Peripheral Type Attribute

The C2000 architecture has 16-bit words. Some peripherals, however, are 8-bit byte addressable. The byte peripherals bridge translates addresses between the CPU and byte peripherals by treating an address as a byte address. Therefore, only some C2000 addresses map correctly to the byte peripherals. Even and odd addresses to 16-bit data both map to the same data element on the byte peripheral.

The same is true for addresses to 32-bit data. Addresses for 16-bit accesses must be 32-bit aligned and those for 32-bit accesses must be 64-bit aligned.

C2000 driver libraries and bitfield header files are provided to access peripherals. To support correct accesses to byte peripheral data, the compiler provides the `__byte_peripheral_32` intrinsic and the `byte_peripheral` type attribute.

The C2000 driver library accesses byte peripheral data at the correct starting address. However, on the C2000, operations on 32-bit data are often broken up into two operations on 16-bit data because these are more efficient on the architecture. Accesses to 32-bit byte peripheral data cannot be broken up regularly into two 16-bit accesses because the starting offset for the second 16-bits will be incorrect. The `__byte_peripheral_32` intrinsic can be used to access a 32-bit byte peripheral data address, preventing these accesses from being broken up. The intrinsic returns a reference to an unsigned long and can be used both to read and write data. See [Section 7.5.6](#) for information about this intrinsic.

The `byte_peripheral` type attribute can be applied as follows to typedefs of unsigned ints and unsigned longs for bitfield support.

```
typedef unsigned int bp_16 __attribute__((byte_peripheral));
typedef unsigned long bp_32 __attribute__((byte_peripheral));
```

The typedef names are not significant. The attributes automatically apply the volatile keyword and handle alignment. All struct members in byte peripheral structs, whether they are bitfields or not, must have these attributes applied via typedefs to ensure proper alignment of the struct accesses. Note that struct layout is different due to differences in alignment, so the bitfields cannot always be accessed via the same container types as in regular structs.

For example, the bit positions for byte peripheral bitfield types are compared in the following examples to the positions of regular bitfields. Because 16-bit accesses must be 32-bit aligned, it is not possible to access bits at offsets 16-31 with a 16-bit container. To access these bits, a 32-bit container must be used. In example 1, you could create the same layout as in the regular case by changing the field types to `bp_32` for field4 through field6. In example 2, you would change the field types to `bp_32` for field2 through field4.

```
struct example1 {           // regular bits position //byte peripherals
    bp_16 field1:9;         // 0-8                // 0-8
    bp_16 field2:6;         // 9-14                // 9-14
    bp_32 field3:4;         // 15-18                // 15-18
    bp_16 field4:1;         // 19                    // 32
    bp_16 field5:5;         // 20-24                // 33-37
    bp_16 field6:7;         // 25-31                // 38-44
};

struct example2{           // regular bits position //byte peripherals
    bp_32 field1:29;        // 0-28                // 0-28
    bp_16 field2:1;         // 29                    // 32
    bp_16 field3:1;         // 30                    // 33
    bp_16 field4:1;         // 31                    // 34
};
```

Because the alignment will create padding in any objects that are declared, it is recommended that you cast byte peripheral addresses as byte peripheral struct types instead of declaring objects of those struct types.

You cannot create arrays using the byte peripheral type attribute. This is because the C language guarantees that the size of an array is the same as the size of each element times the number of elements. This would not be the case in an array of byte peripherals, because there would need to be padding in the array.

6.15 Compiler Limits

Due to the variety of host systems supported by the C/C++ compiler and the limitations of some of these systems, the compiler may not be able to successfully compile source files that are excessively large or complex. In general, exceeding such a system limit prevents continued compilation, so the compiler aborts immediately after printing the error message. Simplify the program to avoid exceeding a system limit.

Some systems do not allow filenames longer than 500 characters. Make sure your filenames are shorter than 500.

The compiler has no arbitrary limits but is limited by the amount of memory available on the host system. On smaller host systems such as PCs, the optimizer may run out of memory. If this occurs, the optimizer terminates and the shell continues compiling the file with the code generator. This results in a file compiled with no optimization. The optimizer compiles one function at a time, so the most likely cause of this is a large or extremely complex function in your source module. To correct the problem, your options are:

- Don't optimize the module in question.
- Identify the function that caused the problem and break it down into smaller functions.
- Extract the function from the module and place it in a separate module that can be compiled without optimization so that the remaining functions can be optimized.

Run-Time Environment

This chapter describes the TMS320C28x C/C++ run-time environment. To ensure successful execution of C/C++ programs, it is critical that all run-time code maintain this environment. It is also important to follow the guidelines in this chapter if you write assembly language functions that interface with C/C++ code.

Topic	Page
7.1 Memory Model.....	137
7.2 Register Conventions.....	141
7.3 Function Structure and Calling Conventions.....	143
7.4 Accessing Linker Symbols in C and C++	146
7.5 Interfacing C and C++ With Assembly Language	146
7.6 Interrupt Handling.....	158
7.7 Integer Expression Analysis	159
7.8 Floating-Point Expression Analysis	160
7.9 System Initialization.....	160

7.1 Memory Model

The C28x compiler treats memory as two linear blocks of program and data memory:

- Program memory contains executable code, initialization records, and switch tables.
- Data memory contains external variables, static variables, and the system stack.

Blocks of code or data generated by a C/C++ program are placed into contiguous blocks in the appropriate memory space.

The Linker Defines the Memory Map

NOTE: The linker, not the compiler, defines the memory map and allocates code and data into target memory. The compiler assumes nothing about the types of memory available, about any locations not available for code or data (holes), or about any locations reserved for I/O or control purposes. The compiler produces relocatable code that allows the linker to allocate code and data into the appropriate memory spaces. For example, you can use the linker to allocate global variables into on-chip RAM or to allocate executable code into external ROM. You can allocate each block of code or data individually into memory, but this is not a general practice (an exception to this is memory-mapped I/O, although you can access physical memory locations with C/C++ pointer types).

7.1.1 Sections

The compiler produces relocatable blocks of code and data called *sections*. The sections are allocated into memory in a variety of ways to conform to a variety of system configurations. For more information about sections and allocating them, see the introductory object file information in the *TMS320C28x Assembly Language Tools User's Guide*.

There are two basic types of sections:

- **Initialized sections** contain data or executable code. Initialized sections are usually, but not always, read-only. The C/C++ compiler creates the following initialized sections:
 - The **.binit section** contains boot time copy tables. This is a read-only section. For details on BINIT, see the *TMS320C28x Assembly Language Tools User's Guide* for linker command file information.
 - The **.cinit section** and the **.pinit section** contain tables for initializing variables and constants. These are read-only sections. The C28x .cinit record is limited to 16 bits. This limits initialized objects to 64K.
 - The **.ovly section** contains copy tables other than boot time (.binit) copy tables. This is a read-only section.
 - The **.econst section** contains string constants, string literals, switch tables, the declaration and initialization of global and static variables, and data defined with the C/C++ qualifier *const* (provided the constant is not also defined as *volatile* or one of the exceptions described in [Section 6.5.1](#)). This is a read-only section. String literals are placed in the .econst.string subsection to enable greater link-time placement control.
 - The **.switch section** contains tables for switch statements.
 - The **.text section** contains all the executable code and compiler-generated constants. This section is usually read-only.
 - The **.TI.crctab section** contains CRC checking tables. This is a read-only section.
- **Uninitialized sections** reserve space in memory (usually RAM). A program can use this space at run time to create and store variables. The compiler creates the following uninitialized sections:
 - The **.ebss section** reserves space for global and static variables defined. At program startup time, the C/C++ boot routine copies data out of the .cinit section (which can be in ROM) and uses it for initializing variables in the .ebss section.
 - The **.stack section** reserves memory for the C/C++ software stack. This memory is used to pass arguments to functions and to allocate space for local variables.
 - The **.esysmem section** reserves space for dynamic memory allocation. The reserved space is used by dynamic memory allocation routines, such as malloc, calloc, realloc, or new. If a C/C++

program does not use these functions, the compiler does not create the `.esymem` section.

The assembler creates the default sections `.text`, `.ebss`, and `.data`. You can instruct the compiler to create additional sections by using the `CODE_SECTION` and `DATA_SECTION` pragmas (see [Section 6.9.5](#) and [Section 6.9.7](#)).

The linker takes the individual sections from different object files and combines sections that have the same name. The resulting output sections and the appropriate placement in memory for each section are listed in [Table 7-1](#). You can place these output sections anywhere in the address space as needed to meet system requirements.

Table 7-1. Summary of Sections and Memory Placement

Section	Type of Memory	Page	Section	Type of Memory	Page
<code>.cinit</code>	ROM or RAM	0	<code>.pinit</code>	ROM or RAM	0
<code>.data</code>	RAM		<code>.stack</code>	RAM	1
<code>.ebss</code>	RAM		<code>.switch</code>	ROM or RAM	0, 1
<code>.econst</code>	ROM or RAM	1	<code>.text</code>	ROM or RAM	0
<code>.esymem</code>	RAM	1			

You can use the `SECTIONS` directive in the linker command file to customize the section-allocation process. For more information about allocating sections into memory, see the linker description chapter in the *TMS320C28x Assembly Language Tools User's Guide*.

7.1.2 C/C++ System Stack

The C/C++ compiler uses a stack to:

- Allocate local variables
- Pass arguments to functions
- Save the processor status
- Save function return addresses
- Save temporary results

The run-time stack grows up from low addresses to higher addresses. By default, the stack is allocated in the `.stack` section. (See the run-time-support `boot.asm` file.) The compiler uses the hardware stack pointer (SP) to manage this stack.

Linking the `.stack` Section

NOTE: The `.stack` section has to be linked into the low 64K of data memory. The SP is a 16-bit register and cannot access addresses beyond 64K.

For frames that exceed 63 words in size (the maximum reach of the SP offset addressing mode), the compiler uses XAR2 as a frame pointer (FP). Each function invocation creates a new frame at the top of the stack, from which local and temporary variables are allocated. The FP points at the beginning of this frame to access memory locations that cannot be referenced directly using the SP.

The stack size is set by the linker. The linker also creates a global symbol, `__STACK_SIZE__`, and assigns it a value equal to the size of the stack in bytes. The default stack size is 1K words. You can change the size of the stack at link time by using the `--stack_size` linker option.

Stack Overflow

NOTE: The compiler provides no means to check for stack overflow during compilation or at run time. A stack overflow disrupts the run-time environment, causing your program to fail. Be sure to allow enough space for the stack to grow. You can use the `--entry_hook` option to add code to the beginning of each function to check for stack overflow; see [Section 2.13](#).

7.1.3 Allocating .econst to Program Memory

If your system configuration does not support allocating an initialized section such as .econst to data memory, then you have to allocate the .econst section to load in program memory and run in data memory. At boot time, copy the .econst section from program to data memory. The following sequence shows how you can perform this task.

1. Extract boot.asm from the source library:

```
ar2000 -x rts.src boot.asm
```

2. Edit boot.asm and change the CONST_COPY flag to 1:

```
CONST_COPY .set 1
```

3. Assemble boot.asm:

```
cl2000 boot.asm
```

4. Archive the boot routine into the object library:

```
ar2000 -r rts2800_ml.lib boot.obj
```

For an .econst section, link with a linker command file that contains the following entries:

```
SECTIONS
{
...
.econst : load = PROG PAGE 1, run = DATA PAGE 1
{
/* GET RUN ADDRESS */
__econst_run = .;
/* MARK LOAD ADDRESS */
*(.ec_mark)
/* ALLOCATE .econst */
*(.econst)
/* COMPUTE LENGTH */
__econst_length = - __econst_run;
}
}
```

In your linker command file, you can substitute the name PROG with the name of a memory area on page 0 and DATA with the name of a memory area on page 1. The rest of the command file must use the names as above. The code in boot.asm that is enabled when you change CONST_COPY to 1 depends on the linker command file using these names in this manner. To change any of the names, you must edit boot.asm and change the names in the same way.

7.1.4 Dynamic Memory Allocation

The run-time-support library supplied with the C28x compiler contains several functions (such as malloc, calloc, and realloc) that allow you to allocate memory dynamically for variables at run time.

Memory is allocated from a global pool, or heap, that is defined in the .esysmem section. You can set the size of the .esysmem section by using the --heap_size=size option with the linker command. The linker also creates a global symbol, __SYSMEM_SIZE, and assigns it a value equal to the size of the heap in words. The default size is 1K words. For more information on the --heap_size option, see the linker description chapter in the *TMS320C28x Assembly Language Tools User's Guide*.

If you use any C I/O function, the RTS library allocates an I/O buffer for each file you access. This buffer will be a bit larger than BUFSIZ, which is defined in stdio.h and defaults to 256. Make sure you allocate a heap large enough for these buffers or use setvbuf to change the buffer to a statically-allocated buffer.

Dynamically allocated objects are not addressed directly (they are always accessed with pointers) and the memory pool is in a separate section (.esysmem); therefore, the dynamic memory pool can have a size limited only by the amount of available memory in your system. To conserve space in the .ebss section, you can allocate large arrays from the heap instead of defining them as global or static. For example, instead of a definition such as:

```
struct big table[100];
```

Use a pointer and call the malloc function:

```
struct big *table
table = (struct big *)malloc(100*sizeof(struct big));
```

When allocating from a heap, make sure the size of the heap is large enough for the allocation. This is particularly important when allocating variable-length arrays. For example, allocating a variable-length array requires at least 1500 words of heap memory.

7.1.5 Initialization of Variables

The C/C++ compiler produces code that is suitable for use as firmware in a ROM-based system. In such a system, the initialization tables in the `.cinit` section are stored in ROM. At system initialization time, the C/C++ boot routine copies data from these tables (in ROM) to the initialized variables in `.ebss` (RAM).

When a program is loaded directly from an object file into memory and run, you can avoid having the `.cinit` section occupy space in memory. A loader can read the initialization tables directly from the object file (instead of from ROM) and perform the initialization directly at load time instead of at run time. You can specify this to the linker by using the `--ram_model` link option. For more information, see [Section 7.9](#).

7.1.6 Allocating Memory for Static and Global Variables

A unique, contiguous space is allocated for all static variables declared in a C/C++ program. The linker determines the address of the space. The compiler ensures that space for these variables is allocated in multiples of words so that each variable is aligned on a word boundary.

The compiler expects global variables to be allocated into data memory. (It reserves space for them in `.ebss`.) Variables declared in the same module are allocated into a single, contiguous block of memory.

7.1.7 Field/Structure Alignment

When the compiler allocates space for a structure, it allocates as many words as are needed to hold all of the structure's members and to comply with alignment constraints for each member.

All non-field types are aligned on word boundaries. Fields are allocated as many bits as requested. Adjacent fields are packed into adjacent bits of a word, but they do not overlap words. If a field would overlap into the next word, the entire field is placed into the next word.

Fields are packed as they are encountered; the least significant bits of the structure word are filled first.

7.1.8 Character String Constants

In C, a character string constant is used in one of the following ways:

- To initialize an array of characters. For example:

```
char s[] = "abc";
```

When a string is used as an initializer, it is simply treated as an initialized array; each character is a separate initializer. For more information about initialization, see [Section 7.9](#).

- In an expression. For example:

```
strcpy (s, "abc");
```

When a string is used in an expression, the string itself is defined in the `.econst` section with the `.string` assembler directive, along with a unique label that points to the string; the terminating 0 byte is included. For example, the following lines define the string `abc`, and the terminating 0 byte (the label `SL5` points to the string):

```
.sect ".econst"
SL5: .string "abc",0
```

String labels have the form `SL n` , where n is a number assigned by the compiler to make the label unique. The number begins at 0 and is increased by 1 for each string defined. All strings used in a source module are defined at the end of the compiled assembly language module.

The label `SL n` represents the address of the string constant. The compiler uses this label to reference the string expression.

Because strings are stored in the `.econst` section (possibly in ROM) and shared, it is bad practice for a program to modify a string constant. The following code is an example of incorrect string use:

```
const char *a = "abc"
a[1] = 'x'; /* Incorrect! undefined behavior */
```

7.2 Register Conventions

Strict conventions associate specific registers with specific operations in the C/C++ environment. If you plan to interface an assembly language routine to a C/C++ program, you must understand and follow these register conventions.

The register conventions dictate how the compiler uses registers and how values are preserved across function calls. There are two types of register variable registers, save on entry and save on call. The distinction between these two types of registers is the method by which they are preserved across function calls. It is the called function's responsibility to preserve save-on-entry registers, and the calling function's responsibility to preserve save-on-call registers if you need to preserve that register's value.

7.2.1 TMS320C28x Register Use and Preservation

[Table 7-2](#) summarizes how the compiler uses the TMS320C28x registers and shows which registers are defined to be preserved across function calls.

The FPU uses all the C28x registers as well as the registers described in [Table 7-3](#).

Table 7-2. Register Use and Preservation Conventions

Register	Usage	Save on Entry	Save on Call
AL	Expressions, argument passing, and returns 16-bit results from functions	No	Yes
AH	Expressions and argument passing	No	Yes
DP	Data page pointer (used to access global variables)	No	No
PH	Multiply expressions and Temp variables	No	Yes
PL	Multiply expressions and Temp variables	No	Yes
SP	Stack pointer		⁽¹⁾
T	Multiply and shift expressions	No	Yes
TL	Multiply and shift expressions	No	Yes
XAR0	Pointers and expressions	No	Yes
XAR1	Pointers and expressions	Yes	No
XAR2	Pointers, expressions, and frame pointing (when needed)	Yes	No
XAR3	Pointers and expressions	Yes	No
XAR4	Pointers, expressions, argument passing, and returns 32-bit pointer values from functions	No	Yes
XAR5	Pointers, expressions, and arguments	No	Yes
XAR6	Pointers and expressions	No	Yes
XAR7	Pointers, expressions, indirect calls and branches (used to implement pointers to functions and switch statements)	No	Yes

⁽¹⁾ The SP is preserved by the convention that everything pushed on the stack is popped off before returning.

Table 7-3. FPU Register Use and Preservation Conventions

Register	Usage	Save on Entry	Save on Call
R0H	Expressions, argument passing, and returns 32-bit float from functions	No	Yes
R1H	Expressions and argument passing	No	Yes
R2H	Expressions and argument passing	No	Yes
R3H	Expressions and argument passing	No	Yes
R4H	Expressions	Yes	No
R5H	Expressions	Yes	No
R6H	Expressions	Yes	No
R7H	Expressions	Yes	No

7.2.2 Status Registers

Table 7-4 shows all of the status fields used by the compiler. Presumed value is the value the compiler expects in that field upon entry to, or return from, a function; a dash in this column indicates the compiler does not expect a particular value. The modified column indicates whether code generated by the compiler ever modifies this field.

Table 7-4. Status Register Fields

Field	Name	Presumed Value	Modified
ARP	Auxiliary Register Pointer	-	Yes
C	Carry	-	Yes
N	Negative flag	-	Yes
OVM	Overflow mode	0 ⁽¹⁾	Yes
PAGE0	Direct/stack address mode	0 ⁽¹⁾	No
PM	Product shift mode	0 ⁽¹⁾	Yes
SPA	Stack pointer align bit	-	Yes (in interrupts)
SXM	Sign extension mode	-	Yes
TC	Test/control flag	-	Yes
V	Overflow flag	-	Yes
Z	Zero flag	-	Yes

⁽¹⁾ The initialization routine that sets up the C run-time environment sets these fields to the presumed value.

Table 7-5 shows the additional status fields used by the compiler for FPU Targets.

Table 7-5. Floating-Point Status Register (STF⁽¹⁾) Fields For FPU Targets Only

Field	Name	Presumed Value	Modified
LVF ⁽²⁾ ⁽³⁾	Latched overflow float flag	-	Yes
LUF ⁽²⁾ ⁽³⁾	Latched underflow float flag	-	Yes
NF ⁽²⁾	Negative float flag	-	Yes
ZF ⁽²⁾	Zero float flag	-	Yes
NI ⁽²⁾	Negative integer flag	-	Yes
ZI ⁽²⁾	Zero integer flag bit	-	Yes
TF ⁽²⁾	Test flag bit	-	Yes
RNDF32	Round F32 mode ⁽⁴⁾	-	Yes
RNDF64	Round F64 mode ⁽⁴⁾	-	Yes
SHDWS	Shadow mode status	-	Yes

⁽¹⁾ Unused STF register bits read 0 and writes are ignored.

⁽²⁾ Specified flags in the STF register can be exported to the ST0 register by way of the MOVST0 instruction.

⁽³⁾ The LVF and LUF flag signals can be connected to the PIE to generate an overflow-and-underflow interrupt. This can be a useful debug tool.

⁽⁴⁾ If RNDF32 or RNDF64 is 0, mode is round to zero (truncate), otherwise mode is round to nearest (even).

All other status register fields are not used and do not affect code generated by the compiler.

7.3 Function Structure and Calling Conventions

The C/C++ compiler imposes a strict set of rules on function calls. Except for special run-time support functions, any function that calls or is called by a C/C++ function must follow these rules. Failure to adhere to these rules can disrupt the C/C++ environment and cause a program to fail.

Figure 7-1 illustrates a typical function call. In this example, parameters that cannot be placed in registers are passed to the function on the stack. The function then allocates local variables and calls another function. This example shows the allocated local frame and argument block for the called function. Functions that have no local variables and do not require an argument block do not allocate a local frame.

The term *argument block* refers to the part of the local frame used to pass arguments to other functions. Parameters are passed to a function by moving them into the argument block rather than pushing them on the stack. The local frame and argument block are allocated at the same time.

Figure 7-1. Use of the Stack During a Function Call

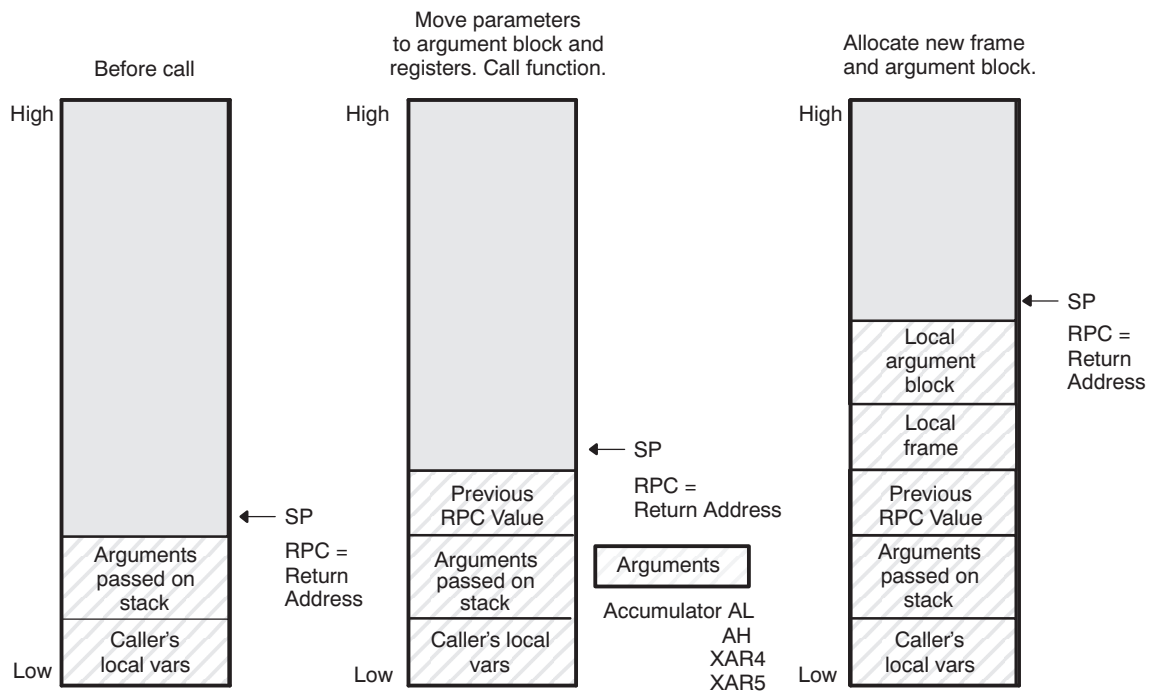

7.3.1 How a Function Makes a Call

A function (parent function) performs the following tasks when it calls another function (child function).

1. Any registers whose values are not necessarily preserved by the function being called (registers that are not save-on-entry (SOE) registers), but will be needed after the function returns are saved on the stack.
2. If the called function returns a structure, the calling function allocates the space for the structure and pass the address of that space to the called function as the first argument.
3. Arguments passed to the called function are placed in registers and, when necessary, placed on the stack.

Arguments are placed in registers using the following scheme:

- a. If the target is FPU and there are any 32-bit float arguments, the first four float arguments are placed in registers R0H-R3H.
- b. If there are any 64-bit floating point arguments (long doubles), they are passed by reference.
- c. If there are any 64-bit integer arguments (long long), the first is placed in ACC and P (ACC holds the upper 32 bits and P holds the lower 32 bits). All other 64-bit integer arguments are placed on the stack in reverse order.

If the P register is used for argument passing, then prolog/epilog abstraction is disabled for that

function. See [Section 3.13](#) for more information on abstraction.

- d. If there are any 32-bit arguments (longs or floats), the first is placed in the 32-bit ACC (AH/AL). All other 32-bit arguments are placed on the stack in reverse order.

```
func1(long a, long long b, int c, int* d);
      stack ACC/P XAR5, XAR4
```

- e. Pointer arguments are placed in XAR4 and XAR5. All other pointers are placed on the stack.
 - f. Remaining 16-bit arguments are placed in the order AL, AH, XAR4, XAR5 if they are available.
4. Any remaining arguments not placed in registers are pushed on the stack in reverse order. That is, the leftmost argument that is placed on the stack is pushed on the stack last. All 32-bit arguments are aligned to even addresses on the stack.

A structure argument is passed as the address of the structure. The called function must make a local copy.

For a function declared with an ellipsis, indicating that it is called with varying numbers of arguments, the convention is slightly modified. The last explicitly declared argument is passed on the stack so that its stack address can act as a reference for accessing the undeclared arguments.

5. The stack pointer (SP) must be even-aligned by the parent function prior to making a call to the child function. This is done by incrementing the stack pointer by 1, if necessary. If needed, the coder should increment the SP before making the call.

Some examples of function calls that show where arguments are placed are listed below:

```
func1 (int a, int b, long c)
      XAR4 XAR5 AH/AL
func1 (long a, int b, long c) ;
      AH/AL XAR4 stack
vararg (int a, int b, int c, ...)
      AL AH stack
```

6. The caller calls the function using the LCR instruction. The RPC register value is pushed on the stack. The return address is then stored in the RPC register.
7. The stack is aligned at function boundary.

7.3.2 How a Called Function Responds

A called function (child function) must perform the following tasks:

1. If the called function modifies XAR1, XAR2, or XAR3, it must save them, since the calling function assumes that the values of these registers are preserved upon return. If the target is FPU, then in addition to the C28x registers, the called function must save registers R4H, R5H, R6H or R7H, if it modifies any of them. Any other registers may be modified without preserving them.
2. The called function allocates enough space on the stack for any local variables, temporary storage area, and arguments to functions that this function might call. This allocation occurs once at the beginning of the function by adding a constant to the SP register.
3. The stack is aligned at function boundary.
4. If the called function expects a structure argument, it receives a pointer to the structure instead. If writes are made to the structure from within the called function, space for a local copy of the structure must be allocated on the stack and the local structure must be copied from the passes pointer to the structure. If no writes are made to the structure, it can be referenced in the called function indirectly through the pointer argument.

You must be careful to properly declare functions that accept structure arguments, both at the point where they are called (so that the structure argument is passed as an address) and at the point where they are declared (so the function knows to copy the structure to a local copy).

5. The called function executes the code for the function.
6. The called function returns a value. It is placed in a register using the following convention:

16-bit integer value	AL
32-bit integer value	ACC
64-bit integer value	ACC/P
32-bit pointer	XAR4
structure reference	XAR6

If the target is FPU and a 32-bit float value is returned, the called function places this value in R0H.

If the function returns a structure, the caller allocates space for the structure and passes the address of the return space to the called function in XAR6. To return a structure, the called function copies the structure to the memory block pointed by the extra argument.

In this way, the caller can be smart about telling the called function where to return the structure. For example, in the statement $s = f(x)$, where S is a structure and F is a function that returns a structure, the caller can actually make the call as $f(\&s, x)$. The function f then copies the return structure directly into s , performing the assignment automatically.

If the caller does not use the return structure value, an address value of 0 can be passed as the first argument. This directs the called function not to copy the return structure.

You must be careful to properly declare functions that return structures both at the point where they are called (so that the extra argument is passed) and at the point where they are declared (so the function knows to copy the result). Returning 64-bit floating-point values (long double) are returned similarly to structures.

7. The called function deallocates the frame by subtracting the value that was added to the SP earlier.
8. The called function restores the values of all registers saved in Step 1.
9. The called function returns using the LRETR instruction. The PC is set to the value in the RPC register. The previous RPC value is popped from the stack and stored in the RPC register.

7.3.3 Special Case for a Called Function (Large Frames)

If the space that needs to be allocated on the stack (step 2 in the previous section) is larger than 63 words, additional steps and resources are required to ensure that all local nonregister variables can be accessed. Large frames require using a frame pointer register (XAR2) to reference local non-register variables within the frame. Prior to allocating space on the frame, the frame pointer is set up to point at the first argument on the stack that was passed on to the called function. If no incoming arguments are passed on to the stack, the frame pointer points to the return address of the calling function, which is at the top of the stack upon entry to the called function.

Avoid allocating large amounts of local data when possible. For example, do not declare large arrays within functions.

7.3.4 Accessing Arguments and Local Variables

A function accesses its local nonregister variables and its stack arguments indirectly through either the SP or the FP (frame pointer, designated to be XAR2). All local and argument data that can be accessed with the SP use the $*-SP$ [offset] addressing mode since the SP always points one past the top of the stack and the stack grows toward larger addresses.

The PAGE0 Mode Bit Must Be Reset

NOTE: Since the compiler uses the $*-SP$ [offset] addressing mode, the PAGE0 mode bit must be reset (set to 0).

The largest offset available using $*-SP$ [offset] is 63. If an object is too far away from the SP to use this mode of access, the compiler uses the FP (XAR2). Since FP points at the bottom of the frame, accesses made with the FP use either $*+FP$ [offset] or $*+FP$ [AR0/AR1] addressing modes. Since large frames require utilizing XAR2 and possibly an index register, extra code and resources are required to make local accesses.

7.3.5 Allocating the Frame and Accessing 32-Bit Values in Memory

Some TMS320C28x instructions read and write 32 bits of memory at once (MOVL, ADDL, etc.). These instructions require that 32-bit objects be allocated on an even boundary. To ensure that this occurs, the compiler takes these steps:

1. It initializes the SP to an even boundary.
2. Because a call instruction adds 2 to the SP, it assumes that the SP is pointing at an even address.
3. It makes sure that the space allocated on the frame totals an even number, so that the SP points to an even address.
4. It makes sure that 32-bit objects are allocated to even addresses, relative to the known even address in the SP.
5. Because interrupts cannot assume that the SP is odd or even, it aligns the SP to an even address.

For more information on how these instructions access memory, see the *TMS320C28x Assembly Language Tools User's Guide*.

7.4 Accessing Linker Symbols in C and C++

See the section on "Using Linker Symbols in C/C++ Applications" in the *TMS320C28x Assembly Language Tools User's Guide* for information about referring to linker symbols in C/C++ code.

7.5 Interfacing C and C++ With Assembly Language

The following are ways to use assembly language with C/C++ code:

- Use separate modules of assembled code and link them with compiled C/C++ modules (see [Section 7.5.1](#)).
- Use assembly language variables and constants in C/C++ source (see [Section 7.5.3](#)).
- Use inline assembly language embedded directly in the C/C++ source (see [Section 7.5.5](#)).
- Use intrinsics in C/C++ source to directly call an assembly language statement (see [Section 7.5.6](#)).

7.5.1 Using Assembly Language Modules With C/C++ Code

Interfacing C/C++ with assembly language functions is straightforward if you follow the calling conventions defined in [Section 7.3](#), and the register conventions defined in [Section 7.2](#). C/C++ code can access variables and call functions defined in assembly language, and assembly code can access C/C++ variables and call C/C++ functions.

Follow these guidelines to interface assembly language and C:

- All functions, whether they are written in C/C++ or assembly language, must follow the register conventions outlined in [Section 7.2](#).
- Dedicated registers modified by a function must be preserved. Dedicated registers include:

XAR1	R4H (FPU only)
XAR2	R5H (FPU only)
XAR3	R6H (FPU only)
SP	R7H (FPU only)

If the SP is used normally, it does not need to be preserved explicitly. The assembly function is free to use the stack as long as anything that is pushed on the stack is popped back off before the function returns (thus preserving the SP).

Any register that is not dedicated can be used freely without being preserved.

- The stack pointer (SP) must be even-aligned by the parent function prior to making a call to the child function. This is done by incrementing the stack pointer by 1, if necessary. If needed, the coder should increment the SP before making the call.
- The stack is aligned at function boundary.
- Interrupt routines must save *all* the registers they use. For more information, see [Section 7.6](#).

- When you call a C/C++ function from assembly language, load the designated registers with arguments and push the remaining arguments onto the stack as described in [Section 7.3.1](#). When accessing arguments passed in from a C/C++ function, these same conventions apply.
- Longs and floats are stored in memory with the least significant word at the lower address.
- Structures are returned as described in [Section 7.3.2](#).
- No assembly module should use the .cinit section for any purpose other than autoinitialization of global variables. The C/C++ startup routine assumes that the .cinit section consists *entirely* of initialization tables. Disrupting the tables by putting other information in .cinit can cause unpredictable results.
- The compiler prepends an underscore (`_`) to the beginning of all identifiers. In assembly language modules, you must use the prefix `_` for all objects that are to be accessible from C/C++. For example, a C/C++ object named `x` is called `_x` in assembly language. For identifiers that are to be used only in an assembly language module or modules, any name that does not begin with an underscore can be safely used without conflicting with a C/C++ identifier.
- The compiler assigns linknames to all external objects. Thus, when you write assembly language code, you must use the same linknames as those assigned by the compiler. See [Section 6.11](#) for details.
- Any object or function declared in assembly language that is accessed or called from C/C++ must be declared with the `.def` or `.global` directive in the assembly language modifier. This declares the symbol as external and allows the linker to resolve references to it.
Likewise, to access a C/C++ function or object from assembly language, declare the C/C++ object with the `.ref` or `.global` directive in the assembly language module. This creates an undeclared external reference that the linker resolves.
- Because compiled code runs with the PAGE0 mode bit reset, if you set the PAGE0 bit to 1 in your assembly language function, you must set it back to 0 before returning to compiled code.
- If you define a structure in assembly and access it in C using `extern struct`, the structure should be blocked. The compiler assumes that structure definitions are blocked to optimize the DP load. So the definition should honor this assumption. You can block the structure by specifying the blocking flag in the `.usect` directive. See the *TMS320C28x Assembly Language Tools User's Guide* for more information on these directives.

7.5.2 Accessing Assembly Language Functions From C/C++

Functions defined in C++ that will be called from assembly should be defined as `extern "C"` in the C++ file. Functions defined in assembly that will be called from C++ must be prototyped as `extern "C"` in C++.

[Example 7-1](#) illustrates a C++ function called `main`, which calls an assembly language function called `asmfunc`, [Example 7-2](#). The `asmfunc` function takes its single argument, adds it to the C++ global variable called `gvar`, and returns the result.

Example 7-1. Calling an Assembly Language Function From a C/C++ Program

```
extern "C"{
extern int asmfunc(int a); /* declare external asm function */
int gvar = 0;             /* define global variable          */
}

void main()
{
    int i = 5;
    i = asmfunc(i);      /* call function normally          */
}
```

Example 7-2. Assembly Language Program Called by [Example 7-1](#)

```

.global _gvar
.global _asmfunc

_asmfunc:
    MOVZ    DP,#_gvar
    ADDB   AL,#5
    MOV    @_gvar,AL
    LRETR
  
```

In the C++ program in [Example 7-1](#), the extern “C” declaration tells the compiler to use C naming conventions (i.e., no name mangling). When the linker resolves the `.global _asmfunc` reference, the corresponding definition in the assembly file will match.

The parameter `i` is passed in register AL.

7.5.3 Accessing Assembly Language Variables From C/C++

It is sometimes useful for a C/C++ program to access variables or constants defined in assembly language. There are several methods that you can use to accomplish this, depending on where and how the item is defined: a variable defined in the `.ebss` section, a variable not defined in the `.ebss` section, or a linker symbol.

7.5.3.1 Accessing Assembly Language Global Variables

Accessing variables from the `.ebss` section or a section named with `.usect` is straightforward:

1. Use the `.usect` directive to define the variable.
2. Use the `.def` or `.global` directive to make the definition external.
3. Use the appropriate linkname in assembly language.
4. In C/C++, declare the variable as *extern* and access it normally.

[Example 7-4](#) and [Example 7-3](#) show how you can access a variable defined in `.ebss`.

Example 7-3. Assembly Language Variable Program

```

* Note the use of underscores in the following lines

.ebss    _var,1    ; Define the variable
.global  _var      ; Declare it as external
  
```

Example 7-4. C Program to Access Assembly Language From [Example 7-3](#)

```

extern int var;    /* External variable */
var = 1;          /* Use the variable */
  
```

7.5.3.2 Accessing Assembly Language Constants

You can define global constants in assembly language by using the `.set` directive in combination with either the `.def` or `.global` directive, or you can define them in a linker command file using a linker assignment statement. These constants are accessible from C/C++ only with the use of special operators.

For **variables** defined in C/C++ or assembly language, the symbol table contains the *address of the value* contained by the variable. When you access an assembly variable by name from C/C++, the compiler gets the value using the address in the symbol table.

For **assembly constants**, however, the symbol table contains the actual *value* of the constant. The compiler cannot tell which items in the symbol table are addresses and which are values. If you access an assembly (or linker) constant by name, the compiler tries to use the value in the symbol table as an address to fetch a value. To prevent this behavior, you must use the `&` (address of) operator to get the value (`_symval`). In other words, if `x` is an assembly language constant, its value in C/C++ is `&x`. See the section on "Using Linker Symbols in C/C++ Applications" in the *TMS320C28x Assembly Language Tools User's Guide* for more examples that use `_symval`.

For more about symbols and the symbol table, refer to the section on "Symbols" in the *TMS320C28x Assembly Language Tools User's Guide*.

You can use casts and `#defines` to ease the use of these symbols in your program, as in [Example 7-5](#) and [Example 7-6](#).

Example 7-5. Accessing an Assembly Language Constant From C

```
extern int table_size;          /*external ref */
#define TABLE_SIZE ((int) (&table_size))
    .                          /* use cast to hide address-of */
    .
    .
for (I=0; i<TABLE_SIZE; ++I) /* use like normal symbol */
```

Example 7-6. Assembly Language Program for Example 7-5

```
_table_size .set    10000      ; define the constant
            .global _table_size ; make it global
```

Because you are referencing only the symbol's value as stored in the symbol table, the symbol's declared type is unimportant. In [Example 7-5](#), `int` is used. You can reference linker-defined symbols in a similar manner.

7.5.4 Sharing C/C++ Header Files With Assembly Source

You can use the `.cdecls` assembler directive to share C headers containing declarations and prototypes between C and assembly code. Any legal C/C++ can be used in a `.cdecls` block and the C/C++ declarations will cause suitable assembly to be generated automatically, allowing you to reference the C/C++ constructs in assembly code. For more information, see the C/C++ header files chapter in the *TMS320C28x Assembly Language Tools User's Guide*.

7.5.5 Using Inline Assembly Language

Within a C/C++ program, you can use the `asm` statement to insert a single line of assembly language into the assembly language file created by the compiler. A series of `asm` statements places sequential lines of assembly language into the compiler output with no intervening code. For more information, see [Section 6.8](#).

The `asm` statement is useful for inserting comments in the compiler output. Simply start the assembly code string with a semicolon (;) as shown below:

```
asm(";*** this is an assembly language comment");
```

NOTE: Using the `asm` Statement

Keep the following in mind when using the `asm` statement:

- Be extremely careful not to disrupt the C/C++ environment. The compiler does not check or analyze the inserted instructions.
 - Avoid inserting jumps or labels into C/C++ code because they can produce unpredictable results by confusing the register-tracking algorithms that the code generator uses.
 - Do not change the value of a C/C++ variable when using an `asm` statement. This is because the compiler does not verify such statements. They are inserted as is into the assembly code, and potentially can cause problems if you are not sure of their effect.
 - Do not use the `asm` statement to insert assembler directives that change the assembly environment.
 - Avoid creating assembly macros in C code and compiling with the `--symdebug:dwarf` (or `-g`) option. The C environment's debug information and the assembly macro expansion are not compatible.
-

7.5.6 Using Intrinsics to Access Assembly Language Statements

The C28x compiler recognizes a number of intrinsic operators. Intrinsics allow you to express the meaning of certain assembly statements that would otherwise be cumbersome or inexpressible in C/C++. Intrinsics are used like functions; you can use C/C++ variables with these intrinsics, just as you would with any normal function.

The intrinsics are specified with a leading double underscore, and are accessed by calling them as you do a function. For example:

```
long lvar;
int  ivar;
unsigned int uivar;

lvar = __mpyxu(ivar, uivar);
```

The intrinsics listed in [Table 7-6](#) are included. They correspond to the indicated TMS320C28x assembly language instruction(s). See the *TMS320C28x CPU and Instruction Set Reference Guide* for more information.

Table 7-6. TMS320C28x C/C++ Compiler Intrinsics

Intrinsic	Assembly Instruction(s)	Description
int __abs16_sat (int <i>src</i>);	SETC OVM MOV AH, src ABS ACC MOV dst, AH CLRC OVM	Clear the OVM status bit. Load <i>src</i> into AH. Take absolute value of ACC. Store AH into <i>dst</i> . Clear the OVM status bit.
void __add (int * <i>m</i> , int <i>b</i>);	ADD * m, b	Add the contents of memory location <i>m</i> to <i>b</i> and store the result in <i>m</i> , in an atomic way.
long __addcu (long <i>src1</i> , unsigned int <i>src2</i>);	ADDCU ACC, {mem reg}	The contents of <i>src2</i> and the value of the carry bit are added to ACC. The result is in ACC.
void __addl (long * <i>m</i> , long <i>b</i>);	ADDL * m, b	Add the contents of memory location <i>m</i> to <i>b</i> and store the result in <i>m</i> , in an atomic way.
void __and (int * <i>m</i> , int <i>b</i>);	AND * m, b	AND the contents of memory location <i>m</i> to <i>b</i> and store the result in <i>m</i> , in an atomic way.
int & __byte (int * <i>array</i> , unsigned int <i>byte_index</i>);	MOVB array [byte_index].LSB, src or MOVB dst, array [byte_index].LSB	The lowest addressable unit in C28x is 16 bits. Therefore, normally you cannot access 8-bit entities off a memory location. This intrinsic helps access an 8-bit quantity off a memory location, and can be invoked as follows: <code>__byte(array,5) = 10;</code> <code>b = __byte(array,20);</code>
unsigned long &y __byte_peripheral_32 (unsigned long * <i>x</i>);		Used to access a 32-bit byte peripheral data address without the access being broken in half. The intrinsic returns a reference to an unsigned long and can be used both to read and write data. See Section 6.14.6 .
void __dec (int * <i>m</i>);	DEC * m	Decrement the contents of memory location <i>m</i> in an atomic way.
unsigned int __disable_interrupts ();	PUSH ST1 SETC INTM, DBGM POP reg16	Disable interrupts and return the old value of the interrupt vector.
void __dmac (long * <i>src1</i> , long * <i>src2</i> , long & <i>accum1</i> , long & <i>accum2</i> , int <i>shift</i>);	SPM n ; the PM value required for <i>shift</i> MOVL ACC, accum1 MOVL P, accum2 MOVL XARx, src1 MOVL XAR7, src2 DMAC ACC:P, *XARx++, *XAR7++	Set the required PM value for shift. Move <i>accum1</i> and <i>accum2</i> into ACC and P. Move the addresses <i>src1</i> and <i>src2</i> into XARx and XAR7. ACC = ACC + (<i>src1</i> [<i>i</i> +1] * <i>src2</i> [<i>i</i> +1]) << PM P = P + (<i>src1</i> [<i>i</i>] * <i>src2</i> [<i>i</i>]) << PM See Section 3.14.3 for more information.
void __eallow (void);	EALLOW	Permits the CPU to write freely to protected registers.
void __edis (void);	EDIS	Prevents the CPU from writing freely to protected registers after EALLOW is used.

Table 7-6. TMS320C28x C/C++ Compiler Intrinsics (continued)

Intrinsic	Assembly Instruction(s)	Description
unsigned int __enable_interrupts ();	PUSH ST1 CLRC INTM, DBGM POP reg16	Enable interrupts and return the old value of the interrupt vector.
long __euclidean_div_i32byu32 (long <i>numerator</i> , unsigned long <i>denominator</i> , unsigned long & <i>remainder</i>);		Performs signed by unsigned long modulus and division. Returns the quotient. This variant is efficient and better suited for control applications than the C-language standard. It varies from the C-language standard in that the quotient does not round towards 0 and the "remainder" is a true modulus calculation.
int __flip16 (int <i>src</i>);		Reverses order of bits in int <i>src</i> .
long __flip32 (long <i>src</i>);		Reverses order of bits in long <i>src</i> .
long long __flip64 (long long <i>src</i>);		Reverses order of bits in long long <i>src</i> .
void __inc (int * <i>m</i>);	INC *m	Increment the contents of memory location <i>m</i> in an atomic way.
long= __IQ (long double <i>A</i> , int <i>N</i>);		Convert the long double <i>A</i> into the correct IQN value returned as a long type. If both arguments are constants the compiler converts the arguments to the IQ value during compile time. Otherwise a call to the RTS routine, __IQ , is made. This intrinsic cannot be used to initialize global variables to the .cinit section.
long <i>dst</i> = __IQmpy (long <i>A</i> , long <i>B</i> , int <i>N</i>);	If $N == 0$: IMPYL {ACC P}, XT, B If $0 < N < 16$: IMPYL P, XT, B QMPYL ACC, XT, B ASR64 ACC:P, # N If $15 < N < 32$: IMPYL P, XT, B QMPYL ACC, XT, B LSL64 ACC:P, #{32- N} If $N == 32$: QMPYL {ACC P}, XT, B If <i>N</i> is a variable: IMPYL P, XT, B QMPYL ACC, XT, B MOV T, N LSR64 ACC:P, T	Perform optimized multiplication using the C28 IQmath library. The <i>dst</i> becomes ACC or P, <i>A</i> becomes XT: The <i>dst</i> is ACC or P. If <i>dst</i> is ACC, the instruction takes 2 cycles. If <i>dst</i> is P, the instruction takes 1 cycle.
long <i>dst</i> = __IQsat (long <i>A</i> , long <i>max</i> , long <i>min</i>);	If <i>max</i> and <i>min</i> are 22-bit unsigned constants: MOVL ACC, A MOVL XAR n, # 22bits MINL ACC, P MOVL XAR n, # 22bits MAXL ACC, P If <i>max</i> and <i>min</i> are other constants: MOVL ACC, A MOV PL, # max lower 16 bits MOV PH, # max upper 16 bits MINL ACC, P MOV PL, # min lower 16 bits MOV PH, # min upper 16 bits MAXL ACC, P If <i>max</i> and/or <i>min</i> are variables: MOVL ACC, A MINL ACC, max MAXL ACC, min	The <i>dst</i> becomes ACC. Different code is generated based on the value of <i>max</i> and/or <i>min</i> .
long <i>dst</i> = __IQxmpy (long <i>A</i> , long <i>B</i> , int <i>N</i>);	If $N == 0$: IMPYL ACC/P, XT, B	Perform optimized multiplication by a power of 2 using the C28 IQmath library. The <i>dst</i> becomes ACC or P; <i>A</i> becomes XT. Code is generated based on the value of <i>N</i> . The <i>dst</i> is in ACC or P.

Table 7-6. TMS320C28x C/C++ Compiler Intrinsics (continued)

Intrinsic	Assembly Instruction(s)	Description
If $0 < N < 17$:	IMPYL P, XT, B QMPYL ACC, XT, B LSL64 ACC:P, # N	The <i>dst</i> is in ACC.
If $0 > N > -17$:	QMPYL ACC, XT, B SETC SXM SFR ACC, #abs(N)	The <i>dst</i> is in ACC.
If $16 < N < 32$:	IMPYL P, XT, B QMPYL ACC, XT, B ASR64 ACC:P, # N	The <i>dst</i> is in P.
If $N == 32$:	IMPYL P, XT, B	The <i>dst</i> is in P.
If $-16 > N > -33$:	QMPYL ACC, XT, B SETC SXM SRF ACC, #16 SRF ACC, #abs(N)-16	The <i>dst</i> is in ACC.
If $32 < N < 49$:	IMPYL ACC, XT, B LSL ACC, # N-32	The <i>dst</i> is in ACC.
If $-32 > N > -49$:	QMPYL ACC, XT, B SETC SXM SFR ACC, #16 SFR ACC, #16	The <i>dst</i> is in ACC.
If $48 < N < 65$:	IMPYL ACC, XT, B LSL64 ACC:P, #16 LSL64 ACC:P, # N-48	The <i>dst</i> is in ACC.
If $-48 > N > -65$:	QMPYL ACC, XT, B SETC SXM SFR ACC, #16 SFR ACC, #16	The <i>dst</i> is in ACC.
long long __llmax (long long <i>dst</i> , long long <i>src</i>);	MAXL ACC, src.hi32 MAXCUL P, src.lo32	If <i>src</i> > <i>dst</i> , copy <i>src</i> to <i>dst</i> .
long long __llmin (long long <i>dst</i> , long long <i>src</i>);	MINL ACC, src.hi32 MINCUL P, src.lo32	If <i>src</i> < <i>dst</i> , copy <i>src</i> to <i>dst</i>
long __lmax (long <i>dst</i> , long <i>src</i>);	MAXL ACC, src	If <i>src</i> > <i>dst</i> , copy <i>src</i> to <i>dst</i> .
long __lmin (long <i>dst</i> , long <i>src</i>);	MINL ACC, src	If <i>src</i> < <i>dst</i> , copy <i>src</i> to <i>dst</i>
int __max (int <i>dst</i> , int <i>src</i>);	MAX dst, src	If <i>src</i> > <i>dst</i> , copy <i>src</i> to <i>dst</i>
int __min (int <i>dst</i> , int <i>src</i>);	MIN dst, src	If <i>src</i> < <i>dst</i> , copy <i>src</i> to <i>dst</i>
int __mov_byte (int * <i>src</i> , unsigned int <i>n</i>);	MOVB AX.LSB,*+XARx[n] or MOVZ AR0/AR1, @ n MOVB AX.LSB,*XARx[{AR0 AR1}]	Return the 8-bit <i>n</i> th element of a byte table pointed to by <i>src</i> . This intrinsic is provided for backward compatibility. The intrinsic __byte is preferred as it returns a reference. Nothing can be done with __mov_byte () that cannot be done with __byte () .
long __mpy (int <i>src1</i> , int <i>src2</i>);	MPY ACC, src1, # src2	Move <i>src1</i> to the T register. Multiply T by a 16-bit immediate (<i>src2</i>). The result is in ACC.
long __mpyb (int <i>src1</i> , uint <i>src2</i>);	MPYB {ACC P}, T, # src2	Multiply <i>src1</i> (the T register) by an unsigned 8-bit immediate (<i>src2</i>). The result is in ACC or P.
long __mpy_mov_t (int <i>src1</i> , int <i>src2</i> , int * <i>dst2</i>);	MPY ACC, T, src2 MOV @ dst2, T	Multiply <i>src1</i> (the T register) by <i>src2</i> . The result is in ACC. Move <i>src1</i> to * <i>dst2</i> .
unsigned long __mpyu (unit <i>src2</i> , unit <i>src2</i>);	MPYU {ACC P}, T,src2	Multiply <i>src1</i> (the T register) by <i>src2</i> . Both operands are treated as unsigned 16-bit numbers. The result is in ACC or P.
long __mpyxu (int <i>src1</i> , uint <i>src2</i>);	MPYXU ACC, T, {mem reg}	The T register is loaded with <i>src1</i> . The <i>src2</i> is referenced by memory or loaded into a register. The result is in ACC.
long <i>dst</i> = __norm32 (long <i>src</i> , int * <i>shift</i>);	CSB ACC LSLL ACC, T MOV @ shift, T	Normalize <i>src</i> into <i>dst</i> and update * <i>shift</i> with the number of bits shifted.

Table 7-6. TMS320C28x C/C++ Compiler Intrinsics (continued)

Intrinsic	Assembly Instruction(s)	Description
long long <i>dst</i> = __norm64 (long long <i>src</i> , int * <i>shift</i>);	CSB ACC LSL64 ACC:P, T MOV @ <i>shift</i> , T CSB ACC LSL64 ACC:P, T MOV TMP16, AH MOV AH, T ADD <i>shift</i> , AH MOV AH, TMP16	Normalize 64-bit <i>src</i> into <i>dst</i> and update * <i>shift</i> with the number of bits shifted.
void __or (int * <i>m</i> , int <i>b</i>);	OR * <i>m</i> , <i>b</i>	OR the contents of memory location <i>m</i> to <i>b</i> and store the result in <i>m</i> , in an atomic way.
long __qmpy32 (long <i>src32a</i> , long <i>src32b</i> , int <i>q</i>);	CLRC OVM SPM - 1 MOV T, <i>src32a</i> + 1 MPYXU P, T, <i>src32b</i> + 0 MOVP T, <i>src32b</i> + 1 MPYXU P, T, <i>src32a</i> + 0 MPYA P, T, <i>src32a</i> + 1 If <i>q</i> = 31,30: SPM <i>q</i> - 30 SFR ACC, #45 - <i>q</i> ADDL ACC, P If <i>q</i> = 29: SFR ACC, #16 ADDL ACC, P If <i>q</i> = 28 through 24: SPM <i>q</i> - 30 SFR ACC, #16 SFR ACC, #29 - <i>q</i> ADDL ACC, P If <i>q</i> = 23 through 13: SFR ACC, #16 ADDL ACC, P SFR ACC, #29 - <i>q</i> If <i>q</i> = 12 through 0: SFR ACC, #16 ADDL ACC, P SFR ACC, #16 SFR ACC, #13 - <i>q</i>	Extended precision DSP Q math. Different code is generated based on the value of <i>q</i> .
long __qmpy32by16 (long <i>src32</i> , int <i>src16</i> , int <i>q</i>);	CLRC OVM MOV T, <i>src16</i> + 0 MPYXU P, T, <i>src32</i> + 0 MPY P, T, <i>src32</i> + 1 If <i>q</i> = 31, 30: SPM <i>q</i> - 30 SFR ACC, #46 - <i>q</i> ADDL ACC, P If <i>q</i> = 29 through 14: SPM 0 SFR ACC, #16 ADDL ACC, P SFR ACC, #30 - <i>q</i> If <i>q</i> = 13 through 0: SPM 0 SFR ACC, #16 ADDL ACC, P SFR ACC, #16 SFR ACC, #14 - <i>q</i>	Extended precision DSP Q math. Different code is generated based on the value of <i>q</i> .
void __restore_interrupts (unsigned int <i>val</i>);	PUSH <i>val</i> POP ST1	Restore interrupts and set the interrupt vector to value <i>val</i> .
long __rol (long <i>src</i>);	ROL ACC	Rotate ACC left.
long __ror (long <i>src</i>);	ROR ACC	Rotate ACC right.
void * <i>result</i> = __rpt_mov_imm (void * <i>dst</i> , int <i>src</i> , int <i>count</i>);	MOV <i>result</i> , <i>dst</i> MOV ARx, <i>dst</i> RPT # <i>count</i> MOV *XARx++, # <i>src</i>	Move the <i>dst</i> register to the <i>result</i> register. Move the <i>dst</i> register to a temp (ARx) register. Copy the immediate <i>src</i> to the temp register <i>count</i> + 1 times. The <i>src</i> must be a 16-bit immediate. The <i>count</i> can be an immediate from 0 to 255 or a variable.

Table 7-6. TMS320C28x C/C++ Compiler Intrinsics (continued)

Intrinsic	Assembly Instruction(s)	Description
int __rpt_norm_inc (long <i>src</i> , int <i>dst</i> , int <i>count</i>);	MOV ARx, dst RPT # count NORM ACC, ARx++	Repeat the normalize accumulator value <i>count</i> + 1 times. The <i>count</i> can be an immediate from 0 to 255 or a variable.
int __rpt_norm_dec (long <i>src</i> , int <i>dst</i> , int <i>count</i>);	MOV ARx, dst RPT # count NORM ACC, ARx--	Repeat the normalize accumulator value <i>count</i> + 1 times. The <i>count</i> can be an immediate from 0 to 255 or a variable.
long __rpt_rol (long <i>src</i> , int <i>count</i>);	RPT # count ROL ACC	Repeat the rotate accumulator left <i>count</i> + 1 times. The result is in ACC. The <i>count</i> can be an immediate from 0 to 255 or a variable.
long __rpt_ror (long <i>src</i> , int <i>count</i>);	RPT # count ROR ACC	Repeat the rotate accumulator right <i>count</i> + 1 times. The result is in ACC. The <i>count</i> can be an immediate from 0 to 255 or a variable.
long __rpt_subcu (long <i>dst</i> , int <i>src</i> , int <i>count</i>);	RPT count SUBCU ACC, src	The <i>src</i> operand is referenced from memory or loaded into a register and used as an operand to the SUBCU instruction. The result is in ACC. The <i>count</i> can be an immediate from 0 to 255 or a variable. The instruction repeats <i>count</i> + 1 times.
unsigned long __rpt_subcul (unsigned long <i>num</i> , unsigned long <i>den</i> , unsigned long <i>&remainder</i> , int <i>count</i>);	RPT count SUBCUL ACC, den	Performs repeated conditional long subtraction as typically used in unsigned modulus division. Returns the quotient.
long __sat (long <i>src</i>);	SAT ACC	Load ACC with 32-bit <i>src</i> . The result is in ACC.
long __sat32 (long <i>src</i> , long <i>limit</i>);	SETC OVM ADDL ACC, {mem P} SUBL ACC, {mem P} SUBL ACC, {mem P} ADDL ACC, {mem P} CLRC OVM	Saturate a 32-bit value to a 32-bit mask. Load ACC with <i>src</i> . Limit value is either referenced from memory or loaded into the P register. The result is in ACC.
long __sathigh16 (long <i>src</i> , int <i>limit</i>);	SETC OVM ADDL ACC, {mem P}<<16 SUBL ACC, {mem P}<<16 SUBL ACC, {mem P}<<16 ADDL ACC, {mem P}<<16 CLRC OVM SFR ACC, rshift	Saturate a 32-bit value to 16-bits high. Load ACC with <i>src</i> . The <i>limit</i> value is either referenced from memory or loaded into register. The result is in ACC. The result can be right shifted and stored into an int. For example: <code>ivar=__sathigh16(lvar, mask)>>6;</code>
long __satlow16 (long <i>src</i>);	SETC OVM MOV T, #0xFFFF CLR SXM ; if necessary ADD ACC, T <<15 SUB ACC, T <<15 SUB ACC, T <<15 ADD ACC, T <<15 CLRC OVM	Saturate a 32-bit value to 16-bits low. Load ACC with <i>src</i> . Load T register with #0xFFFF. The result is in ACC.
long __sbbu (long <i>src1</i> , uint <i>src2</i>);	SBBU ACC, src2	Subtract <i>src2</i> + logical inverse of C from ACC (<i>src1</i>). The result is in ACC.
void __sub (int * <i>m</i> , int <i>b</i>);	SUB * m , b	Subtract <i>b</i> from the contents of memory location <i>m</i> and store the result in <i>m</i> , in an atomic way.
long __subcu (long <i>src1</i> , int <i>src2</i>);	SUBCU ACC, src2	Subtract <i>src2</i> shifted left 15 from ACC (<i>src1</i>). The result is in ACC.
unsigned long __subcul (unsigned long <i>num</i> , unsigned long <i>den</i> , unsigned long <i>&remainder</i>);	SUBCUL ACC, den	Performs a single conditional long subtraction as typically used in unsigned modulus division. Returns the quotient.

Table 7-6. TMS320C28x C/C++ Compiler Intrinsics (continued)

Intrinsic	Assembly Instruction(s)	Description
void __subl (long * <i>m</i> , long <i>b</i>);	SUBL * <i>m</i> , <i>b</i>	Subtract <i>b</i> from the contents of memory location <i>m</i> and store the result in <i>m</i> , in an atomic way.
void __subr (int * <i>m</i> , int <i>b</i>);	SUBR * <i>m</i> , <i>b</i>	Subtract the contents of memory location <i>m</i> from <i>b</i> and store the result in <i>m</i> , in an atomic way.
void __subrl (long * <i>m</i> , long <i>b</i>);	SUBRL * <i>m</i> , <i>b</i>	Subtract the contents of memory location <i>m</i> from <i>b</i> and store the result in <i>m</i> , in an atomic way.
if (__tbit (int <i>src</i> , int <i>bit</i>));	TBIT <i>src</i> , # <i>bit</i>	SET TC status bit if specified <i>bit</i> of <i>src</i> is 1.
void __xor (int * <i>m</i> , int <i>b</i>);	XOR * <i>m</i> , <i>b</i>	XOR the contents of memory location <i>m</i> to <i>b</i> and store the result in <i>m</i> , in an atomic way.

Table 7-7. C/C++ Compiler Intrinsics for FPU

Intrinsic	Assembly Instruction(s)	Description
double __einvf32 (double <i>x</i>);	EINVF32 <i>x</i>	Compute and return 1/ <i>x</i> to about 8 bits of precision.
double __eisqrtf32 (double <i>x</i>);	EISQRTF32 <i>x</i>	Find the square root of 1/ <i>x</i> to about 8 bits of precision.
void __f32_max_idx (double & <i>dst</i> , double <i>src</i> , double & <i>idx_dst</i> , double <i>idx_src</i>);	MAXF32 <i>dst</i> , <i>src</i> MOV32 <i>idx_dst</i> , <i>idx_src</i>	If <i>src</i> > <i>dst</i> , copy <i>src</i> to <i>dst</i> , and copy <i>idx_src</i> to <i>idx_dst</i> .
void __f32_min_idx (double & <i>dst</i> , double <i>src</i> , double & <i>idx_dst</i> , double <i>idx_src</i>);	MINF32 <i>dst</i> , <i>src</i> MOV32 <i>idx_dst</i> , <i>idx_src</i>	If <i>src</i> < <i>dst</i> , copy <i>src</i> to <i>dst</i> , and copy <i>idx_src</i> to <i>idx_dst</i> .
int __f32toi16r (double <i>src</i>);	F32TOI16R <i>dst</i> , <i>src</i>	Convert double to int and round.
unsigned int __f32toui16r (double <i>src</i>);	F32TOUI16R <i>dst</i> , <i>src</i>	Convert double to unsigned int and round.
float __fmax (float <i>x</i> , float <i>y</i>);	MAXF32 <i>dst</i> , <i>src</i>	If <i>src</i> > <i>dst</i> , copy <i>src</i> to <i>dst</i>
float __fmin (float <i>x</i> , float <i>y</i>);	MINF32 <i>dst</i> , <i>src</i>	If <i>src</i> < <i>dst</i> , copy <i>src</i> to <i>dst</i>
double __fracf32 (double <i>src</i>);	FRACF32 <i>dst</i> , <i>src</i>	Return the fractional portion of <i>src</i> .
double __fsat (double <i>val</i> , double <i>max</i> , double <i>min</i>);	MAXF32 <i>dst</i> , <i>src</i> 2 MINF32 <i>dst</i> , <i>src</i> 1	Return <i>val</i> if <i>min</i> < <i>val</i> < <i>max</i> . Else return <i>min</i> if <i>val</i> < <i>min</i> . Else return <i>max</i> if <i>val</i> > <i>max</i> .
void __swapf (double & <i>a</i> , double & <i>b</i>);	swapf <i>a</i> , <i>b</i>	Swap the contents of <i>a</i> and <i>b</i> .
void __swapff (float & <i>a</i> , float & <i>b</i>);	swapff <i>a</i> , <i>b</i>	Swap the contents of <i>a</i> and <i>b</i> .

The following intrinsics perform hardware instructions using the Trigonometric Math Unit (TMU). These intrinsics are enabled if the --tmu_support=tmu0 compiler option is used.

Table 7-8. C/C++ Compiler Intrinsics for TMU

Intrinsic	Assembly Instruction(s)	Description
double __divf32 (double <i>num</i> , double <i>denom</i>);	DIVF32 <i>dst</i> , <i>num</i> , <i>denom</i>	Return <i>num</i> divided by <i>denom</i> using the TMU hardware instruction for floating point division.
double __sqrt (double <i>src</i>);	SQRTF32 <i>dst</i> , <i>src</i>	Return the square root of <i>src</i> .
double __sin (double <i>src</i>);	SINF32 <i>dst</i> , <i>src</i>	Return the sine of <i>src</i> radians, where <i>src</i> is provided in radians.
double __cos (double <i>src</i>);	COSF32 <i>dst</i> , <i>src</i>	Return the cosine of <i>src</i> radians, where <i>src</i> is provided in radians.
double __atan (double <i>src</i>);	ATANF32 <i>dst</i> , <i>src</i>	Return the principal value of the arc tangent of <i>src</i> radians.
double __atan2 (double <i>y</i> , double <i>x</i>);	QUADF32 <i>quadrant</i> , <i>ratio</i> , <i>y</i> , <i>x</i> ATANPUF32 <i>atanpu</i> , <i>ratio</i> ADDF32 <i>atan2pu</i> , <i>atanpu</i> MPY2PIF32 <i>atan2</i> , <i>atan2pu</i>	Return the principal value of the arc tangent plus the quadrant for <i>x</i> , <i>y</i> . The value is returned in radians.

Table 7-8. C/C++ Compiler Intrinsics for TMU (continued)

Intrinsic	Assembly Instruction(s)	Description
double __mpy2pif32 (double <i>src</i>);	MPY2PIF32 <i>dst, src</i>	Return the result of multiplying <i>src</i> by 2pi. This converts a per unit value to radians. Per unit values are commonly used in control applications to represent normalized radians.
double __div2pif32 (double <i>src</i>);	DIV2PIF32 <i>dst, src</i>	Return the result of multiplying <i>src</i> by 1/2pi (effectively dividing by 2pi). This converts a value in radians to a per unit value.
double __sinpuf32 (double <i>src</i>);	SINPUF32 <i>dst, src</i>	Return the sine of <i>src</i> in radians, where <i>src</i> is provided as a per unit value.
double __cospuf32 (double <i>src</i>);	COSPUF32 <i>dst, src</i>	Return the cosine of <i>src</i> in radians, where <i>src</i> is provided as a per unit value.
double __atanpuf32 (double <i>src</i>);	ATANPUF32 <i>dst, src</i>	Return the principal value of the arc tangent of <i>src</i> , which is provided as a per unit value.
double __atan2puf32 (double <i>x</i> , double <i>y</i>);	QUADF32 <i>quadrant, ratio, y, x</i> ATANPUF32 <i>atanpu, ratio</i> ADDF32 <i>dst, atanpu</i>	Return the principal value of the arc tangent plus the quadrant value for <i>y, x</i> . The value is returned as a per unit value.
double __quadf32 (double <i>ratio</i> , double <i>y</i> , double <i>x</i>);	QUADF32 <i>quadrant, ratio, y, x</i>	Return the quadrant value (0.0, +/-0.25, or +/-0.5) and the ratio of <i>x</i> and <i>y</i> , which are provided as per unit values.

7.6 Interrupt Handling

As long as you follow the guidelines in this section, you can interrupt and return to C/C++ code without disrupting the C/C++ environment. When the C/C++ environment is initialized, the startup routine does not enable or disable interrupts. If the system is initialized by way of a hardware reset, interrupts are disabled. If your system uses interrupts, you must handle any required enabling or masking of interrupts. Such operations have no effect on the C/C++ environment and are easily incorporated with asm statements or calling an assembly language function.

7.6.1 General Points About Interrupts

An interrupt routine can perform any task performed by any other function, including accessing global variables, allocating local variables, and calling other functions.

When you write interrupt routines, keep the following points in mind:

- An interrupt handling routine cannot have arguments. If any are declared, they are ignored.
- An interrupt handling routine can be called by normal C/C++ code, but it is inefficient to do this because all the registers are saved.
- An interrupt handling routine can handle a single interrupt or multiple interrupts. The compiler does not generate code that is specific to a certain interrupt, except for `c_int00`, which is the system reset interrupt. When you enter this routine, you cannot assume that the run-time stack is set up; therefore, *you cannot allocate local variables, and you cannot save any information on the run-time stack.*
- To associate an interrupt routine with an interrupt, the address of the interrupt function must be placed in the appropriate interrupt vector. You can use the assembler and linker to do this by creating a simple table of interrupt addresses using the `.sect` assembler directive.
- In assembly language, remember to precede the symbol name with an underscore. For example, refer to `c_int00` as `_c_int00`.

7.6.2 Using C/C++ Interrupt Routines

If a C/C++ interrupt routine does not call any other functions, only those registers that the interrupt handler uses are saved and restored. However, if a C/C++ interrupt routine does call other functions, these functions can modify unknown registers that the interrupt handler does not use. For this reason, the compiler saves all the save-on-call registers if any other functions are called.

A C/C++ interrupt routine is like any other C/C++ function in that it can have local variables and register variables; however, it should be declared with no arguments and should return void. Interrupt handling functions should not be called directly.

Interrupts can be handled directly with C/C++ functions by using the `INTERRUPT` pragma or the `__interrupt` keyword. For information about the `INTERRUPT` pragma, see [Section 6.9.14](#). For information about the `__interrupt` keyword, see [Section 6.5.3](#).

7.7 Integer Expression Analysis

This section describes some special considerations to keep in mind when evaluating integer expressions.

7.7.1 Operations Evaluated With Run-Time-Support Calls

The TMS320C28x does not directly support some C/C++ integer operations. Evaluating these operations is done with calls to run-time-support routines. These routines are hard-coded in assembly language. They are members of the object and source run-time-support libraries (rts2800_ml.lib and rtsrc.zip) in the toolset.

The conventions for calling these routines are modeled on the standard C/C++ calling conventions.

Operation Type	Operations Evaluated With Run-Time-Support Calls
16-bit int	Divide (signed) Modulus
32-bit long	Divide (signed) Modulus
64-bit long long	Multiply ⁽¹⁾ Divide Bitwise AND, OR, and XOR Compare

⁽¹⁾ 64-bit long long multiplies are inlined if -mf=5 is specified.

7.7.2 C/C++ Code Access to the Upper 16 Bits of 16-Bit Multiply

The following methods provide access to the upper 16 bits of a 16-bit multiply in C/C++ language:

- Signed-results method:

```
int m1, m2;
int result;

result = ((long) m1 * (long) m2) >> 16;
```

- Unsigned-results method:

```
unsigned m1, m2;
unsigned result;

result = ((unsigned long) m1 * (unsigned long) m2) >> 16;
```

Danger of Complicated Expressions

NOTE: The compiler must recognize the structure of the expression for it to return the expected results. Avoid complicated expressions such as the following example:

```
((long)((unsigned)((a*b)+c)<5)*(long)(z*sin(w)>6))>>16
```

7.8 Floating-Point Expression Analysis

The C28x C/C++ compiler represents float and double floating-point values as IEEE single-precision numbers. Long double floating-point values are represented as IEEE double-precision numbers. Single-precision floating-point numbers are represented as 32-bit values and double-precision floating-point numbers are represented as 64-bit values.

The run-time-support library, `rts2800_ml.lib`, contains a set of floating-point math functions that support:

- Addition, subtraction, multiplication, and division
- Comparisons (>, <, >=, <=, ==, !=)
- Conversions from integer or long to floating-point and floating-point to integer or long, both signed and unsigned
- Standard error handling

The conventions for calling these routines are the same as the conventions used to call the integer operation routines. Conversions are unary operations.

7.9 System Initialization

Before you can run a C/C++ program, you must create the C/C++ run-time environment. The C/C++ boot routine performs this task using a function called `c_int00` (or `_c_int00`). The run-time-support source library, `rts.src`, contains the source to this routine in a module named `boot.c` (or `boot.asm`).

To begin running the system, the `c_int00` function can be called by reset hardware. You must link the `c_int00` function with the other object files. This occurs automatically when you use the `--rom_model` or `--ram_model` link option and include a standard run-time-support library as one of the linker input files.

When C/C++ programs are linked, the linker sets the entry point value in the executable output file to the symbol `c_int00`.

The `c_int00` function performs the following tasks to initialize the environment:

1. Defines a section called `.stack` for the system stack and sets up the initial stack pointers
2. Initializes global variables by copying the data from the initialization tables to the storage allocated for the variables in the `.ebss` section. If you are initializing variables at load time (`--ram_model` option), a loader performs this step before the program runs (it is not performed by the boot routine). For more information, see [Section 7.9.3](#).
3. Executes the global constructors found in the global constructors table. For more information, see [Section 7.9.3.4](#).
4. Calls the `main()` function to run the C/C++ program

You can replace or modify the boot routine to meet your system requirements. However, the boot routine *must* perform the operations listed above to correctly initialize the C/C++ environment.

7.9.1 Boot Hook Functions for System Pre-Initialization

Boot hooks are points at which you may insert application functions into the C/C++ boot process. Default boot hook functions are provided with the run-time support (RTS) library. However, you can implement customized versions of these boot hook functions, which override the default boot hook functions in the RTS library if they are linked before the run-time library. Such functions can perform any application-specific initialization before continuing with the C/C++ environment setup.

Note that the TI-RTOS operating system uses custom versions of the boot hook functions for system setup, so you should be careful about overriding these functions if you are using TI-RTOS.

The following boot hook functions are available:

_system_pre_init(): This function provides a place to perform application-specific initialization. It is invoked after the stack pointer is initialized but before any C/C++ environment setup is performed. By default, `_system_pre_init()` should return a non-zero value. The default C/C++ environment setup is bypassed if `_system_pre_init()` returns 0.

_system_post_cinit(): This function is invoked during C/C++ environment setup, after C/C++ global data is initialized but before any C++ constructors are called. This function should not return a value.

7.9.2 Run-Time Stack

The run-time stack is allocated in a single continuous block of memory and grows down from low addresses to higher addresses. The SP points to the top of the stack.

The code does not check to see if the run-time stack overflows. Stack overflow occurs when the stack grows beyond the limits of the memory space that was allocated for it. Be sure to allocate adequate memory for the stack.

The stack size can be changed at link time by using the `--stack_size` link option on the linker command line and specifying the stack size as a constant directly after the option.

7.9.3 Automatic Initialization of Variables

Some global variables must have initial values assigned to them before a C/C++ program starts running. The process of retrieving these variables' data and initializing the variables with the data is called autoinitialization.

The compiler builds tables in a special section called `.cinit` that contains data for initializing global and static variables. Each compiled module contains these initialization tables. The linker combines them into a single table (a single `.cinit` section). The boot routine or a loader uses this table to initialize all the system variables.

Initializing Variables

NOTE: In ANSI/ISO C, global and static variables that are not explicitly initialized must be set to 0 before program execution. The C/C++ compiler does not perform any preinitialization of uninitialized variables. Explicitly initialize any variable that must have an initial value of 0.

The easiest method is to have a loader clear the `.ebss` section before the program starts running. Another method is to set a fill value of 0 in the linker control map for the `.ebss` section.

You cannot use these methods with code that is burned into ROM.

Global variables are either autoinitialized at run time or at load time; see [Section 7.9.3.2](#) and [Section 7.9.3.3](#). Also see [Section 6.12](#).

7.9.3.1 Initialization Tables

The tables in the `.cinit` section consist of variable-size initialization records. Each variable that must be autoinitialized has a record in the `.cinit` section. [Figure 7-2](#) shows the format of the `.cinit` section and the initialization records.

Figure 7-2. Format of Initialization Records in the `.cinit` Section

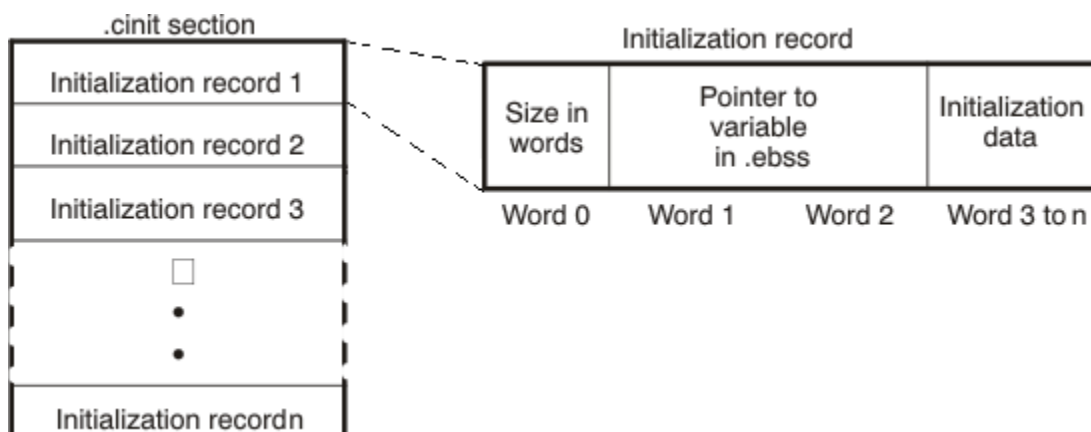

The fields of an initialization record contain the following information:

- The first field of an initialization record contains the size (in words) of the initialization data. That is, this field contains the size of the third field. The size is specified as a negative value; this is legacy behavior, and the absolute value of this field is the size of the data.
- The second field contains the starting address of the area within the `.ebss` section where the initialization data must be copied. The second field requires two words to hold the address.
- The third field contains the data that is copied into the `.ebss` section to initialize the variable. The width of this field is variable.

Each variable that must be autoinitialized has an initialization record in the `.cinit` section.

Example 7-7 shows initialized global variables defined in C. Example 7-8 shows the corresponding initialization table.

Example 7-7. Initialized Variables Defined in C

```
int    i= 23;
far    int j[2] = { 1,2};
```

Example 7-8. Initialized Information for Variables Defined in Example 7-7

```
.global    _i
.ebss     _i,1,1,0
.global    _j
_j:       .usect    .ebss,2,1,0

.sect     ".cinit"
.align    1
.field    1,16
.field    _i+0,16
.field    23,16      ; _i @ 0

.sect     ".cinit"
.align    1
.field    -IR_1,16
.field    _j+0,32
.field    1,16      ; _j[0] @ 0
.field    2,16      ; _j[1] @ 16
IR_1:    .set2
```

The .cinit section must contain only initialization tables in this format. When interfacing assembly language modules, do not use the .cinit section for any other purpose.

The table in the .pinit section simply consists of a list of addresses of constructors to be called (see Figure 7-3). The constructors appear in the table after the .cinit initialization.

Figure 7-3. Format of Initialization Records in the .pinit Section

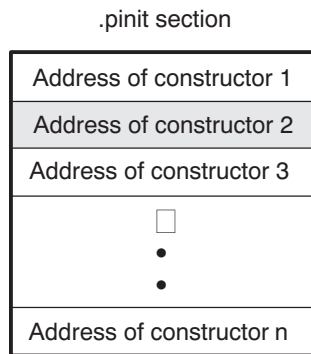

When you use the --rom_model or --ram_model option, the linker combines the .cinit sections from all the C modules and appends a null word to the end of the composite .cinit section. This terminating record appears as a record with a size field of 0 and marks the end of the initialization tables.

Likewise, the --rom_model or --ram_model link option causes the linker to combine all of the .pinit sections from all C/C++ modules and append a null word to the end of the composite .pinit section. The boot routine knows the end of the global constructor table when it encounters a null constructor address.

The const-qualified variables are initialized differently; see Section 6.5.1.

7.9.3.2 Autoinitialization of Variables at Run Time

Autoinitializing variables at run time is the default method of autoinitialization. To use this method, invoke the linker with the `--rom_model` option.

Using this method, the `.cinit` section is loaded into memory along with all the other initialized sections, and global variables are initialized at run time. The linker defines a special symbol called `cinit` that points to the beginning of the initialization tables in memory. When the program begins running, the C/C++ boot routine copies data from the tables (pointed to by `.cinit`) into the specified variables in the `.ebss` section. This allows initialization data to be stored in ROM and copied to RAM each time the program starts.

Figure 7-4 illustrates autoinitialization at run time. Use this method in any system where your application runs from code burned into ROM.

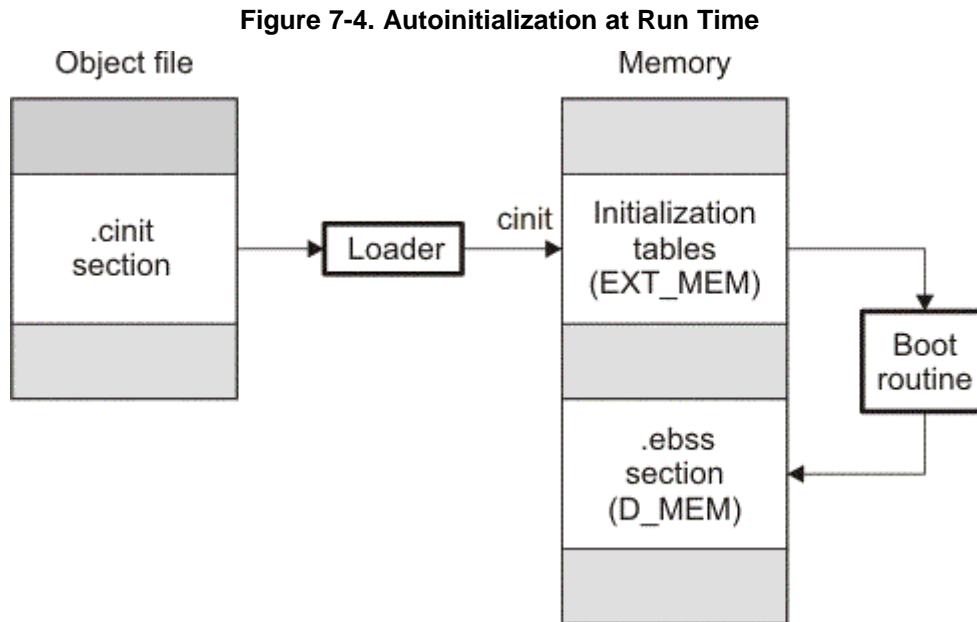

7.9.3.3 Initialization of Variables at Load Time

Initialization of variables at load time enhances performance by reducing boot time and by saving the memory used by the initialization tables. To use this method, invoke the linker with the `--ram_model` option.

When you use the `--ram_model` link option, the linker sets the `STYP_COPY` bit in the `.cinit` section's header. This tells the loader not to load the `.cinit` section into memory. (The `.cinit` section occupies no space in the memory map.) The linker also sets the `cinit` symbol to `-1` (normally, `cinit` points to the beginning of the initialization tables). This indicates to the boot routine that the initialization tables are not present in memory; accordingly, no run-time initialization is performed at boot time.

A loader (which is not part of the compiler package) must be able to perform the following tasks to use initialization at load time:

- Detect the presence of the `.cinit` section in the object file
- Determine that `STYP_COPY` is set in the `.cinit` section header, so that it knows not to copy the `.cinit` section into memory
- Understand the format of the initialization tables

Figure 7-5 illustrates the initialization of variables at load time.

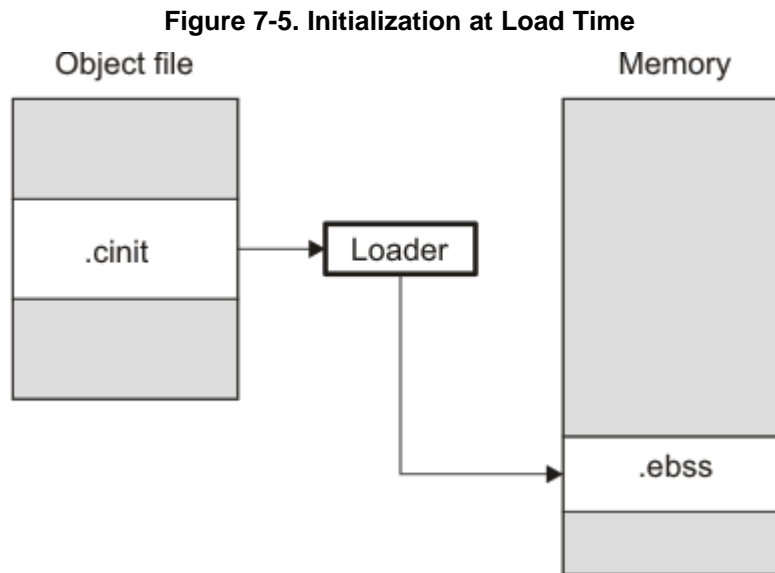

Regardless of the use of the `--rom_model` or `--ram_model` options, the .pinit section is always loaded and processed at run time.

7.9.3.4 Global Constructors

All global C++ variables that have constructors must have their constructor called before `main()`. The compiler builds a table in a section called .pinit of global constructor addresses that must be called, in order, before `main()`. The linker combines the .pinit section from each input file to form a single table in the .pinit section. The boot routine uses this table to execute the constructors.

Using Run-Time-Support Functions and Building Libraries

Some of the features of C/C++ (such as I/O, dynamic memory allocation, string operations, and trigonometric functions) are provided as an ANSI/ISO C/C++ standard library, rather than as part of the compiler itself. The TI implementation of this library is the run-time-support library (RTS). The C/C++ compiler implements the ISO standard library except for those facilities that handle exception conditions, signal, and locale issues (properties that depend on local language, nationality, or culture). Using the ANSI/ISO standard library ensures a consistent set of functions that provide for greater portability.

In addition to the ANSI/ISO-specified functions, the run-time-support library includes routines that give you processor-specific commands and direct C language I/O requests. These are detailed in [Section 8.1](#) and [Section 8.2](#).

A library-build utility is provided with the code generation tools that lets you create customized run-time-support libraries. This process is described in [Section 8.4](#).

Topic	Page
8.1 C and C++ Run-Time Support Libraries	167
8.2 The C I/O Functions	169
8.3 Handling Reentrancy (_register_lock() and _register_unlock() Functions)	181
8.4 Library-Build Process	182

8.1 C and C++ Run-Time Support Libraries

TMS320C28x compiler releases include pre-built run-time support (RTS) libraries that provide all the standard capabilities. Separate libraries are provided for FPU support and C++ exception support. See [Section 8.1.7](#) for information on the library-naming conventions.

The run-time-support library contains the following:

- ANSI/ISO C/C++ standard library
- C I/O library
- Low-level support functions that provide I/O to the host operating system
- Fundamental arithmetic routines
- System startup routine, `_c_int00`
- Compiler helper functions (to support language features that are not directly efficiently expressible in C/C++)

The run-time-support libraries do not contain functions involving signals and locale issues.

The C++ library supports wide chars, in that template functions and classes that are defined for `char` are also available for wide `char`. For example, wide char stream classes `wios`, `wiostream`, `wstreambuf` and so on (corresponding to `char` classes `ios`, `iostream`, `streambuf`) are implemented. However, there is no low-level file I/O for wide chars. Also, the C library interface to wide char support (through the C++ headers `<wchar>` and `<cwctype>`) is limited as described in [Section 6.1](#).

TI does not provide documentation that covers the functionality of the C++ library. TI suggests referring to one of the following sources:

- *The Standard C++ Library: A Tutorial and Reference*, Nicolai M. Josuttis, Addison-Wesley, ISBN 0-201-37926-0
- *The C++ Programming Language* (Third or Special Editions), Bjarne Stroustrup, Addison-Wesley, ISBN 0-201-88954-4 or 0-201-70073-5

8.1.1 Linking Code With the Object Library

When you link your program, you must specify the object library as one of the linker input files so that references to the I/O and run-time-support functions can be resolved. You can either specify the library or allow the compiler to select one for you. See [Section 4.3.1](#) for further information.

When a library is linked, the linker includes only those library members required to resolve undefined references. For more information about linking, see the *TMS320C28x Assembly Language Tools User's Guide*.

C, C++, and mixed C and C++ programs can use the same run-time-support library. Run-time-support functions and variables that can be called and referenced from both C and C++ will have the same linkage.

8.1.2 Header Files

You must use the header files provided with the compiler run-time support when using functions from C/C++ standard library. Set the `C2000_C_DIR` environment variable to the specific include directory: `"include\lib"`.

8.1.3 Modifying a Library Function

You can inspect or modify library functions by examining the source code in the `lib/src` subdirectory of the compiler installation. For example, `C:\ti\ccsv6\tools\compiler\c2000_#.#.#\lib\src`.

Once you have located the relevant source code, change the specific function file and rebuild the library.

You can use this source tree to rebuild the `rts2800_ml.lib` library or to build a new library. See [Section 8.4](#) for details on building.

8.1.4 Support for String Handling

The library includes the header files `<string.h>` and `<strings.h>`, which provide the following functions for string handling beyond those required.

- `string.h`
 - `strdup()`, which duplicates a string
- `strings.h`
 - `bcmp()`, which is equivalent to `memcmp()`
 - `bcopy()`, which is equivalent to `memcpy()`
 - `bzero()`, which replaces memory locations with zero-valued bytes
 - `ffs()`, which finds the first bit set and returns the index of that bit
 - `index()`, which is equivalent to `strchr()`
 - `rindex()`, which is equivalent to `strrchr()`
 - `strncasecmp()` and `strncasecmp()`, which perform case-insensitive string comparisons

8.1.5 Minimal Support for Internationalization

The library includes the header files `<locale.h>`, `<wchar.h>`, and `<wctype.h>`, which provide APIs to support non-ASCII character sets and conventions. Our implementation of these APIs is limited in the following ways:

- The library has minimal support for wide and multibyte characters. The type `wchar_t` is implemented as `int`. The wide character set is equivalent to the set of values of type `char`. The library includes the header files `<wchar.h>` and `<wctype.h>` but does not include all the functions specified in the standard. So-called multibyte characters are limited to single characters. There are no shift states. The mapping between multibyte characters and wide characters is simple equivalence; that is, each wide character maps to and from exactly a single multibyte character having the same value.
- The C library includes the header file `<locale.h>` but with a minimal implementation. The only supported locale is the C locale. That is, library behavior that is specified to vary by locale is hard-coded to the behavior of the C locale, and attempting to install a different locale via a call to `setlocale()` will return `NULL`.

8.1.6 Allowable Number of Open Files

In the `<stdio.h>` header file, the value for the macro `FOPEN_MAX` has the value of the macro `_NFILE`, which is set to 10. The impact is that you can only have 10 files simultaneously open at one time (including the pre-defined streams - `stdin`, `stdout`, `stderr`).

The C standard requires that the minimum value for the `FOPEN_MAX` macro is 8. The macro determines the maximum number of files that can be opened at one time. The macro is defined in the `stdio.h` header file and can be modified by changing the value of the `_NFILE` macro and recompiling the library.

8.1.7 Library Naming Conventions

By default, the linker uses automatic library selection to select the correct run-time-support library (see [Section 4.3.1.1](#)) for your application. If you select the library manually, you must select the matching library according to the following naming scheme:

rts2800_ml.lib or **rts2800_fpu32.lib**

rts2800_ml The default C28x support library
rts2800_fpu32 Indicates support for FPU targets

8.2 The C I/O Functions

The C I/O functions make it possible to access the host's operating system to perform I/O. The capability to perform I/O on the host gives you more options when debugging and testing code.

The I/O functions are logically divided into layers: high level, low level, and device-driver level.

With properly written device drivers, the C-standard high-level I/O functions can be used to perform I/O on custom user-defined devices. This provides an easy way to use the sophisticated buffering of the high-level I/O functions on an arbitrary device.

Debugger Required for Default HOST

NOTE: For the default HOST device to work, there must be a debugger to handle the C I/O requests; the default HOST device cannot work by itself in an embedded system. To work in an embedded system, you will need to provide an appropriate driver for your system.

NOTE: C I/O Mysteriously Fails

If there is not enough space on the heap for a C I/O buffer, operations on the file will silently fail. If a call to `printf()` mysteriously fails, this may be the reason. The heap needs to be at least large enough to allocate a block of size `BUFSIZ` (defined in `stdio.h`) for every file on which I/O is performed, including `stdout`, `stdin`, and `stderr`, plus allocations performed by the user's code, plus allocation bookkeeping overhead. Alternately, declare a char array of size `BUFSIZ` and pass it to `setvbuf` to avoid dynamic allocation. To set the heap size, use the `--heap_size` option when linking (refer to the *Linker Description* chapter in the *TMS320C28x Assembly Language Tools User's Guide*).

NOTE: Open Mysteriously Fails

The run-time support limits the total number of open files to a small number relative to general-purpose processors. If you attempt to open more files than the maximum, you may find that the open will mysteriously fail. You can increase the number of open files by extracting the source code from `rts.src` and editing the constants controlling the size of some of the C I/O data structures. The macro `_NFILE` controls how many `FILE` (`fopen`) objects can be open at one time (`stdin`, `stdout`, and `stderr` count against this total). (See also `FOPEN_MAX`.) The macro `_NSTREAM` controls how many low-level file descriptors can be open at one time (the low-level files underlying `stdin`, `stdout`, and `stderr` count against this total). The macro `_NDEVICE` controls how many device drivers are installed at one time (the HOST device counts against this total).

8.2.1 High-Level I/O Functions

The high-level functions are the standard C library of stream I/O routines (printf, scanf, fopen, getchar, and so on). These functions call one or more low-level I/O functions to carry out the high-level I/O request. The high-level I/O routines operate on FILE pointers, also called *streams*.

Portable applications should use only the high-level I/O functions.

To use the high-level I/O functions, include the header file `stdio.h`, or `cstdio` for C++ code, for each module that references a C I/O function.

For example, given the following C program in a file named `main.c`:

```
#include <stdio.h>

void main()
{
    FILE *fid;

    fid = fopen("myfile","w");
    fprintf(fid,"Hello, world\n");
    fclose(fid);

    printf("Hello again, world\n");
}
```

Issuing the following compiler command compiles, links, and creates the file `main.out` from the run-time-support library:

```
cl2000 main.c --run_linker --heap_size=400 --library=rts2800_ml.lib --output_file=main.out
```

Executing `main.out` results in

```
Hello, world
```

being output to a file and

```
Hello again, world
```

being output to your host's stdout window.

8.2.2 Overview of Low-Level I/O Implementation

The low-level functions are comprised of seven basic I/O functions: open, read, write, close, lseek, rename, and unlink. These low-level routines provide the interface between the high-level functions and the device-level drivers that actually perform the I/O command on the specified device.

The low-level functions are designed to be appropriate for all I/O methods, even those which are not actually disk files. Abstractly, all I/O channels can be treated as files, although some operations (such as lseek) may not be appropriate. See [Section 8.2.3](#) for more details.

The low-level functions are inspired by, but not identical to, the POSIX functions of the same names.

The low-level functions operate on file descriptors. A file descriptor is an integer returned by open, representing an opened file. Multiple file descriptors may be associated with a file; each has its own independent file position indicator.

open	Open File for I/O
Syntax	<pre>#include <file.h> int open (const char * path , unsigned flags , int file_descriptor);</pre>
Description	<p>The open function opens the file specified by <i>path</i> and prepares it for I/O.</p> <ul style="list-style-type: none"> • The <i>path</i> is the filename of the file to be opened, including an optional directory path and an optional device specifier (see Section 8.2.5). • The <i>flags</i> are attributes that specify how the file is manipulated. The flags are specified using the following symbols: <pre>O_RDONLY (0x0000) /* open for reading */ O_WRONLY (0x0001) /* open for writing */ O_RDWR (0x0002) /* open for read & write */ O_APPEND (0x0008) /* append on each write */ O_CREAT (0x0200) /* open with file create */ O_TRUNC (0x0400) /* open with truncation */ O_BINARY (0x8000) /* open in binary mode */</pre> <p>Low-level I/O routines allow or disallow some operations depending on the flags used when the file was opened. Some flags may not be meaningful for some devices, depending on how the device implements files.</p> • The <i>file_descriptor</i> is assigned by open to an opened file. <p>The next available file descriptor is assigned to each new file opened.</p>
Return Value	<p>The function returns one of the following values:</p> <pre>non-negative file descriptor if successful -1 on failure</pre>

close ***Close File for I/O***

Syntax

```
#include <file.h>
int close (int file_descriptor );
```

Description

The close function closes the file associated with *file_descriptor*.
The *file_descriptor* is the number assigned by open to an opened file.

Return Value

The return value is one of the following:

0	if successful
-1	on failure

read
Read Characters from a File

Syntax

```
#include <file.h>
int read (int file_descriptor , char * buffer , unsigned count );
```

Description

The read function reads *count* characters into the *buffer* from the file associated with *file_descriptor*.

- The *file_descriptor* is the number assigned by open to an opened file.
- The *buffer* is where the read characters are placed.
- The *count* is the number of characters to read from the file.

Return Value

The function returns one of the following values:

0	if EOF was encountered before any characters were read
#	number of characters read (may be less than <i>count</i>)
-1	on failure

write
Write Characters to a File

Syntax

```
#include <file.h>
int write (int file_descriptor , const char * buffer , unsigned count );
```

Description

The write function writes the number of characters specified by *count* from the *buffer* to the file associated with *file_descriptor*.

- The *file_descriptor* is the number assigned by open to an opened file.
- The *buffer* is where the characters to be written are located.
- The *count* is the number of characters to write to the file.

Return Value

The function returns one of the following values:

#	number of characters written if successful (may be less than <i>count</i>)
-1	on failure

lseek	<i>Set File Position Indicator</i>
Syntax for C	<pre>#include <file.h> off_t lseek (int file_descriptor , off_t offset , int origin);</pre>
Description	<p>The lseek function sets the file position indicator for the given file to a location relative to the specified origin. The file position indicator measures the position in characters from the beginning of the file.</p> <ul style="list-style-type: none"> • The <i>file_descriptor</i> is the number assigned by open to an opened file. • The <i>offset</i> indicates the relative offset from the <i>origin</i> in characters. • The <i>origin</i> is used to indicate which of the base locations the <i>offset</i> is measured from. The <i>origin</i> must be one of the following macros: <ul style="list-style-type: none"> SEEK_SET (0x0000) Beginning of file SEEK_CUR (0x0001) Current value of the file position indicator SEEK_END (0x0002) End of file
Return Value	<p>The return value is one of the following:</p> <pre># new value of the file position indicator if successful (off_t)-1 on failure</pre>
unlink	<i>Delete File</i>
Syntax	<pre>#include <file.h> int unlink (const char * path);</pre>
Description	<p>The unlink function deletes the file specified by <i>path</i>. Depending on the device, a deleted file may still remain until all file descriptors which have been opened for that file have been closed. See Section 8.2.3.</p> <p>The <i>path</i> is the filename of the file, including path information and optional device prefix. (See Section 8.2.5.)</p>
Return Value	<p>The function returns one of the following values:</p> <pre>0 if successful -1 on failure</pre>

rename	<i>Rename File</i>				
Syntax for C	<pre>#include {<stdio.h> <file.h>} int rename (const char * old_name , const char * new_name);</pre>				
Syntax for C++	<pre>#include {<cstdio> <file.h>} int std::rename (const char * old_name , const char * new_name);</pre>				
Description	<p>The rename function changes the name of a file.</p> <ul style="list-style-type: none"> • The <i>old_name</i> is the current name of the file. • The <i>new_name</i> is the new name for the file. <hr/> <p>NOTE: The optional device specified in the new name must match the device of the old name. If they do not match, a file copy would be required to perform the rename, and rename is not capable of this action.</p> <hr/>				
Return Value	<p>The function returns one of the following values:</p> <table border="0"> <tr> <td style="padding-right: 20px;">0</td> <td>if successful</td> </tr> <tr> <td>-1</td> <td>on failure</td> </tr> </table> <hr/> <p>NOTE: Although rename is a low-level function, it is defined by the C standard and can be used by portable applications.</p> <hr/>	0	if successful	-1	on failure
0	if successful				
-1	on failure				

8.2.3 Device-Driver Level I/O Functions

At the next level are the device-level drivers. They map directly to the low-level I/O functions. The default device driver is the HOST device driver, which uses the debugger to perform file operations. The HOST device driver is automatically used for the default C streams stdin, stdout, and stderr.

The HOST device driver shares a special protocol with the debugger running on a host system so that the host can perform the C I/O requested by the program. Instructions for C I/O operations that the program wants to perform are encoded in a special buffer named `_CIOBUF_` in the `.cio` section. The debugger halts the program at a special breakpoint (C\$\$IO\$\$), reads and decodes the target memory, and performs the requested operation. The result is encoded into `_CIOBUF_`, the program is resumed, and the target decodes the result.

The HOST device is implemented with seven functions, `HOSTopen`, `HOSTclose`, `HOSTread`, `HOSTwrite`, `HOSTlseek`, `HOSTunlink`, and `HOSTrename`, which perform the encoding. Each function is called from the low-level I/O function with a similar name.

A device driver is composed of seven required functions. Not all function need to be meaningful for all devices, but all seven must be defined. Here we show the names of all seven functions as starting with `DEV`, but you may choose any name except for `HOST`.

DEV_open**Open File for I/O****Syntax**

```
int DEV_open (const char * path , unsigned flags , int llv_fd);
```

Description

This function finds a file matching *path* and opens it for I/O as requested by *flags*.

- The *path* is the filename of the file to be opened. If the name of a file passed to open has a device prefix, the device prefix will be stripped by open, so DEV_open will not see it. (See [Section 8.2.5](#) for details on the device prefix.)
- The *flags* are attributes that specify how the file is manipulated. The flags are specified using the following symbols:

```
O_RDONLY   (0x0000)  /* open for reading */
O_WRONLY   (0x0001)  /* open for writing */
O_RDWR     (0x0002)  /* open for read & write */
O_APPEND   (0x0008)  /* append on each write */
O_CREAT     (0x0200)  /* open with file create */
O_TRUNC    (0x0400)  /* open with truncation */
O_BINARY    (0x8000)  /* open in binary mode */
```

See POSIX for further explanation of the flags.

- The *llv_fd* is treated as a suggested low-level file descriptor. This is a historical artifact; newly-defined device drivers should ignore this argument. This differs from the low-level I/O open function.

This function must arrange for information to be saved for each file descriptor, typically including a file position indicator and any significant flags. For the HOST version, all the bookkeeping is handled by the debugger running on the host machine. If the device uses an internal buffer, the buffer can be created when a file is opened, or the buffer can be created during a read or write.

Return Value

This function must return -1 to indicate an error if for some reason the file could not be opened; such as the file does not exist, could not be created, or there are too many files open. The value of *errno* may optionally be set to indicate the exact error (the HOST device does not set *errno*). Some devices might have special failure conditions; for instance, if a device is read-only, a file cannot be opened O_WRONLY.

On success, this function must return a non-negative file descriptor unique among all open files handled by the specific device. The file descriptor need not be unique across devices. The device file descriptor is used only by low-level functions when calling the device-driver-level functions. The low-level function open allocates its own unique file descriptor for the high-level functions to call the low-level functions. Code that uses only high-level I/O functions need not be aware of these file descriptors.

DEV_close	<i>Close File for I/O</i>
Syntax	int DEV_close (int dev_fd);
Description	<p>This function closes a valid open file descriptor.</p> <p>On some devices, DEV_close may need to be responsible for checking if this is the last file descriptor pointing to a file that was unlinked. If so, it is responsible for ensuring that the file is actually removed from the device and the resources reclaimed, if appropriate.</p>
Return Value	<p>This function should return -1 to indicate an error if the file descriptor is invalid in some way, such as being out of range or already closed, but this is not required. The user should not call close() with an invalid file descriptor.</p>
DEV_read	<i>Read Characters from a File</i>
Syntax	int DEV_read (int dev_fd , char * buf , unsigned count);
Description	<p>The read function reads <i>count</i> bytes from the input file associated with <i>dev_fd</i>.</p> <ul style="list-style-type: none"> • The <i>dev_fd</i> is the number assigned by open to an opened file. • The <i>buf</i> is where the read characters are placed. • The <i>count</i> is the number of characters to read from the file.
Return Value	<p>This function must return -1 to indicate an error if for some reason no bytes could be read from the file. This could be because of an attempt to read from a O_WRONLY file, or for device-specific reasons.</p> <p>If count is 0, no bytes are read and this function returns 0.</p> <p>This function returns the number of bytes read, from 0 to count. 0 indicates that EOF was reached before any bytes were read. It is not an error to read less than count bytes; this is common if there are not enough bytes left in the file or the request was larger than an internal device buffer size.</p>
DEV_write	<i>Write Characters to a File</i>
Syntax	int DEV_write (int dev_fd , const char * buf , unsigned count);
Description	<p>This function writes <i>count</i> bytes to the output file.</p> <ul style="list-style-type: none"> • The <i>dev_fd</i> is the number assigned by open to an opened file. • The <i>buffer</i> is where the write characters are placed. • The <i>count</i> is the number of characters to write to the file.
Return Value	<p>This function must return -1 to indicate an error if for some reason no bytes could be written to the file. This could be because of an attempt to read from a O_RDONLY file, or for device-specific reasons.</p>

DEV_lseek ***Set File Position Indicator***

Syntax **off_t lseek (int dev_fd , off_t offset , int origin);**

Description This function sets the file's position indicator for this file descriptor as [lseek](#).
 If lseek is supported, it should not allow a seek to before the beginning of the file, but it should support seeking past the end of the file. Such seeks do not change the size of the file, but if it is followed by a write, the file size will increase.

Return Value If successful, this function returns the new value of the file position indicator.
 This function must return -1 to indicate an error if for some reason no bytes could be written to the file. For many devices, the lseek operation is nonsensical (e.g. a computer monitor).

DEV_unlink ***Delete File***

Syntax **int DEV_unlink (const char * path);**

Description Remove the association of the pathname with the file. This means that the file may no longer be opened using this name, but the file may not actually be immediately removed.
 Depending on the device, the file may be immediately removed, but for a device which allows open file descriptors to point to unlinked files, the file will not actually be deleted until the last file descriptor is closed. See [Section 8.2.3](#).

Return Value This function must return -1 to indicate an error if for some reason the file could not be unlinked (delayed removal does not count as a failure to unlink.)
 If successful, this function returns 0.

DEV_rename ***Rename File***

Syntax **int DEV_rename (const char * old_name , const char * new_name);**

Description This function changes the name associated with the file.
 • The *old_name* is the current name of the file.
 • The *new_name* is the new name for the file.

Return Value This function must return -1 to indicate an error if for some reason the file could not be renamed, such as the file doesn't exist, or the new name already exists.

NOTE: It is inadvisable to allow renaming a file so that it is on a different device. In general this would require a whole file copy, which may be more expensive than you expect.

If successful, this function returns 0.

8.2.4 Adding a User-Defined Device Driver for C I/O

The function `add_device` allows you to add and use a device. When a device is registered with `add_device`, the high-level I/O routines can be used for I/O on that device.

You can use a different protocol to communicate with any desired device and install that protocol using `add_device`; however, the HOST functions should not be modified. The default streams `stdin`, `stdout`, and `stderr` can be remapped to a file on a user-defined device instead of HOST by using `freopen()` as in [Example 8-1](#). If the default streams are reopened in this way, the buffering mode will change to `_IOFBF` (fully buffered). To restore the default buffering behavior, call `setvbuf` on each reopened file with the appropriate value (`_IOLBF` for `stdin` and `stdout`, `_IONBF` for `stderr`).

The default streams `stdin`, `stdout`, and `stderr` can be mapped to a file on a user-defined device instead of HOST by using `freopen()` as shown in [Example 8-1](#). Each function must set up and maintain its own data structures as needed. Some function definitions perform no action and should just return.

Example 8-1. Mapping Default Streams to Device

```
#include <stdio.h>
#include <file.h>
#include "mydevice.h"

void main()
{
    add_device("mydevice", _MSA,
              MYDEVICE_open, MYDEVICE_close,
              MYDEVICE_read, MYDEVICE_write,
              MYDEVICE_lseek, MYDEVICE_unlink, MYDEVICE_rename);

    /*-----*/
    /* Re-open stderr as a MYDEVICE file */
    /*-----*/
    if (!freopen("mydevice:stderrfile", "w", stderr))
    {
        puts("Failed to freopen stderr");
        exit(EXIT_FAILURE);
    }

    /*-----*/
    /* stderr should not be fully buffered; we want errors to be seen as */
    /* soon as possible. Normally stderr is line-buffered, but this example */
    /* doesn't buffer stderr at all. This means that there will be one call */
    /* to write() for each character in the message. */
    /*-----*/
    if (setvbuf(stderr, NULL, _IONBF, 0))
    {
        puts("Failed to setvbuf stderr");
        exit(EXIT_FAILURE);
    }

    /*-----*/
    /* Try it out! */
    /*-----*/
    printf("This goes to stdout\n");
    fprintf(stderr, "This goes to stderr\n"); }
```

NOTE: Use Unique Function Names

The function names `open`, `read`, `write`, `close`, `lseek`, `rename`, and `unlink` are used by the low-level routines. Use other names for the device-level functions that you write.

Use the low-level function `add_device()` to add your device to the `device_table`. The device table is a statically defined array that supports n devices, where n is defined by the macro `_NDEVICE` found in `stdio.h/cstdio`.

The first entry in the device table is predefined to be the host device on which the debugger is running. The low-level routine `add_device()` finds the first empty position in the device table and initializes the device fields with the passed-in arguments. For a complete description, see [the `add_device` function](#).

8.2.5 The device Prefix

A file can be opened to a user-defined device driver by using a device prefix in the pathname. The device prefix is the device name used in the call to `add_device` followed by a colon. For example:

```
FILE *fptr = fopen("mydevice:file1", "r");
int fd = open("mydevice:file2, O_RDONLY, 0);
```

If no device prefix is used, the HOST device will be used to open the file.

add_device	Add Device to Device Table				
Syntax for C	<pre>#include <file.h> int add_device(char * name, unsigned flags , int (* dopen)(const char *path, unsigned flags, int llv_fd), int (* dclose)(int dev_fd), int (* dread)(int dev_fd, char *buf, unsigned count), int (* dwrite)(int dev_fd, const char *buf, unsigned count), off_t (* dlseek)(int dev_fd, off_t ioffset, int origin), int (* dunlink)(const char * path), int (* drename)(const char *old_name, const char *new_name));</pre>				
Defined in	lowlev.c (in the lib/src subdirectory of the compiler installation)				
Description	<p>The <code>add_device</code> function adds a device record to the device table allowing that device to be used for I/O from C. The first entry in the device table is predefined to be the HOST device on which the debugger is running. The function <code>add_device()</code> finds the first empty position in the device table and initializes the fields of the structure that represent a device.</p> <p>To open a stream on a newly added device use <code>fopen()</code> with a string of the format <code>devicename : filename</code> as the first argument.</p> <ul style="list-style-type: none"> • The <i>name</i> is a character string denoting the device name. The name is limited to 8 characters. • The <i>flags</i> are device characteristics. The flags are as follows: <ul style="list-style-type: none"> <code>_SSA</code> Denotes that the device supports only one open stream at a time <code>_MSA</code> Denotes that the device supports multiple open streams More flags can be added by defining them in <code>file.h</code>. • The <i>dopen</i>, <i>dclose</i>, <i>dread</i>, <i>dwrite</i>, <i>dlseek</i>, <i>dunlink</i>, and <i>drename</i> specifiers are function pointers to the functions in the device driver that are called by the low-level functions to perform I/O on the specified device. You must declare these functions with the interface specified in Section 8.2.2. The device driver for the HOST that the TMS320C28x debugger is run on are included in the C I/O library. 				
Return Value	<p>The function returns one of the following values:</p> <table border="0"> <tr> <td style="padding-right: 20px;">0</td> <td>if successful</td> </tr> <tr> <td>-1</td> <td>on failure</td> </tr> </table>	0	if successful	-1	on failure
0	if successful				
-1	on failure				

Example

Example 8-2 does the following:

- Adds the device *mydevice* to the device table
- Opens a file named *test* on that device and associates it with the FILE pointer *fid*
- Writes the string *Hello, world* into the file
- Closes the file

Example 8-2 illustrates adding and using a device for C I/O:

Example 8-2. Program for C I/O Device

```

#include <file.h>
#include <stdio.h>
/*****
/* Declarations of the user-defined device drivers          */
*****/
extern int  MYDEVICE_open(const char *path, unsigned flags, int fno);
extern int  MYDEVICE_close(int fno);
extern int  MYDEVICE_read(int fno, char *buffer, unsigned count);
extern int  MYDEVICE_write(int fno, const char *buffer, unsigned count);
extern off_t MYDEVICE_lseek(int fno, off_t offset, int origin);
extern int  MYDEVICE_unlink(const char *path);
extern int  MYDEVICE_rename(const char *old_name, char *new_name);
main()
{
    FILE *fid;
    add_device("mydevice", _MSA, MYDEVICE_open, MYDEVICE_close, MYDEVICE_read,
              MYDEVICE_write, MYDEVICE_lseek, MYDEVICE_unlink, MYDEVICE_rename);
    fid = fopen("mydevice:test", "w");
    fprintf(fid, "Hello, world\n");

    fclose(fid);
}

```

8.3 Handling Reentrancy (`_register_lock()` and `_register_unlock()` Functions)

The C standard assumes only one thread of execution, with the only exception being extremely narrow support for signal handlers. The issue of reentrancy is avoided by not allowing you to do much of anything in a signal handler. However, SYS/BIOS applications have multiple threads which need to modify the same global program state, such as the CIO buffer, so reentrancy is a concern.

Part of the problem of reentrancy remains your responsibility, but the run-time-support environment does provide rudimentary support for multi-threaded reentrancy by providing support for critical sections. This implementation does not protect you from reentrancy issues such as calling run-time-support functions from inside interrupts; this remains your responsibility.

The run-time-support environment provides hooks to install critical section primitives. By default, a single-threaded model is assumed, and the critical section primitives are not employed. In a multi-threaded system such as SYS/BIOS, the kernel arranges to install semaphore lock primitive functions in these hooks, which are then called when the run-time-support enters code that needs to be protected by a critical section.

Throughout the run-time-support environment where a global state is accessed, and thus needs to be protected with a critical section, there are calls to the function `_lock()`. This calls the provided primitive, if installed, and acquires the semaphore before proceeding. Once the critical section is finished, `_unlock()` is called to release the semaphore.

Usually SYS/BIOS is responsible for creating and installing the primitives, so you do not need to take any action. However, this mechanism can be used in multi-threaded applications that do not use the SYS/BIOS locking mechanism.

You should not define the functions `_lock()` and `_unlock()` functions directly; instead, the installation functions are called to instruct the run-time-support environment to use these new primitives:

```
void _register_lock (void ( *lock)());
```

```
void _register_unlock(void (*unlock)());
```

The arguments to `_register_lock()` and `_register_unlock()` should be functions which take no arguments and return no values, and which implement some sort of global semaphore locking:

```
extern volatile sig_atomic_t *sema = SHARED_SEMAPHORE_LOCATION;
static int sema_depth = 0;
static void my_lock(void)
{
    while (ATOMIC_TEST_AND_SET(sema, MY_UNIQUE_ID) != MY_UNIQUE_ID);
    sema_depth++;
}
static void my_unlock(void)
{
    if (--sema_depth) ATOMIC_CLEAR(sema);
}
```

The run-time-support nests calls to `_lock()`, so the primitives must keep track of the nesting level.

8.4 Library-Build Process

When using the C/C++ compiler, you can compile your code under a large number of different configurations and options that are not necessarily compatible with one another. Because it would be infeasible to include all possible run-time-support library variants, compiler releases pre-build only a small number of very commonly-used libraries such as `rts2800_ml.lib`.

To provide maximum flexibility, the run-time-support source code is provided as part of each compiler release. You can build the missing libraries as desired. The linker can also automatically build missing libraries. This is accomplished with a new library build process, the core of which is the executable `mklib`, which is available beginning with CCS 5.1

8.4.1 Required Non-Texas Instruments Software

To use the self-contained run-time-support build process to rebuild a library with custom options, the following are required:

- `sh` (Bourne shell)
- `gmake` (GNU make 3.81 or later)

More information is available from GNU at <http://www.gnu.org/software/make>. GNU make (`gmake`) is also available in earlier versions of Code Composer Studio. GNU make is also included in some UNIX support packages for Windows, such as the MKS Toolkit, Cygwin, and Interix. The GNU make used on Windows platforms should explicitly report "This program build for Windows32" when the following is executed from the Command Prompt window:

```
gmake -h
```

All three of these programs are provided as a non-optional feature of CCS 5.1. They are also available as part of the optional XDC Tools feature if you are using an earlier version of CCS.

The `mklib` program looks for these executables in the following order:

1. in your `PATH`
2. in the directory `getenv("CCS_UTILS_DIR")/cygwin`
3. in the directory `getenv("CCS_UTILS_DIR")/bin`
4. in the directory `getenv("XDCROOT")`
5. in the directory `getenv("XDCROOT")/bin`

If you are invoking `mklib` from the command line, and these executables are not in your path, you must set the environment variable `CCS_UTILS_DIR` such that `getenv("CCS_UTILS_DIR")/bin` contains the correct programs.

8.4.2 Using the Library-Build Process

You should normally let the linker automatically rebuild libraries as needed. If necessary, you can run `mklib` directly to populate libraries. See [Section 8.4.2.2](#) for situations when you might want to do this.

8.4.2.1 Automatic Standard Library Rebuilding by the Linker

The linker looks for run-time-support libraries primarily through the `C2000_C_DIR` environment variable. Typically, one of the pathnames in `C2000_C_DIR` is *your install directory/lib*, which contains all of the pre-built libraries, as well as the index library `libc.a`. The linker looks in `C2000_C_DIR` to find a library that is the best match for the build attributes of the application. The build attributes are set indirectly according to the command-line options used to build the application. Build attributes include things like CPU revision. If the library name is explicitly specified (e.g. `-library=rts2800_ml.lib`), run-time support looks for that library exactly. If the library name is not specified, the linker uses the index library `libc.a` to pick an appropriate library. If the library is specified by path (e.g. `-library=/foo/rts2800_ml.lib`), it is assumed the library already exists and it will not be built automatically.

The index library describes a set of libraries with different build attributes. The linker will compare the build attributes for each potential library with the build attributes of the application and will pick the best fit. For details on the index library, see the archiver chapter in the *TMS320C28x Assembly Language Tools User's Guide*.

Now that the linker has decided which library to use, it checks whether the run-time-support library is present in C2000_C_DIR . The library must be in exactly the same directory as the index library `libc.a`. If the library is not present, the linker invokes `mklib` to build it. This happens when the library is missing, regardless of whether the user specified the name of the library directly or allowed the linker to pick the best library from the index library.

The `mklib` program builds the requested library and places it in 'lib' directory part of C2000_C_DIR in the same directory as the index library, so it is available for subsequent compilations.

Things to watch out for:

- The linker invokes **mklib** and waits for it to finish before finishing the link, so you will experience a one-time delay when an uncommonly-used library is built for the first time. Build times of 1-5 minutes have been observed. This depends on the power of the host (number of CPUs, etc).
- In a shared installation, where an installation of the compiler is shared among more than one user, it is possible that two users might cause the linker to rebuild the same library at the same time. The **mklib** program tries to minimize the race condition, but it is possible one build will corrupt the other. In a shared environment, all libraries which might be needed should be built at install time; see [Section 8.4.2.2](#) for instructions on invoking **mklib** directly to avoid this problem.
- The index library must exist, or the linker is unable to rebuild libraries automatically.
- The index library must be in a user-writable directory, or the library is not built. If the compiler installation must be installed read-only (a good practice for shared installation), any missing libraries must be built at installation time by invoking **mklib** directly.
- The **mklib** program is specific to a certain version of a certain library; you cannot use one compiler version's run-time support's **mklib** to build a different compiler version's run-time support library.

8.4.2.2 Invoking mklib Manually

You may need to invoke **mklib** directly in special circumstances:

- The compiler installation directory is read-only or shared.
- You want to build a variant of the run-time-support library that is not pre-configured in the index library **libc.a** or known to `mklib`. (e.g. a variant with source-level debugging turned on.)

8.4.2.2.1 Building Standard Libraries

You can invoke `mklib` directly to build any or all of the libraries indexed in the index library **libc.a**. The libraries are built with the standard options for that library; the library names and the appropriate standard option sets are known to `mklib`.

This is most easily done by changing the working directory to be the compiler run-time-support library directory 'lib' and invoking the **mklib** executable there:

```
mklib --pattern=rts2800_ml.lib
```

For C28x these libraries can be built:

- `rts2800_ml.lib` (C/C++ run-time object library)
- `rts2800_fpu32.lib` (C/C++ run-time object library for FPU targets)

8.4.2.2.2 Shared or Read-Only Library Directory

If the compiler tools are to be installed in shared or read-only directory, mklib cannot build the standard libraries at link time; the libraries must be built before the library directory is made shared or read-only.

At installation time, the installing user must build all of the libraries which will be used by any user. To build all possible libraries, change the working directory to be the compiler RTS library directory 'lib' and invoke the mklib executable there:

```
mklib --all
```

Some targets have many libraries, so this step can take a long time. To build a subset of the libraries, invoke mklib individually for each desired library.

8.4.2.2.3 Building Libraries With Custom Options

You can build a library with any extra custom options desired. This is useful for building a debugging version of the library, or with silicon exception workarounds enabled. The generated library is not a standard library, and must not be placed in the 'lib' directory. It should be placed in a directory local to the project which needs it. To build a debugging version of the library rts2800_ml.lib, change the working directory to the 'lib' directory and run the command:

```
mklib --pattern=rts2800_ml.lib --name=rts2800_debug.lib --install_to=$Project/Debug --extra_options="-g"
```

8.4.2.2.4 The mklib Program Option Summary

Run the following command to see the full list of options. These are described in [Table 8-1](#).

```
mklib --help
```

Table 8-1. The mklib Program Options

Option	Effect
<code>--index=filename</code>	The index library (libc.a) for this release. Used to find a template library for custom builds, and to find the source files (in the lib/src subdirectory of the compiler installation). REQUIRED.
<code>--pattern=filename</code>	Pattern for building a library. If neither <code>--extra_options</code> nor <code>--options</code> are specified, the library will be the standard library with the standard options for that library. If either <code>--extra_options</code> or <code>--options</code> are specified, the library is a custom library with custom options. REQUIRED unless <code>--all</code> is used.
<code>--all</code>	Build all standard libraries at once.
<code>--install_to=directory</code>	The directory into which to write the library. For a standard library, this defaults to the same directory as the index library (libc.a). For a custom library, this option is REQUIRED.
<code>--compiler_bin_dir=directory</code>	The directory where the compiler executables are. When invoking mklib directly, the executables should be in the path, but if they are not, this option must be used to tell mklib where they are. This option is primarily for use when mklib is invoked by the linker.
<code>--name=filename</code>	File name for the library with no directory part. Only useful for custom libraries.
<code>--options='str'</code>	Options to use when building the library. The default options (see below) are replaced by this string. If this option is used, the library will be a custom library.
<code>--extra_options='str'</code>	Options to use when building the library. The default options (see below) are also used. If this option is used, the library will be a custom library.
<code>--list_libraries</code>	List the libraries this script is capable of building and exit. ordinary system-specific directory.
<code>--log=filename</code>	Save the build log as filename.
<code>--tmpdir=directory</code>	Use directory for scratch space instead of the ordinary system-specific directory.
<code>--gmake=filename</code>	Gmake-compatible program to invoke instead of "gmake"
<code>--parallel=N</code>	Compile N files at once ("gmake -j N").
<code>--query=filename</code>	Does this script know how to build FILENAME?
<code>--help</code> or <code>--h</code>	Display this help.
<code>--quiet</code> or <code>--q</code>	Operate silently.
<code>--verbose</code> or <code>--v</code>	Extra information to debug this executable.

Examples:

To build all standard libraries and place them in the compiler's library directory:

```
mklib --all --index=$C_DIR/lib
```

To build one standard library and place it in the compiler's library directory:

```
mklib --pattern=rts2800_ml.lib --index=$C_DIR/lib
```

To build a custom library that is just like rts2800_ml.lib, but has symbolic debugging support enabled:

```
mklib --pattern=rts2800_ml.lib --extra_options="-g" --index=$C_DIR/lib --  
install_to=$Project/Debug --name=rts2800_debug.lib
```

8.4.3 Extending mklib

The **mklib** API is a uniform interface that allows Code Composer Studio to build libraries without needing to know exactly what underlying mechanism is used to build it. Each library vendor (e.g. the TI compiler) provides a library-specific copy of 'mklib' in the library directory that can be invoked, which understands a standardized set of options, and understands how to build the library. This allows the linker to automatically build application-compatible versions of any vendor's library without needing to register the library in advance, as long as the vendor supports mklib.

8.4.3.1 Underlying Mechanism

The underlying mechanism can be anything the vendor desires. For the compiler run-time-support libraries, mklib is just a wrapper that knows how to use the files in the lib/src subdirectory of the compiler installation and invoke gmake with the appropriate options to build each library. If necessary, mklib can be bypassed and the Makefile used directly, but this mode of operation is not supported by TI, and you are responsible for any changes to the Makefile. The format of the Makefile and the interface between mklib and the Makefile is subject to change without notice. The mklib program is the forward-compatible path.

8.4.3.2 Libraries From Other Vendors

Any vendor who wishes to distribute a library that can be rebuilt automatically by the linker must provide:

- An index library (like 'libc.a', but with a different name)
- A copy of mklib specific to that library
- A copy of the library source code (in whatever format is convenient)

These things must be placed together in one directory that is part of the linker's library search path (specified either in C2000_C_DIR or with the linker --search_path option).

If mklib needs extra information that is not possible to pass as command-line options to the compiler, the vendor will need to provide some other means of discovering the information (such as a configuration file written by a wizard run from inside CCS).

The vendor-supplied mklib must at least accept all of the options listed in [Table 8-1](#) without error, even if they do not do anything.

C++ Name Demangler

The C++ compiler implements function overloading, operator overloading, and type-safe linking by encoding a function's prototype and namespace in its link-level name. The process of encoding the prototype into the linkname is often referred to as name mangling. When you inspect mangled names, such as in assembly files, disassembler output, or compiler or linker diagnostic messages, it can be difficult to associate a mangled name with its corresponding name in the C++ source code. The C++ name demangler is a debugging aid that translates each mangled name it detects to its original name found in the C++ source code.

These topics tell you how to invoke and use the C++ name demangler. The C++ name demangler reads in input, looking for mangled names. All unmangled text is copied to output unaltered. All mangled names are demangled before being copied to output.

Topic	Page
9.1 Invoking the C++ Name Demangler	187
9.2 C++ Name Demangler Options	187
9.3 Sample Usage of the C++ Name Demangler	188

9.1 Invoking the C++ Name Demangler

The syntax for invoking the C++ name demangler is:

dem2000 [*options*] [*filenames*]

dem2000	Command that invokes the C++ name demangler.
<i>options</i>	Options affect how the name demangler behaves. Options can appear anywhere on the command line. (Options are discussed in Section 9.2 .)
<i>filenames</i>	Text input files, such as the assembly file output by the compiler, the assembler listing file, the disassembly file, and the linker map file. If no filenames are specified on the command line, dem2000 uses standard input.

By default, the C++ name demangler outputs to standard output. You can use the `-o` file option if you want to output to a file.

9.2 C++ Name Demangler Options

The following options apply only to the C++ name demangler:

--debug	Prints debug messages.
--diag_wrap [=on,off]	Sets diagnostic messages to wrap at 79 columns (on, which is the default) or not (off).
--help	Prints a help screen that provides an online summary of the C++ name demangler options.
--output= <i>file</i>	Outputs to the specified file rather than to standard out.
--quiet	Reduces the number of messages generated during execution.
-u	Specifies that external names do not have a C++ prefix.
-v	Enables verbose mode (outputs a banner).

9.3 Sample Usage of the C++ Name Demangler

The examples in this section illustrate the demangling process. [Example 9-1](#) shows a sample C++ program. [Example 9-2](#) shows the resulting assembly that is output by the compiler. In this example, the linknames of all the functions are mangled; that is, their signature information is encoded into their names.

Example 9-1. C++ Code

```
int compute(int val, int *err);

int foo(int val, int *err)
{
    static int last_err = 0;
    int result = 0

    if (last_err == 0)
        result = compute(val, &last_err);

    *err = last_err;
    return result;
}
```

Example 9-2. Resulting Assembly for [Example 9-1](#)

```
*****
;* FNAME: _foo_FiPi                FR SIZE:  4      *
;*                                *
;* FUNCTION ENVIRONMENT           *
;*                                *
;* FUNCTION PROPERTIES            *
;*                                0 Parameter, 3 Auto, 0 SOE *
*****

_foo_FiPi:
    ADDB     SP,#4
    MOVZ    DP,#_last_err$1
    MOV     *-SP[1],AL
    MOV     AL,@_last_err$1
    MOV     *-SP[2],AR4
    MOV     *-SP[3],#0
    BF     L1,NEQ
    ; branch occurs
    MOVL    XAR4,#_last_err$1
    MOV     AL,*-SP[1]
    LCR     #_compute__FiPi
    ; call occurs [#_compute__FiPi]
    MOV     *-SP[3],AL
L1:
    MOVZ    AR6,*-SP[2]
    MOV     *+XAR6[0],*(0:_last_err$1)
    MOV     AL,*-SP[3]
    SUBB    SP,#4
    LRETR
    ; return occurs
```

Executing the C++ name demangler demangles all names that it believes to be mangled. Enter:

```
dem2000 foo.asm
```

The result is shown in [Example 9-3](#). The linknames in [Example 9-2](#) `foo()` and `compute()` are demangled.

Example 9-3. Result After Running the C++ Name Demangler

```

;*****
;* FNAME: foo(int, int *)           FR SIZE: 4           *
;*                                 *
;* FUNCTION ENVIRONMENT             *
;*                                 *
;* FUNCTION PROPERTIES              *
;*                                 0 Parameter, 3 Auto, 0 SOE *
;*****

foo(int, int *):
    ADDB        SP,#4
    MOVZ        DP,#_last_err$1
    MOV         *-SP[1],AL
    MOV         AL,@_last_err$1
    MOV         *-SP[2],AR4
    MOV         *-SP[3],#0
    BF          L1,NEQ
    ; branch occurs
    MOVL        XAR4,#_last_err$1
    MOV         AL,*-SP[1]
    LCR         #compute(int, int *)
    ; call occurs [#compute(int, int *)]
    MOV         *-SP[3],AL
L1:
    MOVZ        AR6,*-SP[2]
    MOV         *+XAR6[0],*(0:_last_err$1)
    MOV         AL,*-SP[3]
    SUBB        SP,#4
    LRETR
    ; return occurs

```

CLA Compiler

The TMS320C28x Software Development toolset also includes support for compiling CLA C code. Because of CLA architecture and programming environment constraints, the C language support has some restrictions that are detailed in [Section 10.2.2](#).

As when including CLA assembly, compiled CLA code is linked together with C28x code to create a single executable.

Topic	Page
10.1 How to Invoke the CLA Compiler	191
10.2 CLA C Language Implementation	192

10.1 How to Invoke the CLA Compiler

The Control Law Accelerator (CLA) compiler is also invoked using the `cl2000` command. Files that have a `.cla` extension are recognized by the compiler as CLA C files. The shell invokes separate CLA versions of the compiler passes to generate CLA-specific code. The `--cla_support` option is also required to assemble the output from the CLA code generator.

If you use the `--cla_default` option, files with an extension of `.c` are also compiled as CLA files.

Support is provided for Type 0, Type 1, and Type 2 CLA.

The object files generated by the compile can then be linked with other C28x objects files to create a combined C28x/CLA program.

To invoke the CLA compiler, enter:

```
cl2000 --cla_support=[cla0|cla1|cla2] [other options] file.cla
```

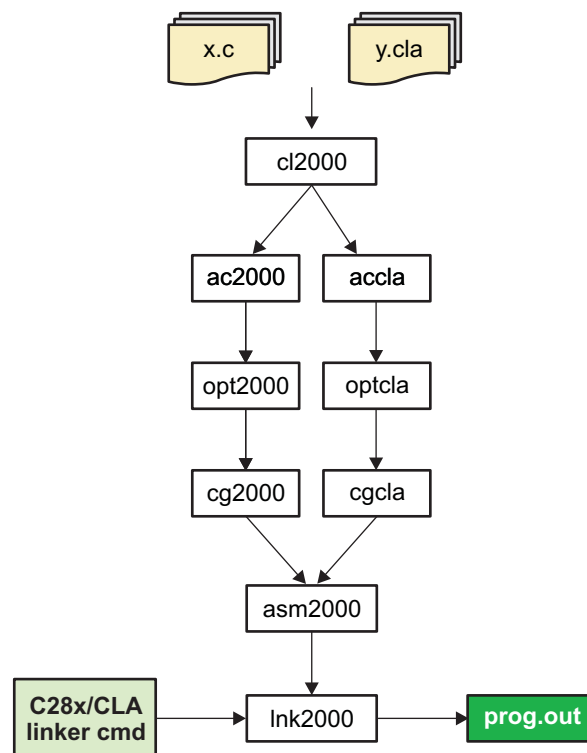

Figure 10-1. CLA Compilation Overview

Important facts about CLA C files:

- Files with `.cla` extension compile using different parser, optimizer, and code generator.
- `cl2000` does not support compiling files using both the C and CLA compilers in a single invocation.
- C28X/CLA builds requires linker command file changes to accommodate CLA compiler-generated sections and scratchpad area.

10.2 CLA C Language Implementation

The CLA C language implementation requires changes from standard C.

10.2.1 Characteristics

CLA implementation supports C only. The compiler produces an error if compiling for C++.

These data types are supported:

- Type char is 16 bits.
- Type short is 16 bits. A char/short should be limited to load/store operations.
- Types int, long, and long long are 32 bits.

Note that the int size for CLA is 32 bits versus 16 bits on C28x. To avoid ambiguity when sharing data between CLA and C28x, it is strongly recommended to use type declarations that include size information (for example, int32 and uint16).

- Types float, double, and long double are 32 bits.
- Pointers are 16 bits.

Pointer sizes for CLA are always 16-bits. This differs from C28x, which has 32-bit pointers.

No 64-bit Types With CLA Compiler

NOTE: The CLA compiler does not support 64-bit types.

CLA accepts the C28x pragmas except for FAST_FUNC_CALL.

The C standard library is not supported.

The far and ioport keywords are not recognized.

Access to the 'MMOV32 MSTF,mem32' and 'MMOV32 mem32,MSTF' instructions is provided using the register keyword. To access these MSTF instructions include the following declaration:

```
extern cregister volatile unsigned int MSTF;
```

The intrinsics listed in [Table 10-1](#) are supported. Additionally, the run-time library functions abs() and fabs() are implemented as intrinsics.

Table 10-1. C/C++ Compiler Intrinsics for CLA

Intrinsic	Assembly Instruction(s)	Description
<code>__mdebugstop()</code>	MDEBUGSTOP	Debug stop
<code>__meallow()</code>	MEALLOW	Enable write access to EALLOW registers
<code>__medis()</code>	MEDIS	Disable write access to EALLOW registers
<code>float __meinvf32(float x);</code>	MEINVF32 x	Estimate 1/x to about 8 bits of precision.
<code>float __meisqrtf32(float x);</code>	MEISQRTF32 x	Estimate the square root of 1/x to about 8 bits of precision.
<code>short __mf32toi16r(float src);</code>	MF32TOI16R dst, src	Convert double to int and round.
<code>unsigned short __mf32toui16r(float src);</code>	MF32TOUI16R dst, src	Convert double to unsigned int and round.
<code>float __mmaxf32(float x, float y);</code>	MMAXF32 dst, src	If <i>src</i> > <i>dst</i> , copy <i>src</i> to <i>dst</i>
<code>float __mminf32(float x, float y);</code>	MMINF32 dst, src	If <i>src</i> < <i>dst</i> , copy <i>src</i> to <i>dst</i>
<code>float __mfracf32(float src);</code>	MFRACF32 dst, src	Return the fractional portion of <i>src</i> .
<code>__mnop()</code>	MNOP	CLA no operation

Table 10-1. C/C++ Compiler Ininsics for CLA (continued)

Intrinsic	Assembly Instruction(s)	Description
<code>__msetflg(unsigned short <i>flag</i>, unsigned short <i>value</i>)</code>	<code>MSETFLG <i>flag</i>, <i>value</i></code>	Set/clear selected flag(s) in the MSTF register. The first argument is a bit mask that indicates which bits are to be modified. The second argument provides the values to be assigned to these bits. See the <i>CLA Reference Guide (SPRUGE6)</i> for details about the MSETFLG instruction and the flags in the MSET register. The following example sets the RND32 flag (bit 7) to 0, the TF flag (bit 6) to 0, and the NF flag (bit 2) to 1. The 0b prefix is a GCC language extension that tells the compiler that these are binary numbers. <code>__msetflg(0b11000100, 0b00000100);</code>
<code>void __mswapf(float <i>a</i>, float <i>b</i>);</code>	<code>MSWAPF <i>a</i>, <i>b</i></code>	Swap the contents of <i>a</i> and <i>b</i> .

The following intrinsics are available only within CLA2 background tasks. The background task has the lowest priority task and so will always be interrupted when another interrupt is available. These intrinsics can be used to temporarily prevent such interrupts from suspending the background task.

- `__disable_interrupts();`
- `__enable_interrupts();`

10.2.2 C Language Restrictions

There are several restrictions to the C language for CLA.

- Defining and initializing global/static data is not supported.
Since the CLA code is executed in an interrupt driven environment, there is no C system boot sequence. As a result, global/static data initialization must be done during program execution, either by the C28x driver code or within a CLA function.
Variables defined as `const` can be initialized globally. The compiler creates initialized data sections named `.const_cla` to hold these variables.
- Recursive function calls are not supported.
- The use of function pointers is not supported.

Most GCC extensions are now supported by the CLA compiler. Both the C and the CLA compiler have GCC extensions enabled by default. See the `--relaxed_ansi` option in [Section 6.13.2](#) and the list of GCC language extensions in [Section 6.14](#) for more information.

The interrupt function attribute described in [Section 6.9.14](#) can be used with CLA interrupts, so long as you do not include any arguments to the interrupt attribute. The `INTERRUPT` pragma is also supported by the CLA compiler. For example, the following uses are supported:

```
__attribute__((interrupt))
void interrupt_name(void) {...}
```

```
#pragma INTERRUPT(interrupt_name);
void interrupt_name(void) {...}
```

For CLA2 background tasks, the "BACKGROUND" argument specifies that this is a background task instead of a regular interrupt. The following uses are supported.

```
__attribute__((interrupt("BACKGROUND")))
void task_name(void) {...}
```

```
#pragma INTERRUPT(task_name, "BACKGROUND");
void task_name(void) {...}
```

10.2.3 Memory Model - Sections

Uninitialized global data is placed in section `.bss_cla`.

Initialized const data is placed in section `.const_cla`.

There is no C system heap for CLA, because there is no support for `malloc()`.

Local variables and compiler temps are placed into a scratchpad memory area, which acts as the CLA C software stack. It is expected that the scratchpad memory area is defined and managed in the application's linker command file.

Instead of using a stack, each function has a generated function frame that is part of the `.scratchpad` section. Therefore, the only section that needs to be placed in the linker command file is the `.scratchpad` section. A scratchpad frame is designated for each function to hold local data, function arguments, and temporary storage. The linker determines which function frames can be overlaid in placement to save memory.

CLA function frames are placed in the `.scratchpad` section and are named in the form `".scratchpad:functionSectionName"`. Each function has its own subsection, and thus a unique section name. For example, if the source-level function name is `"Cla1Task1"`, then the COFF function name will be `"_Cla1Task1"`, the function section name will be `"Cla1Prog:_Cla1Task1"`, and the function's scratchpad frame will be named `".scratchpad:Cla1Prog:_Cla1Task1"`. The function's scratchpad frame will use the base symbol `"__cla_Cla1Task1_sp"`.

CLA2 background tasks are placed in the `.scratchpad` section and are named in the form `".scratchpad:background:functionSectionName"`. The background task frame cannot be overlaid with any other function frames, since the background task is likely to be returned to after yielding to interrupts.

Note that if an assembly writer uses a different naming convention for the data space of a function, it cannot be overlaid nor placed within the `.scratchpad` section.

It is not necessary to specify a size for the `.scratchpad` section.

CLA object files compiled with compiler versions prior to 6.4 are compatible with newly generated object files so long as the linker command file supports both scratchpad naming conventions. However, the scratchpad section used for old object files cannot be overlaid with the new `.scratchpad` section and you must ensure that enough memory is available for both sections.

10.2.4 Function Structure and Calling Conventions

The CLA compiler supports multiple nested levels of function calls. The restriction to two levels of function calls has been removed. If you are using the new function call support, the CLA compiler now also supports calling functions with more than two arguments.

Pointer arguments are passed in `MAR0` and `MAR1`. 32-bit values are passed in `MR0`, `MR1`, and `MR2`. 16-bit values are passed in `MR0`, `MR1`, and `MR2`. Any further arguments are passed on the function frame (function-local scratchpad space), starting at offset 0.

All registers except for `MR3` are saved on call. `MR3` is saved on entry.

When interfacing with CLA assembly language modules, use these calling conventions to interface with compiled CLA code.

Glossary

A.1 Terminology

absolute lister— A debugging tool that allows you to create assembler listings that contain absolute addresses.

Application Binary Interface (ABI)— A standard that specifies the interface between two object modules. An ABI specifies how functions are called and how information is passed from one program component to another.

assignment statement— A statement that initializes a variable with a value.

autoinitialization— The process of initializing global C variables (contained in the .cinit section) before program execution begins.

autoinitialization at run time— An autoinitialization method used by the linker when linking C code. The linker uses this method when you invoke it with the `--rom_model` link option. The linker loads the .cinit section of data tables into memory, and variables are initialized at run time.

alias disambiguation— A technique that determines when two pointer expressions cannot point to the same location, allowing the compiler to freely optimize such expressions.

aliasing— The ability for a single object to be accessed in more than one way, such as when two pointers point to a single object. It can disrupt optimization, because any indirect reference could refer to any other object.

allocation— A process in which the linker calculates the final memory addresses of output sections.

ANSI— American National Standards Institute; an organization that establishes standards voluntarily followed by industries.

archive library— A collection of individual files grouped into a single file by the archiver.

archiver— A software program that collects several individual files into a single file called an archive library. With the archiver, you can add, delete, extract, or replace members of the archive library.

assembler— A software program that creates a machine-language program from a source file that contains assembly language instructions, directives, and macro definitions. The assembler substitutes absolute operation codes for symbolic operation codes and absolute or relocatable addresses for symbolic addresses.

assignment statement— A statement that initializes a variable with a value.

autoinitialization— The process of initializing global C variables (contained in the .cinit section) before program execution begins.

autoinitialization at run time— An autoinitialization method used by the linker when linking C code. The linker uses this method when you invoke it with the `--rom_model` link option. The linker loads the .cinit section of data tables into memory, and variables are initialized at run time.

big endian— An addressing protocol in which bytes are numbered from left to right within a word. More significant bytes in a word have lower numbered addresses. Endian ordering is hardware-specific and is determined at reset. See also *little endian*

block— A set of statements that are grouped together within braces and treated as an entity.

- byte**— Per ANSI/ISO C, the smallest addressable unit that can hold a character.
- C/C++ compiler**— A software program that translates C source statements into assembly language source statements.
- code generator**— A compiler tool that takes the file produced by the parser or the optimizer and produces an assembly language source file.
- COFF**— Common object file format; a system of object files configured according to a standard developed by AT&T. These files are relocatable in memory space.
- command file**— A file that contains options, filenames, directives, or commands for the linker or hex conversion utility.
- comment**— A source statement (or portion of a source statement) that documents or improves readability of a source file. Comments are not compiled, assembled, or linked; they have no effect on the object file.
- compiler program**— A utility that lets you compile, assemble, and optionally link in one step. The compiler runs one or more source modules through the compiler (including the parser, optimizer, and code generator), the assembler, and the linker.
- configured memory**— Memory that the linker has specified for allocation.
- constant**— A type whose value cannot change.
- cross-reference listing**— An output file created by the assembler that lists the symbols that were defined, what line they were defined on, which lines referenced them, and their final values.
- .data section**— One of the default object file sections. The .data section is an initialized section that contains initialized data. You can use the .data directive to assemble code into the .data section.
- direct call**— A function call where one function calls another using the function's name.
- directives**— Special-purpose commands that control the actions and functions of a software tool (as opposed to assembly language instructions, which control the actions of a device).
- disambiguation**— See *alias disambiguation*
- dynamic memory allocation**— A technique used by several functions (such as malloc, calloc, and realloc) to dynamically allocate memory for variables at run time. This is accomplished by defining a large memory pool (heap) and using the functions to allocate memory from the heap.
- ELF**— Executable and Linkable Format; a system of object files configured according to the System V Application Binary Interface specification.
- emulator**— A hardware development system that duplicates the TMS320C28x operation.
- entry point**— A point in target memory where execution starts.
- environment variable**— A system symbol that you define and assign to a string. Environmental variables are often included in Windows batch files or UNIX shell scripts such as .cshrc or .profile.
- epilog**— The portion of code in a function that restores the stack and returns.
- executable object file**— A linked, executable object file that is downloaded and executed on a target system.
- expression**— A constant, a symbol, or a series of constants and symbols separated by arithmetic operators.
- external symbol**— A symbol that is used in the current program module but defined or declared in a different program module.

- file-level optimization**— A level of optimization where the compiler uses the information that it has about the entire file to optimize your code (as opposed to program-level optimization, where the compiler uses information that it has about the entire program to optimize your code).
- function inlining**— The process of inserting code for a function at the point of call. This saves the overhead of a function call and allows the optimizer to optimize the function in the context of the surrounding code.
- global symbol**— A symbol that is either defined in the current module and accessed in another, or accessed in the current module but defined in another.
- high-level language debugging**— The ability of a compiler to retain symbolic and high-level language information (such as type and function definitions) so that a debugging tool can use this information.
- indirect call**— A function call where one function calls another function by giving the address of the called function.
- initialization at load time**— An autoinitialization method used by the linker when linking C/C++ code. The linker uses this method when you invoke it with the `--ram_model` link option. This method initializes variables at load time instead of run time.
- initialized section**— A section from an object file that will be linked into an executable object file.
- input section**— A section from an object file that will be linked into an executable object file.
- integrated preprocessor**— A C/C++ preprocessor that is merged with the parser, allowing for faster compilation. Stand-alone preprocessing or preprocessed listing is also available.
- interlist feature**— A feature that inserts as comments your original C/C++ source statements into the assembly language output from the assembler. The C/C++ statements are inserted next to the equivalent assembly instructions.
- intrinsics**— Operators that are used like functions and produce assembly language code that would otherwise be inexpressible in C, or would take greater time and effort to code.
- ISO**— International Organization for Standardization; a worldwide federation of national standards bodies, which establishes international standards voluntarily followed by industries.
- K&R C**— Kernighan and Ritchie C, the de facto standard as defined in the first edition of *The C Programming Language* (K&R). Most K&R C programs written for earlier, non-ISO C compilers should correctly compile and run without modification.
- label**— A symbol that begins in column 1 of an assembler source statement and corresponds to the address of that statement. A label is the only assembler statement that can begin in column 1.
- linker**— A software program that combines object files to form an executable object file that can be allocated into system memory and executed by the device.
- listing file**— An output file, created by the assembler, which lists source statements, their line numbers, and their effects on the section program counter (SPC).
- little endian**— An addressing protocol in which bytes are numbered from right to left within a word. More significant bytes in a word have higher numbered addresses. Endian ordering is hardware-specific and is determined at reset. See also *big endian*.
- loader**— A device that places an executable object file into system memory.
- macro**— A user-defined routine that can be used as an instruction.
- macro call**— The process of invoking a macro.
- macro definition**— A block of source statements that define the name and the code that make up a macro.
- macro expansion**— The process of inserting source statements into your code in place of a macro call.

- map file**— An output file, created by the linker, which shows the memory configuration, section composition, section allocation, symbol definitions and the addresses at which the symbols were defined for your program.
- memory map**— A map of target system memory space that is partitioned into functional blocks.
- name mangling**— A compiler-specific feature that encodes a function name with information regarding the function's arguments return types.
- object file**— An assembled or linked file that contains machine-language object code.
- object library**— An archive library made up of individual object files.
- operand**— An argument of an assembly language instruction, assembler directive, or macro directive that supplies information to the operation performed by the instruction or directive.
- optimizer**— A software tool that improves the execution speed and reduces the size of C programs.
- options**— Command-line parameters that allow you to request additional or specific functions when you invoke a software tool.
- output section**— A final, allocated section in a linked, executable module.
- overlay page**— A section of physical memory that is mapped into the same address range as another section of memory. A hardware switch determines which range is active.
- parser**— A software tool that reads the source file, performs preprocessing functions, checks the syntax, and produces an intermediate file used as input for the optimizer or code generator.
- partitioning**— The process of assigning a data path to each instruction.
- pop**— An operation that retrieves a data object from a stack.
- pragma**— A preprocessor directive that provides directions to the compiler about how to treat a particular statement.
- preprocessor**— A software tool that interprets macro definitions, expands macros, interprets header files, interprets conditional compilation, and acts upon preprocessor directives.
- program-level optimization**— An aggressive level of optimization where all of the source files are compiled into one intermediate file. Because the compiler can see the entire program, several optimizations are performed with program-level optimization that are rarely applied during file-level optimization.
- prolog**— The portion of code in a function that sets up the stack.
- push**— An operation that places a data object on a stack for temporary storage.
- quiet run**— An option that suppresses the normal banner and the progress information.
- raw data**— Executable code or initialized data in an output section.
- relocation**— A process in which the linker adjusts all the references to a symbol when the symbol's address changes.
- run-time environment**— The run time parameters in which your program must function. These parameters are defined by the memory and register conventions, stack organization, function call conventions, and system initialization.
- run-time-support functions**— Standard ISO functions that perform tasks that are not part of the C language (such as memory allocation, string conversion, and string searches).
- run-time-support library**— A library file, rts.src, which contains the source for the run time-support functions.

- section**— A relocatable block of code or data that ultimately will be contiguous with other sections in the memory map.
- sign extend**— A process that fills the unused MSBs of a value with the value's sign bit.
- source file**— A file that contains C/C++ code or assembly language code that is compiled or assembled to form an object file.
- stand-alone preprocessor**— A software tool that expands macros, #include files, and conditional compilation as an independent program. It also performs integrated preprocessing, which includes parsing of instructions.
- static variable**— A variable whose scope is confined to a function or a program. The values of static variables are not discarded when the function or program is exited; their previous value is resumed when the function or program is reentered.
- storage class**— An entry in the symbol table that indicates how to access a symbol.
- string table**— A table that stores symbol names that are longer than eight characters (symbol names of eight characters or longer cannot be stored in the symbol table; instead they are stored in the string table). The name portion of the symbol's entry points to the location of the string in the string table.
- structure**— A collection of one or more variables grouped together under a single name.
- subsection**— A relocatable block of code or data that ultimately will occupy continuous space in the memory map. Subsections are smaller sections within larger sections. Subsections give you tighter control of the memory map.
- symbol**— A string of alphanumeric characters that represents an address or a value.
- symbolic debugging**— The ability of a software tool to retain symbolic information that can be used by a debugging tool such as an emulator or simulator.
- target system**— The system on which the object code you have developed is executed.
- .text section**— One of the default object file sections. The .text section is initialized and contains executable code. You can use the .text directive to assemble code into the .text section.
- trigraph sequence**— A 3-character sequence that has a meaning (as defined by the ISO 646-1983 Invariant Code Set). These characters cannot be represented in the C character set and are expanded to one character. For example, the trigraph '??' is expanded to '^'.
- unconfigured memory**— Memory that is not defined as part of the memory map and cannot be loaded with code or data.
- uninitialized section**— A object file section that reserves space in the memory map but that has no actual contents.
- unsigned value**— A value that is treated as a nonnegative number, regardless of its actual sign.
- variable**— A symbol representing a quantity that can assume any of a set of values.
- word**— A 16-bit addressable location in target memory

Revision History

B.1 Recent Revisions

Table B-1 lists significant changes made to this document. The left column identifies the first version of this document in which that particular change appeared.

Table B-1. Revision History

Version Added	Chapter	Location	Additions / Modifications / Deletions
SPRU514P	C/C++ Language	Section 6.14	The compiler now supports several Clang <code>__has_</code> macro extensions.
SPRU514P	C/C++ Language	Section 6.14.1	The wrapper header file GCC extension (<code>#include_next</code>) is now supported.
Previous Revisions:			
SPRU514O	C/C++ Language	Section 6.5.1	Clarified exceptions to <code>const</code> data storage set by the <code>const</code> keyword.
SPRU514N	Optimizing Your Code	Section 3.5.1.4	Corrected error in command to process the profile data.
SPRU514M	Using the Compiler C/C++ Language, and CLA Compiler	Section 2.3 , Section 2.3.4 , Section 2.5.1 , Section 6.9.14 , and Section 10.2	Documented support for CLA version 2 and CLA v2 background tasks.
SPRU514M	Using the Compiler, C/C++ Language	Section 2.3.3 , Section 6.3 , Section 6.9.2 , and Section 6.9.17	Revised to state that <code>--check_misra</code> option is required even if the <code>CHECK_MISRA</code> pragma is used.
SPRU514M	Using the Compiler	Section 2.3.5	Removed the <code>--symdebug:coff</code> option, which is no longer supported.
SPRU514M	Using the Compiler	Section 2.10	Corrected the document to describe the <code>---gen_preprocessor_listing</code> option. The name <code>--gen_parser_listing</code> was incorrect.
SPRU514M	Optimizing Your Code	Section 3.10	Provided information about data page blocking.
SPRU514L	Optimizing Your Code	Section 3.5.3	Corrected function names for <code>_TI_start_pprof_collection()</code> and <code>_TI_stop_pprof_collection()</code> .
SPRU514L	CLA Compiler	Section 10.2.1	Provided additional information and an example for the <code>__msetflg</code> intrinsic.
SPRU514K	Using the Compiler	Section 2.3.13	Several compiler options have been deprecated, removed, or renamed. The compiler continues to accept some of the deprecated options, but they are not recommended for use. See the Compiler Option Cleanup wiki page for a list of deprecated and removed options, options that have been removed from CCS, and options that have been renamed.
SPRU514J	Using the Compiler	Section 2.3 and Section 4.2.2	The <code>--gen_data_subsections</code> option has been added.
SPRU514J	Using the Compiler	Section 2.3.5	The <code>--symdebug:dwarf_version</code> compiler option has been added. This option sets the DWARF debugging format version used.
SPRU514J	Optimizing Your Code	Section 3.5 and Section 3.6	Feedback directed optimization is described. This technique can be used for code coverage analysis.
SPRU514J	C/C++ Language	Section 6.9.1	A <code>CALLS</code> pragma has been added to specify a set of functions that can be called indirectly from a specified calling function. Using this pragma allows such indirect calls to be included in the calculation of a functions' inclusive stack size.
SPRU514J	C/C++ Language	Section 6.14.6	A <code>byte_peripheral</code> type attribute and an intrinsic have been added to access byte peripheral data.

Table B-1. Revision History (continued)

Version Added	Chapter	Location	Additions / Modifications / Deletions
SPRU514J	Run-Time Environment	Section 7.5.6	Intrinsics have been added to perform unsigned integer division. The new intrinsics are <code>__euclidean_div_i32byu32()</code> , <code>__rpt_subcul()</code> , and <code>__subcul()</code> .
SPRU514J	Run-Time Environment	Section 7.9.1	Additional boot hook functions are available. These can be customized for use during system initialization.
SPRU514I	Using the Compiler	Table 2-7	The <code>--cla_default</code> option has been added. This option causes files with an extension of <code>.c</code> to be processed as CLA files.
SPRU514I	Using the Compiler	Section 2.3.4	The <code>--ramfunc</code> option has been added. If set, this option places all functions in RAM.
SPRU514I	Using the Compiler	Section 2.3.13	The <code>--no_fast_branch</code> option has been deprecated.
SPRU514I	C/C++ Language	Section 6.13.1	C99 math support is now available, including float and long double versions of floating point math functions.
SPRU514I	C/C++ Language	Section 6.14.2	The <code>ramfunc</code> function attribute has been added. It specifies that a function should be placed in RAM.
SPRU514I	Run-Time Environment	Section 7.3.2	Added XAR6 to the list of registers and corrected the location in which the address of the returned structure is placed.
SPRU514I	Run-Time Environment	Section 7.5.6	Added the <code>__eallow</code> and <code>__edis</code> intrinsics.
SPRU514I	CLA Compiler	Section 10.2.2	Most GCC extensions are now supported by the CLA compiler.
SPRU514H	Introduction	Section 1.3	Added support for C99 and C++03.
SPRU514H	Using the Compiler	Table 2-7	Added support for C99 and C++03. The <code>-gcc</code> option has been deprecated. The <code>--relaxed_ansi</code> option is now the default.
SPRU514H	Using the Compiler	Section 2.3.3	Added the <code>--advice:performance</code> option.
SPRU514H	Using the Compiler	Section 2.3.4	The <code>--silicon_version=27</code> option is no longer supported.
SPRU514G	Using the Compiler	Section 2.3.4	Added <code>--tmu_support=tmu0</code> option. This option also affects the behavior of the <code>--float_support</code> and <code>--fp_mode=relaxed</code> options.
SPRU514G	Using the Compiler	Section 2.3.4	Added support for Type 1 CLA via <code>--cla_support=cla1</code> .
SPRU514G	Using the Compiler	Section 2.3.4	Added support for Type 2 VCU via <code>--vcu_support=vcu2</code> .
SPRU514H	Using the Compiler	Section 2.3.11	Added information about the <code>--flash_prefetch_warn</code> option.
SPRU514H	Using the Compiler	Section 2.5.1	Added several predefined macro names that were not documented.
SPRU514H	Using the Compiler	Section 2.5.3	Documented that the <code>#warning</code> and <code>#warn</code> preprocessor directives are supported.
SPRU514H	Using the Compiler	Section 2.6	Added section on techniques for passing arguments to <code>main()</code> .
SPRU514H	Using the Compiler	Section 2.11	Documented that the <code>inline</code> keyword is now enabled in all modes except C89 strict ANSI mode.
SPRU514H	C/C++ Language	Section 6.4	The size of pointer types on C28x is now 32 bits instead of 22 bits. The near and far keywords are deprecated. The small memory model is no longer supported; the only memory model uses 32-bit pointers. The <code>.bss</code> , <code>.const</code> , and <code>.system</code> sections are no longer used; the <code>.ebss</code> , <code>.econst</code> , and <code>.esystem</code> sections are used instead. (Symbol addresses are assumed to be less than 22 bits for performance reasons.)
SPRU514H	C/C++ Language	Section 6.1.1	Added section documenting implementation-defined behavior.
SPRU514H	C/C++ Language	Section 6.4.1	Added documentation on the size of enum types.
SPRU514H	C/C++ Language	Section 6.9.3 , Section 6.9.14 , Section 6.9.18 , and Section 6.14.2	Added C++ syntax for the CLINK, INTERRUPT, and RETAIN pragmas. Also removed unnecessary semicolons from <code>#pragma</code> syntax specifications. Also the GCC interrupt and alias function attributes are now supported.
SPRU514H	C/C++ Language	Section 6.9.10 and Section 6.9.11	Added the <code>FUNC_ALWAYS_INLINE</code> and <code>FUNC_CANNOT_INLINE</code> pragmas.
SPRU514H	C/C++ Language	Section 6.9.8	Added the <code>diag_push</code> and <code>diag_pop</code> diagnostic message pragmas.
SPRU514H	C/C++ Language	Section 6.13 , Section 6.13.1 , and Section 6.13.2	Added support for C99 and C++03. The <code>--relaxed_ansi</code> option is now the default and <code>--strict_ansi</code> is the other option; "normal mode" for standards violation strictness is no longer available.
SPRU514H	Run-Time Environment	Section 7.4	Added reference to section on accessing linker symbols in C and C++ in the <i>Assembly Language Tools User's Guide</i> .

Table B-1. Revision History (continued)

Version Added	Chapter	Location	Additions / Modifications / Deletions
SPRU514G	Run-Time Environment	Table 7-6 and Table 7-8	Added intrinsics for TMU instructions and for reading from and writing to memory using 32-bit addresses for data placed higher than the usual 22-bit address range.
SPRU514H	Run-Time Support Functions	Section 8.1.3	RTS source code is no longer provided in a rtssrc.zip file. Instead, it is located in separate files in the lib/src subdirectory of the compiler installation.
SPRU514H	C++ Name Demangler	Section 9.2	Corrected information about name demangler options.
SPRU514H	CLA Compiler	Chapter 10	Non-recursive function calls and more than two function parameters are now supported for CLA code. CLA scratchpad management has been simplified; it is no longer necessary to specify a size for the scratchpad in the linker command file. The compiler now supports both the interrupt attribute and the INTERRUPT pragma for CLA interrupts.

IMPORTANT NOTICE FOR TI DESIGN INFORMATION AND RESOURCES

Texas Instruments Incorporated ("TI") technical, application or other design advice, services or information, including, but not limited to, reference designs and materials relating to evaluation modules, (collectively, "TI Resources") are intended to assist designers who are developing applications that incorporate TI products; by downloading, accessing or using any particular TI Resource in any way, you (individually or, if you are acting on behalf of a company, your company) agree to use it solely for this purpose and subject to the terms of this Notice.

TI's provision of TI Resources does not expand or otherwise alter TI's applicable published warranties or warranty disclaimers for TI products, and no additional obligations or liabilities arise from TI providing such TI Resources. TI reserves the right to make corrections, enhancements, improvements and other changes to its TI Resources.

You understand and agree that you remain responsible for using your independent analysis, evaluation and judgment in designing your applications and that you have full and exclusive responsibility to assure the safety of your applications and compliance of your applications (and of all TI products used in or for your applications) with all applicable regulations, laws and other applicable requirements. You represent that, with respect to your applications, you have all the necessary expertise to create and implement safeguards that (1) anticipate dangerous consequences of failures, (2) monitor failures and their consequences, and (3) lessen the likelihood of failures that might cause harm and take appropriate actions. You agree that prior to using or distributing any applications that include TI products, you will thoroughly test such applications and the functionality of such TI products as used in such applications. TI has not conducted any testing other than that specifically described in the published documentation for a particular TI Resource.

You are authorized to use, copy and modify any individual TI Resource only in connection with the development of applications that include the TI product(s) identified in such TI Resource. NO OTHER LICENSE, EXPRESS OR IMPLIED, BY ESTOPPEL OR OTHERWISE TO ANY OTHER TI INTELLECTUAL PROPERTY RIGHT, AND NO LICENSE TO ANY TECHNOLOGY OR INTELLECTUAL PROPERTY RIGHT OF TI OR ANY THIRD PARTY IS GRANTED HEREIN, including but not limited to any patent right, copyright, mask work right, or other intellectual property right relating to any combination, machine, or process in which TI products or services are used. Information regarding or referencing third-party products or services does not constitute a license to use such products or services, or a warranty or endorsement thereof. Use of TI Resources may require a license from a third party under the patents or other intellectual property of the third party, or a license from TI under the patents or other intellectual property of TI.

TI RESOURCES ARE PROVIDED "AS IS" AND WITH ALL FAULTS. TI DISCLAIMS ALL OTHER WARRANTIES OR REPRESENTATIONS, EXPRESS OR IMPLIED, REGARDING TI RESOURCES OR USE THEREOF, INCLUDING BUT NOT LIMITED TO ACCURACY OR COMPLETENESS, TITLE, ANY EPIDEMIC FAILURE WARRANTY AND ANY IMPLIED WARRANTIES OF MERCHANTABILITY, FITNESS FOR A PARTICULAR PURPOSE, AND NON-INFRINGEMENT OF ANY THIRD PARTY INTELLECTUAL PROPERTY RIGHTS.

TI SHALL NOT BE LIABLE FOR AND SHALL NOT DEFEND OR INDEMNIFY YOU AGAINST ANY CLAIM, INCLUDING BUT NOT LIMITED TO ANY INFRINGEMENT CLAIM THAT RELATES TO OR IS BASED ON ANY COMBINATION OF PRODUCTS EVEN IF DESCRIBED IN TI RESOURCES OR OTHERWISE. IN NO EVENT SHALL TI BE LIABLE FOR ANY ACTUAL, DIRECT, SPECIAL, COLLATERAL, INDIRECT, PUNITIVE, INCIDENTAL, CONSEQUENTIAL OR EXEMPLARY DAMAGES IN CONNECTION WITH OR ARISING OUT OF TI RESOURCES OR USE THEREOF, AND REGARDLESS OF WHETHER TI HAS BEEN ADVISED OF THE POSSIBILITY OF SUCH DAMAGES.

You agree to fully indemnify TI and its representatives against any damages, costs, losses, and/or liabilities arising out of your non-compliance with the terms and provisions of this Notice.

This Notice applies to TI Resources. Additional terms apply to the use and purchase of certain types of materials, TI products and services. These include; without limitation, TI's standard terms for semiconductor products (<http://www.ti.com/sc/docs/stdterms.htm>), [evaluation modules](#), and [samples](http://www.ti.com/sc/docs/sampterm.htm) (<http://www.ti.com/sc/docs/sampterm.htm>).

Mailing Address: Texas Instruments, Post Office Box 655303, Dallas, Texas 75265
Copyright © 2018, Texas Instruments Incorporated