

UCC27282 具有跨导保护和低开关损耗的 3A 120V 半桥驱动器

1 特性

- 可驱动两个采用高侧/低侧配置的 N 沟道 MOSFET
- 5V 典型欠压锁定
- 输入互锁
- 在 DRC 封装中启用/禁用功能
- 16ns 典型传播延迟
- 1.8nF 负载时的上升时间为 12ns，下降时间为 10ns
- 1ns 典型延迟匹配
- 输入引脚上接受的绝对最大负电压 (-5 V)
- HS 引脚上接受的绝对最大负电压 (-14 V)
- $\pm 3A$ 峰值输出电流
- 绝对最大启动电压为 120V
- 禁用时消耗的电流很低 (7 μA)
- 集成式自举二极管
- 额定结温范围为 -40°C 至 140°C

2 应用

- 电信和商用电源
- 电机驱动器和电动工具
- 辅助逆变器
- 半桥和全桥转换器
- 有源箝位正激式转换器
- 高电压同步降压型转换器
- D 类音频放大器

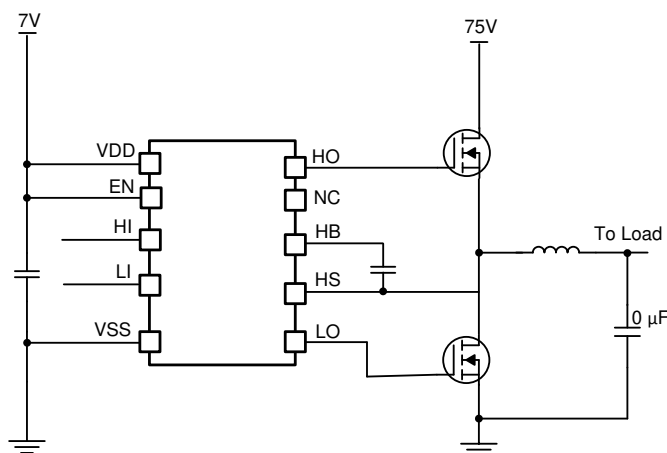

简化版应用示意图

3 说明

UCC27282 是一款功能强大的 N 沟道 MOSFET 驱动器，最大开关节点 (HS) 额定电压为 100V。借助此器件，可在基于半桥或同步降压配置的拓扑中控制两个 N 沟道 MOSFET。由于具有 3A 的峰值灌电流和拉电流以及较低的上拉和下拉电阻，UCC27282 能够在 MOSFET 米勒平台转换期间以极低开关损耗驱动大功率 MOSFET。由于输入与电源电压无关，因此 UCC27282 与模拟控制器和数字控制器均可结合使用。

输入引脚和 HS 引脚能够承受较大的负电压，因此提高了系统稳健性。输入互锁进一步提高了高噪声应用中的稳健性和系统可靠性。启用和禁用功能通过降低驱动器的功耗并响应系统内的故障事件，提供额外的系统灵活性。5V UVLO 允许系统在较低的偏置电压下工作，这在许多高频应用中是必需的，并可在某些工作模式下提高效率。较小的传播延迟和延迟匹配规格可尽可能降低死区时间要求，从而进一步提高效率。

高侧和低侧驱动器级均配有欠压锁定 (UVLO) 功能，因此可在 VDD 电压低于指定阈值时将输出强制为低电平。在许多应用中，集成自举二极管无需使用外部分立式二极管，节省布板空间和降低系统成本。UCC27282 采用小型封装，因此可支持高密度设计。

器件信息⁽¹⁾

器件型号	封装 (大小)
UCC27282	SON10 (3mm x 3mm)
	SOIC8 (6mm x 5mm)
	SON8 (4mm x 4mm)
	SON10 (4mm x 4mm)

(1) 如需了解所有可用封装，请参阅产品说明书末尾的可订购产品附录。



Table of Contents

1 特性	1	7.4 Device Functional Modes.....	16
2 应用	1	8 Application and Implementation	17
3 说明	1	8.1 Application Information.....	17
4 Revision History	2	8.2 Typical Application.....	18
5 Pin Configuration and Functions	3	9 Power Supply Recommendations	26
6 Specifications	4	10 Layout	27
6.1 Absolute Maximum Ratings.....	4	10.1 Layout Guidelines.....	27
6.2 ESD Ratings.....	4	10.2 Layout Example.....	27
6.3 Recommended Operating Conditions.....	4	11 Device and Documentation Support	28
6.4 Thermal Information.....	5	11.1 Device Support.....	28
6.5 Electrical Characteristics.....	5	11.2 接收文档更新通知.....	28
6.6 Switching Characteristics.....	6	11.3 支持资源.....	28
6.7 Timing Diagrams.....	7	11.4 Trademarks.....	28
6.8 Typical Characteristics.....	7	11.5 Electrostatic Discharge Caution.....	28
7 Detailed Description	13	11.6 术语表.....	28
7.1 Overview.....	13	12 Mechanical, Packaging, and Orderable Information	28
7.2 Functional Block Diagram.....	13		
7.3 Feature Description.....	14		

4 Revision History

Changes from Revision A (January 2020) to Revision B (May 2022)	Page
• 在器件信息表中添加了 SON 8 引脚 DRM 和 SON 10 引脚 DPR 封装.....	1
• Added SON 8-Pin DRM and SON 10-pin DPR package images and updated the Pin Functions table.....	3
• Added SON 8-pin DRM and SON 10-pin DPR packages to Thermal Information.....	5
• Updated typical peak pullup/pulldown current from +2.5A/-3.5A to ±3A in Electrical Characteristics.....	5
• Updated I _{HBS} typical leakage to 5.0 μA and test voltage from 110V to 100V in Electrical Characteristics.....	5

Changes from Revision * (November 2018) to Revision A (January 2020)	Page
• 向器件信息表中添加了 SOIC 8 引脚 D 封装。.....	1
• Added SOIC 8-Pin D package image and updated the Pin Functions table.....	3

5 Pin Configuration and Functions



图 5-1. DRC Package 10-Pin VSON With Exposed Thermal Pad Top View



图 5-2. D Package 8-Pin SOIC Top View

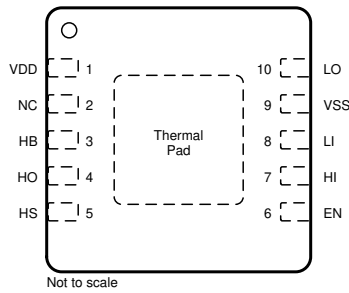

图 5-3. DRM Package 8-Pin SON Top View

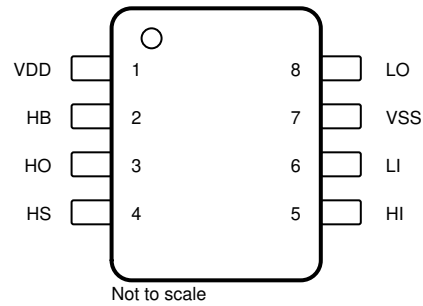

图 5-4. DPR Package 10-Pin SON Top View

表 5-1. Pin Functions

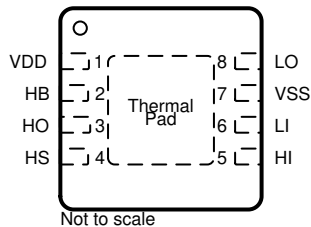
Name	PIN				I/O ⁽¹⁾	DESCRIPTION
	D	DRC	DRM	DPR		
EN	n/a	6	n/a	n/a	I	Enable input. When this pin is pulled high, it will enable the driver. If left floating or pulled low, it will disable the driver. 1 nF filter capacitor is recommended for high-noise systems.
HB	2	3	2	2	P	High-side bootstrap supply. The bootstrap diode is on-chip but the external bootstrap capacitor is required. Connect positive side of the bootstrap capacitor to this pin. Typical recommended value of HB bypass capacitor is 0.1 μ F. This value primarily depends on the gate charge of the high-side MOSFET. When using external boot diode, connect cathode of the diode to this pin.
HI	5	7	5	7	I	High-side input.
HO	3	4	3	3	O	High-side output. Connect to the gate of the high-side power MOSFET or one end of external gate resistor, when used.
HS	4	5	4	4	P	High-side source connection. Connect to source of high-side power MOSFET. Connect negative side of bootstrap capacitor to this pin.
LI	6	8	6	8	I	Low-side input
LO	8	10	8	10	O	Low-side output. Connect to the gate of the low-side power MOSFET or one end of external gate resistor, when used.
NC	n/a	2	n/a	5,6	—	Not connected internally.
VDD	1	1	1	1	P	Positive supply to the low-side gate driver. Decouple this pin to VSS. Typical decoupling capacitor value is 1 μ F. When using an external boot diode, connect the anode to this pin.
VSS	7	9	7	9	G	Negative supply terminal for the device which is generally the system ground.
Thermal pad	n/a	-	-	-	—	Connect to a large thermal mass trace (generally IC ground plane) to improve thermal performance. This can only be electrically connected to VSS.

(1) P = Power, G = Ground, I = Input, O = Output, I/O = Input/Output

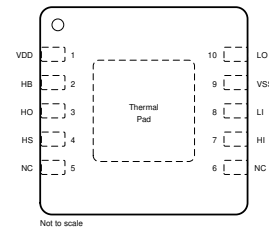
6 Specifications

6.1 Absolute Maximum Ratings

All voltages are with respect to V_{SS} ⁽¹⁾ ⁽²⁾

		MIN	MAX	UNIT	
V_{DD}	Supply voltage	- 0.3	20	V	
V_{EN}, V_{HI}, V_{LI}	Input voltages on EN, HI and LI	- 5	20	V	
V_{LO}	Output voltage on LO	DC	- 0.3	$V_{DD} + 0.3$	V
		Pulses < 100 ns ⁽³⁾	- 2	$V_{DD} + 0.3$	
V_{HO}	Output voltage on HO	DC	$V_{HS} - 0.3$	$V_{HB} + 0.3$	V
		Pulses < 100 ns ⁽³⁾	$V_{HS} - 2$	$V_{HB} + 0.3$	
V_{HS}	Voltage on HS	DC	- 10	100	V
		Pulses < 100 ns ⁽³⁾	- 14	100	
V_{HB}	Voltage on HB	- 0.3	120	V	
V_{HB-HS}	Voltage on HB with respect to HS	- 0.3	20	V	
T_J	Operating junction temperature	- 40	150	°C	
	Lead temperature (soldering, 10 sec.)		300	°C	
T_{stg}	Storage temperature	- 65	150	°C	

- Operation outside the Absolute Maximum Ratings may cause permanent device damage. Absolute Maximum Ratings do not imply functional operation of the device at these or any other conditions beyond those listed under Recommended Operating Conditions. If outside the Recommended Operating Conditions but within the Absolute Maximum Ratings, the device may not be fully functional, and this may affect device reliability, functionality, performance, and shorten the device lifetime.
- All voltages are with respect to V_{SS} . Currents are positive into, negative out of the specified terminal.
- Values are verified by characterization only.

6.2 ESD Ratings

		VALUE	UNIT	
$V_{(ESD)}$	Electrostatic discharge	Human-body model (HBM), per ANSI/ESDA/JEDEC JS-001 ⁽¹⁾ ⁽³⁾	±2000	V
		Charged-device model (CDM), per JEDEC specification JESD22-C101 ⁽²⁾	±1500	

- JEDEC document JEP155 states that 500-V HBM allows safe manufacturing with a standard ESD control process.
- JEDEC document JEP157 states that 250-V CDM allows safe manufacturing with a standard ESD control process.
- Pins HS, HB and HO are rated at 500V HBM

6.3 Recommended Operating Conditions

Over operating free-air temperature range (unless otherwise noted)

		MIN	NOM	MAX	UNIT
V_{DD}	Supply voltage	5.5	12	16	V
V_{EN}, V_{HI}, V_{LI}	Input Voltage	0		$V_{DD} + 0.3$	
V_{LO}	Low side output voltage	0		$V_{DD} + 0.3$	
V_{HO}	High side output voltage	V_{HS}		$V_{HB} + 0.3$	
V_{HS}	Voltage on HS ⁽¹⁾	- 8		100	V
	Voltage on HS (Pulses < 100 ns) ⁽¹⁾	- 12		100	
V_{HB}	Voltage on HB	$V_{HS} + 5.5$		$V_{HS} + 16$	V
V_{sr}	Voltage slew rate on HS			50	V/ns
T_J	Operating junction temperature	- 40		140	°C

- $V_{HB-HS} < 16V$ (Voltage on HB with respect to HS must be less than 16V)

6.4 Thermal Information

THERMAL METRIC ⁽¹⁾	UCC27282				UNIT
	D	DRC	DRM	DPR	
	8 PINS	10 PINS	8 PINS	10 PINS	
$R_{\theta JA}$ Junction-to-ambient thermal resistance	118.3	47.3	TBD	TBD	°C/W
$R_{\theta JC(top)}$ Junction-to-case (top) thermal resistance	53.6	50.3	TBD	TBD	°C/W
$R_{\theta JB}$ Junction-to-board thermal resistance	63.1	21.3	TBD	TBD	°C/W
ψ_{JT} Junction-to-top characterization parameter	10.7	1.0	TBD	TBD	°C/W
ψ_{JB} Junction-to-board characterization parameter	62.1	21.2	TBD	TBD	°C/W
$R_{\theta JC(bot)}$ Junction-to-case (bottom) thermal resistance	n/a	4.4	TBD	TBD	°C/W

(1) For more information about traditional and new thermal metrics, see the Semiconductor and IC Package Thermal Metrics application report, SPRA953.

6.5 Electrical Characteristics

$V_{DD} = V_{HB} = V_{EN} = 12\text{ V}$, $V_{HS} = V_{SS} = 0\text{ V}$, No load on LO or HO, $T_J = -40^\circ\text{C}$ to $+140^\circ\text{C}$, (unless otherwise noted)

PARAMETER	TEST CONDITIONS	MIN	TYP	MAX	UNIT
SUPPLY CURRENTS					
I_{DD} VDD quiescent current	$V_{LI} = V_{HI} = 0$		0.3	0.4	mA
I_{DDO} VDD operating current	$f = 500\text{ kHz}$, $C_{LOAD} = 0$		2.2	4.5	mA
I_{HB} HB quiescent current	$V_{LI} = V_{HI} = 0\text{ V}$		0.2	0.4	mA
I_{HBO} HB operating current	$f = 500\text{ kHz}$, $C_{LOAD} = 0$		2.5	4	mA
I_{HBS} HB to VSS quiescent current	$V_{HS} = V_{HB} = 100\text{ V}$		5.0	50	$\mu\text{ A}$
I_{HBSO} HB to VSS operating current ⁽¹⁾	$f = 500\text{ kHz}$, $C_{LOAD} = 0$		0.1		mA
I_{DD_DIS} I_{DD} when driver is disabled	$V_{EN} = 0$		7.0		$\mu\text{ A}$
INPUT					
V_{HIT} Input rising threshold		1.9	2.1	2.4	V
V_{LIT} Input falling threshold		0.9	1.1	1.3	V
V_{IHYS} Input voltage Hysteresis			1.0		V
R_{IN} Input pulldown resistance		100	250	350	k Ω
ENABLE					
V_{EN} Voltage threshold on EN pin to enable the driver			1.54	2.0	V
V_{DIS} Voltage threshold on EN pin to disable the driver		0.7	1.21		V
V_{ENHYS} Enable pin Hysteresis			0.3		V
R_{EN} EN pin internal pull-down resistor			250		k Ω
T_{EN} Time to enable the driver once the EN pin is pulled high	$V_{EN} = 2\text{ V}$		18		$\mu\text{ s}$
T_{DIS} Time to disable the driver once the EN pin is pulled low	$V_{EN} = 0\text{ V}$		1.5		$\mu\text{ s}$
UNDERVOLTAGE LOCKOUT PROTECTION (UVLO)					
V_{DDR} VDD rising threshold		4.7	5.0	5.4	V
V_{DDF} VDD falling threshold		4.2	4.5	4.9	V
V_{DDHYS} VDD threshold hysteresis			0.5		V
V_{HBR} HB rising threshold with respect to HS pin		3.3	3.7	4.4	V
V_{HBF} HB falling threshold with respect to HS pin		3.0	3.3	4.1	V
V_{HBHYS} HB threshold hysteresis			0.3		V

6.5 Electrical Characteristics (continued)

$V_{DD} = V_{HB} = V_{EN} = 12\text{ V}$, $V_{HS} = V_{SS} = 0\text{ V}$, No load on LO or HO, $T_J = -40^\circ\text{C}$ to $+140^\circ\text{C}$, (unless otherwise noted)

PARAMETER		TEST CONDITIONS	MIN	TYP	MAX	UNIT
BOOTSTRAP DIODE						
V_F	Low-current forward voltage	$I_{V_{DD-HB}} = 100\ \mu\text{A}$	0.55	0.85		V
V_{FI}	High-current forward voltage	$I_{V_{DD-HB}} = 80\text{ mA}$	0.88	1.0		V
R_D	Dynamic resistance, $\Delta V_F / \Delta I$	$I_{V_{DD-HB}} = 100\text{ mA}$ and 80 mA	1.5	2.5		Ω
LO GATE DRIVER						
V_{LOL}	Low level output voltage	$I_{LO} = 100\text{ mA}$	0.085	0.4		V
V_{LOH}	High level output voltage	$I_{LO} = -100\text{ mA}$, $V_{LOH} = V_{DD} - V_{LO}$	0.13	0.42		V
	Peak pullup current ⁽¹⁾	$V_{LO} = 0\text{ V}$	3.0			A
	Peak pulldown current ⁽¹⁾	$V_{LO} = 12\text{ V}$	3.0			A
HO GATE DRIVER						
V_{HOL}	Low level output voltage	$I_{HO} = 100\text{ mA}$	0.1	0.4		V
V_{HOH}	High level output voltage	$I_{HO} = -100\text{ mA}$, $V_{HOH} = V_{HB} - V_{HO}$	0.13	0.42		V
	Peak pullup current ⁽¹⁾	$V_{HO} = 0\text{ V}$	3.0			A
	Peak pulldown current ⁽¹⁾	$V_{HO} = 12\text{ V}$	3.0			A

(1) Parameter not tested in production

6.6 Switching Characteristics

$V_{DD} = V_{HB} = 12\text{ V}$, $V_{HS} = V_{SS} = 0\text{ V}$, No load on LO or HO, $T_J = -40^\circ\text{C}$ to $+140^\circ\text{C}$, (unless otherwise noted)

PARAMETER		TEST CONDITIONS	MIN	TYP	MAX	UNIT
PROPAGATION DELAYS						
t_{DLFF}	V_{LI} falling to V_{LO} falling	See § 6.7		16	30	ns
t_{DHFF}	V_{HI} falling to V_{HO} falling	See § 6.7		16	30	ns
t_{DLRR}	V_{LI} rising to V_{LO} rising	See § 6.7		16	30	ns
t_{DHRR}	V_{HI} rising to V_{HO} rising	See § 6.7		16	30	ns
DELAY MATCHING						
t_{MON}	From LO being ON to HO being OFF	See § 6.7		1	7	ns
t_{MOFF}	From LO being OFF to HO being ON	See § 6.7		1	7	ns
OUTPUT RISE AND FALL TIME						
t_R	LO, HO rise time	$C_{LOAD} = 1800\text{ pF}$, 10% to 90%		12		ns
t_F	LO, HO fall time	$C_{LOAD} = 1800\text{ pF}$, 90% to 10%		10		ns
t_R	LO, HO (3 V to 9 V) rise time	$C_{LOAD} = 0.1\ \mu\text{F}$, 30% to 70%		0.33	0.6	μs
t_F	LO, HO (3 V to 9 V) fall time	$C_{LOAD} = 0.1\ \mu\text{F}$, 70% to 30%		0.23	0.6	μs
MISCELLANEOUS						
$T_{PW,min}$	Minimum input pulse width that changes the output			20		ns
	Bootstrap diode turnoff time ⁽¹⁾	$I_F = 20\text{ mA}$, $I_{REV} = 0.5\text{ A}$		50		ns

(1) Parameter not tested in production

6.7 Timing Diagrams

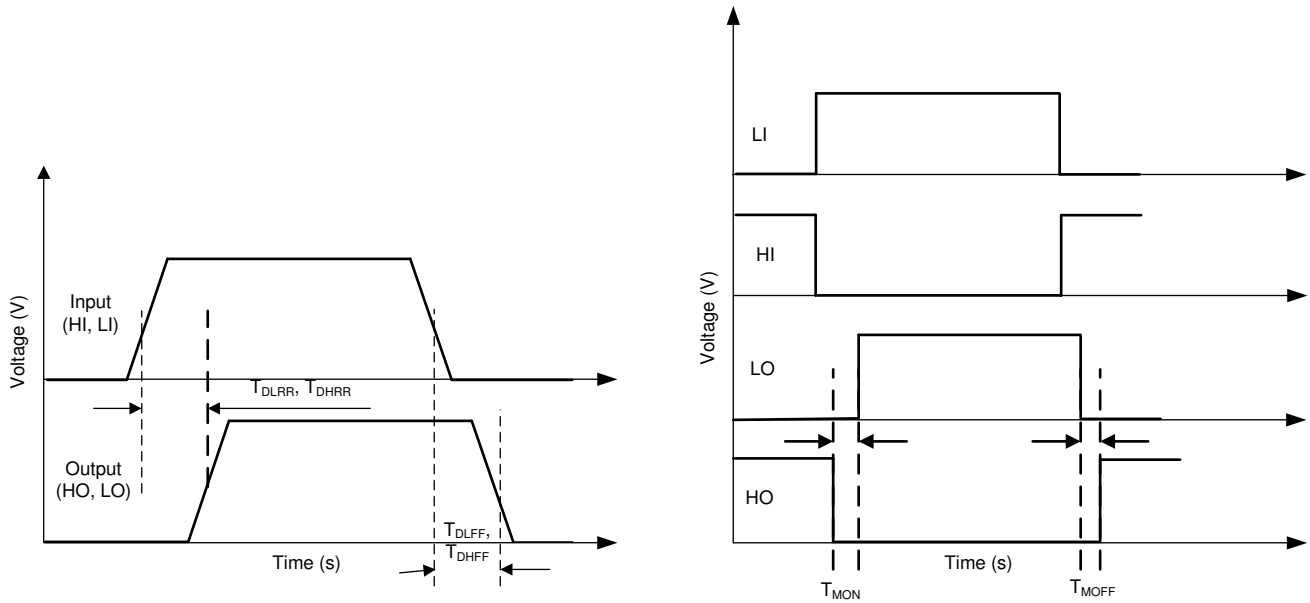

6.8 Typical Characteristics

Unless otherwise specified $V_{VDD}=V_{HB} = 12\text{ V}$, $V_{HS}=V_{VSS} = 0\text{ V}$, No load on outputs



图 6-1. VDD Quiescent Current



图 6-2. HB Quiescent Current

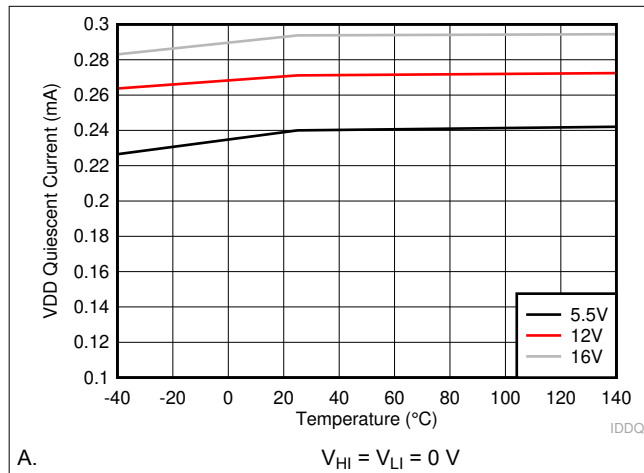

A. $C_L = 0\text{ F}$ $V_{DD} = V_{HB} = 12\text{ V}$

图 6-3. VDD Operating Current

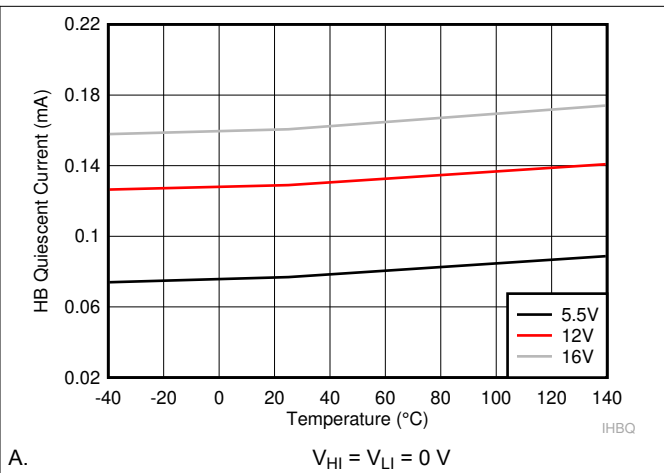
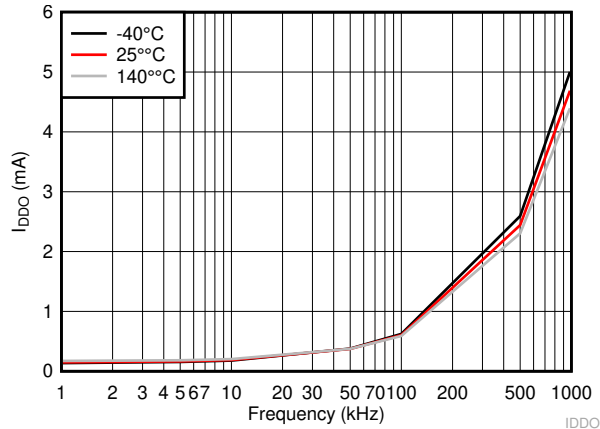
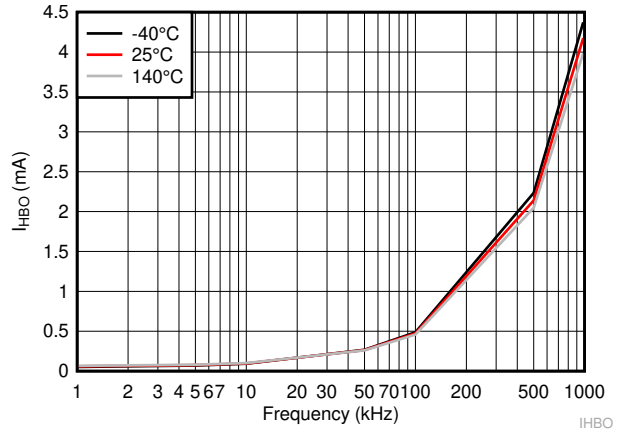

A. $C_L = 0\text{ F}$ $V_{DD} = V_{HB} = 12\text{ V}$

图 6-4. HB Operating Current

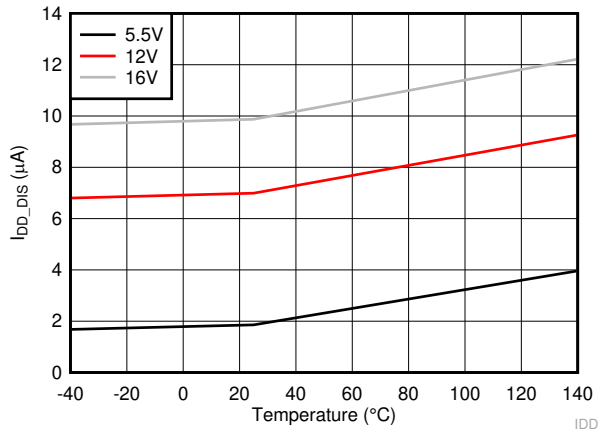

A. $C_L = 0\text{ F}$ $V_{EN} = 0\text{ V}$

图 6-5. VDD Current When Disabled

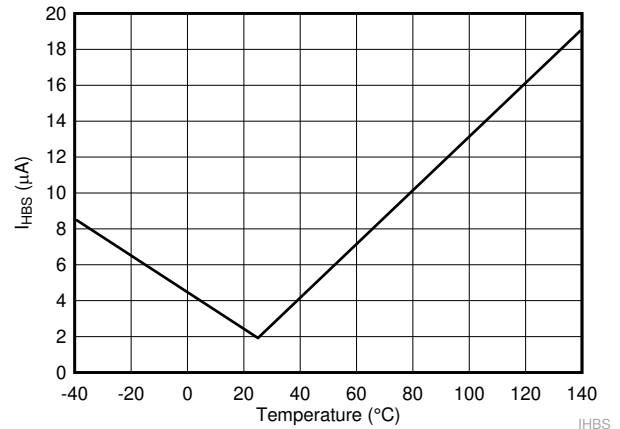

A. $V_{HB} = V_{HS} = 100\text{ V}$

图 6-6. HB to VSS Quiescent Current



图 6-7. Input Rising Threshold



图 6-8. Input Falling Threshold

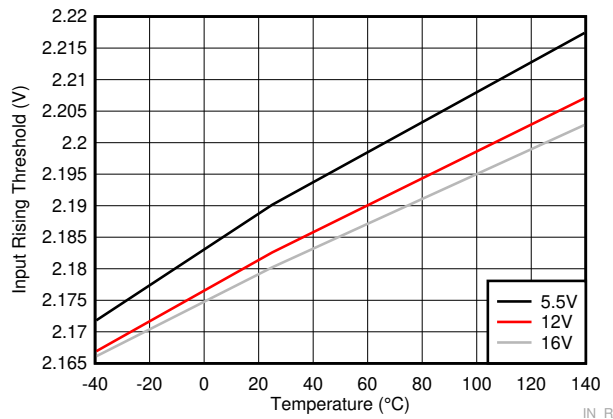

图 6-9. Input Pull-down Resistor

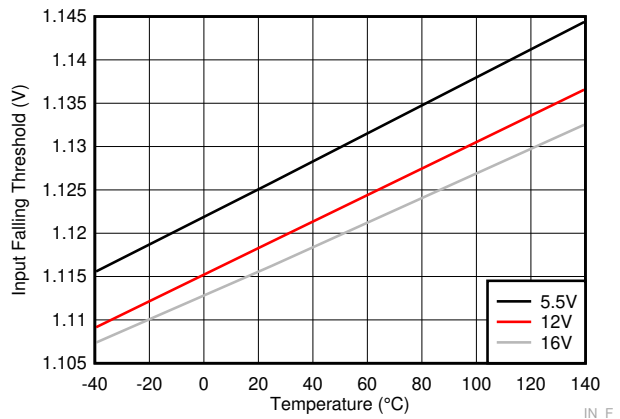

图 6-10. Enable Threshold

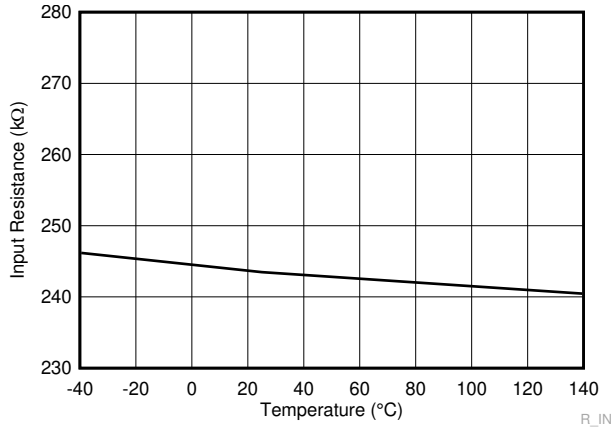

图 6-11. Disable Threshold

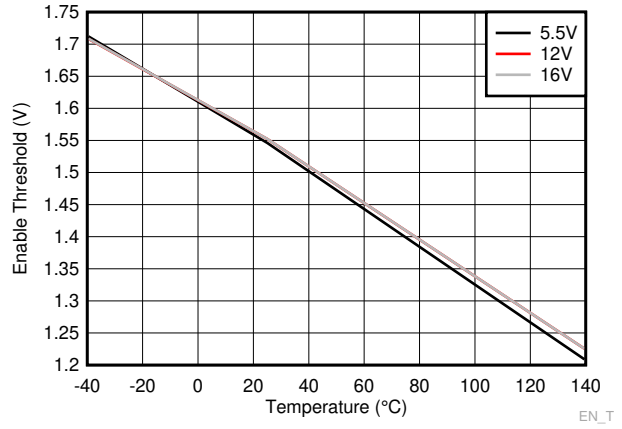

图 6-12. Enable Delay

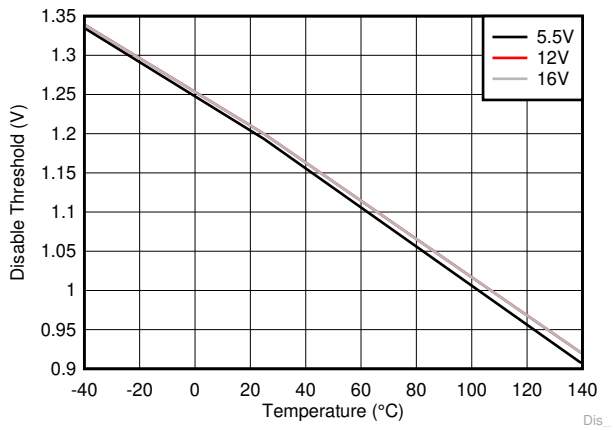

图 6-13. Disable Delay

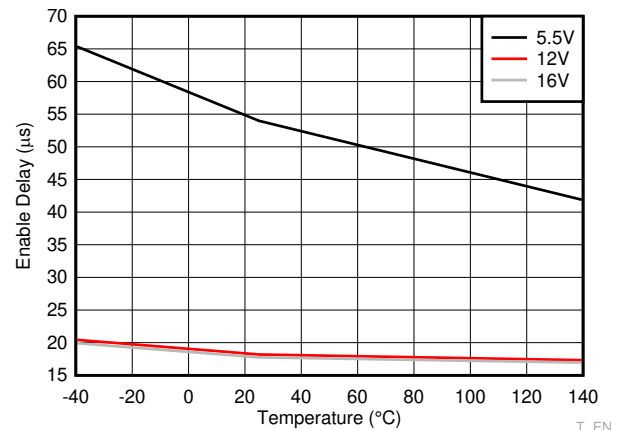

图 6-14. VDD UVLO Threshold

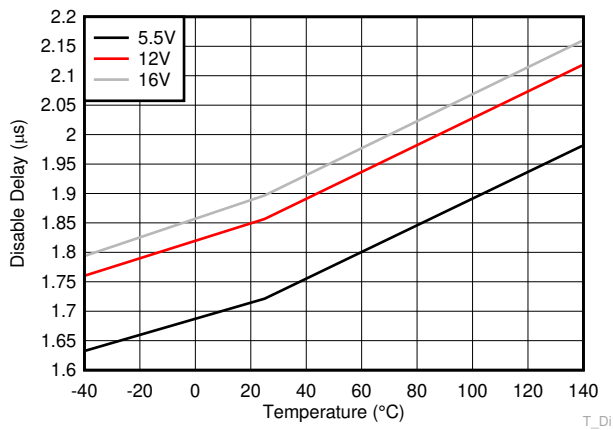

图 6-15. HB UVLO Threshold

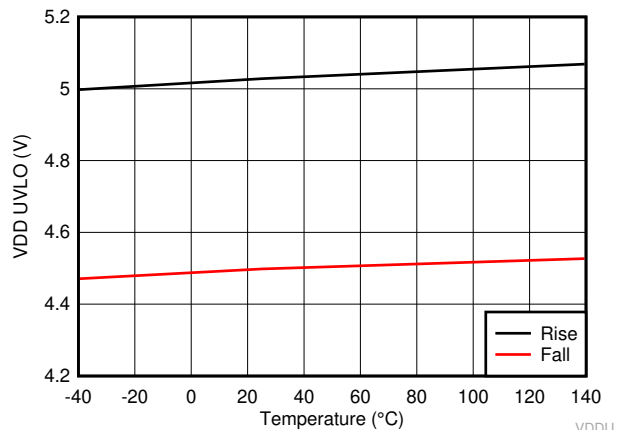

图 6-16. Boot Diode Forward Voltage Drop

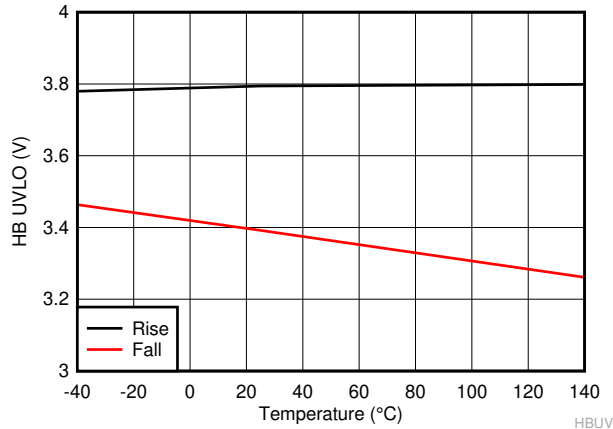

图 6-17. Boot Diode Dynamic Resistance

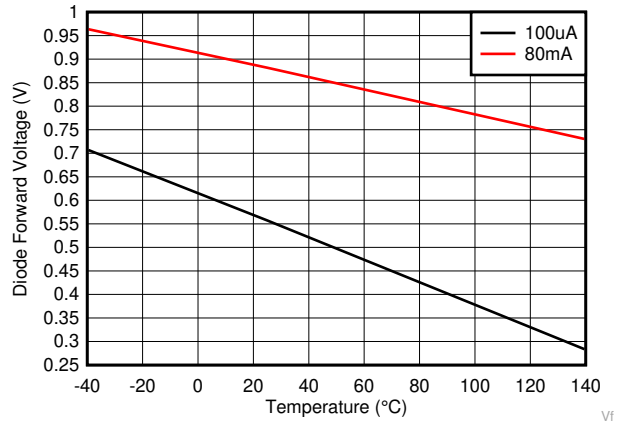

$I_O=100\text{mA}$

图 6-18. LO Low Output Voltage (V_{LOL})

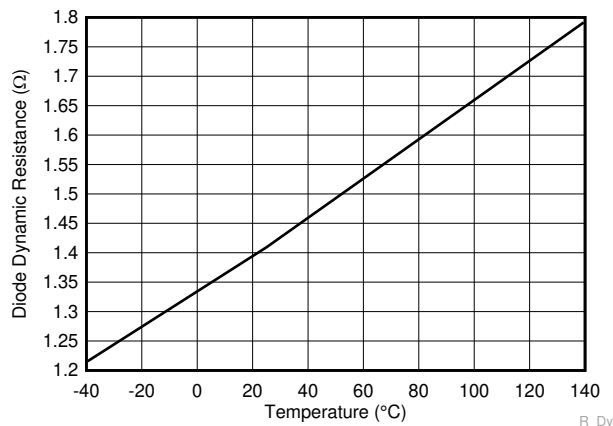
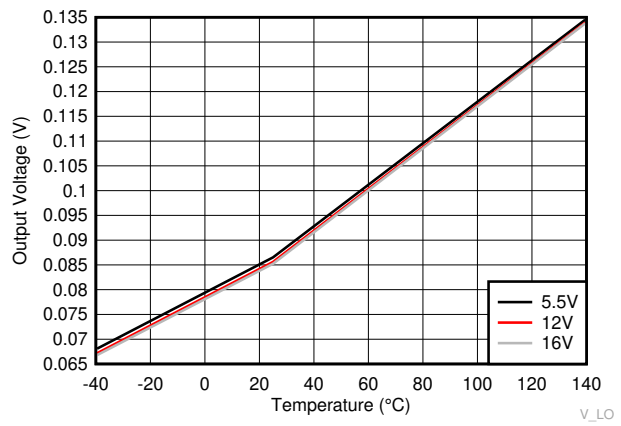
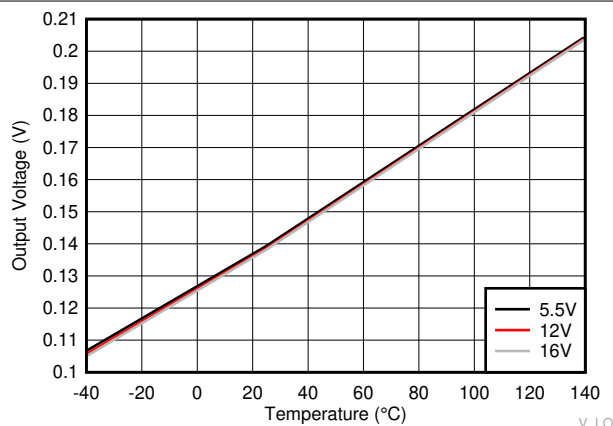

$I_O=-100\text{mA}$

图 6-19. LO High Output Voltage (V_{LOH})

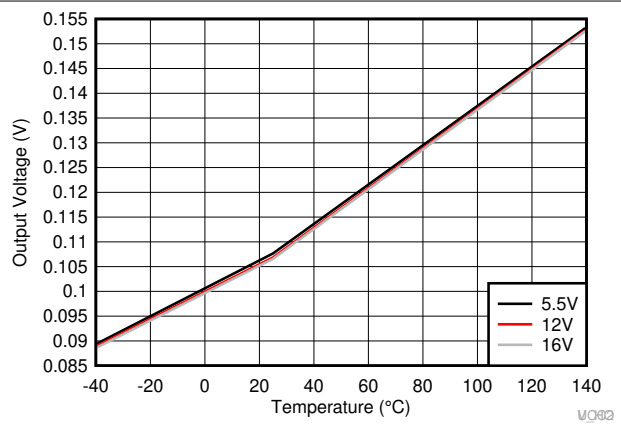

$I_O=100\text{mA}$

图 6-20. HO Low Output Voltage (V_{HOL})



图 6-21. HO High Output Voltage (V_{HOH})



图 6-22. LO Rise Time

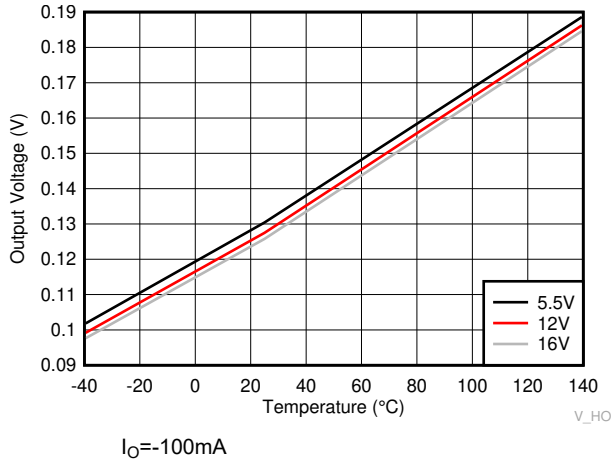

图 6-23. LO Fall Time

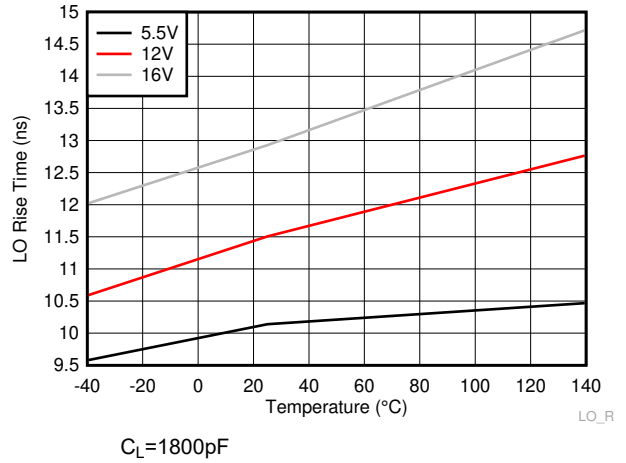

图 6-24. HO Rise Time

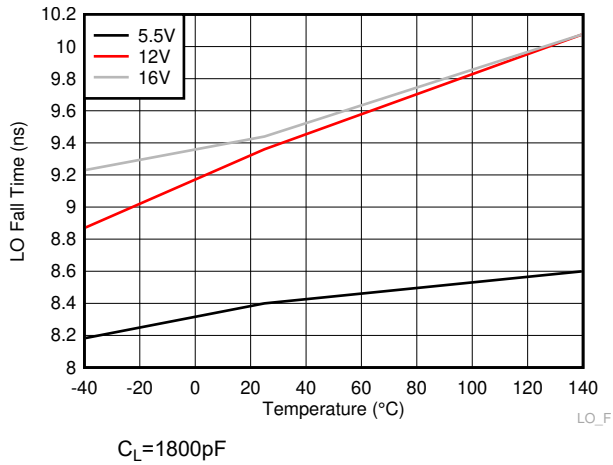

图 6-25. HO Fall Time

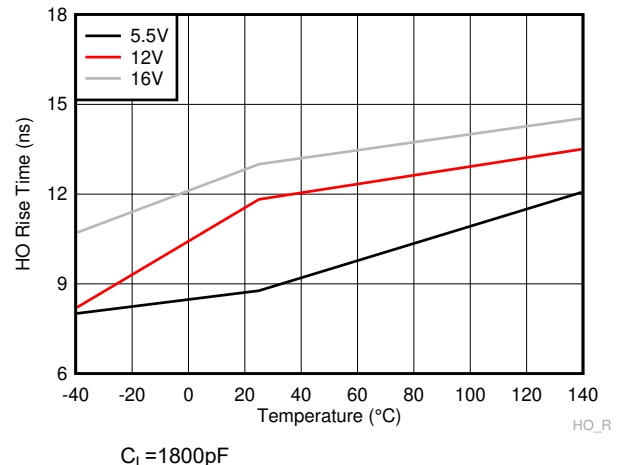

图 6-26. LO Rise & Fall Time

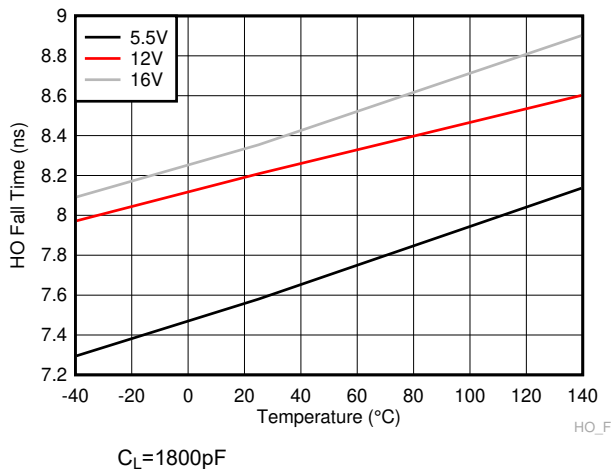

$C_L=100nF$

图 6-27. HO Rise & Fall Time

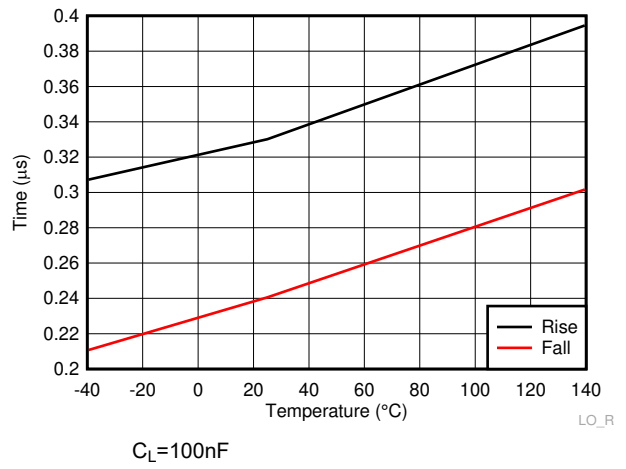
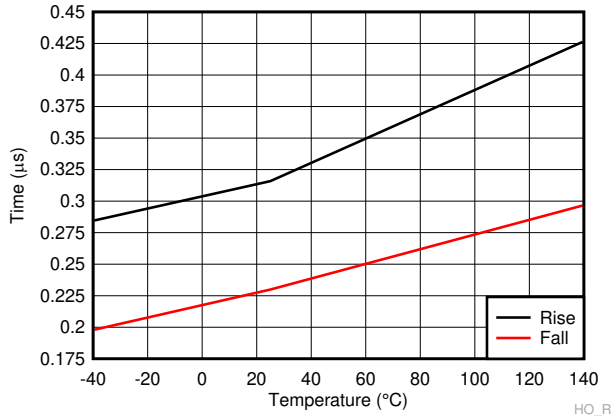
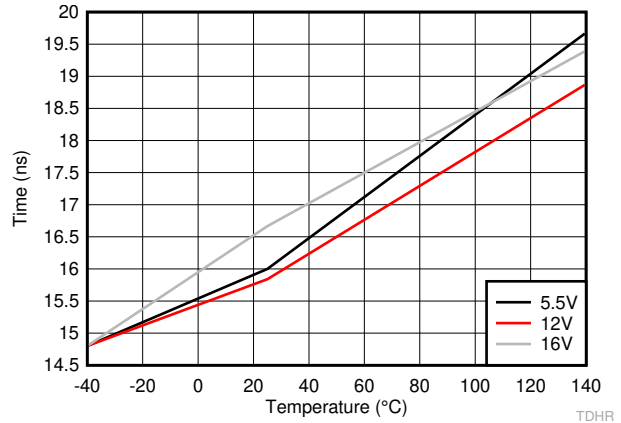

$C_L=No\ Load$

图 6-28. HO Rising Propagation Delay (TDHR)

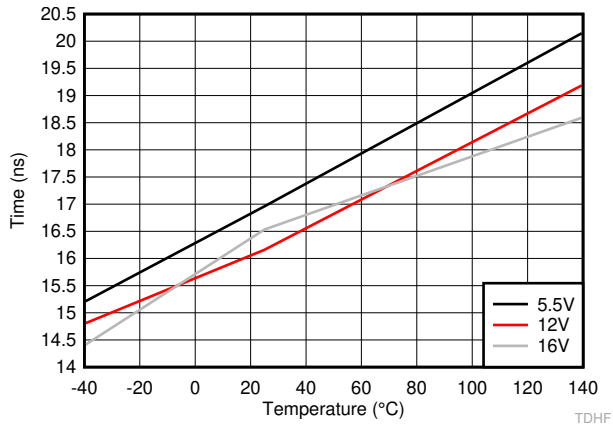

$C_L=No\ Load$

图 6-29. HO Falling Propagation Delay (TDHFF)

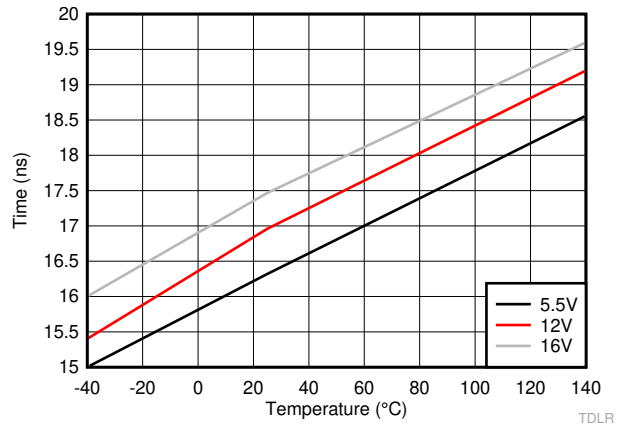

$C_L=No\ Load$

图 6-30. LO Rising Propagation Delay (TDLRR)

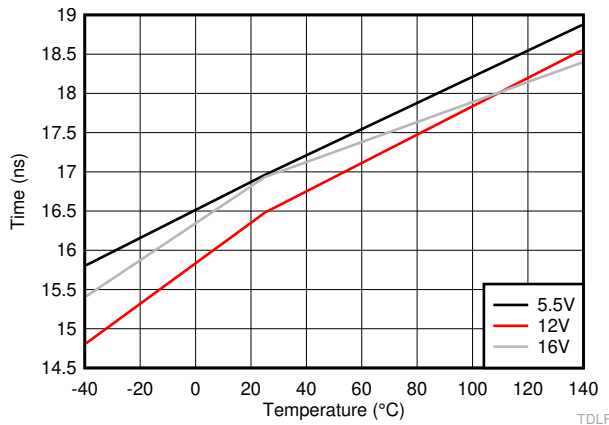

$C_L=No\ Load$

图 6-31. LO Falling Propagation Delay (TDLFF)

7 Detailed Description

7.1 Overview

The UCC27282 is a high-voltage gate driver designed to drive both the high-side and the low-side N-channel FETs in a synchronous buck or a half-bridge configurations. The two outputs are independently controlled with two TTL-compatible input signals. The device can also work with CMOS type control signals at its inputs as long as signals meet turn-on and turn-off threshold specifications of the UCC27282. The floating high-side driver is capable of working with HS voltage up to 100 V with respect to VSS. A 100 V bootstrap diode is integrated in the UCC27282 device to charge high-side gate drive bootstrap capacitor. A robust level shifter operates at high speed while consuming low power and provides clean level transitions from the control logic to the high-side gate driver. Undervoltage lockout (UVLO) is provided on both the low-side and the high-side power rails. EN pin is provided (in DRC packaged parts) to enable or disable the driver. The driver also has input interlock functionality, which shuts off both the outputs when the two inputs overlap.

7.2 Functional Block Diagram

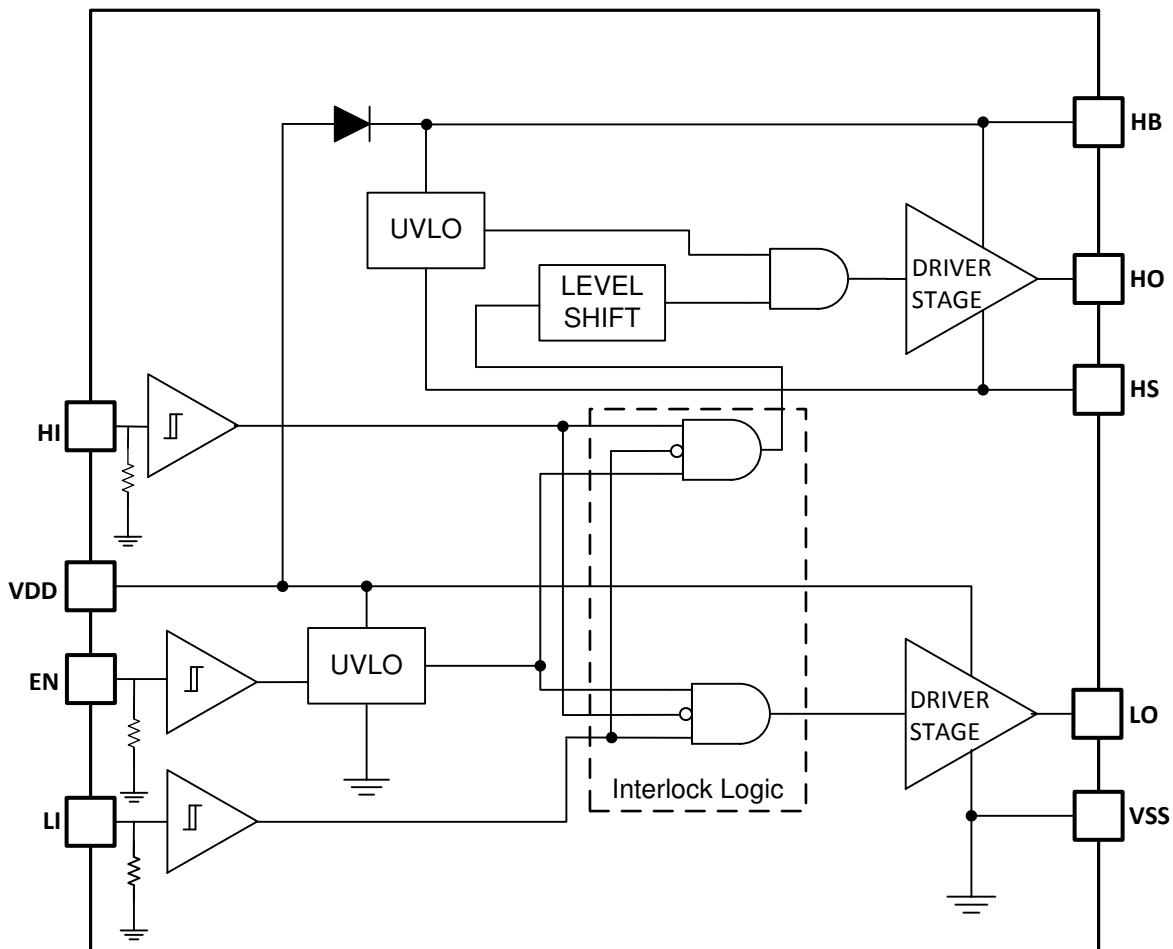

Copyright © 2018, Texas Instruments Incorporated

7.3 Feature Description

7.3.1 Enable

The device in DRC package has an enable (EN) pin. The outputs will be active only if the EN pin voltage is above the threshold voltage. Outputs will be held low if EN pin is left floating or pulled-down to ground. An internal 250 kΩ resistor connects EN pin to VSS pin. Thus, leaving the EN pin floating disables the device. Externally pulling EN pin to ground shall also disable the device. If the EN pin is not used, then it is recommended to connect it to VDD pin. If a pull-up resistor needs to be used then a strong pull-up resistor is recommended. For 12V supply voltage, a 10kΩ pull-up is suggested. In noise prone application, a small filter capacitor, 1nF, should be connected from the EN pin to VSS pin as close to the device as possible. An analog or a digital controller output pin could be connected to EN pin to enable or disable the device. Built-in hysteresis helps prevent any nuisance tripping or chattering of the outputs.

7.3.2 Start-up and UVLO

Both the high-side and the low-side driver stages include UVLO protection circuitry which monitors the supply voltage (V_{DD}) and the bootstrap capacitor voltage (V_{HB-HS}). The UVLO circuit inhibits each output until sufficient supply voltage is available to turn on the external MOSFETs. The built-in UVLO hysteresis prevents chattering during supply voltage variations. When the supply voltage is applied to the VDD pin of the device, both the outputs are held low until VDD exceeds the UVLO threshold, typically 5 V. Any UVLO condition on the bootstrap capacitor (V_{HB-HS}) disables only the high-side output (HO).

表 7-1. VDD UVLO Logic Operation

Condition ($V_{HB-HS} > V_{HBR}$ and $V_{EN} > \text{Enable Threshold}$)	HI	LI	HO	LO
$V_{DD}-V_{SS} < V_{DDR}$ during device start-up	H	L	L	L
	L	H	L	L
	H	H	L	L
	L	L	L	L
$V_{DD}-V_{SS} < V_{DDR} - V_{DDH}$ after device start-up	H	L	L	L
	L	H	L	L
	H	H	L	L
	L	L	L	L

表 7-2. HB UVLO Logic Operation

Condition ($V_{DD} > V_{DDR}$ and $V_{EN} > \text{Enable Threshold}$)	HI	LI	HO	LO
$V_{HB-HS} < V_{HBR}$ during device start-up	H	L	L	L
	L	H	L	H
	H	H	L	L
	L	L	L	L
$V_{HB-HS} < V_{HBR} - V_{HBH}$ after device start-up	H	L	L	L
	L	H	L	H
	H	H	L	L
	L	L	L	L

7.3.3 Input Stages and Interlock

The two inputs operate independently, with an exception that both outputs will be pulled low when both inputs are high or overlap. The independence allows for full control of two outputs compared to the gate drivers that have a single input. The device has input interlock or cross-conduction protection. Whenever both the inputs are high, the internal logic turns both the outputs off. Once the device is in shoot-through mode, when one of the inputs goes low, the outputs follow the input logic. There is no other fixed time de-glitch filter implemented in the device and therefore propagation delay and delay matching are not sacrificed. In other words, there is no built-in dead-time due to the interlock feature. Any noise on the input that could cause the output to shoot-through will be filtered by this feature and the system stays protected. Because the inputs are independent of supply voltage,

they can be connected to outputs of either digital controller or analog controller. Inputs can accept wide slew rate signals and input can withstand negative voltage to increase the robustness. Small filter at the inputs of the driver further improves system robustness in noise prone applications. The inputs have internal pull down resistors with typical value of 250 k Ω . Thus, when the inputs are floating, the outputs are held low.



图 7-1. Interlock or Input Shoot-through Protection

7.3.4 Level Shifter

The level shift circuit is the interface from the high-side input, which is a VSS referenced signal, to the high-side driver stage which is referenced to the switch node (HS pin). The level shift allows control of the HO output which is referenced to the HS pin. The delay introduced by the level shifter is kept as low as possible and therefore the device provides excellent propagation delay characteristic and delay matching with the low-side driver output. Low delay matching allows power stages to operate with less dead time. The reduction in dead-time is very important in applications where high efficiency is required.

7.3.5 Output Stage

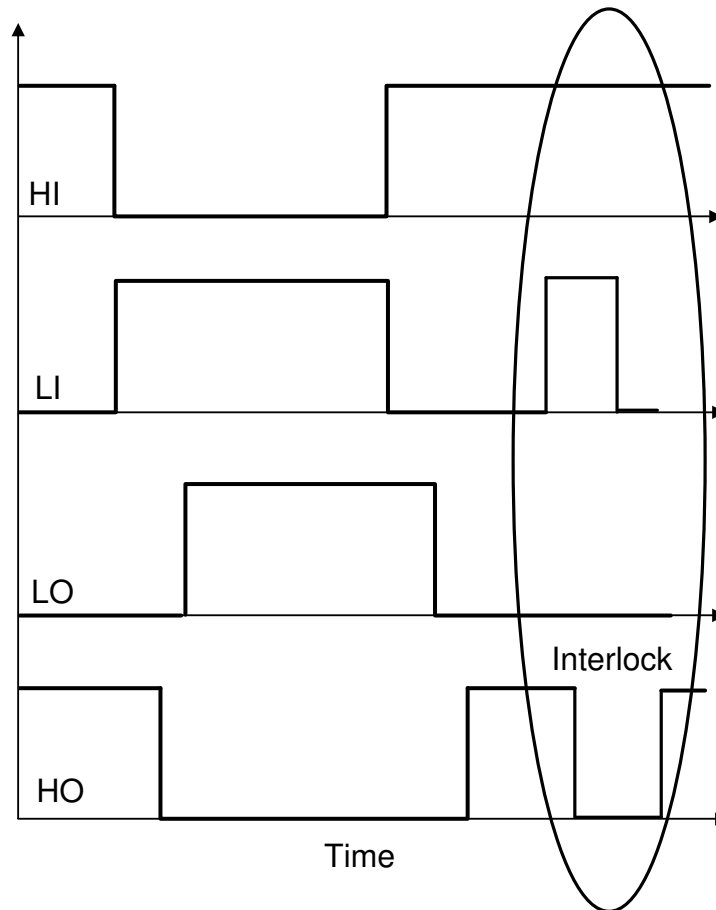
The output stages are the interface from level shifter output to the power MOSFETs in the power train. High slew rate, low resistance, and high peak current capability of both outputs allow for efficient switching of the power MOSFETs. The low-side output stage is referenced to VSS and the high-side is referenced to HS. The device output stages are robust to handle harsh environment, such as - 2 V transient for 100 ns. The device can also sustain positive transients on the outputs. The device output stages feature a pull-up structure which delivers the highest peak source current when it is most needed, during the Miller plateau region of the power switch turn on transition. The output pull-up and pull-down structure of the device is totem pole NMOS-PMOS structure.

7.3.6 Negative Voltage Transients

In most applications, the body diode of the external low-side power MOSFET clamps the HS node to ground. In some situations, board capacitances and inductances can cause the HS node to transiently swing several volts below ground, before the body diode of the external low-side MOSFET clamps this swing. When used in conjunction with the UCC27282, the HS node can swing below ground as long as specifications are not violated and conditions mentioned in this section are followed.

HS must always be at a lower potential than HO. Pulling HO more negative than specified conditions can activate parasitic transistors which may result in excessive current flow from the HB supply. This may result in damage to the device. The same relationship is true with LO and VSS. If necessary, a Schottky diode can be placed externally between HO and HS or LO and VSS to protect the device from this type of transient. The diode must be placed as close to the device pins as possible in order to be effective.

Ensure that the HB to HS operating voltage is 16 V or less. Hence, if the HS pin transient voltage is -5 V, then VDD (and thus HB) is ideally limited to 11 V to keep the HB to HS voltage below 16 V. Generally when HS swings negative, HB follows HS instantaneously and therefore the HB to HS voltage does not significantly overshoot.

Low ESR bypass capacitors from HB to HS and from VDD to VSS are essential for proper operation of the gate driver device. The capacitor should be located at the leads of the device to minimize series inductance. The peak currents from LO and HO can be quite large. Any series inductances with the bypass capacitor causes voltage ringing at the leads of the device which must be avoided for reliable operation.

Based on application board design and other operating parameters, along with HS pin, other pins such as inputs, HI and LI, might also transiently swing below ground. To accommodate such operating conditions UCC27282 input pins are capable of handling absolute maximum of -5 V. As explained earlier, based on the layout and other design constraints, some times the outputs, HO and LO, might also see transient voltages for short durations. Therefore, UCC27282 gate drivers can also handle -2 V 100 ns transients on output pins, HO and LO.

7.4 Device Functional Modes

When the device is enabled, the device operates in normal mode and UVLO mode. See [节 7.3.2](#) for more information on UVLO operation mode. In normal mode when the V_{DD} and V_{HB-HS} are above UVLO threshold, the output stage is dependent on the states of the EN, HI and LI pins. The output HO and LO will be low if input state is floating.

表 7-3. Input/Output Logic in Normal Mode of Operation

EN	HI	LI	HO ⁽¹⁾	LO ⁽²⁾
L	H	H	L	L
	L	H	L	L
	H	L	L	L
	L	L	L	L
H	H	H	L	L
	L	H	L	H
	H	L	H	L
	L	L	L	L
H	Floating	L	L	L
	Floating	H	L	H
	L	Floating	L	L
	H	Floating	H	L
Floating	Floating	Floating	L	L

(1) HO is measured with respect to HS

(2) LO is measured with respect to VSS

8 Application and Implementation

备注

以下应用部分中的信息不属于 TI 器件规格的范围，TI 不担保其准确性和完整性。TI 的客户应负责确定器件是否适用于其应用。客户应验证并测试其设计，以确保系统功能。

8.1 Application Information

Most electronic devices and applications are becoming more and more power hungry. These applications are also reducing in overall size. One way to achieve both high power and low size is to improve the efficiency and distribute the power loss optimally. Most of these applications employ power MOSFETs and they are being switched at higher and higher frequencies. To operate power MOSFETs at high switching frequencies and to reduce associated switching losses, a powerful gate driver is employed between the PWM output of controller and the gates of the power semiconductor devices, such as power MOSFETs, IGBTs, SiC FETs, and GaN FETs. Many of these applications require proper UVLO protection so that power semiconductor devices are turned ON and OFF optimally. Also, gate drivers are indispensable when it is impossible for the PWM controller to directly drive the gates of the switching devices. With the advent of digital power, this situation is often encountered because the PWM signal from the digital controller is often a 3.3-V logic signal which cannot effectively turn on a power switch. A level-shift circuit is needed to boost the 3.3-V signal to the gate-drive voltage (such as 12 V or 5 V) in order to fully turn-on the power device, minimize conduction losses, and minimize the switching losses. Traditional buffer drive circuits based on NPN/PNP bipolar transistors in totem-pole arrangement prove inadequate with digital power because they lack level-shifting capability and under voltage lockout protection. Gate drivers effectively combine both the level-shifting and buffer-drive functions. Gate drivers also solve other problems such as minimizing the effect of high-frequency switching noise (by placing the high-current driver device physically close to the power switch), driving gate-drive transformers and controlling floating power device gates. This helps reduce power dissipation and thermal stress in controllers by moving gate charge power losses from the controller IC to the gate driver.

UCC27282 gate drivers offer high voltage (100 V), small delays (16 ns), and good driving capability (± 3 -A) in a single device. The floating high-side driver is capable of operating with switch node voltages up to 100 V. This allows for N-channel MOSFETs control in half-bridge, full-bridge, synchronous buck, synchronous boost, and active clamp topologies. UCC27282 gate driver IC also has built-in bootstrap diode to help power supply designers optimize PWB area and to help reduce bill of material cost in most applications. The driver has an enable/disable functionality to be used in applications where driver needs to be enabled or disabled based on fault condition in other parts of the circuit. Interlock functionality of the device is very useful in applications where overall reliability of the system is of utmost criteria and redundant protection is desired. Each channel is controlled by its respective input pins (HI and LI), allowing flexibility to control ON and OFF state of the output. Both the outputs are forced OFF when the two inputs overlap.

Switching power devices such as MOSFETs have two main loss components; switching losses and conduction losses. Conduction loss is dominated by current through the device and ON resistance of the device. Switching losses are dominated by gate charge of the switching device, gate voltage of the switching device, and switching frequency. Applications where operating switching frequency is very high, the switching losses start to significantly impact overall system efficiency. In such applications, to reduce the switching losses it becomes essential to reduce the gate voltage. The gate voltage is determined by the supply voltage the gate driver ICs, therefore, the gate driver IC needs to operate at lower supply voltage in such applications. UCC27282 gate driver has typical UVLO level of 5V and therefore, they are perfectly suitable for such applications. There is enough UVLO hysteresis provided to avoid any chattering or nuisance tripping which improves system robustness.

8.2 Typical Application

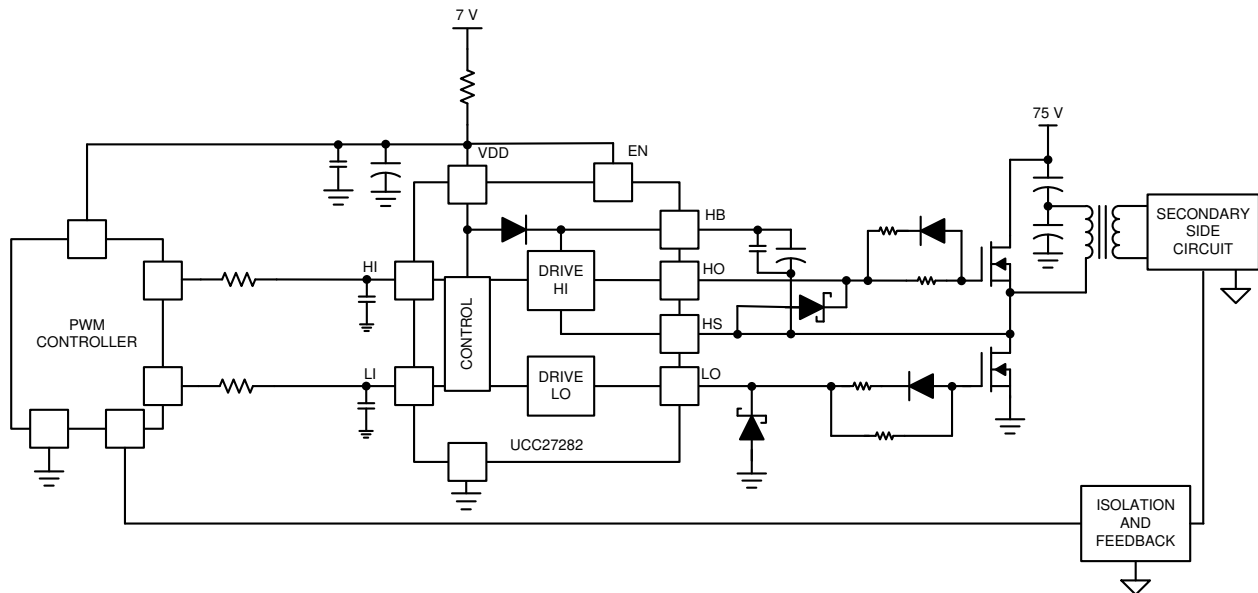

Copyright © 2018, Texas Instruments Incorporated

图 8-1. Typical Application

8.2.1 Design Requirements

Table below lists the system parameters. UCC27282 needs to operate satisfactorily in conjunction with them.

表 8-1. Design Requirements

Parameter	Value
MOSFET	CSD19535KTT
Maximum Bus/Input Voltage, V_{in}	75V
Operating Bias Voltage, V_{DD}	7V
Switching Frequency, F_{sw}	300kHz
Total Gate Charge of FET at given V_{DD} , Q_G	52nC
MOSFET Internal Gate Resistance, R_{GFET_Int}	1.4
Maximum Duty Cycle, D_{Max}	0.5
Gate Driver	UCC27282

8.2.2 Detailed Design Procedure

8.2.2.1 Select Bootstrap and VDD Capacitor

The bootstrap capacitor must maintain the V_{HB-HS} voltage above the UVLO threshold for normal operation. Calculate the maximum allowable drop across the bootstrap capacitor, ΔV_{HB} , with [方程式 1](#).

$$\begin{aligned} \Delta V_{HB} &= V_{DD} - V_{DH} - V_{HBL} \\ &= (7\text{ V} - 1\text{ V} - (4.4\text{ V} - 0.37\text{ V})) = 1.97\text{ V} \end{aligned} \quad (1)$$

where

- V_{DD} is the supply voltage of gate driver device
- V_{DH} is the bootstrap diode forward voltage drop

- V_{HBL} is the HB falling threshold ($V_{HBR(max)} - V_{HBH}$)

In this example the allowed voltage drop across bootstrap capacitor is 1.97 V.

It is generally recommended that ripple voltage on both the bootstrap capacitor and VDD capacitor should be minimized as much as possible. Many of commercial, industrial, and automotive applications use ripple value of 0.5 V.

Use [方程式 2](#) to estimate the total charge needed per switching cycle from bootstrap capacitor.

$$Q_{TOTAL} = Q_G + I_{HBS} \times \left(\frac{D_{MAX}}{f_{SW}} \right) + \left(\frac{I_{HB}}{f_{SW}} \right)$$

$$= 52 \text{ nC} + 0.083 \text{ nC} + 1.33 \text{ nC} = 53.41 \text{ nC} \quad (2)$$

where

- Q_G is the total MOSFET gate charge
- I_{HBS} is the HB to VSS leakage current from datasheet
- D_{Max} is the converter maximum duty cycle
- I_{HB} is the HB quiescent current from the datasheet

The calculated total charge is 53.41 nC.

Next, use [方程式 3](#) to estimate the minimum bootstrap capacitor value.

$$C_{BOOT (min)} = \frac{Q_{TOTAL}}{\Delta V_{HB}} = \frac{53.41 \text{ nC}}{1.97 \text{ V}} = 27.11 \text{ nF} \quad (3)$$

The calculated value of minimum bootstrap capacitor is 27.11 nF. It should be noted that, this value of capacitance is needed at full bias voltage. In practice, the value of the bootstrap capacitor must be greater than calculated value to allow for situations where the power stage may skip pulse due to various transient conditions. It is recommended to use a 100-nF bootstrap capacitor in this example. It is also recommended to include enough margin and place the bootstrap capacitor as close to the HB and HS pins as possible. Also place a small size, 0402, low value, 1000 pF, capacitor to filter high frequency noise, in parallel with main bypass capacitor.

For this application, choose a C_{BOOT} capacitor that has the following specifications: 0.1 μF , 25 V, X7R

As a general rule the local VDD bypass capacitor must be greater than the value of bootstrap capacitor value (generally 10 times the bootstrap capacitor value). For this application choose a C_{VDD} capacitor with the following specifications: 1 μF , 25 V, X7R

C_{VDD} capacitor is placed across VDD and VSS pin of the gate driver. Similar to bootstrap capacitors, place a small size and low value capacitor in parallel with the main bypass capacitor. For this application, choose 0402, 1000 pF, capacitance in parallel with main bypass capacitor to filter high frequency noise.

The bootstrap and bias capacitors must be ceramic types with X7R dielectric or better. Choose a capacitor with a voltage rating at least twice the maximum voltage that it will be exposed to. Choose this value because most ceramic capacitors lose significant capacitance when biased. This value also improves the long term reliability of the system.

8.2.2.2 Estimate Driver Power Losses

The total power loss in gate driver device such as the UCC27282 is the summation of the power loss in different functional blocks of the gate driver device. These power loss components are explained in this section.

1. [方程式 4](#) describes how quiescent currents (I_{DD} and I_{HB}) affect the static power losses, P_{QC} .

$$P_{QC} = (V_{DD} \times I_{DD}) + (V_{DD} - V_{DH}) \times I_{HB}$$

$$= 7 \text{ V} \times 0.4 \text{ mA} + 6 \text{ V} \times 0.4 \text{ mA} = 5.2 \text{ mW} \quad (4)$$

it is not shown here, but for better approximation, add no load operating current, I_{DDO} and I_{HBO} in above equation.

2. 方程式 5 shows how high-side to low-side leakage current (I_{HBS}) affects level-shifter losses (P_{IHBS}).

$$P_{IHBS} = V_{HB} \times I_{HBS} \times D = 82 \text{ V} \times 50 \mu\text{A} \times 0.5 = 2.05 \text{ mW} \quad (5)$$

where

- D is the high-side MOSFET duty cycle
 - V_{HB} is the sum of input voltage and voltage across bootstrap capacitor.
3. 方程式 6 shows how MOSFETs gate charge (Q_G) affects the dynamic losses, P_{QG} .

$$P_{QG} = 2 \times V_{DD} \times Q_G \times f_{SW} \times \frac{R_{GD_R}}{R_{GD_R} + R_{GATE} + R_{GFET(int)}} \\ = 2 \times 7 \text{ V} \times 52 \text{ nC} \times 300 \text{ kHz} \times 0.74 = 0.16 \text{ W} \quad (6)$$

where

- Q_G is the total MOSFET gate charge
- f_{SW} is the switching frequency
- R_{GD_R} is the average value of pullup and pulldown resistor
- R_{GATE} is the external gate drive resistor
- $R_{GFET(int)}$ is the power MOSFETs internal gate resistor

Assume there is no external gate resistor in this example. The average value of maximum pull-up and pull down resistance of the driver output section is approximately 4Ω . Substitute the application values to calculate the dynamic loss due to gate charge, which is 160 mW here.

4. 方程式 7 shows how parasitic level-shifter charge (Q_P) on each switching cycle affects dynamic losses, (P_{LS}) during high-side switching.

$$P_{LS} = V_{HB} \times Q_P \times f_{SW} \quad (7)$$

For this example and simplicity, it is assumed that value of parasitic charge Q_P is 1 nC. Substituting values results in 24.6 mW as level shifter dynamic loss. This estimate is very high for level shifter dynamic losses.

The sum of all the losses is 191.85 mW as a total gate driver loss. As shown in this example, in most applications the dynamic loss due to gate charge dominates the total power loss in gate driver device. For gate drivers that include bootstrap diode, one should also estimate losses in bootstrap diode. Diode forward conduction loss is computed as product of average forward voltage drop and average forward current.

方程式 8 estimates the maximum allowable power loss of the device for a given ambient temperature.

$$P_{MAX} = \frac{(T_J - T_A)}{R_{\theta JA}} \quad (8)$$

where

- P_{MAX} is the maximum allowed power dissipation in the gate driver device
- T_J is the recommended maximum operating junction temperature
- T_A is the ambient temperature of the gate driver device
- $R_{\theta JA}$ is the junction-to-ambient thermal resistance

To better estimate the junction temperature of the gate driver device in the application, it is recommended to first accurately measure the case temperature and then determine the power dissipation in a given application. Then use ψ_{JT} to calculate junction temperature. After estimating junction temperature and measuring ambient temperature in the application, calculate $\theta_{JA(effective)}$. Then, if design parameters (such as the value of an

external gate resistor or power MOSFET) change during the development of the project, use $\theta_{JA(\text{effective})}$ to estimate how these changes affect junction temperature of the gate driver device.

For detailed information regarding the thermal information table, please refer to the [Semiconductor and Device Package Thermal Metrics](#) application report.

8.2.2.3 Selecting External Gate Resistor

In high-frequency switching power supply applications where high-current gate drivers such as the UCC27282 are used, parasitic inductances, parasitic capacitances and high-current loops can cause noise and ringing on the gate of power MOSFETs. Often external gate resistors are used to damp this ringing and noise. In some applications the gate charge, which is load on gate driver device, is significantly larger than gate driver peak output current capability. In such applications external gate resistors can limit the peak output current of the gate driver. It is recommended that there should be provision of external gate resistor whenever the layout or application permits.

Use [Equation 9](#) to calculate the driver high-side pull-up current.

$$I_{OHH} = \frac{V_{DD} - V_{DH}}{R_{HOH} + R_{GATE} + R_{GFET(int)}} \quad (9)$$

where

- I_{OHH} is the high-side, peak pull-up current
- V_{DH} is the bootstrap diode forward voltage drop
- R_{HOH} is the gate driver internal high-side pull-up resistor. Value either directly provided in datasheet or can be calculated from test conditions ($R_{HOH} = V_{HOH}/I_{HO}$)
- R_{GATE} is the external gate resistance connected between driver output and power MOSFET gate
- $R_{GFET(int)}$ is the MOSFET internal gate resistance provided by MOSFET datasheet

Use [Equation 10](#) to calculate the driver high-side sink current.

$$I_{OLH} = \frac{V_{DD} - V_{DH}}{R_{HOL} + R_{GATE} + R_{GFET(int)}} \quad (10)$$

where

- R_{HOL} is the gate driver internal high-side pull-down resistance

Use [Equation 11](#) to calculate the driver low-side source current.

$$I_{OHL} = \frac{V_{DD}}{R_{LOH} + R_{GATE} + R_{GFET(int)}} \quad (11)$$

where

- R_{LOH} is the gate driver internal low-side pull-up resistance

Use [Equation 12](#) to calculate the driver low-side sink current.

$$I_{OLL} = \frac{V_{DD}}{R_{LOL} + R_{GATE} + R_{GFET(int)}} \quad (12)$$

where

- R_{LOL} is the gate driver internal low-side pull-down resistance

Both high and low-side channels of the gate driver have a peak current rating of ± 3 A. These equations help reduce the peak current if needed. To establish different rise time value compared to fall time value, external gate resistor can be anti-parallelled with diode-resistor combination as shown in [Figure 8-1](#). Generally selecting an optimal value or configuration of external gate resistor is an iterative process. For additional information on selecting external gate resistor please refer to [External Gate Resistor Design Guide for Gate Drivers](#)

8.2.2.4 Delays and Pulse Width

The total delay encountered in the PWM, driver and power stage need to be considered for a number of reasons, primarily delay in current limit response. Also to be considered are differences in delays between the drivers which can lead to various concerns depending on the topology. The synchronous buck topology switching requires careful selection of dead-time between the high-side and low-side switches to avoid cross conduction as well as excessive body diode conduction.

Bridge topologies can be affected by a volt-second imbalance on the transformer if there is imbalance in the high-side and low-side pulse widths in any operating condition. The UCC27282 device has maximum propagation delay, across process, and temperature variation, of 30 ns and delay matching of 7 ns, which is one of the best in the industry.

Narrow input pulse width performance is an important consideration in gate driver devices, because output may not follow input signals satisfactorily when input pulse widths are very narrow. Although there may be relatively wide steady state PWM output signals from controller, very narrow pulses may be encountered under following operating conditions.

- soft-start period
- large load transients
- short circuit conditions

These narrow pulses appear as an input signal to the gate driver device and the gate driver device need to respond properly to these narrow signals.

[Figure 8-2](#) shows that the UCC27282 device produces reliable output pulse even when the input pulses are very narrow and bias voltages are very low. The propagation delay and delay matching do not get affected when the input pulse width is very narrow.

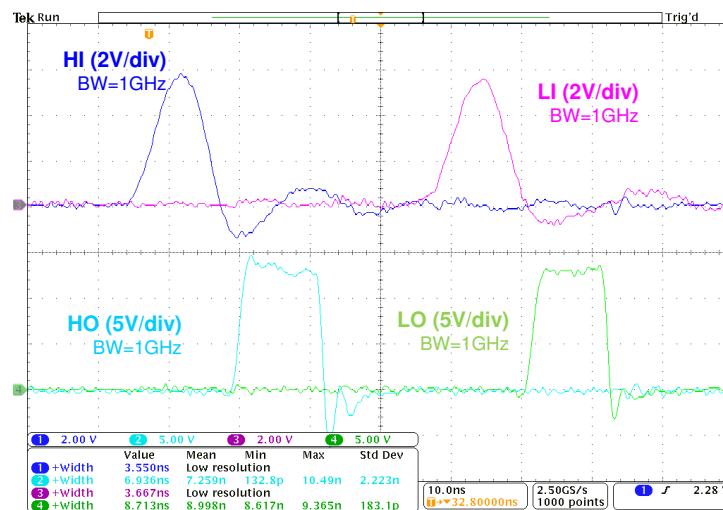

Figure 8-2. Input and Output Pulse Width

8.2.2.5 External Bootstrap Diode

The UCC27282 incorporates the bootstrap diode necessary to generate the high-side bias for HO to work satisfactorily. The characteristics of this diode are important to achieve efficient, reliable operation. The characteristics to consider are forward voltage drop and dynamic resistance. Generally, low forward voltage drop diodes are preferred for low power loss during charging of the bootstrap capacitor. The device has a boot diode

forward voltage drop rated at 0.85 V and dynamic resistance of 1.5 Ω for reliable charge transfer to the bootstrap capacitor. The dynamic characteristics to consider are diode recovery time and stored charge. Diode recovery times that are specified without operating conditions, can be misleading. Diode recovery times at no forward current (I_F) can be noticeably less than with forward current applied. The UCC27282 boot diode recovery is specified as 50 ns at $I_F = 20$ mA, $I_{REV} = 0.5$ A. Dynamic impedance of UCC27282 bootstrap diode naturally limits the peak forward current and prevents any damage if repetitive peak forward current pulses exist in the system for most applications.

In applications where switching frequencies are very high, for example in excess of 1 MHz, and the low-side minimum pulse widths are very small, the diode peak forward current could be very high and peak reverse current could also be very high, specifically if high bootstrap capacitor value has been chosen. In such applications it might be advisable to use external Schottky diode as bootstrap diode. It is safe to at least make a provision for such diode on the board if possible.

8.2.2.6 VDD and Input Filter

Some switching power supply applications are extremely noisy. Noise may come from ground bouncing and ringing at the inputs, (which are the HI and LI pins of the gate driver device). To mitigate such situations, the UCC27282 offers both negative input voltage handling capability and wide input threshold hysteresis. If these features are not enough, then the application might need an input filter. Small filter such as 10- Ω resistor and 47-pF capacitor might be sufficient to filter noise at the inputs of the gate driver device. This RC filter would introduce delay and therefore need to be considered carefully. High frequency noise on bias supply can cause problems in performance of the gate driver device. To filter this noise it is recommended to use 1- Ω resistor in series with VDD pin as shown in [图 8-1](#). This resistor also acts as a current limiting element. In the event of short circuit on the bias rail, this resistor opens up and prevents further damage. This resistor can also be helpful in debugging the design during development phase.

8.2.2.7 Transient Protection

As mentioned in previous sections, high power high switching frequency power supplies are inherently noisy. High dV/dt and dI/dt in the circuit can cause negative voltage on different pins such as HO, LO, and HS. The device tolerates negative voltage on all of these pins as mentioned in specification tables. If parasitic elements of the circuit cause very large negative swings, circuit might require additional protection. In such cases fast acting and low leakage type Schottky diode should be used. This diode must be placed as close to the gate driver device pin as possible for it to be effective in clamping excessive negative voltage on the gate driver device pin. Sometimes a small resistor, (for example 2 Ω , in series with HS pin) is also effective in improving performance reliability. To avoid the possibility of driver device damage due to over-voltage on its output pins or supply pins, low leakage Zener diode can be used. A 15-V Zener diode is often sufficient to clamp the voltage below the maximum recommended value of 16 V.



8.2.3 Application Curves

To minimize the switching losses in power supplies, turn-ON and turn-OFF of the power MOSFETs need to be as fast as possible. Higher the drive current capability of the driver, faster the switching. Therefore, the UCC27282 is designed with high drive current capability and low resistance of the output stages. One of the common way to test the drive capability of the gate driver device, is to test it under heavy load. Rise time and fall time of the outputs would provide idea of drive capability of the gate driver device. There must not be any resistance in this test circuit. [图 8-3](#) and [图 8-4](#) shows rise time and fall time of HO respectively of UCC27282. [图 8-5](#) and [图 8-6](#) shows rise time and fall time of LO respectively of UCC27282. For accuracy purpose, the VDD and HB pin of the gate driver device were connected together. HS and VSS pins are also connected together for this test.

Peak current capability can be estimated using the fastest dV/dt along the rise and fall curve of the plot. This method is also useful in comparing performance of two or more gate driver devices.

As explained in [节 8.2.2.4](#), propagation delay plays an important role in reliable operation of many applications. [图 8-7](#) and [图 8-8](#)

[图 8-8](#) shows propagation delay and delay matching of UCC27282. In many switching power supply applications input signals to the gate driver have large amplitude high frequency noise. If there is no filter employed at the

input, then there is a possibility of false signal passing through the gate driver and causing shoot-through on the output. UCC27282 prevents such shoot-through. If two inputs are high at the same time, UCC27282 shuts both the outputs off.  8-9 shows interlock feature of UCC27282 and  8-10 shows input negative voltage handling capability of UCC27282.

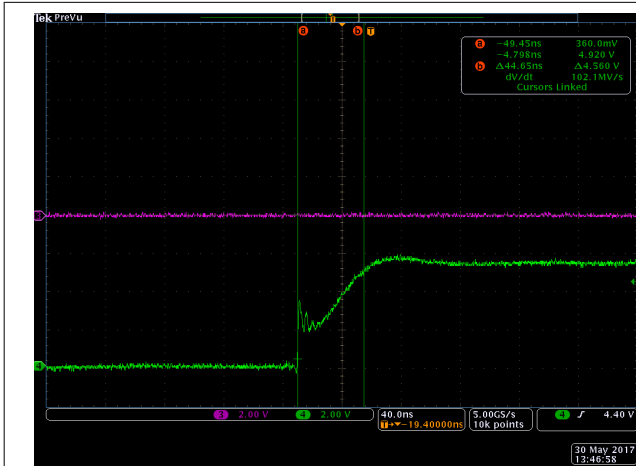

$V_{DD} = V_{HB} = 6\text{ V}$, $HS = VSS$, $C_{LOAD} = 10\text{ nF}$, Ch4 = HO

 8-3. HO Rise Time

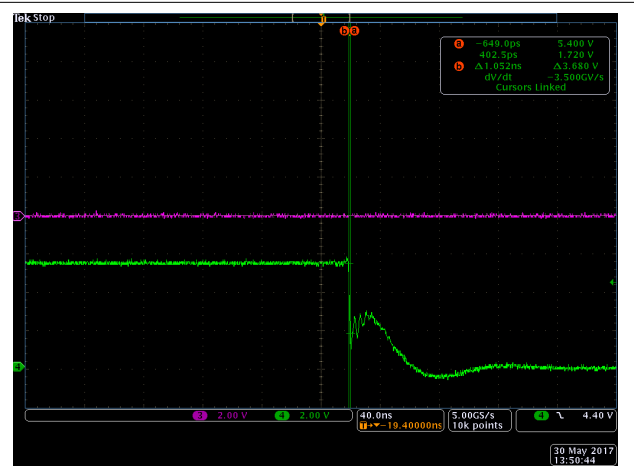

$V_{DD} = V_{HB} = 6\text{ V}$, $HS = VSS$, $C_{LOAD} = 10\text{ nF}$, Ch4 = HO

 8-4. HO Fall Time

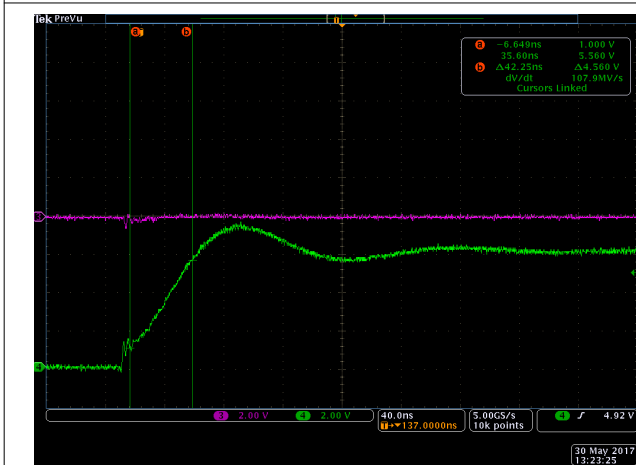

A. $V_{DD} = V_{HB} = 6\text{ V}$, $HS = VSS$, $C_{LOAD} = 10\text{ nF}$, Ch4 = LO

 8-5. LO Rise Time

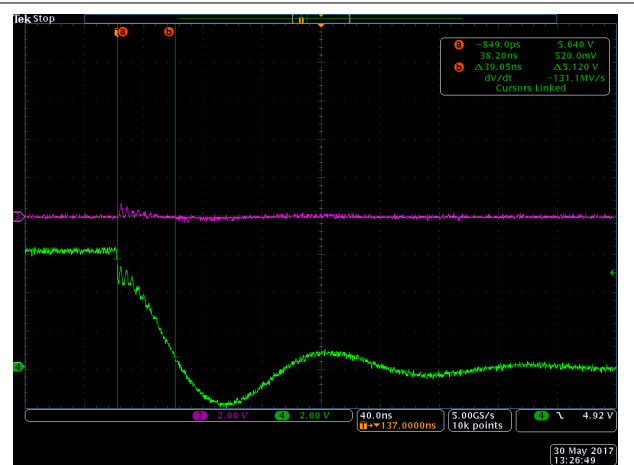

A. $V_{DD} = V_{HB} = 6\text{ V}$, $HS = VSS$, $C_{LOAD} = 10\text{ nF}$, Ch4 = LO

 8-6. LO Fall Time

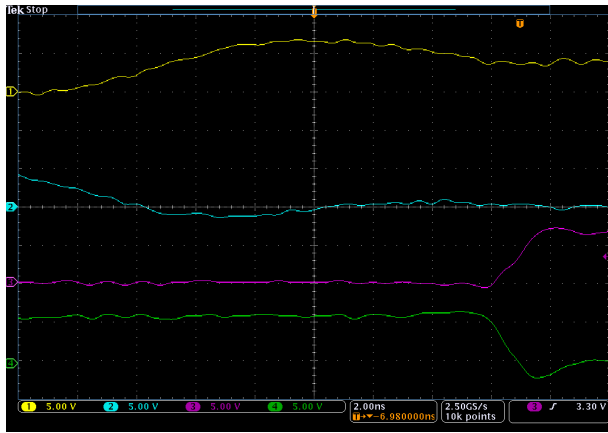

A. $V_{DD} = 6\text{ V}$ $C_{LOAD} = 2\text{ nF}$ Ch1 = HI Ch2 = LI Ch3 = HO Ch4 = LO

图 8-7. Propagation Delay and Delay Matching

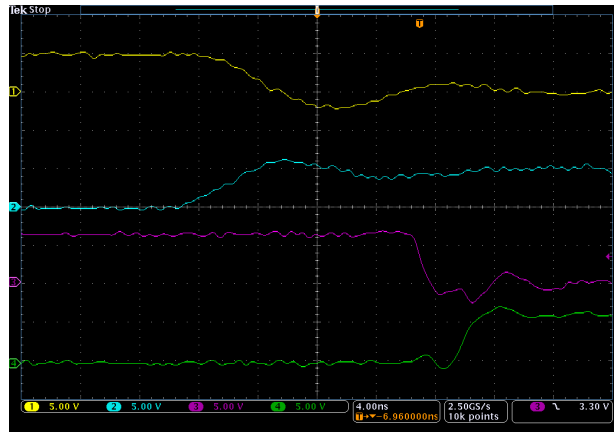

A. $V_{DD} = 6\text{ V}$ $C_{LOAD} = 2\text{ nF}$ Ch1 = HI Ch2 = LI Ch3 = HO Ch4 = LO

图 8-8. Propagation Delay and Delay Matching

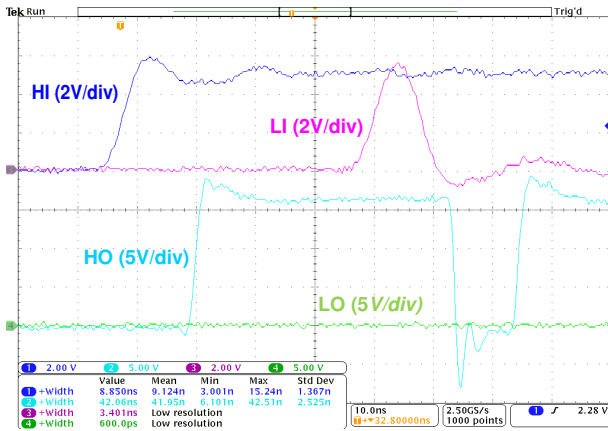

A. $V_{DD} = V_{HB} = 12\text{ V}$, HS = VSS $C_{LOAD} = 0\text{ nF}$

图 8-9. Input Shoot-through Protection or Interlock

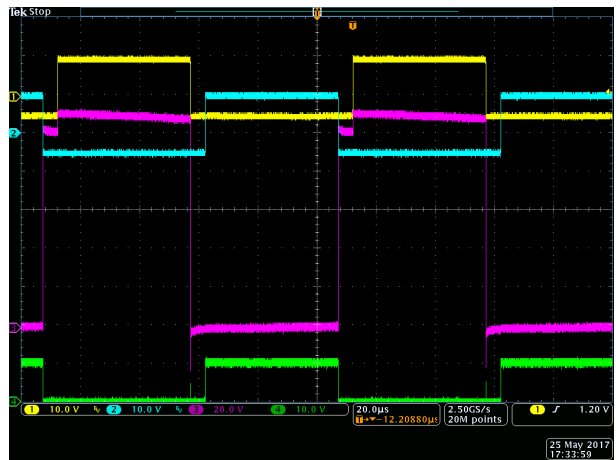

A. $V_{DD} = 10\text{ V}$ $V_{in} = 100\text{ V}$ $C_L = 1\text{ nF}$ Ch1 = HI Ch2 = LI Ch3 = HO Ch4 = LO

图 8-10. Input Negative Voltage

9 Power Supply Recommendations

The recommended bias supply voltage range for UCC27282 is from 5.5 V to 16 V. The lower end of this range is governed by the internal under voltage-lockout (UVLO) protection feature, 5 V typical, of the V_{DD} supply circuit block. The upper end of this range is driven by the 16-V recommended maximum voltage rating of the V_{DD} . It is recommended that voltage on VDD pin should be lower than maximum recommended voltage. In some transient condition it is not possible to keep this voltage below recommended maximum level and therefore absolute maximum voltage rating of the UCC27282 is 20 V.

The UVLO protection feature also involves a hysteresis function. This means that once the device is operating in normal mode, if the V_{DD} voltage drops, the device continues to operate in normal mode as far as the voltage drop do not exceeds the hysteresis specification, V_{DDHYS} . If the voltage drop is more than hysteresis specification, the device shuts down. Therefore, while operating at or near the 5.5-V range, the voltage ripple on the auxiliary power supply output should be smaller than the hysteresis specification of UCC27282 to avoid triggering device shutdown.

A local bypass capacitor should be placed between the VDD and GND pins. This capacitor should be located as close to the device as possible. A low ESR, ceramic surface mount capacitor is recommended. It is recommended to use two capacitors across VDD and GND: a low capacitance ceramic surface-mount capacitor for high frequency filtering placed very close to VDD and GND pin, and another high capacitance value surface-mount capacitor for device bias requirements. In a similar manner, the current pulses delivered by the HO pin are sourced from the HB pin. Therefore, two capacitors across the HB to HS are recommended. One low value small size capacitor for high frequency filtering and another one high capacitance value capacitor to deliver HO pulses.

UCC27282 has enable/disable functionality through EN pin. Therefore, signal at the EN pin should be as clean as possible. If EN pin is not used, then it is recommended to connect the pin to VDD pin. If EN pin is pulled up through a resistor, then the pull-up resistor needs to be strong. In noise prone applications, it is recommended to filter the EN pin with small capacitor, such as X7R 0402 1nF.

In power supplies where noise is very dominant and there is space on the PWB (Printed Wiring Board), it is recommended to place a small RC filter at the inputs. This allows for improving the overall performance of the design. In such applications, it is also recommended to have a place holder for power MOSFET external gate resistor. This resistor allows the control of not only the drive capability but also the slew rate on HS, which impacts the performance of the high-side circuit. If diode is used across the external gate resistor, it is recommended to use a resistor in series with the diode, which provides further control of fall time.

In power supply applications such as motor drives, there exist lot of transients through-out the system. This sometime causes over voltage and under voltage spikes on almost all pins of the gate driver device. To increase the robustness of the design, it is recommended that the clamp diode should be used on HO and LO pins. If user does not wish to use power MOSFET parasitic diode, external clamp diode on HS pin is recommended, which needs to be high voltage high current type (same rating as MOSFET) and very fast acting. The leakage of these diodes across the temperature needs to be minimal.

In power supply applications where it is almost certain that there is excessive negative HS voltage, it is recommended to place a small resistor between the HS pin and the switch node. This resistance helps limit current into the driver device up to some extent. This resistor will impact the high side drive capability and therefore needs to be considered carefully.

10 Layout

10.1 Layout Guidelines

To achieve optimum performance of high-side and low-side gate drivers, one must consider following printed wiring board (PWB) layout guidelines.

- Low ESR/ESL capacitors must be connected close to the device between VDD and VSS pins and between HB and HS pins to support high peak currents drawn from VDD and HB pins during the turn-on of the external MOSFETs.
- To prevent large voltage transients at the drain of the top MOSFET, a low ESR electrolytic capacitor and a good quality ceramic capacitor must be connected between the high side MOSFET drain and ground (VSS).
- In order to avoid large negative transients on the switch node (HS) pin, the parasitic inductances between the source of the high-side MOSFET and the source of the low-side MOSFET (synchronous rectifier) must be minimized.
- Overlapping of HS plane and ground (VSS) plane should be minimized as much as possible so that coupling of switching noise into the ground plane is minimized.
- Thermal pad should be connected to large heavy copper plane to improve the thermal performance of the device. Generally it is connected to the ground plane which is the same as VSS of the device. It is recommended to connect this pad to the VSS pin only.
- Grounding considerations:
 - The first priority in designing grounding connections is to confine the high peak currents that charge and discharge the MOSFET gates to a minimal physical area. This confinement decreases the loop inductance and minimize noise issues on the gate terminals of the MOSFETs. Place the gate driver as close to the MOSFETs as possible.
 - The second consideration is the high current path that includes the bootstrap capacitor, the bootstrap diode, the local ground referenced bypass capacitor, and the low-side MOSFET body diode. The bootstrap capacitor is recharged on a cycle-by-cycle basis through the bootstrap diode from the ground referenced VDD bypass capacitor. The recharging occurs in a short time interval and involves high peak current. Minimizing this loop length and area on the circuit board is important to ensure reliable operation.

10.2 Layout Example



图 10-1. Layout Example

11 Device and Documentation Support

11.1 Device Support

11.1.1 第三方产品免责声明

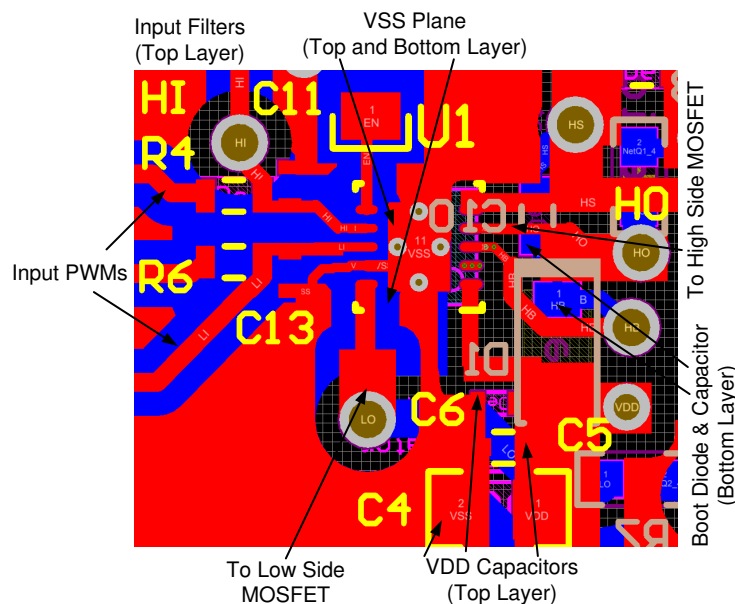
TI 发布的与第三方产品或服务有关的信息，不能构成与此类产品或服务或保修的适用性有关的认可，不能构成此类产品或服务单独或与任何 TI 产品或服务一起的表示或认可。

11.2 接收文档更新通知

要接收文档更新通知，请导航至 ti.com 上的器件产品文件夹。点击 [订阅更新](#) 进行注册，即可每周接收产品信息更改摘要。有关更改的详细信息，请查看任何已修订文档中包含的修订历史记录。

11.3 支持资源

[TI E2E™ 支持论坛](#) 是工程师的重要参考资料，可直接从专家获得快速、经过验证的解答和设计帮助。搜索现有解答或提出自己的问题可获得所需的快速设计帮助。

链接的内容由各个贡献者“按原样”提供。这些内容并不构成 TI 技术规范，并且不一定反映 TI 的观点；请参阅 TI 的《[使用条款](#)》。

11.4 Trademarks

TI E2E™ is a trademark of Texas Instruments.

所有商标均为其各自所有者的财产。

11.5 Electrostatic Discharge Caution



This integrated circuit can be damaged by ESD. Texas Instruments recommends that all integrated circuits be handled with appropriate precautions. Failure to observe proper handling and installation procedures can cause damage.

ESD damage can range from subtle performance degradation to complete device failure. Precision integrated circuits may be more susceptible to damage because very small parametric changes could cause the device not to meet its published specifications.

11.6 术语表

[TI 术语表](#) 本术语表列出并解释了术语、首字母缩略词和定义。

12 Mechanical, Packaging, and Orderable Information

The following pages include mechanical, packaging, and orderable information. This information is the most current data available for the designated devices. This data is subject to change without notice and revision of this document. For browser-based versions of this data sheet, refer to the left-hand navigation.

PACKAGING INFORMATION

Orderable Device	Status (1)	Package Type	Package Drawing	Pins	Package Qty	Eco Plan (2)	Lead finish/ Ball material (6)	MSL Peak Temp (3)	Op Temp (°C)	Device Marking (4/5)	Samples
UCC27282D	ACTIVE	SOIC	D	8	75	RoHS & Green	NIPDAU	Level-2-260C-1 YEAR	-40 to 125	U282	Samples
UCC27282DR	ACTIVE	SOIC	D	8	2500	RoHS & Green	NIPDAU	Level-2-260C-1 YEAR	-40 to 125	U282	Samples
UCC27282DRCR	ACTIVE	VSON	DRC	10	3000	RoHS & Green	NIPDAU	Level-1-260C-UNLIM	-40 to 125	U27282	Samples
UCC27282DRCT	ACTIVE	VSON	DRC	10	250	RoHS & Green	NIPDAU	Level-1-260C-UNLIM	-40 to 125	U27282	Samples
UCC27282DRMR	ACTIVE	VSON	DRM	8	3000	RoHS & Green	NIPDAU	Level-1-260C-UNLIM	-40 to 140	U282	Samples

(1) The marketing status values are defined as follows:

ACTIVE: Product device recommended for new designs.

LIFEBUY: TI has announced that the device will be discontinued, and a lifetime-buy period is in effect.

NRND: Not recommended for new designs. Device is in production to support existing customers, but TI does not recommend using this part in a new design.

PREVIEW: Device has been announced but is not in production. Samples may or may not be available.

OBSELETE: TI has discontinued the production of the device.

(2) **RoHS:** TI defines "RoHS" to mean semiconductor products that are compliant with the current EU RoHS requirements for all 10 RoHS substances, including the requirement that RoHS substance do not exceed 0.1% by weight in homogeneous materials. Where designed to be soldered at high temperatures, "RoHS" products are suitable for use in specified lead-free processes. TI may reference these types of products as "Pb-Free".

RoHS Exempt: TI defines "RoHS Exempt" to mean products that contain lead but are compliant with EU RoHS pursuant to a specific EU RoHS exemption.

Green: TI defines "Green" to mean the content of Chlorine (Cl) and Bromine (Br) based flame retardants meet JS709B low halogen requirements of <=1000ppm threshold. Antimony trioxide based flame retardants must also meet the <=1000ppm threshold requirement.

(3) MSL, Peak Temp. - The Moisture Sensitivity Level rating according to the JEDEC industry standard classifications, and peak solder temperature.

(4) There may be additional marking, which relates to the logo, the lot trace code information, or the environmental category on the device.

(5) Multiple Device Markings will be inside parentheses. Only one Device Marking contained in parentheses and separated by a "~" will appear on a device. If a line is indented then it is a continuation of the previous line and the two combined represent the entire Device Marking for that device.

(6) Lead finish/Ball material - Orderable Devices may have multiple material finish options. Finish options are separated by a vertical ruled line. Lead finish/Ball material values may wrap to two lines if the finish value exceeds the maximum column width.

Important Information and Disclaimer:The information provided on this page represents TI's knowledge and belief as of the date that it is provided. TI bases its knowledge and belief on information provided by third parties, and makes no representation or warranty as to the accuracy of such information. Efforts are underway to better integrate information from third parties. TI has taken and continues to take reasonable steps to provide representative and accurate information but may not have conducted destructive testing or chemical analysis on incoming materials and chemicals. TI and TI suppliers consider certain information to be proprietary, and thus CAS numbers and other limited information may not be available for release.

In no event shall TI's liability arising out of such information exceed the total purchase price of the TI part(s) at issue in this document sold by TI to Customer on an annual basis.

OTHER QUALIFIED VERSIONS OF UCC27282 :

- Automotive : [UCC27282-Q1](#)

NOTE: Qualified Version Definitions:

- Automotive - Q100 devices qualified for high-reliability automotive applications targeting zero defects

TAPE AND REEL INFORMATION

QUADRANT ASSIGNMENTS FOR PIN 1 ORIENTATION IN TAPE

*All dimensions are nominal

Device	Package Type	Package Drawing	Pins	SPQ	Reel Diameter (mm)	Reel Width W1 (mm)	A0 (mm)	B0 (mm)	K0 (mm)	P1 (mm)	W (mm)	Pin1 Quadrant
UCC27282DR	SOIC	D	8	2500	330.0	12.5	6.4	5.2	2.1	8.0	12.0	Q1
UCC27282DRCR	VSON	DRC	10	3000	330.0	12.4	3.3	3.3	1.1	8.0	12.0	Q2
UCC27282DRCT	VSON	DRC	10	250	180.0	12.4	3.3	3.3	1.1	8.0	12.0	Q2
UCC27282DRMR	VSON	DRM	8	3000	330.0	12.4	4.25	4.25	1.15	8.0	12.0	Q2

TAPE AND REEL BOX DIMENSIONS

*All dimensions are nominal

Device	Package Type	Package Drawing	Pins	SPQ	Length (mm)	Width (mm)	Height (mm)
UCC27282DR	SOIC	D	8	2500	340.5	336.1	25.0
UCC27282DRCR	VSON	DRC	10	3000	367.0	367.0	35.0
UCC27282DRCT	VSON	DRC	10	250	210.0	185.0	35.0
UCC27282DRMR	VSON	DRM	8	3000	367.0	367.0	35.0

TUBE

*All dimensions are nominal

Device	Package Name	Package Type	Pins	SPQ	L (mm)	W (mm)	T (μm)	B (mm)
UCC27282D	D	SOIC	8	75	506.6	8	3940	4.32

DRM (S-PVSON-N8)

PLASTIC SMALL OUTLINE NO-LEAD

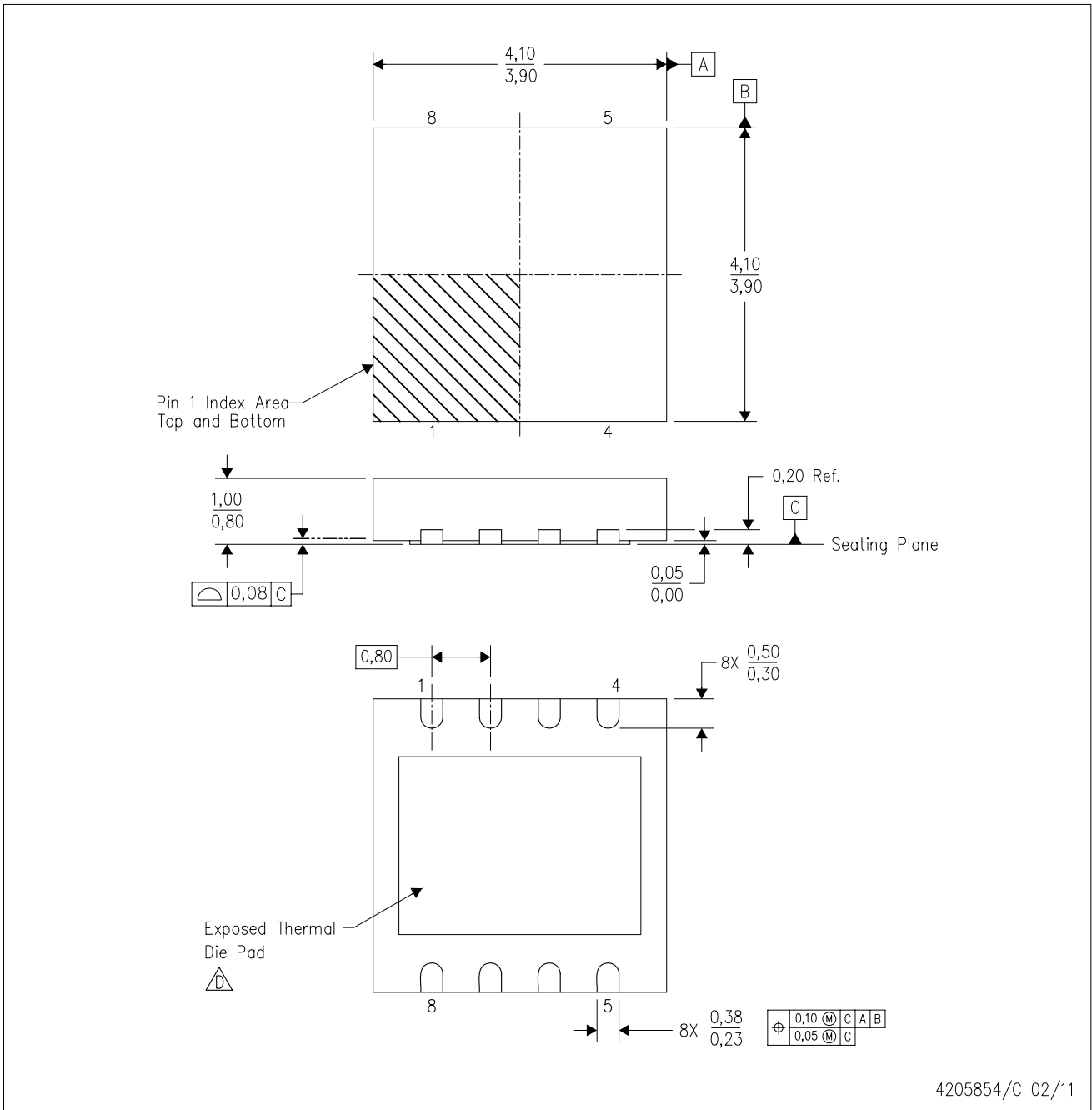

4205854/C 02/11

- NOTES:
- A. All linear dimensions are in millimeters. Dimensioning and tolerancing per ASME Y14.5M-1994.
 - B. This drawing is subject to change without notice.
 - C. SON (Small Outline No-Lead) package configuration.
 -  D. The package thermal pad must be soldered to the board for thermal and mechanical performance. See the Product Data Sheet for details regarding the exposed thermal pad dimensions.



D0008A

PACKAGE OUTLINE

SOIC - 1.75 mm max height

SMALL OUTLINE INTEGRATED CIRCUIT



4214825/C 02/2019

NOTES:

- Linear dimensions are in inches [millimeters]. Dimensions in parenthesis are for reference only. Controlling dimensions are in inches. Dimensioning and tolerancing per ASME Y14.5M.
- This drawing is subject to change without notice.
- This dimension does not include mold flash, protrusions, or gate burrs. Mold flash, protrusions, or gate burrs shall not exceed $.006$ [0.15] per side.
- This dimension does not include interlead flash.
- Reference JEDEC registration MS-012, variation AA.

EXAMPLE BOARD LAYOUT

D0008A

SOIC - 1.75 mm max height

SMALL OUTLINE INTEGRATED CIRCUIT



LAND PATTERN EXAMPLE
EXPOSED METAL SHOWN
SCALE:8X



SOLDER MASK DETAILS

4214825/C 02/2019

NOTES: (continued)

- 6. Publication IPC-7351 may have alternate designs.
- 7. Solder mask tolerances between and around signal pads can vary based on board fabrication site.

EXAMPLE STENCIL DESIGN

D0008A

SOIC - 1.75 mm max height

SMALL OUTLINE INTEGRATED CIRCUIT



SOLDER PASTE EXAMPLE
BASED ON .005 INCH [0.125 MM] THICK STENCIL
SCALE:8X

4214825/C 02/2019

NOTES: (continued)

8. Laser cutting apertures with trapezoidal walls and rounded corners may offer better paste release. IPC-7525 may have alternate design recommendations.
9. Board assembly site may have different recommendations for stencil design.

GENERIC PACKAGE VIEW

DRC 10

VSON - 1 mm max height

3 x 3, 0.5 mm pitch

PLASTIC SMALL OUTLINE - NO LEAD

This image is a representation of the package family, actual package may vary.
Refer to the product data sheet for package details.

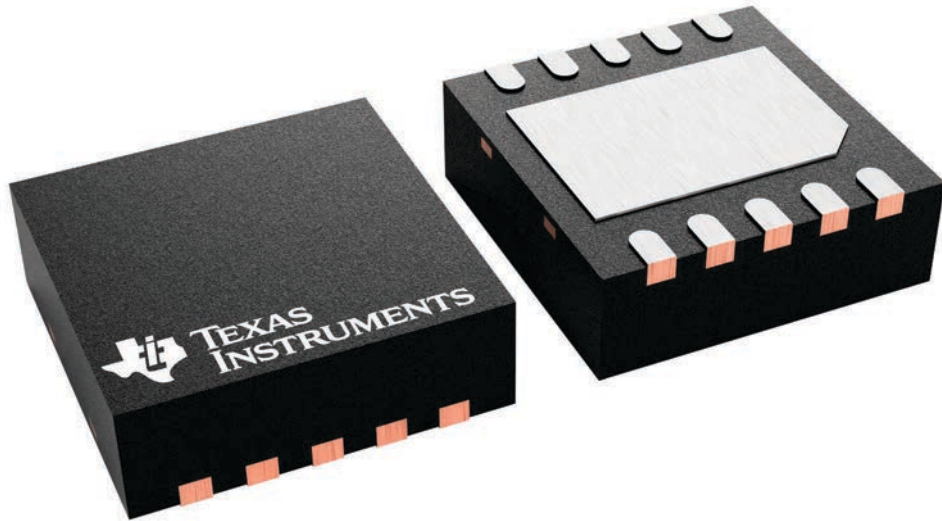

4226193/A

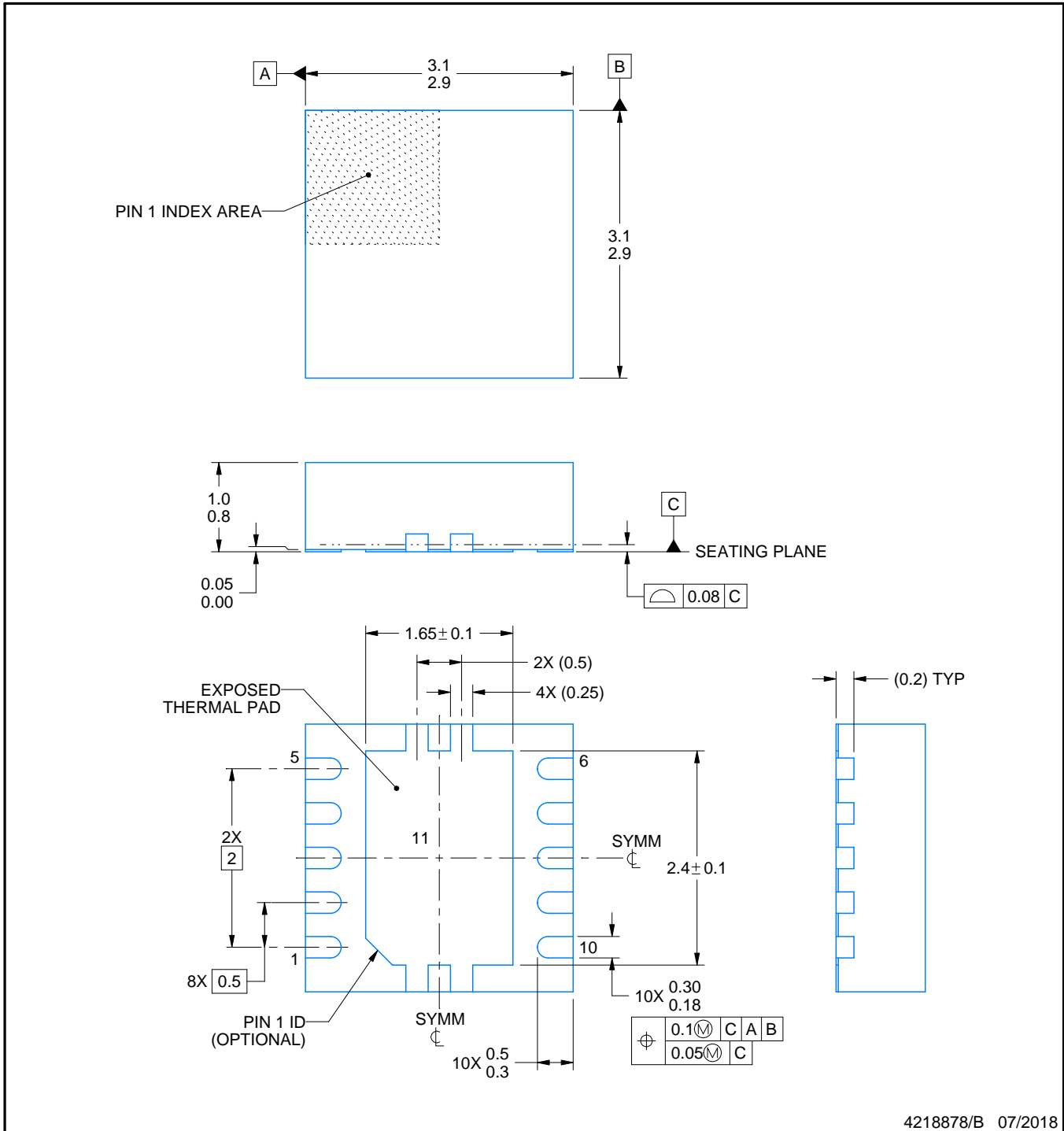

4218878/B 07/2018

NOTES:

1. All linear dimensions are in millimeters. Any dimensions in parenthesis are for reference only. Dimensioning and tolerancing per ASME Y14.5M.
2. This drawing is subject to change without notice.
3. The package thermal pad must be soldered to the printed circuit board for optimal thermal and mechanical performance.

EXAMPLE BOARD LAYOUT

DRC0010J

VSON - 1 mm max height

PLASTIC SMALL OUTLINE - NO LEAD

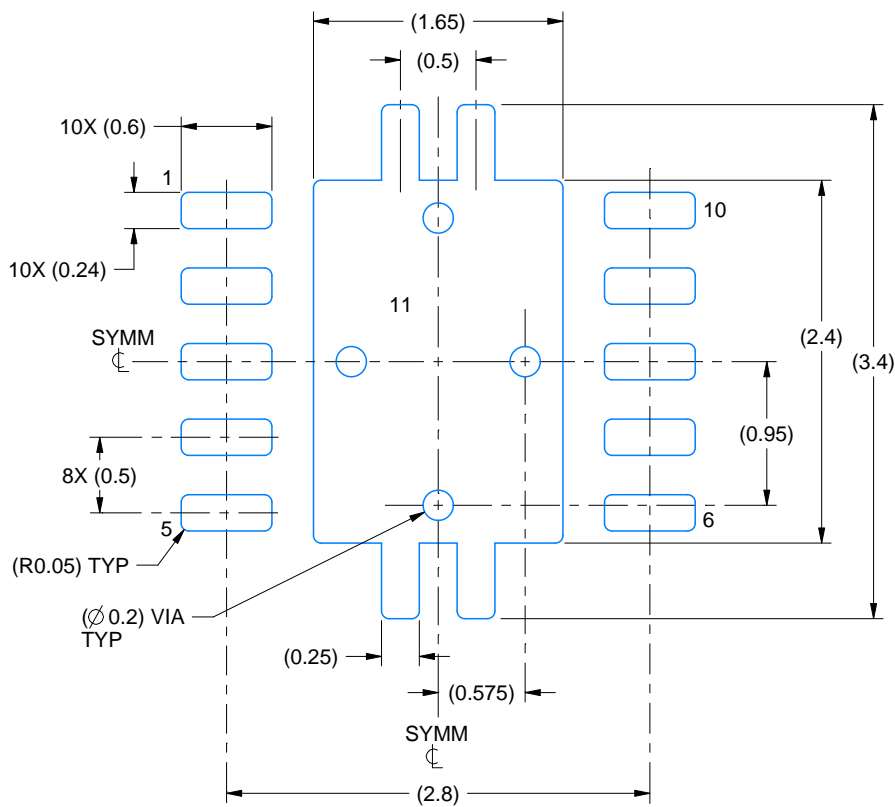

LAND PATTERN EXAMPLE
EXPOSED METAL SHOWN
SCALE:20X

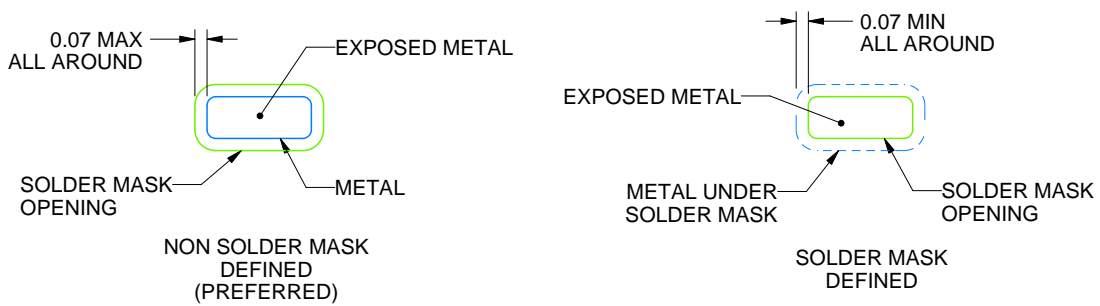

SOLDER MASK DETAILS

4218878/B 07/2018

NOTES: (continued)

4. This package is designed to be soldered to a thermal pad on the board. For more information, see Texas Instruments literature number SLUA271 (www.ti.com/lit/sluea271).
5. Vias are optional depending on application, refer to device data sheet. If any vias are implemented, refer to their locations shown on this view. It is recommended that vias under paste be filled, plugged or tented.

EXAMPLE STENCIL DESIGN

DRC0010J

VSON - 1 mm max height

PLASTIC SMALL OUTLINE - NO LEAD

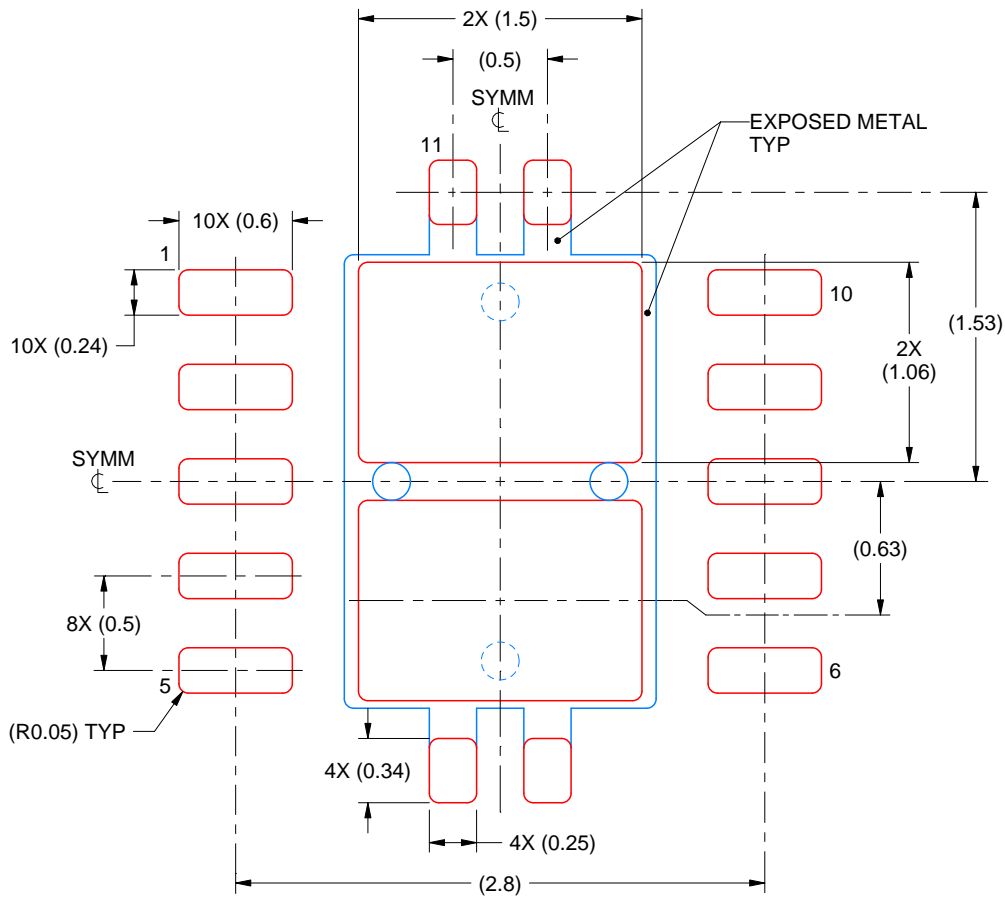

SOLDER PASTE EXAMPLE
BASED ON 0.125 mm THICK STENCIL

EXPOSED PAD 11:
80% PRINTED SOLDER COVERAGE BY AREA
SCALE:25X

4218878/B 07/2018

NOTES: (continued)

6. Laser cutting apertures with trapezoidal walls and rounded corners may offer better paste release. IPC-7525 may have alternate design recommendations.

重要声明和免责声明

TI“按原样”提供技术和可靠性数据（包括数据表）、设计资源（包括参考设计）、应用或其他设计建议、网络工具、安全信息和其他资源，不保证没有瑕疵且不做任何明示或暗示的担保，包括但不限于对适销性、某特定用途方面的适用性或不侵犯任何第三方知识产权的暗示担保。

这些资源可供使用 TI 产品进行设计的熟练开发人员使用。您将自行承担以下全部责任：(1) 针对您的应用选择合适的 TI 产品，(2) 设计、验证并测试您的应用，(3) 确保您的应用满足相应标准以及任何其他功能安全、信息安全、监管或其他要求。

这些资源如有变更，恕不另行通知。TI 授权您仅可将这些资源用于研发本资源所述的 TI 产品的应用。严禁对这些资源进行其他复制或展示。您无权使用任何其他 TI 知识产权或任何第三方知识产权。您应全额赔偿因在这些资源的使用中对 TI 及其代表造成的任何索赔、损害、成本、损失和债务，TI 对此概不负责。

TI 提供的产品受 [TI 的销售条款](#) 或 [ti.com](#) 上其他适用条款/TI 产品随附的其他适用条款的约束。TI 提供这些资源并不会扩展或以其他方式更改 TI 针对 TI 产品发布的适用的担保或担保免责声明。

TI 反对并拒绝您可能提出的任何其他或不同的条款。

邮寄地址：Texas Instruments, Post Office Box 655303, Dallas, Texas 75265

Copyright © 2023，德州仪器 (TI) 公司