

## TI Designs: TIDA-01494

# 24V、480W 标称值、720W 峰值、能效高于 93.5% 的交流/直流工业电源参考设计



### 说明

该参考设计是用于工业交流/直流电源的紧凑型、高效率、24V 直流、480W 标称值、720W 峰值输出参考设计。电路中包括前端连续导通模式 (CCM) 功率因数校正 (PFC) 电路及其后具有稳健的同步整流功能的 LLC 级。该设计确保在宽负载范围内的效率大于 93.5%，能让系统在无需强制冷却的情况下工作。

基于 UCC256301 的 LLC 级利用 UC256301 中的 ZCS 回避功能实现峰值输出功率，最大限度地减小 PFC 大容量电容器以满足保持要求，同时使系统能应对短路和过流情况。基于 UCC24612-2 的同步整流器有助于最大限度减少输出整流器的损耗。

### 资源

<a href="#">TIDA-01494</a>	设计文件夹
<a href="#">UCC28180</a>	产品文件夹
<a href="#">UCC256301</a>	产品文件夹
<a href="#">UCC24612-2</a>	产品文件夹
<a href="#">TLV3202</a>	产品文件夹
<a href="#">TMP302</a>	产品文件夹
<a href="#">TL103W</a>	产品文件夹
<a href="#">TLV70433</a>	产品文件夹
<a href="#">INA181</a>	产品文件夹

### 特性

- 具有 PFC 前端和半桥 LLC 谐振转换器的 480W 工业交流/直流电源
- 提供高达 20A 的持续电流和 3 秒高达 30A 的峰值电流
- 可调节输出电压范围为 22V 至 28V
- 满载条件下的总体效率达 93.5%，峰值效率大于 94%，可实现自然对流冷却
- 功率因数高达 0.99 以上，并满足 PFC 规范以及 IEC 61000-3-2 A 类电流 THD 要求
- 符合传导发射标准 (EN55011 B 类) 的要求
- 极低的无负载功耗 (为 400mW)
- PCB 外形小巧: 155mm x 125mm
- 系统具有针对过流、短路、过压、输出端子的保护以确保满足安全需求，还具有针对功率级的过热保护

### 应用

- [工业交流/直流电源](#)
- [DIN 轨电源](#)
- [医疗电源](#)
- [能量存储系统](#)
- [电池充电器](#)



咨询我们的 E2E™ 专家

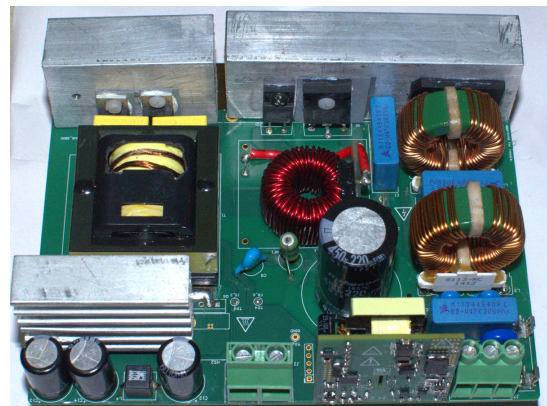
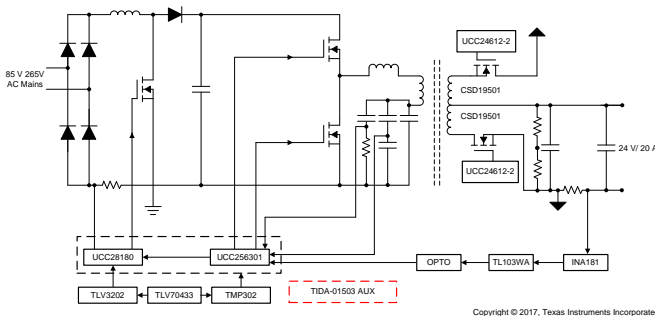



该 TI 参考设计末尾的重要声明表述了授权使用、知识产权问题和其他重要的免责声明和信息。

## 1 System Description

Industrial AC/DC power supplies are used in various applications such as process control, data logging, machinery control, instrumentation, factory automation, and security systems. These AC/DC supplies provide a convenient means for powering DC operated devices including programmable logic controllers (PLCs), sensors, transmitters and receivers, analyzers, motors, actuators, solenoids, relays, and so on. These supplies are convection cooled and need to support features like power boost where it supplies a increased output load for a short duration. The supplies operate over a wide input range from 85- to 265-V AC, delivering full load for entire input voltage range. The output voltages from these supplies range from 5 to 56 V with power ratings from 7.5 to 480 W. Many of these supplies can be connected in parallel for higher power applications.

This reference design is a 480-W high efficiency industrial AC/DC power supply. The design consists of a CCM boost PFC converter, which operates from an input voltage range of 85- to 265-V AC RMS and generates a 390-V DC bus. The second stage is made up of an isolated half-bridge LLC stage, which generates a 24-V, 20-A nominal output. The output voltage range is settable from 22 to 28 V using potentiometer present on the board. Industrial power supplies have requirements of high efficiency over their entire operating voltage range and wide load variations from a 50% to 100% load. This design demonstrates high efficiency operation in a small form factor (155 × 125 mm) and delivers continuous 480 W of power over the entire input operating voltage range from 85- to 265-V AC. It gives an efficiency of > 93.5% for 230-V AC nominal operation and 91% for 115-V AC nominal operation. The CCM PFC stage is controlled by the UCC28180 fixed frequency PFC device. CCM PFC offers a cost-optimized solution at this power level and wide input range. The HB-LLC power stage is controlled through the stage of the art UCC256301 resonant controller, which implements current mode control for increased control bandwidth. This increased control bandwidth reduces the output capacitors required to suppress the AC ripple on the output. To achieve high efficiency, the output of the LLC stage uses synchronous rectification based on the UCC24612 device and the CSD19501KCS MOSFET.

The design has low standby power of < 400 mW and meets ENERGY STAR® rating requirements as well as 2013 EU eco-design directive ErP Lot 6. The EMI filter is designed to meet EN55011 class-B conducted emission levels. The design is fully tested and validated for various parameters such as regulation, efficiency, EMI signature, output ripple, startup, and switching stresses. Overall, the design meets the key challenges of industrial power supplies to provide safe and reliable power with all protections built in, while delivering high performance with low power consumption and low bill of material (BOM) cost.

## 1.1 Key System Specifications

表 1. Key System Specifications

PARAMETER	TEST CONDITIONS	MIN	NOM	MAX	UNIT
<b>INPUT CONDITIONS</b>					
Input voltage ( $V_{INAC}$ )	—	85	230	265	VAC
Frequency ( $f_{LINE}$ )	—	47	50	63	Hz
No load power ( $P_{SB}$ )	—	—	400	—	mW
<b>OUTPUT CONDITIONS</b>					
Output voltage	—	22	—	28	V
Output current	—	—	20	30	A
Line regulation	Both current and voltage	—	—	0.5	%
Load regulation	Both current and voltage	—	—	1	%
Output voltage ripple	Peak to peak	—	200	—	mV
Output power (nominal) ( $P_o$ )	—	—	—	480	W
Output power (power boost)	—	—	—	720	W
<b>SYSTEM CHARACTERISTICS</b>					
Efficiency ( $\eta$ )	$V_{IN} = 230\text{-V AC RMS}$ and full load at 24-V output	—	93.5	—	%
	$V_{IN} = 115\text{-V AC RMS}$ and 230-W load at 24-V output	—	91	—	%
Protections	Output overcurrent	—	—	—	—
	Output overvoltage	—	—	—	—
	Output undervoltage	—	—	—	—
Operating ambient	Open frame	-10	25	55	°C
Standards and norms	Power line harmonics	As per IEC 61000-3-2 Class A			
	Conducted emissions	EN55022 Class B			
	EFT	As per IEC-61000-4-4			
	Surge	As per IEC-61000-4-5			
Board form factor (FR4 material, 2 layer)	Length x Breadth x Height	155 x 125 x 45			mm

## 2 System Overview

### 2.1 Block Diagram

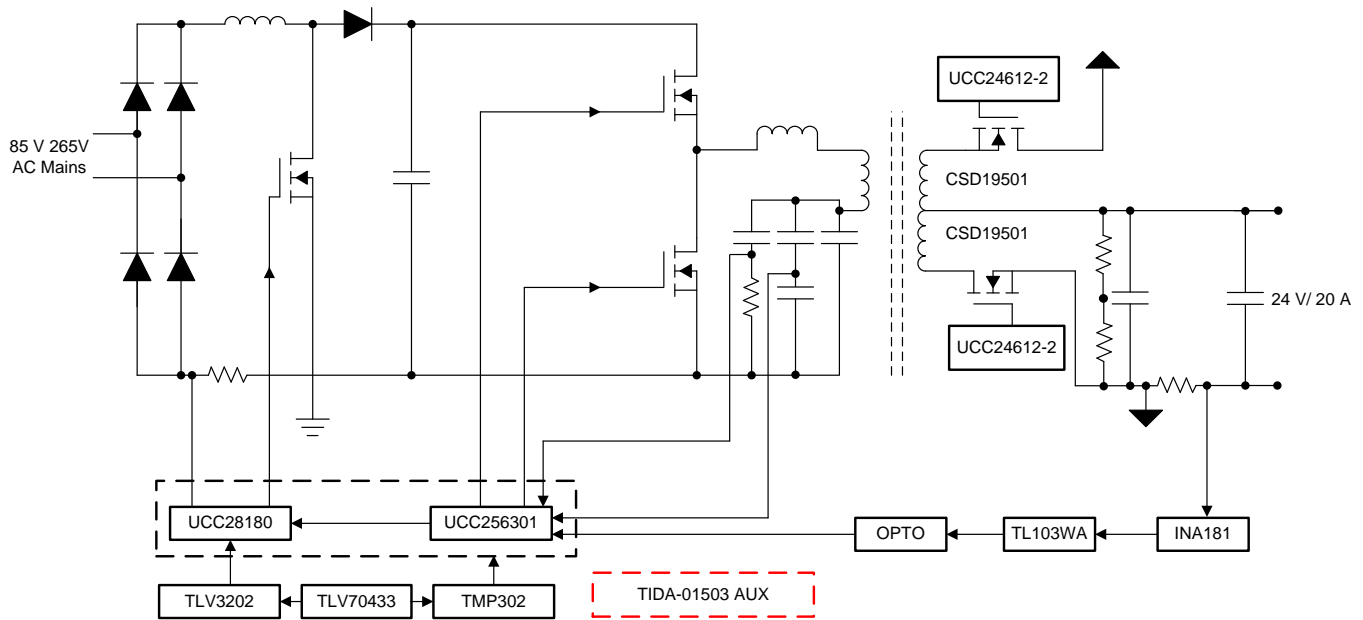

Copyright © 2017, Texas Instruments Incorporated

图 1. Block Diagram of TIDA-01494

图 1 shows the high-level block diagram of this reference design. The main parts of this design are the UCC28180 (PFC controller), UCC256301 (LLC controller), UCC24612-2 (multi-mode synchronous rectifier controller), and CSD19501KCS (80-V MOSFET).

### 2.2 Highlighted Products

#### 2.2.1 UCC28180

To implement the high-performance, small form factor PFC design at 480-W power, the UCC28180 is the preferred controller because it offers a series of benefits to address the next generation needs of low THD norms for power tools.

The UCC28180 is a high-performance, CCM compact, 8-pin programmable frequency PFC controller. Its wide and programmable operating frequency provides flexibility in design. Its trimmed current loop circuits help achieve a less than 5% THD from medium-to-full load (50% to 100%). Reduced current sense threshold helps use a 50% smaller shunt resistor, resulting in lower power dissipation while maintaining low THD. Its integrated fast gate driver of +2-A/-1.5-A drive current eliminates the need for an external gate driver.

The UCC28180 also has the following system protection features, which greatly improves reliability and further simplifies the design:

- Soft overcurrent
- Cycle-by-cycle peak current limit
- Output overvoltage
- VCC UVLO protection

- Open pin protections ( $I_{\text{SENSE}}$ ,  $V_{\text{SENSE}}$ )

### 2.2.2 UCC256301

LLC resonant converters are one of the most widely used topologies for implementing medium-to-high power isolated DC/DC power stages in industrial power supplies. These converters are popular due to their ability to achieve soft-switching (ZVS turnon) for the high-voltage MOSFET, improving the overall efficiency of the system.

LLC converters in industrial power supplies do face some specific requirements. Some industrial power supplies need to support an overload (up to 1.5 times the nominal load) for a short period of time. The LLC converter must not enter the capacitive (ZCS) region during the overload operation; otherwise, it can be catastrophic. With its ZCS avoidance feature, the UCC256301 can ensure that the system does not enter the ZCS region under all operating conditions, keeping the system safe. Apart from the overload (also known as power boost) functionality, industrial power supplies typically need a tunable output voltage with a wide range. For example, in a 24-V nominal output system, the output voltage can range from 22 to 28 V. The UCC256301 provides a wide operating frequency range from 35 kHz to 1 MHz to make it easier to design wide output voltage range using an LLC converter.

The UCC256301 with its unique hybrid hysteretic control provides excellent line and load transient response, minimizing the need for output filter capacitors. Its wide frequency range can be used to reduce the PFC bulk capacitor required to meet the holdup time requirement in the industrial power supplies. With the integrated high-voltage gate drive, X-capacitor discharge function, and addition output overvoltage protection, the UCC256301 reduces the amount of external discrete components required to implement a high-efficiency industrial power supply.

### 2.2.3 UCC24612-2

The UCC24612-2 is a multi-mode synchronous rectifier controller for active clamp flyback and LLC applications. With its 4-A sink and 1-A source capability, the proportional gate drive of the device helps in using this synchronous rectifier in LLC applications where the system can operate above the resonant frequency. The adaptive off-time feature adds robustness to the synchronous rectifier by preventing false triggering.

### 2.2.4 CSD19501KCS

The CSD19501KCS is an 80-V NexFET™ with 5.5-mΩ resistance and a 38-nC gate charge. In this reference design, the CSD19501KCS is used as the synchronous FET to lower the losses in the output stage of the LLC converter.

## 2.3 System Design Theory

This reference design provides universal AC mains powered, 480-W nominal output at 24 V and 20 A. This design is able to support a short-time overload of up to 720 W for > 3 seconds. The UCC28180 controls a PFC boost front end, while the UCC25630 LLC resonant half-bridge converts the PFC output to an isolated 24 V and 20 A. The total system efficiency is 93.2% with a 230-V AC input and over 91% with a 110-V AC input at full load. In addition, several protections are embedded into this design, which includes input undervoltage protection and output short-circuit protection.

Low EMI, high efficiency, a high power factor, and reliable power supply are the main focus of this design for targeted applications.

### 2.3.1 PFC Regulator Stage Design

For high power levels such as 500 W, either the single-phase CCM PFC or interleaved CrCM PFC can be preferred. CCM PFC has certain advantages at these power levels, such as a lower component count, reduced input peak currents, and simpler EMI filter requirements. CrCM PFC requires smaller PFC inductors and can use ultrafast diode for the PFC boost diode. CrCM PFC also have the advantage of enabling valley switching and ZCS turnon condition for the PFC MOSFET.

In this design, the CCM PFC is used as it enables a fixed frequency PFC implementation with reduced input peak currents, which helps reduce the cost.

The UCC28180 operates at fixed frequency in CCM mode and requires minimal external components for high-wattage PFC pre-regulator implementation. The design process and component selection for this design are illustrated in the following subsections.

#### 2.3.1.1 Design Parameters

表 2. Design Parameters for PFC Power Stage Design

PARAMETER		MIN	TYP	MAX	UNIT
<b>INPUT</b>					
$V_{IN}$	Input voltage	85	—	265	VAC
$f_{LINE}$	Input frequency	47	—	63	Hz
<b>OUTPUT</b>					
$V_{OUT}$	Output voltage	—	391		VDC
$P_{OUT(nom)}$	Output power	—	—	500	W
$P_{OUT(max)}$	Output power	—	—	750	W
—	Line regulation	—	—	5	%
—	Load regulation	—	—	5	%
PF	Targeted power factor	—	0.99	—	—
$\eta$	Targeted efficiency	—	97.5	—	%
$f_{sw}$	Mean switching frequency	—	70	—	kHz

#### 2.3.1.2 Current Calculations

The input fuse, bridge rectifier, and input capacitor are selected based upon the input current calculations. First, determine the maximum average output current,  $I_{OUT(max)}$ :

$$I_{OUT(max)} = \frac{P_{OUT(max)}}{V_{OUT(max)}} \quad (1)$$

$$I_{OUT(max)} = \frac{500}{390} = 1.28$$

The maximum input RMS line current,  $I_{INrms(max)}$ , is calculated using the parameters from 表 2 and the efficiency and power factor initial assumptions:

$$I_{INrms(max)} = \frac{P_{OUT(max)}}{\eta \times V_{IN(max)} \times PF} \quad (2)$$

$$I_{INrms(max)} = \frac{500}{0.94 \times 85 \times 0.99} = 6.32$$

### 2.3.1.3 Boost Inductor

To dimension the boost inductor, first calculate the maximum allowed ripple current. The maximum ripple current is observed at the lowest input voltage and maximum load. Assuming a maximum 25% ripple in the inductor current gives a ripple current:

$$I_{\text{Nripple(max)}} = \Delta\text{RIPPLE} \times I_{\text{Nrms(max)}} \quad (3)$$

$$I_{\text{Nripple(max)}} = 0.25 \times \sqrt{2} \times 6.32 = 2.23$$

The duty cycle,  $\text{DUTY}_{(\text{max})}$ , at the peak of the minimum input voltage can be calculated as:

$$\text{DUTY}_{(\text{max})} = \frac{V_{\text{OUT(max)}} - V_{\text{INrms(min)}} \times \sqrt{2}}{V_{\text{OUT(max)}}} \quad (4)$$

$$\text{DUTY}_{(\text{max})} = \frac{390 - (1.414 \times 85)}{390} = 0.691$$

The minimum value of the boost inductor is calculated based upon the acceptable ripple current,  $I_{\text{Nripple(max)}}$ , at a worst case duty cycle of 0.691:

$$L_{\text{Boost}} \geq V_{\text{OUT(max)}} \times \text{DUTY}_{(\text{max})} \times \frac{(1 - \text{DUTY}_{(\text{max})})}{f_{\text{SW}} \times I_{\text{RIPPLE(max)}}} \quad (5)$$

$$L_{\text{Boost}} \geq \frac{390 \times 0.691 \times (1 - 0.691)}{(950000 \times 2.23)} \geq 392 \mu\text{H}$$

The actual value of the boost inductor used is 420  $\mu\text{H}$ .

The required saturation current for the boost inductor is calculated using 公式 6 for the minimum input voltage and short-time maximum overload conditions.

$$I_{\text{L(max)}} = \left( \sqrt{2} \times \frac{P_{\text{OUT(max)}}}{V_{\text{INrms(min)}}} \right) \times \left( 1 + \frac{\Delta\text{RIPPLE}}{2} \right) = 11.3 \quad (6)$$

### 2.3.1.4 Output Capacitor

The output capacitor,  $C_{\text{OUT}}$ , is sized to meet the holdup requirements of the converter. The holdup time required by this design,  $T_{\text{Holdup}}$ , is 20 ms. During this time, the minimum voltage that the PFC output can reach at full load is designed to be  $V_{\text{OUT(min)}} = 290 \text{ V}$ . Substituting the known values in 公式 7, the minimum  $C_{\text{OUT}}$  is:

$$C_{\text{OUT}} \geq 2 \times P_{\text{OUT(nom)}} \times \frac{T_{\text{Holdup}}}{V_{\text{OUT(max)}}^2 - V_{\text{OUT(min)}}^2} \quad (7)$$

$$C_{\text{OUT(min)}} \geq \frac{2 \times 500 \times 20 \text{ ms}}{(390^2 - 290^2)} = 294 \mu\text{F}$$

The capacitor of 330  $\mu\text{F}$  is selected for use in this reference design.

### 2.3.1.5 Switching Element

The drain-to-source RMS current,  $I_{\text{DSrms}}$ , through the PFC MOSFET is calculated as:

$$I_{\text{DSrms}} = \frac{P_{\text{OUT(nom)}}}{\sqrt{2} \times V_{\text{INrms(min)}}} \times \sqrt{2 - \frac{16 \times V_{\text{INrms}} \times \sqrt{2}}{3 \times \pi \times V_{\text{OUT(max)}}}} \quad (8)$$

$$I_{DSrms} = \frac{500}{120} \times \sqrt{2 - \left( \frac{16 \times 120}{3\pi \times 390} \right)} = 5.05$$

Select a MOSFET with a low figure of merit for this application. The key specifications that are important for this topology are:

- Low  $R_{DSon}$ , for reducing the conduction losses in the MOSFET
- Low  $Q_G$ , for fast turnon and turnoff, both of which are hard switched in this topology
- Low output capacitance, to reduce  $C_{OSS}$  related losses

### 2.3.1.6 Boost Diode

The output diode must have a blocking voltage that exceeds the output overvoltage of the converter and average current same as  $I_{OUT(max)}$ . In CCM PFC topology, the boost diode undergoes hard turnoff and hence suffers from reverse recovery losses.

One way of reducing the reverse recovery loss is by using a silicon-carbide diode. In this design, the TRS6E65F diode is used.

### 2.3.1.7 Sense Resistor

To accommodate the gain of the nonlinear power limit, the sense resistor,  $R_{SENSE}$ , is sized such that it triggers the soft overcurrent at 10% higher than the maximum peak inductor current using the minimum soft overcurrent threshold of the ISENSE pin,  $V_{SOC}$ , of ISENSE equal to 0.265 V.

$$R_{SENSE} = \frac{V_{SOC(min)}}{I_{L(max)} \times 1.1} \tag{9}$$

$$R_{SENSE} = \frac{0.259 \text{ V}}{11.3 \text{ A} \times 1.1} = 0.02 \Omega = R41$$

### 2.3.1.8 Control Loop Compensation

The voltage error amplifier is compensated with a zero,  $f_{ZERO}$ , at the  $f_{PWM\_PS}$  pole, and a pole,  $f_{POLE}$ , is placed at 20 Hz to reject high-frequency noise and roll off the gain amplitude. The overall voltage loop crossover,  $f_v$ , is desired to be at 10 Hz. The compensation components of the voltage error amplifier are selected accordingly.

## 2.3.2 LLC Converter Stage Design

The DC/DC stage in an industrial AC/DC converter needs to support a wide output voltage range and a hold up time > 20 ms. Combined with the need to meet the short time power boost feature, the LLC-based DC/DC stage needs to be designed with sufficient gain and proper operating point to maximize efficiency.

Because this DC/DC stage supports a nominal output power of 480 W and a peak output power of 720 W, designing the DC/DC stage for 720-W operation does not give an optimum performance at 480 W. While designing for 480 W, take care in dimensioning the resonant tank components such that the system does not enter into the capacitive region of operation at 720 W.

The hybrid hysteretic mode control and ZCS avoidance of the UCC256301 helps in developing a robust LLC power stage for use in these applications.



**表 3. Design Parameters for LLC Power Stage Design**

PARAMETER		MIN	TYP	MAX	UNIT
<b>INPUT</b>					
$V_{\text{INDC}}$	Input voltage	300	397	410	VDC
<b>OUTPUT</b>					
$V_{\text{OUT}}$	Output voltage	—	24	—	VDC
$P_{\text{LIMIT}}$	Output power limit	—	—	720	W
$P_{\text{OUT}}$	Max output power	—	480	—	W
$f_{\text{SW(nom)}}$	Nominal switching frequency	—	80	—	kHz
—	Line regulation	—	1	—	%
—	Load regulation	—	1	—	%
$\eta$	Targeted efficiency	—	0.97	—	—

### 2.3.2.1 Determine $M_g$ (Voltage Gain)

The transformer turns ratio is determined by 公式 10.

$$n = M_g \times \frac{V_{\text{DCIN(nom)}}}{2V_0} \quad (10)$$

Where  $M_g$  is the voltage gain ( $M_g = 0.9$ ).

From these specifications, the nominal values for input voltage and output voltage are 390 V and 24 V, respectively. As a result, the turns ratio can be calculated as:

$$n = M_g \times \left( \frac{V_{\text{DCIN(nom)}}}{2V_0} \right) = 7.32 \quad (11)$$

#### 2.3.2.1.1 Determine $M_{g(\min)}$ and $M_{g(\max)}$

$M_{g(\min)}$  and  $M_{g(\max)}$  can be determined by using 公式 12 and 公式 13, respectively:

$$M_{g(\min)} = n \times \left( \frac{V_{0(\min)}}{V_{\text{DCIN(max)}}} \right) \quad (12)$$

$$M_{g(\min)} = 7.32 \times \left( \frac{22 \text{ V}}{410 \text{ V}} \right) = 0.766$$

$$M_{g(\max)} = n \times \left( \frac{V_{0(\max)}}{V_{\text{DCIN(min)}}} \right) \quad (13)$$

$$M_{g(\max)} = 7.32 \times \left( \frac{\frac{28 \text{ V}}{300 \text{ V}}}{2} \right) = 1.366$$

The dimensioned  $M_{g(\max)}$  is increased to 1.1 times the required value to handle the power boost functionality =  $M_{g(\max)} = 1.1 \times 1.366 \approx 1.5$ .

### 2.3.2.2 Determine Equivalent Load Resistance ( $R_e$ ) of Resonant Network

The equivalent load resistance at nominal and peak load under nominal output voltage and peak output voltage are derived in this section.

$$R_e = \frac{8 \times n^2}{\pi^2} \times \left( \frac{V_{0(nom)}}{I_{0(nom)}} \right) \quad (14)$$

$$R_{e(nom)} = \frac{8 \times 7.7^2}{\pi^2} \times \left( \frac{24}{20} \right) = 57.7 \Omega$$

Under peak load conditions of 30 A at a 24-V output, the equivalent load resistance is given by 公式 15:

$$R_{e\_pk} = \frac{8 \times n^2}{\pi^2} \times \left( \frac{V_{0(nom)}}{I_{0\_pk}} \right) \quad (15)$$

$$R_{e\_pk} = \frac{8 \times 7.7^2}{\pi^2} \times \left( \frac{24}{20} \right) = 38.48 \Omega$$

Similarly, the equivalent load resistance at the maximum output voltage is  $V_{O\_pk} = 28$  V.

$$R_{e(maxV)} = \frac{8 \times 7.7^2}{\pi^2} \times \left( \frac{28}{17.2} \right) = 78.31 \Omega \quad (16)$$

### 2.3.2.3 Select $L_m/L_r$ Ratio ( $L_n$ ) and $Q_e$

The second resonance point for the LLC converter is set at close to 75 kHz. By choosing a value of  $L_r = 47 \mu\text{H}$  and  $C_r = 94 \text{ nF}$ , calculate the value of the resonant frequency to be using 公式 17:

$$F_r = \frac{1}{2 \times \pi \sqrt{L_r \times C_r}} = 75.75 \text{ kHz} \quad (17)$$

The magnetizing inductance to resonant inductance ratio is chosen as 6 to develop sufficient gain while minimizing the magnetizing current in the LLC transformer. By using an integrated magnetics approach, the  $L_r$  is realized as the leakage inductor of the main LLC transformer.

The Q curves for this design at different corner conditions are depicted in 图 2. The corner conditions operate at a 28-V output with 480-W output power and at 24-V output with 720-W peak power. The Q curve for the 24-V output and 480-W output power is also plotted for reference.



图 2. Q Curves at Various Normal and Boundary Operating Conditions

### 2.3.2.4 Determine Primary-Side Currents

The primary-side RMS load current ( $I_{PRI}$ ) at full load is determined from 公式 18:

$$I_{pri} = \frac{\pi}{2\sqrt{2}} \times \left(\frac{I_o}{n}\right) \tag{18}$$

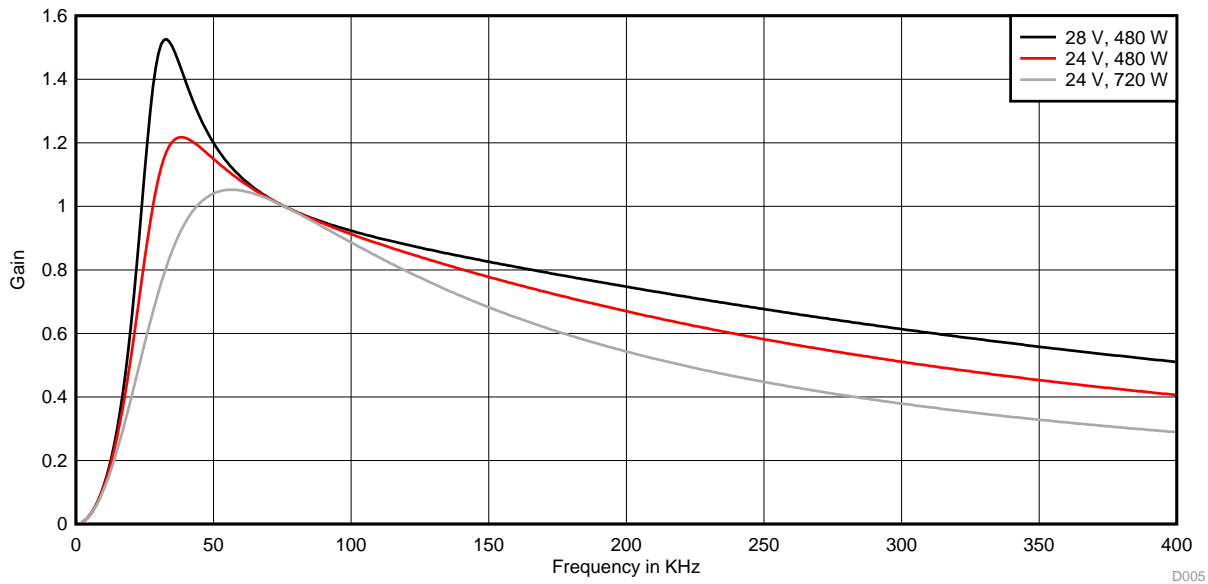
$$I_{pri} = 1.11 \times \left(\frac{20}{7.7}\right) = 2.883$$

The RMS magnetizing current ( $I_M$ ) at  $f_{SW(min)} = 50$  kHz is determined from 公式 19:

$$I_m = \left(\frac{2\sqrt{2}}{\pi}\right) \times \left(\frac{7.7 \times 28}{2 \times \pi \times 50 \text{ kHz} \times 280 \mu\text{H}}\right) = 2.202 \tag{19}$$

The resonant circuit's current ( $I_r$ ) is determined from 公式 20:

$$I_r = \sqrt{I_m^2 + I_{pri}^2} \tag{20}$$

$$I_r = \sqrt{2.883^2 + 2.208^2} = 3.63$$

This is also the transformer's primary winding current at  $f_{SW(min)}$ .

### 2.3.2.5 Determine Secondary-Side Currents

The secondary-side RMS currents can be calculated from the average load current:

$$I_{sec} = 20 \tag{21}$$

Assuming the LLC power stage is operating at close to its second resonant frequency, the average current through each rectifier in the secondary-side push-pull output is given as:

$$I_{sec\_avg} = 10 \tag{22}$$

The corresponding half-wave RMS current is:

$$I_{sec\_rms} = I_{sec} \times \frac{\pi}{4} = 15.7 \tag{23}$$

### 2.3.2.6 Select Primary Side MOSFETs

Each MOSFET sees the input voltage as its maximum applied voltage:

$$V_{DS} = 1.2 \times V_{INDC(max)} = 1.2 \times 410 = 492 \text{ V} \rightarrow 500 \quad (24)$$

For the LLC power stage to work in ZVS, the turnon losses can be neglected. Choose the MOSFET based on  $R_{DS\_ON}$  and  $C_{OSS}$ . Optimizing  $C_{OSS}$  helps in minimizing the dead time required for achieving ZVS, thereby minimizing duty cycle loss.

For this design, the IPP60R190P6 MOSFET is used. The UCC256301's adaptive dead-time optimization feature helps in maximizing the duty cycle, which improves efficiency.

### 2.3.2.7 Select Secondary-Side MOSFETs

The diode rectifier voltage rating is determined as:

$$V_{DS\ max\_sec} = 1.2 \times 2 V_{OUT(max)} = 1.2 \times 2 \times 28 = 67.2 \quad (25)$$

The MOSFET's current rating is determined as:

$$I_{sec\_rms} = 15.7 \quad (26)$$

TI's 80-V NexFET CSD19501KCS with its low  $R_{DS\_ON}$  ( $< 5.5 \text{ m}\Omega$ ) and  $Q_g$  ( $< 38 \text{ nC}$ ) is used in this reference design. The very low  $R_{DSon}$  of the TI NexFET helps in reducing the overall loss in the synchronous rectifier.

## 2.3.3 Components for UCC256301 Controller

This section explains the selection of certain components for the LLC power stage controlled by the UCC256301.

### 2.3.3.1 Soft Start

The UCC256301 is configured to give a maximum of a 400-ms soft start period. During startup, the soft-start capacitor is charged using the 25- $\mu\text{A}$  current source internally. The UCC256301 exits soft start when the closed loop control takes over or when the voltage on the soft-start capacitor reaches 7 V. The value of the soft-start capacitor is selected using [公式 27](#).

$$C_{SS} = C31 = 400 \text{ ms} \times \frac{25 \mu\text{A}}{7 \text{ V}} = 1.5 \mu\text{F} \quad (27)$$

### 2.3.3.2 Current Sense Circuit

The overcurrent limit OCP3 is set to trigger at 1.2 times the peak overload capability of the system.

$$V_{ISNSFullload} = \frac{OCP3}{1.2} = \frac{0.6}{1.2} = 0.5 \quad (28)$$

The current sense ratio is then calculated as:

$$K_{ISNS} = \frac{V_{ISNSFullload}}{\left(\frac{P_{OUT(max)}}{\eta}\right) \times \left(\frac{1}{V_{Bulk}}\right)} = \frac{0.5}{(757) \times \left(\frac{1}{390}\right)} = 0.257 \quad (29)$$

Select the current sense capacitor using:

$$C_{ISNS} = C39 = 150 \text{ p} \quad (30)$$

As a result:

$$R_{\text{ISNS}} = R3 = K_{\text{ISNS}} \times \frac{C_r}{C_{\text{ISNS}}} = 0.257 \times \frac{94 \times 10^{-9}}{150 \times 10^{-12}} = 161 \quad (31)$$

The R3 is selected as 162  $\Omega$ .

### 2.3.3.3 Overvoltage Protection (BW Pin)

The BW pin senses the output voltage through the bias winding mounted on the LLC transformer. This pin can be used to provide an additional overvoltage protection in the system. In this reference design, the bias winding has 0.6 times the turns of the secondary winding, and the overvoltage protection is set at 35 V. At this point, the bias winding voltage is at 21 V. Now the BW pin potential divider is set in such a way that it sees 4 V at a 35-V output.

Use [公式 32](#) to select:

$$R_{\text{BWLLOWER}} = R12 = 10 \quad (32)$$

As a result:

$$R_{\text{BWUPPER}} = R17 = R12 \times \frac{21 \text{ V} - 4 \text{ V}}{4 \text{ V}} = 42.5 \quad (33)$$

### 2.3.4 Bias Power Supply

The [TIDA-01503 reference design](#), a 20-W auxiliary power supply based on the UCC28704, is used in this reference design to provide the bias power to the PFC, LLC, SR, and other logic circuits on the board. The converter is powered from the output of the PFC pre-regulator stage and must be able to start up prior to the PFC stage being operational. For this reason, the circuit is designed to operate over a wide input voltage, 100- to 450-V DC. The flyback transformer has three output windings, which are isolated to each other.

## 3 Hardware, Testing Requirements, and Test Results

### 3.1 Required Hardware

#### 3.1.1 Test Conditions

For input conditions:

- $V_{IN}$ : 85- to 265-V AC
- $I_{IN}$ : Current limit to 8 A

For output conditions:

- $V_{OUT}$ : 22 to 28 V
- $I_{OUT}$ : 0 to 20 A (nominal), 30-A overload

#### 3.1.2 Equipment Needed

- Isolated AC source
- Single-phase power analyzer
- Digital oscilloscope
- Multimeters
- Electronic load

#### 3.1.3 Procedure

1. Adjust the R77 potentiometer to set for a 24-V output.
2. Connect input terminals (connector J3) of the reference board to the AC power source.
3. Connect output terminals (connector J2) to electronic load, maintaining correct polarity.
4. Set minimum load of about 50 mA.
5. Gradually increase the input voltage from 0 V to a turnon voltage of 85-V AC. As the input voltage crosses 85 V, the PFC section starts working and boost the PFC output to 390-V DC.
6. Observe the startup conditions for smooth switching waveforms.
7. As the PFC output voltage crosses 310 V, the LLC section starts working and the output voltage is developed.

### 3.2 Testing and Results

#### 3.2.1 Efficiency and Regulation

This section shows the efficiency, power factor, iTHD, and load regulation results at 115-V and 230-V AC input conditions.

The following figures show the graphs for efficiency, power factor, iTHD, and load regulation, respectively.



图 3. Efficiency Data



图 4. Power Factor Data

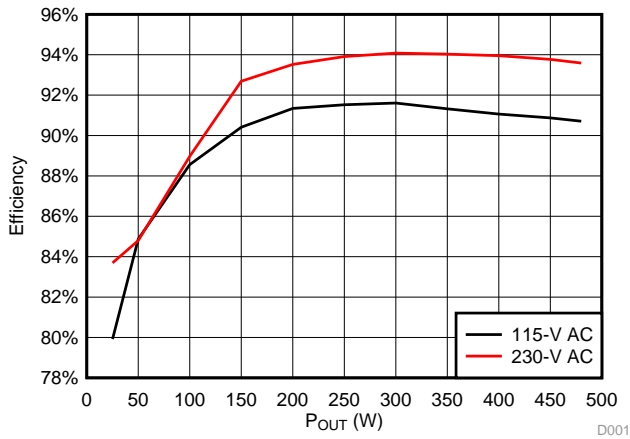

图 5. iTHD Data

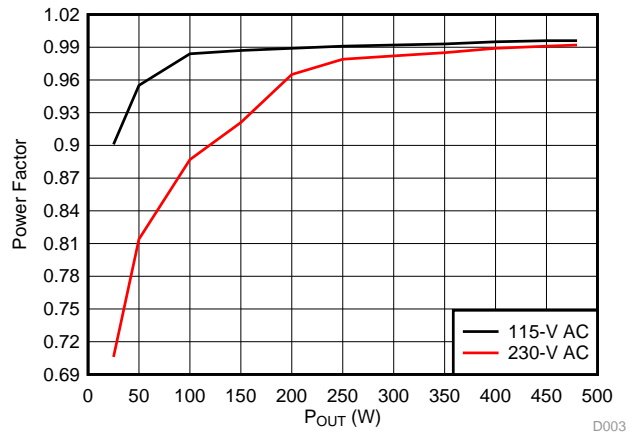

图 6. Load Regulation Data

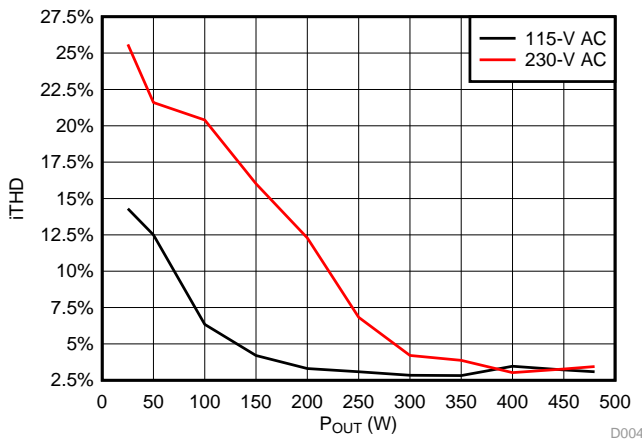

### 3.2.2 Startup Waveform

The startup waveform showing the 24-V output voltage and the input AC current is shown in 图 7. 图 8 shows the same waveform zoomed in.

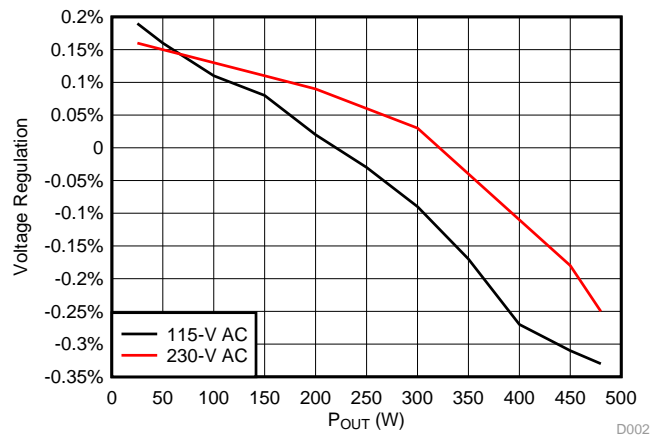

图 7. Startup Waveform at 230-V AC



图 8. Startup Waveform at 230-V AC (Zoomed In)

### 3.2.3 Load Transient Response

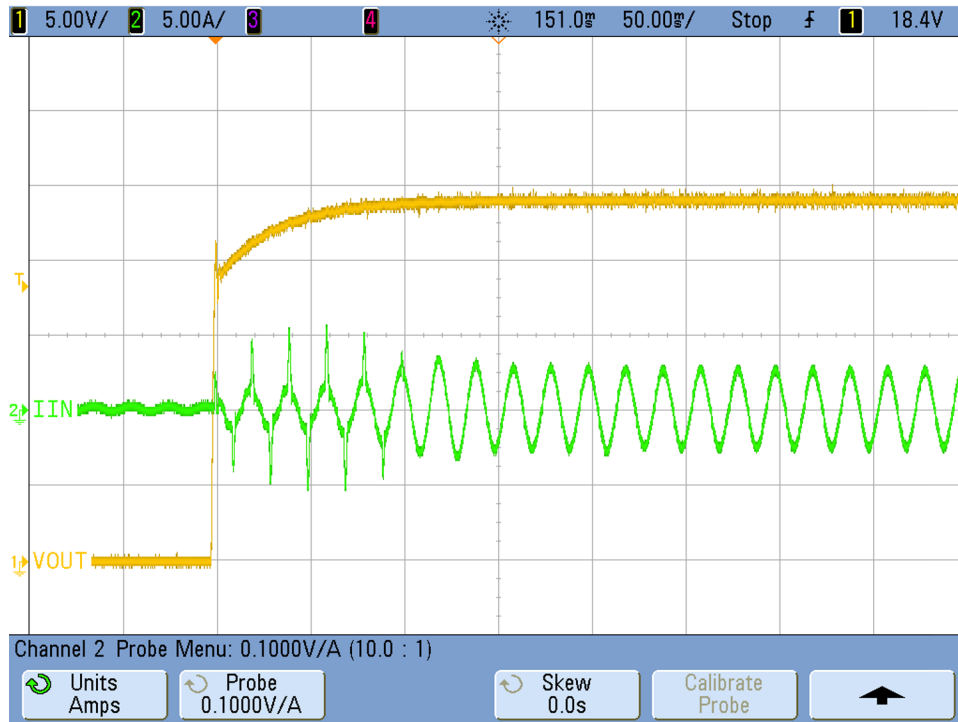
图 9 显示了系统的瞬态响应，当 24-V 输出负载从 4 A 到 20 A 以 500 mA/μC 的斜率变化时。最大电压跌落为 200 mV。

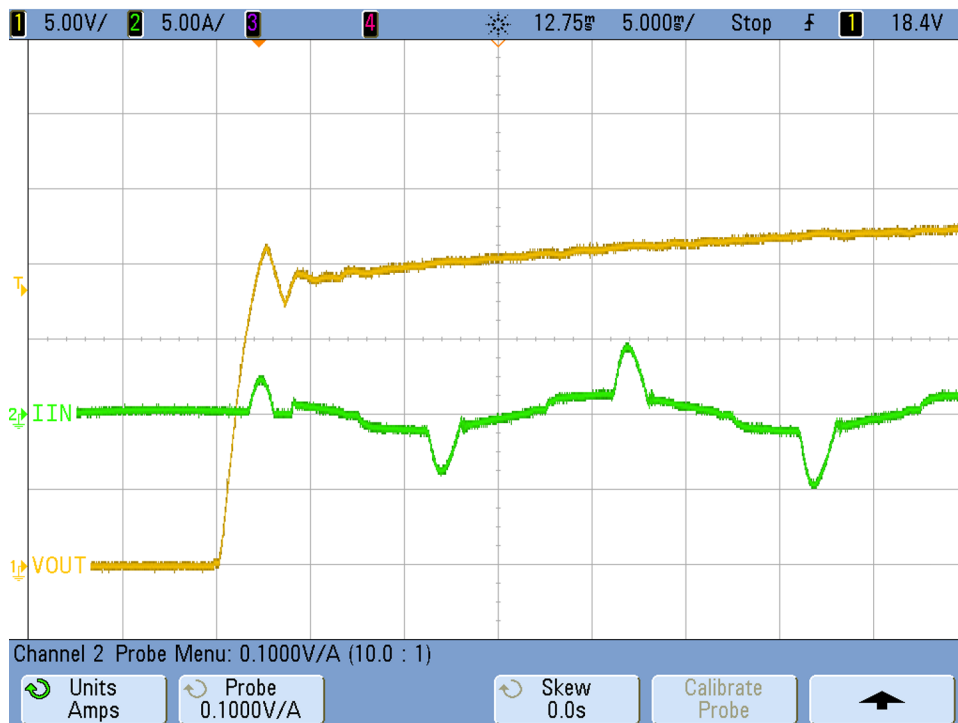

图 9. Transient Response at 24-V Output

### 3.2.4 PFC MOSFET Switching Waveforms

This sections shows the PFC MOSFET turnon and turnoff switching waveforms in 图 10 and 图 11, respectively.

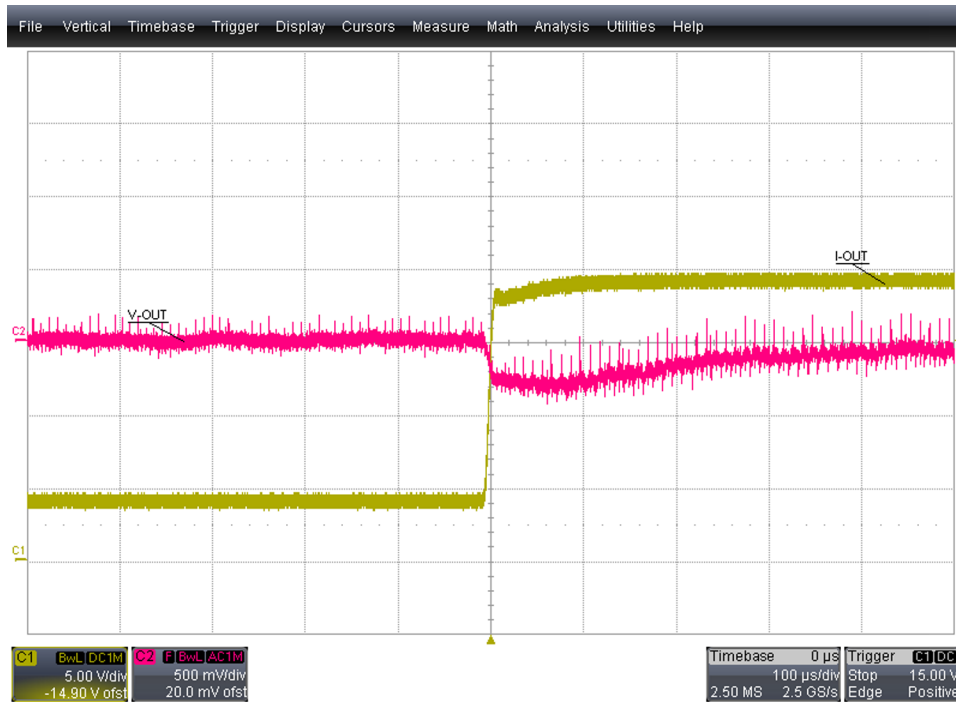

图 10. PFC MOSFET Turnon Waveform



图 11. PFC MOSFET Turnoff Waveform

### 3.2.5 LLC Primary-Side Switching Waveform

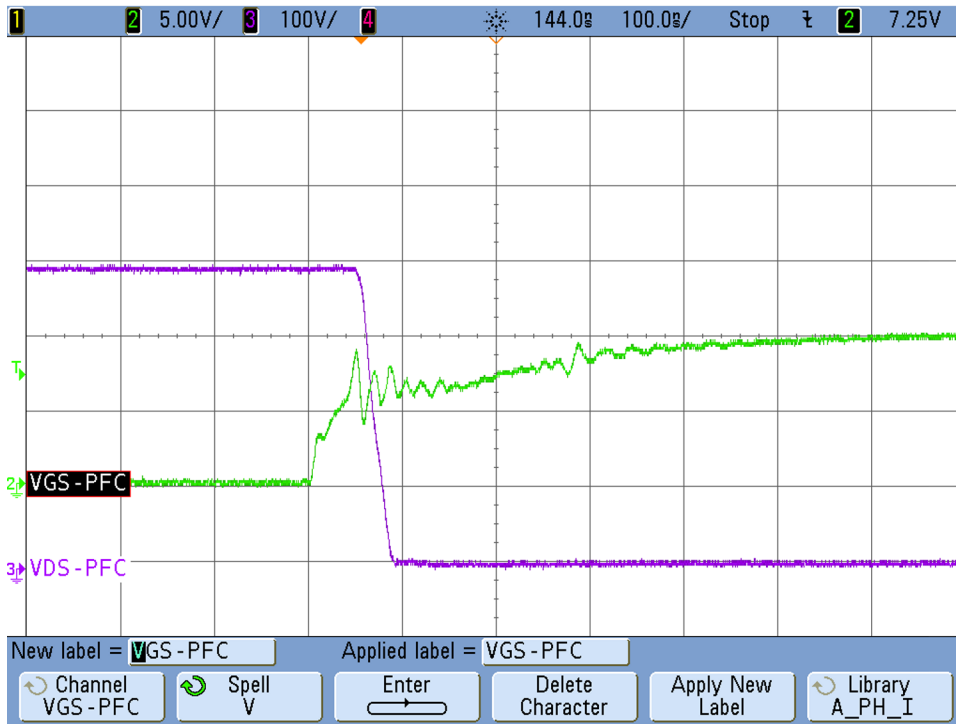
The primary-side switching waveform of the LLC stage depicting the tank current and low-side PWM is shown in 图 12.

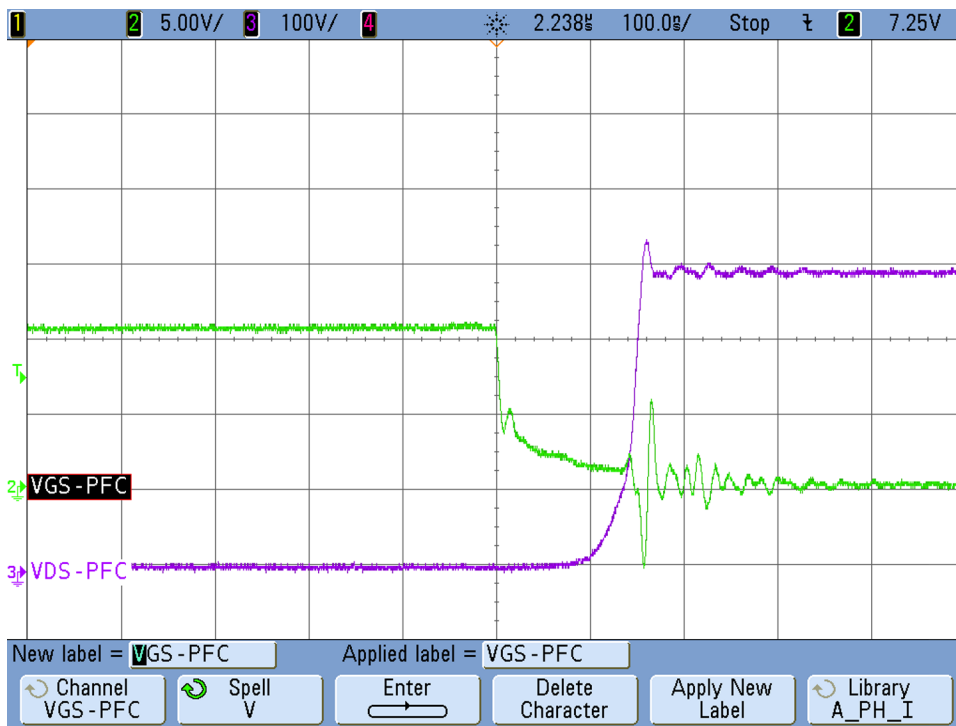

图 12. LLC Tank Current and Low-Side PWM

### 3.2.6 LLC Secondary-Side Synchronous Drive Waveform

The synchronous MOSFET and the synchronous drive output waveforms are shown in the following figures. 图 13 shows the  $V_{DS}$  of the synchronous MOSFET and the proportional gate drive output of the UCC24612-2. 图 14 and 图 15 show the zoomed-out synchronous MOSFET turnon and turnoff waveforms, respectively. The synchronous driver turns the synchronous MOSFET on within 150 ns of its body diode conducting and it turns off slightly before and intentionally lets the body diode conduct for a short period so as to avoid shoot-through and current reversal.

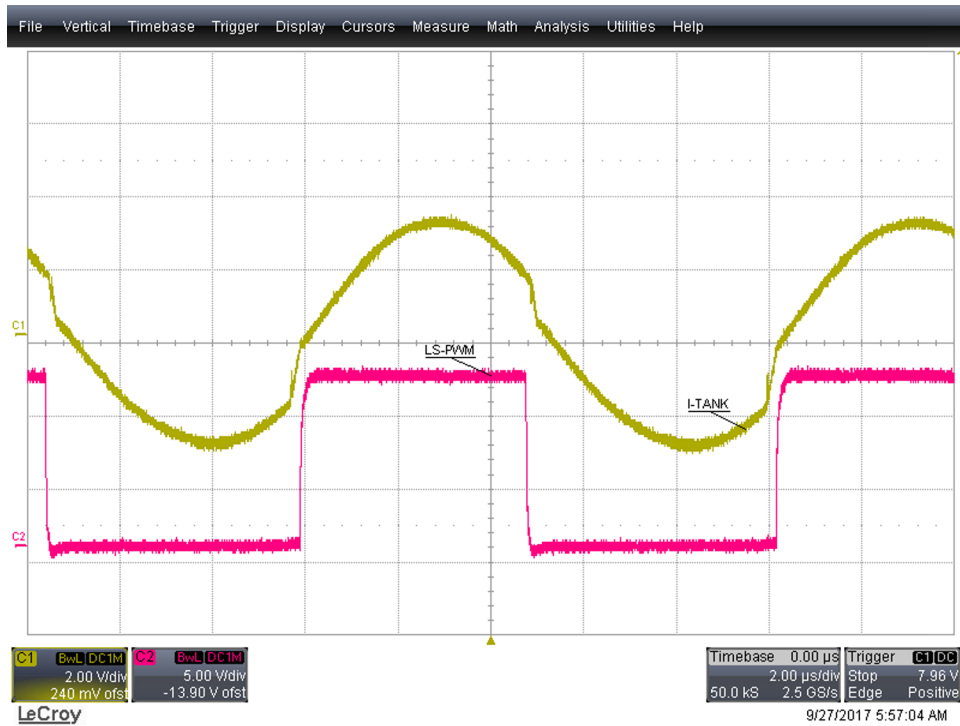

图 13. Synchronous MOSFET  $V_{DS}$  and Proportion Gate Drive Signal



图 14. Synchronous MOSFET Turnon

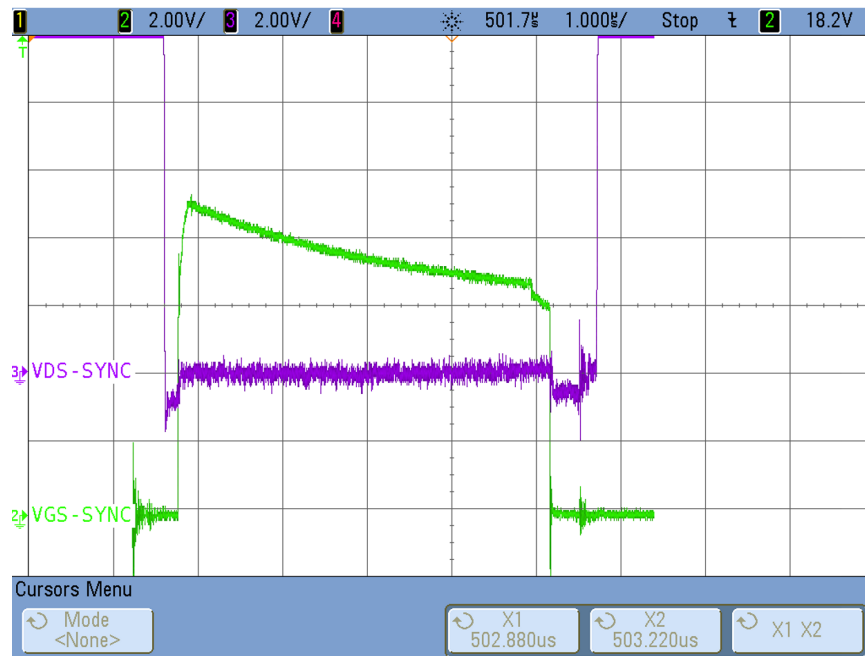

图 15. Synchronous MOSFET Turnoff

### 3.2.7 Short-Time 720-W Peak Output

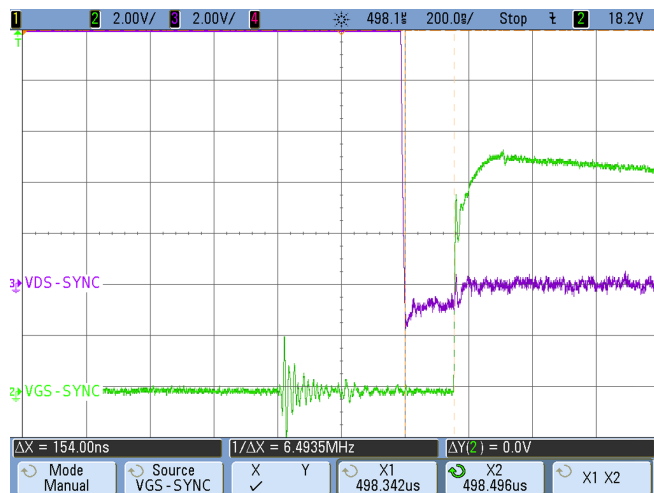
The output power capability of the short-time peak is shown in 图 16.

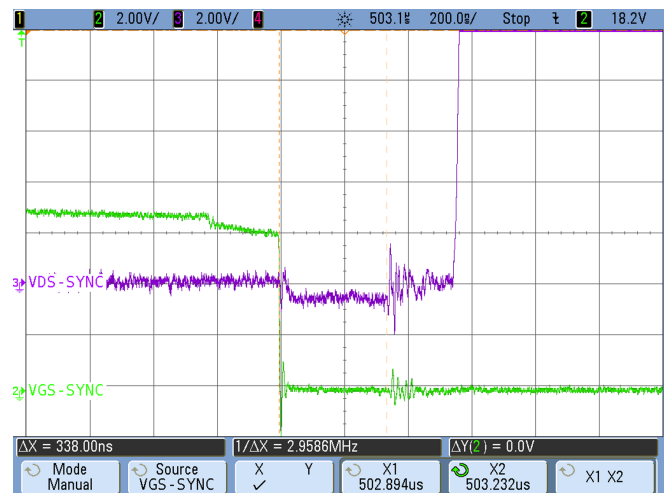

图 16. 720-W Peak Output Power Capability at 24-V Output

For 3 seconds, the system can support up to 720 W. Do not continuously load this reference design beyond 480 W.

### 3.2.8 Thermal Image

The thermal image of the board working at full load under natural convection cooling is shown in 图 17.

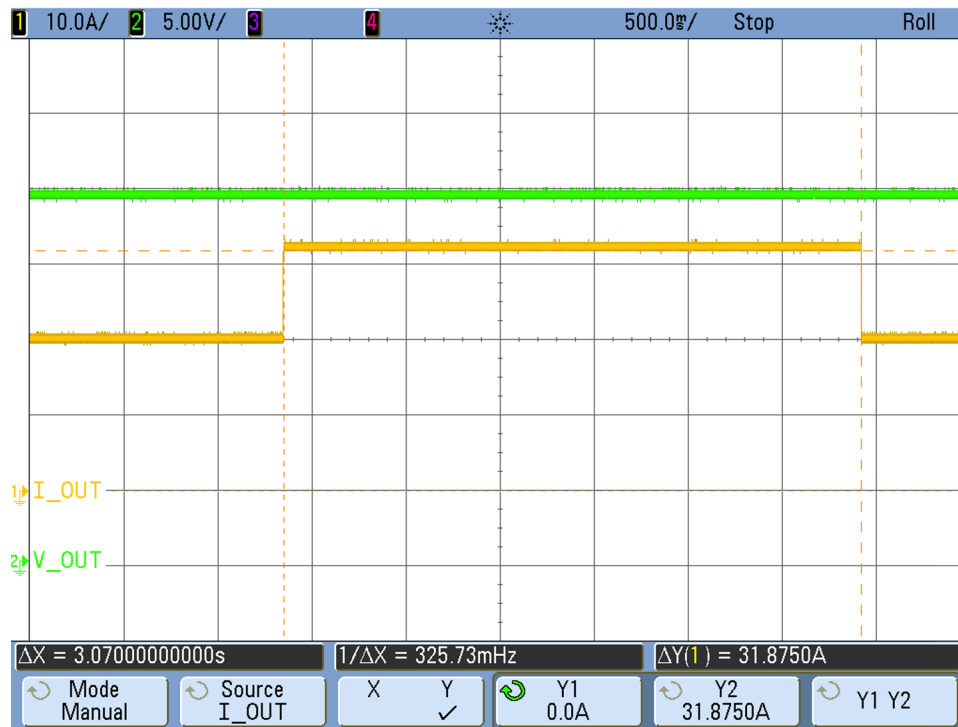

图 17. Thermal Image at 230-V AC Input and 480-W Load

表 4 shows the temperature on the main components on the board.

表 4. Temperature of Major Components at 230-V AC, 480-W Output

COMPONENT	TEMPERATURE
Diode bridge	56.8°C
PFC MOSFET	56.4°C
PFC diode	52.2°C
HB-LLC HV MOSFET	54.2°C, 46.4°C
HB-LLC synchronous MOSFET	46.9°C, 42.5°C
PFC choke	59.9°C
HB-LLC transformer	79.8°C (secondary), 79.4°C (primary), 55.3°C (core)

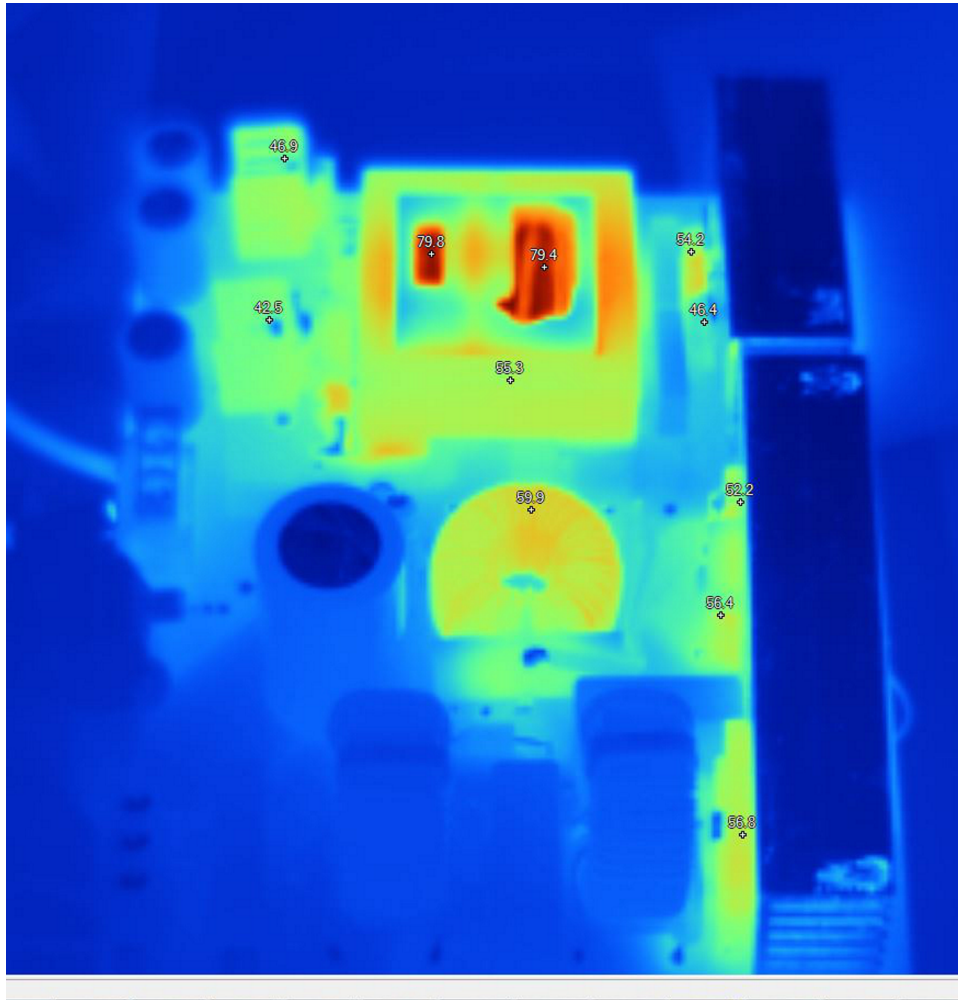
## 4 Design Files

### 4.1 Schematics

To download the schematics, see the design files at [TIDA-01494](#).

### 4.2 Bill of Materials

To download the bill of materials (BOM), see the design files at [TIDA-01494](#).

### 4.3 PCB Layout Recommendations

#### 4.3.1 Layout Prints

To download the layer plots, see the design files at [TIDA-01494](#).

### 4.4 Altium Project

To download the Altium project files, see the design files at [TIDA-01494](#).

### 4.5 Gerber Files

To download the Gerber files, see the design files at [TIDA-01494](#).

### 4.6 Assembly Drawings

To download the assembly drawings, see the design files at [TIDA-01494](#).

## 5 Software Files

To download the software files, see the design files at [TIDA-01494](#).

## 6 Related Documentation

1. Texas Instruments, [Designing an LLC Resonant Half-Bridge Power Converter](#), Power Supply Design Seminar (SLUP263)
2. Texas Instruments, [Feedback Loop Design of an LLC Resonant Power Converter](#), Application Report (SLUA582)
3. Texas Instruments, [UCC256301 Hybrid Hysteretic Mode Wide VIN LLC Resonant Controller Enabling Ultra-Low Standby Power](#), Datasheet (SLUSCU6)

### 6.1 商标

E2E, NexFET are trademarks of Texas Instruments.

ENERGY STAR is a registered trademark of U.S. Environmental Protection Agency.

All other trademarks are the property of their respective owners.

## 7 About the Author

**RAMKUMAR S** is a systems engineer at Texas Instruments, where he is responsible for developing reference design solutions for the industrial segment. Ramkumar brings his diverse experience in analog and digital power supplies design to this role. Ramkumar earned his master of technology (M.Tech) from the Indian Institute of Technology in Delhi.



## 有关 TI 设计信息和资源的重要通知

德州仪器 (TI) 公司提供的技术、应用或其他设计建议、服务或信息，包括但不限于与评估模块有关的参考设计和材料（总称“TI 资源”），旨在帮助设计人员开发整合了 TI 产品的应用；如果您（个人，或如果是代表贵公司，则为贵公司）以任何方式下载、访问或使用了任何特定的 TI 资源，即表示贵方同意仅为该等目标，按照本通知的条款进行使用。

TI 所提供的 TI 资源，并未扩大或以其他方式修改 TI 对 TI 产品的公开适用的质保及质保免责声明；也未导致 TI 承担任何额外的义务或责任。TI 有权对其 TI 资源进行纠正、增强、改进和其他修改。

您理解并同意，在设计应用时应自行实施独立的分析、评价和判断，且应全权负责并确保应用的安全性，以及您的应用（包括应用中使用的 TI 产品）应符合所有适用的法律法规及其他相关要求。就您的应用声明，您具备制订和实施下列保障措施所需的一切必要专业知识，能够 (1) 预见故障的危险后果，(2) 监视故障及其后果，以及 (3) 降低可能导致危险的故障几率并采取适当措施。您同意，在使用或分发包含 TI 产品的任何应用前，您将彻底测试该等应用和该等应用所用 TI 产品的功能而设计。除特定 TI 资源的公开文档中明确列出的测试外，TI 未进行任何其他测试。

您只有在为开发包含该等 TI 资源所列 TI 产品的应用时，才被授权使用、复制和修改任何相关单项 TI 资源。但并未依据禁止反言原则或其他法律授予您任何 TI 知识产权的任何其他明示或默示的许可，也未授予您 TI 或第三方的任何技术或知识产权的许可，该等许可包括但不限于任何专利权、版权、屏蔽作品权或与使用 TI 产品或服务的任何整合、机器制作、流程相关的其他知识产权。涉及或参考了第三方产品或服务的信息不构成使用此类产品或服务的许可或与其相关的保证或认可。使用 TI 资源可能需要您向第三方获得对该等第三方专利或其他知识产权的许可。

TI 资源系“按原样”提供。TI 兹免除对 TI 资源及其使用作出所有其他明确或默示的保证或陈述，包括但不限于对准确性或完整性、产权保证、无复发故障保证，以及适销性、适合特定用途和不侵犯任何第三方知识产权的任何默认保证。

TI 不负责任何申索，包括但不限于因组合产品所致或与之有关的申索，也不为您辩护或赔偿，即使该等产品组合已列于 TI 资源或其他地方。对因 TI 资源或其使用引起或与之有关的任何实际的、直接的、特殊的、附带的、间接的、惩罚性的、偶发的、从属或惩戒性损害赔偿，不管 TI 是否获悉可能会产生上述损害赔偿，TI 概不负责。

您同意向 TI 及其代表全额赔偿因您不遵守本通知条款和条件而引起的任何损害、费用、损失和/或责任。

本通知适用于 TI 资源。另有其他条款适用于某些类型的材料、TI 产品和服务的使用和采购。这些条款包括但不限于适用于 TI 的半导体产品 (<http://www.ti.com/sc/docs/stdterms.htm>)、[评估模块](http://www.ti.com/sc/docs/sampters.htm)和样品 (<http://www.ti.com/sc/docs/sampters.htm>) 的标准条款。

邮寄地址：上海市浦东新区世纪大道 1568 号中建大厦 32 楼，邮政编码：200122  
Copyright © 2018 德州仪器半导体技术（上海）有限公司