

TPS56x200 采用 6 引脚 SOT-23 封装的 4.5V 至 17V 输入、2A、3A 同步降压稳压器

1 特性

- TPS562200 - 集成有 122mΩ 和 72mΩ FET 的 2A 转换器
- TPS563200 - 集成有 68mΩ 和 39mΩ FET 的 3A 转换器
- 可实现快速瞬态响应的 D-CAP2™ 控制拓扑
- 输入电压范围：4.5V 至 17V
- 输出电压范围：0.76V 至 7V
- 开关频率：650 kHz
- 高级 Eco-Mode 脉冲跳跃
- 低关断电流（低于 10μA）
- 1% 反馈电压精度 (25°C)
- 从预偏置输出电压启动
- 逐周期过流限制
- 断续模式欠压保护
- 非锁存 OVP、UVLO 和 TSD 保护
- 固定软启动：1ms
- 使用 [TPS563252](#) 在更小的封装中实现更高的效率和频率
- 使用 [WEBENCH®](#) 工具创建定制设计

2 应用

- 数字电视电源
- 高清蓝光光盘™ 播放器
- 网络家庭终端设备
- 数字机顶盒 (STB)

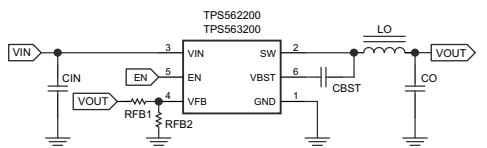

Copyright © 2016, Texas Instruments Incorporated

简化原理图

3 说明

TPS562200 和 TPS563200 是采用 6 引脚 SOT-23 封装的简单易用型 2A 和 3A 同步降压转换器。

此器件被优化为使用尽可能少的外部组件即可运行，并且可以实现低待机电流。

这些开关模式电源 (SMPS) 器件采用 D-CAP2 控制拓扑，从而提供快速瞬态响应，并且在无需外部补偿组件的情况下支持专用聚合物等低等效串联电阻 (ESR) 输出电容器以及超低 ESR 陶瓷电容器。

TPS562200 和 TPS563200 可在高级 Eco-mode 下运行，从而能在轻载运行期间保持高效率。这些器件采用 6 引脚 1.6mm × 2.9mm SOT (DDC) 封装，额定工作环境温度范围为 -40°C 至 85°C。

器件信息(1)

器件型号	输出电流 (最大值)	封装
TPS562200	2A	DRL (SOT-236, 6)
TPS563200	3A	

(1) 如需了解所有可用封装，请参阅数据表末尾的可订购产品附录。

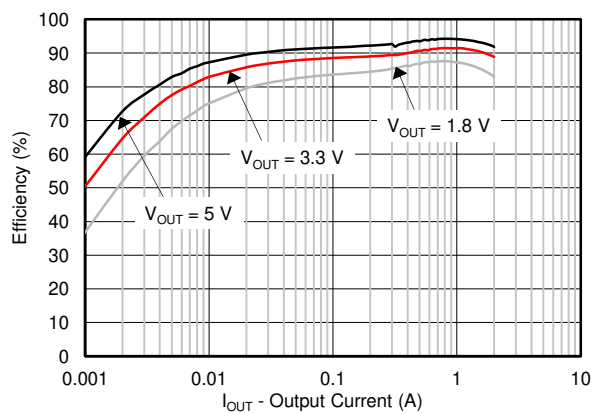

Tps562200 效率



Table of Contents

1 特性.....	1	7.3 Feature Description.....	13
2 应用.....	1	7.4 Device Functional Modes.....	14
3 说明.....	1	8 Application and Implementation.....	15
4 Revision History.....	2	8.1 Application Information.....	15
5 Pin Configuration and Functions.....	4	8.2 Typical Applications.....	15
6 Specifications.....	5	8.3 Power Supply Recommendations.....	26
6.1 Absolute Maximum Ratings ⁽¹⁾	5	8.4 Layout.....	26
6.2 ESD Ratings.....	5	9 Device and Documentation Support.....	28
6.3 Recommended Operating Conditions.....	5	9.1 Device Support.....	28
6.4 Thermal Information.....	6	9.2 接收文档更新通知.....	28
6.5 Electrical Characteristics.....	7	9.3 支持资源.....	28
6.6 Timing Requirements.....	7	9.4 Trademarks.....	28
6.7 Typical Characteristics TPS562200.....	8	9.5 静电放电警告.....	28
6.8 Typical Characteristics TPS563200.....	10	9.6 术语表.....	28
7 Detailed Description.....	12	10 Mechanical, Packaging, And Orderable Information.....	28
7.1 Overview.....	12		
7.2 Functional Block Diagram.....	12		

4 Revision History

注：以前版本的页码可能与当前版本的页码不同

Changes from Revision D (June 2016) to Revision E (May 2023)	Page
• 更新了整个文档中的表格、图和交叉参考的编号格式.....	1
• 添加了 TPS563252 信息.....	1
• 更新了商标信息.....	1
• 通篇去除了图像的颜色.....	1
Changes from Revision C (August 2015) to Revision D (June 2016)	Page
• Updated the Pinout image in <i>Pin Configuration And Functions</i>	4
• Changed $R_{\theta_{JB}}$ for TPS562200 From: 3.4 To: 13.4 in <i>Thermal Information</i>	6
• 节 7.3.1, changed text From: "proportional to the converter input voltage, V_{IN} , and inversely proportional to the output voltage, V_O " To: "inversely proportional to the converter input voltage, V_{IN} , and proportional to the output voltage, V_O ".....	13
Changes from Revision B (July 2014) to Revision C (August 2015)	Page
• 将 <i>特性</i> 部分从“集成 122mΩ 和 72mΩ FET ('562200)”更改为“TPS562200 - 集成有 122mΩ 和 72mΩ FET 的 2A 转换器”.....	1
• 将 <i>特性</i> 部分从“集成 68mΩ 和 39mΩ FET ('563200)”更改为“TPS563200 - 集成有 68mΩ 和 39mΩ FET 的 3A 转换器”.....	1
• 添加了 节 1：650kHz 开关频率.....	1
• 将 <i>特性</i> 部分从“逐周期间断过流限制”更改为：逐周期过流限制.....	1
• 添加了 <i>特性</i> ：断续模式欠压保护.....	1
• 将“说明”第一段中的文本从“采用 SOT-23 封装...”修改为“采用 6 引脚 SOT-23 封装...”.....	1
• Moved Storage temperature range, T_{stg} From: <i>Handling Ratings</i> To: <i>Absolute Maximum Ratings</i>	5
• Changed the <i>Handling Ratings</i> table to the <i>ESD Ratings</i> table.....	5
• Changed the TPS562200 <i>Thermal Information</i> values.....	6
• Changed V_{OVP} Description in the <i>Electrical Characteristics</i> From: OVP Detect (L > H) To: OVP Detect, and the TYP value From: 125% To: 125% x Vfbth.....	7
• Changed V_{UVP} Description in the <i>Electrical Characteristics</i> From: Hiccup detect (H < L) To: Hiccup detect, and the TYP value From: 65% To: 65% x Vfbth.....	7

• Changed the Output Current (A) scale of 图 6-7	8
• Changed $V_{OUT} = 5\text{ V}$ To $V_{OUT} = 3.3\text{ V}$ in 图 6-15	10
• Changed the X axis From: Junction Temperature To: Ambient Temperature in 图 6-16	10
• Added a NOTE to the Application and Implementation section.....	15
• Changed column heading C8 + C9 (μF) To: C5 + C6 (μF) in 表 8-2	17
• Changed column heading C8 + C9 (μF) To: C5 + C6 + C7 (μF) in 表 8-2	22

Changes from Revision A (January 2014) to Revision B (July 2014)

Page

• 添加了特性说明部分、器件功能模式、应用和实现部分、电源相关建议部分、器件和文档支持部分以及机械、封装和可订购信息部分.....	1
• 将数据表标题从“4.5V 至 17V 输入，2A 同步降压...”修改为“4.5V 至 17V 输入，2A/3A 同步降压..”	1
• 将器件编号从 TPS563209 更改为 TPS563200.....	1
• 将特性部分从“2% 反馈电压精度 (25°C)”更改为：1% 反馈电压精度 (25°C).....	1
• Added the Timing Requirements table	7
• Added 表 8-1	15
• Changed 表 8-2	17
• Deleted sentence following 表 8-2 "For higher output voltages, additional phase boost can be achieved by adding a feed forward capacitor (C7) in parallel with R2."	17
• Added Application Information for the TPS563200 device	22
• Added 表 8-3	22

Changes from Revision * (January 2014) to Revision A (January 2014)

Page

• 将器件状态从“产品预发布”更改为“量产”	1
------------------------------	---

5 Pin Configuration and Functions



图 5-1. DDC Package 6 Pin (SOT) Top View

表 5-1. Pin Functions

PIN		DESCRIPTION
NAME	NUMBER	
GND	1	Ground pin Source terminal of low-side power NFET as well as the ground terminal for controller circuit. Connect sensitive VFB to this GND at a single point.
SW	2	Switch node connection between high-side NFET and low-side NFET.
VIN	3	Input voltage supply pin. The drain terminal of high-side power NFET.
VFB	4	Converter feedback input. Connect to output voltage with feedback resistor divider.
EN	5	Enable input control. Active high and must be pulled up to enable the device.
VBST	6	Supply input for the high-side NFET gate drive circuit. Connect a 0.1µF capacitor between VBST and SW pins.

6 Specifications

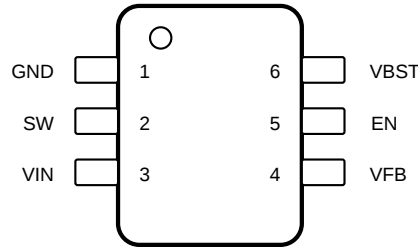
6.1 Absolute Maximum Ratings⁽¹⁾

$T_J = -40^{\circ}\text{C}$ to 150°C (unless otherwise noted)

		MIN	MAX	UNIT
Input voltage range	VIN, EN	- 0.3	19	V
	VBST	- 0.3	25	V
	VBST (10-ns transient)	- 0.3	27.5	V
	VBST (vs SW)	- 0.3	6.5	V
	VFB	- 0.3	6.5	V
	SW	- 2	19	V
	SW (10-ns transient)	- 3.5	21	V
Operating junction temperature, T_J		- 40	150	$^{\circ}\text{C}$
Storage temperature range, T_{stg}		- 55	150	$^{\circ}\text{C}$

- (1) Stresses beyond those listed under absolute maximum ratings may cause permanent damage to the device. These are stress ratings only, and functional operation of the device at these or any other conditions beyond those indicated under recommended operating conditions is not implied. Exposure to absolute-maximum-rated conditions for extended periods may affect device reliability.

6.2 ESD Ratings

			VALUE	UNIT
$V_{(ESD)}$	Electrostatic discharge	Human body model (HBM), per ANSI/ESDA/JEDEC JS-001, all pins ⁽¹⁾	± 2000	V
		Charged device model (CDM), per JEDEC specification JESD22-C101, all pins ⁽²⁾	± 500	

- (1) JEDEC document JEP155 states that 500-V HBM allows safe manufacturing with a standard ESD control process.
 (2) JEDEC document JEP157 states that 250-V CDM allows safe manufacturing with a standard ESD control process.

6.3 Recommended Operating Conditions

$T_J = -40^{\circ}\text{C}$ to 150°C (unless otherwise noted)

		MIN	MAX	UNIT	
V_{IN}	Supply input voltage range	4.5	17	V	
V_I	Input voltage range	VBST	- 0.1	23	V
		VBST (10-ns transient)	- 0.1	26	
		VBST(vs SW)	- 0.1	6	
		EN	- 0.1	17	
		VFB	- 0.1	5.5	
		SW	- 1.8	17	
		SW (10-ns transient)	- 3.5	20	
T_A	Operating free-air temperature	- 40	85	$^{\circ}\text{C}$	

6.4 Thermal Information

THERMAL METRIC ⁽¹⁾		TPS562200	TPS563200	UNITS
		DDC (SOT)	DDC (SOT)	
		(6 PINS)	(6 PINS)	
$R_{\theta JA}$	Junction-to-ambient thermal resistance	89.0	87.9	°C/W
$R_{\theta Jc\text{top}}$	Junction-to-case (top) thermal resistance	44.5	42.2	
$R_{\theta JB}$	Junction-to-board thermal resistance	13.4	13.6	
ψ_{JT}	Junction-to-top characterization parameter	2.2	1.9	
ψ_{JB}	Junction-to-board characterization parameter	13.2	13.3	

(1) For more information about traditional and new thermal metrics, see the *IC Package Thermal Metrics* application report, [SPRA953](#).

6.5 Electrical Characteristics

$T_J = -40^{\circ}\text{C}$ to 150°C , $V_{IN} = 12\text{V}$ (unless otherwise noted)

PARAMETER		TEST CONDITIONS	MIN	TYP	MAX	UNIT	
SUPPLY CURRENT							
$I_{(VIN)}$	Operating - non-switching supply current	V_{IN} current, $T_A = 25^{\circ}\text{C}$, $EN = 5\text{V}$, $V_{FB} = 0.8\text{V}$	TPS562200	230	330	μA	
			TPS563200	190	290		
$I_{(VINSDN)}$	Shutdown supply current	V_{IN} current, $T_A = 25^{\circ}\text{C}$, $EN = 0\text{V}$		3	10	μA	
LOGIC THRESHOLD							
$V_{EN(H)}$	EN high-level input voltage	EN	1.6			V	
$V_{EN(L)}$	EN low-level input voltage	EN			0.6	V	
R_{EN}	EN pin resistance to GND	$V_{EN} = 12\text{V}$	225	450	900	$\text{k}\Omega$	
V_{FB} VOLTAGE AND DISCHARGE RESISTANCE							
$V_{FB(TH)}$	V_{FB} threshold voltage	$T_A = 25^{\circ}\text{C}$, $V_O = 1.05\text{V}$, $I_O = 10\text{mA}$, Eco-mode operation		772		mV	
		$T_A = 25^{\circ}\text{C}$, $V_O = 1.05\text{V}$, continuous mode operation	758	765	772	mV	
$I_{(VFB)}$	V_{FB} input current	$V_{FB} = 0.8\text{V}$, $T_A = 25^{\circ}\text{C}$		0	± 0.1	μA	
MOSFET							
$R_{DS(on)h}$	High side switch resistance	$T_A = 25^{\circ}\text{C}$, $V_{BST} - SW = 5.5\text{V}$	TPS562200	122		$\text{m}\Omega$	
			TPS563200	68		$\text{m}\Omega$	
$R_{DS(on)l}$	Low side switch resistance	$T_A = 25^{\circ}\text{C}$	TPS562200	72		$\text{m}\Omega$	
			TPS563200	39		$\text{m}\Omega$	
CURRENT LIMIT							
I_{ocl}	Current limit (1)	DC current, $V_{OUT} = 1.05\text{V}$, $L_{OUT} = 2.2\mu\text{F}$	TPS562200	2.5	3.2	4.3	A
		DC current, $V_{OUT} = 1.05\text{V}$, $L_{OUT} = 1.5\mu\text{F}$	TPS563200	3.5	4.2	5.3	A
THERMAL SHUTDOWN							
T_{SDN}	Thermal shutdown threshold(1)	Shutdown temperature		155		$^{\circ}\text{C}$	
		Hysteresis		35			
OUTPUT UNDERVOLTAGE AND OVERVOLTAGE PROTECTION							
V_{OVP}	Output OVP threshold	OVP Detect		125% x V_{fbth}			
V_{UVP}	Output Hiccup threshold	Hiccup detect		65% x V_{fbth}			
$t_{HiccupOn}$	Hiccup On Time	Relative to soft-start time		1		ms	
$t_{HiccupOff}$	Hiccup Off Time	Relative to soft-start time		7		ms	
UVLO							
UVLO	UVLO threshold	Wake up V_{IN} voltage	3.45	3.75	4.05	V	
		Hysteresis V_{IN} voltage	0.13	0.32	0.55		

(1) Not production tested

6.6 Timing Requirements

		MIN	TYP	MAX	UNIT	
ON-TIME TIMER CONTROL						
t_{ON}	On time	$V_{IN} = 12\text{V}$, $V_O = 1.05\text{V}$	150		ns	
$t_{OFF(MIN)}$	Minimum off time	$T_A = 25^{\circ}\text{C}$, $V_{FB} = 0.5\text{V}$	260	310	ns	
SOFT START						
t_{ss}	Soft-start time	Internal soft-start time, $T_A = 25^{\circ}\text{C}$	0.7	1	1.3	ms

6.7 Typical Characteristics TPS562200

$V_{IN} = 12\text{ V}$ (unless otherwise noted).



图 6-1. Supply Current vs Junction Temperature



EN = 0 V

图 6-2. VIN Shutdown Current vs Junction Temperature

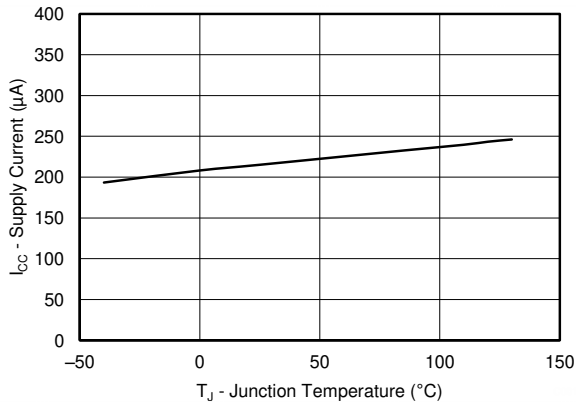
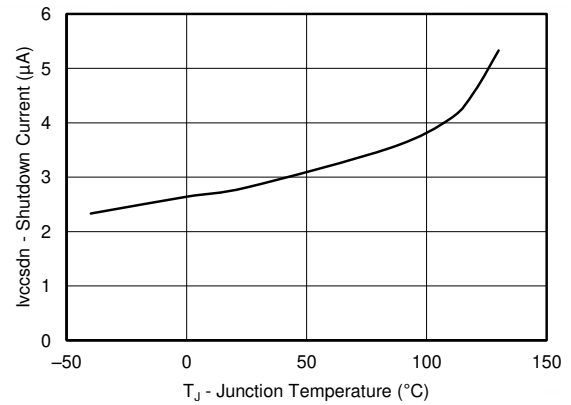
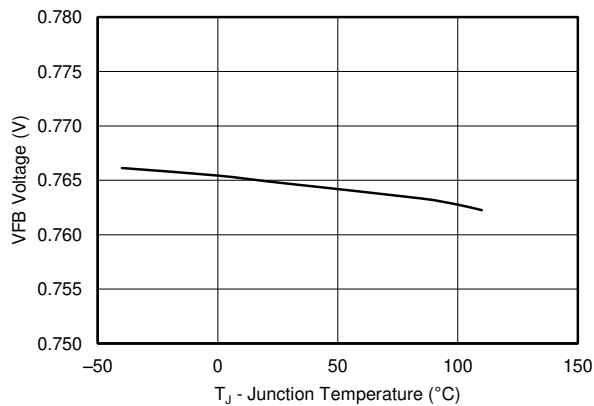

$I_O = 1\text{ A}$

图 6-3. Vfb Voltage vs Junction Temperature



图 6-4. En Current vs En Voltage



图 6-5. Efficiency vs Output Current

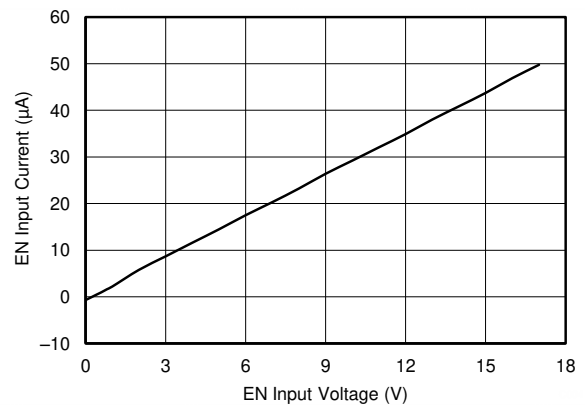

$V_{IN} = 5\text{ V}$

图 6-6. Efficiency vs Output Current

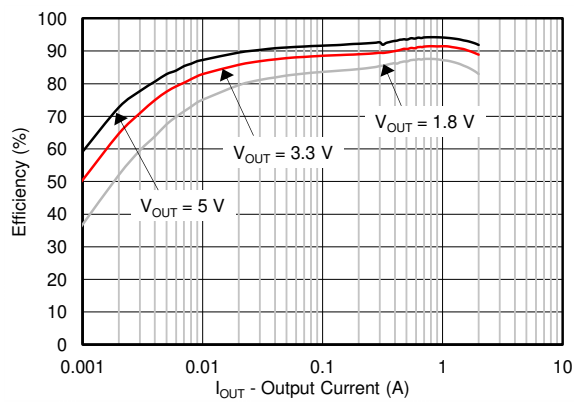
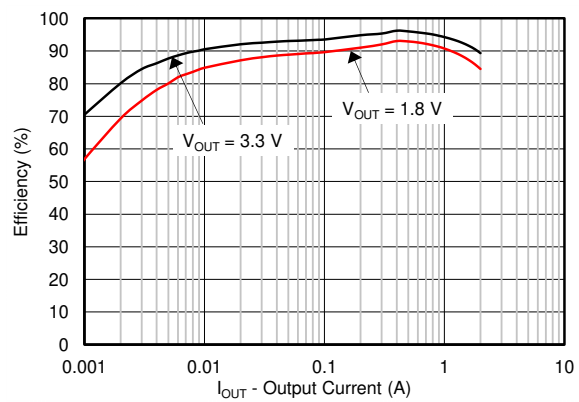
6.7 Typical Characteristics TPS562200 (continued)

$V_{IN} = 12\text{ V}$ (unless otherwise noted).



图 6-7. Output Current vs Ambient Temperature



$I_{OUT} = 500\text{ mA}$

图 6-8. Switching Frequency vs Input Voltage

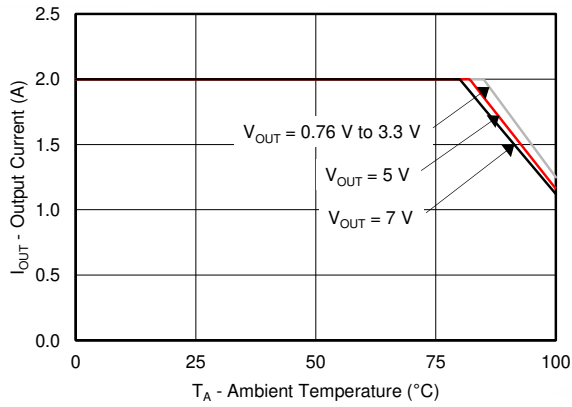
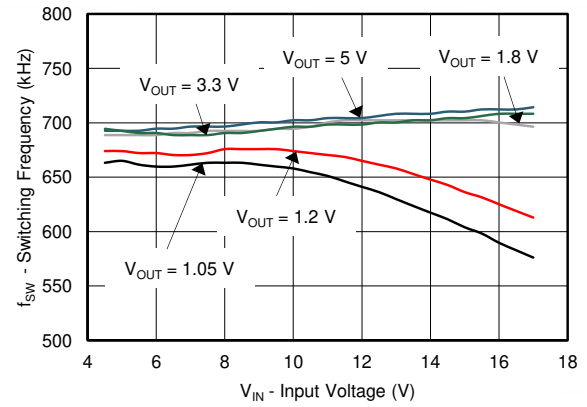

图 6-9. Switching Frequency vs Output Current

6.8 Typical Characteristics TPS563200

$V_{IN} = 12\text{ V}$ (unless otherwise noted).

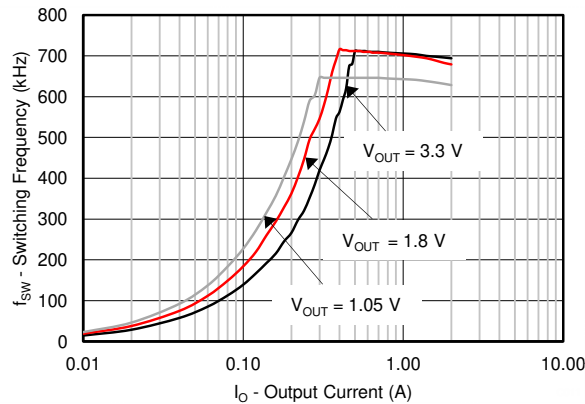
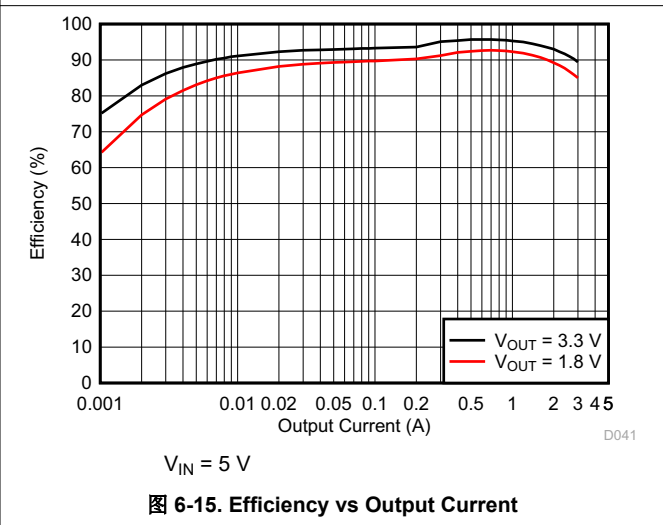
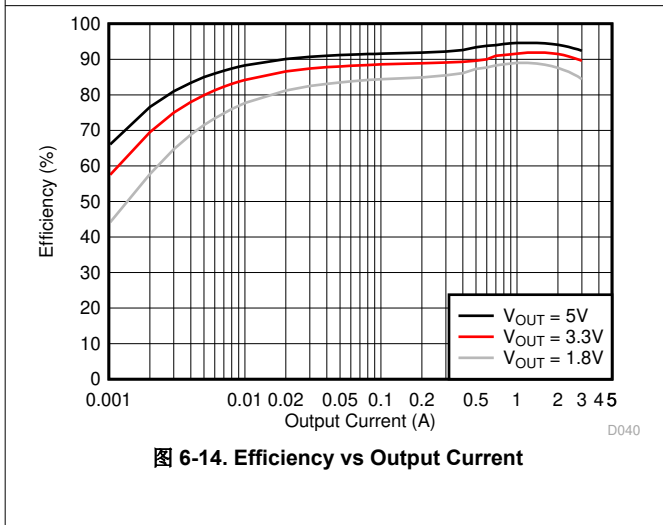
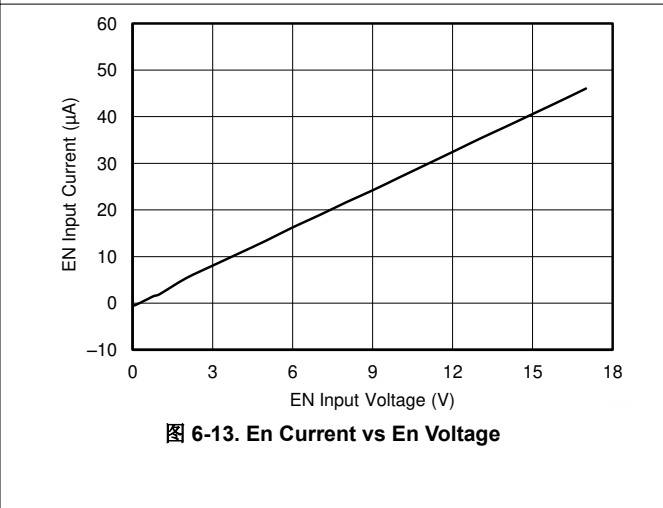
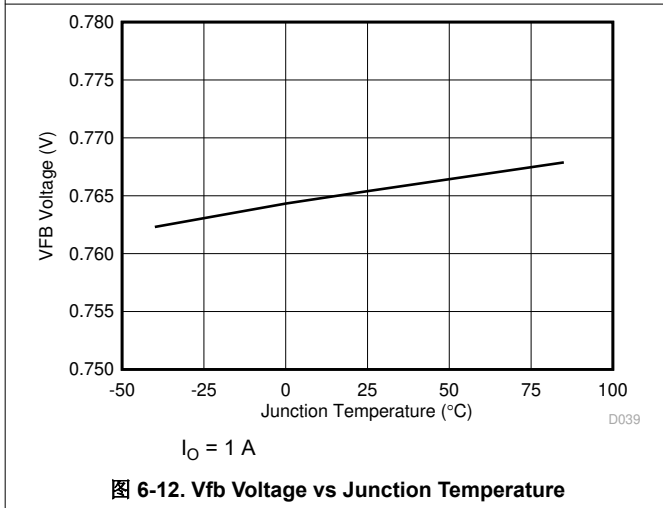
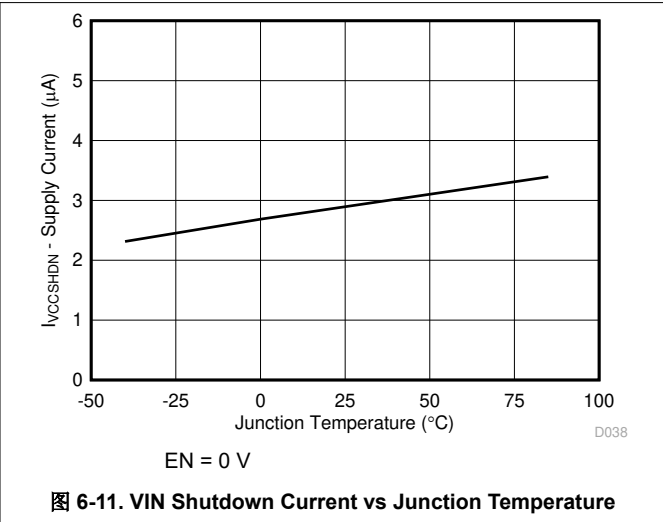
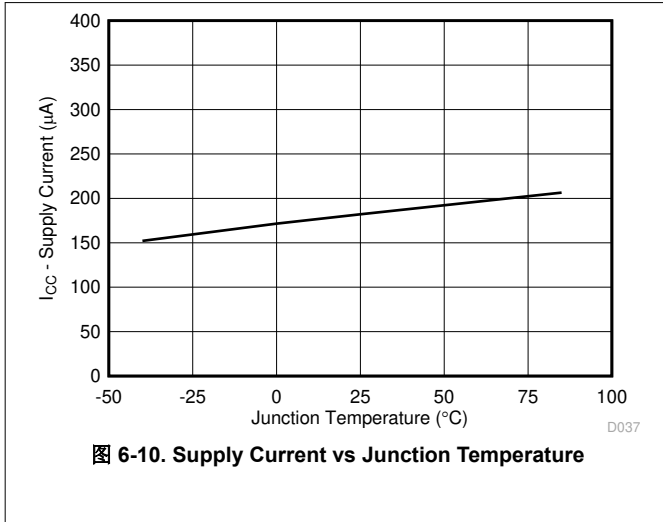

6.8 Typical Characteristics TPS563200 (continued)

$V_{IN} = 12\text{ V}$ (unless otherwise noted).

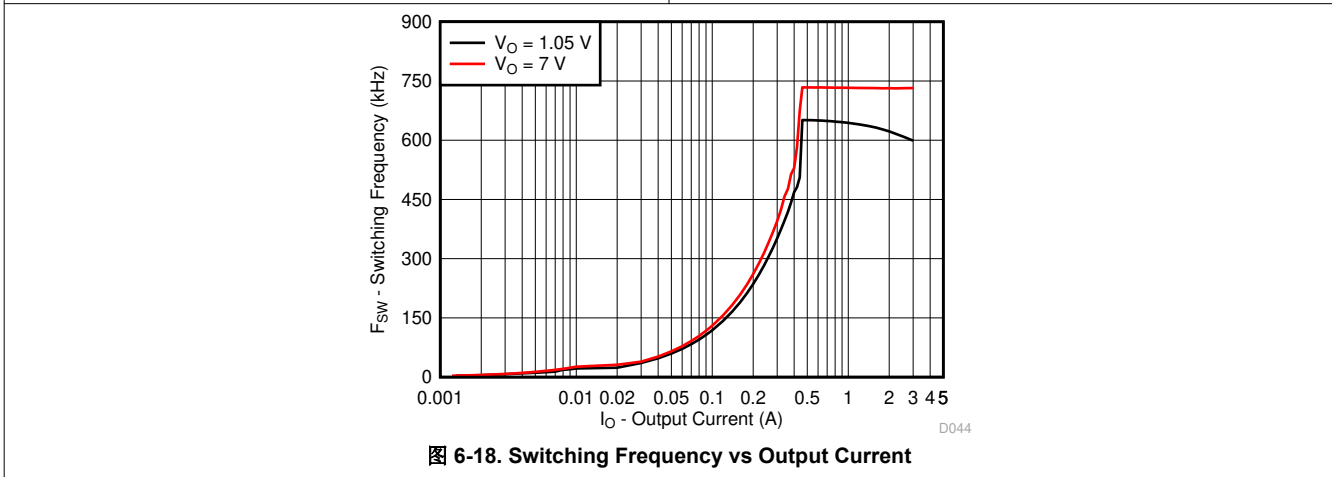
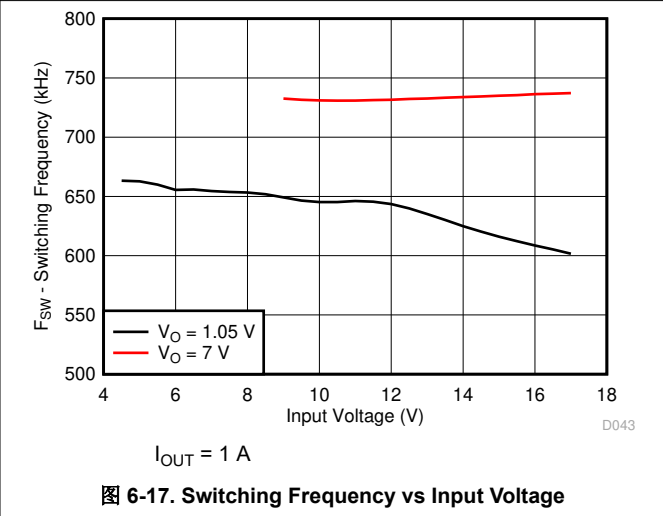
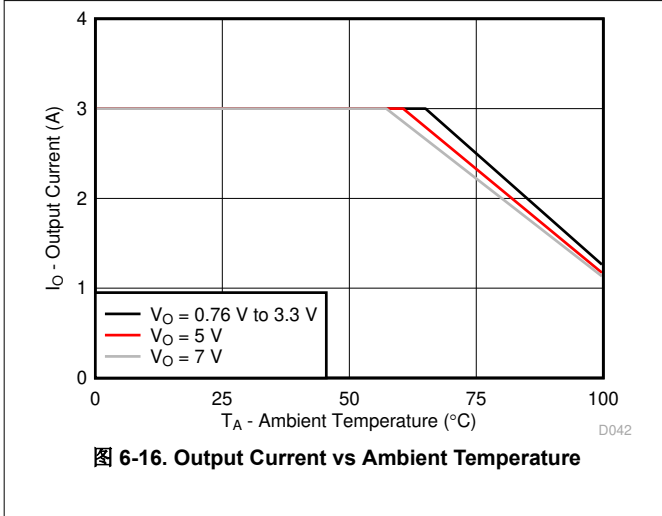

7 Detailed Description

7.1 Overview

The TPS562200 and TPS563200 are 2-A and 3-A synchronous step-down converters. The proprietary D-CAP2 control scheme supports low ESR output capacitors such as specialty polymer capacitors and multi-layer ceramic capacitors without complex external compensation circuits. The fast transient response of D-CAP2 control scheme can reduce the output capacitance required to meet a specific level of performance.

7.2 Functional Block Diagram

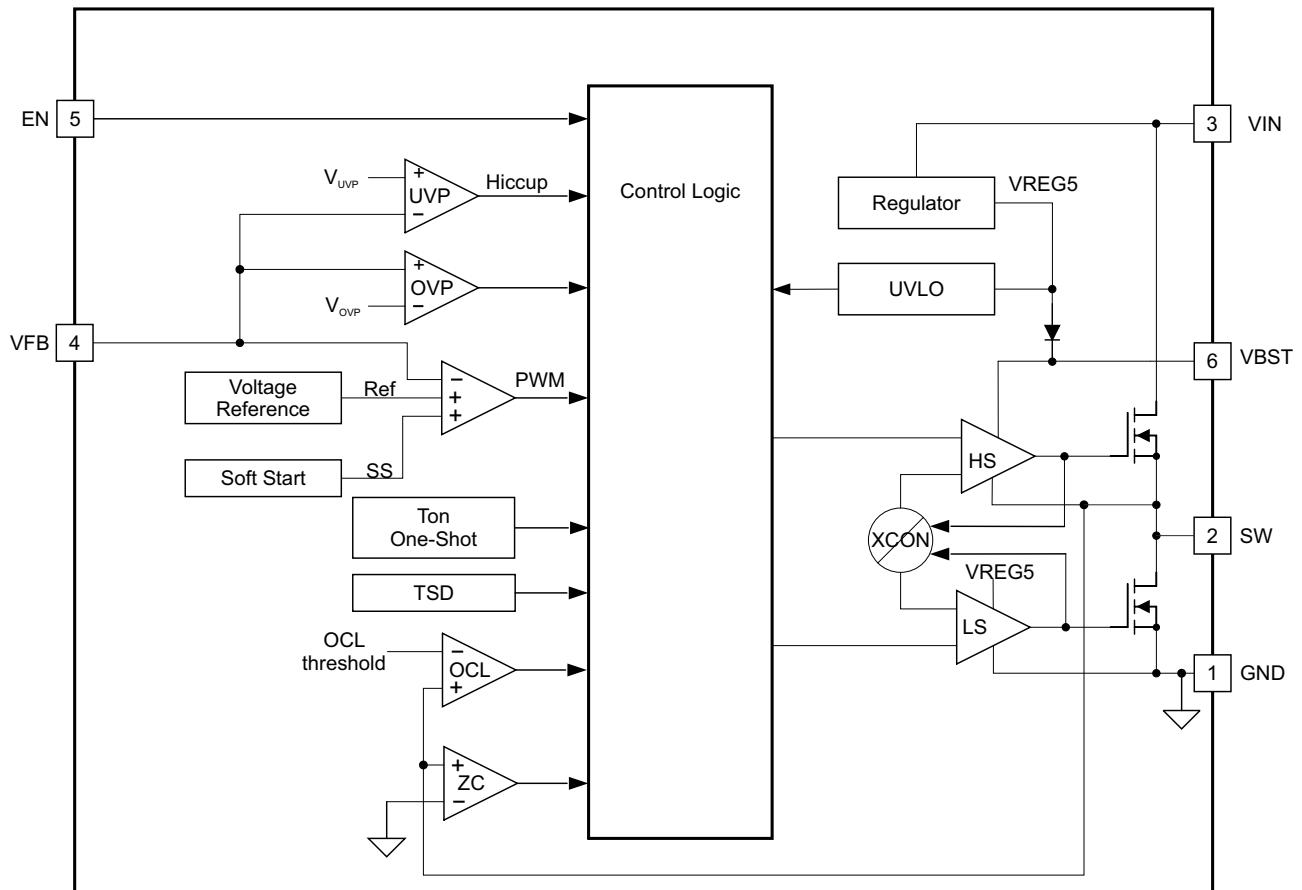

7.3 Feature Description

7.3.1 The Adaptive On-Time Control And PWM Operation

The main control loop of the TPS562200 and TPS563200 are adaptive on-time pulse width modulation (PWM) controller that supports a proprietary D-CAP2 control scheme. The D-CAP2 control scheme combines adaptive on-time control with an internal compensation circuit for pseudo-fixed frequency and low external component count configuration with both low ESR and ceramic output capacitors. It is stable even with virtually no ripple at the output.

At the beginning of each cycle, the high-side MOSFET is turned on. This MOSFET is turned off after internal one shot timer expires. This one shot duration is set inversely proportional to the converter input voltage, V_{IN} , and proportional to the output voltage, V_O , to maintain a pseudo-fixed frequency over the input voltage range, hence it is called adaptive on-time control. The one-shot timer is reset and the high-side MOSFET is turned on again when the feedback voltage falls below the reference voltage. An internal ramp is added to reference voltage to simulate output ripple, eliminating the need for ESR induced output ripple from D-CAP2 control scheme.

7.3.2 Advanced Eco-mode Control

The TPS562200 and TPS563200 are designed with Advanced Eco-mode to maintain high light load efficiency. As the output current decreases from heavy load condition, the inductor current is also reduced and eventually comes to point that its rippled valley touches zero level, which is the boundary between continuous conduction and discontinuous conduction modes. The rectifying MOSFET is turned off when the zero inductor current is detected. As the load current further decreases, the converter runs into discontinuous conduction mode. The on-time is kept almost the same as it was in the continuous conduction mode so that it takes longer time to discharge the output capacitor with smaller load current to the level of the reference voltage. This makes the switching frequency lower, proportional to the load current, and keeps the light load efficiency high. The transition point to the light load operation $I_{OUT(LL)}$ current can be calculated in [Equation 1](#).

$$I_{OUT(LL)} = \frac{1}{2 \times L \times f_{SW}} \times \frac{(V_{IN} - V_{OUT}) \times V_{OUT}}{V_{IN}} \quad (1)$$

7.3.3 Soft Start And Pre-Biased Soft Start

The TPS562200 and TPS563200 have an internal 1 ms soft-start. When the EN pin becomes high, the internal soft-start function begins ramping up the reference voltage to the PWM comparator. If the output capacitor is pre-biased at startup, the devices initiate switching and start ramping up only after the internal reference voltage becomes greater than the feedback voltage V_{FB} . This scheme ensures that the converters ramp up smoothly into regulation point.

7.3.4 Current Protection

The output overcurrent limit (OCL) is implemented using a cycle-by-cycle valley detect control circuit. The switch current is monitored during the OFF state by measuring the low-side FET drain to source voltage. This voltage is proportional to the switch current. To improve accuracy, the voltage sensing is temperature compensated.

During the on time of the high-side FET switch, the switch current increases at a linear rate determined by V_{IN} , V_{OUT} , the on-time and the output inductor value. During the on time of the low-side FET switch, this current decreases linearly. The average value of the switch current is the load current I_{OUT} . If the monitored current is above the OCL level, the converter maintains low-side FET on and delays the creation of a new set pulse, even the voltage feedback loop requires one, until the current level becomes OCL level or lower. In subsequent switching cycles, the on-time is set to a fixed value and the current is monitored in the same manner. If the over current condition exists consecutive switching cycles, the internal OCL threshold is set to a lower level, reducing the available output current. When a switching cycle occurs where the switch current is not above the lower OCL threshold, the counter is reset and the OCL threshold is returned to the higher value.

There are some important considerations for this type of over-current protection. The load current is higher than the over-current threshold by one half of the peak-to-peak inductor ripple current. Also, when the current is being limited, the output voltage tends to fall as the demanded load current can be higher than the current available

from the converter. This can cause the output voltage to fall. When the VFB voltage falls below the UVP threshold voltage, the UVP comparator detects it. Then, the device shuts down after the UVP delay time (typically 14 μ s) and re-start after the hiccup time (typically 12 ms).

When the overcurrent condition is removed, the output voltage returns to the regulated value.

7.3.5 Over Voltage Protection

TPS562200 and TPS563200 detect overvoltage condition by monitoring the feedback voltage (VFB). When the feedback voltage becomes higher than 125% of the target voltage, the OVP comparator output goes high and both the high-side MOSFET driver and the low-side MOSFET driver turn off. This function is non-latch operation.

7.3.6 UVLO Protection

Undervoltage lock out protection (UVLO) monitors the internal regulator voltage. When the voltage is lower than UVLO threshold voltage, the device is shut off. This protection is non-latching.

7.3.7 Thermal Shutdown

The device monitors the temperature of itself. If the temperature exceeds the threshold value (typically 155°C), the device is shut off. This is a non-latch protection

7.4 Device Functional Modes

7.4.1 Normal Operation

When the input voltage is above the UVLO threshold and the EN voltage is above the enable threshold, the TPS562200 and TPS563200 can operate in their normal switching modes. Normal continuous conduction mode (CCM) occurs when the minimum switch current is above 0 A. In CCM, the TPS562200 and TPS563200 operate at a quasi-fixed frequency of 650 kHz.

7.4.2 Eco-mode Operation

When the TPS562200 and TPS563200 are in the normal CCM operating mode and the switch current falls to 0 A, the TPS562200 and TPS563200 begin operating in pulse skipping Eco-mode. Each switching cycle is followed by a period of energy saving sleep time. The sleep time ends when the VFB voltage falls below the Eco-mode threshold voltage. As the output current decreases the perceived time between switching pulses increases.

7.4.3 Standby Operation

When the TPS562200 and TPS563200 are operating in either normal CCM or Eco-mode, they can be placed in standby by asserting the EN pin low.

8 Application and Implementation

备注

以下应用部分中的信息不属于 TI 器件规格的范围，TI 不担保其准确性和完整性。TI 的客户应负责确定器件是否适用于其应用。客户应验证并测试其设计，以确保系统功能。

8.1 Application Information

The TPS562200 and TPS563200 are typically used as step down converters, which convert a voltage from 4.5 V – 17 V to a lower voltage. WEBENCH software is available to aid in the design and analysis of circuits

8.2 Typical Applications

8.2.1 Tps562200 4.5-V To 17-V Input, 1.05-V Output Converter



图 8-1. Tps562200 1.05v/2a Reference Design

8.2.1.1 Design Requirements

To begin the design process, the user must know a few application parameters:

表 8-1. Design Parameters

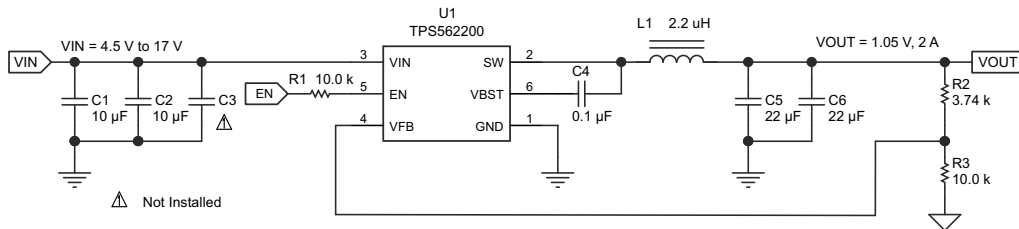
PARAMETER	VALUE
Input voltage range	4.5 V to 17 V
Output voltage	1.05 V
Output current	2 A
Output voltage ripple	20 mVpp

8.2.1.2 Detailed Design Procedures

8.2.1.2.1 Custom Design with WEBENCH® Tools

[Click here](#) to create a custom design using the WEBENCH Power Designer.

1. Start by entering your V_{IN} , V_{OUT} and I_{OUT} requirements.
2. Optimize your design for key parameters like efficiency, footprint and cost using the optimizer dial and compare this design with other possible solutions from Texas Instruments.
3. WEBENCH Power Designer provides you with a customized schematic along with a list of materials with real time pricing and component availability.
4. In most cases, you will also be able to:
 - Run electrical simulations to see important waveforms and circuit performance,
 - Run thermal simulations to understand the thermal performance of your board,
 - Export your customized schematic and layout into popular CAD formats,
 - Print PDF reports for the design, and share your design with colleagues.

8.2.1.2.2 Output Voltage Resistors Selection

The output voltage is set with a resistor divider from the output node to the VFB pin. TI recommends to use 1% tolerance or better divider resistors. Start by using [Equation 2](#) to calculate V_{OUT} .

To improve efficiency at light loads consider using larger value resistors, too high of resistance is more susceptible to noise and voltage errors from the VFB input current are more noticeable.

$$V_{\text{OUT}} = 0.765 \times \left(1 + \frac{R2}{R3} \right) \quad (2)$$

8.2.1.2.3 Output Filter Selection

The LC filter used as the output filter has double pole at:

$$F_P = \frac{1}{2\pi\sqrt{L_{OUT} \times C_{OUT}}} \quad (3)$$

At low frequencies, the overall loop gain is set by the output set-point resistor divider network and the internal gain of the device. The low frequency phase is 180 degrees. At the output filter pole frequency, the gain rolls off at a - 40 dB per decade rate and the phase drops rapidly. D-CAP2 control scheme introduces a high frequency zero that reduces the gain roll off to - 20 dB per decade and increases the phase to 90 degrees one decade above the zero frequency. The inductor and capacitor selected for the output filter must be selected so that the double pole of Equation 3 is located below the high frequency zero but close enough that the phase boost provided by the high frequency zero provides adequate phase margin for a stable circuit. To meet this requirement use the values recommended in Table 1.

表 8-2. TPS562200 Recommended Component Values

Output Voltage (V)	R2 (kΩ)	R3 (kΩ)	L1(μH)			C5 + C6 (μF)
			MIN	TYP	MAX	
1	3.09	10.0	1.5	2.2	4.7	20 - 68
1.05	3.74	10.0	1.5	2.2	4.7	20 - 68
1.2	5.76	10.0	1.5	2.2	4.7	20 - 68
1.5	9.53	10.0	1.5	2.2	4.7	20 - 68
1.8	13.7	10.0	1.5	2.2	4.7	20 - 68
2.5	22.6	10.0	2.2	3.3	4.7	20 - 68
3.3	33.2	10.0	2.2	3.3	4.7	20 - 68
5	54.9	10.0	3.3	4.7	4.7	20 - 68
6.5	75	10.0	3.3	4.7	4.7	20 - 68

The inductor peak-to-peak ripple current, peak current and RMS current are calculated using 方程式 4, 方程式 5 and Equation 6. The inductor saturation current rating must be greater than the calculated peak current and the RMS or heating current rating must be greater than the calculated RMS current. Use 650 kHz for f_{SW} .

Use 650 kHz for f_{SW} . Make sure the chosen inductor is rated for the peak current of 方程式 5 and the RMS current of 方程式 6.

$$I_{P-P} = \frac{V_{OUT}}{V_{IN(MAX)}} \times \frac{V_{IN(MAX)} - V_{OUT}}{L_O \times f_{SW}} \quad (4)$$

$$I_{PEAK} = I_O + \frac{I_{P-P}}{2} \quad (5)$$

$$I_{LO(RMS)} = \sqrt{I_O^2 + \frac{1}{12} I_{P-P}^2} \quad (6)$$

For this design example, the calculated peak current is 2.34 A and the calculated RMS current is 2.01 A. The inductor used is a TDK CLF7045T-2R2N with a peak current rating of 5.5 A and an RMS current rating of 4.3 A

The capacitor value and ESR determines the amount of output voltage ripple. The device is intended for use with ceramic or other low ESR capacitors. Recommended values range from 20 μF to 68 μF. Use 方程式 7 to determine the required RMS current rating for the output capacitor.

$$I_{CO(RMS)} = \frac{V_{OUT} \times (V_{IN} - V_{OUT})}{\sqrt{12} \times V_{IN} \times L_O \times f_{SW}} \quad (7)$$

For this design, two TDK C3216X5R0J226M 22- μ F output capacitors are used. The typical ESR is 2 m Ω each. The calculated RMS current is 0.286 A and each output capacitor is rated for 4 A.

8.2.1.2.4 Input Capacitor Selection

The device requires an input decoupling capacitor and a bulk capacitor is needed depending on the application. TI recommends a ceramic capacitor over 10 μ F for the decoupling capacitor. An additional 0.1- μ F capacitor(C3) from pin 3 to ground is optional to provide additional high frequency filtering. The capacitor voltage rating must be greater than the maximum input voltage.

8.2.1.2.5 Bootstrap Capacitor Selection

A 0.1- μ F ceramic capacitor must be connected between the VBST to SW pin for proper operation. TI recommends to use a ceramic capacitor.

8.2.1.3 Application Curves



图 8-2. Tps562200 Efficiency



图 8-3. Tps562200 Light Load Efficiency

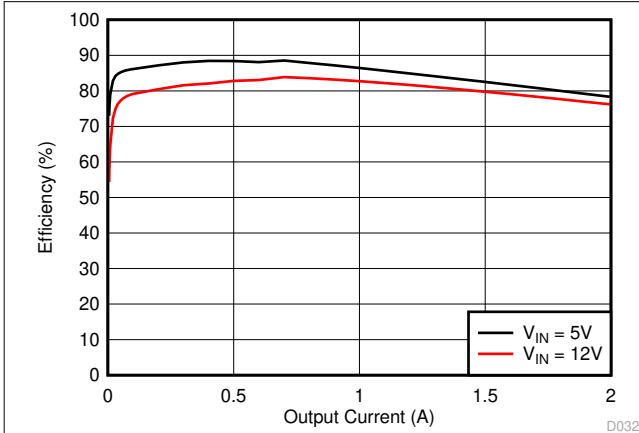

图 8-4. Tps562200 Load Regulation, $V_I = 5V$

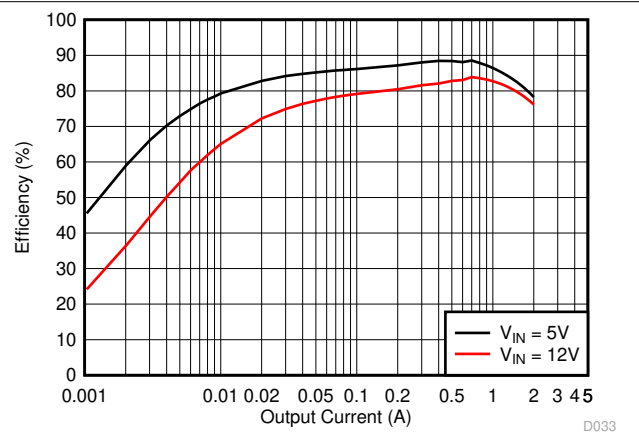

图 8-5. Tps562200 Load Regulation, $V_I = 12V$

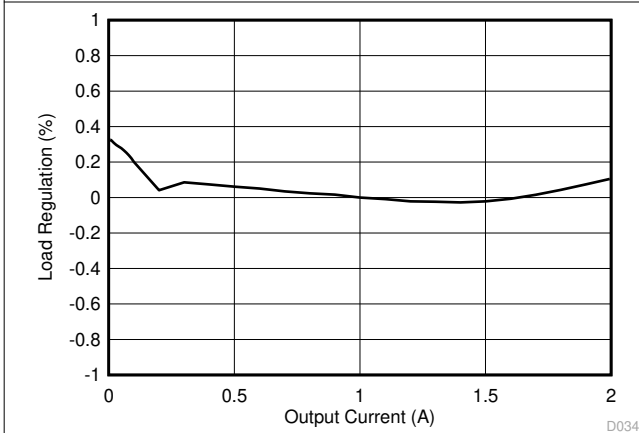

图 8-6. Tps562200 Line Regulation

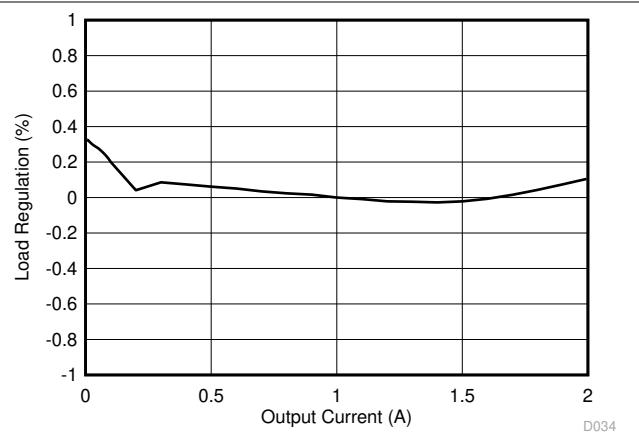

图 8-7. Tps562200 Input Voltage Ripple

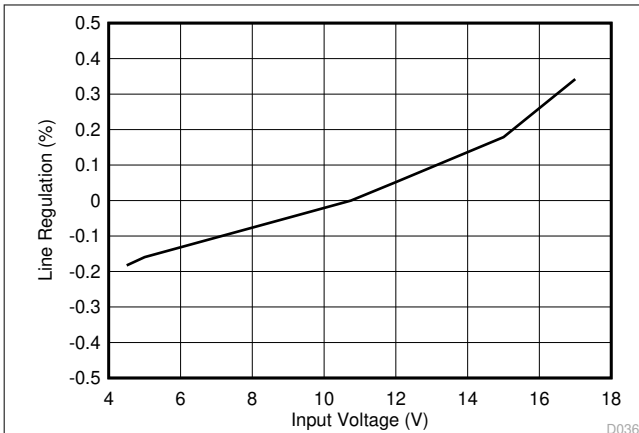

图 8-8. Tps562200 Output Voltage Ripple

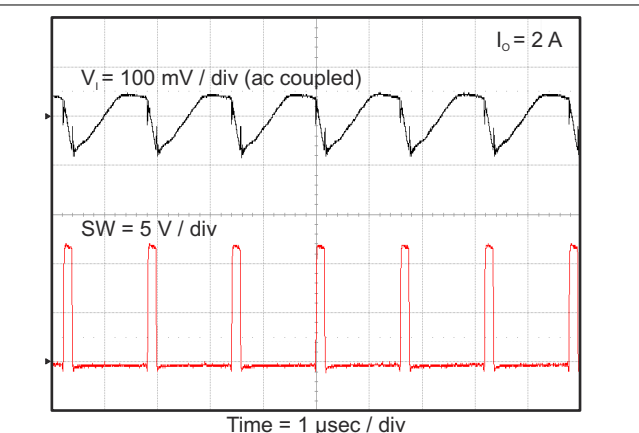

图 8-9. Tps562200 Output Voltage Ripple

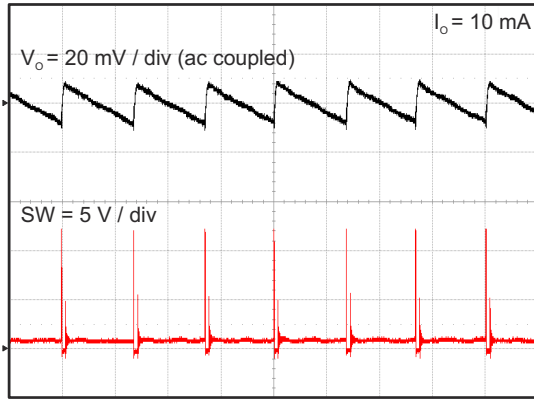

图 8-10. Tps562200 Output Voltage Ripple

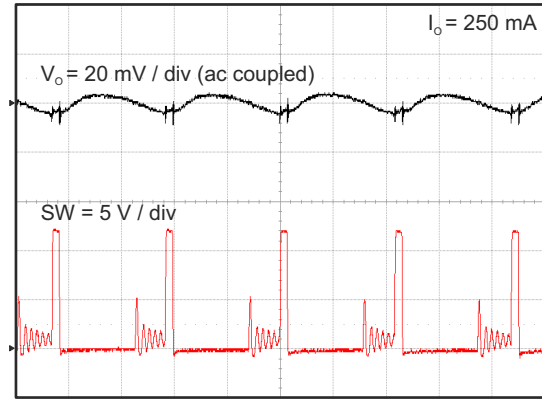

图 8-11. Tps562200 Transient Response

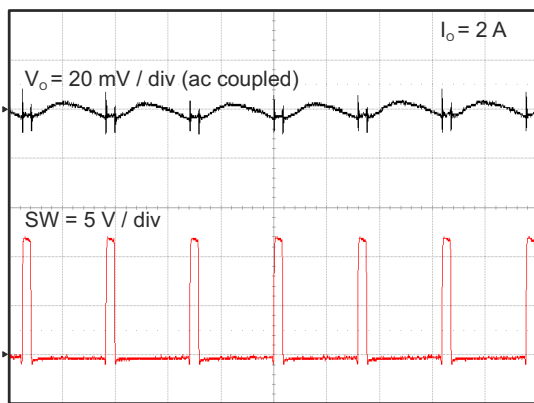

图 8-12. Tps562200 Start Up Relative to V_I

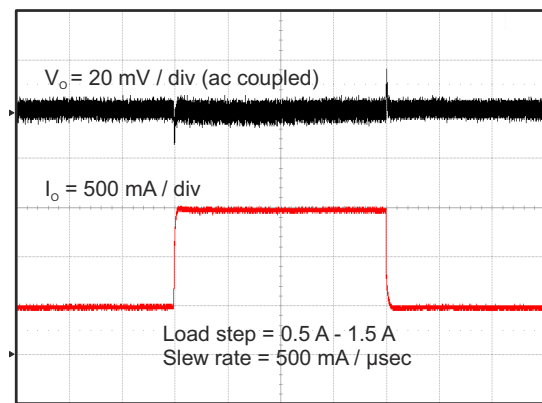

图 8-13. Tps562200 Start Up Relative to En

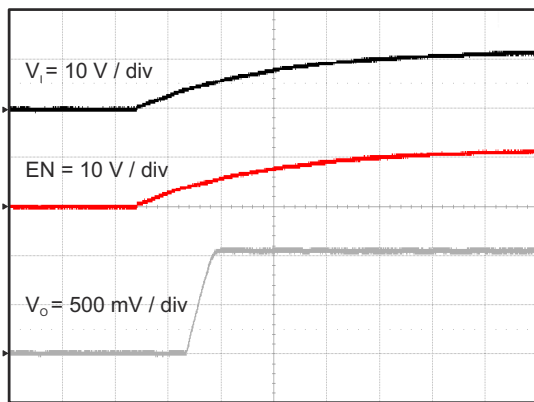

Time = 2 msec / div

图 8-14. Tps562200 Shut Down Relative to V_1

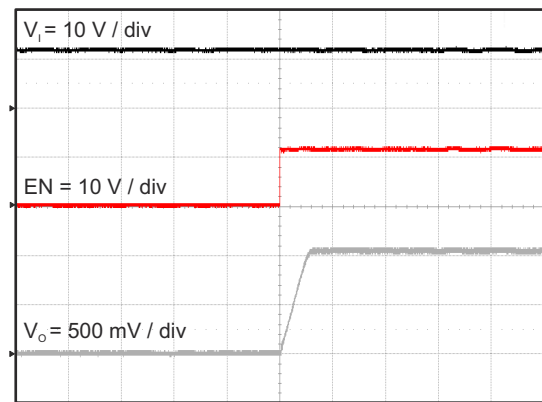
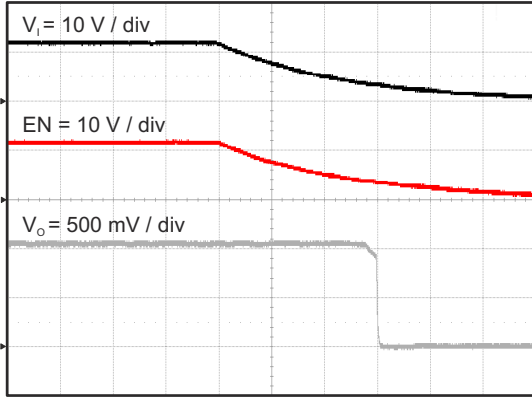
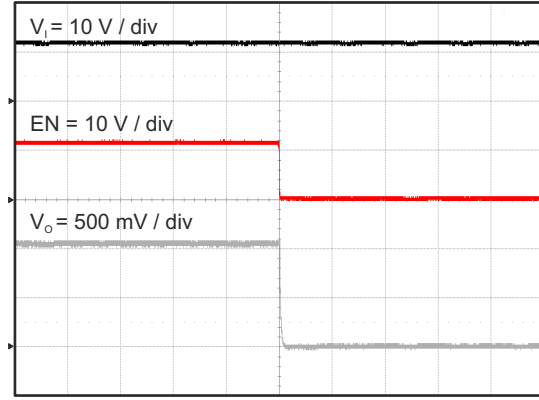

Time = 2 msec / div

图 8-15. Tps562200 Shut Down Relative to EN

8.2.2 Tps563200 4.5-V To 17-V Input, 1.05-V Output Converter

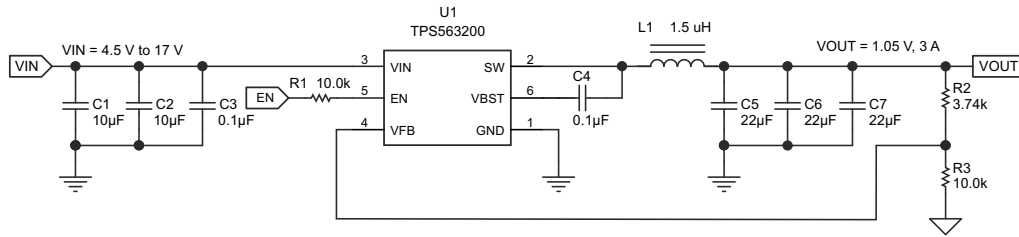

Copyright © 2016, Texas Instruments Incorporated

图 8-16. Tps563200 1.05v/3a Reference Design

8.2.2.1 Design Requirements

To begin the design process, the user must know a few application parameters:

表 8-3. Design Parameters

PARAMETER	VALUE
Input voltage range	4.5 V to 17 V
Output voltage	1.05 V
Output current	3 A
Output voltage ripple	20 mVpp

8.2.2.2 Detailed Design Procedures

The detailed design procedure for TPS563200 is the same as for TPS562200 except for inductor selection.

8.2.2.2.1 Output Filter Selection

表 8-4. Tps563200 Recommended Component Values

Output Voltage (V)	R2 (kΩ)	R3 (kΩ)	L1 (µH)			C5 + C6 + C7 (µF)
			MIN	TYP	MAX	
1	3.09	10.0	1.0	1.5	4.7	20 - 68
1.05	3.74	10.0	1.0	1.5	4.7	20 - 68
1.2	5.76	10.0	1.0	1.5	4.7	20 - 68
1.5	9.53	10.0	1.0	1.5	4.7	20 - 68
1.8	13.7	10.0	1.5	2.2	4.7	20 - 68
2.5	22.6	10.0	1.5	2.2	4.7	20 - 68
3.3	33.2	10.0	1.5	2.2	4.7	20 - 68
5	54.9	10.0	2.2	3.3	4.7	20 - 68
6.5	75	10.0	2.2	3.3	4.7	20 - 68

The inductor peak-to-peak ripple current, peak current and RMS current are calculated using 方程式 8, 方程式 9 and 方程式 10. The inductor saturation current rating must be greater than the calculated peak current and the RMS or heating current rating must be greater than the calculated RMS current. Use 650 kHz for f_{SW} .

Use 650 kHz for f_{SW} . Make sure the chosen inductor is rated for the peak current of 方程式 9 and the RMS current of 方程式 10.

$$I_{P-P} = \frac{V_{OUT}}{V_{IN(MAX)}} \times \frac{V_{IN(MAX)} - V_{OUT}}{L_O \times f_{SW}} \tag{8}$$

$$I_{\text{PEAK}} = I_{\text{O}} + \frac{I_{\text{P-P}}}{2} \quad (9)$$

$$I_{\text{LO(RMS)}} = \sqrt{I_{\text{O}}^2 + \frac{1}{12} I_{\text{P-P}}^2} \quad (10)$$

For this design example, the calculated peak current is 3.505 A and the calculated RMS current is 3.014 A. The inductor used is a TDK CLF7045T-1R5N with a peak current rating of 7.3 A and an RMS current rating of 4.9 A.

The capacitor value and ESR determines the amount of output voltage ripple. The TPS563209 is intended for use with ceramic or other low ESR capacitors. Recommended values range from 20 μF to 68 μF . Use Equation 6 to determine the required RMS current rating for the output capacitor. For this design three TDK C3216X5R0J226M 22 μF output capacitors are used. The typical ESR is 2 m Ω each. The calculated RMS current is 0.292 A and each output capacitor is rated for 4 A.

8.2.2.3 Application Curves



图 8-17. Tps563200 Efficiency



图 8-18. Tps563200 Light Load Efficiency

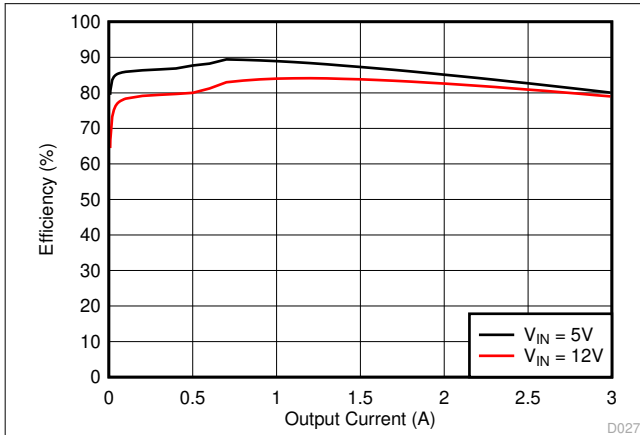

图 8-19. Tps563200 Load Regulation, $V_I = 5\text{ V}$

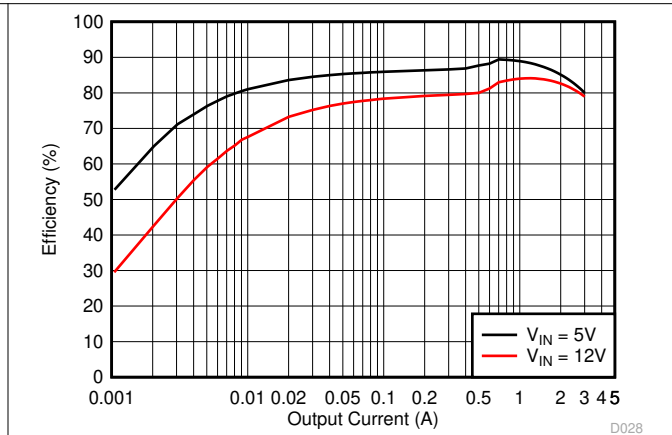

图 8-20. Tps563200 Load Regulation, $V_I = 12\text{ V}$

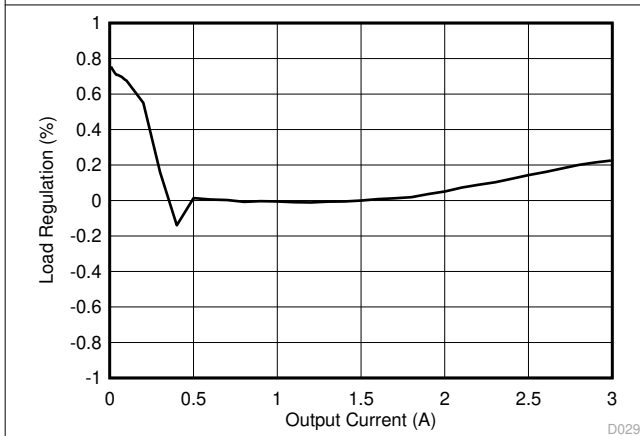

图 8-21. Tps563200 Line Regulation

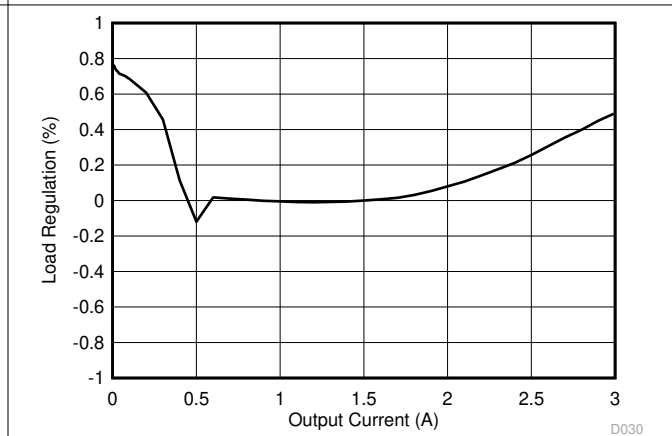

图 8-22. Tps563200 Input Voltage Ripple

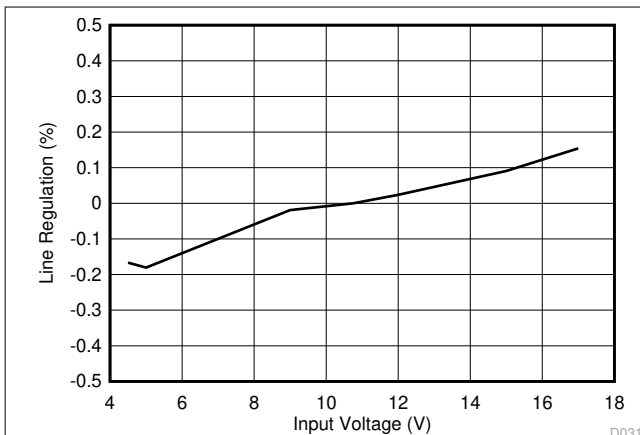

图 8-23. Tps563200 Output Voltage Ripple

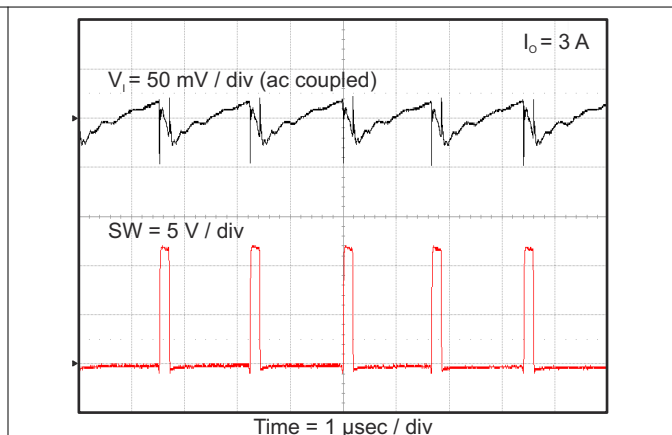

图 8-24. Tps563200 Output Voltage Ripple

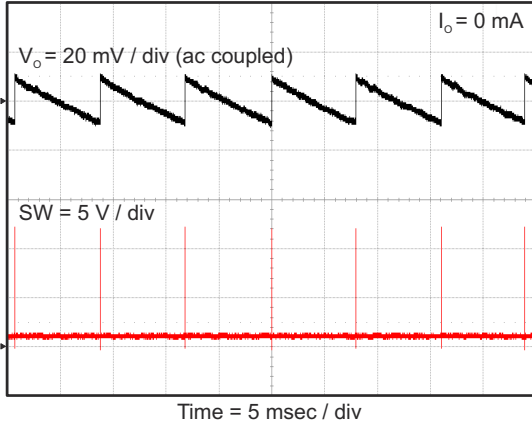

图 8-25. Tps563200 Output Voltage Ripple

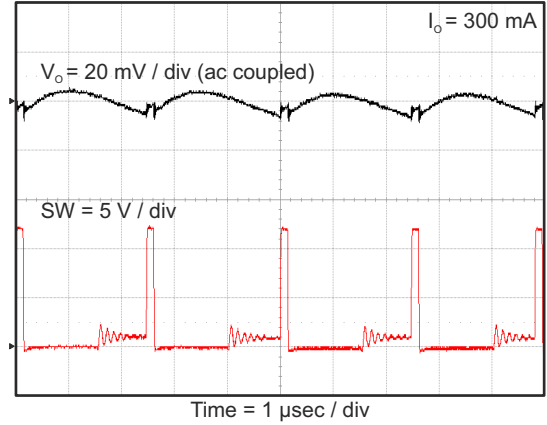

图 8-26. Tps563200 Transient Response

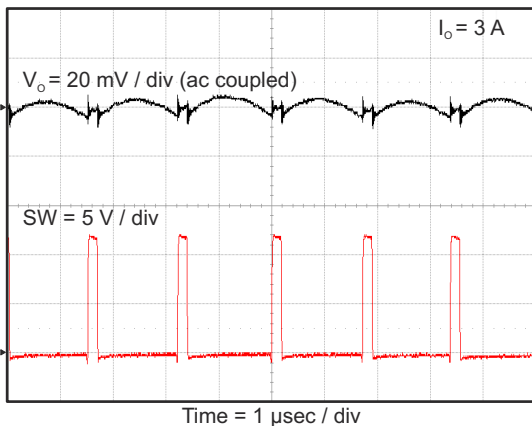

图 8-27. Tps563200 Start-up Relative to V_i

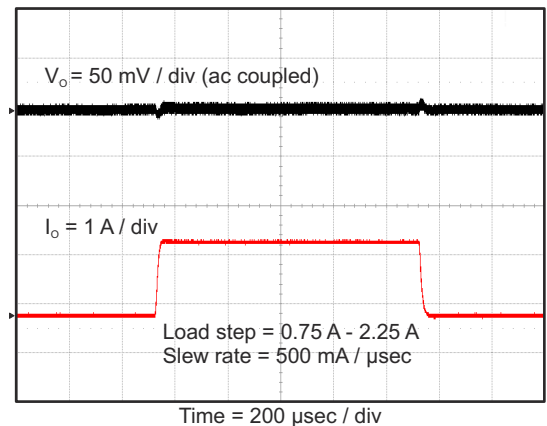

图 8-28. Tps563200 Start-up Relative to En

图 8-29. Tps563200 Shutdown Relative to V_I 

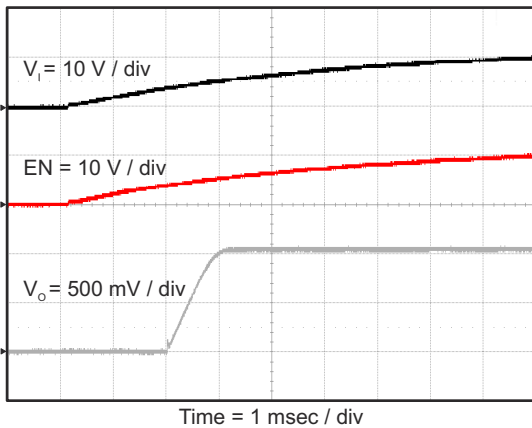
图 8-30. Tps563200 Shutdown Relative to En

8.3 Power Supply Recommendations

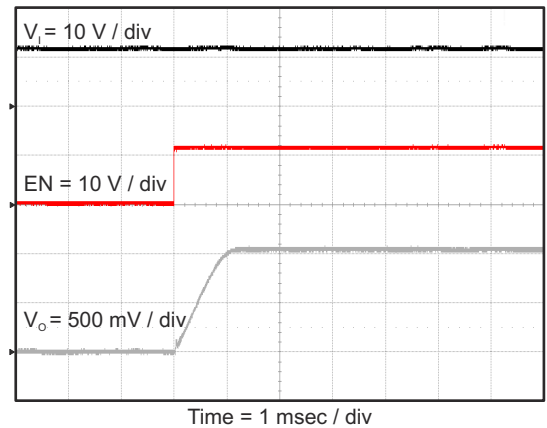
The TPS562200 and TPS563200 are designed to operate from input supply voltage in the range of 4.5 V to 17 V. Buck converters require the input voltage to be higher than the output voltage for proper operation. The maximum recommended operating duty cycle is 65%. Using that criteria, the minimum recommended input voltage is $V_O / 0.65$.

8.4 Layout

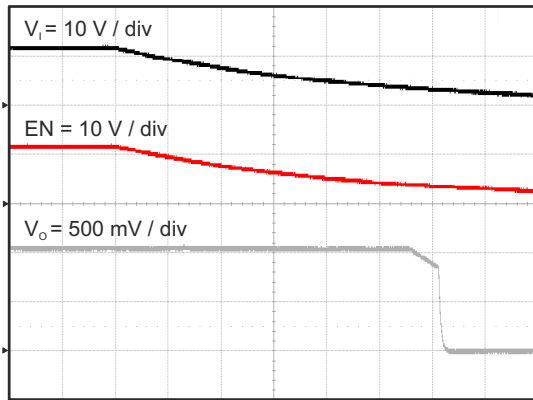
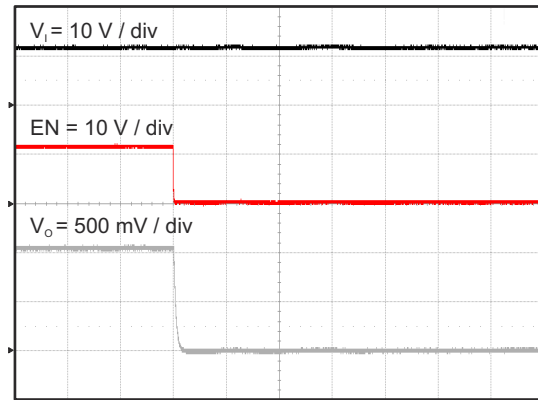
8.4.1 Layout Guidelines

1. VIN and GND traces must be as wide as possible to reduce trace impedance. The wide areas are also of advantage from the view point of heat dissipation.
2. The input capacitor and output capacitor must be placed as close to the device as possible to minimize trace impedance.
3. Provide sufficient vias for the input capacitor and output capacitor.
4. Keep the SW trace as physically short and wide as practical to minimize radiated emissions.
5. Do not allow switching current to flow under the device.
6. A separate VOUT path must be connected to the upper feedback resistor
7. Make a Kelvin connection to the GND pin for the feedback path.
8. Voltage feedback loop must be placed away from the high-voltage switching trace, and preferably has ground shield.
9. The trace of the VFB node must be as small as possible to avoid noise coupling.
10. The GND trace between the output capacitor and the GND pin must be as wide as possible to minimize its trace impedance.

8.4.2 Layout Example



图 8-31. Typical Layout

9 Device and Documentation Support

9.1 Device Support

9.1.1 Development Support

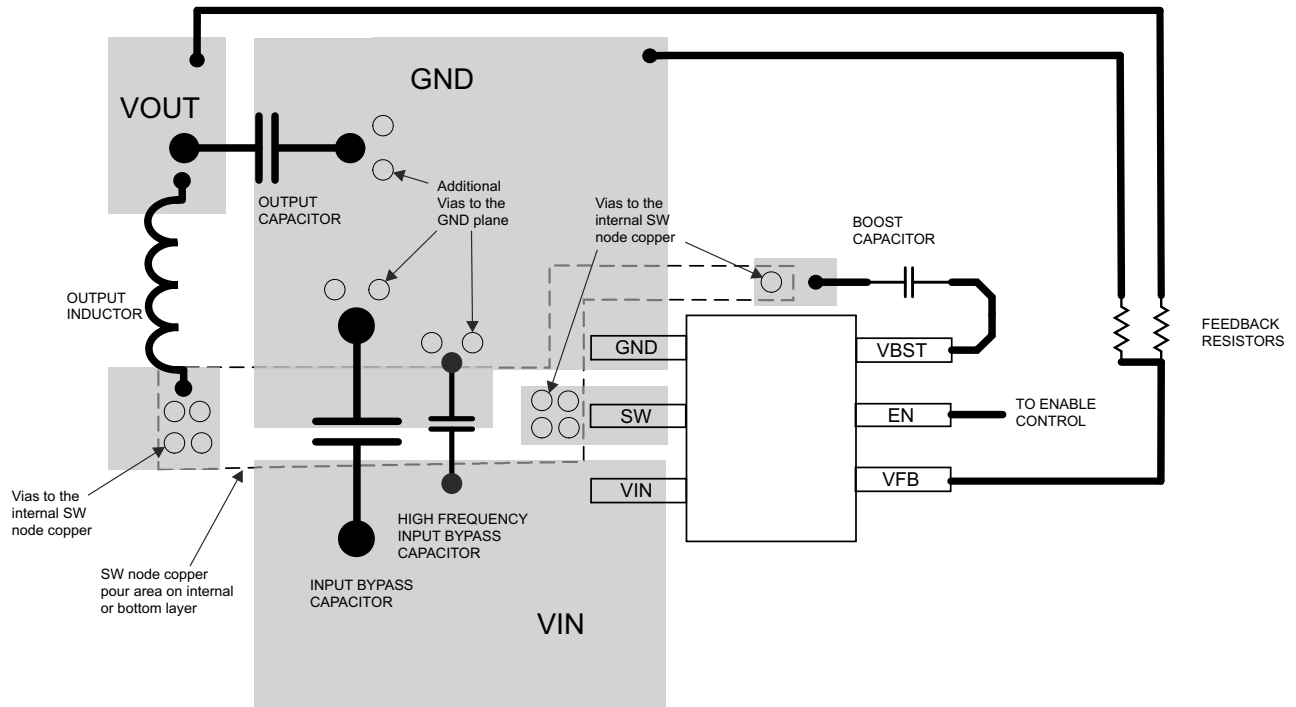
9.1.1.1 Custom Design with WEBENCH® Tools

[Click here](#) to create a custom design using the WEBENCH Power Designer.

1. Start by entering your V_{IN} , V_{OUT} and I_{OUT} requirements.
2. Optimize your design for key parameters like efficiency, footprint and cost using the optimizer dial and compare this design with other possible solutions from Texas Instruments.
3. WEBENCH Power Designer provides you with a customized schematic along with a list of materials with real time pricing and component availability.
4. In most cases, you will also be able to:
 - Run electrical simulations to see important waveforms and circuit performance,
 - Run thermal simulations to understand the thermal performance of your board,
 - Export your customized schematic and layout into popular CAD formats,
 - Print PDF reports for the design, and share your design with colleagues.

9.2 接收文档更新通知

要接收文档更新通知，请导航至 ti.com 上的器件产品文件夹。点击 [订阅更新](#) 进行注册，即可每周接收产品信息更改摘要。有关更改的详细信息，请查看任何已修订文档中包含的修订历史记录。

9.3 支持资源

[TI E2E™ 支持论坛](#) 是工程师的重要参考资料，可直接从专家获得快速、经过验证的解答和设计帮助。搜索现有解答或提出自己的问题可获得所需的快速设计帮助。

链接的内容由各个贡献者“按原样”提供。这些内容并不构成 TI 技术规范，并且不一定反映 TI 的观点；请参阅 TI 的《[使用条款](#)》。

9.4 Trademarks

D-CAP2™ and TI E2E™ are trademarks of Texas Instruments.

蓝光光盘™ is a trademark of Blu-ray Disc Association.

WEBENCH® is a registered trademark of Texas Instruments.

所有商标均为其各自所有者的财产。

9.5 静电放电警告



静电放电 (ESD) 会损坏这个集成电路。德州仪器 (TI) 建议通过适当的预防措施处理所有集成电路。如果不遵守正确的处理和安装程序，可能会损坏集成电路。

ESD 的损坏小至导致微小的性能降级，大至整个器件故障。精密的集成电路可能更容易受到损坏，这是因为非常细微的参数更改都可能会导致器件与其发布的规格不相符。

9.6 术语表

[TI 术语表](#) 本术语表列出并解释了术语、首字母缩略词和定义。

10 Mechanical, Packaging, And Orderable Information

The following pages include mechanical, packaging, and orderable information. This information is the most current data available for the designated devices. This data is subject to change without notice and revision of this document. For browser-based versions of this data sheet, refer to the left-hand navigation.

PACKAGING INFORMATION

Orderable Device	Status (1)	Package Type	Package Drawing	Pins	Package Qty	Eco Plan (2)	Lead finish/ Ball material (6)	MSL Peak Temp (3)	Op Temp (°C)	Device Marking (4/5)	Samples
TPS562200DDCR	ACTIVE	SOT-23-THIN	DDC	6	3000	RoHS & Green	Call TI SN	Level-1-260C-UNLIM	-40 to 125	200	Samples
TPS562200DDCT	ACTIVE	SOT-23-THIN	DDC	6	250	RoHS & Green	Call TI SN	Level-1-260C-UNLIM	-40 to 125	200	Samples
TPS563200DDCR	ACTIVE	SOT-23-THIN	DDC	6	3000	RoHS & Green	SN	Level-1-260C-UNLIM	-40 to 125	320	Samples
TPS563200DDCT	ACTIVE	SOT-23-THIN	DDC	6	250	RoHS & Green	SN	Level-1-260C-UNLIM	-40 to 125	320	Samples

(1) The marketing status values are defined as follows:

ACTIVE: Product device recommended for new designs.

LIFEBUY: TI has announced that the device will be discontinued, and a lifetime-buy period is in effect.

NRND: Not recommended for new designs. Device is in production to support existing customers, but TI does not recommend using this part in a new design.

PREVIEW: Device has been announced but is not in production. Samples may or may not be available.

OBSELETE: TI has discontinued the production of the device.

(2) **RoHS:** TI defines "RoHS" to mean semiconductor products that are compliant with the current EU RoHS requirements for all 10 RoHS substances, including the requirement that RoHS substance do not exceed 0.1% by weight in homogeneous materials. Where designed to be soldered at high temperatures, "RoHS" products are suitable for use in specified lead-free processes. TI may reference these types of products as "Pb-Free".

RoHS Exempt: TI defines "RoHS Exempt" to mean products that contain lead but are compliant with EU RoHS pursuant to a specific EU RoHS exemption.

Green: TI defines "Green" to mean the content of Chlorine (Cl) and Bromine (Br) based flame retardants meet JS709B low halogen requirements of <=1000ppm threshold. Antimony trioxide based flame retardants must also meet the <=1000ppm threshold requirement.

(3) MSL, Peak Temp. - The Moisture Sensitivity Level rating according to the JEDEC industry standard classifications, and peak solder temperature.

(4) There may be additional marking, which relates to the logo, the lot trace code information, or the environmental category on the device.

(5) Multiple Device Markings will be inside parentheses. Only one Device Marking contained in parentheses and separated by a "-" will appear on a device. If a line is indented then it is a continuation of the previous line and the two combined represent the entire Device Marking for that device.

(6) Lead finish/Ball material - Orderable Devices may have multiple material finish options. Finish options are separated by a vertical ruled line. Lead finish/Ball material values may wrap to two lines if the finish value exceeds the maximum column width.

Important Information and Disclaimer:The information provided on this page represents TI's knowledge and belief as of the date that it is provided. TI bases its knowledge and belief on information provided by third parties, and makes no representation or warranty as to the accuracy of such information. Efforts are underway to better integrate information from third parties. TI has taken and

continues to take reasonable steps to provide representative and accurate information but may not have conducted destructive testing or chemical analysis on incoming materials and chemicals. TI and TI suppliers consider certain information to be proprietary, and thus CAS numbers and other limited information may not be available for release.

In no event shall TI's liability arising out of such information exceed the total purchase price of the TI part(s) at issue in this document sold by TI to Customer on an annual basis.

TAPE AND REEL INFORMATION

QUADRANT ASSIGNMENTS FOR PIN 1 ORIENTATION IN TAPE



*All dimensions are nominal

Device	Package Type	Package Drawing	Pins	SPQ	Reel Diameter (mm)	Reel Width W1 (mm)	A0 (mm)	B0 (mm)	K0 (mm)	P1 (mm)	W (mm)	Pin1 Quadrant
TPS562200DDCR	SOT-23-THIN	DDC	6	3000	180.0	8.4	3.2	3.2	1.4	4.0	8.0	Q3
TPS562200DDCR	SOT-23-THIN	DDC	6	3000	180.0	8.4	3.2	3.2	1.4	4.0	8.0	Q3
TPS562200DDCT	SOT-23-THIN	DDC	6	250	180.0	8.4	3.2	3.2	1.4	4.0	8.0	Q3
TPS562200DDCT	SOT-23-THIN	DDC	6	250	180.0	8.4	3.2	3.2	1.4	4.0	8.0	Q3
TPS563200DDCR	SOT-23-THIN	DDC	6	3000	180.0	8.4	3.2	3.2	1.4	4.0	8.0	Q3
TPS563200DDCT	SOT-23-THIN	DDC	6	250	180.0	8.4	3.2	3.2	1.4	4.0	8.0	Q3

TAPE AND REEL BOX DIMENSIONS

*All dimensions are nominal

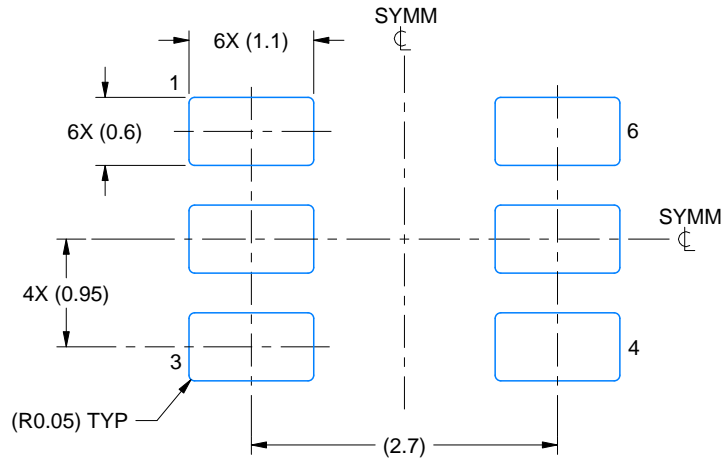
Device	Package Type	Package Drawing	Pins	SPQ	Length (mm)	Width (mm)	Height (mm)
TPS562200DDCR	SOT-23-THIN	DDC	6	3000	210.0	185.0	35.0
TPS562200DDCR	SOT-23-THIN	DDC	6	3000	210.0	185.0	35.0
TPS562200DDCT	SOT-23-THIN	DDC	6	250	210.0	185.0	35.0
TPS562200DDCT	SOT-23-THIN	DDC	6	250	210.0	185.0	35.0
TPS563200DDCR	SOT-23-THIN	DDC	6	3000	210.0	185.0	35.0
TPS563200DDCT	SOT-23-THIN	DDC	6	250	210.0	185.0	35.0



LAND PATTERN EXAMPLE
EXPLODED METAL SHOWN
SCALE:15X



SOLDEMASK DETAILS

4214841/E 08/2024

NOTES: (continued)

- 4. Publication IPC-7351 may have alternate designs.
- 5. Solder mask tolerances between and around signal pads can vary based on board fabrication site.

EXAMPLE STENCIL DESIGN

DDC0006A

SOT-23 - 1.1 max height

SMALL OUTLINE TRANSISTOR



SOLDER PASTE EXAMPLE
BASED ON 0.125 THICK STENCIL
SCALE:15X

4214841/E 08/2024

NOTES: (continued)

6. Laser cutting apertures with trapezoidal walls and rounded corners may offer better paste release. IPC-7525 may have alternate design recommendations.
7. Board assembly site may have different recommendations for stencil design.

重要声明和免责声明

TI“按原样”提供技术和可靠性数据（包括数据表）、设计资源（包括参考设计）、应用或其他设计建议、网络工具、安全信息和其他资源，不保证没有瑕疵且不做任何明示或暗示的担保，包括但不限于对适销性、某特定用途方面的适用性或不侵犯任何第三方知识产权的暗示担保。

这些资源可供使用 TI 产品进行设计的熟练开发人员使用。您将自行承担以下全部责任：(1) 针对您的应用选择合适的 TI 产品，(2) 设计、验证并测试您的应用，(3) 确保您的应用满足相应标准以及任何其他功能安全、信息安全、监管或其他要求。

这些资源如有变更，恕不另行通知。TI 授权您仅可将这些资源用于研发本资源所述的 TI 产品的应用。严禁对这些资源进行其他复制或展示。您无权使用任何其他 TI 知识产权或任何第三方知识产权。您应全额赔偿因在这些资源的使用中对 TI 及其代表造成的任何索赔、损害、成本、损失和债务，TI 对此概不负责。

TI 提供的产品受 [TI 的销售条款](#) 或 [ti.com](#) 上其他适用条款/TI 产品随附的其他适用条款的约束。TI 提供这些资源并不会扩展或以其他方式更改 TI 针对 TI 产品发布的适用的担保或担保免责声明。

TI 反对并拒绝您可能提出的任何其他或不同的条款。

邮寄地址：Texas Instruments, Post Office Box 655303, Dallas, Texas 75265
Copyright © 2024，德州仪器 (TI) 公司